



OWNER'S MANUAL

Operation

Maintenance

Specifications

All information in this Owner's Manual is current at the time of publication. However, HYUNDAI reserves the right to make changes at any time so that our policy of continual product improvement may be carried out.

This manual applies to all models of this vehicle and includes descriptions and explanations of optional as well as standard equipment.

As a result, you may find material in this manual that does not apply to your specific vehicle.

CAUTION: MODIFICATIONS TO YOUR HYUNDAI

Your HYUNDAI should not be modified in any way. Such modifications may adversely affect the performance, safety or durability of your HYUNDAI and may, in addition, violate conditions of the limited warranties covering the vehicle. Certain modifications may also be in violation of regulations established by the Department of Transportation and other government agencies in your country.

TWO-WAY RADIO INSTALLATION

Your vehicle is equipped with a Tire Pressure Monitoring System, Passenger Occupant Classification System and other CAN bus systems. It is possible for an improperly installed/adjusted high powered two-way radio to adversely affect electronic systems. For this reason, we recommend that you carefully follow the radio manufacturer's instructions if you choose to install one of these devices.

SAFETY AND VEHICLE DAMAGE WARNING

This manual includes information titled as DANGER, WARNING, CAUTION and NOTICE. These titles indicate the following:

DANGER

DANGER indicates a hazardous situation which, if not avoided, will result in death or serious injury.

WARNING

WARNING indicates a hazardous situation which, if not avoided, could result in death or serious injury.

CAUTION

CAUTION indicates a hazardous situation which, if not avoided, could result in minor or moderate injury.

NOTICE

NOTICE indicates a situation which, if not avoided, could result in vehicle damage.

HYUNDAI VEHICLE OWNER PRIVACY POLICY

Your Hyundai vehicle may be equipped with technologies and services that use information collected, generated, recorded or stored by the vehicle. Hyundai has created a Vehicle Owner Privacy Policy to explain how these technologies and services collect use and share this information.

You may read our Vehicle Owner Privacy Policy on the Hyundaiusa.com website at: <https://www.hyundaiusa.com/owner-privacy-policy.aspx>

If you would like to receive a hard copy of our Vehicle Owner Privacy Policy, please contact the Hyundai Customer Care Center at:

Hyundai Customer Care
P.O. Box 20850
Fountain Valley, CA 92728
800-633-5151
consumeraffairs@hmmausa.com

Hyundai's Customer Care representatives are available Monday through Friday, between the hours of 6:00 AM and 5:00 PM PST and Saturday between 6:30 AM and 3:00 PM PST (English).

For Customer Care assistance in Spanish or Korean, representatives are available Monday through Friday between 6:30 AM and 3:00 PM PST.

Table of contents

Introduction	1
Picture Index	2
Seats & Safety System	3
Instrument Cluster	4
Convenience Features	5
Driving Your Vehicle	6
Driver Assistance System	7
Emergency Situations	8
Maintenance	9
Vehicle Information, Reporting Safety Defects, And Consumer Information	10
Index	I

1. Introduction

Introduction	1-2
HYUNDAI Motor America.....	1-3
Safety Messages.....	1-4
Vehicle Modifications.....	1-5
Vehicle Handling Instructions.....	1-5
Vehicle Break-in Process	1-6
Hybrid Electric Vehicle (HEV) System.....	1-7
Driving Your Hybrid Vehicle.....	1-9
Starting your vehicle.....	1-9
Stopping your vehicle.....	1-10
Special features.....	1-11
Energy flow.....	1-13
Hybrid system gauge.....	1-18
Warning and indicator lights	1-20
Cluster display messages	1-22
Hybrid Driving System	1-24
e-Handling (Electrically Assisted Handling Performance)/e-EHA (Electrically Evasive Handling Assist)	1-24
e-Ride (Electrically-controlled Ride Comfort).....	1-25
Safety Precautions For Hybrid System	1-26
Hybrid vehicle components	1-26
When the hybrid vehicle shuts off.....	1-30
Countermeasures for accidents or fire.....	1-31

Introduction

Congratulations, and thank you for choosing HYUNDAI. We are pleased to welcome you to the growing number of discerning people who drive HYUNDAI. We are very proud of the advanced engineering and high quality construction of each HYUNDAI we build.

Your Owner's Manual will introduce you to the features and operation of your new HYUNDAI. To become familiar with your new HYUNDAI, so that you can fully enjoy it, read this Owner's Manual carefully before driving your new vehicle.

This manual contains important safety information and instructions intended to familiarize you with your vehicle's controls and safety features so you can safely operate your vehicle.

This manual also contains information on maintenance designed to enhance safe operation of the vehicle. It is recommended that all service and maintenance on your car be performed by an authorized HYUNDAI dealer. An authorized HYUNDAI dealer are prepared to provide high-quality service, maintenance, and any other assistance that may be required.

You may download an electronic version of this manual from owners.hyundaiusa.com.

HYUNDAI Motor America

Copyright 2024 HYUNDAI Motor America. All rights reserved. No part of this publication may be reproduced, stored in any retrieval system or transmitted in any form or by any means without the prior written permission of HYUNDAI Motor America.

Safety Messages

Your safety, and the safety of others, are very important. This Owner's Manual provides you with many safety precautions and operating procedures. This information alerts you to potential hazards that may hurt you or others, and may damage your vehicle.

Safety messages found on vehicle labels and in this manual describe these hazards and what to do to avoid or reduce the risks.

Warnings and instructions contained in this manual are for your safety. Failure to follow safety warnings and instructions can lead to serious injury or death.

Throughout this manual DANGER, WARNING, CAUTION, NOTICE, and the SAFETY ALERT SYMBOL will be used.



This is the safety alert symbol. It is used to alert you to potential physical injury hazards. Obey all safety messages that follow this symbol to avoid possible injury or death. The safety alert symbol precedes the signal words DANGER, WARNING, and CAUTION.

DANGER

DANGER indicates a hazardous situation that, if not avoided, will result in death or serious injury.

WARNING

WARNING indicates a hazardous situation that, if not avoided, could result in death or serious injury.

CAUTION

CAUTION indicates a hazardous situation that, if not avoided, could result in minor or moderate injury.

NOTICE

NOTICE indicates a situation that, if not avoided, could result in vehicle damage.

Vehicle Modifications

WARNING

Your HYUNDAI should not be modified in any way. Modifications may adversely affect the performance, safety or durability of your HYUNDAI and may, violate conditions of the limited warranties covering the vehicle. Certain modifications may also be in violation of safety and emissions regulations established by the U.S. Department of Transportation and other federal or state agencies.

If you use unauthorized electronic devices, it may cause the vehicle to operate abnormally, wire damage, battery discharge, and fire. For your safety, do not use unauthorized electronic devices.

NOTICE

Some vehicle interior sounds (including welcome chime, navigation alerts, or warning chimes) may be generated from the interior speakers or amplifier. Do not replace these components with anything other than the original Hyundai factory parts. Any unauthorized product may cause a malfunction of the vehicle interior sounds that may affect the intended operation of the vehicle.

Vehicle Handling Instructions

As with other vehicles of this type, failure to operate this vehicle correctly may result in loss of control, a collision or vehicle rollover.

Specific design characteristics (higher ground clearance, track, etc.) give this vehicle a higher center of gravity than other types of vehicles. In other words they are not designed for cornering at the same speeds as conventional 2-wheel drive vehicles. Avoid sharp turns or abrupt maneuvers. Again, failure to operate this vehicle correctly may result in loss of control, a collision or vehicle rollover. Be sure to read the "Reducing the Risk of a Rollover" driving guidelines, in section 3 of this manual.

Vehicle Break-in Process

By following a few simple precautions for the first 600 mi. (1,000 km), you may add to the performance, economy, and life of your vehicle.

- Do not race the engine.
- While driving, avoid sudden acceleration.
- Do not maintain a single speed for long time, either fast or slow. Differing engine speed is needed to properly break-in the engine.
- Avoid hard stops, except in emergencies, to allow the brakes to seat properly.
- Fuel economy, engine performance, and engine oil consumption may differ depending on vehicle break-in process and be stabilized after 4,000 mi. (6,000 km). New engines may consume more oil during the vehicle break-in period.
- Do not tow a trailer during the first 1,200 mi. (2,000 km) of operation.

Hybrid Electric Vehicle (HEV) System





The HYUNDAI Hybrid Electric Vehicle (HEV) uses both the gasoline engine and the electric motor for power. The electric motor is run by a high voltage hybrid battery.

Depending on the driving conditions, the HEV computer selectively operates between the engine and the electric motor or even both at the same time.

Fuel economy increases when the vehicle is driven by the electric motor with the HEV battery.

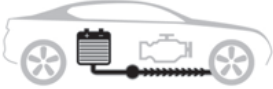
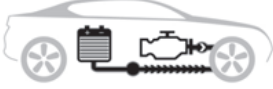
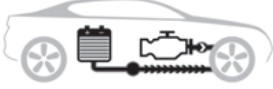
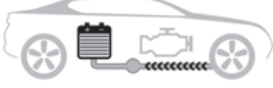
The hybrid battery charge must be maintained, so at times the engine will come on even at idle to act as a generator. Charging also occurs when decelerating or by regenerative braking.

<p>(1) Startup/Low speed cruise - Electric motor</p>	
<p>(2) Acceleration - Electric motor + Engine</p>	
<p>(3) High speed cruise - Electric motor or Engine</p>	
<p>(4) Deceleration - Charging</p>	
<p>(5) Stop</p>	

Driving Your Hybrid Vehicle

Starting your vehicle

CAUTION

- Always fasten the seat belt before starting the vehicle.
 - Check if the Electronic Parking Brake (EPB) is applied before starting the vehicle.
-

1. Carry the smart key or leave it inside the vehicle.
2. Make sure the gear is in P (Park). You cannot start the vehicle with the gear in N (Neutral).
3. Press the Engine Start/Stop button while depressing the brake pedal.
 - The **READY** indicator illuminates on the instrument cluster.
 - If the **READY** indicator does not illuminate, start the vehicle again.
 - Whether the engine is cold or warm, the vehicle should be started without depressing the accelerator pedal.
4. Depress and hold the brake pedal and shift to the desired position.
5. Release the parking brake and slowly release the brake pedal. Check if the vehicle slowly moves forward, then depress the accelerator pedal.

Stopping your vehicle

1. Hold down the brake pedal while the vehicle is stopped.
2. Shift the gear to P (Park) while depressing the brake pedal.
3. Apply the Electronic Parking Brake (EPB).
4. Press the Engine Start/Stop button and turn off the engine while depressing the brake pedal.
 - The **READY** indicator turns off on the instrument cluster.

ECONOMICAL and SAFE OPERATION of the Hybrid system

- Drive smoothly. Accelerate at a moderate rate and maintain a steady cruising speed. Do not make "jackrabbit" starts. Do not race between stoplights.
Avoid heavy traffic whenever possible. Always maintain a safe distance from other vehicles so you can avoid unnecessary braking. This also reduces brake wear out.
- The regenerative brake generates energy when the vehicle decelerates.
- When the hybrid battery power is low, the hybrid system automatically recharges the hybrid battery.
- When the engine is running with the gear in N (Neutral), the hybrid system cannot generate electricity. The hybrid battery cannot recharge with the gear in N (Neutral).

***i* Information**

In the hybrid system, the engine automatically runs and stops. When the hybrid system operates, the **READY** indicator is illuminated.

In the following situation, the engine may operate automatically.

- When the engine is ready to run
 - When the hybrid battery is being charged
 - Depending on the temperature condition of the hybrid battery
-

Special features

Hybrid vehicles sound different than gasoline engine vehicles. When the hybrid system operates, you may hear a sound from the hybrid battery system under the floor. If you apply the accelerator pedal rapidly, you may hear an unconventional sound. When you apply the brake pedal, you may hear a sound from the regenerative brake system. When the hybrid system is turned off or on, you may hear a sound in the engine compartment. If you depress the brake pedal repeatedly when the hybrid system is turned on, you may hear a sound in the engine compartment. None of these sounds indicate a problem. These are normal characteristics of hybrid vehicles.

If any of following occur, it's a normal condition if you hear a motor sound in the engine compartment:

- After turning off the hybrid system, the brake pedal is released.
- When the hybrid system is turned off, the brake pedal is applied.
- When the driver door is opened.

When the hybrid system is turned ON, the gasoline engine may run or may not. In this situation, you may feel a vibration. This does not indicate a malfunction. When the **READY** indicator illuminates, the hybrid system is ready to begin driving. Even if the engine is off, you can operate the vehicle as long as the **READY** indicator is illuminated.

NOTICE

The hybrid system contains many electronic components. High voltage components, such as cables and other parts, may emit electromagnetic waves. Even when the electromagnetic cover blocks electromagnetic emissions, electromagnetic waves may have an effect on electronic devices. When your vehicle is not used for a long period of time, the hybrid system will discharge. You need to drive the vehicle several times a month. Drive at least for 1 hour or 10 mi. (16 km) When the hybrid battery is discharged, or when it is impossible to jump start the vehicle, contact an authorized HYUNDAI dealer.

WARNING

- When you start the hybrid system with the gear in P (Park), the **READY** indicator illuminates on the instrument cluster. The driver can drive the vehicle, even when the gasoline engine is off.
- When you leave the vehicle, you should turn off the hybrid system or shift the gear to P (Park). When you depress the accelerator pedal by mistake, or when the gear is not in P (Park), the vehicle will abruptly move, possibly resulting in serious injury or death.

Virtual Engine Sound System (VESS)

The Virtual Engine Sound System generates engine sound for pedestrians to hear vehicle sound because there is limited sound while motor power is used.

- When the engine is running and the gear is not in P (Park), the VESS operates.

What does regenerative braking do?

It uses an electric motor when decelerating and when braking and transforms kinetic energy to electrical energy in order to charge the high voltage battery.

Battery information

- The vehicle is composed of a high voltage battery that drives the motor and air conditioner, and a 12 V battery with the hybrid battery that operates the lamps, wipers, and audio system.
- The 12 V battery is automatically charged when the vehicle is in the ready mode (READY indicator on).

Energy flow

The hybrid system informs the drivers of its energy flow in various operating modes. While driving, the current energy flow is specified in 11 modes.

Vehicle stop

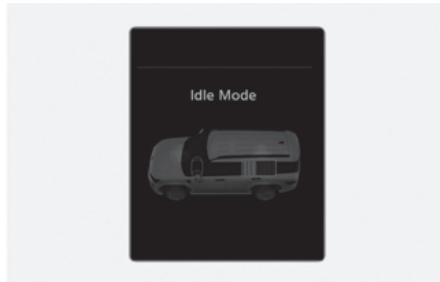

The vehicle is stopped.
(No energy flow)

Electric mode

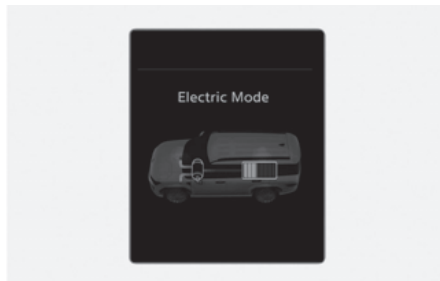

Only the motor power is used to drive the vehicle.
(Battery → Wheel)

Hybrid mode

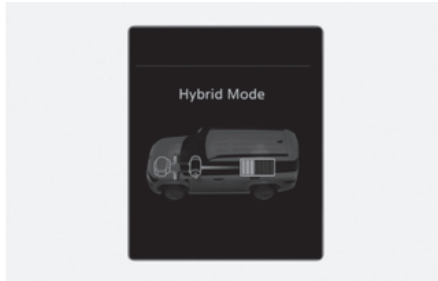

Both the motor and the engine power are used to drive the vehicle.
(Battery & Engine → Wheel)

Fuel engine mode

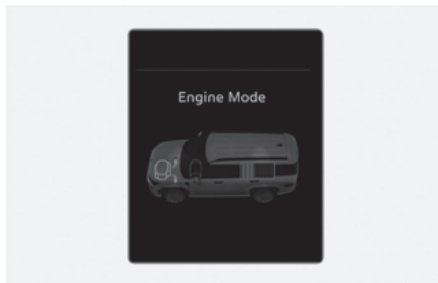

Only the engine power is used to drive the vehicle.
(Engine → Wheel)

Engine generation



The engine charges the high voltage battery according to the vehicle and surrounding conditions.

(Engine → Battery)

Regeneration

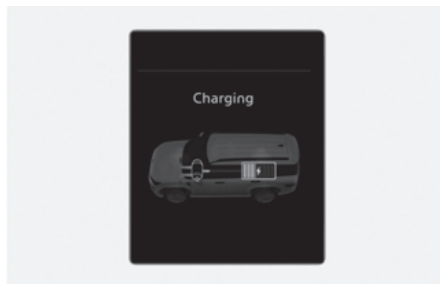

The high voltage battery is charged up by the regenerative brake system.

(Wheel → Battery)

Engine brake

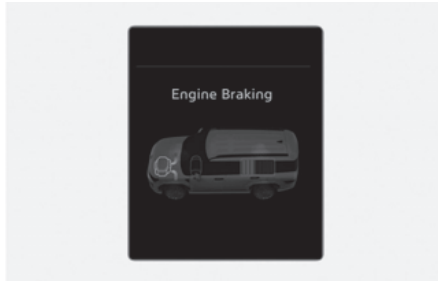

The engine braking is used to decelerate the vehicle.
(Wheel → Engine)

Power reserve

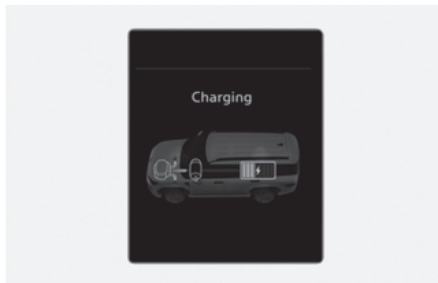

The engine is simultaneously used to drive the vehicle and to charge up the high voltage battery.
(Engine → Wheel and Battery)

Engine generation/motor drive



The engine charges up the high voltage battery. The motor power is used to drive the vehicle.

(Engine → Battery → Wheel)

Engine generation/regeneration

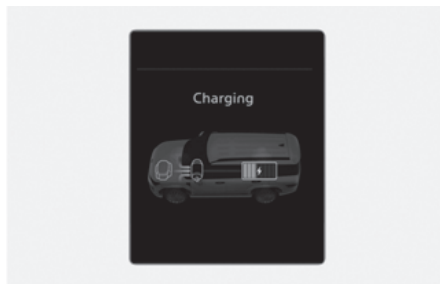

The engine and regenerative brake system charges up the high voltage battery.

(Engine and Wheel → Battery)

Engine brake/regeneration



The engine braking is simultaneously used to decelerate the vehicle and to charge up the high voltage battery.

(Wheel → Engine and Battery)

Hybrid system gauge

Power gauge

Type A



Type B



The hybrid system gauge indicates whether the current driving condition is fuel efficient or not.

- CHARGE: Shows that the energy made by the vehicle is being converted to electrical energy. (Regenerated energy)
- ECO: Shows that the vehicle is being driven in an Eco-friendly manner.
- POWER: Shows that the vehicle is exceeding the Eco-friendly range.

According to the hybrid system gauge area, the EV indicator comes on or off.

- EV indicator ON: The vehicle is driven using the electric motor or the gasoline engine is stopped.
- EV indicator OFF: The vehicle is driven using the gasoline engine.

Hybrid battery SOC (State of Charge) gauge

Type A



Type B



This gauge indicates the remaining hybrid battery power. If the SOC is near the L (Low) level, the vehicle automatically operates the engine to charge the battery.

However, if the Service Indicator (↔) and Malfunction Indicator Lamp (MIL) (⚠️) turn on when the SOC gauge is near the L (Low) level, have your vehicle inspected by an authorized HYUNDAI dealer.

Warning and indicator lights

Ready indicator

READY

This indicator illuminates:

When the vehicle is ready to be driven.

- ON: Normal driving is possible.
- OFF: Normal driving is not possible, or a problem has occurred.

When the **READY** indicator goes off or blinks, there is a problem with the system. If this occurs, have your vehicle inspected by an authorized HYUNDAI dealer.

Service warning light



This warning light illuminates:

- When you set the Engine Start/Stop button to the ON position.
 - The service warning light illuminates for about 3 seconds and then turns off when all checks have been performed.
- When there is a problem with the hybrid vehicle control system or hardware.

When the warning light illuminates while driving, or does not go OFF after starting the vehicle, have your vehicle inspected by an authorized HYUNDAI dealer.

EV mode indicator

EV

This indicator illuminates:
When the vehicle is driven by the electric motor.

Regenerative brake warning light



This warning light illuminates:
When the regenerative brake does not operate and the brake does not perform well. This causes the Brake Warning light (red) and Regenerative Brake Warning Light (yellow) to illuminate simultaneously.
If this occurs, have your vehicle inspected by an authorized HYUNDAI dealer. The operation of the brake pedal may be more difficult than normal and the braking distance may increase.

Cluster display messages

Check Hybrid system

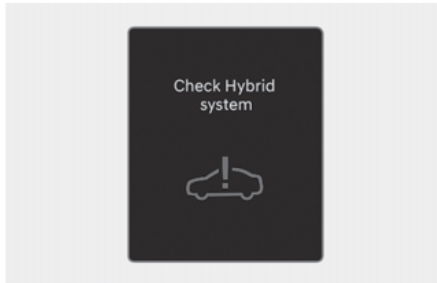

This message appears when there is a problem with the hybrid control system. Refrain from driving when the warning message appears.

If this occurs, have your vehicle inspected by an authorized HYUNDAI dealer.

Check Hybrid system. Stop safely.

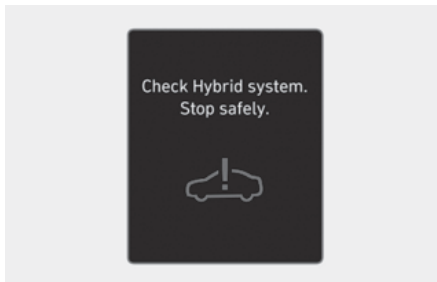

This message appears when there is a problem with the hybrid control system. The **READY** indicator will blink and a warning chime will sound until the problem is solved. Refrain from driving when the warning message appears.

If this occurs, have your vehicle inspected by an authorized HYUNDAI dealer.

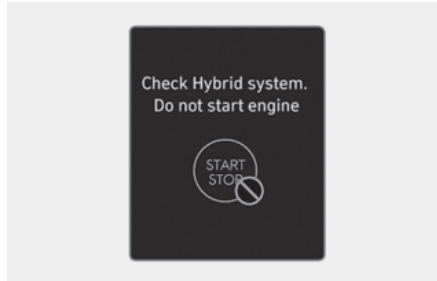
Check Hybrid system. Do not start engine

This message appears when the hybrid battery power (SOC) level is low. A warning chime will sound until the problem is solved. Refrain from driving when the warning message appears.

If this occurs, have your vehicle inspected by an authorized HYUNDAI dealer.

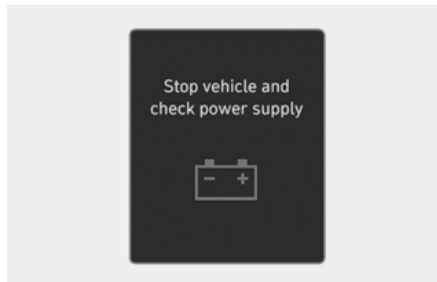
Stop vehicle and check power supply

This message appears when a failure occurs in the power supply system.

If this occurs, have your vehicle inspected by an authorized HYUNDAI dealer.

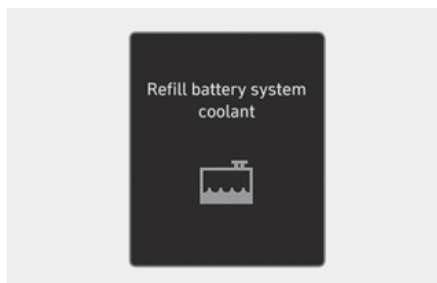
Refill battery system coolant

This message appears when the battery system coolant is nearly empty. You should refill the battery system coolant.

Hybrid Driving System

e-Handling (Electrically Assisted Handling Performance)/e-EHA (Electrically Evasive Handling Assist)

e-Handling controls the electric motor while cornering to improve handling performance, driving safety, convenience, and comfortable riding.

e-EHA connects Forward Collision Avoidance Assist and the electric motor to help avoid collision so that prompt collision avoidance is available while Forward Collision Avoidance Assist warning appears.

Operating Condition

e-Handling operates when the function judges you are in a cornering situation while the vehicle is steered above a certain level and vehicle speed is between 25 mph (40 km/h) and 75 mph (120 km/h).

e-EHA operates if there is urgent steering wheel operation while Forward Collision Avoidance Assist warning appears.

Off conditions

- When ESC operates
- When ABS operates

i Information

The system does not operate under the following conditions.

- When the ESC OFF indicator light is illuminated
 - When there is an electronic device malfunction
 - When the paddle shifter (manual shift mode) is used
For more information, refer to the "Automatic Transmission" section in chapter 6.
 - When the gear is not in D (Drive)
-

e-Ride (Electrically-controlled Ride Comfort)

e-Ride controls the vehicle's sensors and drive motor torque to help soften the impact when passing over obstacles such as speed bumps, and detects and adjusts the vehicle's movement to provide a more comfortable and stable driving performance.

i Information

e-Ride does not operate in the following circumstances:

- When your vehicle is in manual shift mode or SPORT mode
- When driving on steep slopes
- When ABS and TCS is activated
- When vehicle speed is 35 mph (55 km/h) or faster
- When your vehicle is driving off-road, making sharp turns, or shifting gears

Once these conditions are cleared, e-Ride will operate when driving over speed bumps.

Safety Precautions For Hybrid System

Hybrid vehicle components

High voltage battery system

- **HPCU (Hybrid Power Control Unit):** Located in the engine compartment

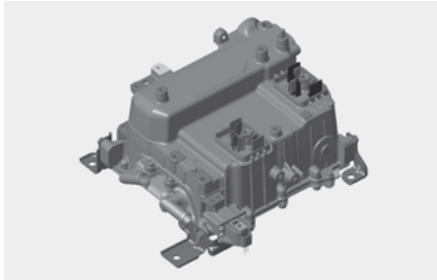

- **High voltage battery system:** Located under front seat

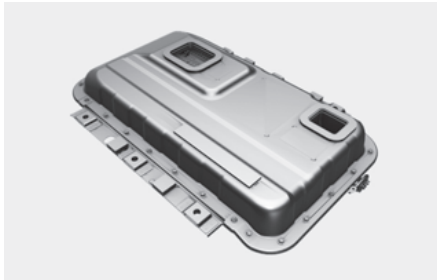

WARNING

- Never touch orange colored or high voltage labeled components, including wires, cables, and connections. When the insulators or covers are damaged or removed, severe injury or death from electrocution may occur.
 - While replacing the fuses in the engine compartment, never touch the HPCU. The HPCU carries high voltage. Touching the HPCU may result in electrocution, serious injury, or death.
 - In the hybrid system, the hybrid battery uses high voltage to operate the motor and other components. This high voltage hybrid battery system can be very dangerous. Never touch the hybrid system. When you touch the hybrid battery system, serious injury or death may occur.
-

⚠ WARNING

- Do not disassemble or assemble the high voltage battery system. Doing so may result in electric shock, causing death or serious injury.
 - If you disassemble or assemble hybrid system components improperly, it may damage the performance and reliability of your vehicle.
 - If electrolyte comes in contact with your body, clothes or eyes, immediately flush with a large quantity of fresh tap water. Have your eyes examined by a doctor as soon as possible.
-

⚠ WARNING

Never assemble or disassemble the high voltage battery system.

- If you assemble or disassemble the high voltage battery system, the durability and performance of the vehicle may be damaged.
 - When you want to check the high voltage battery system, have your vehicle inspected by an authorized HYUNDAI dealer.
 - Do not touch the high voltage battery and high voltage cable connected to motor (orange color). Severe burns and electric shock may occur. For your safety, do not touch the cover of electronic components and electronic cable. Do not remove the cover of electronic components and electronic cable. In particular, never touch the high voltage battery system when the hybrid system in operation. It may result in death or serious injury.
-

⚠ WARNING

- Never use the package modules (high voltage battery, inverter and converter) for any other purpose.
 - Do not use an unauthorized battery charger to charge the high voltage battery. Doing so may result in death or serious injury.
 - Never locate the high voltage system near or in a fire.
 - Never drill into or strike the package module. Otherwise, it may be damaged. An electric shock may occur, resulting in serious injury or death.
-

NOTICE

- When the vehicle is paint baked, do not bake over 30 minutes in 158 °F (70 °C) or 20 minutes in 176 °F (80 °C) degrees.
 - Do not wash the engine compartment, using water. Water may cause an electric shock and damage the electronic components.
-

⚠ WARNING

This hybrid vehicle uses the hybrid battery system inverter and converter to generate high voltage. High voltage in the hybrid battery system is very dangerous and may cause severe burns and electric shock. This may result in serious injury or death.

- For your safety, never touch, replace, disassemble or remove the hybrid battery system including components, cables and connectors. Severe burns or electric shock may result in serious injury or death when you fail to follow this warning.
 - When the hybrid battery system operates, the hybrid battery system can be hot. Always be careful because burns or electric shock may be caused by high voltage.
 - Do not spill liquid on the HPCU, HSG, motor and fuses. If the hybrid system components come in contact with liquid, it may result in electric shock.
-

High Voltage Motor Connector

- **Drive Motor:** Located in the engine compartment

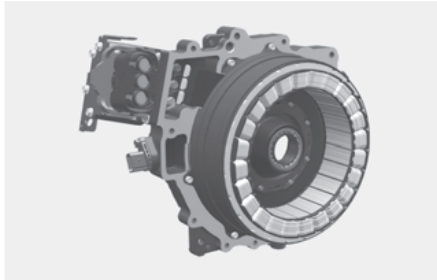

⚠ WARNING

- Do not disassemble the high voltage motor connector. The high voltage motor connector may contain residual high voltage. Coming in contact with high voltage may result in death or serious injury.
 - Have your vehicle's hybrid system inspected by an authorized HYUNDAI dealer.
-

High voltage cut-off switch

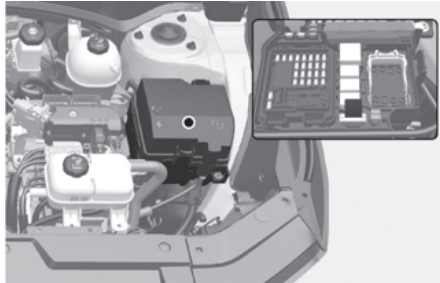

High voltage cut-off switch is a device located inside the engine compartment to block the battery's high voltage when your vehicle is inspected at an authorized HYUNDAI dealer.

⚠ WARNING

- Never touch the high voltage cut-off switch. This could result in serious injury or death in a collision or electric shock.
- If the high voltage cut-off switch requires an inspection or repair, contact an authorized HYUNDAI dealer.
- Never disconnect or cut the high voltage cut-off switch except in an emergency situation. Serious problems may occur, such as the vehicle may not start.

Hybrid battery cooling duct

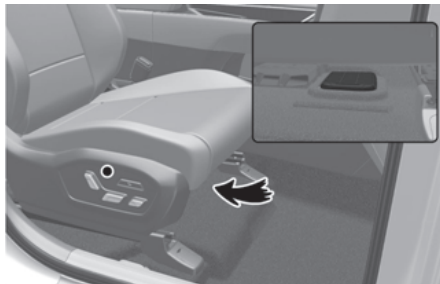

The hybrid battery cooling duct is located below the passenger seat. The cooling duct cools down the hybrid battery. When the hybrid battery cooling duct is blocked, the hybrid battery may be overheated.

Clean the cooling duct for the hybrid battery with a dry cloth on a regular basis.

WARNING

- Never clean the cooling duct of the hybrid battery with a wet cloth. If any water enters the cooling duct of the hybrid battery, the hybrid battery may cause an electric shock, resulting in a serious damage, an injury or a death.
 - The hybrid battery is composed of lithium-ion. If the hybrid battery is improperly handled, it is dangerous to the environment. Also it may cause electrical shock and severe burns, resulting in a serious injury or a death.
 - Do not spill liquid over the cooling duct of the hybrid battery. Doing so is very dangerous. It may cause electric shock or serious injury.
 - Do not cover the cooling duct with objects.
 - Do not put any objects into the cooling duct of the hybrid battery. Doing so may cause loss of cooling duct volume to the hybrid battery. When the cooling duct is blocked with any objects, immediately contact your HYUNDAI dealer.
 - Never place a container of liquid on or near the cooling duct. If the liquid spills, the hybrid battery located in the under floor may be damaged.
 - Do not obstruct the cooling duct with any other objects.
-

When the hybrid vehicle shuts off

When the high voltage battery or 12 V battery is discharged, or when the fuel tank is empty, the hybrid system may not operate while driving. When the Hybrid system does not operate, do the followings:

1. Gradually reduce the vehicle speed. Pull over your engine off the road in a safe area.
2. Make sure the gear is in P (Park).
3. Turn on the hazard warning flashers.
4. Turn off the vehicle and try to start the hybrid system again, while depressing the brake pedal and turning on the Engine Start/Stop button.
5. When the hybrid system still does not operate, refer to the "Jump Starting" section in chapter 8.

Before jump starting the vehicle, check the fuel level and the exact procedure to jump start. For more information, refer to the "Jump Starting" section in chapter 8. When the fuel level is low, do not attempt to drive the vehicle only with the battery power. The high voltage battery may be discharged, and the hybrid system may turn off.

Countermeasures for accidents or fire

When an accident occurs while driving the hybrid vehicle, turn on the hazard warning flasher, move the vehicle to a safe place, and do not let other people approach the site.

WARNING

When an accident occurs, and the high voltage battery is damaged, harmful gas and electrolytes may leak.

- Be careful not to touch the leaked liquid.
- When you suspect leakage of inflammable gas and other harmful gases, open the windows and immediately evacuate to a safe location.
- If any leaked fluid comes in contact with your eyes or skin, immediately clean the affected area thoroughly with tap water or saline solution and have doctors inspect it as soon as possible.

If the hybrid vehicle catches fire

If a fire occurs, evacuate to a safe place and do not let other people approach the site.

- Contact the fire department, report a hybrid vehicle fire, and then follow its instructions.

CAUTION

- If a fire occurs, evacuate to a safe place and wait until the firefighters arrive.
- If the lower part of the vehicle where the high voltage battery is located catches fire, large amount of water must be supplied continuously for a long time to completely extinguish the fire. It is hard to extinguish the fire without sufficient water and appropriate fire extinguishers. If you approach the vehicle carelessly, it may cause accidents, such as electric shock, and result in serious injury.

If the hybrid vehicle is submerged

If the hybrid vehicle is submerged while driving, follow the instructions below:

- Immediately turn off the vehicle and evacuate to a safe place with your key.
- Contact the emergency rescue service such as a fire department, or an authorized HYUNDAI dealer.

WARNING

Never touch the submerged hybrid vehicle. This may lead to an accident such as an electric shock or fire.

2. Picture Index

Exterior Overview (Front View).....	2-2
Exterior Overview (Rear View).....	2-3
Interior Overview	2-4
Center Console Overview	2-6
Steering Wheel Control Overview	2-8
Engine Compartment Overview	2-9

Exterior Overview (Front View)



The actual shape may differ from the illustration.

(1) Hood	5-84
(2) Headlight	9-59
(3) Tires and wheels	9-34
(4) Side view mirror.....	5-67
(5) Sunroof	5-75, 5-79
(6) Front windshield wiper blades	9-28
(7) Windows.....	5-71
(8) Front radar	7-153
(9) Roof rack	5-152

Exterior Overview (Rear View)



The actual shape may differ from the illustration.

(1) Door	5-33
(2) Fuel filler door	5-94
(3) Rear combination light.....	9-60
(4) Liftgate	5-85
(5) High mounted stop light	9-61
(6) Antenna	5-155
(7) Wide-rear view camera	7-153
(8) Reverse light	9-60
(9) Liftgate open/close button	5-85
(10)Hidden type assist handle.....	5-153

Interior Overview

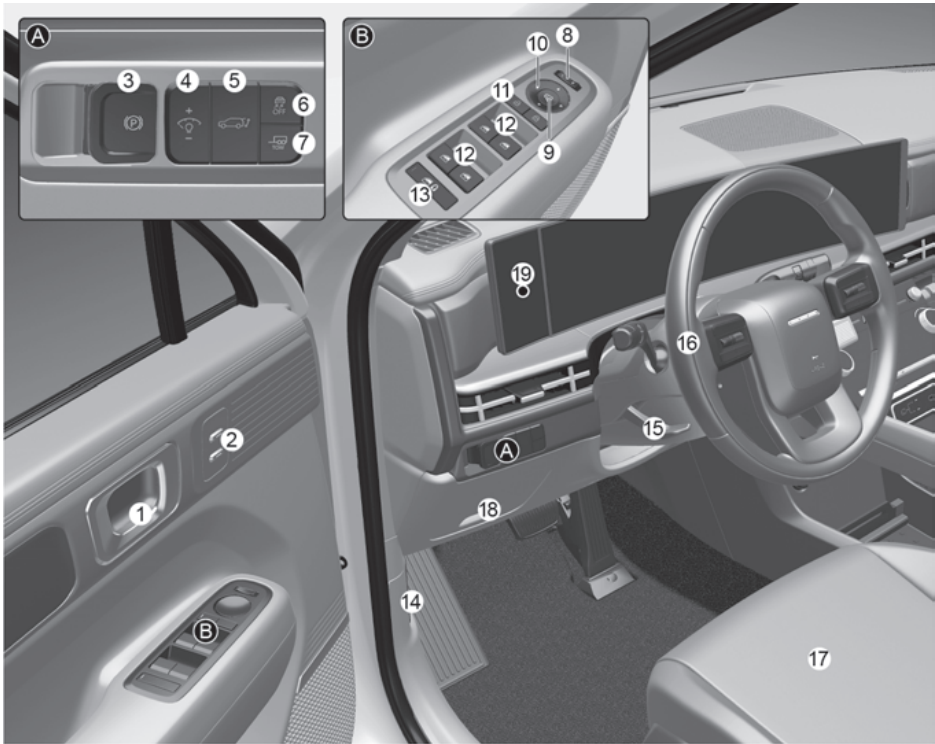

The actual shape may differ from the illustration.

(1) Inside door handle	5-35
(2) Integrated Memory System	5-45
(3) EPB (Electronic Parking Brake) switch.....	6-19
(4) Instrument panel illumination control switch	4-3
(5) Power liftgate button	5-85
(6) ESC (Electronic Stability Control) OFF button.....	6-26
(7) Towing button.....	6-50
(8) Side view mirror control selection button	5-68
(9) Side view mirror folding button.....	5-68
(10)Side view mirror control switch.....	5-68
(11) Central door lock/unlock button	5-35
(12)Power window switches	5-72
(13)Power window lock button, Electronic child safety lock button	5-73, 5-37
(14)Hood release lever	5-84

(15)Steering wheel tilt/telescopic lever	5-47
(16)Steering wheel	5-47
(17)Seat.....	3-5
(18)Fuse box	9-48

Center Console Overview

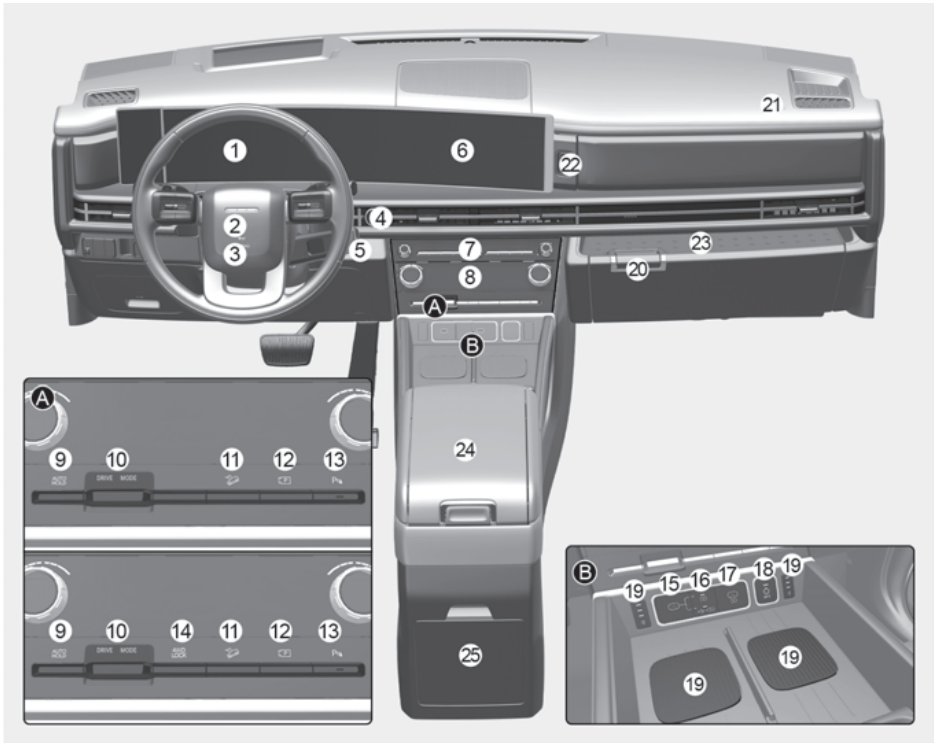

The actual shape may differ from the illustration.

(1) Instrument cluster	4-2
(2) Horn	5-49
(3) Driver's front airbag	3-56
(4) Engine Start/Stop button	6-5
(5) Rotary gear shift dial	6-11
(6) Infotainment system	4-35
(7) Hazard warning flasher button	8-2
(8) Climate control system	5-117
(9) Auto Hold button	6-22
(10) Drive mode button	6-48
(11) DBC (Downhill Brake Control) button	6-30
(12) Parking/View button	7-111,7-115,7-142
(13) Parking Safety button	7-128,7-135,7-142
(14) 4WD lock button	6-34

(15)USB charger, USB port	5-144,5-154
(16)USB Charger/USB Port convert button.....	5-154
(17)USB Charger.....	5-144
(18)UV-C sterilizer system.....	5-141
(19)Wireless smartphone charging Indicator light, Wireless smartphone charging system	5-146
(20)Glove box.....	5-138
(21)Passenger's front airbag	3-56
(22)Passenger's front multi tray.....	5-138
(23)Passenger's front open tray.....	5-138
(24)Two-way multi console	5-137
(25)Sliding tray	5-139

Steering Wheel Control Overview

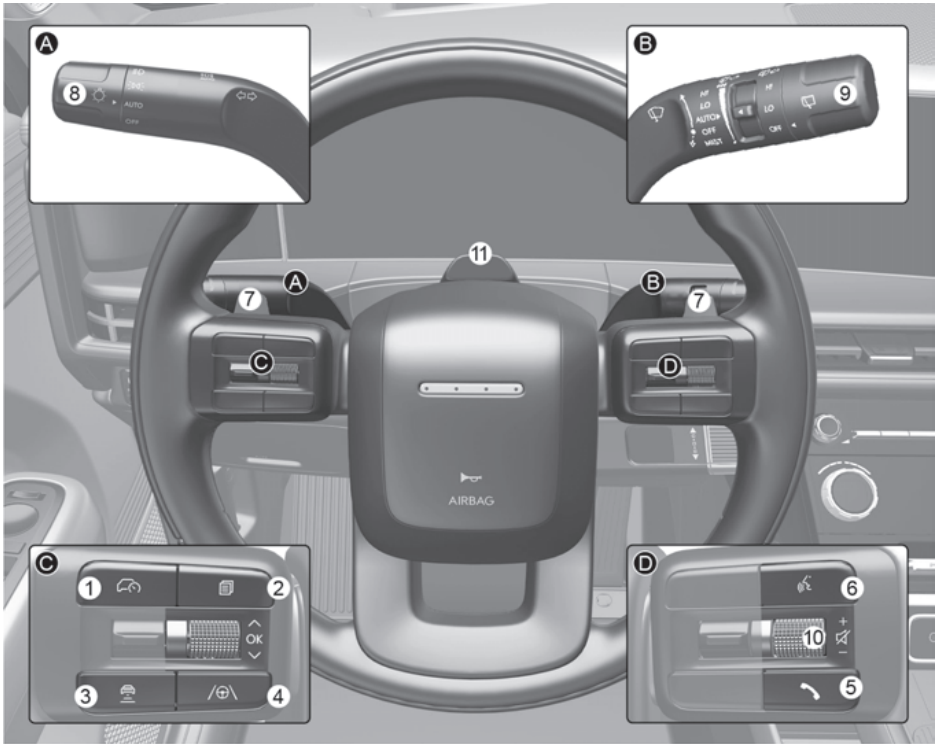

The actual shape may differ from the illustration.

(1) Driving Assist button	7-71
(2) Cluster display controls.....	4-31
(3) Vehicle Distance button.....	7-71
(4) Lane Driving Assist button	7-32
(5) Bluetooth® hands-free phone button	5-157
(6) Voice recognition button	5-157
(7) Paddle shifter.....	6-16
(8) Lighting control lever	5-100
(9) Wiper and washer control lever.....	5-113
(10)Audio remote control buttons	5-156
(11) In-cabin camera.....	7-66, 7-87

Engine Compartment Overview

Smartstream G1.6 T-GDi HEV

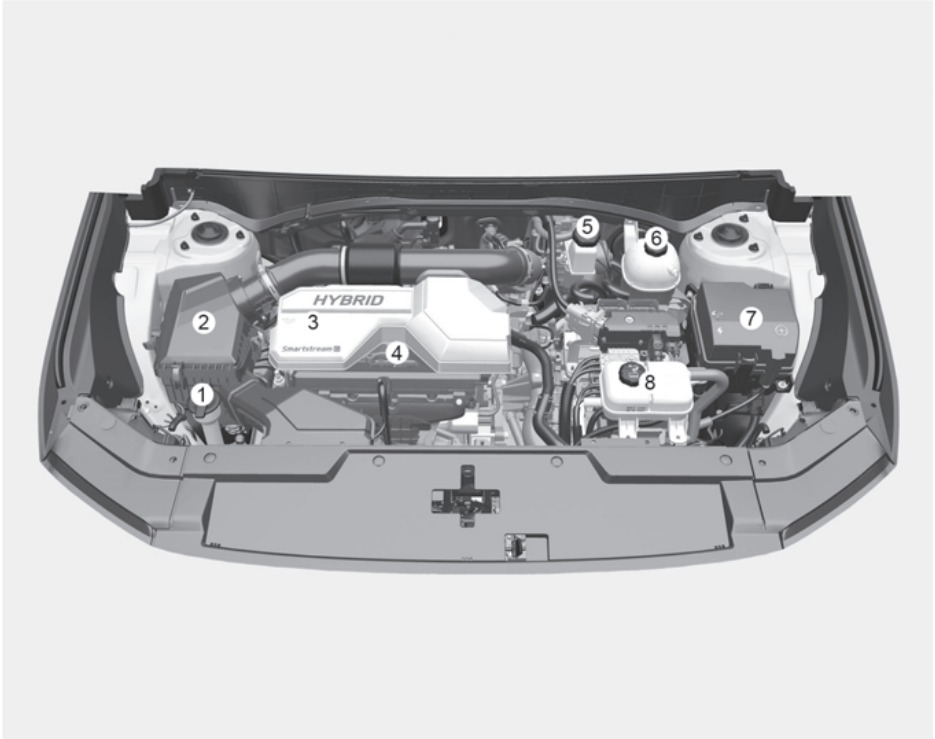

The actual engine compartment in the vehicle may differ from the illustration.

(1) Windshield washer fluid reservoir	9-25
(2) Air cleaner	9-26
(3) Engine oil filler cap	9-19
(4) Engine oil dipstick	9-19
(5) Brake fluid reservoir	9-24
(6) Engine coolant reservoir	9-21
(7) Fuse box	9-48
(8) Battery system coolant reservoir	9-21

3. Seats & Safety System

This chapter provides you with important information about how to protect yourself and your passengers. It explains how to properly use your seats and seat belts, and how your airbags work.

Additionally, this chapter explains how to properly restrain infants and children in your vehicle.

Important Safety Precautions.....	3-3
Always Wear Your Seat Belt	3-3
Restrain All Children	3-3
Airbag Hazards	3-3
Driver Distraction.....	3-3
Never Drink or Take Drugs and Drive.....	3-4
Control Your Speed.....	3-4
Keep Your Vehicle In Proper Operating Condition - Inspecting Your Tires.....	3-4
Reducing the Risk of a Rollover	3-4
Seats	3-5
Safety Precautions	3-10
Front Seats.....	3-11
Rear Seats.....	3-18
Head Restraints.....	3-26
Seat Warmers.....	3-30
Air Ventilation Seats	3-32
Seat Belts	3-33
Seat Belt Safety Precautions	3-33
Seat Belt Warning Light.....	3-34
Seat Belt Restraint System	3-35
Pretensioner seat belt.....	3-39
Additional Seat Belt Safety Precautions.....	3-41
Care of Seat Belts.....	3-43
Child Restraint System (CRS)	3-44
Children Always in the Rear	3-44
Selecting a Child Restraint System.....	3-45
Installing a Child Restraint System	3-46
Supplemental Restraint System - Airbags.....	3-53
SRS Components	3-55
Where are the Airbags?	3-56
How does the Airbag System Operate?	3-59

What to Expect After an Airbag Inflates	3-62
SRS Warning Light.....	3-63
Occupant Classification System (OCS).....	3-63
Why didn't My Airbag Go Off In a Collision?.....	3-70
SRS Care.....	3-74
Additional Safety Precautions	3-75
Airbag Warning Labels	3-75

Important Safety Precautions

You will find many safety precautions and recommendations throughout this section, and throughout this manual. The safety precautions in this section are among the most important.

Always Wear Your Seat Belt

A seat belt is your best protection in all types of collisions. Airbags are designed to supplement seat belts, not to replace them. Even though your vehicle is equipped with airbags, always make sure you and your passengers wear your seat belts, and wear them properly.

Restrain All Children

All children under age 13 should ride in your vehicle properly restrained in a rear seat, not the front seat. Infants and small children should be restrained in an appropriate Child Restraint System. Larger children should use a booster seat with the lap/shoulder belt until they can use the seat belt properly without a booster seat.

Airbag Hazards

While airbags can save lives, they can also cause serious or fatal injuries to occupants who sit too close to them, or who are not properly restrained. Infants, young children, and short adults are at the greatest risk of being injured by an inflating airbag. Follow all instructions and warnings in this manual.

Driver Distraction

Driver distraction presents a serious and potentially deadly danger, especially for inexperienced drivers. Safety should be the first concern when behind the wheel and drivers need to be aware of the wide array of potential distractions, such as drowsiness, reaching for objects, eating, personal grooming, becoming distracted from other passengers, and using mobile phones.

Drivers can become distracted when they take their eyes and attention off the road or their hands off the wheel to focus on activities other than driving. To reduce your risk of distraction and a collision:

- Set up your mobile devices (for example, MP3 players, phones, navigation units, etc.) **ONLY** when your vehicle is safely stopped and parked.
- **ONLY** use your mobile device when allowed by laws and conditions permit safe use. **NEVER** text or email while driving. Most states have laws prohibiting drivers from texting while driving. Some states and cities also prohibit drivers from using handheld phones while driving.
- **NEVER** let the use of a mobile device distract you from driving. You have a responsibility to your passengers and others on the road to always drive safely, with your hands on the wheel as well as your eyes and attention on the road.

Never Drink or Take Drugs and Drive.

Drinking alcohol or taking drugs can reduce your ability to respond to changing conditions and emergencies. Do not drink or take drugs and drive, and do not let others drink or take drugs and drive.

Control Your Speed

Excessive speed is a major factor in crash injuries and deaths. Generally, the higher the speed, the greater the risk, but serious injuries can also occur at lower speeds. Never drive faster than is safe for current conditions, regardless of the maximum speed posted.

Keep Your Vehicle In Proper Operating Condition - Inspecting Your Tires

Having a tire blowout or a mechanical failure can be extremely hazardous. To reduce the possibility of a tire hazard while driving, check your tire pressures regularly and also inspect the condition of your tires (tread depth, uneven wear, etc.). Be sure to perform all regularly scheduled maintenance as indicated in your Owner's Manual.

Reducing the Risk of a Rollover

Your multi-purpose passenger vehicle is defined as a Sports Utility Vehicle (SUV). Some SUVs have higher ground clearance and a narrower track to make them capable of performing in a wide variety of off-road applications. The specific design characteristics can give them a higher center of gravity than ordinary passenger vehicles making them more likely to roll over if you make abrupt turns. SUVs have a significantly higher rollover rate than other types of vehicles. Always make sure

you and your passengers wear your seat belts properly and securely. In a rollover crash, an unbelted person is significantly more likely to be seriously injured or killed than a person wearing a seat belt.

There are steps that a driver can make to reduce the risk of a rollover. If at all possible, avoid sharp turns or abrupt maneuvers, do not load your vehicle with heavy cargo on the roof, and never modify your vehicle in any way.

WARNING

Some Sports Utility Vehicles (SUVs) can have a significantly higher rollover rate than other types of vehicles. To prevent rollovers or loss of control:

- Take corners at slower speeds than you would with a passenger vehicle.
- Avoid sharp turns and abrupt maneuvers.
- Do not modify your vehicle in any way that you would raise the center of gravity.
- Keep tires properly inflated.
- Do not carry heavy cargo on the roof.

WARNING

Fasten your seat belt properly. In a rollover crash, an unbelted person is significantly more likely to be seriously injured or killed than a person wearing a seat belt.

Seats

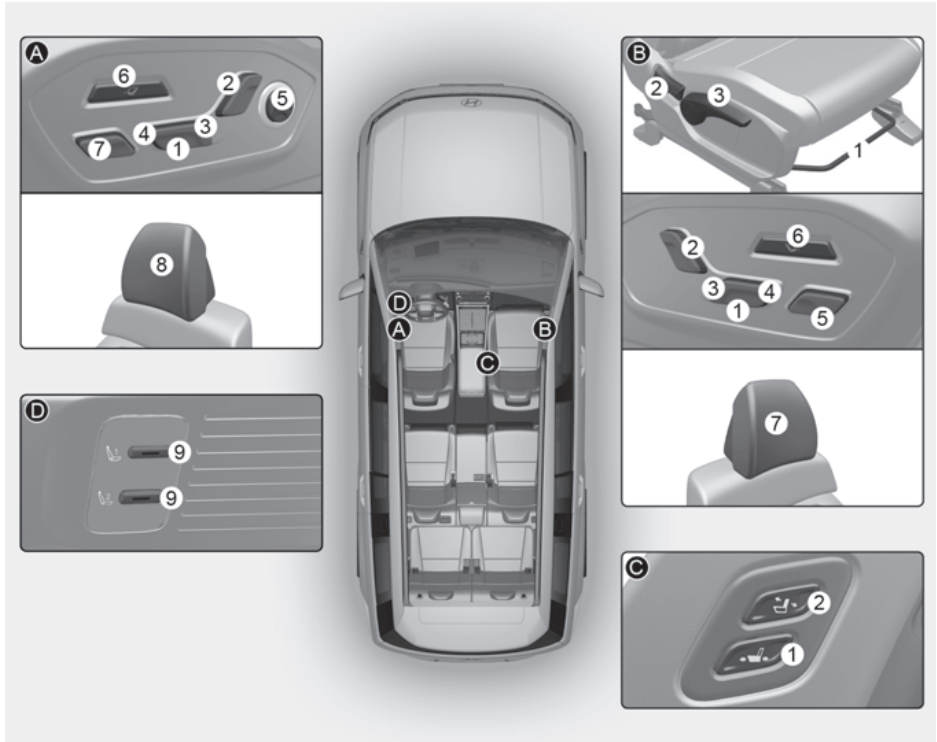

Driver's seat [A], [D]

- (1) Forward or rearward
- (2) Seatback angle
- (3) Seat height
- (4) Seat cushion angle
- (5) Lumbar support
- (6) Relaxation comfort seat switch
- (7) Leg support
- (8) Head restraint
- (9) Integrated memory system

Front passenger's seat [B]

- (1) Forward or rearward
- (2) Seatback angle
- (3) Seat height
- (4) Seat cushion angle
- (5) Leg support
- (6) Relaxation comfort seat switch
- (7) Head restraint

Front passenger's walk-in switch [C]

- (1) Forward or rearward
- (2) Seatback angle

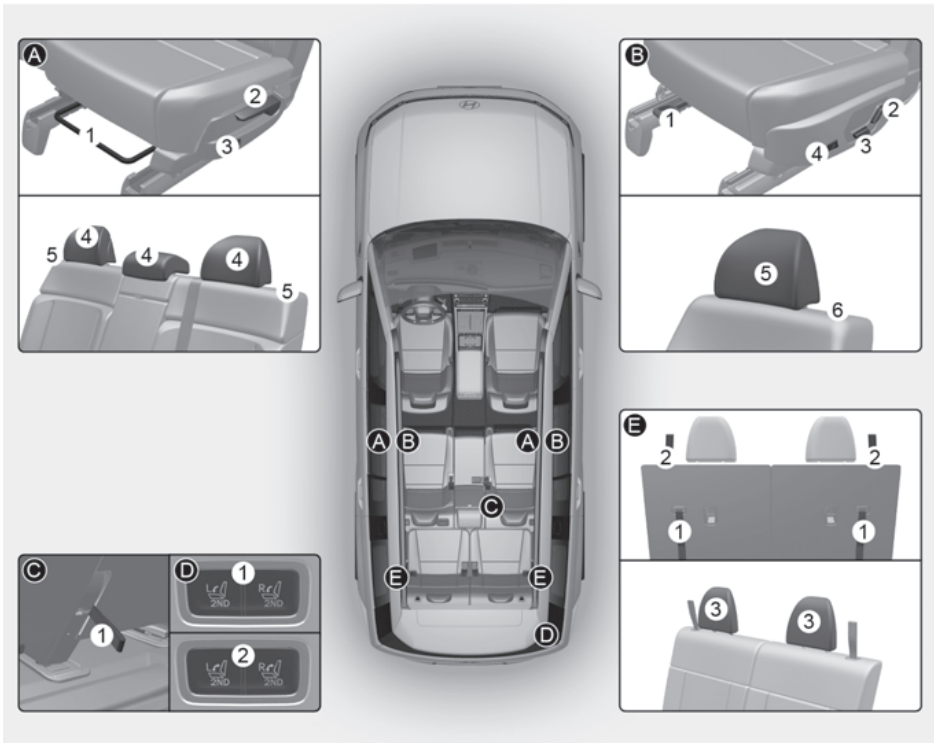

2nd row seat (7-seater) [A]

- (1) Forward or rearward
- (2) Seatback angle
- (3) 3rd row seat walk-in switch
- (4) Head restraint
- (5) 3rd row seat walk-in switch

2nd row seat (6-seater) [B]

- (1) Forward or rearward
- (2) Seatback angle
- (3) Seat cushion angle
- (4) Sliding locking
- (5) Head restraint
- (6) 3rd row seat walk-in switch

2nd row seat [C]

- (1) 3rd row seat walk-in strap

Cargo area [D]

- (1) 2nd row seat remote folding switch (7-seater))
- (2) 2nd row seat remote folding/unfolding switch (6-seater)

3rd row seat [E]

- (1) Seatback folding/unfolding strap
- (2) Seatback angle
- (3) Head restraint

Infotainment system

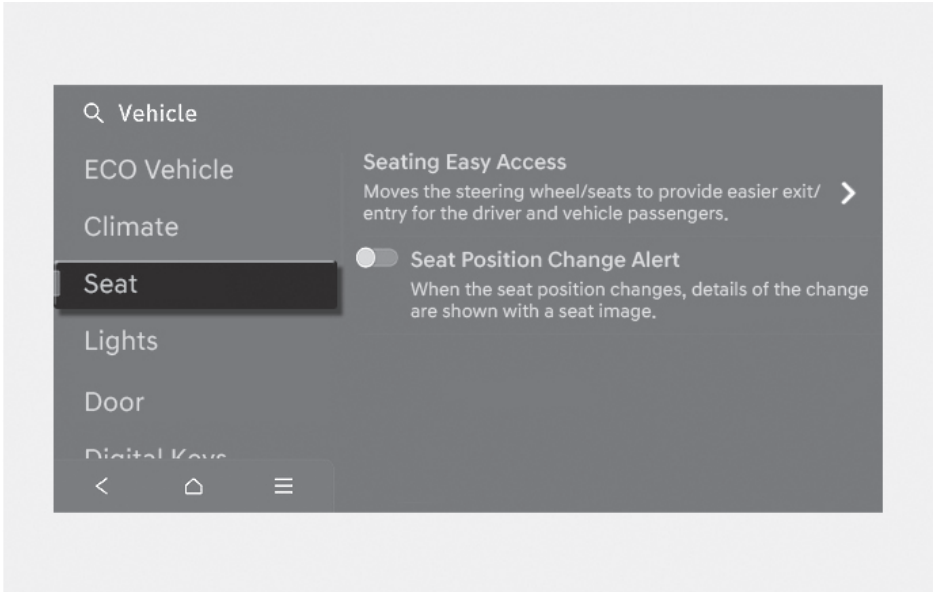

Select **Setup > Vehicle > Seat** from the Settings menu in the infotainment system, you may use various convenience functions.

- Seating Easy Access
 - Driver Seat Easy Access: The distance (Normal/Extended/Off) the seat automatically moves when the driver enters or leaves the vehicle may be selected.
- Seat Position Change Alert: When the seat position changes, details of the change are shown with a seat image.

i Information

The infotainment system may change after software updates. For more information, refer to the user's manual provided in the infotainment system and the quick reference guide.

i Information

The information provided may differ depending on which functions are applicable to your vehicle.

Safety Precautions

Adjusting the seats so that you are sitting in a safe and comfortable position plays an important role for the safety of the driver and passengers, as much as seat belts and airbags when in a collision.

WARNING

Do not use a cushion that reduces friction between the seat and the passenger. The passenger's hips may slide under the lap portion of the seat belt during a collision or a sudden stop.

Serious or fatal internal injuries could result because the seat belt cannot operate properly.

Airbags

You can take steps to reduce the risk of being injured by an inflating airbag. Sitting too close to an airbag greatly increases the risk of injury in the event the airbag inflates.

The National Highway Traffic Safety Administration (NHTSA) recommends that drivers allow at least 10 in. (25cm) between the center of the steering wheel and their chest.

WARNING

To reduce the risk of serious injury or death from an inflating airbag:

- Adjust the driver's seat as far to the rear as possible while maintaining your ability to control the vehicle.
- Adjust the front passenger seat as far to the rear as possible.
- Hold the steering wheel by the rim with your hands at the 9 o'clock and 3 o'clock positions to minimize the risk of injuries to your hands and arms.
- Never place anything or anyone between you and the airbag.

- Do not allow the front passenger to place feet or legs on the dashboard to minimize the risk of leg injuries.
-

Seat belts

Always fasten your seat belt before starting any trip. At all times, passengers should sit upright and be properly restrained with a seat belt. Infants and small children must be restrained in appropriate Child Restraint Systems. Children who have outgrown a booster seat and adults must be restrained using the seat belts.

WARNING

To prevent serious injury or death:

- Never use one seat belt for more than one occupant.
 - Always position the seatback upright with the lap portion of the seat belt snug and low across the hips.
 - Never allow children or small infants to ride on a passenger's lap.
 - Do not route the seat belt across your neck, across sharp edges, or reroute the shoulder strap away from your body.
 - Do not allow the seat belt to become caught or jammed.
-

Front Seats

WARNING

To prevent serious injury or death:

- Never attempt to adjust the seat while the vehicle is moving. The seat could respond with unexpected movement and may cause loss of vehicle control resulting in a collision.
- Do not place anything under the front seats. Loose objects, including unsecured floor mats, in the driver's foot area could interfere with the operation of the foot pedals.
- Do not allow anything to interfere with the normal position and proper locking of the seatback.
- Do not place a cigarette lighter on the floor or seat.
- Use extreme caution when picking up small objects trapped under the seats or between the seat and the center console. Your hands might be cut or injured by the sharp edges of the seat mechanism.
- If there are occupants in the rear seats, be careful while adjusting the front seat.
- Make sure that the seat is locked in place after the adjustment. If not, the seat might move unexpectedly.

Reclining seatback

Sitting in a reclined position when the vehicle is moving can be dangerous. Even when buckled up, the effectiveness of the restraint system (seat belts and/or airbags) is greatly reduced by reclining your seatback.

Seat belts must be snug against your hips and chest to work properly.

The more the seatback is reclined, the greater the chance for the passenger's hips to slide under the lap belt or the passenger's neck to strike the shoulder belt.

WARNING

Never ride with a reclined seatback when the vehicle is moving.

Riding with a reclined seatback increases your chance of serious or fatal injuries in the event of a collision or sudden stop.

Driver and passengers should always sit well back in their seats, properly belted, and with the seatbacks upright.

Seat belts must be snug against your hips and chest to work properly. When the seatback is reclined, the shoulder belt cannot do its job because it will not be snug against your chest. Instead, it will be in front of you. During a collision, you could be thrown into the seat belt, causing neck or other injuries.

The more the seatback is reclined, the greater chance the passenger's hips will slide under the lap belt or the passenger's neck will strike the shoulder belt.

Manual seat controls

 if equipped

The front seat can be adjusted by using the levers located underneath the front part of the seat or on the outer side of the seat.

Forward and rearward adjustment



To move the seat forward or rearward:

1. Pull up the seat slide adjustment lever and hold it.
2. Slide the seat to the desired position.
3. Release the lever and make sure the seat is locked in place. Move forward and rearward without using the lever. If the seat moves, it is not locked properly.

Seatback angle adjustment

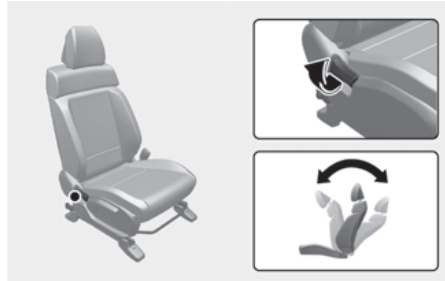

To recline the seatback:

1. Lean forward slightly and lift up the seatback lever.
2. Carefully lean back on the seat and adjust the seatback to the desired position.
3. Release the lever and make sure the seatback is locked in place.

Seat height adjustment



To change the height of the seat:

- Push down on the lever several times, to lower the seat.
- Pull up on the lever several times, to raise the seat.

Power seat controls

 if equipped

The front seat can be adjusted by using the control switches located on the outside of the seat cushion.

WARNING

Never allow children to remain in the vehicle unattended. The power seats are operable when the vehicle is turned off.

NOTICE

To prevent damage to the seats:

- Always stop adjusting the seats when the seat has been adjusted as far forward or rearward as possible.
- Do not adjust the seats longer than necessary when the vehicle is turned off. This may result in unnecessary battery drain.
- Do not operate two or more seats at the same time. This may result in an electrical malfunction.

Forward and rearward adjustment



To move the seat forward or rearward:

1. Push the control switch forward or rearward.
2. Release the switch once the seat reaches the desired position.

Seatback angle adjustment



To recline the seatback:

1. Push the control switch forward or rearward.
2. Release the switch once the seatback reaches the desired position.

Seat cushion tilt/Seat height adjustment



- Seat cushion tilt (1)

To change the angle of the front part of the seat cushion:

1. Push the front portion of the control switch up to raise or down to lower the front part of the seat cushion.
2. Release the switch once the seat reaches the desired position.

- Seat height (2)

To change the height of the seat:

1. Push the rear portion of the control switch up to raise or down to lower the height of the seat.
2. Release the switch once the seat reaches the desired position.

Lumbar support (for driver's seat)

Type A

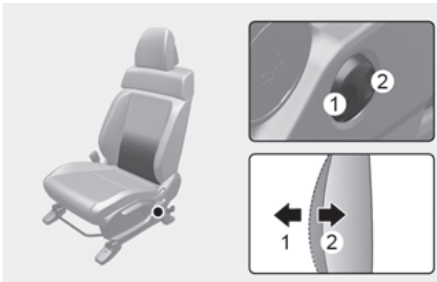

Type B (if equipped)

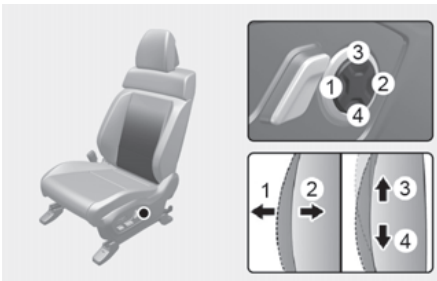

To adjust the lumbar support (Type A):

1. The lumbar support can be adjusted by pressing the lumbar support switch.
2. Press the front portion of the switch (1) to increase support or the rear portion of the switch (2) to decrease support.

To adjust the lumbar support (Type B):

1. Press the front portion of the switch (1) to increase support or the rear portion of the switch (2) to decrease support.
2. Press switch (3) or (4) to move the support position up or down.
3. Release the switch once the lumbar support reaches the desired position.

CAUTION

Do not continue to operate the lumbar support when the lumbar support provides its maximum support. Damage to the lumbar support motor could occur.

Leg support adjustment

 if equipped



Push the control switch forward (1) to raise the leg support.

Push the control switch rearward (2) to lower the leg support.

WARNING

- When lowering or raising the Leg support, be careful not to have your hands or legs caught under the front seats or other surrounding parts of the Leg support. Unexpected injuries may occur.
- Do not allow children to adjust the switch. Unexpected injuries may occur.
- Make sure that the leg support do not interfere with each other while adjusting. The body parts or objects may be damaged if it is caught in the interference.

CAUTION

Do not sit or place heavy objects on the Leg support. It may damage the system.

i Information

The driver's leg support can be raised only when the gear is in P (Park) or when the vehicle speed is below 3 mph (5 km/h).

Relaxation comfort seat

+ if equipped



Relaxation comfort seats help distribute body pressure and concentrated weight on specific body parts that occur while sitting in the same position for a long period of time. The seat helps relieve fatigue and discomfort by providing the optimal sit position.

i Information

Press the auto return button to return to the original seat position after operating the Relaxation comfort seat.

Using the seat adjustment switch other than the auto return button may restrict the downward cushion movement.

! WARNING

Take the following precautions when using the relaxation comfort seat:

- Do not use the relaxation comfort seat while the vehicle is moving. Using the comfort seat could increase the risk of injuries in the event of a collision or sudden stop.
- Do not use the relaxation comfort seat when the luggage or other objects are placed at the rear seat.
- Do not use the relaxation comfort seat while the vehicle is moving. Seat belts may not operate normally due to the lack of adherence between the shoulder belts and the body.
- Do not use the relaxation comfort seat when the rear seats are not in the rearmost position and upright.

Using the relaxation comfort seat

Relaxation comfort seat switch



To activate relaxation comfort seat

Press the switch (1) for more than 0.5 seconds while satisfying the relaxation operating conditions. The seat moves to the relaxation position.

When relaxation comfort seat is activated:

- The seat cushion moves forward or rearward automatically.
- The seat cushion and seatback angle are adjusted.

In the following situation, an alarm appears when the infotainment system is on and the relaxation comfort seat deactivates.

- When the gear is not in P (Parking).
- When the vehicle is moving more than 1.8 mph (3 km/h).
- When the rear seat belt is fastened.

You can adjust the seat by using the seat adjustment switches.



- Pull up the front of the switch (1) to adjust the cushion to the desired position.

- Push down front of the switch (2) to adjust the cushion to the desired position.



- Pull the upper part of the switch rearward (1) to adjust the seat back to the desired position.
- Push the upper part of the switch forward (2) to adjust the seat back to the desired position.

Even when the relaxation comfort seat is operated by others, the additional adjustment is possible by pressing relaxation comfort seat switches.

Returning to the original seat position

Relaxation comfort seat switch



Press the front portion of the switch (1) for more than 0.5 seconds while the seat is in the relaxation comfort seat position, the seat return backs to the original position.

- The driver seat returns to the original position when the gear was in P (Park).

In the following situation, the relaxation comfort seat does not return to the original position.

- When the gear is not in P (Park).
- When the vehicle speed is above 1.8 mph (3 km/h).
- When the driver's seat Integrated Memory System is reset. (if equipped)

i Information

When relaxation comfort seat cannot be operated, reset the Integrated Memory System. If relaxation comfort seat does not operate even after resetting the Integrated Memory System, contact an authorized HYUNDAI dealer.

i Information

Do not use the seat switches simultaneously. It may damage the seat system.

Resetting the Relaxation mode

Refer to the "Integrated Memory System" section in chapter 5 of the complete Owner's Manual.

NOTICE

If resetting stops before the process is complete, restart the resetting procedure. The use of Relaxation mode may be limited if resetting has not been completed.

i Information

After resetting is completed, adjust the seat to the desired position.

Seatback pocket



The seatback pocket is provided on the back of the front seatbacks.

⚠ WARNING

Do not put heavy or sharp objects in the seatback pockets. In a collision, they could come loose from the pocket and injure occupants.

Rear Seats

2nd row seat adjustment (7-seater)

Forward and rearward

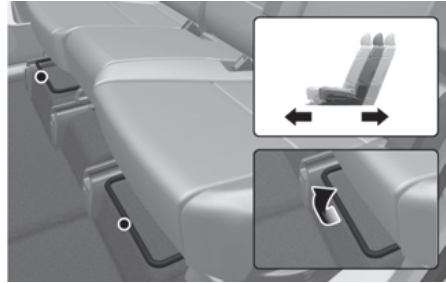

To move the seat forward or rearward:

1. Pull the seat slide adjustment lever up and hold it.
2. Slide the seat to the position you desire.
3. Release the lever and make sure the seat is locked in place.

Adjust the seat before driving, and make sure the seat is locked securely by trying to move forward and backward without using the lever. If the seat moves, it is not locked properly.

Seatback angle adjustment



To recline the seatback:

1. Pull up the seatback recline lever.
2. Hold the lever and adjust the seatback of the seat to the position you desire.
3. Release the lever and make sure the seatback is locked in place. (The lever must return to its original position for the seatback to lock.)

2nd row seat adjustment (6-seater)



Forward and rearward (1)

To move the seat forward or rearward:

1. Pull the seat slide adjustment lever up and hold it.
2. Slide the seat to the position you desire.
3. Release the lever and make sure the seat is locked in place.

Seatback angle adjustment (2)

Push the control switch forward or rearward.

Release the switch once the seatback reaches the desired position.

Seat cushion angle (3)

To change the angle of the front part of the seat cushion:

Push the front portion of the control switch up to raise or down to lower the front part of the seat cushion.

Release the switch once the seat reaches the desired position.

Sliding Unlock switch (4)

1. Press the Sliding Unlock switch to release.
2. Move the seat to your desired front or back position.
3. The seat will automatically lock in place after a short period.
4. Give the seat a gentle shake to ensure it's securely locked

i Information

The sliding unlock feature will not operate when the vehicle is moving over a certain speed.

3rd row seat adjustment

Seatback angle adjustment



1. Pull up the seatback recline strap.
2. Hold the strap and adjust the seatback of the seat to the position you desire.
3. Release the strap and make sure the seatback is locked in place. The strap **MUST** return to its original position for the seatback to lock.

Walk-in seat

If equipped

6-seater



To get in or out of the 3rd row seat:

1. Store the 2nd row seatbelt in the storage holder.
2. Press the 3rd row seat access switch (1) located at the top of the 2nd row seatback. The seatback will fold, and the seat will move forward slightly.
If necessary, slide the 2nd row seat forward after pressing the sliding unlocking switch (2) or slide the 2nd row seat forward while pulling the front lever (3) of the seat cushion.
3. Hold the seat to safely get in or out of the 3rd row seat.
4. After getting in or out of the 3rd row, adjust the position of the 2nd row seat and press the 3rd row seat access switch (1). The seatback will return to its initially set position.

Walk-in switch may not operate properly when:

- When the 2nd row seat belt is fastened
- When the vehicle is moving more than 1.8 mph (3 km/h)
- When the gear is not in P (Park)

WARNING

Before attempting to get out of the 3rd row seat after folding and sliding the 2nd row seat, make sure the vehicle is at a complete stop. Only use the switch once any passengers on the 2nd row have left the vehicle and press the switch to move the 2nd row seat forward.

Never press the button to fold the seat whenever there is a passenger in the 2nd row or someone is getting out of the vehicle. A sudden change to the seat may result in injury.

7-seater

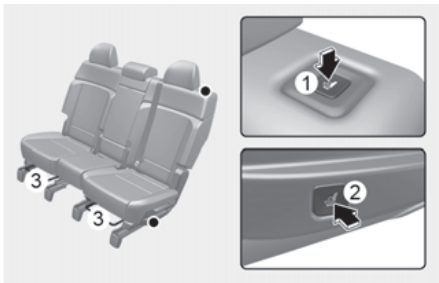

To get in or out of the 3rd row seat:

1. Store the 2nd row seatbelt in the storage holder.
2. Press either the 3rd row seat access switch (1) located at the top of the 2nd row seatback or the 3rd row seat access switch (2) on the outer side of the 2nd row seat. Then the seatback will fold and the seat will move forward slightly.

If necessary, pull the lever at the front of the seat cushion (3) and push the 2nd row seat forward.

3. Hold the seat to safely get in or out of the 3rd row seat.
4. After accessing or exiting the 3rd row, adjust the position of the 2nd row seat, and have the seatback to the upright position.

WARNING

When folding and sliding the 2nd row seat to access the 3rd row, ensure the vehicle is completely stopped. Only operate the switch after any occupants or passenger of the 2nd row seat have disembarked. Do not press the button to fold the seat if someone is seated or disembarking from the 2nd row seat, as sudden seat movement may result in injury.

WARNING

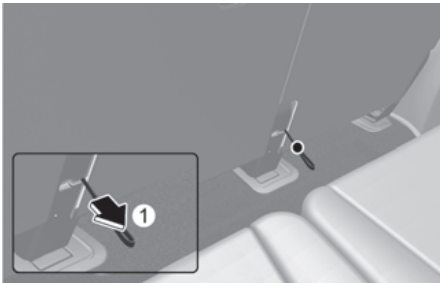

- If the walk-in switch does not work, pull the strap (1) located on the lower left side of the seat. Then you can move the 2nd row seat forward.
- Never attempt to pull the strap (1) while the 2nd row seat is occupied as the seat may suddenly move and cause the passenger on the seat to be injured. Use only the strap when the walk-in switch does not work.

Folding the rear seats

The rear seatbacks can be folded to facilitate carrying long items or to increase the luggage capacity of the vehicle.

To fold down the rear seatback:

1. Locate the seatbelt toward the outboard position before folding down the seatback to avoid the seatbelt system interfering with the seatback.
2. Lower the rear head restraints to the lowest position.
3. Route the seat belt webbing through the rear seat belt guides to prevent the belts from being trapped behind or under the seats.

7-Seater



- Pull the seat angle adjustment lever (located in the 2nd row seat) to completely fold the seatback toward the front of the vehicle. Make sure the seatback is locked in place.
- When using it as a seat, pull the seat angle adjustment lever (2nd row seat) to fully raise the seatback. Adjust the seatback to the desired angle and release the lever to lock in place.

6-seater



Cargo area



- With the door open, the seatback will recline when you pull the upper portion of seatback switch for more than a second while the seatback is folded down toward the front and the plate is not locked in the seatbelt buckle of the 2nd row seat (when the seatback is folded, pull the upper portion of this switch rearward more than a second to unfold the seatback). You may also press fold/unfold switch. Make sure the seatback is locked in place.
- When using it as a seat, push the upper portion of the seatback angle adjustment switch rearward for more than a second to have an upright position. You can also press the seatback fold/unfold switch.
- Once the seatback is raised, lightly shake it back and forth to ensure it is securely locked before driving.

3rd row seat

1. Pull the seatback folding/unfolding strap to completely fold the seatback forward. Make sure the seatback is securely locked in place.



2. When using it as a seat, pull the seatback folding/unfolding strap to fully raise the seatback. Adjust the seatback to the desired angle, and release the upper angle adjustment strap to lock in place. Make sure the seatback is locked in place.

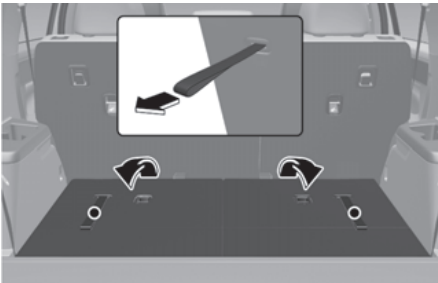

! WARNING

When returning the rear seatback from a folded to an upright position, hold the seatback and return it slowly. Ensure that the seatback is completely locked into its upright position by pushing on the top of the seatback. In a collision or sudden stop, the unlocked seatback could allow cargo to move forward with great force and enter the passenger compartment, which could result in serious injury or death.

! WARNING

Do not place objects in the rear seats, since they cannot be properly secured and may hit vehicle occupants in a collision causing serious injury or death.

! WARNING

Make sure the engine is off, the shift lever is in P (Park), and the parking brake is securely applied whenever loading or unloading cargo. Failure to take these steps may allow the vehicle to move if the shift lever is inadvertently shifted to another position.

! CAUTION

- Be careful when loading cargo through the rear passenger seats to prevent damage to the vehicle interior.
- When cargo is loaded through the rear passenger seats, ensure the cargo is properly secured to prevent it from moving while driving.
- Unsecured cargo in the passenger compartment can cause damage to the vehicle or injury to its occupants.

2nd row seatback remote folding (7-seater)

 if equipped

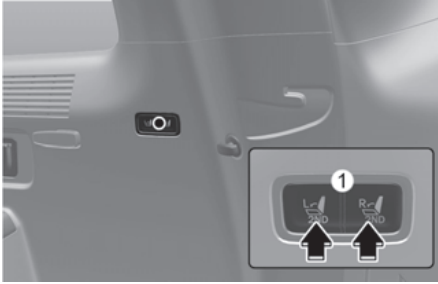

With the liftgate open, this feature allows you to conveniently fold the 2nd row seatback forward.

1. Press the seatback folding switch (1) located on the right side of the liftgate.
2. Once the seatback is folded forward, the space can be used for cargo.
3. If the seatback does not fold down completely, push it to make sure it's fully folded.

WARNING

Always check for any occupants or passengers in the 2nd row seats before folding. Do not fold the seat if there are pets, luggage, passengers sitting in the 2nd row seats, or when passengers are getting out of the vehicle. A sudden movement of the seat may cause injury.

2nd row seatback remote folding/unfolding (6-seater)

 if equipped

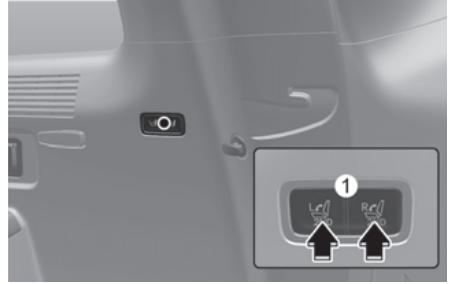

With the liftgate open, this feature allows you to conveniently fold or unfold the 2nd row seatback forward or rearward.

1. Press the seatback folding/unfolding switch (1) located on the right side of the liftgate. You can also select **Setup > Seat > 2nd row seatback remote folding/unfolding** in the infotainment system. You may choose between folding or unfolding of 2nd row seatback.
2. When the seatback is folded forward, the space can be used for cargo.
3. If the seatback doesn't fully fold down, push it to fold it completely.
4. When the seatback is folded, press the fold/unfold switch (1) to unfold the seatback.

WARNING

Always check for any occupants or passengers in the 2nd row seats before folding or unfolding. Do not adjust the seat if there are pets, luggage, passengers sitting in the 2nd row seats, or when passengers are getting out of the vehicle. A sudden movement of the seat may cause injury.

Armrest (2nd row seat)

6-seater



To adjust the armrest to a desired angle: Lift the armrest to slightly above the highest position, then lower it to the lowest position, then lift the armrest to position it to the desired angle.

7-seater



The armrest is located in the center of the rear seat. Pull the armrest down from the seatback to use it.

Head Restraints

The vehicle's front and rear seats have adjustable head restraints. The head restraints are designed to help protect passengers from whiplash and other neck and spinal injuries during a collision, especially a rear impact collision. When there are no occupants in the rear seats, adjust the rear head restraints to the lowest height to improve the driver's visibility.

WARNING

To help reduce, the risk of serious injury or death in a crash, take the following precautions when adjusting your head restraints:

- Always adjust the head restraints properly for all passengers BEFORE starting the vehicle.
- Never let anyone ride in a seat with the head restraints removed or reversed.
- Adjust the head restraints so that the middle of the head restraint is at the same height as the top of the eyes.



- Never adjust the driver's head restraint when the vehicle is moving.
- Make sure the head restraint is locked in place after adjustment.

Front seat head restraints

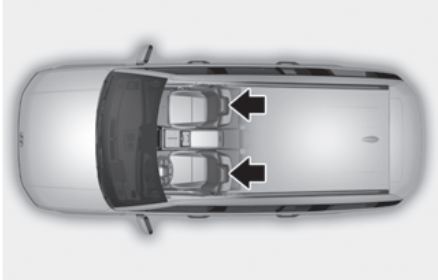

The driver's and front passenger's seats are equipped with adjustable head restraint for the passengers safety and comfort.

Forward and rearward adjustment

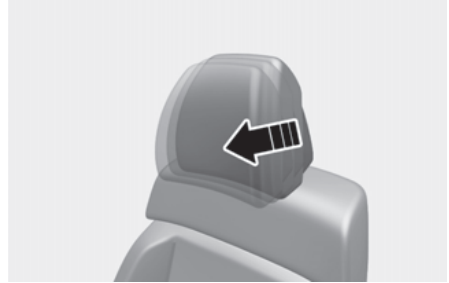

The head restraint may be adjusted forward to 3 different positions by pulling the head restraint forward to the desired detent. To adjust the head restraint to its furthest rearwards position, pull it fully forward to the farthest position and release it.

Adjusting the height up and down

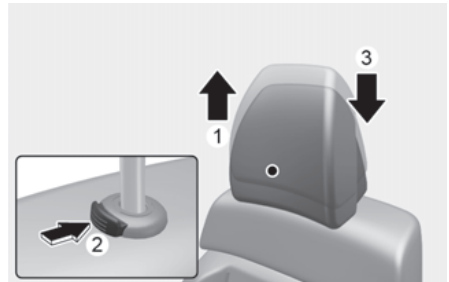

To raise the head restraint:

1. Pull it up to the desired position (1).

To lower the head restraint:

1. Press and hold the release button (2) on the head restraint support.
2. Lower the head restraint to the desired position (3).

Removal/Reinstallation

Manual

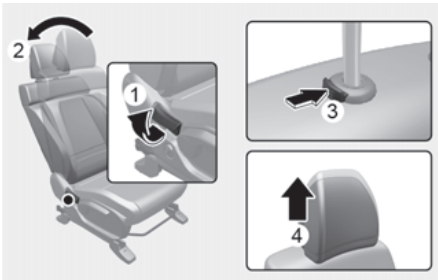

Auto



To remove the head restraint:

1. Recline the seatback (2) with the seatback angle lever or switch (1).
2. Raise the head restraint as far as it can go.
3. Press the head restraint release button (3) while pulling the head restraint up (4).

WARNING

Never allow anyone to travel in a seat with the head restraint removed.

Manual

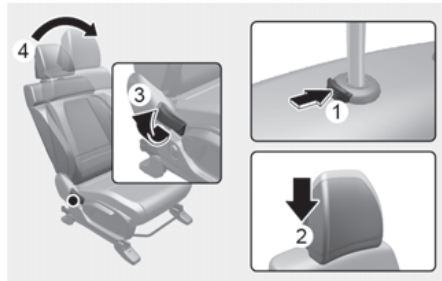

Auto



To reinstall the head restraint:

1. Recline the seatback.
2. Put the head restraint poles (2) into the holes while pressing the release button (1).
3. Adjust the head restraint to the appropriate height.
4. Return the seatback (4) with the seatback angle lever or switch (3).

WARNING

Always make sure the head restraint is locked in place and properly adjusted for the passenger.

Rear seat head restraint

6, 7-seater

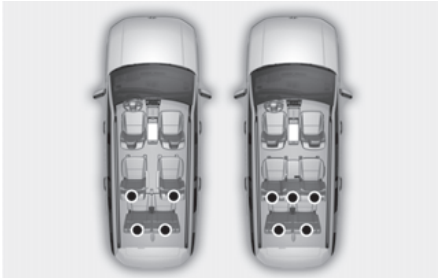

The rear seats are equipped with head restraint in all the seating positions for the passenger's safety and comfort.

WARNING

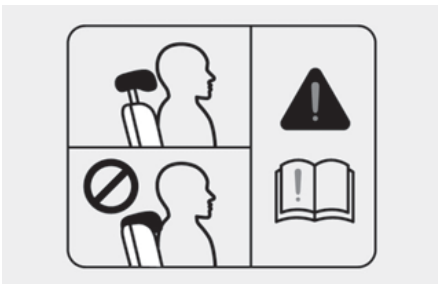

When a passenger is sitting on the 2nd row center seat, always raise the head restraint above the lowest stored position.

Adjusting the height up and down

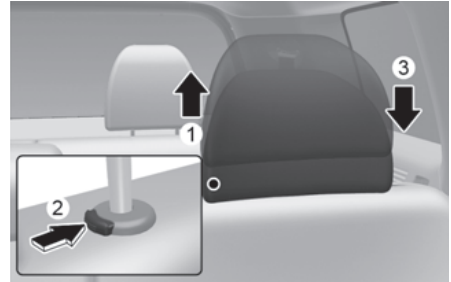

To raise the head restraint:

1. Pull it up to the desired position (1).

To lower the head restraint:

1. Press and hold the release button (2) on the head restraint support.
2. Lower the head restraint to the desired position (3).

Removal/Reinstallation

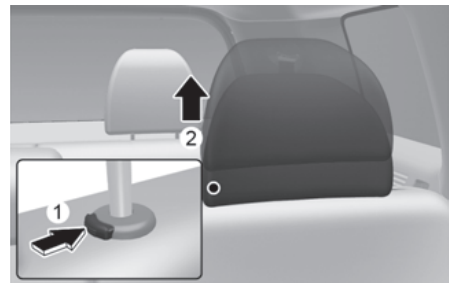

To remove the head restraint:

1. Raise the head restraint as far as it can go.
2. Press the head restraint release button (1) while pulling up the head restraint (2).

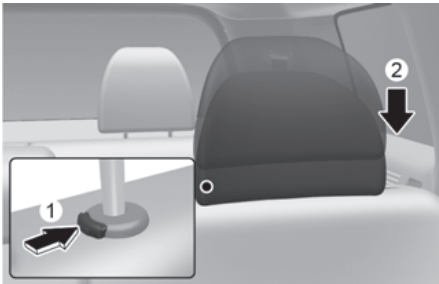

To reinstall the head restraint:

1. Put the head restraint poles into the holes (3) while pressing the release button (1).
2. Adjust the head restraint to the appropriate height.

3rd row seat head restraint folding

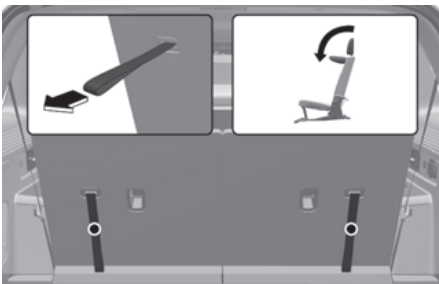

- To fold the 3rd row head restraint, pull the head restraint folding strap.
- To use the third row head restraint, unfold the head restraint manually.

Seat Warmers

if equipped

Seat warmers are provided to warm the seats during cold weather.

During mild weather or under conditions where the operation of the seat warmer is not needed, keep the seat warmers off.

WARNING

The seat warmers can cause serious burns, even at low temperatures and especially if used for long periods of time. Passengers must be able to feel if the seat is becoming too warm so they can turn it off, if needed.

Seat warmers consumes huge amount of electricity. Please avoid using seat warmers while the vehicle is off in order to prevent the battery discharge.

People who cannot detect temperature change or pain to the skin should use extreme caution, especially the following types of passengers:

- Infants, children, elderly or disabled persons, or people with medical condition causing insensitivity to hot objects or heat intolerance and heat and temperature sensitivity.
- People with sensitive skin or who burn easily.
- Fatigued individuals.
- Intoxicated individuals.
- People taking medication that may cause drowsiness or sleepiness.

Never place anything on the seat that insulates against heat when the seat warmer is operating, such as a blanket or seat cushion.

NOTICE

To prevent damage to the seat warmers and seats:

- Never use a solvent such as paint thinner, benzene, alcohol or gasoline to clean the seats.
- Do not place heavy or sharp objects on seats equipped with seat warmers.
- Do not change the seat cover. It may damage the seat warmer.

Front seat warmers

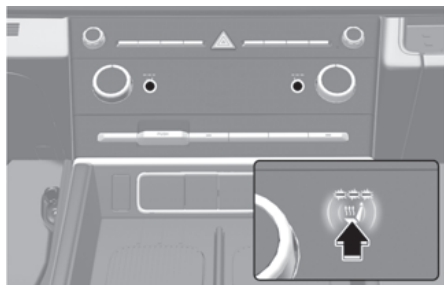

While the engine is running, touch the icon to warm the driver's seat or front passenger's seat.

Touch the icon repeatedly to cycle through the seat warmer temperature from high, medium, low, and off.

i Information

- The seat warmer temperature is lowered automatically and then goes off after a certain time to prevent low temperature burns. If high temperature is selected again after the seat warmer turns off, the temperature is controlled automatically again.
- The seat warmer defaults to the OFF position whenever the Engine Start/Stop button is pressed to the ON position.

Rear seat warmers



While the engine is running, press the seat warmer button to warm the rear seat. Press the button repeatedly to cycle through the seat warmer temperature from high, medium, low, and off.

i Information

- The seat warmer temperature is lowered automatically and then goes off after a certain time to prevent low temperature burns. If high temperature is selected again after the seat warmer turns off, the temperature is controlled automatically again.
- The seat warmer defaults to the OFF position whenever the Engine Start/Stop button is pressed to the ON position.

Air Ventilation Seats

 if equipped

The air ventilation seats cool the front seats by blowing air through small vent holes on the surface of the seat cushions and seatbacks.

When the air ventilation seat is not desired, keep the air ventilation seats off.

NOTICE

To prevent damage to the air ventilation seats:

- Do not change the seat covers. It may damage the air ventilation seat.
- Do not place materials such as plastic bags or newspapers under the seats. They may block the air intake causing the air vents not to work properly.
- Never use a solvent such as paint thinner, benzene, alcohol, or gasoline to clean the seats.
- Avoid spilling liquids on the surface of the front seats and seatbacks. This may cause the air vent holes to become blocked and not to work properly.
- If the air vents do not operate, restart the vehicle. If there is no change, have your vehicle inspected by an authorized HYUNDAI dealer.

Front air ventilation seats

 if equipped

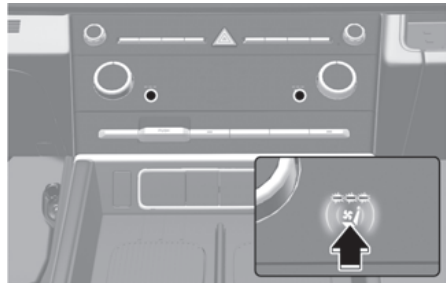

While the engine is running, touch the icon to cool the driver's seat or front passenger's seat.

Touch the icon to repeatedly to cycle through the airflow speed from high, medium, low, and off.

Information

- It may take 3 to 5 minutes after switch operation to feel the temperature change.
- Use the air ventilation seat with the air conditioning on for more effective ventilation.
- The air ventilation seat defaults to the OFF position whenever the Engine Start/Stop button is pressed to the ON position.

Seat Belts

This section describes how to use the seat belts properly. It also describes some of the things not to do when using seat belts.

Seat Belt Safety Precautions

Always fasten your seat belt and make sure all passengers have fastened their seat belts before starting any trip. Airbags are designed to supplement the seat belt as an additional safety device, not a replacement. Most states require all vehicle occupants wear seat belts.

WARNING

Seat belts must be used by ALL passengers whenever the vehicle is moving. To prevent serious injury or death:

- Children under the age of 13 should be properly restrained in the rear seats.
- Never allow children to ride in the front passenger seat, unless the airbag is deactivated. If a child is seated in the front passenger seat, move the seat as far back as possible. And the child must always be restrained in the seat properly.
- NEVER allow an infant or child to be carried on an occupant's lap.
- NEVER ride with the seatback reclined when the vehicle is moving.
- Do not allow children to share a seat or seat belt.
- Do not wear the shoulder belt under your arm or behind your back.

- NEVER wear a seat belt over fragile objects. If there is a sudden stop or impact, the seat belt can damage it.
- Do not use the seat belt if it is twisted. A twisted seat belt will not protect you properly in a collision.
- Do not use a seat belt if the webbing or hardware is damaged.
- Do not latch the seat belt into the buckles intended for other seating positions.
- Never unfasten the seat belt while driving. This may cause loss of vehicle control resulting in a collision.
- Make sure there is nothing in the buckle that could interfere with the seat belt latch mechanism from fastening securely.
- Never modify seatbelt or install devices that may prevent seatbelt assembly from removing slack.
- Do not use a seat belt if the webbing or hardware is damaged. Have the seat belt replaced by an authorized HYUNDAI dealer.

WARNING

Damaged seat belts and seat belt assemblies do not operate properly. Always replace:

- Frayed, contaminated, or damaged webbing.
- Damaged hardware.
- The entire seat belt assembly after it has been worn in a crash, even if damage to webbing or assembly is not apparent.

Seat Belt Warning Light

Instrument cluster

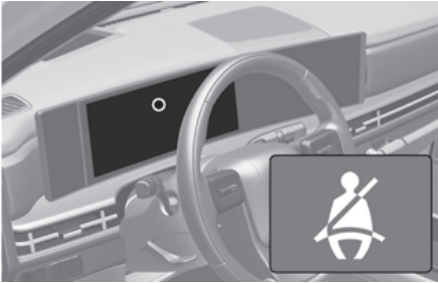

The seat belt warning light and warning chime operate under the following conditions.

Driver's seat belt warning

As a reminder to the driver, the seat belt warning lights will illuminate for about 6 seconds each time you turn the Engine Start/Stop button ON regardless of belt fastening. If the seatbelt is not fastened, the warning chime will sound for about 6 seconds.

If you start to drive without the seat belt fastened over 5 mph (9 km/h) and less than 12 mph (20 km/h), the corresponding warning light will illuminate. The warning light will turn off when the vehicle speed drops below 5 mph (9 km/h).

If you start to drive without the seat belt fastened or you unfasten the seat belt when you drive 12 mph (20 km/h) and faster, the warning light will blink and warning chime will sound for about 100 seconds. When the seat belt is unfastened during driving, the warning light will illuminate when the speed is under 12 mph (20 km/h). When the speed is 12 mph (20 km/h) and faster, the warning light will blink and warning chime will sound for about 100 seconds.

Front passenger's seat belt warning

As a reminder to the front passenger, the seat belt warning lights will illuminate for about 6 seconds each time you turn the Engine Start/Stop button ON regardless of belt fastening.

If you start to drive without the passenger seat belt fastened when you drive over 5 mph (9 km/h) and less than 12 mph (20 km/h), the corresponding warning light will illuminate. The warning light will turn off when the vehicle speed drops below 5 mph (9 km/h).

If you start to drive without the passenger seat belt fastened or you unfasten the seat belt when you drive 12 mph (20 km/h) and faster, the warning light will blink and warning chime will sound for about 100 seconds.

When the passenger seat belt is unfastened during driving, the warning light will illuminate when the speed is under 12 mph (20 km/h). When the speed is 12 mph (20 km/h) and faster, the warning light will blink and warning chime will sound for about 100 seconds.

! WARNING

Riding in an improper position may adversely affect the front passenger's seat belt warning system. Instruct the passenger to properly be seated when the vehicle is moving.

i Information

- If the front passenger seat is not occupied, the seat belt warning light blinks or illuminates for 6 seconds.
- The front passenger's seat belt warning may operate when luggage is placed on the front passenger seat.

Rear passenger's seat belt warning

6-seater



7-seater



As a reminder to the rear passenger, the rear passenger's seat belt warning lights will illuminate for about 6 seconds each time the Engine Start/Stop button is in the ON position regardless of belt fastening.

If the seat belt is not fastened when the Engine Start/Stop button is in the ON position, the seat belt warning light will illuminate for about 70 seconds.

After wearing the seat belt, if the rear passenger unfastens the seat belt and you drive under 12 mph (20 km/h), the corresponding warning light will continue to illuminate for about 70 seconds.

After wearing the seat belt, if the rear passenger unfastens it when you drives over 12 mph (20 km/h), the seat belt warning chime will sound for about 35 seconds and the corresponding warning light will blink.

If the rear door is opened or closed under 6 mph (10 km/h), the warning light and warning sound do not activate even if you drive over 12 mph (20 km/h).

Seat Belt Restraint System

⚠ WARNING



Improperly positioned seat belts may increase the risk of serious injury in a crash. Take the following precautions when adjusting the seat belt:

- Position the lap portion of the seat belt as low as possible across your hips, not on your waist, so that it fits snugly. This allows your strong pelvic bones to absorb the force of a collision, reducing the chance of internal injuries.
- Position one arm under the shoulder belt and the other over the belt, as shown in the illustration.
- Always position the shoulder belt anchor into the locked position at an appropriate height.
- Never position the shoulder belt across your neck or face.

Driver's Seat Belt – 3-point system with emergency locking retractor

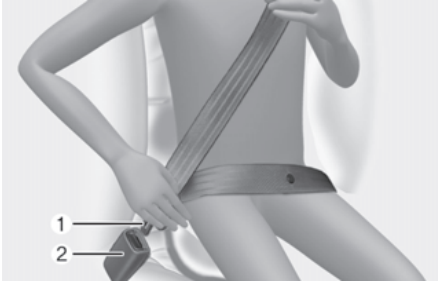

To fasten your seat belt:

Pull the seat belt out of the retractor and insert the metal tab (1) into the buckle (2). An audible "click" sounds when the tab locks into the buckle. Make sure the seat belt is not twisted.



Place the lap belt (1) portion across your hips and the shoulder belt (2) portion across your chest.

The seat belt automatically adjusts to the proper length after the lap belt portion is adjusted manually so that it fits snugly around your hips. If you lean forward in a slow, easy motion, the belt extends and moves with you.

If there is a sudden stop or collision, the belt is locked in place. It also locks if you try to lean forward too quickly.

i Information

If you cannot smoothly pull the seat belt out from the retractor, firmly pull the seat belt out and release it. After release, the belt may be pulled out smoothly.

Height adjustment

Adjust the height of the shoulder belt so that it lies across your chest and midway over your shoulder nearest the door, not over your neck.

Front seat

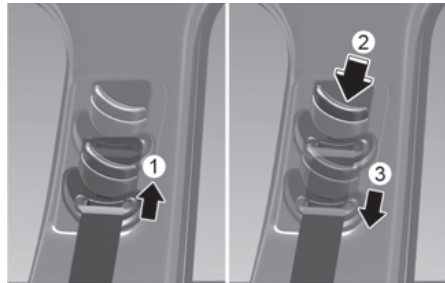

To adjust the height of the seat belt anchor:

Pull it up (1) to raise the height. To lower it, push it down (3) while pressing the height adjuster button (2).

Release the button to lock the anchor in place. Try pushing the height adjuster down to make sure that it is locked in place.

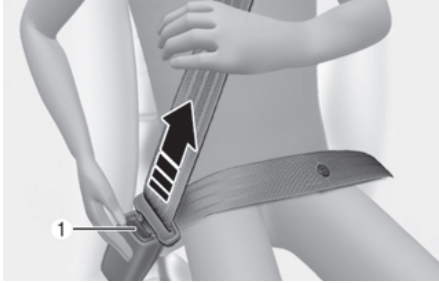
To release your seat belt:

Press the release button (1) in the locking buckle.

The belt should automatically draw back into the retractor. If this does not happen, check the belt is not twisted, then try again.

Passenger and Rear Seat Belts - 3-point system with convertible locking retractor

This type of seat belt combines both an emergency locking retractor and an automatic locking retractor. Convertible retractor type seat belts are installed in the rear seat positions to help accommodate the installation of child restraint systems.

A convertible retractor is also installed in the front passenger seat position, children should always be seated in the rear and never place any infant/child restraint system in the front seat.

To fasten your seat belt:

Pull the seat belt out of the retractor and insert the metal tab into the buckle. An audible "click" sounds when the tab locks into the buckle. Pull the shoulder portion of the belt to snug the belt across your hips and remove slack. Make sure the seat belt is not twisted.

When not securing a child restraint, the seat belt automatically adjusts to the proper length only after the lap belt portion of the seat belt is adjusted manually so that it fits snugly across your hips.

When the seat belt has been fully extended from the retractor to allow for the installation of a child restraint system, the seat belt operation changes to allow the belt to retract, but not to extend (Automatic Locking Retractor Type). Refer to the "Child Restraint System (CRS)" section in this chapter.

To release your seat belt:

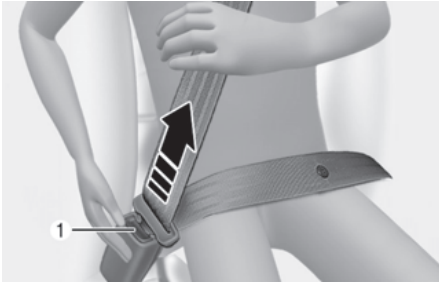

Press the release button (1) in the locking buckle.

The belt should automatically draw back into the retractor. If this does not happen, check the belt is not twisted, then try again.

i Information

- The emergency locking mode allows seated passengers to move freely in their seats while keeping some tension on the belt. During a collision or sudden stop, the retractor automatically locks the belt to help restrain the passengers.
- To deactivate the automatic locking mode, unbuckle the seat belt and allow the belt to fully retract.

Second row center seat belt (3-point rear center seat belt)

+ if equipped

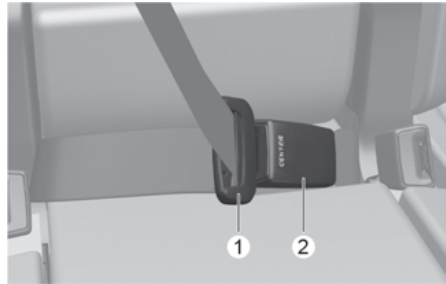

Insert the tongue plate (1) into the buckle (2) until an audible "click" is heard, indicating the latch is locked. Pull the shoulder portion of the belt to snug the belt across your hips and remove slack. Make sure the seat belt is not twisted.

When using the rear center seat belt, use the buckle with the "CENTER" mark.

i Information

If you cannot pull out the safety belt from the retractor, firmly pull the belt out and release it. After release, pull out the belt smoothly.

! WARNING

Make sure the seatback is locked in place when using the rear center seat belt. If not secure, the seatback may move if there is a sudden stop or crash and result in serious injury or death.

Stowing the rear seat belt

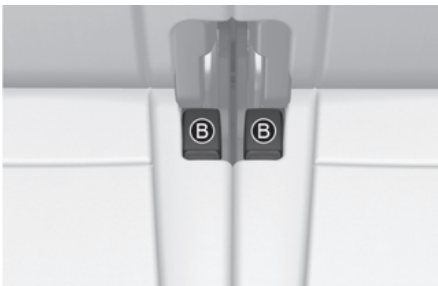
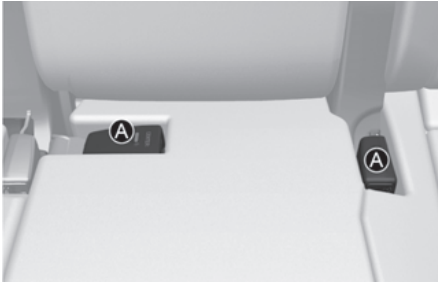

[A] : 2nd row seat (7-seater)
[B] : 3rd row seat

The rear seat belt buckles can be stowed in the pocket between the rear seatback and cushion when not in use.

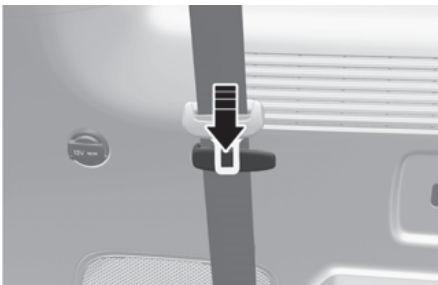

Routing the seat belt webbing through the rear seat belt guides will help keep the belts from being trapped behind or under the seats.

After inserting the seat belt, tighten the belt webbing by pulling it up.

WARNING

When using the seat belt, use it after taking it out of the guides.

If you pull the seat belt when it is stored in the guides, it may damage the guides and/or belt webbing.

Pretensioner seat belt

Retractor pretensioner seat belt (Front seat and second row outboard seat)



Your vehicle is equipped with driver's and front passenger's and rear passengers pretensioner seat belts (retractor pretensioner). The pretensioner makes sure the seat belts fit tightly against your body in certain frontal or side collision(s). The pretensioner seat belts may be activated in some crashes where the frontal or side collision(s) is severe enough, together with the airbags.

When the vehicle stops suddenly, or if you try to lean forward too quickly, the seat belt retractor locks in place.

In some frontal collisions, the pretensioner activates and pulls the seat belt against your body.

WARNING

To prevent serious injury or death:

- Always wear your seat belt and sit properly in your seat.
- Do not use the seat belt if it is loose or twisted.
- Do not place anything near the buckle.
- Always replace your pretensioners after activation or a crash.
- Never inspect, service, repair or replace the pretensioners by yourself.

Have the pretensioners inspected, serviced, repaired, or replaced by only an authorized HYUNDAI dealer.

- Do not hit seat belt assemblies.

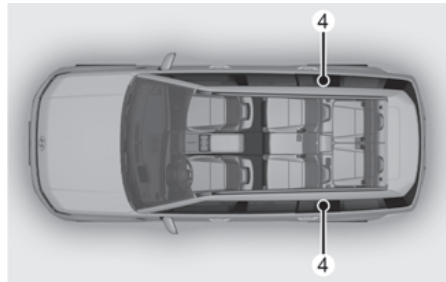
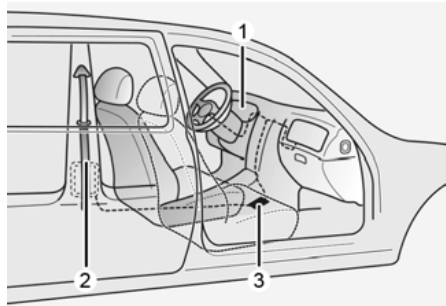

WARNING

Do not touch the pretensioner seat belt assemblies for several minutes after they have been activated. When the pretensioner seat belt mechanism deploys during a collision, the pretensioner can become hot and can burn you.

WARNING

Have the system serviced by an authorized HYUNDAI dealer. Body work on the front of the vehicle may damage the pretensioner seat belt system.

The pretensioner seat belt system consists mainly of the following components. Their locations are shown in the illustration above:

- (1) SRS airbag warning light
- (2) Front retractor pretensioner
- (3) SRS control module
- (4) Rear retractor pretensioner

The sensor that activates the SRS control module is connected with the pretensioner seat belt. The SRS airbag warning light on the instrument cluster illuminates for about 3-6 seconds after the Engine Start/Stop button is in the ON position, and then it turns off.

If the pretensioner is not working properly, the warning light illuminates even if the SRS airbag is not malfunctioning. If the warning light does not illuminate when starting the engine or stays illuminated or illuminates while driving, have the pretensioner seat belts and/or SRS control module inspected by an authorized HYUNDAI dealer as soon as possible.

i Information

- The pretensioner seat belt system may be activated in certain frontal or side collisions or rollover situations.
- When the pretensioner seat belts are activated, a loud noise may be heard and fine dust, which may appear to be smoke, may be visible in the passenger compartment. These are normal operating conditions and are not hazardous.
- Although it is non-toxic, the fine dust may cause skin irritation and should not be inhaled for prolonged periods. Wash all exposed skin areas thoroughly after a crash in which the pretensioner seat belts were activated.

Additional Seat Belt Safety Precautions

Seat belt use during pregnancy

The seat belt should always be used during pregnancy. The best way to protect your unborn child is to protect yourself by always wearing the seat belt.

Pregnant women should always wear a lap-shoulder seat belt. Place the shoulder belt across your chest, routed between your breasts and away from your neck. Place the lap belt below your belly and pull the shoulder portion so it fits SNUGLY across your hips and pelvic bone, under the rounded part of your belly.

⚠ WARNING

- A pregnant woman is more vulnerable to any impacts on the abdomen during an abrupt stop or collision. If you are in a crash while pregnant, consult your doctor.
- To reduce the risk of serious injury or death to an unborn child during a crash, do not let pregnant women place the lap portion of the seat belt above or over the area of the abdomen where the unborn child is located.

Seat belt use and children

Infant and small children

All 50 states have Child Restraint System laws that require children to travel in approved Child Restraint System devices, including booster seats. The age at which seat belts can be used instead of Child Restraint System may be different, so you should be aware of the specific requirements in your state where you are traveling. Infant and Child Restraint System must be properly placed and installed in a rear seat.

For more information, refer to the "Seat Belt Safety Precautions" section in this chapter.

WARNING

Always properly restrain infants and small children in a Child Restraint System appropriate for the child's height and weight.

To reduce the risk of serious injury or death to a child and other passengers, never hold a child in your lap or arms when the vehicle is moving. Violent forces during a collision will tear the child from your arms and throw the child against the interior or to be ejected from the vehicle.

Small children are best protected from injury in a crash when properly restrained in the rear seat by a Child Restraint System that meets the requirements of the Federal Motor Vehicle Safety Standards. Before buying any Child Restraint System, make sure that it has a label certifying that it meets the applicable Safety Standards. The Child Restraint System must be appropriate for your child's height and weight. Check the label on the Child Restraint System for this information.

Refer to the "Child Restraint System (CRS)" section in this chapter.

Larger children

Children under age 13 and who are too large for a booster seat should always occupy the rear seat and use the available lap/shoulder belts. A seat belt should be snug against the hips and be snug across the shoulder and chest to restrain the child safely. A child's squirming could move the belt out of position. Adults should frequently check belt fit. In a collision, the safest place for children is in the rear seats, using a Child Restraint System appropriate for the child.

If a larger child over age 13 must be seated in the front seat, the child must be securely restrained by the available seat belt and the seat should be placed in the rearmost position.

If the shoulder belt portion slightly touches the child's neck or face, try placing the child closer to the center of the vehicle. If the shoulder belt still touches their face or neck, the child needs to return to an appropriate booster seat in the rear seat.

! WARNING

- Always make sure children's seat belts are buckled and properly adjusted.
- Never allow the shoulder belt to contact the child's neck or face.
- Do not allow more than one child to use a single seat belt.

Seat belt use and injured people

A seat belt should still be used when an injured person is being transported. Consult a physician for specific recommendations.

One person per belt

When two people (children or adults) are sitting together, never attempt to use a single seat belt. This could increase the severity of injuries in a collision.

Do not lie down

Sitting in a reclined position when the vehicle is moving, can be dangerous. Even when buckled up, the protections of your restraint system (seat belts and/or airbags) are greatly reduced by reclining your seatback.

Seat belts must be snug against your hips and chest to work properly.

During a collision, you could be thrown into the seat belt, causing neck or other injuries.

The more the seat back is reclined, the greater the chance for the passenger's hips to slide under the lap belt or the passenger's neck to strike the shoulder belt.

! WARNING

- Never ride with a reclined seatback when the vehicle is moving.
- Do not ride with a reclined seatback. It may increase your chance of serious or fatal injuries in the event of a collision or sudden stop.
- Have the driver and all passengers always sit well back in their seats, properly belted, and with the seatbacks upright.

Care of Seat Belts

Seat belt systems should never be disassembled or modified.

Periodic inspection

All seat belts should be inspected periodically for wear or damage of any kind. Any damaged parts should be replaced as soon as possible.

Keep belts clean and dry

Seat belts should be kept clean and dry. If belts become dirty, they can be cleaned by using a mild soap solution and warm water. Bleach, dye, strong detergents, or abrasives should not be used because they may damage and weaken the fabric.

When to replace seat belts

The entire seat belt assembly or assemblies should be replaced if the vehicle has been involved in a crash. This should be done even if no damage is visible. Consult an authorized HYUNDAI dealer for assistance.

Child Restraint System (CRS)

Children Always in the Rear

WARNING

Always properly restrain children in the rear seats of the vehicle. Children of all ages are safer when restrained in the rear seat. A child riding in the front passenger seat can be forcefully struck by an inflating airbag resulting in serious injury or death.

Children under age 13 should always ride in the rear seats and must always be properly restrained to minimize the risk of injury in a collision, sudden stop, or sudden maneuver.

According to crash statistics, children are safer when properly restrained in the rear seat than in the front seat. Even with airbags, children can be seriously injured or killed. Children too large for a Child Restraint System must use the seat belts provided.

All 50 states have child restraint laws that require children to travel in approved Child Restraint Systems.

The laws governing the age or height/weight restrictions at which seat belts can be used instead of Child Restraint System differs among states, so you should be aware of the specific requirements where you are travelling.

Child Restraint Systems must be properly placed and installed in the rear seat. Use a commercially available Child Restraint System that meets the requirements of the Federal Motor Vehicle Safety Standards (FMVSS 213).

Child Restraint Systems are generally designed to be secured in a vehicle seat by a lap/shoulder seat belt, or by a LATCH system in the rear seats of the vehicle.

Child Restraint System

Infants and younger children must be restrained in an appropriate rearward-facing or forward-facing Child Restraint System that has first been properly secured to the rear seats of the vehicle. Read and comply with the instructions for installation and use provided by the manufacturer of the Child Restraint System.

WARNING

Do not use an improperly secured child restraint. It may increase the risk of serious injury or death in a collision.

When using a Child Restraint System:

- Never install a child or infant restraint in the front passenger's seat.
- Always properly secure the Child Restraint System in the rear seat of the vehicle.
- Always follow the Child Restraint System manufacturer's instructions for installation and use.
- Always properly restrain your child in the Child Restraint System.

- If the head restraint prevents proper installation of a child seat (as described in the Child Restraint System manual), readjust or remove the head restraint for that seating position.
- Do not use an infant carrier or a child safety seat that "hooks" over a seatback. It may not provide adequate protection in a crash.
- After a crash, have an authorized HYUNDAI dealer check the Child Restraint System, seat belts, tether anchors, and lower anchors.

Selecting a Child Restraint System

When selecting a Child Restraint System for your child, always:

- Make sure the Child Restraint System has a label certifying that it meets applicable Federal Motor Vehicle Safety Standards (FMVSS 213).
- Select a Child Restraint System based on your child's height and weight. The required label or the instructions for use typically provide this information.
- Select a Child Restraint System that fits the vehicle seating position where it is to be used.
- Read and comply with the warnings and instructions for installation and use provided with the Child Restraint System.

Child Restraint System types

There are three main types of Child Restraint Systems: rearward-facing, forward-facing, and booster seat Child Restraint Systems.

They are classified according to the child's age, height, and weight.

Rearward-facing Child Restraint System



With a rearward-facing Child Restraint System, the collision forces are absorbed by its shell instead of the child's body. The shell also supports the system's cradles and protects the head, neck and spine of the child. All children under the age of one year must always ride in a rearward-facing Child Restraint System. Convertible and 3-in-1 Child Restraint Systems typically have higher height and weight limits for the rearward-facing position, allowing you to keep your child rearward-facing for a longer period of time.

Continue using the Child Restraint Systems in the rearward-facing position as long as the child is within the height and weight limits allowed by the Child Restraint System's manufacturer. It's the best way to keep them safe. Once your child has outgrown the rearward-facing Child Restraint System, your child is ready for a forward-facing Child Restraint System with a harness.

⚠ WARNING

Never install a child or infant restraint in the front passenger's seat.

Placing a rearward-facing child restraint in the front seat may result in serious injury or death, if the child restraint is struck by an inflating airbag.

Forward-facing Child Restraint System



A forward-facing Child Restraint System provides restraint for the child's body with a harness. Keep children in a forward-facing Child Restraint System with a harness until they reach the top height or weight limit allowed by your Child Restraint System's manufacturer.

Once your child outgrows the forward-facing Child Restraint System, your child is ready for a booster seat.

Booster seats

A booster seat is a Child Restraint System designed to improve the fit of the vehicle's seat belt system. A booster seat positions the seat belt so that it fits properly over the lap of your child. Keep your children in booster seats until they are big enough to fit in a seat belt properly.

For a seat belt to fit properly, the lap belt must lie snugly across the upper thighs, not the stomach. The shoulder belt should lie snug across the shoulder and chest and not across the neck or face. Children under age 13 must always be properly restrained to minimize the risk of injury in a crash, sudden stop, or sudden maneuver.

Installing a Child Restraint System

WARNING

Before installing your Child Restraint System, always read and follow the instructions provided by the manufacturer of the Child Restraint System and in this manual to prevent serious injury or death if a collision occurs.

WARNING

If the vehicle head restraint prevents proper installation of a Child Restraint System, readjust or remove the head restraint for that seating position.

After selecting a proper Child Restraint System for your child and checking that the Child Restraint System fits properly in a rear seating position, there are three general steps for proper installation:

- **Properly secure the Child Restraint System to the vehicle.** All Child Restraint Systems must be secured to the vehicle with the a lap/shoulder belt or with a LATCH system in the rear seat of the vehicle.

Make sure the Child Restraint System is firmly secured. After installing a Child Restraint System in the vehicle, push and pull the seat forwards and backwards and from side to side to verify that it is securely attached to the seat. Install a Child Restraint System secured with a seat belt as tightly as possible. Some side-to-side movement can be expected.

- **Secure a child in the Child Restraint System.** Make sure the child is properly strapped in the Child Restraint System according to the Child Restraint System manufacturer's instructions.

CAUTION

Check the seating surface and buckles before placing your child in the Child Restraint System to prevent burns. A Child Restraint System in a closed vehicle can become very hot.

Lower Anchors and Tether for Children (LATCH System)

The LATCH system connects a Child Restraint System to the vehicle during driving and in a collision. This system is designed to make installation of the Child Restraint System easier and reduce the possibility of improperly installing your Child Restraint System. The LATCH system uses anchors in the vehicle and attachments on the Child Restraint System. The LATCH system eliminates the need to use seat belts to secure the Child Restraint System to the rear seats.

Lower anchors are metal bars built into the vehicle. There are two lower anchors for each LATCH seating position that accommodates a Child Restraint System with lower attachments.

To use the LATCH system in your vehicle, install a Child Restraint System with LATCH attachments.

The Child Restraint System manufacturer provides you with instructions on how to use the Child Restraint System with its attachments for the LATCH anchors.

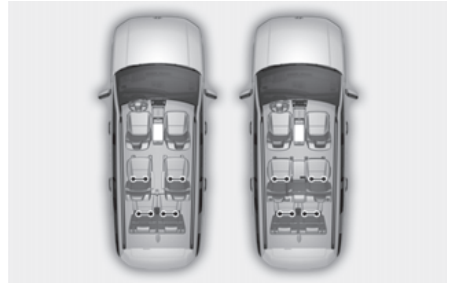

LATCH anchors have been provided in the left and right outboard rear seating positions. Their locations are shown in the illustration. There are no LATCH anchors provided for the center rear seating position.

WARNING

Do not attempt to install a Child Restraint System using LATCH anchors in the rear center seating position. There are no LATCH anchors provided for this seat. Do not use the outboard seat anchors for the center seat. It may damage the anchors that may break or fail in a collision resulting in serious injury or death.

Rear passenger seat

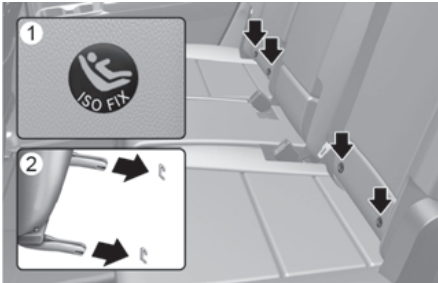

[A] Lower Anchor Position Indicator
[B] Lower Anchor

The lower anchor position indicator symbols are located on the left and right rear seatbacks to identify the positions of the lower anchors in your vehicle.

The LATCH anchors are located between the seatback and the seat cushion of the rear seat left and right outboard seating positions.

WARNING

Before installing the Child Restraint System, make sure that there are no objects (e.g. toys, pens, wires) near the lower anchor area. Those objects may damage either the seat belt system or the Child Restraint System during installation. If necessary, have the vehicle inspected by an authorized HYUNDAI dealer.

Securing a Child Restraint System with the LATCH Anchors System

To install a LATCH-compatible Child Restraint System in either of the rear outboard seating positions:

1. Move the seat belt buckle away from the lower anchors.
2. Move any other objects away from the anchorages that could prevent a secure connection between the Child Restraint System and the lower anchors.
3. Place the Child Restraint System on the vehicle seat, then attach the seat to the lower anchors according to the instructions provided by the Child Restraint System manufacturer.
4. Follow the instructions of the Child Restraint System's manufacturer for proper installation and connection of the lower attachments on the Child Restraint System to the lower anchors.

WARNING

Take the following precautions when using the LATCH system:

- Read and follow all installation instructions provided with your Child Restraint System.
- To prevent the child from reaching and taking hold of unretracted seat belts, buckle all unused rear seat belts and retract the seat belt webbing behind the child. Children can be strangled if a shoulder belt becomes wrapped around their neck and the seat belt tightens.

- Never attach more than one Child Restraint System to a single anchorage. This could cause the anchor or attachment to come loose or break.
- Always have the LATCH system inspected by an authorized HYUNDAI dealer after a collision. A collision can damage the LATCH system and may not properly secure the Child Restraint System.

WARNING

Make sure that the combined weight of the child and the child restraint system is less than 65 lbs. (30 kg) for each LATCH system.

Securing a Child Restraint System seat with Tether Anchor system

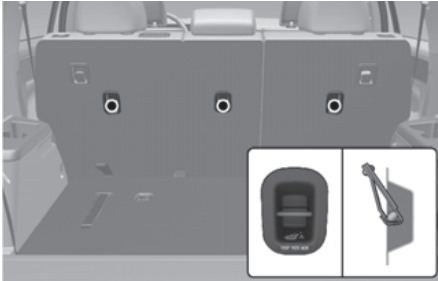

First secure the child restraint with the LATCH lower anchors or the seat belt. If the child restraint manufacturer recommends that the top tether strap be attached, attach and tighten the top tether strap to the top tether strap anchor.

Tether anchors are located on the rear of the second row seatbacks and third row seatbacks.



To install the tether anchor:

1. Route the Child Restraint System top tether strap over the seatback. Route the tether strap under the head restraint and between the head restraint posts, or route the tether strap over the top of the vehicle seatback. Make sure the strap is not twisted.
2. Connect the tether strap hook to the tether anchor, then tighten the top tether strap according to the instructions of your Child Restraint System's manufacturer to firmly secure the Child Restraint System.
3. Check the Child Restraint System is secure by pushing and pulling the seat forward and back and side-to-side.

⚠ WARNING

Take the following precautions when installing the top tether:

- Read and follow all installation instructions provided with your Child Restraint System.
- Never attach more than one Child Restraint System to a single tether anchor. This could cause the anchor or attachment to come loose or break.
- Only attach the tether strap to the correct tether anchor for that seating position.
- Make sure that the Child Restraint System anchors withstand the combined weight of the child and the child restraint system of less than 65 lbs. (30 kg) for each LATCH system.

Do not use them for adult seat belts, harnesses, or for attaching other items or equipment to the vehicle.

Securing a Child Restraint System with a lap/shoulder belt

⚠ WARNING

Always place a rearward-facing Child Restraint System in the rear seat of the vehicle.

Placing a rearward-facing child restraint in the front seat may result in serious injury or death if the Child Restraint System is struck by an inflating airbag.

When not using the LATCH system, all Child Restraint Systems must be secured to a rear seat using the lap/shoulder belt.



Automatic locking mode

Since all passenger seat belts move freely under normal conditions and only lock under extreme or emergency conditions (emergency locking mode), you must manually pull the seat belt all the way out to shift the retractor to the Automatic Locking mode to secure a Child Restraint System.

The Automatic Locking mode will help prevent the normal movement of the child in the vehicle from causing the seat belt to loosen and compromise the Child Restraint System.

To install a Child Restraint System on the rear seats:

1. Place the Child Restraint System on a rear seat and route the lap/shoulder belt around or through the Child Restraint System, following the Child Restraint System manufacturer's instructions. Make sure the seat belt webbing is not twisted.

i Information

When using the rear center seat belt, refer to the "Passenger and Rear Seat Belts - 3-point system with convertible locking retractor" section in this chapter.

2. Fasten the lap/shoulder belt latch into the buckle. Check a distinct "click" sound is heard.



i Information

Position the release button so it is easy to access in an emergency.

3. Pull the shoulder portion of the seat belt all the way out. When the shoulder portion of the seat belt is fully extended, it shifts the retractor to the Automatic Locking (child restraint) mode.



4. Slowly allow the shoulder portion of the seat belt to retract and listen for an audible "clicking" or "ratcheting" sound. This indicates that the retractor is in the Automatic Locking mode. If no distinct sound is heard, repeat Step 3 and 4.



5. Remove as much slack from the belt as possible by pushing down on the Child Restraint System while feeding the shoulder belt back into the retractor.
6. Push and pull on the Child Restraint System to confirm that the seat belt is holding it firmly in place. If it is not, release the seat belt and repeat Step 2 through 6.

7. Double check that the retractor is in the Automatic Locking mode by attempting to pull more of the seat belt out of the retractor. If you cannot, the retractor is in the Automatic Locking mode.

If your Child Restraint System manufacturer instructs or recommends you to use a tether anchor with the lap/shoulder belt, refer to the previous pages for more information.

Information

When the seat belt is allowed to retract to its fully stowed position, the retractor automatically switches from the Automatic Locking mode to the emergency lock mode for normal adult usage.

WARNING

Make sure that the retractor is in the Automatic Locking mode. Otherwise, the child restraint may move when your vehicle turns or stops suddenly. A child may be seriously injured or killed if the child restraint is not properly anchored in the vehicle including manually pulling the seat belt all the way out to shift the retractor to the Automatic Locking mode.

To remove the Child Restraint System, press the release button on the buckle and then pull the seat belt out of the Child Restraint System and allow the seat belt to retract fully.

Supplemental Restraint System - Airbags

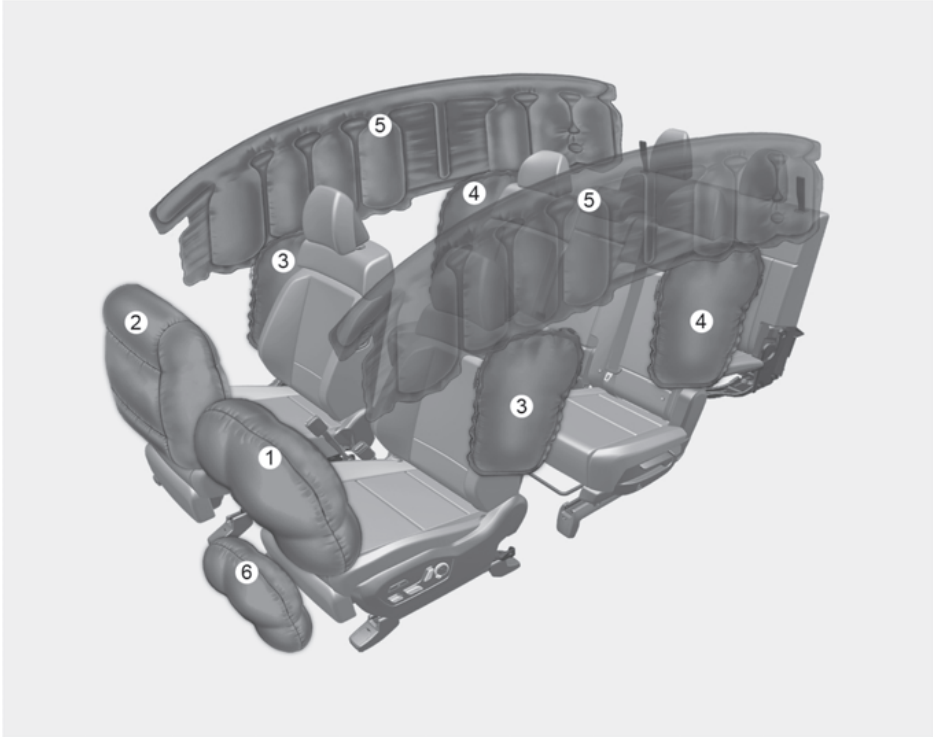

The actual airbags in the vehicle may differ from the illustration.

- (1) Driver's front airbag
- (2) Passenger's front airbag
- (3) Front side airbag
- (4) Rear side airbag
- (5) Curtain airbag
- (6) Driver's knee airbag

Your vehicle is equipped with a Supplemental Airbag System for the driver's seat and front passenger's seats.

The front airbags are designed to supplement the three-point seat belts. For these airbags to provide protection, seat belts must be properly worn at all times when driving. You can be severely injured or killed in a crash if you are not wearing a seat belt. Airbags are built into the vehicle as a supplementary system. They are not intended as a replacement for wearing 3-point seat belts. Also, airbags are not designed to deploy in every collision. In some crashes, the seat belts are the only restraint protecting you.



WARNING

AIRBAG SAFETY PRECAUTIONS

- Always use seat belts and Child Restraint Systems - every trip, every time, everyone! Even with airbags, you can be seriously injured or killed in a collision if you are improperly belted or not wearing your seat belt when the airbag inflates.
- Never place a child in any Child Restraint System or booster seat in the front passenger seat, unless the airbag is deactivated.

An inflating airbag could forcefully strike the infant or child causing serious or fatal injuries.

- ABC - Always Buckle Children under age 13 in the back seat. It is the safest place for children of any age to ride. If a child age 13 or older must be seated in the front seat, he or she must be properly belted and the seat should be moved as far back as possible.
- Make sure that all occupants sit upright with the seatback in an upright position, centered on the seat cushion with their seat belt on, legs comfortably extended, and their feet on the floor until the vehicle is parked and the vehicle is turned off. If an occupant is out of position during a crash, the rapidly deploying airbag may forcefully contact the occupant causing serious or fatal injuries.
- Never sit or lean unnecessarily close to the airbags or lean against the door or center console.

Move your seat as far back as possible from front airbags, while still maintaining control of the vehicle. The U.S. National Highway Traffic Safety Administration (NHTSA) recommends that drivers allow at least 10 in. (25 cm) between the center of the steering wheel and the chest.

SRS Components

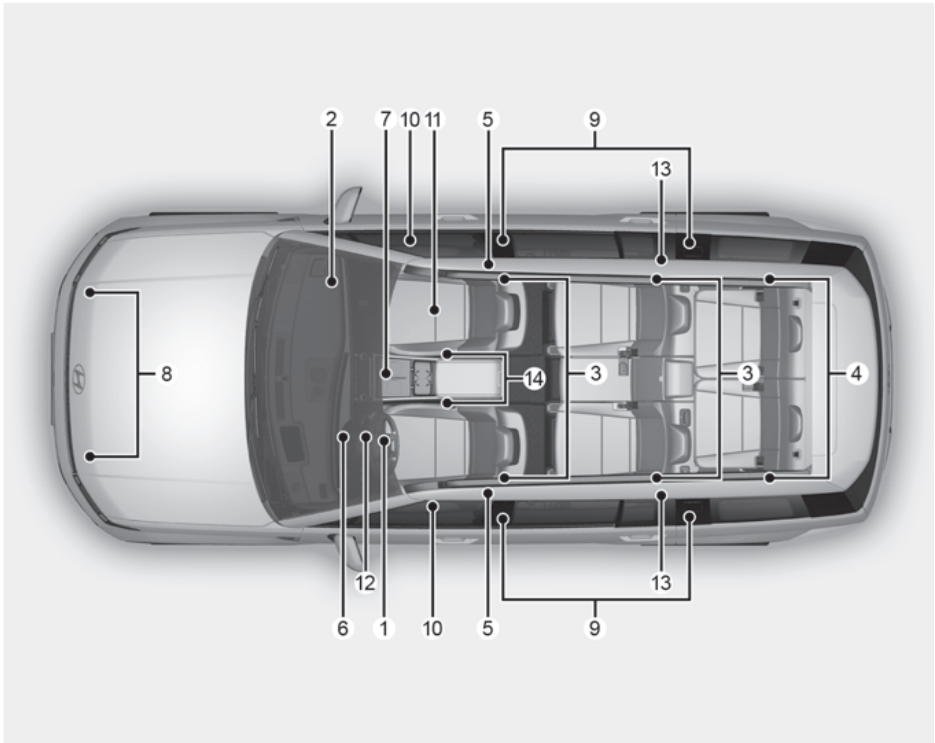

The SRS consists of the following components:

- (1) Driver's front airbag module
- (2) Passenger's front airbag module
- (3) Side airbag modules
- (4) Curtain airbag modules
- (5) Front retractor pretensioner
- (6) Airbag warning light
- (7) SRS control module (SRSCM)/Rollover sensor
- (8) Front impact sensors
- (9) Side impact sensors
- (10) Side pressure sensors
- (11) Occupant classification system
- (12) Driver's knee airbag module
- (13) Rear retractor pretensioner
- (14) Buckle sensor

Where are the Airbags?

Driver's and passenger's front airbags

Driver's front airbag



Driver's knee airbag

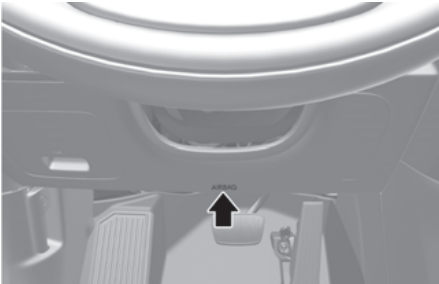

Passenger's front airbag

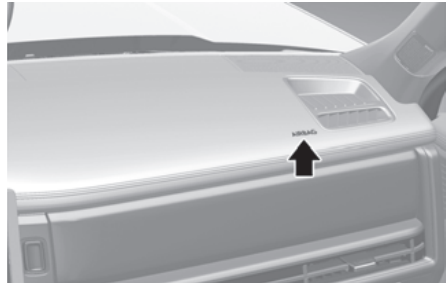

The SRS consists of advanced airbags located in the center of the steering wheel and the passenger's side front panel pad above the glove box.

The airbag locations are embossed with the letters "AIRBAG".

The purpose of the SRS is to provide the vehicle's driver and front passenger with additional supplemental protection that the seat belt system does not provide in case of a frontal impact of sufficient severity.

The SRS uses sensors to gather information about the driver's and front passenger's seat belt usage and impact severity.

The seat belt buckle sensors determine if the driver and front passenger's seat belts are fastened. These sensors provide the ability to control the SRS deployment based on whether or not the seat belts are fastened, and how severe the impact is.

The SRS offers the ability to control the airbag inflation within two levels. A first stage level is provided for moderate-severity impacts. A second stage level is provided for more severe impacts.

According to the impact severity and seat belt usage, the SRS Control Module (SRSCM) controls the airbag inflation. Failure to properly wear seat belts may increase the risk or severity of injury in a collision.

WARNING

To reduce the risk of serious injury or death from inflating front airbags:

- Seat belts must be worn at all times to help keep occupants positioned properly.
- Move your seat as far back as possible from front airbags, while still maintaining control of the vehicle.
- Never lean against the door or center console.
- Hold the steering wheel at the 9 o'clock and 3 o'clock positions, to minimize the risk of injuries to your hands and arms.
- Do not allow the front passenger to place their feet or legs on the dashboard.
- Never place any objects (such as dashboard cover, mobile phone holder, cup holder, perfume or stickers) over or near the airbag modules on the steering wheel, instrument panel, windshield glass, and the front passenger's panel above the glove box. Such objects may cause harm if the vehicle is in a collision severe enough to cause the airbags to deploy.
- Do not attach any objects on the front windshield and inside mirror.

Side airbags

Front



Rear



The side airbags are designed to deploy during certain side impact collisions, depending on the crash severity.

The side airbags on both sides of the vehicle are designed to deploy when a rollover is detected by a rollover sensor.

The side airbags are not designed to deploy in all side impact or rollover situations.

WARNING

To reduce the risk of serious injury or death from an inflating side airbag:

- Seat belts must be worn at all times to help keep occupants positioned properly.
- Do not allow passengers to lean their heads or bodies onto doors, put their arms on the doors, stretch their arms out of the window, or place objects between the doors and seats.
- Do not use any accessory seat covers. It may reduce or prevent the effectiveness of the system.
- Do not hang other objects except clothes. In a crash it may cause vehicle damage or personal injury especially when airbag is inflated.
- Do not place any objects over the airbag location or between the airbag and yourself. Also, do not attach any objects around the area the airbag inflates such as door, side door glass, and front and rear pillar.
- Do not place any objects between the door and the seat. They may become dangerous projectiles if the side airbag inflates.
- Do not install any accessories on the side or near the side airbags.
- Do not cause an impact to the doors when the Engine Start/Stop button is in the ON or START position because the side airbags can inflate.
- If the seat or seat cover is damaged, have the vehicle serviced by an authorized HYUNDAI dealer.

Curtain airbags



Curtain airbags are located along both sides of the roof rails above the front and rear doors.

They are designed to help protect the heads of the front seat occupants and the rear outboard seat occupants in certain side impact collisions.

The curtain airbags are designed to deploy during certain side impact collisions, depending on the crash severity.

For vehicles equipped with a rollover sensor the side and/or curtain airbags and pretensioners on both sides of the vehicle may deploy if a rollover or possible rollover is detected.

The curtain airbags are not designed to deploy in all side impact or rollover situations.

WARNING

To reduce the risk of serious injury or death from an inflating curtain airbag:

- All occupants must wear seat belts at all times to help keep occupants positioned properly.
- Properly secure a Child Restraint System as far away from the door as possible.
- Do not place any objects over the airbag. Also, do not attach any objects around the area the airbag inflates such as door, side door glass, front and rear pillar, and roof side rail.
- Do not hang other objects except clothes, especially hard or breakable objects near airbag locations. In a crash, it may cause vehicle damage or personal injury.
- Do not allow passengers to lean their heads or bodies onto doors, put their arms on the doors, stretch their arms out of the window, or place objects between the doors and seats.
- Do not open or repair the side curtain airbags.

How does the Airbag System Operate?

The SRSCM (Supplemental Restraint System Control Module) continually monitors all SRS components while the Engine Start/Stop button is ON to determine if a crash impact is severe enough to require airbag deployment or pretensioner seat belt deployment.

During a moderate to severe frontal collision, sensors detect the vehicle's rapid deceleration. If the rate of deceleration is high enough, the SRSCM inflates the front airbags with the force needed.

The front airbags help protect the driver and front passenger by responding to frontal impacts in which seat belts alone cannot provide adequate restraint. When needed, the side airbags help provide protection in the event of a side impact or rollover by supporting the side upper body area.

- Airbags are activated (able to inflate if necessary) only when the Engine Start/Stop button is in the ON or START position, and it may be activated within 3 minutes after the engine is turned off.
- Airbags inflate in the event of certain frontal or side collisions to help protect the occupants from serious physical injury.
- There is no single speed at which the airbags will inflate. Generally, airbags are designed to inflate based upon the severity of a collision and its direction. Airbag deployment also depends on a number of other factors including vehicle speed, angles of impact and the density and stiffness of the vehicles or objects which your vehicle impacts during a collision. The determining factors are not limited to those mentioned above.

- The front airbags completely inflate and deflate in an instant. It is virtually impossible for you to see the airbags inflate during a crash. It is much more likely that you simply see the deflated airbags hanging out of their storage compartments after the collision.

- In addition to inflating in serious side collisions, vehicles equipped with a rollover sensor, side and/or curtain airbags inflate if the sensing system detects a rollover.

When a rollover is detected, curtain airbags remain inflated longer to help provide protection from ejection, especially when used in conjunction with the seat belts, (if equipped with a rollover sensor).

- To help provide protection, the airbags must inflate rapidly. The speed of airbag inflation is a consequence of extremely short time in which the airbag inflates between the occupant and the vehicle structures before the occupant impacts those structures. This speed of inflation reduces the risk of serious or life-threatening injuries and is thus a necessary part of airbag design.

However, the rapid airbag inflation may also cause injuries that include facial abrasions, bruises, and broken bones because the inflation speed also causes the airbags to expand with great force.

- There are even circumstances under which contact with the airbag may cause fatal injuries, especially when the occupant is positioned excessively close to the airbag.

You can take steps to reduce the risk of being injured by an inflating airbag. The greatest risk is sitting too close to the airbag. An airbag needs about 10 in. (25 cm) of space to inflate. NHTSA recommends that drivers allow at least 10 in. (25 cm) between the center of the steering wheel and the chest.

WARNING

To reduce the risk of serious injury or death from an inflating airbag:

- Never place a child restraint in the front passenger seat.
Always properly restrain children under age 13 in the rear seats of the vehicle.
 - Adjust the front passenger's and driver's seats as far to the rear as possible while maintaining you to maintain full control of the vehicle.
 - Hold the steering wheel with hands at the 9 o'clock and 3 o'clock positions.
 - Never place anything or anyone between the airbag and the seat occupant.
 - Do not allow the front passenger to place their feet or legs on the dashboard.
-

Driver's front airbag (1)



When the SRSCM detects a sufficiently severe impact to the front of the vehicle, it automatically deploys the front airbags.

Driver's front airbag (2)

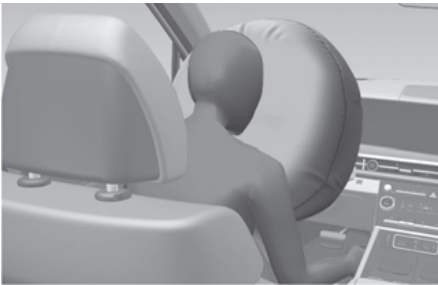

Upon deployment, tear seam in the pad cover separates from the expansion of the airbags.

A fully inflated airbag, in combination with a properly worn seat belt, slows the driver's or the front passenger's forward motion, reducing the risk of head and chest injury.

Driver's front airbag (3)

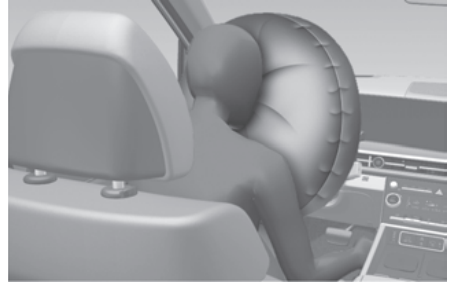

Passenger's front airbag

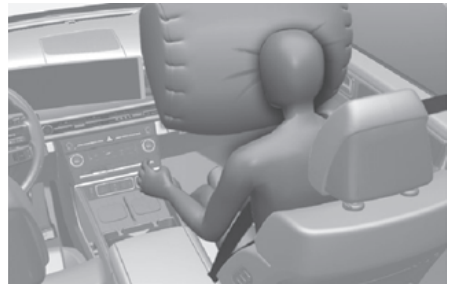

After complete inflation, the airbag immediately starts deflating, enabling the driver to maintain forward visibility and steer or operate other controls.

WARNING

To prevent objects from becoming dangerous projectiles when the passenger's airbag inflates:

- Do not install or place any objects (drink holder, CD holder, stickers, etc.) on the front passenger's panel above the glove box where the passenger's airbag is located.
- Do not install a container of liquid air freshener near the instrument cluster or on the instrument panel surface.

What to Expect After an Airbag Inflates

After a frontal or side airbag inflates, it deflates very quickly. Airbag inflation does not prevent the driver from seeing out of the windshield or being able to steer. Curtain airbags may remain partially inflated for some time after they deploy.

WARNING

After an airbag inflates, take the following precautions:

- Open your windows and doors as soon as possible after impact to reduce prolonged exposure to the powder released by the inflating airbag.
 - Do not touch the airbag storage area's internal components immediately after an airbag has inflated. The parts that come into contact with an inflating airbag may be very hot.
 - Always wash exposed skin areas thoroughly with cold water and mild soap.
 - Have an authorized HYUNDAI dealer inspect your vehicle and replace components as required before operating your vehicle again. Airbags are designed to be used only once.
-

Noise and powder from inflating airbag

When the airbags inflate, they make a loud noise and may release powder inside the vehicle. After the airbag inflates, you may feel discomfort while breathing. This may be due to the impact of the airbag or the seat belt with your chest and it may also be due to breathing residual powder in the air and around your vehicle. The powder may aggravate asthma for some people. If you experience breathing problems after an airbag deployment, seek medical attention immediately.

Though the powder is nontoxic, it may cause irritation to the skin, eyes, nose, throat, etc. If this is the case, wash and rinse with cold water immediately and seek medical attention if the symptoms persist.

SRS Warning Light



The SRS (Supplemental Restraint System) airbag warning light on the instrument panel displays the airbag symbol in the illustration. The light indicates if there is a potential problem with your airbag system, which could include your side and/or curtain airbags used for rollover protection.

WARNING

If your SRS malfunctions, the airbags may not inflate properly during a collision increasing the risk of serious injury or death.

Your SRS malfunctions in the following conditions:

- The light does not turn on for about three to six seconds when the Engine Start/Stop button is in the ON position.
- The light stays on after illuminating for about three to six seconds.
- The light comes on while the vehicle is moving.
- The light blinks when the engine is running.

Have an authorized HYUNDAI dealer inspect the SRS as soon as possible.

Occupant Classification System (OCS)



Your vehicle is equipped with an Occupant Classification System (OCS) in the front passenger's seat.

Main components of the Occupant Classification System

- A detection device located within the front passenger seat cushion.
- Electronic system to determine whether the passenger airbag systems should be activated or deactivated.
- An indicator light located on the instrument panel that illuminates the words "PASSENGER AIR BAG OFF" indicating the front passenger airbag system is deactivated.
- The instrument panel airbag indicator light is interconnected with the OCS.

The OCS is designed to help detect the presence of a properly seated front passenger and determine if the passenger's front airbag should be enabled (ready to inflate if required) or not.

The purpose is to help reduce the risk of injury or death from an inflating airbag to certain front passenger seat occupants, such as children, by requiring the airbag to be automatically turned off.

For example, if a Child Restraint System is installed on the seat, the Occupant Classification System can detect it and turn off the front passenger airbag.

Front passenger seat adult occupants who are properly seated and wearing the seat belt properly, should not cause the passenger airbag to be automatically turned off. For smaller adults, it may turn off. However, if the occupant does not sit in the seat properly (for example, not sitting upright, sitting on the edge of the seat, or being out of position), this may cause the sensor to turn the front passenger airbag off.

You can find the "PASSENGER AIR BAG OFF" indicator on the overhead console panel. This system detects one of the four conditions as described in the following table and activates or deactivates the front passenger airbag based on these conditions.

Always make sure that you and all occupants are seated properly and wearing the seat belt properly for the most effective protection by the airbag and the seat belt.

Condition and operation in the front passenger Occupant Classification System

Condition detected by the occupant classification system	Indicator/Warning light		Devices
	"PASSENGER AIR BAG OFF" indicator light	SRS warning light	Front passenger airbag
Adult ^{*1}	Off	Off	Activated
Infant ^{*2} or child restraint system with 12 months old ^{*3 *4}	On	Off	Deactivated
Unoccupied	On	Off	Deactivated
Problems with OCS	Off	On	Activated

*1 The system judges a person of adult size as an adult. When a smaller adult sits in the front passenger seat, the system may recognize him/her as a child depending on his/her physique and posture.

*2 Do not allow children to ride in the front passenger seat. When a larger child who has outgrown a Child Restraint System sits in the front passenger seat, the system may recognize him/her as an adult depending on his/her physique or sitting position.

*3 Never install a Child Restraint System on the front passenger seat.

*4 The "PASSENGER AIR BAG OFF" indicator may turn ON or OFF when a child above 12 months to 12 years old (with or without Child Restraint System) sits in the front passenger seat. This is a normal condition.

 **WARNING**

Riding in an improper position or placing weight on the front passenger's seat when it is unoccupied by a passenger, adversely affects the OCS. To reduce the risk of serious injury or death:

- Never put a heavy load in the front seat or seatback pocket, or hang any items on the front passenger seat.



- Never place your feet on the front passenger seatback.



- Never sit with your hips shifted toward the front of the seat.



- Never ride with the seatback reclined when the vehicle is moving.



- Never place your feet or legs on the dashboard.



- Never lean on the door or center console or sit on one side of the front passenger seat.



- Do not use car seat accessories such as thick blankets and cushions that cover up the car seat surface.



- Do not sit on the passenger seat wearing heavily padded clothes such as ski wear and hip protector.



- Do not place electronic devices such as laptops, DVD player, or conductive materials such as water bottles on the front passenger seat.
- Do not use electronic devices such as laptops and satellite radios that use inverter chargers when seated in the front passenger seat.



- Make sure the seat has been completely dried before driving the vehicle. If a large quantity of liquid has been spilled on the front passenger seat, the airbag warning light may illuminate or malfunction.



- Do not place sharp objects on the front passenger seat. These may damage the occupant detection system, if they puncture the seat cushion.
- Do not place any items under the front passenger seat.
- When changing or replacing the seat or seat cover, use original items only. The OCS has been developed based on using original HYUNDAI car seats only. Altering or changing the authentic parts may result in system malfunction and increase risk of injury in a collision. Any of the above may interfere with the proper operation of the OCS sensor thereby increasing the risk of an injury in a crash.

Proper seated position for OCS



If the "PASSENGER AIR BAG OFF" indicator is on when an adult is seated in the front passenger seat, move the Engine Start/Stop button to the OFF position and ask the passenger to sit properly (sitting upright with the seatback in an upright position, centered on the seat cushion with their seat belt on, legs comfortably extended, and their feet on the floor). Restart the engine and have the person remain in that position. This allows the system to detect the person and to enable the passenger airbag. If the "PASSENGER AIR BAG OFF" indicator is still on, ask the passenger to move to the rear seat.

⚠ WARNING

Never allow an adult passenger to ride in the front passenger seat when the "PASSENGER AIR BAG OFF" indicator is illuminated. During a collision, the airbag does not inflate if the indicator is illuminated. If the indicator is illuminated while an adult is seated in the front passenger seat, follow the steps in the previous paragraph to have the passenger reposition themselves in the seat.

If the "PASSENGER AIR BAG OFF" indicator remains illuminated after the passenger sits in the proper seating position, have the passenger sit in the rear seat of the vehicle instead.

***i* Information**

The "PASSENGER AIR BAG OFF" indicator generally illuminates for about 4 seconds after the Engine Start/Stop button is in the ON or START position. But, if the Engine Start/Stop button is in the ON or START position within 3 minutes after the engine is turned OFF, the indicator does not illuminate. If the front passenger seat is occupied, the OCS classifies the front passenger after several seconds.

Do not install a Child Restraint System on the Front Passenger's Seat

Even though your vehicle is equipped with the OCS, never install a Child Restraint System in the front passenger's seat. An inflating airbag may forcefully strike a child or child restraint resulting in serious or fatal injury.

⚠ WARNING

Never use a rearward facing Child Restraint on a seat protected by an ACTIVE AIRBAG in front of it. It may result in death or serious injury to the CHILD. Children should always ride in the rear seats.

Why didn't My Airbag Go Off In a Collision?

There are certain types of crashes in which the airbag would not deploy including rear impacts and second or third collisions in multiple impact crashes, as well as low speed impacts. Damage to the vehicle indicates a collision energy absorption, and is not an indicator of whether or not an airbag should have inflated.

Airbag collision sensors



WARNING

To reduce the risk of an airbag deploying unexpectedly and causing serious injury or death:

- Do not hit or allow any objects to impact the locations where airbags or sensors are installed.
 - Do not perform maintenance on or around the airbag sensors. If the location or angle of the sensors is changed, the airbags may deploy when they should not or may not deploy.
 - Do not install bumper guards with non genuine Hyundai or non-equivalent parts. It may adversely affect the collision and airbag deployment performance.
 - Move the Engine Start/Stop button to the OFF or ACC position and wait for 3 minutes before the vehicle is towed to prevent unintended airbag deployment.
 - Have all airbag repairs conducted by an authorized HYUNDAI dealer.
-

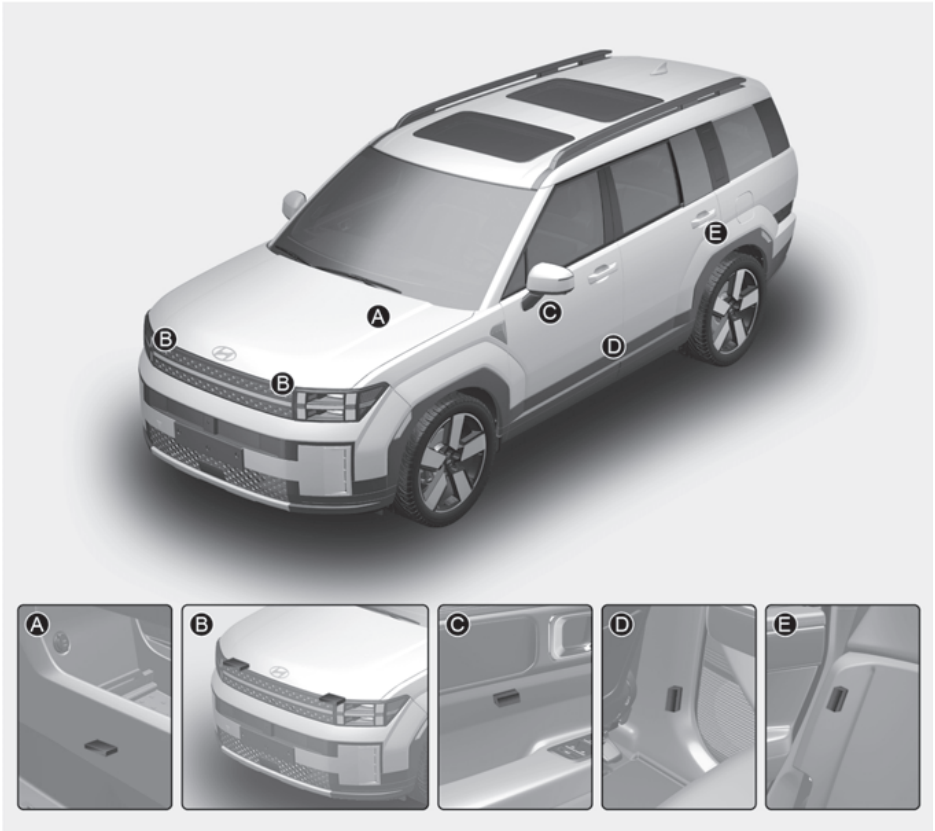

- [A] SRS control module/Rollover sensor
- [B] Front impact sensor
- [C] Side impact sensor (Pressure)
- [D] Side impact sensor (Acceleration): B-pillar
- [E] Side impact sensor (Acceleration): C-pillar

Airbag inflation conditions

Front airbags

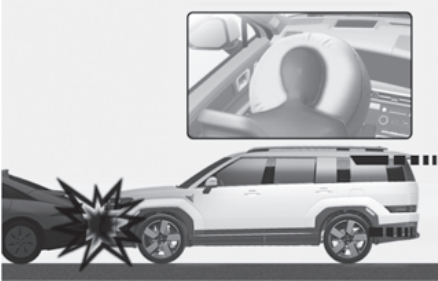

Front airbags are designed to inflate in a frontal collision depending on the severity of impact.

Side and curtain airbags



Side and curtain airbags are designed to inflate when an impact is detected by side collision sensors depending on the severity of impact resulting from a side impact collision.

Although the driver's and front passenger's airbags are designed to inflate in frontal collisions and side and curtain airbags are designed to inflate in side impact collisions, airbags may inflate in other types of collisions if the sensors detect a sufficient impact.

Also, the side and curtain airbags inflate when a rollover is detected by a rollover sensor.

If the vehicle chassis is impacted by bumps or objects on unimproved roads, the airbags may deploy. Drive carefully on unimproved roads or on surfaces not designed for vehicle traffic to prevent unintended airbag deployment.

Airbag non-inflation conditions



In certain low-speed collisions, the airbags may not deploy. The airbags are designed not to deploy in such cases because they may not provide benefits beyond the protection of the seat belts.



Front airbags are not designed to inflate in rear collisions, because occupants are moved backward by the force of the impact.



Front airbags may not inflate in side impact collisions, because occupants move in the direction of the collision.

Side and curtain airbags may inflate depending on the severity of impact.

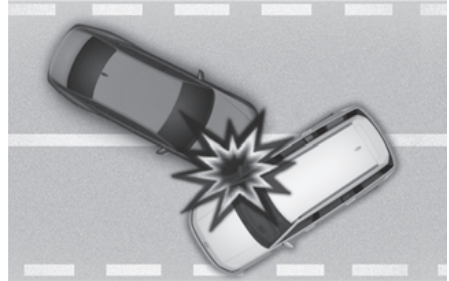

In an angled collision, the force of impact may position the occupants in a direction where the airbags would not be able to provide any additional benefit, and thus the sensors may not deploy any airbags.



Just before impact, drivers often brake heavily. Such heavy braking lowers the front portion of the vehicle causing it to "nosedive". This is particularly important when the vehicle in front has a higher ground clearance. Airbags may not inflate if your vehicle is in a "nosedive" condition because the collision forces detected by the sensors may have been significantly reduced.

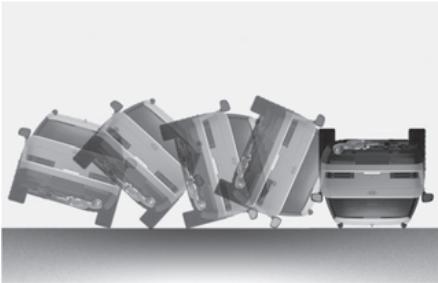

Front airbags may not inflate in rollover crash because front airbag deployment would not provide additional occupant protection.

i Information

The side and curtain airbags may inflate in a rollover situation, when detected by the rollover sensor.



Airbags may not inflate if the vehicle collides with objects such as utility poles or trees, where the point of impact is concentrated and the collision energy is absorbed by the vehicle structure.

SRS Care

The SRS is virtually maintenance-free and there are no parts you can safely service by yourself. If the SRS airbag warning light does not illuminate when the Engine Start/Stop button is in the ON position or continuously remains on, have the system immediately inspected by an authorized HYUNDAI dealer.

Any work on the SRS system, such as removing, installing, repairing, or any work on the steering wheel, the front passenger's panel, front seats, and roof rails should be performed by an authorized HYUNDAI dealer. Improper handling of the SRS system may result in serious personal injury or death.

! WARNING

To reduce the risk of serious injury or death:

- Do not attempt to modify or disconnect the SRS components or wiring, including the addition of any kind of badges to the pad covers or modifications to the body structure.
- Do not place objects over or near the airbag modules on the steering wheel, instrument panel, and the front passenger's panel above the glove box.
- Clean the airbag pad covers with a soft cloth moistened with water. Solvents or cleaners may adversely affect the airbag covers and proper deployment of the system.
- Replace inflated airbags by an authorized HYUNDAI dealer.
- If components of the airbag system must be discarded, or if the vehicle must be scrapped, observe safety precautions. Consult an authorized HYUNDAI dealer for the necessary information.

Additional Safety Precautions

Passengers should not move out of or change seats while the vehicle is moving. A passenger who is not wearing a seat belt during a collision or emergency stop can be thrown against the inside of the vehicle, against other occupants, or be ejected from the vehicle.

Do not use any accessories on seat belts. Devices claiming to improve occupant comfort or reposition the seat belt can reduce the protection provided by the seat belt and increase the chance of serious injury in a collision.

Do not modify the front seats. Modification of the front seats may interfere with the operation of the Supplemental Restraint System sensing components or side airbags.

Do not place items under the front seats. Placing items under the front seats may interfere with the operation of the Supplemental Restraint System sensing components and wiring harnesses.

Do not cause impact to the doors. Impact to the doors when the Engine Start/Stop button is in the ON or START position may cause the airbags to inflate.

Modifications to accommodate disabilities. If you require modification to your vehicle to accommodate a disability, contact the HYUNDAI Customer Connect Center at 800-633-5151.

Adding equipment to or modifying your airbag equipped vehicle

If you modify your vehicle by changing your vehicle's frame, bumper system, front end or side sheet metal, or ride height, this may affect the operation of your vehicle's Supplemental Restraint System.

Airbag Warning Labels



Airbag warning labels, required by the U.S. National Highway Traffic Safety Administration (NHTSA), are attached to alert the driver and passengers of potential risks of the airbag system. Be sure to read all of the information about the airbags that are installed on your vehicle in this Owners Manual.

4. Instrument Cluster

Instrument Cluster.....	4-2
Instrument cluster control.....	4-3
Gauges and meters.....	4-4
Transmission shift indicator.....	4-8
Warning and indicator lights.....	4-9
Cluster display messages.....	4-23
Cluster Display.....	4-31
Cluster display control.....	4-31
View modes.....	4-31
Vehicle Settings (infotainment System).....	4-35
Setting your vehicle.....	4-35

Instrument Cluster

Type A

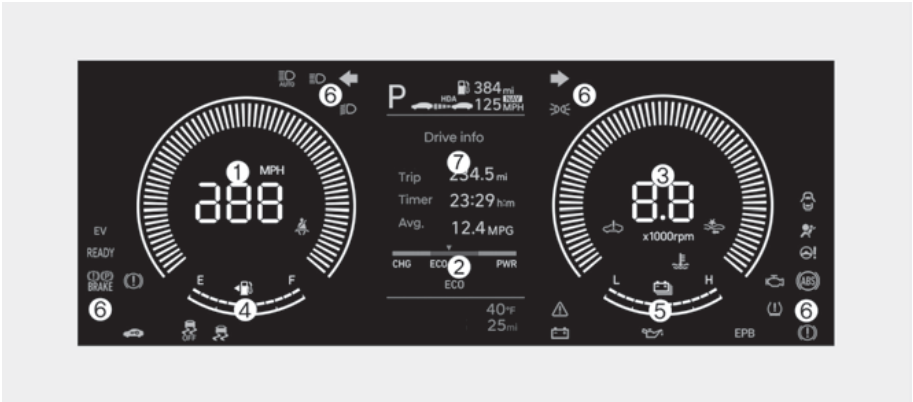

Type B



The actual cluster in the vehicle may differ from the illustration. For more information, refer to the "Gauges and meters" section in this chapter.

- (1) Speedometer
- (2) Hybrid system gauge
- (3) Tachometer
- (4) Fuel gauge
- (5) Hybrid battery SOC (State of Charge) gauge
- (6) Warning and indicator lights
- (7) Cluster display

Instrument cluster control

Instrument panel illumination

Control switch

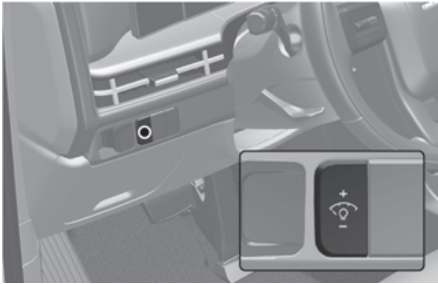

When the vehicle's parking lights or headlights are on, press the illumination control switch to adjust the brightness of the instrument panel illumination.

When pressing the illumination control switch, the interior switch illumination intensity is also adjusted.

WARNING

Never adjust the instrument panel illumination while driving to prevent death, serious injury, or vehicle damage.

- The brightness of the instrument panel illumination is displayed.
- When the brightness setting reaches either the minimum or maximum level, a chime sounds.

Infotainment system

You can adjust the brightness of the instrument panel illumination from the Settings menu in the infotainment system. Select:

- **Setup > Cluster > Illumination**

Information

The infotainment system may change after software updates. For more information, refer to the user's manual provided in the infotainment system and the quick reference guide.

WARNING

Never adjust the instrument cluster while driving. This could result in loss of control and lead to a crash that may cause death, serious injury, or vehicle damage.

Gauges and meters

Speedometer

Type A



Type B



The speedometer indicates the speed of the vehicle and is calibrated in miles per hour (MPH) and/or kilometers per hour (km/h).

Hybrid system gauge

Type A



Type B



The hybrid system gauge indicates whether the current driving condition is fuel efficient or not.

- **CHARGE:** Shows that the energy made by the vehicle is being converted to electrical energy. (Regenerated energy)
- **ECO:** Shows that the vehicle is being driven in an Eco-friendly manner.
- **POWER:** Shows that the vehicle is exceeding the Eco-friendly range.

According to the hybrid system gauge area, the **EV** indicator comes on or off.

- **EV indicator ON:** The vehicle is driven using the electric motor or the gasoline engine is stopped.
- **EV indicator OFF:** The vehicle is driven using the gasoline engine.

Tachometer

Type A



Type B



The tachometer indicates the approximate number of engine revolutions per minute (RPM).

Use the tachometer to select the correct shift points and to help prevent lugging and/or over-revving the engine.

NOTICE

Do not operate the engine within the tachometer's RED ZONE to prevent severe engine damage.

Fuel gauge

Type A



Type B

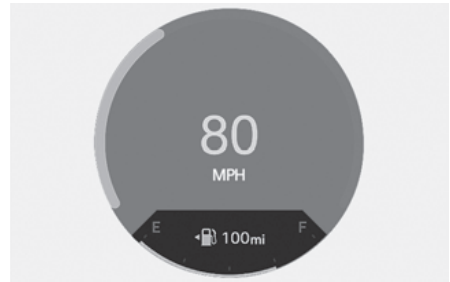

The fuel gauge indicates the approximate amount of fuel remaining in the fuel tank.

i Information

- The fuel tank capacity is given in chapter 10.
- The fuel gauge is supplemented by a low fuel warning light, that illuminates when the fuel tank is nearly empty.
- On inclines or curves, the fuel gauge may fluctuate or the low fuel warning light may come on earlier than usual due to the movement of fuel in the tank.

WARNING

Always refuel the vehicle as soon as possible after the warning light comes on or when the gauge indicator comes close to the E (Empty) level.

NOTICE

Avoid driving with an extremely low fuel level. Running out of fuel may cause the engine to misfire and cause damage to the catalytic converter (if equipped).

Hybrid battery SOC (State of Charge) gauge

Type A



Type B



This gauge indicates the remaining hybrid battery power. If the SOC is near the L (Low) level, the vehicle automatically operates the engine to charge the battery.

However, if the Service Indicator (↶↷) and Malfunction Indicator Lamp (MIL) (⚠) turn on when the SOC gauge is near the L (Low) level, have the vehicle inspected by an authorized HYUNDAI dealer.

Outside temperature gauge

Type A



Type B

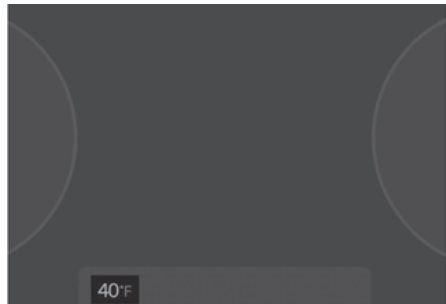

The outside ambient temperature appears in the lower portion of the cluster display. The temperature reads in Fahrenheit or Celsius depending on the units selected from the instrument cluster or infotainment system.

The temperature indicated on the instrument cluster may not change as quickly as the outside temperature. Select:

- **Setup > General > Units > Temperature Unit > °C/°F**

Both the temperature unit on the cluster display and climate control information screen is changed.

i Information

The infotainment system may change after software updates. For more information, refer to the user's manual provided in the infotainment system and the quick reference guide.

Odometer

Type A



Type B

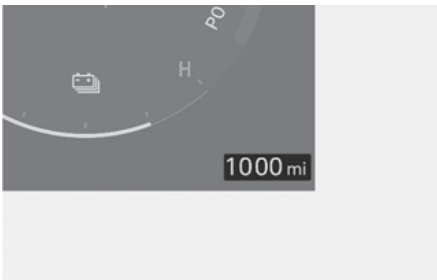

The odometer indicates the total distance that the vehicle has been driven and is used to determine when periodic maintenance is required.

Distance to empty

Type A

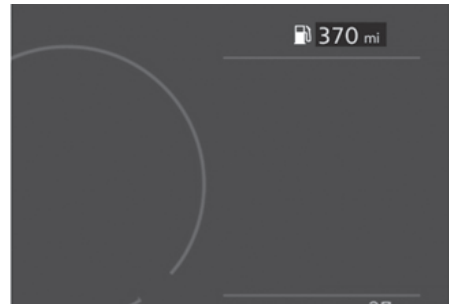

Type B

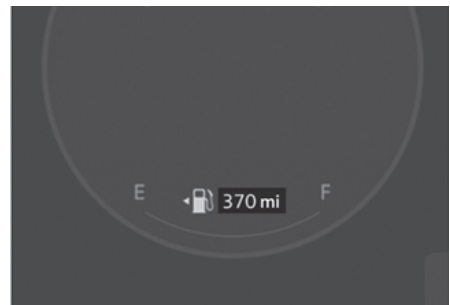

The distance to empty is the estimated distance the vehicle can be driven with the remaining fuel.

If the estimated distance is below 1 mi. (1 km), the trip computer displays '---' as the distance to empty. When this occurs, refuel the vehicle immediately.

- The distance to empty may differ from the actual driving distance because it is only an estimate of the available driving distance.
- The distance to empty may differ significantly based on driving conditions, driving habits, and condition of the vehicle.

- If the vehicle is not on level ground or the battery power has been interrupted, the distance to empty function may not operate correctly until the vehicle has been driven enough for the system to recalculate.
- The distance to empty indicator may not change accurately if less than 1.5 US gal. (6 liters) of fuel are added to the vehicle.

CAUTION

If the shift gear is not 'P' (Park) or 'N' (Neutral) during refueling, the refueling may not be recognized and the fuel amount and distance to empty may be displayed abnormally.

Information

- The distance to empty may differ from the actual driving distance as it is an estimate of the available driving distance.
- The distance to empty may differ significantly based on driving conditions, driving habits, and condition of the vehicle.
- If the remaining battery level is low, the driving distance may appear longer on the instrument cluster than the actual vehicle.

Transmission shift indicator

Automatic transmission shift indicator

Type A

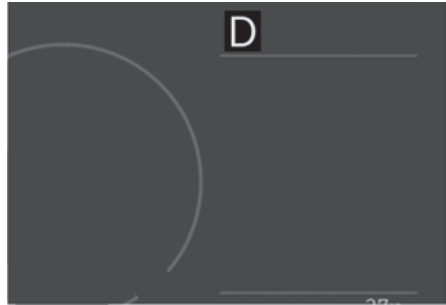

Type B

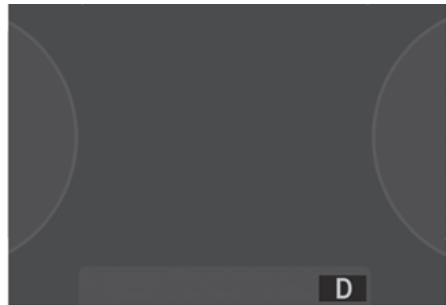

This indicator informs the current gear engaged.

Warning and indicator lights

i Information

Make sure that all warning lights are OFF after starting the engine. If any light is still ON, this indicates a situation that needs attention.

Seat belt warning light



This warning light informs the driver that the seat belt is not fastened.

For more information, refer to the "Seat Belts" section in chapter 3.

Airbag warning light



This warning light illuminates:

- When the Engine Start/Stop button is in the ON position. It illuminates for 3-6 seconds and then goes off.
- When there is a malfunction with the Safety Restraint System (SRS).

If the Airbag warning light remains illuminated while driving, have the vehicle inspected by an authorized HYUNDAI dealer.

Parking brake warning light



This warning light illuminates:

- When the Engine Start/Stop button is in the ON position. It illuminates for about 3 seconds and then goes off once the parking brake is released.
- Whenever the parking brake is applied.
- Whenever the brake fluid level in the reservoir is low.
 - If the warning light illuminates with the parking brake released, it indicates the brake fluid level in the reservoir is low.
 - Whenever the regenerative brake does not operate.

If the brake fluid level in the reservoir is low:

1. Drive carefully to the nearest safe location and stop your vehicle.
2. With the engine stopped, check the brake fluid level immediately and add fluid as required (For more information, refer to the "Brake Fluid" section in chapter 9). After adding brake fluid, check all brake components for fluid leaks. If a brake fluid leak is found, or if the warning light remains on, or if the brakes do not operate properly, do not drive the vehicle. Have the vehicle inspected by an authorized HYUNDAI dealer.

Dual-diagonal braking system

Your vehicle is equipped with the dual-diagonal braking system. This means you still have braking on two wheels even if one of the dual systems should fail.

With only one of the dual systems working, more than normal pedal travel and greater pedal force are required to stop the vehicle.

Also, the vehicle does not stop in a short distance if only a portion of the braking system is working.

If you experience a malfunction with the braking system while driving, attempt to slow your vehicle by coasting or by using engine braking. You may be able to reduce your vehicle speed by manually downshifting to a lower gear. Use Manual Shift Mode using either the gear shift button or the paddle shifters (if equipped) to shift to a lower gear.

WARNING

If the parking brake warning light illuminates with the parking brake released, it indicates that the brake fluid level is low. Have the vehicle inspected by an authorized HYUNDAI dealer.

Regenerative brake warning light



This warning light illuminates:

When the regenerative brake does not operate and the brake does not perform well. This causes the Brake Warning light (red) and Regenerative Brake Warning Light (yellow) to illuminate simultaneously.

If this occurs, have the vehicle inspected by an authorized HYUNDAI dealer. The operation of the brake pedal may be more difficult than normal and the braking distance may increase.

Anti-lock Brake System (ABS) warning light



This warning light illuminates:

- When the Engine Start/Stop button is in the ON position. It illuminates for about 3 seconds and then goes off.
- Whenever there is a malfunction with the ABS.

The hydraulic braking system still operates even if there is a malfunction with the ABS. If the ABS warning light remains illuminated while driving, have the vehicle inspected by an authorized HYUNDAI dealer.

Electronic Brake Force Distribution (EBD) System warning light



These two warning lights illuminate at the same time while driving:

When the ABS and brake system does not work normally.

If both the ABS warning light and the Parking Brake warning light remain illuminated while driving, have the vehicle inspected by an authorized HYUNDAI dealer.

⚠ WARNING

- When both ABS and Parking Brake warning lights are on, the braking system does not work normally and you may experience an unexpected and dangerous situation during sudden braking.
- Avoid high speed driving and abrupt braking.
- Have the vehicle inspected by an authorized HYUNDAI dealer as soon as possible.

i Information

When the ABS warning light is on or both ABS and Parking Brake warning lights are on, the speedometer, odometer, or tripmeter may not work. Also, the MDPS warning light may illuminate and the steering effort may increase or decrease.

Motor Driven Power Steering (MDPS) warning light



This warning light illuminates:

- When the Engine Start/Stop button is in the ON position. It illuminates for about 3 seconds and then goes off.
- Whenever there is a malfunction with the Motor Driven Power Steering.

If the MDPS warning light remains illuminated while driving, have the vehicle inspected by an authorized HYUNDAI dealer.

Low fuel level warning light



This warning light illuminates:

When the fuel tank is nearly empty. Refuel the vehicle as soon as possible.

NOTICE

Driving with the Low Fuel Level warning light on or with the fuel level below E (Empty) may cause the engine to misfire and damage the catalytic converter (if equipped).

Engine oil pressure warning light



This warning light illuminates:

When the engine oil pressure is low.

If the engine oil pressure is low:

1. Drive carefully to the nearest safe location and stop your vehicle.
2. Turn the engine off and check the engine oil level (For more information, refer to the "Engine Oil" in chapter 9). If the level is low, add oil as required.

If the warning light remains on after adding oil or if oil is not available, have your vehicle inspected by an authorized HYUNDAI dealer as soon as possible. Continued driving with the warning light on may cause engine failure.

NOTICE

- Continued driving with the warning light on may cause engine failure.
- If the engine is not stopped immediately after the Engine Oil Pressure warning light is illuminated, severe damage could result.

i Information

When engine oil pressure decreases due to insufficient engine oil, etc., the Engine Oil Pressure warning light illuminates. In addition, the enhanced engine protection system that limits engine power is activated. When the engine oil pressure is restored, the warning light and the enhanced engine protection system will turn off after the engine is restarted.

Malfunction Indicator Lamp (MIL)

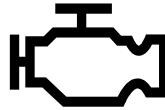

This indicator light illuminates:

- When the Engine Start/Stop button is in the ON position. It illuminates for about 3 seconds and then goes off.
- Whenever there is a malfunction with either the emission control system or the engine or the vehicle powertrain. If the MIL warning light remains illuminated while driving, have the vehicle inspected by an authorized HYUNDAI dealer.
- If the enhanced engine protection system activates due to the lack of engine oil, the engine power is limited.

NOTICE

- Driving with the Malfunction Indicator Lamp (MIL) on may cause damage to the emission control system that may affect drivability and/or fuel economy.
- If the Malfunction Indicator Lamp (MIL) illuminates, catalytic converter (if equipped) damage is possible that may result in loss of engine power.

NOTICE

If the Malfunction Indicator Lamp (MIL) illuminates, potential catalytic converter damage is possible which could result in loss of engine power.

If this occurs, have the vehicle inspected by an authorized HYUNDAI dealer as soon as possible.

Charging system warning light

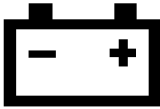

This warning light illuminates:

When there is a malfunction with either the alternator or electrical charging system.

If there is a malfunction with either the alternator or electrical charging system:

1. Drive carefully to the nearest safe location and stop your vehicle.
2. Turn the engine off and check the alternator drive belt for looseness or breakage.

If the belt is adjusted properly, there may be a problem in the electrical charging system.

If the Charging system warning light remains illuminated while driving, have the vehicle inspected by an authorized HYUNDAI dealer.

Low tire pressure warning light



This warning light illuminates:

- When the Engine Start/Stop button is in the ON position. It illuminates for about 3 seconds and then goes off.
- When one or more tires are significantly under-inflated. (The location of the under-inflated tire appears on the cluster display.)

For more information, refer to the "Tire Pressure Monitoring System (TPMS)" section in chapter 8.

This warning light remains ON after blinking for about 60 seconds, or repeatedly blinks ON and OFF at 3 second intervals:

When there is a malfunction with the TPMS.

If this occurs, have the vehicle inspected by an authorized HYUNDAI dealer as soon as possible.

For more information, refer to the "Tire Pressure Monitoring System (TPMS)" section in chapter 8.

WARNING

- The TPMS cannot alert you to severe and sudden tire damage caused by external factors.
- If you notice any vehicle instability, immediately take your foot off the accelerator pedal, apply the brakes gradually with light force, and slowly move to a safe position off the road.

Electronic Parking Brake (EPB) warning light

EPB

This warning light illuminates:

- When the Engine Start/Stop button is in the ON position. It illuminates for about 3 seconds and then goes off.
- Whenever there is a malfunction with EPB.

If the EPB warning light remains illuminated while driving, have the vehicle inspected by an authorized HYUNDAI dealer.

i Information

The Electronic Parking Brake (EPB) warning light may illuminate when the Electronic Stability Control (ESC) indicator light comes on to indicate that ESC is not working properly. This does not indicate malfunction of EPB.

AUTO HOLD indicator light

AUTO HOLD

This indicator light illuminates:

- White: When you activate Auto Hold by pressing the AUTO HOLD switch.
- Green: When you stop the vehicle completely by depressing the brake pedal with Auto Hold activated.
- Yellow: Whenever a malfunction with the Auto Hold is detected.

If the AUTO HOLD indicator light remains yellow while driving, have the vehicle inspected by an authorized HYUNDAI dealer.

For more information, refer to the "Electronic Parking Brake (EPB)" section in chapter 6.

4WD warning light

 if equipped



This indicator light illuminates:

Whenever there is a malfunction with the 4WD system.

If this occurs, have the vehicle inspected by an authorized HYUNDAI dealer as soon as possible.

For more information, refer to "Four Wheel Drive (4WD)" section in chapter 6.

Forward Safety warning light



This warning light illuminates:

- When the Engine Start/Stop button is in the ON position. It illuminates for about 3 seconds and then goes off.
- Yellow: When Forward Safety of Forward Collision-Avoidance Assist is deselected, disabled, or a malfunction is detected.

If the yellow warning light remains on after the sensor has been uncovered or unblocked when the Forward Safety is set, have the vehicle inspected by an authorized HYUNDAI dealer.

This warning light blinks:

Red: When Forward Safety or Forward Cross-Traffic Safety function is operating.

For more information, refer to the "Forward Collision-Avoidance Assist (FCA)" section in chapter 7.

Emergency steering warning light

⁺if equipped



This warning light illuminates:

- When you set the Engine Start/Stop button to the ON position, the yellow warning light illuminates for about 3 seconds and then goes off.
- Continuously Yellow: When Forward/Side Safety is deselected or Forward Collision-Avoidance Assist is disabled or a malfunction is detected.

If the yellow warning light is still on even after removing foreign material from the front of the sensors after Forward Safety select in settings, have the vehicle inspected by an authorized HYUNDAI dealer as soon as possible.

This warning light blinks:

Red: When Forward/Side Safety of Forward Collision-Avoidance Assist is operating.

For more information, refer to the "Forward Collision-Avoidance Assist (FCA)" section in chapter 7.

Lane Safety indicator light



This indicator light illuminates:

- When the Engine Start/Stop button is in the ON position. It illuminates for about 3 seconds and then goes off.
- Grey: When Lane Keeping Assist operating conditions are not satisfied.
- Green: When Lane Keeping Assist operating conditions are satisfied.
- Yellow: When Lane Safety is deselected, disabled, or a malfunction is detected.

If the yellow warning light remains on after the sensor has been uncovered or unblocked when Lane Safety is set, have the vehicle inspected by an authorized HYUNDAI dealer.

This indicator light blinks:

Green: When Lane Keeping Assist is operating.

For more information, refer to the "Lane Keeping Assist (LKA)" section in chapter 7.

Lane Following Assist indicator light



This indicator light illuminates:

- When the Engine Start/Stop button is in the ON position. It illuminates for about 3 seconds and then goes off.
- Green: When Lane Following Assist is operating.
- Grey: When Lane Following Assist operating conditions are not satisfied.

This indicator light blinks:

White: When the steering wheel assist is cancelled.

For more information, refer to the "Lane Following Assist (LFA)" section in chapter 7.

Speed Limiter indicator light



This indicator light illuminates:

When the speed limiter is enabled.

For more information, refer to the "Manual Speed Limit Assist (MSLA)" in chapter 7.

Intelligent Speed Limit Assist indicator light

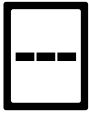

This indicator light illuminates:

- When the Engine Start/Stop button is in the ON position. It illuminates for about 3 seconds and then goes off.
- Yellow: When Intelligent Speed Limit Assist is disabled, the front view camera is blocked, or a malfunction is detected.

If the yellow indicator light remains on after the front view camera has been uncovered or unblocked, have the vehicle inspected by an authorized HYUNDAI dealer.

For more information, refer to the "Intelligent Speed Limit Assist (ISLA)" section in chapter 7.

Inattentive Driving Warning light



This indicator light illuminates:

- When the Engine Start/Stop button is in the ON position. It illuminates for about 3 seconds and then goes off.
- Yellow: When Driver Attention Warning is disabled or a malfunction is detected. If the yellow indicator light remains on after the front view camera has been uncovered or unblocked, have the vehicle inspected by an authorized HYUNDAI dealer.

This indicator light blinks:

Yellow: When the Inattentive Driving Warning is operating.

For more information, refer to the "Driver Attention Warning (DAW)" section in chapter 7.

Service warning light



This warning light illuminates:

- When you set the Engine Start/Stop button to the ON position.
 - The service warning light illuminates for about 3 seconds and then turns off when all checks have been performed.
- When there is a problem with the hybrid vehicle control system or hardware.

When the warning light illuminates while driving, or does not go OFF after starting the vehicle, have the vehicle inspected by an authorized HYUNDAI dealer.

Master warning light



This warning light illuminates:

When there is a malfunction in operation in any of the following systems:

- Forward Collision-Avoidance Assist malfunction
- Forward Collision-Avoidance Assist radar blocked
- Blind-Spot Collision-Avoidance Assist malfunction
- Blind-Spot Collision-Avoidance Assist radar blocked
- Exterior light malfunction
- Rear Cross-Traffic Collision-Avoidance Assist malfunction
- Rear Cross-Traffic Collision-Avoidance Assist radar blocked
- LED headlight malfunction
- High Beam Assist malfunction
- Smart Cruise Control malfunction
- Smart Cruise Control radar blocked
- Lane Following Assist malfunction
- Door/Liftgate malfunction
- Low washer fluid
- Four Wheel Drive (4WD) malfunction (if equipped)
- Tire Pressure Monitoring System (TPMS) malfunction

If the issue is resolved, the Master Warning Light turns off.

LED headlight warning light



This warning light illuminates:

- When the Engine Start/Stop button is in the ON position. It illuminates for about 3 seconds and then goes off.
 - Whenever there is a malfunction with a LED headlight.

If the LED Headlight warning light remains illuminated while driving, have the vehicle inspected by an authorized HYUNDAI dealer.

This warning light blinks:

Whenever there is a malfunction with a LED headlight related part.

If this occurs, have the vehicle inspected by an authorized HYUNDAI dealer as soon as possible.

NOTICE

Driving with the LED Headlight warning light on or blinking may reduce LED headlight life.

Downhill Brake Control (DBC) indicator light



This indicator light illuminates:

- When you set the Engine Start/Stop button to the ON position. It illuminates for about 3 seconds and then goes off.
- Green: When you activate the system by pressing the DBC button.
- Yellow: Whenever a malfunction with the Downhill Brake Control system is detected.

If the yellow indicator light remains on, have the vehicle inspected by an authorized HYUNDAI dealer.

This indicator light blinks:

Green: When Downhill Brake Control system is operating.

For more information, refer to "Downhill Brake Control (DBC)" section in chapter 6.

Ready indicator

READY

This indicator illuminates:

When the vehicle is ready to be driven.

- ON: Normal driving is possible.
- OFF: Normal driving is not possible, or a problem has occurred.

When the **READY** indicator goes off or blinks, there is a problem with the system. If this occurs, have the vehicle inspected by an authorized HYUNDAI dealer.

EV mode indicator

EV

This indicator illuminates:

When the vehicle is driven by the electric motor.

Electronic Stability Control (ESC) indicator light



This indicator light illuminates:

- When the Engine Start/Stop button is in the ON position. It illuminates for about 3 seconds and then goes off.
- Whenever there is a malfunction with ESC system.

If this occurs, have the vehicle inspected by an authorized HYUNDAI dealer as soon as possible.

This indicator light blinks:

While ESC is operating.

For more information, refer to "Electronic Stability Control (ESC)" section in chapter 6.

Electronic Stability Control (ESC) OFF indicator light



This indicator light illuminates:

- When the Engine Start/Stop button is in the ON position. It illuminates for about 3 seconds and then goes off.
- When you deactivate ESC system by pressing the ESC OFF button.

For more information, refer to "Electronic Stability Control (ESC)" section in chapter 6.

Immobilizer indicator light



This indicator light illuminates for up to 30 seconds:

When the vehicle detects the smart key in the vehicle with the Engine Start/Stop button in the ACC or ON position.

- At this time, you can start the engine.
- The indicator light goes off after starting the engine.

This indicator light blinks for a few seconds:

When the smart key is not in the vehicle, you cannot start the engine.

This indicator light illuminates for a few seconds and goes off:

If the smart key is in the vehicle and the Engine Start/Stop button is ON, but the vehicle cannot detect the smart key.

If this occurs, have the vehicle inspected by an authorized HYUNDAI dealer.

This indicator light blinks:

Whenever there is a malfunction with the immobilizer system.

If this occurs, have the vehicle inspected by an authorized HYUNDAI dealer.

Turn signal indicator light



This indicator light blinks:

When you operate the turn signal lever.

If any of the following occur, there may be a malfunction with the turn signal system.

- The turn signal indicator light illuminates but does not blink.
- The turn signal indicator light blinks rapidly.
- The turn signal indicator light does not illuminate at all.

If any of these occur, have the vehicle inspected by an authorized HYUNDAI dealer.

Low beam indicator light



This indicator light illuminates:

When the headlights are on.

High beam indicator light



This indicator light illuminates:

- When the headlights are on and the turn signal lever is moved to the high beam position.
- When the turn signal lever is pulled into the Flash-to-Pass position.

High Beam Assist indicator light



This indicator light illuminates:

When the high beam is on with the light switch in the AUTO position.

- White: When High Beam Assist is ready to operate.
- Green: When High Beam Assist is operating.

If your vehicle detects oncoming or preceding vehicles, High Beam Assist switches the high beam to low beam automatically.

For more information, refer to the "High Beam Assist (HBA)" section in chapter 5.

Exhaust system (GPF) warning light

 If equipped

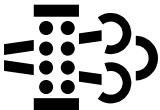

This warning light illuminates:

When accumulated soot reaches a certain amount. It may turn off after driving the vehicle at more than 50 mph (80 km/h) for about 30 minutes (above 3rd gear with 1500-4000 RPM). If this warning light blinks and a cluster message appears, have the GPF system inspected by an authorized HYUNDAI dealer.

NOTICE

If you continue to drive with the GPF warning light blinking for a long time, the GPF system may be damaged and the fuel consumption may increase.

Icy road warning light

 If equipped



This indicator light illuminates:

To warn the driver the road may be icy.

When the outside temperature on the temperature gauge is below 40 °F (4 °C), a single chime sounds, both the outside temperature gauge and Icy Road Warning indicator blink several times, and then they remain illuminated.

You can activate or deactivate the Icy Road Warning function from the Settings menu in the infotainment system. Select:

- **Setup > Cluster > Content Selection**

Information

- If the Icy Road warning light appears while driving, avoid speeding, rapid acceleration, sudden braking, or sharp turning.
- The infotainment system may change after software updates. For more information, refer to the user's manual provided in the infotainment system and the quick reference guide.

Light ON indicator light



This indicator light illuminates:
When the parking lights or headlights are on.

Door open indicator light



This indicator light illuminates:
When any door or the liftgate is left open.

WARNING

Before driving the vehicle, confirm the doors and liftgate are fully closed.

Cluster display messages

Vehicle is On

This message appears if you open the driver's door when the gear is in P (Park) and the Engine Start/Stop button in the ON or START position.

Turn the engine off before leaving the vehicle.

Shift to P

This message appears if the Engine Start/Stop button is pressed to the OFF position without the gear in the P (Park) position.

If this occurs, the Engine Start/Stop button goes to the ACC position.

Vehicle is in N. Press START button, shift to P and turn vehicle Off

This message appears if you try to turn off the vehicle with the gear in N (Neutral).

To turn off the vehicle:

1. Press the Engine Start/Stop button. The Engine Start/Stop button moves to the ON position.
2. Shift the gear to P (Park).
3. Press the Engine Start/Stop button again, then the vehicle turns off.

Low key battery

When the Engine Start/Stop button is pressed to the OFF position, a message may appear, indicating the internal battery of the smart key is low. Replace the smart key battery.

Press brake pedal to start engine

This message appears if the Engine Start/Stop button is pressed repeatedly without depressing the brake pedal.

Start the vehicle by depressing the brake pedal and then pressing the Engine Start/Stop button.

Key not in vehicle

This message appears if the smart key is not in the vehicle when you have left the vehicle with the Engine Start/Stop button in the ON or Start position.

Always turn off the engine before leaving your vehicle.

Press START button again

If you cannot start the vehicle after the Engine Start/Stop button is pressed, attempt to start the engine by pressing the Engine Start/Stop button again.

If the warning message appears each time you press the Engine Start/Stop button, have the vehicle inspected by an authorized HYUNDAI dealer.

Press START button with key

This message appears if the smart key is not detected when you press the Engine Start/Stop button after accessing with the smart key.

Check BRAKE SWITCH fuse

This message appears if the brake switch fuse is disconnected. Replace the fuse before starting the engine.

If that is not possible, start the engine by pressing the Engine Start/Stop button for 10 seconds in the ACC position.

Shift to P or N to start engine

This message appears if you try to start the engine in any other position except P (Park) or N (Neutral).

***i* Information**

You can start the engine with the gear in N (Neutral). But, for your safety, always start the engine with the vehicle in P (Park) with your foot depressing the brake pedal.

Battery discharging due to external electrical devices

 if equipped

This message appears if the vehicle battery voltage is low or if a current draw is detected that could drain the vehicle battery.

Do not connect any external electronic devices to the battery system or battery discharge may occur.

If this message appears on the cluster and there are no other external electronic devices connected to the vehicle, have the vehicle inspected by an authorized HYUNDAI dealer.

Door, Hood, Liftgate open indicator



This warning appears if any door or hood or liftgate is left open. The warning indicates which door is open on the cluster display.

CAUTION

Before driving the vehicle, confirm the door, hood, and liftgate are fully closed.

Sunroof open indicator

 if equipped



This warning appears if you turn off the engine when the sunroof is open.

Close the sunroof securely before leaving your vehicle.

Low tire pressure

Type A



Type B



This warning message appears if the tire pressure is low. The corresponding tire on the vehicle is illuminated.

For more information, refer to the "Tire Pressure Monitoring System (TPMS)" section in chapter 8.

Lights

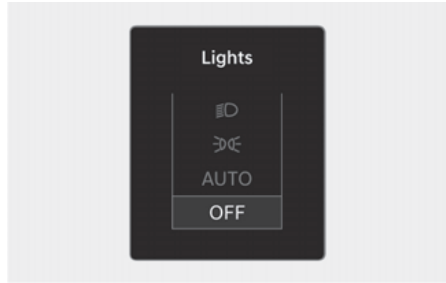

This indicator displays which exterior light is selected using the lighting control.

You can activate or deactivate Wiper/Lights display function from the Settings menu in the infotainment system. Select:

- **Setup > Cluster > Content Selection**

Wiper

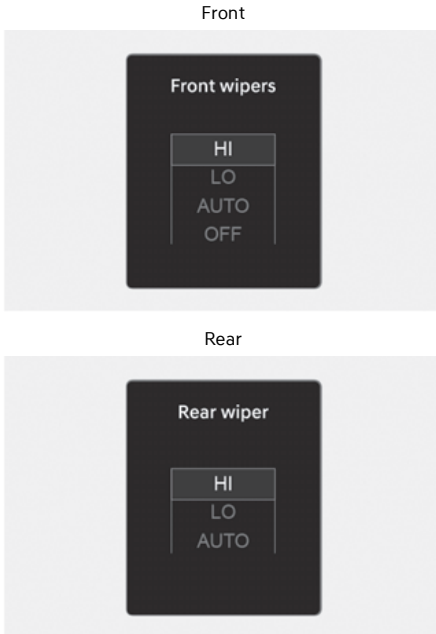

This indicator displays which wiper speed is selected using the wiper control.

You can activate or deactivate Wiper/Lights display function from the Settings menu in the infotainment system. Select:

- **Setup > Cluster > Content Selection**

i Information

The infotainment system may change after software updates. For more information, refer to the user's manual provided in the infotainment system and the quick reference guide.

Low washer fluid

This message appears if the washer fluid level in the reservoir is nearly empty.

Have the washer fluid reservoir refilled.

Low fuel

This message appears if the fuel tank is almost out of fuel.

When this message appears, the low fuel level warning light on the cluster comes on.

Refuel as soon as possible.

Engine overheated

This message appears when the engine coolant temperature is above about 248 °F (120 °C). The engine is overheated and may be damaged.

If your vehicle is overheated, refer to the "If The Engine Overheats" section in chapter 8.

Check headlight

This message appears if the headlights are not operation properly. Replace the burned out bulb with a new one with the same wattage rating.

Check turn signal

This message appears if the turn signal lights are not operating properly.

Replace the burned out bulb with a new one with the same wattage rating.

Check headlight LED

This message appears if there is a problem with the LED headlight. Have the vehicle inspected by an authorized HYUNDAI dealer.

Check Active Air Flap system

This warning message appears in the following situations:

- There is a malfunction with the actuator flap.
- There is a malfunction with the actuator air flap controller.
- The air flap does not open.

When all of the above conditions are fixed, the warning disappears.

Check regenerative brakes

This message appears when the brake performance is low or the regenerative brake does not work properly due to a failure in the brake system.

If this occurs, it may take longer for the brake pedal to operate and the braking distance may become longer.

Stop vehicle and check regenerative brakes

This message appears when a failure occurs in the brake system.

If this occurs, park the vehicle in a safe location and tow your vehicle to the nearest authorized HYUNDAI dealer and have the vehicle inspected.

Check Hybrid system

This message appears when there is a problem with the hybrid system. Refrain from driving when the warning message appears.

If this occurs, have the vehicle inspected by an authorized HYUNDAI dealer.

Check Hybrid system. Stop safely.

This message appears when there is a problem with the hybrid system. The **READY** indicator will blink and a warning chime will sound until the problem is solved. Refrain from driving when the warning message appears.

If this occurs, have the vehicle inspected by an authorized HYUNDAI dealer.

Check Hybrid system. Do not start engine

This message appears when the hybrid battery power (SOC) level is low. A warning chime will sound until the problem is solved. Refrain from driving when the warning message appears.

If this occurs, have the vehicle inspected by an authorized HYUNDAI dealer.

Check Virtual Engine Sound System

This message appears when there is a problem with the Virtual Engine Sound System (VESS).

In this case, have the vehicle inspected by an authorized HYUNDAI dealer.

Check battery

 if equipped

This warning message appears to protect battery and electric vehicle system when an abnormality such as high temperature or overcharge is detected in the 12 V battery.

In this case, have the vehicle inspected by an authorized HYUNDAI dealer.

Authenticated. The vehicle can now be started

 if equipped

This message is displayed for 4 seconds when you place your finger on the fingerprint sensor, and it is verified while the engine is off.

You can start the vehicle by depressing the brake pedal and then pressing the Engine Start/Stop button. However, the engine starts when the Engine Start/ Stop button is pressed within 30 seconds after your fingerprint is verified and the immobilizer () indicator light is illuminated. If the immobilizer indicator light is off, your fingerprint must be verified again.

Fingerprint authentication is locked out. Try again in XX min.

 if equipped

This message is displayed for 4 seconds when fingerprint authentication has failed more than five times while the engine is off. While the message is displayed, fingerprint authentication does not work even if you place your finger on the fingerprint sensor, and the engine does not start even if the Engine Start/Stop button is pressed.

Try again after the time indicated in the message has passed. However, you may start the engine with the smart key or digital key.

If fingerprint authentication still does not work, refer to "Limitations of fingerprint authentication system" section in the chapter 5.

Place digital key on the wireless charger to keep the vehicle running

 if equipped

If the vehicle is remotely started and **Start Vehicle** is deselected from the Settings menu in the infotainment system for **Driver 1** and **Driver 2**, this message will be displayed for up to 30 seconds when a door is opened after unlocking the doors with a digital key.

To drive your vehicle, place the registered digital key on the wireless charger, when this message appears.

Scan an authorized fingerprint to keep the vehicle running

 if equipped

If the vehicle is remotely started and **Start Vehicle** is selected from the Settings menu in the infotainment system for **Driver 1** or **Driver 2**, this message will be displayed for up to 30 seconds when a door is opened after unlocking the doors with a digital key or the Blue Link app.

To drive your vehicle, have an authorized fingerprint verified on the fingerprint sensor when this message appears.

Place digital key on the wireless charger or scan an authorized fingerprint

 if equipped

If the vehicle is remotely started and **Start Vehicle** is selected from the Settings menu in the infotainment system for **Driver 1** or **Driver 2**, this message will be displayed for up to 30 seconds when a door is opened after unlocking the doors with a digital key or the Blue Link app.

To drive your vehicle, place the registered digital key on the wireless charger, or have your fingerprint verified on the fingerprint sensor when this message appears.

Vehicle is On (started by fingerprint)

 if equipped

This message is displayed for up to 10 seconds if the driver's door is opened without the driver's seat belt fastened after turning on the engine with a fingerprint. After the message is displayed, a warning sounds when the door is closed.

***i* Information**

Since the engine was started with a fingerprint, if the engine is turned off, and there is no smart key, digital key or a registered fingerprint in the vehicle, it may be difficult to start the engine again.

Verify digital key or a fingerprint, then press the START button

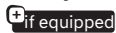
 if equipped

This message is displayed for 6 seconds and the immobilizer () indicator light will blink for 10 seconds after the message "**Press START button with key**" is displayed for 4 seconds if the smart key is not in the vehicle or not detected, the digital key is not placed on the wireless charger, or your fingerprint is not verified when you press the Engine Start/Stop button.

To start the vehicle, place a registered digital key on the wireless charger or have an authorized fingerprint verified on the fingerprint sensor, and then press the Engine Start/Stop button.

Biometric authentication active

 if equipped

This message is displayed for 4 seconds when the Engine Start/Stop button is placed to the ON or START position with the fingerprint registered, and **Start Vehicle** selected from the Settings menu in the infotainment system.

Check user authentication system



 if equipped

This message is displayed if there is a problem with the Digital Key or Fingerprint Authentication System. Have the system inspected by an authorized retailer of HYUNDAI dealer.

Cluster Display

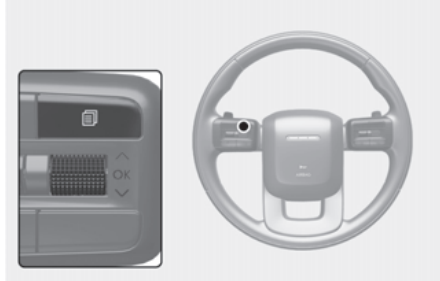
Cluster display control



Switch	Function
	MODE button for changing modes
	MOVE switch for changing items
OK	SELECT/RESET button for setting or resetting the selected item

View modes

View modes	Explanation
Driving Assist	This mode displays Driver Assistance system such as Lane Keeping Assist, Smart Cruise Control, and Lane Following Assist etc.
Turn by Turn	This mode displays the navigation guidance.
Utility	This mode displays driving information such as the trip distance, fuel economy and etc.

The information provided may differ depending on which functions are applicable to your vehicle.

Driving Assist mode



LKA/SCC/LFA/HDA

Displays the state of Lane Keeping Assist, Smart Cruise Control, Lane Following Assist and Highway Driving Assist (if equipped). For more information, refer to each system information in chapter 7.

Turn by Turn (TBT) mode



Turn-by-turn navigation and distance/time to destination appear when Turn by Turn mode is selected.

Utility view

Current Trip

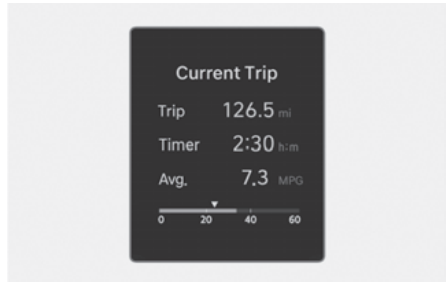

The trip computer mode displays information related to vehicle driving parameters including fuel economy, tripmeter information, and vehicle speed.

Since Refueling

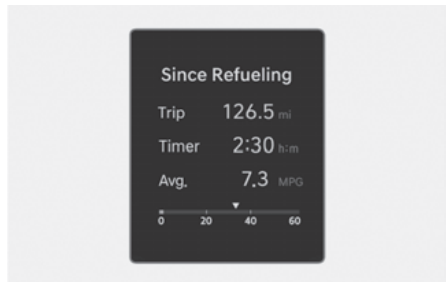

After the vehicle has been refueled, the trip distance, total driving time and average fuel economy appear.

To reset manually, press the **OK** button on the steering wheel for more than 1 second when "**Since Refueling**" appears.

Since Last Reset

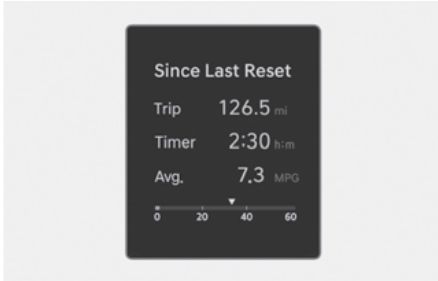

Accumulated trip distance, total driving time, and average fuel economy appear. The information is accumulated starting from the last reset.

To reset manually, press the **OK** button on the steering wheel for more than 1 second when "**Since Last Reset**" appears.

Tire pressure



The tire pressure of each tire appears. For more information, refer to the "Tire Pressure Monitoring System (TPMS)" section in chapter 8.

Driving force distribution (4WD)

 if equipped

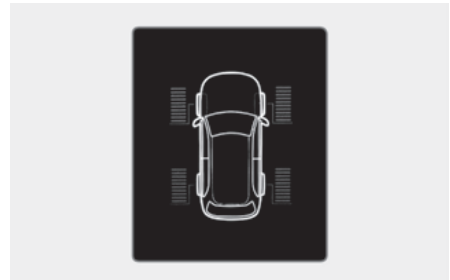

Information related to 4WD driving force appears.

If the vehicle is in 4WD lock state, this mode is not displayed.

For more information, refer to the "Four Wheel Drive (4WD)" section in the chapter 6.

Additional information display

Driver Assistance



The current operation condition of Manual Speed Limit Assist, Smart Cruise Control, Lane Following Assist, etc. appears.

Master warning mode

Master warning light illuminates if one or more of the following occurs:

- Forward Collision-Avoidance Assist malfunction
- Forward Collision-Avoidance Assist radar blocked
- Blind-Spot Collision-Avoidance Assist malfunction
- Blind-Spot Collision-Avoidance Assist radar blocked
- Rear Cross-Traffic Collision-Avoidance Assist malfunction
- Rear Cross-Traffic Collision-Avoidance Assist radar blocked
- Exterior light malfunction
- LED headlight malfunction
- High Beam Assist malfunction
- Smart Cruise Control malfunction
- Smart Cruise Control radar blocked
- Lane Following Assist malfunction
- Door/Liftgate malfunction
- Low washer fluid
- Tire Pressure Monitoring System (TPMS) malfunction

Vehicle Settings (infotainment System)

Vehicle Settings in the infotainment system provides user options for a the settings including door lock/unlock features, convenience features, driver assistance settings, etc.

Vehicle Settings menu

- Driver Assistance
- Drive Mode
- ECO Vehicle
- Climate
- Seat
- Lights
- Door
- Digital Keys
- Convenience

The information provided may differ depending on which functions are available to your vehicle.

WARNING

Do not adjust the Vehicle Settings while driving. You may be distracted from the driving task and could crash.

Setting your vehicle

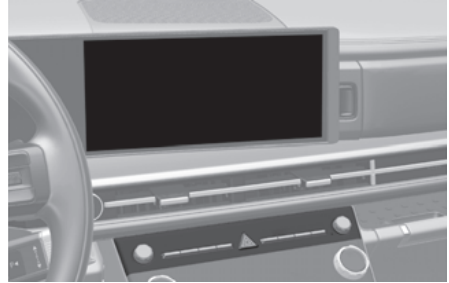

1. Press the **SETUP** button on the main keyboard.
2. Select **Vehicle** to change the settings for features.

Information

The infotainment system may change after software updates. For more information, refer to the user's manual provided in the infotainment system and the quick reference guide.

5. Convenience Features

Accessing Your Vehicle	5-6
Smart key	5-6
Immobilizer system.....	5-13
Hyundai Digital Key	5-14
Digital key (smartphone).....	5-14
Digital key (Card key).....	5-22
Used vehicle/Digital key maintenance.....	5-26
Limitations of the system	5-27
Fingerprint authentication system.....	5-28
Fingerprint authentication system settings.....	5-28
Fingerprint authentication system operation	5-30
Limitations of fingerprint authentication system.....	5-31
When purchasing a used vehicle	5-32
Remotely starting the vehicle	5-32
Door Locks	5-33
Operating door locks from outside the vehicle	5-33
Operating door unlocks from inside the vehicle	5-35
Auto door lock/unlock features	5-36
Electronic child safety lock	5-37
Theft-alarm System.....	5-38
Rear Occupant Alert (ROA)	5-40
Advanced Rear Occupant Alert (ROA)	5-41
Advanced rear occupant alert settings	5-41
Advanced rear occupant alert operation	5-41
Advanced rear occupant alert precautions.....	5-42
Declaration of conformity	5-43
Integrated memory system	5-45
Storing memory positions	5-45
Recalling memory positions.....	5-45
Resetting the integrated memory system	5-46
While resetting integrated memory system	5-46
Seat easy access operation.....	5-46

Steering wheel	5-47
Motor Driven Power Steering (MDPS)	5-47
Tilt/telescopic steering	5-47
Steering wheel heater	5-48
Horn.....	5-49
Steering wheel grip sensor	5-50
Haptic warning/Steering wheel vibration warning.....	5-50
Mirrors.....	5-51
Inside rearview mirror	5-51
Side view mirrors.....	5-67
Reverse parking aid.....	5-70
Windows	5-71
Power windows	5-72
Sunroof	5-75
Sunshade	5-75
Tilt open/close	5-76
Slide open/close.....	5-76
Automatic reversal	5-77
Resetting the sunroof.....	5-78
Sunroof open warning	5-79
Dual wide sunroof.....	5-79
Sunshade (Front)/Power sunshade (Rear)	5-80
Tilt open/close (Front)	5-81
Slide open/close (Front)	5-81
Automatic reversal	5-82
Resetting the sunroof.....	5-83
Sunroof open warning	5-83
Hood	5-84
Opening the hood.....	5-84
Closing the hood	5-84
Power Liftgate.....	5-85
Power liftgate operating conditions	5-85
Operating the power liftgate	5-87
Automatic reversal	5-88
Setting the power liftgate.....	5-89
Resetting the power liftgate.....	5-90

5. Convenience Features

Emergency liftgate safety release	5-90
Smart Liftgate	5-91
Using smart liftgate	5-91
Deactivating smart liftgate.....	5-92
Detecting area.....	5-93
Fuel Filler Door.....	5-94
Opening the fuel filler door	5-94
Closing the fuel filler door	5-95
Head-up display (HUD)	5-96
Head-up display settings	5-96
Head-up display information.....	5-97
Precautions while using the head-up display	5-97
Vehicle system OTA update.....	5-98
Downloading software	5-98
Approving software update	5-98
Preparing software update.....	5-98
Updating software	5-99
Exterior Lights.....	5-100
Lighting control.....	5-100
High beam operation.....	5-102
Turn signals and lane change signals	5-102
Battery saver function	5-103
Headlight delay function	5-103
Daytime Running Lights (DRL).....	5-103
Reverse guide light	5-104
Welcome system.....	5-104
High Beam Assist (HBA).....	5-106
High Beam Assist settings.....	5-106
High Beam Assist operation.....	5-107
High Beam Assist malfunction and limitations.....	5-108
Interior Lights.....	5-109
Interior lights auto off.....	5-109
Front lights	5-109
Rear personal lamps	5-110
Vanity mirror lamp	5-110
Glove box lamp	5-110

Two-way multi console lamp	5-111
Interior button lights	5-111
Mood lighting.....	5-112
Cargo area lamp	5-112
Wipers And Washers.....	5-113
Front windshield wipers.....	5-113
Front windshield washers.....	5-115
Rear window wipers and washers.....	5-116
Automatic Climate Control System	5-117
Automatic heating and air conditioning	5-119
Manual heating and air conditioning	5-120
System operation	5-127
System maintenance	5-128
Windshield Defrosting And Defogging.....	5-130
Automatic climate control system	5-130
Rear window defroster.....	5-131
Climate Control Additional Features	5-132
Air conditioning auto-drying	5-132
Auto defogging system.....	5-133
Auto dehumidify	5-134
Recirculating air when washer fluid is used	5-135
Recirculating air when entering a tunnel	5-135
Scheduled ventilation control	5-136
Storage Compartment.....	5-137
Two-way multi console.....	5-137
Glove box	5-138
Passenger seat multi tray.....	5-138
Passenger seat open tray.....	5-138
Front tray.....	5-138
Sliding tray	5-139
Cargo tray	5-139
Interior Features.....	5-140
Cup holder	5-140
UV-C sterilizer system.....	5-141
Sunvisor.....	5-143
Power outlet	5-143

5. Convenience Features

USB charger.....	5-144
Wireless smartphone charging system	5-146
AC Inverter.....	5-148
Clock	5-149
Coat hook	5-149
Plastic bag hook.....	5-149
Floor mat anchor(s).....	5-150
Rear side sunshade	5-150
Cargo net holder	5-151
Cargo security screen.....	5-151
Exterior Features	5-152
Roof side rails.....	5-152
Hidden type assist handle.....	5-153
Infotainment System.....	5-154
USB port.....	5-154
Antenna	5-155
Steering wheel remote controls	5-156
Infotainment System	5-156
Bluetooth® wireless technology	5-157
Voice Recognition.....	5-157

Accessing Your Vehicle

Smart key

Your HYUNDAI may be equipped with a smart key that can be used to lock or unlock the doors liftgate, and start the engine.

Type A

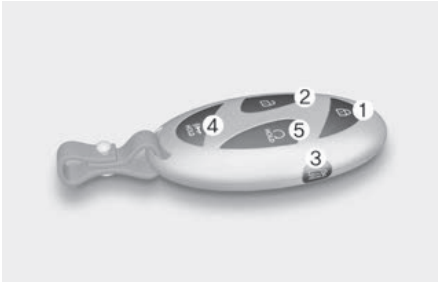

Type B

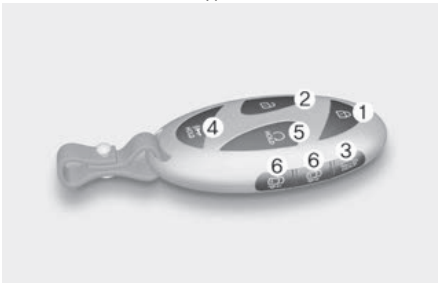

- (1) Door lock
- (2) Door unlock
- (3) Liftgate open/close
- (4) Panic
- (5) Remote start
- (6) Remote Smart Parking Assist
(Forward/Backward)

Locking your vehicle (1)

Button type



To lock:

1. Close all doors.
2. Have the smart key with you.
3. Press the door handle button or press the Door Lock button (1) on the smart key. The chime sounds and hazard warning lights blink. Also, the side view mirrors fold if **On door unlock** or **On driver approach** is selected from the Settings menu in the infotainment system.

Touch sensor type

 if equipped



To lock:

1. Close all doors, hood, and liftgate.
2. Have the smart key with you.
3. Touch the outer part of the door handle on or near the handle detent for about 1 second or until you hear the door locks actuate. The chime sounds and hazard warning lights blink. Also, the side view mirrors fold if **On door unlock** or **On driver approach** is selected from the Settings menu in the infotainment system.

i Information

- The door handle button or touch sensor only operates when the smart key is within 40 in. (1 m) from the outside door handle.
- If you lock the door with the touch sensor, the doors cannot be unlocked with the touch sensor within 3 seconds.
- If you lock the doors using the door handle button or touch sensor, the doors are not locked under the following circumstances:
 - The smart key is in the vehicle.
 - The Engine Start/Stop button is in the ACC or ON position.
 - Any door is open (except for the liftgate).

If this occurs, a chime sounds for about 3 seconds. Check the vehicle before attempting to lock the vehicle again.

i Information

Before you leave your vehicle with the smart key, verify that your vehicle is locked. When using the touch sensor on the front door handle, listen to hear that the lock has actuated, and then pull the handle within 3 seconds to confirm the doors are locked.

(If it has been longer than 3 seconds, verify the doors are locked by pressing the lock button on the smart key. You can hear a single beep.)

WARNING

Do not leave the smart key in your vehicle with children that are unattended or unsupervised.

Children could unintentionally press the Engine Start/Stop button or could operate the power windows or other vehicle controls or even cause the vehicle to move. This may result in serious injury or death.

Unlocking your vehicle (2)

Button type



To unlock:

1. Have the smart key with you.
2. Press the door handle button or press the Door Lock button (2) on the smart key. The chime sounds and hazard warning lights blink two times. Also, the side view mirrors unfold if **On door unlock** or **On driver approach** is selected from the Settings menu in the infotainment system.

- If you unlock the doors using the passenger side door handle, all the doors are unlocked. If you unlock the doors using the driver side door handle, either the driver's side door is unlocked or all the doors are unlocked depending on the setting for the Two Press Unlock feature. Change the Driver Door unlock mode by referring to "Setting the Two Press Unlock feature".

Touch sensor type

+ if equipped

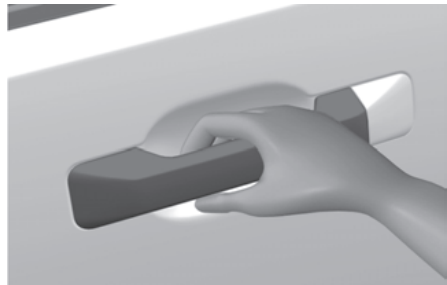

To unlock:

1. Have the smart key with you.
 2. Grab the door handle to activate the door unlock touch sensor. The chime sounds and hazard warning lights blink two times. Also, the side view mirrors unfold if **On door unlock** or **On driver approach** is selected from the Settings menu in the infotainment system.
- If you unlock the doors using the passenger side door handle, all the doors are unlocked. If you unlock the doors using the driver side door handle, either the driver's side door is unlocked or all the doors are unlocked depending on the setting for the Two Press Unlock feature. Change the Driver Door unlock mode by referring to "Setting the Two Press Unlock feature".

i Information

- The door handle button or touch sensor only operates when the smart key is within 40 in. (1 m) from the outside door handle.
 - After unlocking the doors, the doors are locked automatically after 30 seconds unless a door is opened.
-

Setting the Two Press Unlock feature

You can activate or deactivate the Two Press Unlock feature from the Settings menu in the infotainment system. Select:

- **Setup > Vehicle > Door > 2 Press Unlock**

i Information

The infotainment system may change after software updates. For more information, refer to the user's manual provided in the infotainment system and the quick reference guide.

Setting the door lock/unlock prevention feature

The doors may lock or unlock if the touch sensor of the outside door handle is recognized while washing your vehicle or due to heavy rain.

To prevent unintentional door lock or unlock:

Press the lock button and unlock button simultaneously for 4 seconds. The hazard warning lights blink four times. At this time, the doors do not lock or unlock even though the touch sensor is touched on the outside door handle.

To deactivate the function, press the door lock or unlock button on the smart key.

i Information

During a car wash or rain, in order to minimize unintentional operation of the touch sensor, the touch sensor may become insensitive. This is not a malfunction.

Opening the liftgate (3)

To open the liftgate:

1. Have the smart key with you.
2. Press the liftgate open button on the vehicle or press and hold the Liftgate open/close button (3) on the smart key for more than 1 second. The hazard warning lights blink two times and the liftgate open.

To close the liftgate:

Press and hold the Liftgate open/close button (3) on the smart key to close the opened liftgate. If you release the button while the liftgate is being closed, it stops working and the chime sounds for about 5 seconds.

***i* Information**

The Liftgate open/close button only operates when the smart key is within 40 in. (1 m) from the liftgate.

Using panic alarm (4)

The horn sounds and the hazard warning lights blink for about 30 seconds if this button (4) is pressed for more than 1 second. To stop the horn and lights, press any button on the smart key.

Remotely starting the vehicle (5)

To start the vehicle remotely:

1. Press the door lock button on the smart key. You must be within about 32 ft. (10 m) from the vehicle.



2. Press the Remote Start button (5) for more than 2 seconds on the smart key within 4 seconds from when you have pressed the door lock button. The hazard warning flasher blink and the engine starts.
3. To turn off the engine, press the Remote Start button (5) once.

***i* Information**

- The vehicle must be in P (Park) for the remote start function to start.
- The vehicle displays "**Smart Key must be present to keep the vehicle running**" if you get on the vehicle without a registered smart key.
- The engine turns off if you get inside the vehicle without a registered smart key.
- The engine turns off if you do not get on the vehicle within 10 minutes after remotely starting the vehicle.
- The Remote Start button may not operate if the smart key is not within 32 ft. (10 m) from the vehicle.
- The vehicle does not remotely start if the hood or liftgate is open.

- Do not idle the engine for a long time.
- The vehicle can also be remotely started through the Bluelink subscription. For more information, refer to the Bluelink manual.

Remotely moving vehicle forward or backward (6)

+ if equipped

Some models are equipped with the Remote Smart Parking Assist feature. With the smart key, the vehicle can be moved forward or backward remotely to enter or exit a tight parking space.

For more information, refer to the "Remote Smart Parking Assist (RSPA)" section in chapter 7.

Starting the vehicle

Some models are equipped with a Engine Start/Stop button instead of a key cylinder. You can leave your smart key in your pocket or purse when you start your vehicle.

For more information, refer to the "Engine Start/Stop Button" section in chapter 6.

i Information

If the smart key is not moved for some time, the detection function for smart key operation will pause. Lift the smart key to activate the detection again.

NOTICE

To prevent damaging the smart key:

- Keep the smart key in a cool, dry place to avoid damage or malfunction. Exposure to moisture or high temperature may cause the internal circuit of the smart key to malfunction. This may not be covered under warranty.

- Avoid dropping or throwing the smart key.
- Protect the smart key from extreme temperatures.

Mechanical key

If the smart key does not operate normally, you can lock or unlock the driver's door by using the mechanical key.

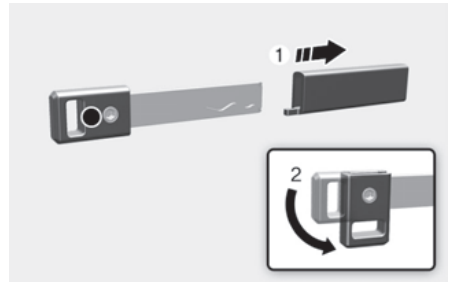

Turn the knob (2) of the mechanical key after removing the key protector (1).

After using the mechanical key, turn the key knob (2) and insert the key protector (1).

Key cylinder (Driver door)

A key cylinder is located on the driver side door handle hidden behind a plastic cover. Using the mechanical key, push and hold the key cylinder cover release button located on the underside of the door handle.

Use the mechanical key inserted into the release button slot to open the cover outward. Once the cover is off, the mechanical key can be inserted into the key cylinder to lock or unlock the vehicle.

To reinstall the mechanical key into the smart key, put the key into the key hole and push inward until a click sound is heard.

Loss of a smart key

A maximum of two smart keys can be registered to a single vehicle. If you happen to lose your smart key, immediately take the vehicle and remaining key to your authorized HYUNDAI dealer or tow the vehicle, if necessary.

Smart key precautions

The smart key may not work if any of the following occur:

- The smart key is close to a radio transmitter such as radio station or airport that may interfere with normal operation of the transmitter.
- The smart key is near a mobile two way radio system or a mobile phone.
- Another vehicle's smart key is being operated close to your vehicle.
- The smart key is near any normal electronic devices or credit cards.
- The vehicle battery is discharged.
- Connecting an external device to the power outlet and placing the smart key near the external device.
- If your windows are tinted, especially with metallic window tint, it may cause frequency interference, reducing the smart key operating range.

If the smart key does not work correctly, open and close the door with the mechanical key.

To start the engine, press the Engine Start/Stop button directly with the smart key. If you have a problem with the smart key, contact an authorized HYUNDAI dealer.



If the smart key is in close proximity to your mobile phone, the signal could be blocked by your mobile phone's operational signals. This is specifically relevant when the phone is active such as making and receiving calls, text messaging, and/or sending/receiving emails. If possible, avoid keeping the smart key and your mobile phone in the same location such as pants or jacket pocket to avoid interference between the two devices.

NOTICE

- Keep the smart key away from electromagnetic materials that may block electromagnetic waves to the key surface.
 - Always have the smart key with you when leaving the vehicle. If the smart key is left near the vehicle, the vehicle battery may be discharged.
-

Replacing the battery

Battery type: CR2450

To replace the battery:

1. Insert a slim tool into the slot (1) and gently open the rear cover.

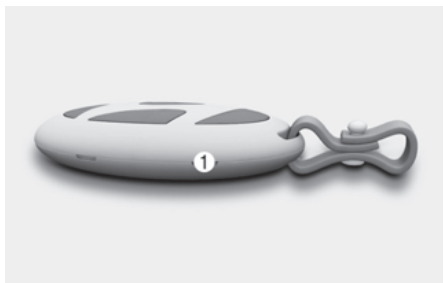

2. Remove the old battery and insert a new battery. Make sure the battery position is correct. An improperly positioned battery may discharge the battery, causing smart key failure.



3. Reinstall the rear cover of the smart key.

If you suspect your smart key might have sustained some damage or you feel your smart key is not working correctly, contact an authorized HYUNDAI dealer.

WARNING

This product contains a button battery.

If swallowed, a lithium button battery can cause severe or fatal injuries within 2 hours. Keep batteries out of reach of children.

If you think batteries may have been swallowed or placed inside any part of the body, seek immediate medical attention.

Information



Always dispose batteries in accordance with local laws and regulations.

Immobilizer system

The immobilizer system helps protect your vehicle from theft. If an improperly coded key (or other device) is used, the engine's fuel system is disabled.

When the Engine Start/Stop button is in the ON position, the immobilizer system indicator should come on briefly, then go off. If the indicator starts to blink, the system does not recognize the coding of the key.

Move the Engine Start/Stop button to the OFF position, then to the ON position again.

The system may not recognize your key's coding if another immobilizer key or other metal object (e.g. key chain) is near the key. The engine may not start because the metal may interrupt the transponder signal from transmitting normally.

If the system repeatedly does not recognize the coding of the key, contact an authorized HYUNDAI dealer.

Do not attempt to modify this system or add other devices to it. Electrical problems may occur making your vehicle inoperable.

i Information

To prevent theft of your vehicle, do not leave spare keys anywhere in your vehicle. Your immobilizer password is a customer unique password and should be kept confidential.

NOTICE

Avoid exposing the key to moisture, static electricity, and rough handling. The Immobilizer system may malfunction.

Hyundai Digital Key

 if equipped

Hyundai digital key provides convenience to the driver, which the driver can use to lock or unlock the driver and passenger doors or the liftgate and turn on the vehicle.

Digital key (smartphone)

i Information

- Hyundai digital keys are only available on smartphone that support digital key functions, and digital key functions of smartphones are provide by smartphone manufacturers.
 - Available smartphone brands and models can be found on smartphone manufactures' website or HYUNDAI website.
 - Certain functions may not operate depending on whether the service is provided in the vehicle.
 - Depending on the availability of service on the vehicle, some functions may not operated.
-

Setting your smartphone

To use the digital key (smartphone), download the Bluelink App and sign up Hyundai account and service.

For more information about Bluelink, refer to the infotainment system guide.

Registering your digital key (smartphone)

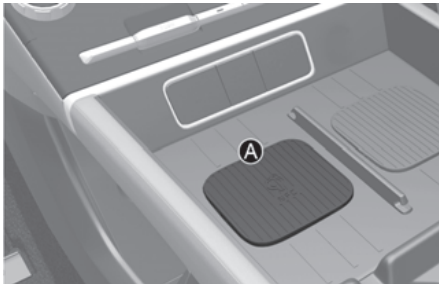
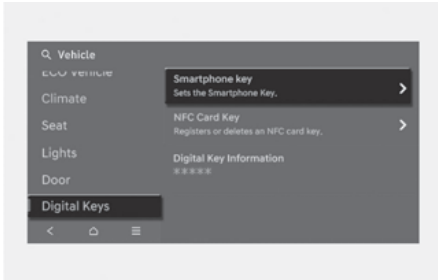

[A] Vehicle authentication pad (wireless charging pad)

1. Turn on the vehicle with a smart key and have your smart key with you in the vehicle.
2. Put the gear in P (Park), select **Setup > Vehicle > Digital keys > Smartphone key > My Smartphone Key** from the infotainment system.

3. After selecting **Digital Key > Set Up Digital Key** from the Bluelink App in the smartphone, register the digital key according to the guidance in the smartphone screen.

- Ultra Wide Band unsupported smartphone
 - Place your smartphone on the vehicle authentication pad (wireless charging pad) with the screen facing up.
 - The NFC Antenna position on Samsung device can be found in the following path: **Settings > Connections > NFC and contactless payments.**
 - The NFC Antenna position on Google Pixel phone can be found in the following path: **Settings > Connected devices > Connection preference > NFC.**
 - Ensure that the NFC Antenna position on the smartphone is in contact with the vehicle authentication pad (wireless charging pad).

- The NFC Antenna position on Apple iPhone is located at the top of the rear (A) and Apple WATCH is located at the center of the screen (B).



- The location of the NFC Antenna on the smartphone may vary by phone model, so please contact the smartphone manufacturer for details.
- NFC communication may not work for some smartphones depending on the internal structure of the smartphone. Move the smartphone to the left or right of the vehicle authentication pad (wireless charging pad) to operate.
- Ultra Wide Band supported smartphone
 - The digital key can be registered if the smartphone is inside the vehicle even without placing it on the vehicle authentication pad (wireless charging pad).
- Contact the smartphone manufacturer to check for Ultra Wide Band supported devices.

4. Press **Save** button in the infotainment system to start registration.

When the digital key (smartphone) is saved, a message appears on the infotainment system.

i Information

- If you want to register a different digital key (smartphone), refer to "Deleting your digital key (smartphone)" and delete the digital key (smartphone) before re-registering. An active Digital Key can be shared through the BlueLink App with a different smartphone.
 - During the digital key saving process, the process may cancel when:
 - The smartphone is removed from the vehicle authentication pad (wireless charging pad)
 - The infotainment system is changed
 - The engine is turned off
 - The gear is shifted
 - The registering process does not start if a smart key is not in the vehicle.
 - Some smartphones may not start the registering process depending on the internal structure. Move the smartphone to the left or right on the vehicle authentication pad (wireless charger pad) and try registering the smartphone.
 - Ultra Wide Band (UWB) is a radio technology that can use a very low energy level for short-range, high-bandwidth communications over a large portion of the radio spectrum.
-

Using the digital key (smartphone)

Digital key touch control

The driver can lock or unlock the door by placing the smartphone on the outside door handle, and the vehicle can be started by placing the smartphone on the vehicle authentication pad (wireless charging pad).

i Information

The location of the NFC Antenna on the smartphone may vary by phone model, so please contact the smartphone manufacturer for details.

Digital key close proximity control

- If you have the smartphone in possession, the doors can be locked or unlocked without touching the smartphone to the door handle, but by touching the door lock/unlock sensor (engraved part) on the door handle. Also, the vehicle can be started by pressing the Engine Start/ Stop button without placing the smartphone on the vehicle authentication pad (wireless charging pad).
- When the smartphone and vehicle is connected by Bluetooth, the Remote Start, Door Lock/Unlock, and Panic functions are available using the App provided by the smartphone manufacturer.

i Information

- The function is only available for Ultra Wide Band supported smartphone digital keys. To use the function, the smartphone's Bluetooth must be activated.
- The necessary distance between the smartphone and vehicle for Bluetooth connection may vary depending on the surroundings of the vehicle and smartphone.
- The Remote Start, Panic or Frunk open function may not be available depending on the country or vehicle type (hybrid, plug-in hybrid or electric vehicle).

Locking/Unlocking the doors

- Ultra Wide Band unsupported smartphone

Samsung & Google Pixel smartphones



[A] Door handle authentication pad
[B] NFC Antenna

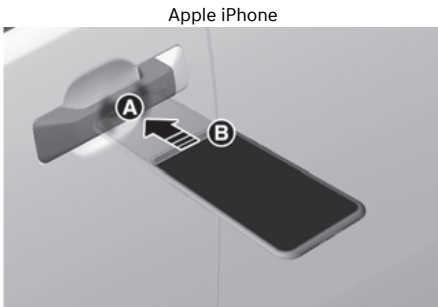

[A] Door handle authentication pad
[B] NFC Antenna

- If the driver places the digital key (smartphone) NFC antenna to the driver's or passenger's door handle authentication pad (A) for more than 2 seconds, the door locks or unlocks.
- If the **Two Press Unlock** feature is set, only the driver's door unlocks when the digital key (smartphone) is placed on the driver's door handle authentication pad (A). Place the digital key (smartphone) on the driver's door handle authentication pad once more within 4 seconds to unlock all doors.

- Ultra Wide Band supported smartphone
 - If you touch the door lock/unlock sensor (engraved part) on the door handle with the smartphone in possession, the door locks or unlocks.

After unlocking the doors, the doors are automatically re-locked after 30 seconds unless a door is opened.

If the smartphone digital key does not operate, try again after moving the smartphone away from the door handle authentication pad (more than 4 in. (0.1 m)).

i Information

- You cannot lock your vehicle using the digital key (smartphone) if any of the following occurs:
 - The smart key is in the vehicle.
 - The Engine Start/Stop button is in the ACC or ON position.
 - Any of the doors, hood, or liftgate are open.
- The door may not unlock automatically if you stay near the vehicle for several minutes with the Ultra Wide Band supported smartphone in possession.
- If the smartphone is kept in the back pocket or bag, it may cause poor Bluetooth connection, or the door lock/unlock or vehicle start-up operation may be delayed.

Starting the vehicle

- Ultra Wide Band unsupported smartphone
 - After placing your registered digital key (smartphone) on the vehicle authentication pad (wireless charging pad), depress the brake pedal and press the Engine Start/Stop button.
 - After starting the vehicle, the digital key (smartphone) may be removed from the vehicle authentication pad (wireless charging pad).
 - NFC communication may not work for some smartphones depending on the internal structure of the smartphone. Move the smartphone to the left or right of the vehicle authentication pad (wireless charging pad) to operate.
- Ultra Wide Band supported smartphone
 - With the smartphone inside the vehicle, depress the brake pedal and press the Engine Start/Stop button.
 - To start the vehicle remotely, use the App provided by the smartphone manufacturer to lock the vehicle with the door lock button, and press the remote start button within 4 seconds. The vehicle starts and the hazard warning lights blink.
 - Press the remote start button again to turn off the vehicle.

For more details on the basic way to start the vehicle, refer to the "Engine Start/Stop Button" section in chapter 6.

i Information

If a shared digital key (smartphone) is used for the first time, the activating time may take longer.

- Place the shared digital key (smartphone) on the door handle authentication pad until the vehicle door lock/unlock activates.
- If a shared digital key (smartphone) is first used on the vehicle authentication pad (wireless charging pad), the initial start of the vehicle may fail.
- If the door lock/unlock is activated once with the shared digital key (smartphone) or the vehicle is started with the digital key (smartphone) on the vehicle authentication pad, the digital key (smartphone) is registered in the vehicle.

WARNING

The vehicle can be started when the registered smartphone is placed on the vehicle authentication pad (wireless charging pad). Therefore, do not leave unsupervised children or people who are not aware of the system since it can result in serious injury or death. In addition, always have the registered smartphone with you to prevent vehicle theft when leaving the vehicle.

Operating the liftgate

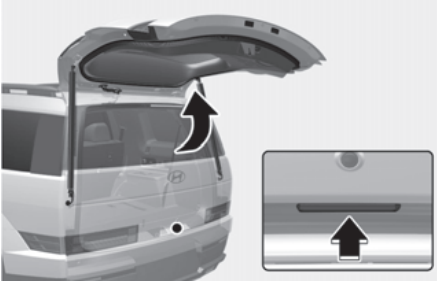

- Ultra Wide Band supported smartphone
 - If the vehicle is locked, press the liftgate open button with the smartphone in possession to open the liftgate.
 - If you are in the detecting area behind the liftgate for more than 3 seconds with the smartphone in possession when **Smart Liftgate** is set, the liftgate opens automatically.

WARNING

The vehicle can be started when the registered smartphone is placed on the vehicle authentication pad (wireless charging pad). Therefore, do not leave unsupervised children or people who are not aware of the system since it can result in serious injury or death. In addition, always have the registered smartphone with you to prevent vehicle theft when leaving the vehicle.

Information

- The Ultra Wide Band supported smartphone digital key can be used only when the smartphone and vehicle are connected with Bluetooth.
 - The necessary distance between the smartphone and vehicle for Bluetooth connection may vary depending on the surroundings.
 - Window tinting substances may cause poor Bluetooth connection.
 - If the smartphone is kept in the back pocket or bag, it may cause poor Bluetooth connection, or the door lock/unlock or vehicle start-up operation may be delayed.
- The Ultra Wide Band supported smartphone digital key can be used only for a certain amount of time to optimize the performance of the smartphone and vehicle battery. If you stay near the vehicle for several minutes with the Ultra Wide Band supported smartphone, the Auto Unlock feature may not operate.
- Check the smartphone's setting menu or the App provided by the smartphone manufacturer for the connection of the vehicle and smartphone.
- The Ultra Wide Band supported smartphone digital key can also use the NFC function.

Deleting your digital key (smartphone)

Turn on the vehicle with a smart key. Have your smart key with you in the vehicle.

Deleting all registered digital key (smartphone)

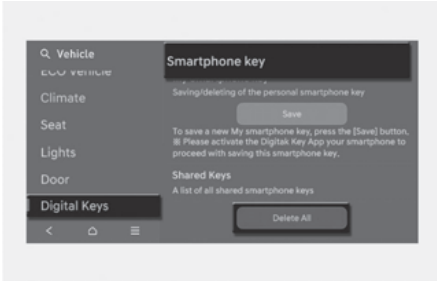

To delete all the registered digital key (smartphone), select **Setup > Vehicle > Digital Keys > Smartphone key > Delete all** from the infotainment system.

- The "**Delete all**" button is disabled if there is no registered digital key (smartphone).

Deleting my registered digital key (smartphone)

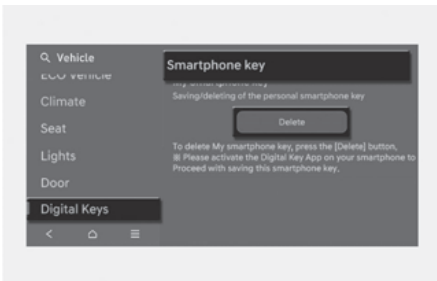

To delete only my registered digital key (smartphone), select **Setup > Vehicle > Digital Keys > Smartphone key > My Smartphone Key > Delete** from the infotainment system.

- If a shared digital key (smartphone) is registered, it cannot be deleted.
- A new smartphone can be registered after deleting the existing digital key (smartphone) from "**My Smartphone Key**" menu.

i Information

- If the registered digital key (smartphone) is deleted, the digital key saved in the smartphone is also deleted.
- If the digital key is deleted from the smartphone, the digital key (smartphone) registered in the vehicle is also deleted.
- The shared digital key registered in the vehicle cannot be deleted individually.
- Even though the Blue Link® App is deleted from the smartphone, the digital key saved in the smartphone is not deleted.
- Management of the digital key saved in the smartphone is available from the Digital Key App provided by the smartphone manufacturer.

Digital key (Card key)

How to register Digital key (Card Key)

To use the card key as a digital key, follow the following procedure.

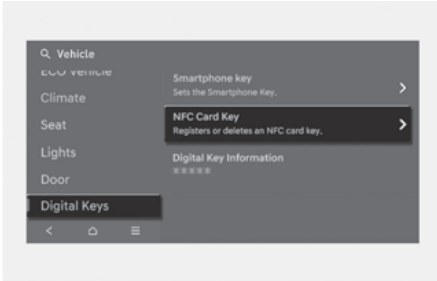

[A] Vehicle authentication pad (Wireless charging pad)

1. Have both of your smart keys with you in the vehicle.
2. Select **Setup > Vehicle > Digital Keys > NFC Card Key**, and check whether "Use" is selected in the infotainment system.

3. Place your card key on the vehicle authentication pad (wireless charging pad) while the engine is on.
4. Register your card key by selecting **Vehicle > Digital Keys > NFC Card Key > Save** from the Settings menu in the infotainment system.

i Information

- Only one digital key (card key) can be registered to the vehicle. If it must be replaced, delete the existing card key before registering the new card key.
- To register a digital key (card key), both of your smart keys must be in the vehicle.
- Once a digital key (card key) is registered, it cannot be registered in another vehicle. It is possible to re-register it to the original vehicle.

Using the digital key (card key)

The driver can lock or unlock the door by placing the card key on the outside door handle, and the vehicle can be started by placing the card key on the vehicle authentication pad (wireless charging pad).

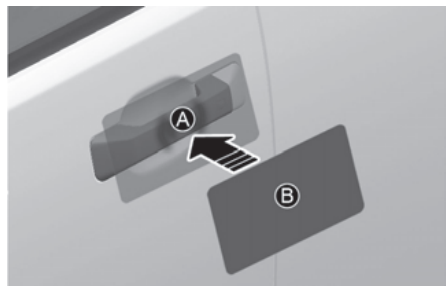

[A] Door handle authentication pad
[B] Card key NFC Antenna

Locking/Unlocking the doors

If the driver places the digital key (card key) to the driver's or passenger's door handle authentication pad (A) for more than 2 seconds, the door locks or unlocks.

If the **Two Press Unlock** feature is set, only the driver's door unlocks when the digital key (card key) is placed on the driver's door handle authentication pad. Hold the digital key (card key) near the driver's door handle authentication pad once more within 4 seconds to unlock all doors.

After unlocking the doors, the doors are automatically re-locked after 30 seconds unless a door is opened.

Information

You cannot lock your vehicle using the digital key (card key) if any of the following occurs:

- The smart key is in the vehicle.
 - The Engine Start/Stop button is in the ACC or ON position.
 - Any of the doors, hood, or liftgate are open.
-

Starting the vehicle

After placing your registered digital key (card key) on the vehicle authentication pad (wireless charging pad), depress the brake pedal and press the Engine Start/Stop button.

For more information on the basic way to start the vehicle, refer to the "Engine Start/Stop Button" section in chapter 6.

WARNING

The vehicle can be started when the registered card key is placed on the vehicle authentication pad (wireless charging pad). Therefore, do not leave unsupervised children or people who are not aware of the system since it can result in serious injury or death. In addition, always have the registered card key with you to prevent vehicle theft when leaving the vehicle.

NOTICE

- The digital key (card key) may not work under the following conditions:
 - The digital key (card key) is not placed on the door handle authentication pad or vehicle authentication pad (wireless charging pad) correctly.
 - The digital key (card key) is near NFC-enabled cards such as credit cards or smartphones.
If the digital key (card key) does not work, try again after moving the digital key (card key) away from the door handle authentication pad (more than 4 in. (0.1 m)).
 - The digital key (card key) can be damaged by impacts. If the digital key (card key) is damaged, replace the digital key (card key) with a new one and register it again.
 - Long-time exposure to high temperature may cause the digital key (card key) to malfunction. Be careful not to expose the digital key (card key) to direct sunlight or high temperature.
 - Leaving the digital key (card key) on the in-vehicle authentication pad (wireless charging pad) while driving may cause the digital key (card key) to malfunction. Remove the digital key (card key) from the in-vehicle authentication pad (wireless charging pad) after starting the vehicle.
 - Keep the digital key (card key) away from the smartphone when charging the smartphone. If the digital key (card key) is placed between the smartphone and the in-vehicle authentication pad (wireless charging pad) while the smartphone is being charged, the digital key (card key) may malfunction. For example, when charging smartphone while the digital key (card key) is attached to the back of the smartphone case.
-

Deleting your digital key (card key)

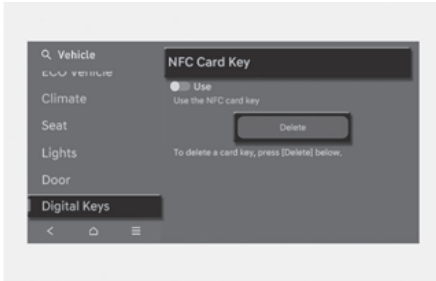

1. Turn on the engine with a smart key. Have your smart key with you in the vehicle.
2. Select **Setup > Vehicle > Digital Keys > Card Key > Delete** from the infotainment system.
 - The "**Delete**" button is disabled if there is no digital key (card key) registered.

Personalized profile and vehicle settings

You can set the registered digital key (smartphone) profiles for Driver 1 and Driver 2. When you use the digital key (smartphone), the vehicle can be set to the user-defined personalized profile (includes items such as vehicle settings and audio preferences).

Linking/Unlinking profile

How to link user profile

1. Select **Setup > User Profile > Profile Settings > Link Digital Key (Smartphone)** from Settings menu in the infotainment system.
2. Select "**Link**" to connect the registered smartphone's digital key and the user's profile.
3. Follow the instructions according to the message on the infotainment system.

How to unlink user profile

Select **Setup > User Profile > Profile Settings**, and then deselect "**Link Digital Key (Smartphone)**" from Settings menu in the infotainment system.

- Unlinking is possible only when user profile is linked.

i Information

- User profile cannot be linked to both Driver 1 and Driver 2 that are connected to single smartphone. Personalization operates with the recently linked user profile, and the previously linked user profile will be automatically canceled.
- User profile link works only when the digital key is registered to the vehicle.
- Digital key (card key) cannot be linked with a user profile.
- If the user profile linked digital key in the smartphone is deleted, the digital key should be re-registered and personalized by linking the user profile again.

Vehicle personalization operation

- The personalization function linked with digital key works when the profile linked smartphone is placed on the outside door handle authentication pad to lock or unlock the doors.
- The profile set by the digital key can be changed manually from the infotainment system.
- The personalization function using the digital key can be operated after linking the digital key in the infotainment system profile menu.
- The personalization function works only when the vehicle is OFF or when the vehicle is started remotely. If the vehicle is not started remotely, the personalization function does not work with the digital key.

i Information

User profile operation according to door lock/unlock system is as follows:

Item	Personalization Operation
Initial value	Guest
Profile linked smartphone key	Linked profile
Profile unlinked smartphone key	
NFC card key	
Smart key	

Used vehicle/Digital key maintenance

Purchasing used vehicle

If any of the digital key devices (smartphone key, card key) are registered in the vehicle, the "**Digital key registered**" message appears once on the infotainment system when the Engine Start/Stop button is in the ON position after unlocking the doors. When purchasing a used vehicle, make sure to check the message and delete the smartphone key and card key registered by the previous user and inform the purchase of a used vehicle through Hyundai Customer Care Center.

If the card key comes with the vehicle, check whether it operates properly.

Digital Key maintenance

If you need to have your Digital Key System repaired or replaced, the registered smartphone key or card key can be deleted.

Limitations of the system

- HYUNDAI Digital Key may not operate if any of the following occurs:
 - Smartphone battery or the vehicle battery is discharged.
 - NFC or Bluetooth is turned off on the smartphone settings.
 - A credit card is near your smartphone, or a metal or thick smartphone case is used.
 - The card key is in a wallet or card holder, or overlapped with other cards.
 - There is electronic interference by other vehicles, objects, etc.
 - If you use a smartphone cover that uses wireless communication or is made of metal, remove the smartphone cover.
- The vehicle may not be controlled by the smartphone if any of the following occurs:
 - Other smartphone functions (calls, urgent calls, audio or NFC payment), apps, or wireless earphones are operating.
 - The Bluelink App function such as basic setting or app launching is limited by the prior policy according to the manufacturer.

Fingerprint authentication system

 If equipped

Fingerprint authentication system provides convenient features such as allowing the driver to start the engine without a smart key, making electronic payments without a password, etc., with a registered fingerprint.

A fingerprint must be registered in the **User Profile** settings from the infotainment system to use the system.

The maximum of two fingerprints can be registered. **Driver 1** and **Driver 2** can register one fingerprint each.

Information

Fingerprint authentication system operates only when A fingerprint is registered.

Fingerprint authentication system settings

You can set or delete a fingerprint through the infotainment system.

Follow the following procedure.

Registering fingerprint



[A] : Fingerprint sensor

1. Turn on the vehicle with a smart key. Have both of your smart keys with you in the vehicle.
2. Select **Setup > User Profile > Driver 1 > Fingerprint Identification > Set/Delete Fingerprint > Set** in the infotainment system.
3. Place your finger that you wish to register on the fingerprint sensor according to the instruction.
4. Following the instructions, place several parts of your fingerprint until the scanning process is complete.
5. Once the "**Saving fingerprint....**" appears and the fingerprint registering process is proceeded.
6. When the fingerprint registering process is completed in the vehicle, the status is displayed on the infotainment system.

i Information

- Remove all substances including protection film on the fingerprint sensor, and then register your fingerprint.
 - Starting the engine with fingerprint is available when your vehicle is equipped with the Digital Key system.
 - Electronic payment with fingerprint is available when you are a member of Blue Link.
 - The fingerprint registering process is canceled when the following condition occurs:
 - The infotainment system screen is altered
 - The Engine Start/Stop button turns on or off
 - The gear is shifted, and the vehicle is driven
-

Deleting fingerprint

1. Turn on the vehicle with a smart key.
2. Select **Setup > User Profile > Driver 1 > Fingerprint Identification > Set/Delete Fingerprint > Delete** in the infotainment system.
3. Delete the registered fingerprint according to the message "**Delete all Driver 1 fingerprints?**".
4. Once the fingerprint is deleted, the status is displayed on the infotainment system.

i Information

To delete your fingerprint, at least one smart key must be in the vehicle.

CAUTION

Do not participate in duplicating fingerprints with anyone.

NOTICE

Touch the fingerprint sensor gently. Fingerprint authentication attempts with excessive force may fail.

Fingerprint authentication system operation

Using features with touch control

The convenient features such as starting the engine, accessing personal information, unlocking profile, exiting valet mode, and making electronic payment (Hyundai Car pay) are available with the fingerprint authentication system.

When the fingerprint shape appears on the infotainment system screen, you should place your finger on the fingerprint sensor in the vehicle according to the instruction message for authorization and then you can operate the linked features without entering the password.

If the fingerprint authentication system does not work, pull your finger away from the fingerprint authentication sensor and then try again.

Fingerprint linked features can be turned on or off from the Settings menu. Select:

- **Setup > User Profile > Driver 1 > Fingerprint Identification**

Fingerprint linked features	Characteristic
Starting engine	Start engine with fingerprint but without smart key Use features with fingerprint but without a password
Personal information access	
Profile unlock	
Valet mode exit	
Hyundai Car pay (Electronic payment)	

See additional information in supplied Infotainment Manual to link profile, to set valet mode, or to use Hyundai Car Pay.

i Information

You cannot link a profile with the same fingerprint for **Driver 1** and **Driver 2**. The personalization function works with the recently linked profile, and the previously linked profile automatically cancels.

Starting the engine

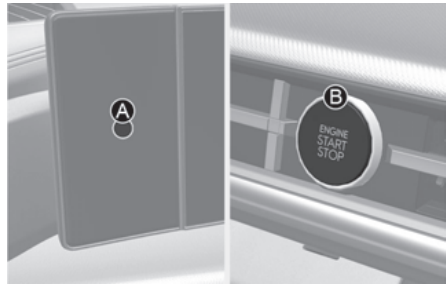

[A] Fingerprint sensor
[B] Engine Start/Stop button

Place your finger on the fingerprint sensor to verify your fingerprint. After it is successfully verified, start the engine by pressing the Engine Start/Stop button within 30 seconds.

Message on cluster when starting the engine

Fingerprint authentication status	Light color	Message on cluster display
Standby	White	-
Succeed	Blue	"Authenticated. The vehicle can now be started."
Fail	Yellow	-
Restricted due to consecutive failure	Red	"Fingerprint authorization is locked out. Try again in 00 min." <ul style="list-style-type: none"> Restricted for 1 minute, 3 minutes or 5 minutes when failed every 5 times.

For more information on how to start your vehicle with the Engine Start/Stop button, refer to "Engine Start/Stop Button" section in chapter 6.

i Information

If you are in the vehicle for an extended period without starting the engine, the fingerprint sensor may turn off.

If this occurs, depress the brake pedal and verify your fingerprint again when the fingerprint sensor illuminates.

Limitations of fingerprint authentication system

- Fingerprint authentication system may not work when:
 - Trying to authorize with an unregistered fingerprint.
 - The center of the fingerprint sensor is not touched.
 - Any water or substance is on your finger or the sensor.
 - The film on the sensor is not removed.
 - The registered fingerprint is scarred or swollen.
 - The hand is overly dry.
 - The sensor is touched shortly.
- If fingerprint authentication fails repeatedly, fingerprint authentication may be temporarily restricted. You should try it later or try other methods such as using your smart key or inputting your password.
- If the engine does not start due to fingerprint sensor malfunction, have the system inspected by an authorized HYUNDAI dealer.
- When you visit an authorized HYUNDAI dealer to repair parts due to fingerprint authentication system or related part failure, your registered fingerprint might be deleted. Have your smart key when you visit an authorized HYUNDAI dealer.
- You cannot use the fingerprint sensor when the vehicle is discharged.
- If **Start Vehicle** is deselected from the vehicle settings menu for **Driver 1** and **Driver 2**, the fingerprint sensor will not operate when the vehicle is off.
- If the engine is turned on or off during the fingerprint authentication process, your fingerprint may not be verified properly.



WARNING

Do not register children's fingerprints in the vehicle.

If you register children's fingerprints and leave them in the vehicle, unexpected crashes may occur.

When purchasing a used vehicle

If you purchase a used vehicle, you should confirm and delete all registered fingerprints in **Driver 1** and **Driver 2** profile.

If a fingerprint is registered, the message "**Biometric authentication active**" appears on the cluster display once when the vehicle door is unlocked, and the engine is started.

Remotely starting the vehicle

If **Start Vehicle** is selected from the **Driver 1** or **Driver 2 User Profile** settings menu, and the door is unlocked with the Digital Key App or the Blue Link App while the vehicle is remotely started, the engine will turn off if the fingerprint sensor does not verify your fingerprint.

To remotely start the vehicle with the Digital Key App, refer to the "Hyundai Digital Key" section in this chapter. And for Blue Link App, see additional information in separately supplied manual.

To remotely start the vehicle with the Digital Key App, refer to the "Hyundai Digital Key" section in chapter 5 of the complete Owner's Manual. And for Blue Link App, see additional information in separately supplied manual.

Door Locks

Operating door locks from outside the vehicle

Using the mechanical key

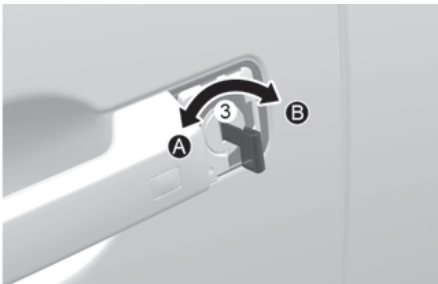
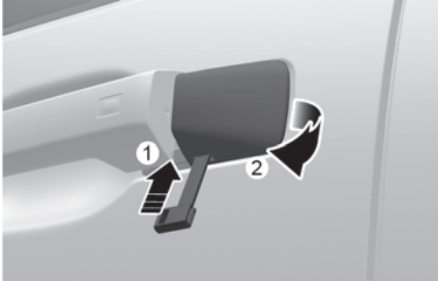

[A] Lock
[B] Unlock

To unlock:

1. Pull the door handle.
2. Press the release button located inside the cover with a mechanical key (1).
3. Carefully pull out the cover (2) while continuing to press the release button to remove the cover and expose the key cylinder.
4. Insert the mechanical key into the key cylinder and rotate (3) clockwise to unlock the vehicle and counterclockwise to lock the vehicle.

Once the doors are unlocked, they can be opened by pulling the door handle.

i Information

Only the driver's door can be locked/unlocked using the mechanical key.

NOTICE

- When removing the key cylinder cover, avoid scratching or breaking the plastic material.
- If the key cylinder cover freezes and cannot be removed easily, lightly tap on the cover or try to warm the cover by placing your hands around it and blowing warm air on it.
- Do not apply excessive force to the door and door handle.

Using the smart key

For more information, refer to the "Smart key" section in this chapter.

***i* Information**

- In cold and wet climates, door lock and door mechanisms may not work properly due to freezing conditions.
 - If the door is locked/unlocked multiple times in rapid succession with either the vehicle key or door lock switch, the system may stop operating temporarily in order to protect the circuit and prevent damage to system components.
-

In case of an emergency

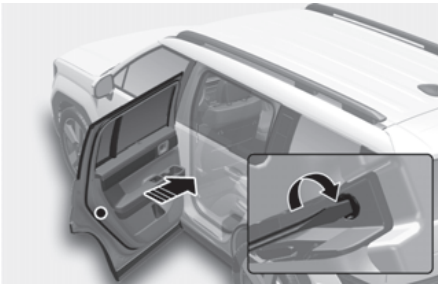

In case of emergency such as when the battery is discharged, the only way to lock the door(s) is with the mechanical key from the outside key hole.

Doors without an outside key hole can be locked as follows:

1. Open the door.
2. Insert a small blade tool (e.g. screwdriver or similar) into the emergency door lock hole and turn it clockwise for left side door, or turn it counterclockwise for right side door.
3. Close the door securely.

***i* Information**

If the electrical power to door lock switch does not operate (e.g. discharged vehicle battery) and the liftgate is closed, you cannot open the liftgate until power is restored.

Operating door unlocks from inside the vehicle

With the door inside handle



Driver door

If the inner door handle is pulled when the door is locked, the door is unlocked and opened.

Passenger door and Rear door

If the inner door handle is pulled once when the door is locked, the door is unlocked. If the inner door handle is pulled once more, the door is opened.

With the central door lock/unlock switch

Driver's door



Front passenger's door

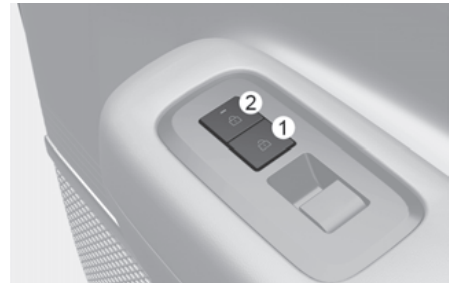

When pressing the (🔒) portion (1) on the switch, all vehicle doors are locked.

- If any door is opened, the doors are not locked even though the lock switch (1) of the door is pressed.

When pressing the (🔓) portion (2) on the switch, all vehicle doors are unlocked.

WARNING

- Always close and lock the doors while the vehicle is moving. If the doors are unlocked, the risk of being thrown from the vehicle in a collision increases.
- Do not pull the inner door handle of the driver's or passenger's door while the vehicle is moving.

WARNING

Do not leave the elderly, children, or animals unattended in your vehicle. An enclosed vehicle can become extremely hot and the elderly, unattended children or animals who cannot escape the vehicle may be seriously injured or killed.

WARNING

Always park your vehicle properly. Depress the brake pedal, change the gear to P (Park), apply the parking brake, move the Engine Start/Stop button to the OFF position, close all windows, lock all doors, and always take the keys with you.

WARNING

Be careful when opening doors and watch for vehicles, motorcycles, bicycles, or pedestrians approaching the vehicle to prevent serious injury or death.

Information

To exit the vehicle if the power door lock does not function:

- Operate the door unlock feature repeatedly (both electronic and manual) while simultaneously pulling on the door handle.
 - Operate the other door locks and handles.
 - Lower the driver's front window and use the mechanical key to unlock the door from outside.
-

Auto door lock/unlock features

Impact sensing door unlock system

All doors are automatically unlocked when an impact causes the airbags to deploy.

Speed sensing door lock system

All doors are automatically locked when the vehicle exceeds 9 mph (15 km/h).

Auto unlock on shift to P

When this feature is set in the infotainment system, all the doors will be unlocked automatically when the vehicle is shifted back to P (Park) while the engine is running.

Electronic child safety lock



When the electronic child safety lock button is pressed and the indicator light on the button illuminates, the rear doors cannot be opened from inside the vehicle.

- The rear door window cannot be opened or closed while the electronic child safety lock button is in the LOCK position (indicator light ON).
For more information, refer to the "Windows".
- Electronic child safety lock does not automatically turn on unless the driver presses the electronic child safety lock button.
- If 3 minutes passes after the Engine Start/Stop button is pressed to the OFF or ACC, the indicator on the button turns off, and the driver cannot turn off electronic child safety lock by pressing the button. To turn off the function, press the Engine Start/Stop button to the ON position, and then press the electronic child safety lock button.

- If the power is supplied again after removing the battery or battery is discharged while the electronic child safety lock button is in the LOCK position, press the button once more to match the state of the indicator on the electronic child safety lock button and actual status of the electronic child safety lock function.
- If the airbag is activated while the electronic child safety lock button is in the LOCK position (indicator light ON), the rear doors will unlock automatically.
- Vehicles equipped with the electronic child safety lock feature is not provided with a manual child safety lock.

WARNING

If children accidentally opens the rear door while the vehicle is in motion, they could fall out of the vehicle. Electronic child safety lock should always be used whenever children are in the vehicle.

NOTICE

Child safety lock failure/Child safety lock error

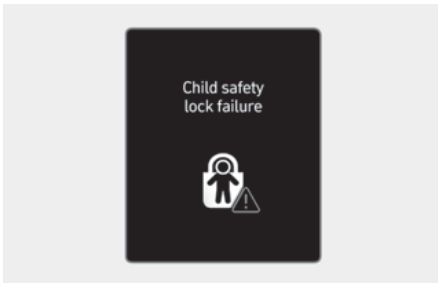

When electronic child safety lock does not work even though the button is pressed, the message will be displayed and an alarm will sound. If this occurs, have your vehicle inspected by an authorized HYUNDAI dealer.

Safe Exit Assist (with electronic child safety lock)

Safe Exit Assist prevents the rear occupant from opening the rear door. When an approaching vehicle from the rear area is detected after the vehicle stops, the rear doors will not unlock even when the driver tries to unlock the rear doors using the electronic child safety lock button.

For more information, refer to the "Safe Exit Assist (SEA)".

Theft-alarm System

This system helps protect your vehicle and valuables. The horn sounds and the hazard warning lights blinks continuously if any of the following occur:

- A door is opened without using the smart key.
- The liftgate is opened without using the smart key.
- The hood is opened.

The alarm continues for 30 seconds, then the system resets. To turn off the alarm, unlock the doors with the smart key.

The Theft Alarm System automatically sets 30 seconds after you lock the doors and the liftgate. For the system to activate, you must lock the doors and the liftgate from outside the vehicle by doing one of the following:

- Using the smart key.
- Pressing the button on the outside door handle with the smart key in your possession. (available with button type)
- Touching the touch sensor on the outside door handle with the smart key in your possession. (available with touch sensor type)

The hazard warning lights blink and the chime sounds once to indicate the system is armed.

Once the security system is set, opening any door, liftgate, or hood without using the smart key causes the alarm to activate.

The Theft Alarm System is not set if the hood, liftgate, or door is not fully closed. If the system is not set, check the hood, liftgate, or doors are fully closed.

Do not attempt to modify this system or add other devices to it.

i Information

- Do not lock the doors until all passengers have left the vehicle. If a door is opened after the system is armed, the alarm is activated.
 - If the vehicle is not disarmed with the smart key, open the doors using the mechanical key and start the engine by pressing the Engine Start/Stop button with the smart key.
 - If the system is disarmed by unlocking the vehicle, and a door or the liftgate is not opened within 30 seconds, the doors are relocked and the system is rearmed automatically.
-

i Information



Vehicles equipped with a theft alarm system have a label attached to the vehicle with the following words:

1. WARNING
 2. SECURITY SYSTEM
-

Rear Occupant Alert (ROA)

Rear Occupant Alert is provided to help prevent the driver from leaving with any rear passenger left in the vehicle.

System setting

To use Rear Occupant Alert, it can be enabled from the Settings menu in the infotainment system. Select:

Setup > Vehicle > Convenience > Rear Occupant Alert

i Information

The infotainment system may change after software updates. For more information, refer to the manual provided in the infotainment system and the quick reference guide.

System operation

When you turn off the engine and open the driver's door after opening and closing the rear door, the "**Check rear seats**" warning message appears on the cluster display.

i Information

To turn the warning message off, press the **OK** button.

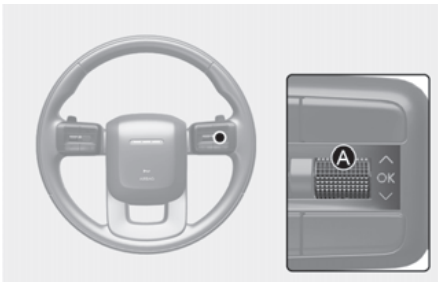

! WARNING

Always check the rear seats before you leave the vehicle.

The Rear Occupant Alert system does not actually detect the presence of objects or occupants in the rear seat but just informs you to check the rear seat by using the record of the rear door opening and closing.

i Information

The record of the rear door opening and closing resets only when the driver turns the vehicle off and locks the vehicle door. Even if the rear door has not been reopened, an alert may occur if the door record is not reset. For example, if the driver opens the door and exits the vehicle again without locking the door after the Rear Occupant Alert operates, the alert may occur again.

Advanced Rear Occupant Alert (ROA)

 if equipped

Advanced Rear Occupant Alert is provided to prevent a driver from leaving a vehicle with a passenger left in the vehicle.

Advanced rear occupant alert settings

To use Rear Occupant Alert, it must be enabled from the Settings menu in the infotainment system. Select:

- **Setup > Vehicle > Convenience > Rear Occupant Alert**

See additional information in supplied Infotainment Manual.

Information

- Deselect **Rear Occupant Alert** from the settings menu to turn the system off.
- The infotainment system may change after software updates. For more information, refer to the user's manual provided in the infotainment system and the quick reference guide.

Advanced rear occupant alert operation

- **First alert**
When you turn off the engine and open the driver's door after opening and closing the rear door or liftgate, the **Check Rear Seats** warning message appears on the cluster.
- **Second alert**
After the first alert, the second alert operates when any movement is detected in the vehicle after the driver's door is closed and all the doors are locked. The horn will sound for approximately 25 seconds.
If the system continues to detect a movement, the alert operates up to 8 times.
Unlock the doors with the smart key to stop the alert.
- The system detects movement in the vehicle for 10 minutes after the door is locked.

i Information

- The second alert is available for vehicles equipped with the ROA sensor.
- The second alert is activated only after the prior activation of the first alert.
- If you do not want to use Rear Occupant Alert, press the OK button on the steering wheel when the first alert is displayed on the cluster. Doing so will deactivate the second alert one time.

Cluster

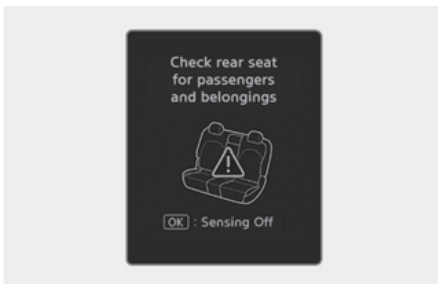

Steering wheel

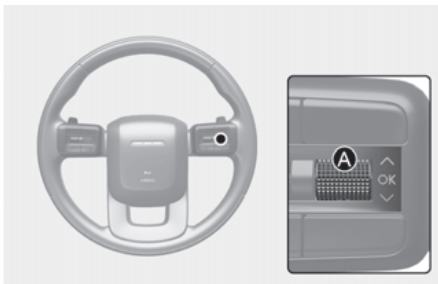

- If the vehicle is started remotely (if equipped with Remote Start), inside movement detection will stop.

Advanced rear occupant alert precautions

Sensor

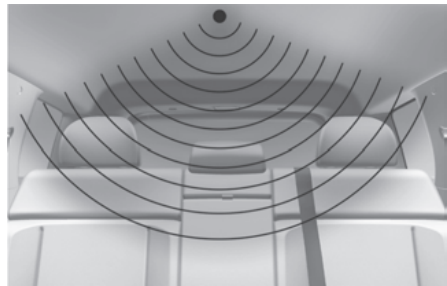

- Make sure that all the windows are closed. If the window is open, the alert may operate by the sensor detecting an unintended movement (for example, wind or bugs).
- The alert may operate if movement in the driver or passenger seat is detected.
- If the doors are locked with a passenger inside the vehicle, the alert may operate.
- An alert can occur if the vehicle is impacted.
- If boxes or objects are stacked in the vehicle, the system may not detect passengers. Or, the alert may operate if the boxes or objects fall off.
- The alert may operate when the vehicle is pushed or shaken, or while washed, or by surrounding noise or vibration after the vehicle is locked.
- The alert may operate when there are metallic or liquid objects in the vehicle.
- **Movement is not detected in areas other than the rear seats.**

WARNING

Even if your vehicle is equipped with Advanced Rear Occupant Alert (ROA), always make sure to check the rear seats before you leave the vehicle.

Advanced Rear Occupant Alert (ROA) may not operate when:

- Movement does not continue for a certain period of time or the movement is small.
- A child is not seated in a child restraint system.
- The detection signal is weak because the signal is obscured by seat or CRS (for example, child is restrained in the forward-facing CRS).
- The rear passenger is covered with a fabric containing metallic substance such as a blanket.
- An object in the vehicle blocks the sensor.
- The sensor is contaminated by foreign material.
- An animal at the rear seat is not large enough to be detected by the sensor or there is hardly any movement.
- Attaching objects or modifying the interior ceiling, or the interior ceiling is deformed or damaged.
- There are electronic interference around the vehicle.
- Other environmental reasons that may affect the system.

Declaration of conformity

The radio frequency components (ROA Radar Sensor) complies:

- For USA

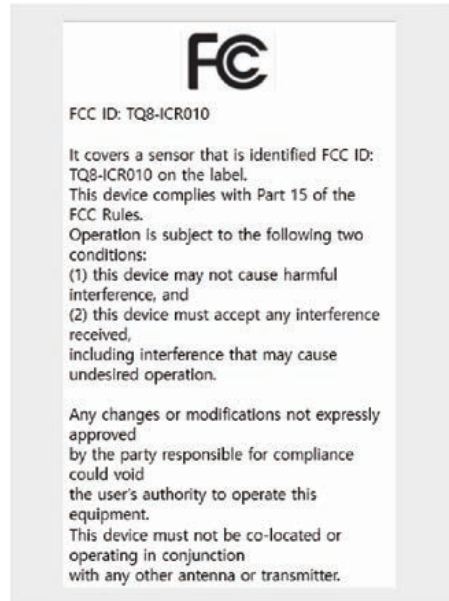

- For Canada

Model : ICR010
IC ID : 5074A-ICR010

This device contains license exempt transmitter(s)/receiver(s) that comply with Innovation, Science and Economic Development Canada's license-exempt RSS(s). Operation is subject to the following two conditions:

- (1) This device may not cause interference.
- (2) This device must accept any interference, including interference that may cause undesired operation of the device.

L'émetteur/récepteur exempt de licence contenu dans le présent appareil est conforme aux CNR

d'Innovation, Sciences et Développement économique Canada applicables aux appareils radio exempts de licence.

L'exploitation est autorisée aux deux conditions suivantes :

- 1) L'appareil ne doit pas produire de brouillage;
- 2) L'appareil doit accepter tout brouillage radioélectrique subi, même si le brouillage est susceptible d'en compromettre le fonctionnement.

Integrated memory system

 if equipped



Integrated Memory System for the driver's seat is provided to store and recall the following memory settings with a simple button operation.

- Driver's seat position
- Side view mirror position
- Head-Up Display (HUD) position (if equipped)

WARNING

Never attempt to operate the Integrated Memory System while the vehicle is moving.

Information

- If the battery is disconnected, the memory settings are erased.
- If the Integrated Memory System does not operate normally, contact an authorized HYUNDAI dealer.

Storing memory positions

1. Make sure the Engine Start/Stop button is in the ON position and the gear is in P (Park).
2. Adjust the driver's seat and side view mirror to the desired position.
3. Press and hold one of the memory buttons (1 or 2). The system beeps once when successfully stored.
4. **"Driver 1 (or 2) settings saved"** appears on the infotainment system.

Recalling memory positions

1. Make sure the Engine Start/Stop button is in the ON position and the gear is in P (Park).
2. Press the desired memory button (1 or 2). The system beeps once and then the driver's seat position and side view mirror position are automatically adjusted to the stored positions.
3. **"Driver 1 (or 2) settings applied"** appears on the infotainment system.

Information

- To recall the IMS settings of memory button 2 while the settings of memory button 1 is being recalled, press memory button 1 to stop the IMS adjustment, and then press memory button 2.
- If you adjust the driver seat and the side view mirror while the IMS is adjusting the seat and the side view mirror, the system stops the adjustments.

Resetting the integrated memory system

1. Make sure that the gear is in P (Park) and the engine is ON, and then open the driver's door.
2. Adjust the driver's seat and seatback to the most forward position.
3. Press and hold both the memory button 1 or 2 and the driver's seat forward movement switch.

While resetting integrated memory system

A notification sound is heard and the seat is adjusted to the most reward position. Then the seat and seatback move to the default center position.

The resetting procedure and the notification sound may stop if:

- The memory button is pressed.
- The seat control switch is operated.
- The gear is shifted out of P (Park).
- The driving speed exceeds 2 mph (3 km/h).
- The driver's door is closed.

Information

- If the seat movement or notification sound stops before the process is complete, restart the resetting procedure.
- Before resetting the IMS, make sure there are no objects on or around the driver's seat.
- After resetting the IMS, the driver's seat must be adjusted and stored again to recall the memory position.

Seat easy access operation

 If equipped

Seat easy access moves the driver's seat automatically as follows:

• **Exiting the vehicle (driver seat):**

The driver's seat moves rearward when the Engine Start/Stop button is in the OFF position with the gear in P (Park) and the driver's door open.

Seat Easy Access operation may be limited when the driver's seat position setting is already close to the maximum rearward travel position.

• **Entering the vehicle (driver seat):**

The driver's seat moves forward when the Engine Start/Stop button is in the ACC, ON or START position or while carrying the smart key, the driver's door is closed with the Engine Start/Stop button in the OFF position.

- You can set the Seat Easy Access feature from the Settings menu in the infotainment system. Select:
 - **Setup > Vehicle > Seat > Seat Easy Access > Driver seat easy access > Extended/Normal/Off**

Information

The infotainment system may change after software updates. For more information, refer to the user's manual provided in the infotainment system and the quick reference guide.

WARNING

To prevent injury or property damage, be aware if there are objects or passengers in the driver's side rear seat or seat floor. To stop movement of the front seat, press any of the driver's seat control switches.

Steering wheel

Motor Driven Power Steering (MDPS)

The system assists you with steering the vehicle. If the vehicle is turned off or if the power steering system becomes inoperative, you may still steer the vehicle, but it requires increased steering effort.

If you notice any change in the effort required to steer during normal vehicle operation, contact an authorized HYUNDAI dealer.

CAUTION

If the Motor Driven Power Steering (⚠) warning light and the message, "**Check motor driven power steering**" illuminate on the instrument cluster, you can continue to steer the vehicle, but it requires increased effort. Contact an authorized HYUNDAI dealer and have the system inspected as soon as possible.

Information

During normal vehicle operation:

- The steering effort may be high immediately after moving the Engine Start/Stop button to the ON position. This happens as the system performs the MDPS system diagnostics. When the diagnostics are completed, the steering wheel effort returns to its normal condition.
- When the battery voltage is low, you might have to use more effort to steer. This is a temporary condition and returns to normal after charging the battery.

- A noise may be heard from the MDPS relay after the Engine Start/Stop button is in the ON or OFF position.
- Motor noise may be heard when the vehicle is at a stop or driving at low speeds.
- When you operate the steering wheel in low temperatures, abnormal noise may occur. When the temperature rises, the noise disappears.
- When an error is detected from MDPS, the steering effort assist function is not activated. Instrument cluster warning lights may illuminate or the steering effort may be high. If these symptoms occur, drive the vehicle to a safe location as soon as possible. Have the system inspected by an authorized HYUNDAI dealer as soon as possible.

Tilt/telescopic steering

Adjust the steering wheel toward your chest, not toward your face. Make sure you can see the instrument cluster warning lights and gauges. After adjusting, push the steering wheel up and down to be in the locked position.

WARNING

Never adjust the steering wheel while driving. This may cause loss of vehicle control resulting in a collision.

NOTICE

While adjusting the steering wheel position, please do not push or pull it hard since the fixture can be damaged.

Manual adjustment

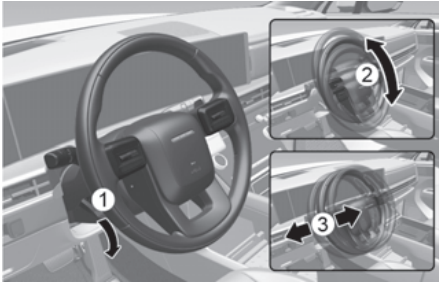

To adjust:

1. Pull down the lock-release lever (1).
2. Adjust the steering wheel to the desired angle (2) and distance forward/back (3).
3. Pull the lock-release lever up to lock the steering wheel in place.

i Information

Sometimes the lock-release lever may not engage completely. Pull down on the lock-release lever, readjust the steering wheel again, and then pull back up on the lock-release lever to lock the steering wheel in place.

Steering wheel heater

If equipped

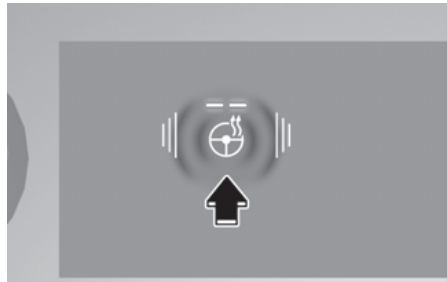

When the Engine Start/Stop button is in the ON position or when the engine is running, press the steering wheel heater button to warm the steering wheel.

The indicator on the button illuminates. To turn the steering wheel heater off, press the button again. The indicator on the button turns off.

Manually adjusting temperature

Each time you press the heated steering icon, the temperature changes as follows.

- OFF > HIGH > LOW
- Pressing the button or the icon when temperature is HIGH, the heated steering wheel will turn off.

Automatically adjusting temperature

- When HIGH is manually selected, the heated steering wheel automatically changes to the LOW position after 30 minutes. You can turn off the heated steering wheel by pressing the button or the icon to the OFF position.
- When LOW is manually selected, the heated steering wheel will not be controlled automatically.

Horn



To sound the horn, press the area indicated by the horn symbol on your steering wheel (see illustration). The horn operates only when this area is pressed.

NOTICE

Do not strike the horn severely or hit it with your fist. Do not press on the horn with a sharp-pointed object.

NOTICE

Do not clean the steering wheel surface with the following products:

- Organic solvents such as thinner, alcohol and gasoline
- Chemical products such as leather cleaner, coating agent, and wax

Steering wheel grip sensor

While driving the vehicle with the Driver Assistance system on, it detects whether the driver is holding the steering wheel and displays the Hands-off warning when the driver is not holding the steering wheel. For more information, refer to the "Hands off warning" from "Lane Keeping Assist (LKA)", "Lane Following Assist (LFA)", "Highway Driving Assist (HDA)" section in chapter 7.

In the following situations, the sensor may fail to detect the driver's hands although the driver is holding the steering wheel.

- When the driver is wearing gloves.
- When accessories such as a cover is attached on the steering wheel.
- When electronic device is touching the steering wheel.
- When the steering wheel is wet.

CAUTION

The steering wheel sensor may not work properly if the following precautions are not followed.

- Do not modify the steering wheel cover.
 - Do not attach accessories on the rim of the steering wheel.
 - Do not touch the steering wheel with electronic devices. (ex. Laptop, tablet PC, etc)
 - Do not touch the steering wheel with metallic or conductive objects. (ex. Tumbler, soda can, etc)
 - Do not excessively wet the steering wheel. (ex. spilled water, wet tissue, vapor from steam wash)
-

Haptic warning/Steering wheel vibration warning

If haptic steering wheel is available, the Driver Assistance system vibrates the steering wheel to warn the driver when the system indicates hazardous situations.

Setting haptic warning

While the engine is on, select:

Setup > Vehicle > Driver Assistance > Warning Methods > Haptic Warning in the infotainment system.

Mirrors

Inside rearview mirror

Before driving your vehicle, check to see that your inside rearview mirror is properly positioned. Adjust the rearview mirror so that the view through the rear window is properly centered.

WARNING

Make sure your line of sight is not obstructed. Do not place objects on the rear seat or in the cargo area that may interfere with your vision through the rear window.

WARNING

To prevent serious injury during a collision or deployment of the airbag, do not modify the rearview mirror and do not install a wide mirror.

WARNING

Never adjust the mirror while driving. This may cause loss of vehicle control and result in a collision.

NOTICE

When cleaning the mirror, use a paper towel or similar material dampened with glass cleaner. Do not spray glass cleaner directly on the mirror as this may cause the liquid cleaner to enter the mirror housing.

Day/night rearview mirror

 if equipped

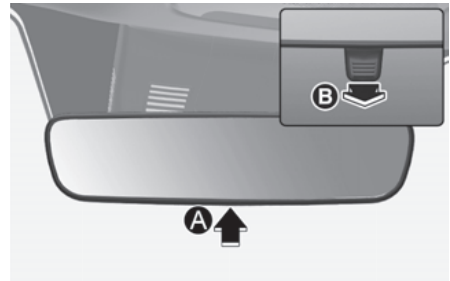

[A] Day
[B] Night

Before driving at night, pull the day/night lever toward you to reduce glare from the headlights of the vehicles behind you.

Remember that you lose some rearview clarity in the night position.

Electrochromic mirror

 if equipped



[A] Sensor

When the engine is running, the glare from vehicle headlights behind you is automatically controlled by the sensor mounted in the rearview mirror.

When the gear is shifted to R (Reverse), the mirror automatically goes to the brightest setting to improve the driver's view behind the vehicle.

Digital Center Mirror

 if equipped

The Digital Center Mirror is a system that uses the camera on the rear of the vehicle and displays its image on the screen of the Digital Center Mirror. The Digital Center Mirror allows the driver to see the rearview despite obstructions, such as the head restraint or luggage, ensuring rear visibility.

WARNING

- Failure to follow the warnings and instructions for proper use of the Digital Center Mirror could result in serious crash.
 - The Digital Center Mirror is a convenience feature but it is not a substitute for proper vehicle operation. The system has areas where objects cannot be viewed. Check the blind spot of the Digital Center Mirror before vehicle operation. The driver is always responsible for safe driving.
 - Do not operate the Digital Center Mirror while driving. Doing so can be a distraction and it could lose control of your vehicle and cause a collision or serious injury.
 - Do not disassemble or modify the Digital Center Mirror, the camera unit or wirings. If you do, it may result in crashes or fire. In case you notice smoke or smell coming from the Digital Center Mirror, stop using the system immediately. Have your vehicle inspected by an authorized HYUNDAI dealer for servicing.

- Be sure to adjust the Digital Center Mirror before driving.
 - Switch the system to the conventional rearview mirror mode and be properly seated on the driver's seat. Then adjust the mirror so as to see the rear window properly.
 - Push the lever all the way to change to digital mirror mode and adjust the display settings. Driving without adjusting the mirror may cause difficulty in watching the display at the Digital Mirror mode (camera view mode) due to the reflection from the surface of the mirror.
 - As the range of the image display by the Digital Center Mirror is different from that of the optical mirror, make sure to check this difference before driving.
- If the Digital Center Mirror malfunction, immediately switch the system to the conventional rearview mirror mode.
- When strong light (for example, sunlight or high beams from following vehicles) enters the camera, a light beam or a glaring light may appear on the monitor screen of the Digital Center Mirror. In that case, switch the system to the conventional rearview mirror mode appropriately.



- If the camera lens (1) is dirty, the displayed image may not be clear. In this case, clean it with a soft cloth dampened with water or a swab.

System component

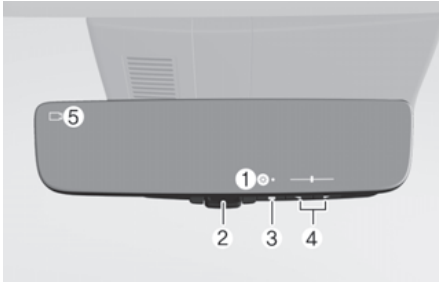

1. Icon display area
Displays icons, adjusting Brightness & Tilt
2. Lever
Operate to change between digital mirror mode and optical mirror mode.
3. Menu button
Press to display the icon display area and select the item you want to adjust (Brightness & Tilt).
4. Select/adjust button
Press to change the setting of the item you want to adjust.
5. Camera indicator
Indicates that the camera is operating normally.

How to change the mode

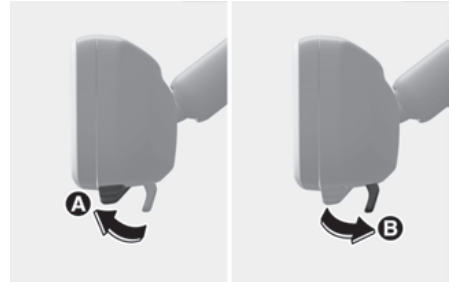

The mode can be switched when the switch is in the ON position.

1. Pull the mode select lever all the way to switch to the Digital Center Mirror mode (camera view mode).
* Displays an image of the area behind the vehicle. In this mode, camera indicator (5) is shown.
2. Push the mode select lever all the way to switch to the optical inside rearview mirror mode
* Turns off the display of the Digital Center Mirror allows it to be used as an optical mirror.

Adjusting the mirror height



The height of the rearview mirror can be adjusted to suit your driving posture. Change to optical mirror mode, adjusting the rearview mirror angle by moving it up and down.



Display settings (Digital mirror mode)

 if equipped

Settings of the display in the digital mirror mode.



1. Press the menu button (a). The icons will be displayed.

Icons	Settings
	Select to adjust the brightness of the display.
	Select to adjust the display up/down.

2. Press the menu button repeatedly and select the item you want to adjust.
3. Press the button (b) or button (c) to change the setting.

The icons will disappear if the button is not operated for about 5 seconds or more.

* If the brightness of the Digital Center Mirror is set too high, it may cause eye strain.

Adjust the Digital Center Mirror to an appropriate brightness. If your eyes become tired, change to optical mirror mode.

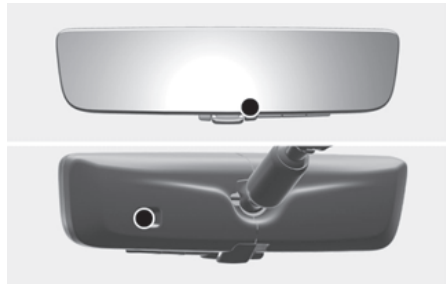

To prevent the light sensors from malfunctioning

To prevent the light sensors from malfunctioning, do not touch or cover them.

Digital mirror mode operating condition

The Engine Start/Stop button is in the ON position.

When the Engine Start/Stop button is changed from ON position to OFF or ACC position, the image will be disappeared.

When using the Digital Center Mirror in digital mirror mode

- When the liftgate is open, the Digital Center Mirror image may not display properly. Before driving, make sure the liftgate is closed.
- If the display is difficult to see due to reflected light, close the sunshade for the sunroof (if equipped).
- Any of the following conditions may occur when driving in the dark, such as at night. None of them indicates that the malfunction has occurred.
 - Colors of objects in the displayed image may differ their actual color.
 - Depending on your physical condition or age, it may take longer than usual to focus on the displayed image. In this case, change to optical mirror mode.
 - Do not let passengers stare at the displayed image when the vehicle is being driven, as doing so may cause motion sickness.

When the system malfunctions

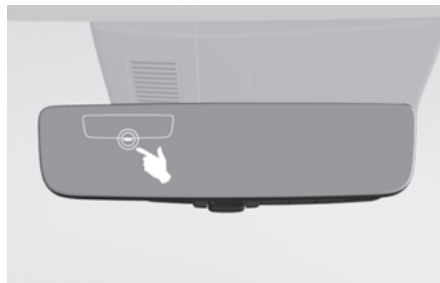

If the symbol shown in the illustration is displayed when using the Digital Center Mirror in digital mirror mode, the system may be malfunctioning. The symbol will disappear in a few seconds.

Operate the lever, change to optical mirror mode and have the vehicle inspected by an authorized HYUNDAI dealer.

CAUTION



To prevent the Digital Center Mirror from malfunctioning

- Do not use detergents, such as thinner, benzene, and alcohol to clean the mirror. They may discolor, deteriorate or damage the mirror surface.
- Do not remove, disassemble or modify the mirror and camera.
- Do not allow an organic solvent, vehicle wax, window cleaner or glass coating to adhere to the camera. If this happens, wipe it off as soon as possible.

Convenience Features

- When cleaning the camera lens, wipe the camera lens with a damp soft cloth.
 - Do not strongly rub the camera lens, as it may be scratched and will not be able to transmit a clear image.
 - Do not subject the camera to a strong impact as this could cause a malfunction. If this happens, have the vehicle inspected by an authorized HYUNDAI dealer as soon as possible.
 - Operating the system at the ON position while the engine is not running would cause discharging of the battery.
 - Do not attach an antenna of wireless device near the Digital Center Mirror. Electric wave from wireless device may cause disturbed image in Digital Center Mirror.
 - Do not push buttons excessively or operate the lever roughly may cause a system failure or the Digital Center Mirror itself to drop.
 - Never rotate the body of Digital Center Mirror by 90° or more. It may damage the Digital Center Mirror. Do not apply strong shocks to the body of Digital Center Mirror. It may cause a system failure.
 - If it is difficult to see the Digital Center Mirror display screen because of a strong external light or foreign substances on the lens surface, switch the mode to the conventional rearview mirror mode.
-

Digital Center Mirror error icon and solution

Symptom	Likely cause	Solution
<p>If the high temp icon is displayed on the display right side.</p> 	<p>The Digital Center Mirror is extremely hot. (The display will gradually become more dim. If the temperature continues to increase, the Digital Center Mirror will turn off.)</p>	<p>Reducing the cabin temperature is recommended to reduce the temperature of the mirror. (The icon will disappear when the mirror becomes cool.) If the icon does not disappear even though the mirror is cool, have the vehicle inspected by an authorized HYUNDAI dealer.</p>
<p>If the display icon has been switched to which is the display error icon.</p> 	<p>The system may be malfunctioning</p>	<p>Change to optical mirror mode and have the vehicle inspected by an authorized HYUNDAI dealer.</p>

Electrochromic mirror (ECM) with HomeLink® system

+ if equipped

Your vehicle may be equipped with a Gentex Automatic-Dimming Mirror with an Integrated HomeLink® Wireless Control System.

During nighttime driving, this feature will automatically detect and reduce rearview mirror glare. The HomeLink® Universal Transceiver allows you to activate your garage door(s), electric gate, home lighting, etc.



- (1) HomeLink Channel 1
- (2) HomeLink Channel 2
- (3) HomeLink Channel 3
- (4) Garage Door Opener Status Indicator: Closing or Closed
- (5) HomeLink Operation Indicator
- (6) Garage Door Opener Status Indicator: Opening or Opened
- (7) HomeLink User Interface Indicator

Automatic-Dimming Night Vision Safety™ (NVS®) Mirror

+ if equipped

The NVS® Mirror automatically reduces glare by monitoring light levels in the front and the rear of the vehicle. Any object that obstructs either light sensor will degrade the automatic dimming control feature.

For more information regarding NVS® mirrors and other applications, please refer to the Gentex website:

www.gentex.com

Your mirror will automatically dim upon detecting glare from the vehicles traveling behind you.

The mirror defaults to the ON position each time the vehicle is started.

Integrated HomeLink® Wireless Control System

The HomeLink® Wireless Control System provides a convenient way to replace up to three hand-held radio-frequency transmitters used to activate compatible devices such as gate operators, garage door openers, entry door locks, security systems, and home lighting.

NOTICE

HomeLink® operates while the Engine Start/Stop button is in the ACC or ON position for safety reasons. It is to prevent unintentional security problems from happening when the vehicle is parked outside the garage.

WARNING

Before programming HomeLink® to a garage door opener or gate operator, make sure people and objects are out of the way of the device to prevent potential harm or damage. Do not use the HomeLink® with any garage door opener that lacks the safety stop and reverse features required by U.S. federal safety standards (this includes any garage door opener model manufactured before April 1, 1982). A garage door that cannot detect an object-signaling the door to stop and reverse-does not meet current U.S. federal safety standards. Using a garage door opener without these features increases the risk of serious injury or death.

For more information, contact HomeLink® at www.homelink.com, or call Home-Link customer support at 1-800-355-3515.

It is also recommended that a new battery be replaced in the hand-held transmitter of the device being trained to HomeLink® for quicker training and accurate transmission of the radio frequency.

1. Programming HomeLink®

The following steps show how to program HomeLink. If you have any questions or are having difficulty programming your HomeLink buttons, refer to the HomeLink website or call the HomeLink customer support toll-free number. Do this, before going back to the dealer who sold you the vehicle.

- Visit the HomeLink website at: www.homelink.com. Then at the top of the page, choose your vehicle make. Then watch the You Tube video, and/or access additional website information.
- If you choose to access the website via your cell phone, scan the QR code.



- Or, call HomeLink customer support at 1-800-355-3515 (Please have the vehicle make/model AND the opener device make/model readily available.)

1) Programming Preparation



1. When programming a garage door opener, it is advised to park the vehicle outside of the garage.
2. It is recommended that a new battery be placed in the hand-held transmitter of the device being programmed to HomeLink for quicker training and accurate transmission of the radio-frequency signal.

3. Press the Engine Start/Stop button to the ACC (Accessory) position for programming of HomeLink.

2) Programming a New HomeLink®



1. Press and release the HomeLink button (1), (2) or (3), you would like to program. The HomeLink indicator light (7) will flash orange slowly (if not, perform the steps of "Erasing HomeLink Buttons" section, and start over).



2. Position the garage door opener remote 1-3 in. (2-8 cm) away from the HomeLink buttons.
3. While the HomeLink indicator light (7) is flashing orange, press and hold the handheld remote button. Continue pressing the handheld remote button until the HomeLink indicator light (7) light changes from orange to green. You may now release the handheld remote button.
4. Wait until your garage door comes to a complete stop, regardless of position, before proceeding to the next steps.

5. Press and release the HomeLink button you are programming and observe the indicator light.

- If the indicator light remains solid green, your device should operate when the HomeLink button is pressed. At this point, if your device operates, programming is complete.
- If the indicator light rapidly flashes green, firmly press, hold for two seconds and release the HomeLink button up to three times in a row slowly to complete the programming process. Do not press the HomeLink button rapidly. At this point if your device operates, programming is complete. If the device does not operate, continue with step 6.

6. At the garage door opener motor, (security gate motor, etc.) locate the 'Learn', 'Smart', 'Set' or 'Program' button. This can usually be found where the hanging antenna wire is attached to the motor-head unit (see the device's manual to identify this button). The name and color of the button may vary by manufacturer.

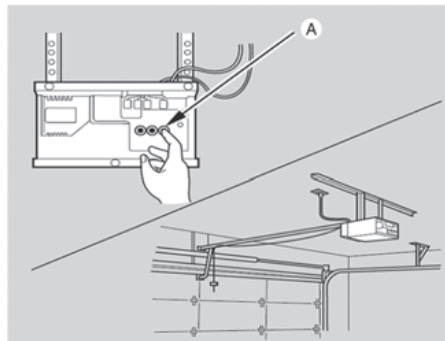

[A] Learn button

- A ladder and/or second person may simplify the following steps.
7. Firmly press and release the 'Learn', 'Smart', 'Set' or 'Program' button. You now have up to 30 seconds in which to complete the next step.

8. Return to the vehicle and firmly press, hold for two seconds and release, the HomeLink button up to three times in a row slowly. Do not press the HomeLink button rapidly. As soon as you see the garage door start to move, stop pressing any buttons until a few seconds after the garage door has come to a complete stop, regardless of position. At this point, programming is complete and your device should operate when the HomeLink button is pressed and released.

3) Two-Way Communication Programming (For select garage door openers)

If your garage door opener has the 'myQ' logo on its side, your opener likely has Two-Way Communication capability. HomeLink has the capability to establish Two-Way Communication with your garage door opener. HomeLink can receive and display "closing" or "opening" status messages from compatible garage door openers. At any time, Home-Link can also recall and display the last recorded status communicated by the garage door opener to indicate your garage door being "closed" or "opened".

To check if your garage door opener is compatible with this feature, refer to www.homelink.com/compatible/Two-way-Communication. If your garage door opener has this functionality, AND the Two-Way Communication indicators (4), (6) in the mirror appear while the garage door is opening/closing, then no further steps are needed. Two-Way Communication Programming is already complete. However, if your garage door opener has this functionality, AND the Two-Way Communication indicators (4), (6) in the mirror DO NOT appear while the garage door is opening/closing, use the following instructions to enable this functionality.

1. In your vehicle, press and hold the programmed HomeLink button for 2 seconds, then release. Confirm that the garage door is moving. AFTER it stops, you will have one minute to complete the following steps:
 - A ladder and/or second person may simplify the following steps.
2. On your garage door opener in your garage, locate the 'Learn' button (usually near where the hanging antenna wire is attached to the garage door opener). If there is difficulty locating this button, reference the device's owner's manual.
3. Press and release the 'Learn' button.
4. A light on your garage door opener may flash, and your Two-Way Communication indicators (4), (6) in your vehicle may flash, confirming completion of the process.
5. Return to the vehicle and firmly press and release the programmed HomeLink button to activate your garage door. The Two-Way Communication indicators (4), (6) flash in orange when the door is moving. Do not make any additional button presses until AFTER the garage door has come to a complete stop.
6. Your Two-Way Communication programming is now complete.

i Information

If your garage door opener has Two-Way Communication functionality, it is possible for HomeLink to stop functioning the garage door shortly after initial programming, IF the Two-Way Communication Programming wasn't properly completed. This usually happens after the first 10 times a programmed HomeLink button is pressed. If you experience this, completing the "Programming a New HomeLink Button" and "Two-Way Communication Programming" will restore door operation.

4) Canadian Programming

Canadian radio-frequency laws require transmitter remote signals to "time-out" (or quit) after a couple seconds of transmission, which may not be long enough for HomeLink to pick up the signal during programming.

If you live in Canada or you are having difficulties programming a gate operator or garage door opener by using the programming procedures, replace "Programming a New HomeLink Button" step 3 with the following:

While the HomeLink indicator light (7) is flashing orange, press and release ("cycle") your device's handheld remote every two seconds until the HomeLink indicator light (7) changes from orange to green. You may now release the handheld remote button. Then proceed with "Programming a New HomeLink Button" step 4.

2. Operating HomeLink®

1) Operating HomeLink®



1. Press and release the desired programmed HomeLink button (1, 2 or 3).

i Information

The HomeLink indicator (7) should light green, solid or flashing, and your programmed device should operate.

If your device does not operate, the HomeLink programming was not successful, and you'll need to reprogram the button.

2) Two-Way Communication Display Behavior



1. Press and release one of the programmed HomeLink buttons (1, 2 or 3).

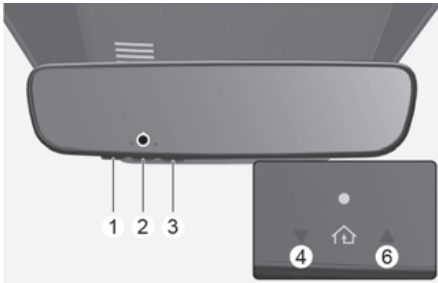

2. The indicator (4) and (6) operates as below, if your garage door opener has Two-Way Communication functionality.

- If the indicator (4) flashes in Orange, it indicates that the garage door is "Closing".
- The indicator (4) turns solid green once the garage door has closed.
- If the indicator (6) flashes in Orange, it indicates that the garage door is "Opening".
- The indicator (6) turns solid green once the garage door has fully opened.
- If the indicator (4) or (6) does not turn to green, it indicates that the last status of garage door was not received properly. The HomeLink mirror tries to receive the last known status of the garage door for a few seconds.

3) Recalling Garage Door Status

HomeLink mirror with Two-Way Communication provides a way to view the last stored message from the garage door opener. In order to recall the last known status of the last activated device, press the buttons "1 and 2" or "2 and 3" simultaneously.

- If the indicator (4) appears solid Green, it indicates that the last activated device was "closed" properly.
- If the indicator (6) appears solid Green, it indicates that the last activated device was "open" properly.

3. Erasing HomeLink® Buttons

1) Erasing and Reprogramming a Single HomeLink® Button:

1. Press and hold the desired HomeLink button you want to re-program. DO NOT release the button.
2. The HomeLink indicator light (7) will illuminate solid green. Release the button as soon as the HomeLink indicator light (7) begins to flash orange, usually about 20 seconds.
3. Proceed with the steps in the "Programming a New HomeLink Button" section.

i Information

If you do not complete the re-programming of a new device to the button, it will revert to the previously stored programming.

2) The following instructions will erase ALL HomeLink® programming from ALL buttons:



1. Press and hold the buttons (1) and (3) simultaneously
2. The HomeLink indicator light (7) will illuminate solid Orange for about 10 seconds
3. Release the buttons once the HomeLink indicator light (7) changes to Green and flashes rapidly
4. Now all three HomeLink buttons (1), (2) and (3) are cleared of any programming

i Information

HomeLink® and the HomeLink® House logo are registered trademarks of Gentex Corporation.

The myQ logo is a registered trademark of The Chamberlain Group, Inc.

FCC (USA) and ISED (Canada)

This device complies with FCC rules part 15 and Innovation, Science, and Economic Development Canada RSS-210. Operation is subject to the following two conditions: (1) This device may not cause harmful interference, and (2) This device must accept any interference that may be received including interference that may cause undesired operation. **WARNING:** The transmitter has been tested and complies with FCC and ISED rules. Changes or modifications not expressly approved by the party responsible for compliance could void the user's authority to operate the device.

This equipment complies with FCC and ISED radiation exposure limits set forth for an uncontrolled environment. End Users must follow the specific operating instructions for satisfying RF exposure compliance. This transmitter must be at least 20cm from the user and must not be co-located or operating in conjunction with any other antenna or transmitter.

FCC (Etats-Unis) et ISED (Canada)

Cet appareil est conforme aux règlements de la FCC, section 15, et au CNR-210 d'Innovation, Sciences et Développement économique Canada. Le fonctionnement est assujéti aux deux conditions suivantes: (1) cet appareil ne doit pas causer d'interférences nuisibles et (2) cet appareil doit accepter toute interférence reçue, y compris celle qui pourrait entraîner un dysfonctionnement. **MISE EN GARDE:** L'émetteur a subi des tests et est conforme aux règlements de la FCC et d'ISDE. Les changements ou modifications non approuvés explicitement par la partie responsable de la conformité pourraient rendre caduque l'autorisation de l'utilisateur de se servir du dispositif.

Cet appareil est conforme aux limites d'exposition aux radiations de la FCC et d'ISDE établies pour un environnement non contrôlé. Les utilisateurs finaux doivent respecter les instructions d'utilisation spécifiques pour satisfaire aux exigences de conformité aux expositions de RF. L'émetteur doit se trouver à 20 cm au minimum de l'utilisateur et ne doit pas être situé au même endroit que tout autre émetteur ou antenne ni fonctionner avec un autre émetteur ou antenne.

Mejico

La operación de este equipo está sujeta a las siguientes dos condiciones: (1) es posible que este equipo o dispositivo pueda no causar interferencia dañina, y (2) este dispositivo o dispositivos deben aceptar cualquier interferencia, que incluye la interferencia que puede causar su operación no deseada.

HomeLink 5 Programing Flow Chart

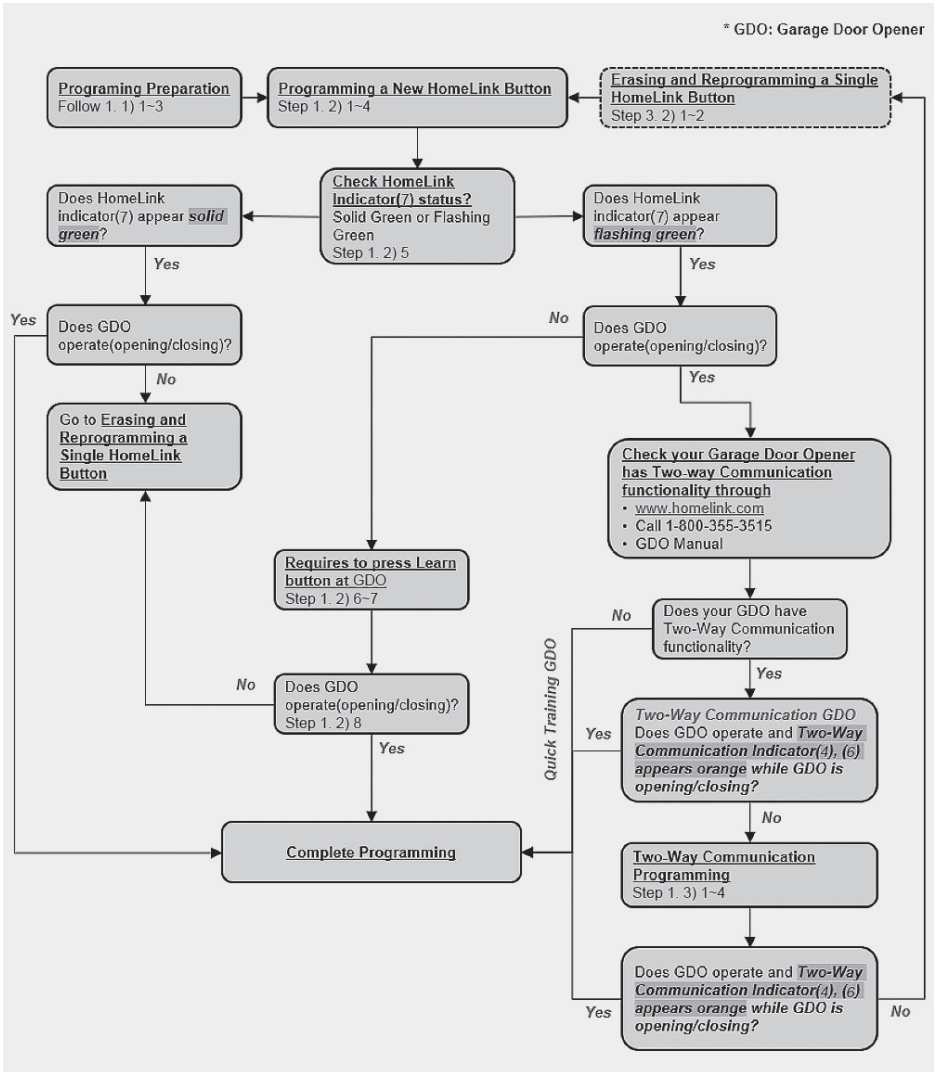

Side view mirrors



Your vehicle is equipped with both left-hand and right-hand side view mirrors. The mirrors can be adjusted remotely with the mirror adjustment control switch. Adjust the side view mirrors to your desired position before driving.

The side view mirrors can be folded manually to help prevent damage when going through an automatic car wash or when passing through a narrow street.

WARNING

The right side view mirror is convex. Objects in mirror are closer than they appear.

Use the inside rearview mirror or turn your head and look to determine the actual distance of other vehicles prior to changing lanes.

WARNING

Do not adjust or fold the side view mirrors while driving. This may cause loss of vehicle control resulting in a collision.

NOTICE

- Do not scrape ice off the mirror face. This may damage the surface of the glass.
- If the mirror is jammed with ice, do not adjust the mirror by force. Use an approved de-icer (not radiator antifreeze) spray, or a sponge or soft cloth with very warm water, or move the vehicle to a warm place and allow the ice to melt.
- Do not clean the mirror with harsh abrasives, fuel, or other petroleum based cleaning products.

Adjusting the side view mirrors



1. Press the switch (1) either to the L (left side) or R (right side) to select the side view mirror you want to adjust.
2. Use the mirror adjustment control (2) to position the selected mirror up, down, left, or right.
3. After adjustment, Press the switch (1) to the middle to prevent unintended adjustment.

NOTICE

- The mirrors stop moving when they reach the maximum adjusting angles, but the motor continues to operate while the switch is pressed. Do not press the switch longer than necessary, because this can damage the motor.
- Do not adjust the side view mirrors by force to prevent damage to the motor.

Folding the side view mirror

Folding button

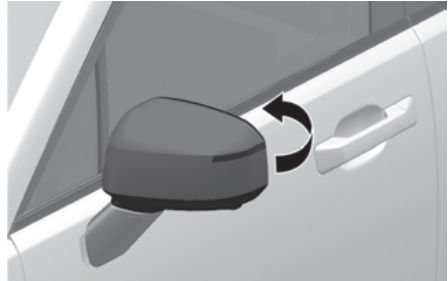

To fold the side view mirror, grasp the housing of the mirror and then fold it toward the rear of the vehicle.

Folding button

 If equipped



The side view mirrors can be folded or unfolded by pressing the button.

Infotainment system

 if equipped

- Enable on door unlock
If **Setup > Vehicle > Lights > Welcome Mirror/Light > On door unlock** is selected from the Settings menu in the infotainment system:
 - The mirror folds or unfolds when the door is locked or unlocked using the smart key.
 - The mirror folds or unfolds when the door is locked or unlocked by the touching the touch sensor on the outside door handle.
- Enable on driver approach
If **Setup > Vehicle > Lights > Welcome Mirror/Light > On driver approach** is selected from the Settings menu in the infotainment system, the mirror unfolds when the vehicle is approached with the smart key in possession.

Information

- The infotainment system may change after software updates. For more information, refer to the user's manual provided in the infotainment system and the quick reference guide.
- For your safety, the side view mirrors cannot be folded automatically when driving at a speed of 9 mph (15 km/h) or faster.

NOTICE

To prevent unnecessary battery discharge, do not adjust the mirrors longer than necessary when the engine is not running.

NOTICE

Do not fold the electric type side view mirror by hand. It may cause motor failure.

Reverse parking aid

 If equipped



When the gear is shifted to the R (Reverse) position, the side view mirrors rotate downwards to aid with driving in reverse.

The state of the side view mirror switch (1) determines whether or not the mirrors move.

How it works

- Left/Right : When the switch is pressed to L or R, both side view mirrors move.
- Neutral : When both L or R is not pressed, the side view mirrors does not move.

The side view mirrors automatically revert to their original positions if any of the following occur:

- The Engine Start/Stop button is moved to either the OFF position or the ACC position.
- The gear is shifted to any position except R (Reverse).
- The side view mirror adjustment button is not selected.

Reverse parking aid user settings mode

You may change the angle of the side view mirror if it is difficult to see the rearview with the basic downward mirror angle provided when reversing.

When the vehicle is first delivered, the set downward angle of the left and right side view mirror are different to ensure driver visibility.

1. Make sure the vehicle is stopped.
2. Depress the brake pedal and shift the gear to R (Reverse). When L or R switch is pressed, both side view mirrors move downward to the basic set position.
3. Press the L or R switch to select the side view mirror you want to adjust. Then press "▼, ▲, ◀, ▶" switch to adjust the side view mirror to the desired angle.
4. After adjusting the angle to save the adjusted side view mirror angle, shift the gear to another position other than R (Reverse), or change the L and R switch to the neutral position (L and R switch is not pressed).
5. Set the other side view mirror following the above procedure 1 to 4.

Resetting reverse parking aid user settings mode

To change the side view mirror angle back to the basic angle, shift the gear to R (Reverse), and adjust the mirror angle higher than when the gear is in P (Park), N (Neutral) and D (Drive).

NOTICE

When changing the angle of both side view mirrors, it is recommended to change the angle one side at a time following the procedure 1 to 4.

Windows

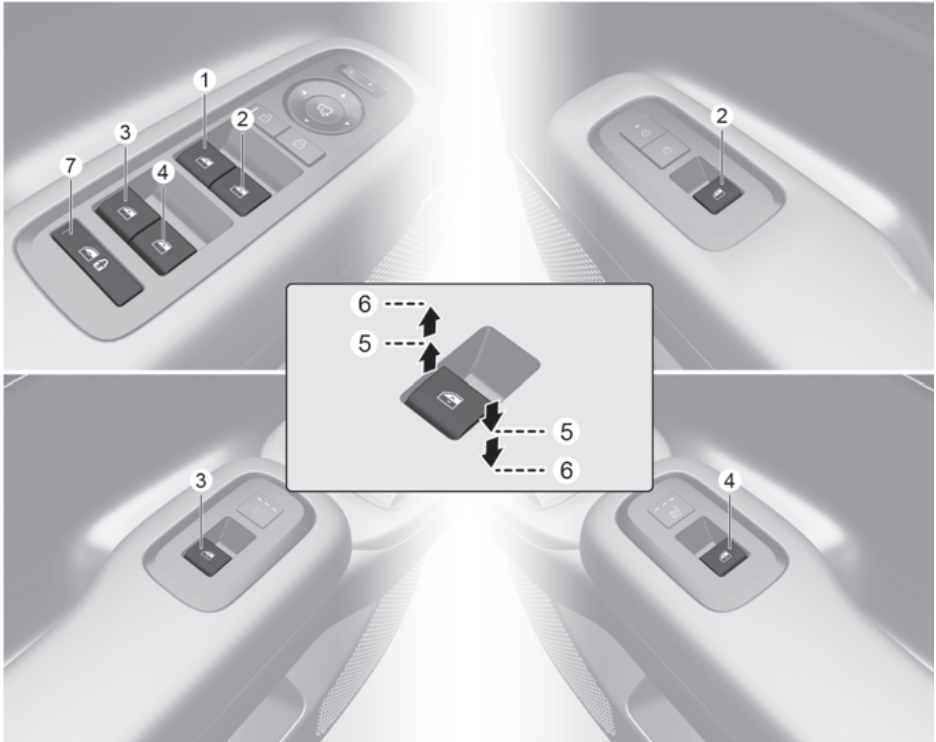

- (1) Driver's door open/close window switch
- (2) Front passenger's door open/close window switch
- (3) Rear door (left) open/close window switch
- (4) Rear door (right) open/close window switch
- (5) Window opening and closing
- (6) Automatic power window (if equipped)
- (7) Power window lock button/Electronic child safety lock

Power windows

The Engine Start/Stop button must be in the ON position to be able to raise or lower the windows. Each door has a Power Window switch to control the door's window. The driver has a Power Window Lock button that can block the operation of rear passenger windows. The power windows will operate for about 3 minutes after the Engine Start/Stop button is turned OFF or if the Engine Start/Stop button is placed in the ACC position, as long as the front doors remain closed.

If the front doors are opened, the battery power is turned OFF and the Power Windows do not operate.

Window opening and closing

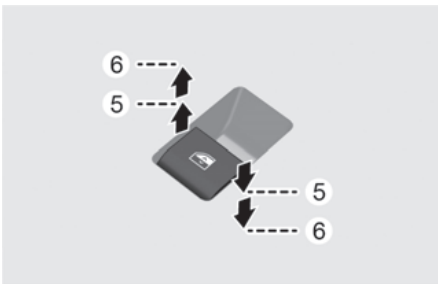

To open:

Press the window switch down to the first detent position (5). Release the switch when you want the window to stop.

To close:

Pull the window switch up to the first detent position (5). Release the window switch when you want the window to stop.

Auto up/down window

 If equipped

Pressing or pulling up the power window switch momentarily to the second detent position (6) completely lowers or lifts the window even when the switch is released. To stop the window at the desired position while the window is operating, pull up or press down and release the switch.

WARNING

- Do not leave the vehicle running and the key in your vehicle with unsupervised children. Unattended children could operate the window, which could result in serious injury.
- Do not extend your head, arms or any other body parts or objects outside the window while driving to avoid serious injury.

Resetting the power windows

If the power windows do not operate normally, the automatic power window system must be reset as follows:

1. Press the Engine Start/Stop button to the ON position.
2. Close the window and continue pulling up on the power window switch for at least one second.

If the power windows do not operate properly after resetting, contact an authorized HYUNDAI dealer.

Automatic reversal

+ if equipped

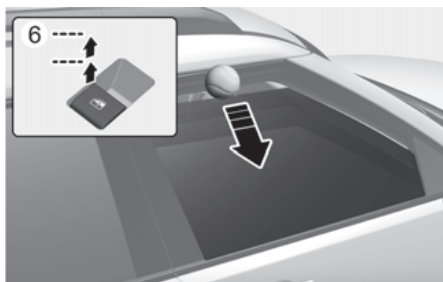

If a window senses any obstacle while it is closing automatically, it stops and lowers approximately 12 in. (30 cm) to allow the object to be cleared.

If the window detects any resistance while the power window switch is pulled up continuously, the window stops upward movement and then lowers approximately 1 in. (2.5 cm).

If the power window switch is pulled up continuously again within 5 seconds after the window is lowered by the automatic window reverse feature, the automatic window reverse does not operate.

i Information

The automatic reverse feature is active only when the "Auto Up" feature is used by fully pulling up the switch to the second detent.

NOTICE

Do not install any accessories on the windows. The automatic reverse feature may not operate.

! WARNING

Make sure body parts or other objects are safely out of the way before closing the windows to avoid injuries or vehicle damage.

Objects less than 0.16 in. (4 mm) in diameter caught between the window glass and the upper window channel may not be detected by the automatic reverse window and the window does not stop and reverse direction.

Power window lock button



The driver can disable the power window switches on the rear passenger doors by pressing the power window lock button.

When the power window lock button is pressed:

- The driver's master control can operate all the power windows.
- The front passenger's control can operate the front passenger's power window.
- The rear passenger's control cannot operate the rear passengers' power window.

WARNING

Do not allow children to play with the power windows. Keep the driver's door power window lock button in the LOCK position. Serious injury or death may result from unintentional window operation by a child.

NOTICE

- To prevent possible damage to the power window system, do not open or close two windows or more at the same time. This also ensures the longevity of the fuse.
 - Never try to operate the main switch on the driver's door and the individual door window switch in opposite directions at the same time. If this is done, the window stops and cannot be opened or closed.
-

Remote window opening feature

 If equipped



Press and hold the Door Unlock button (1) on the smart key for more than 3 seconds and the windows move down after the doors are unlocked. Window movement stops when you release the door unlock button.

NOTICE

Do not leave the windows down when leaving the vehicle to prevent theft or damage from water entering the vehicle.

Information

- The remote window opening feature operates only with the Safety Power Windows equipped.
 - The remote window opening feature may abruptly stop when you move away from your vehicle during operation. Stay in close proximity from your vehicle, while monitoring the window movement.
 - The doors unlock when the windows are opened using the remote window open feature.
-

Sunroof

 if equipped

If your vehicle is equipped with a sunroof, you can slide or tilt your sunroof with the sunroof switch located on the overhead console.



The sunroof can only be operated when the Engine Start/Stop button is in the ON or START position.

The sunroof can be operated for approximately 3 minutes after the Engine Start/Stop button is in the ACC or OFF position. However, if the front door is open, the sunroof cannot be operated even within the 3 minute period.

WARNING

- Adjust the sunroof or sunshade when your vehicle stops. This could result in loss of control and a collision that may cause injury, or property damage.
- Do not leave the engine running and the key in your vehicle with unsupervised children. Unattended children could operate the sunroof, which could result in serious injury.
- Do not sit on the top of the vehicle. It may cause injury or vehicle damage.

NOTICE

Do not operate the sunroof when roof bars are installed on the vehicle or when there is luggage on the roof.

Sunshade

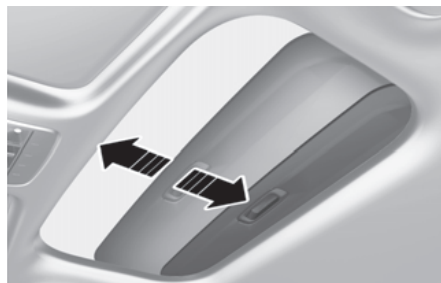

Use the sunshade to block direct sunlight coming through the sunroof glass.

Open or close the sunshade by hand.

Information

The sunshade opens automatically when the sunroof glass is opened, but the sunshade does not close automatically when the sunroof glass is closed. Also, only the sunshade cannot be closed when the sunroof glass is opened.

NOTICE

Do not pull the sunshade up or down, or apply excessive force as such action may damage the sunshade or cause it to malfunction.

Tilt open/close

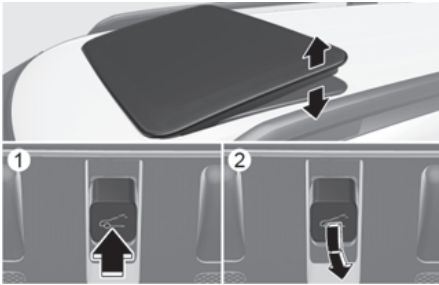

(1) Tilt open

(2) Tilt close

- Push the sunroof switch upward, the sunroof glass tilts open.
- Push the sunroof switch forward when the sunroof glass is tilt opened, the sunroof glass closes.

Slide open/close

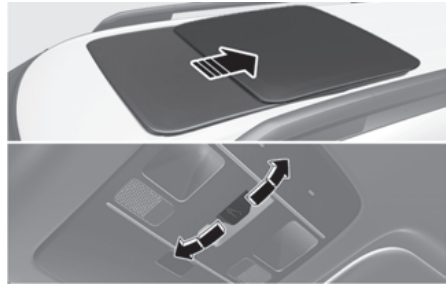

- Push the sunroof switch rearward, the sunshade and sunroof glass slide open. Push the sunroof switch forward, only the sunroof glass closes.
- Push the sunroof switch forward or rearward to the first detent position, the sunroof glass moves until the switch is released.
- Push the sunroof switch forward or rearward to the second detent position, the sunroof glass operates automatically (auto slide feature). To stop the sunroof movement at any point, push the sunroof switch in any direction.
- The sunroof glass stops halfway (first detent position) before it is fully opened. To fully open the sunroof glass, push the sunroof switch rearward once more.
At this time, the sunroof glass opens only while the switch is pushed.

i Information

To reduce wind noise while driving, we recommend that you drive at the recommended position (first detent position) before the maximum slide open position.

Automatic reversal

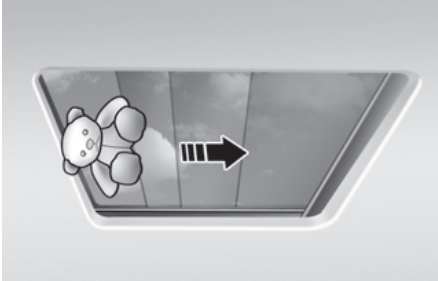

If the sunroof glass senses any obstacle while it is closing automatically, it will reverse direction then stop at a certain position.

The auto reverse function may not work if an object thin or soft is caught between the sliding sunroof glass and sunroof sash.

WARNING

- Make sure heads, hands, arms or any other body parts or objects are out of the way before operating the sunroof. Body parts or objects may get caught causing injuries or vehicle damage.
- Never deliberately use your body parts to test the automatic reversal function. The sunroof glass may reverse direction, but there is a risk of injury.

NOTICE

- Do not continue to push the sunroof switch after the sunroof is fully opened, closed, or tilted. Damage to the sunroof motor could occur.
- Continuous operations such as slide open/close, tilt open/close, etc. may cause the motor or sunroof system to malfunction.
- Regularly remove any accumulated dust on the sunroof rail.
- Dust accumulated between the sunroof and roof panel can make noise. Open the sunroof and remove dust regularly using a clean cloth.
- Do not try to open the sunroof when the temperature is below freezing or when the sunroof is covered with snow or ice. The sunroof may not work properly and may break if opened by force.
- Do not open or drive with the sunroof glass open immediately after rain or washing the vehicle. Water may wet the interior of the vehicle.
- Do not extend any luggage outside the sunroof while driving. Vehicle damage may occur if the vehicle suddenly stops.

WARNING

Do not extend your head, arms, body parts or objects outside the sunroof while driving. Injuries may occur if the vehicle suddenly stops.

Resetting the sunroof

Front

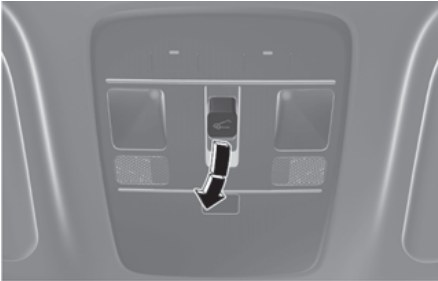

Rear



In some circumstances resetting the sunroof operation may need to be performed. Some instances where resetting the sunroof may be required include:

- When the sunroof fuse is replaced
- If the sunroof one-touch AUTO OPEN/CLOSE operation is not functioning properly

Sunroof resetting procedure:

1. It is recommended to perform the reset procedure with the vehicle engine running. Start the vehicle in P (Park).
2. Make sure the sunroof glass is in the fully closed position. If the sunroof glass is open, push the switch forward until the sunroof glass is fully closed.
3. Release the switch when the sunroof glass is fully closed.
4. Push the switch forward until the sunroof glass moves slightly. Then release the switch.
5. Once again push and hold the sunroof switch forward until the sunroof glass slides open and close. Do not release the switch until the operation is completed.

If you release the switch during operation, start the procedure again from step 2.

i Information

If the sunroof does not reset when the vehicle battery is disconnected or discharged, or the sunroof fuse is blown, the sunroof may not operate normally.

Sunroof open warning

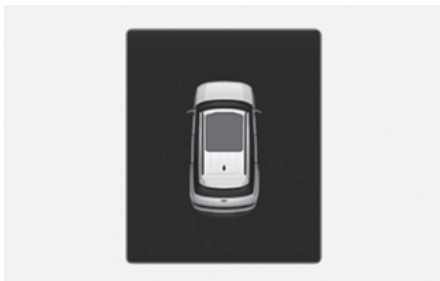

If the driver turns off the engine when the sunroof is not fully closed, the warning chime will sound for several seconds and the sunroof open warning will appear on the cluster display.

Close the sunroof securely when leaving your vehicle.

CAUTION

Make sure the sunroof is closed fully when leaving your vehicle. If the sunroof is left open, rain or snow may wet the interior of the vehicle.

Also, leaving the sunroof open when the vehicle is unattended may invite theft.

Dual wide sunroof

 if equipped

If your vehicle is equipped with a sunroof, you can slide or tilt your sunroof with the sunroof switch located on the overhead console.

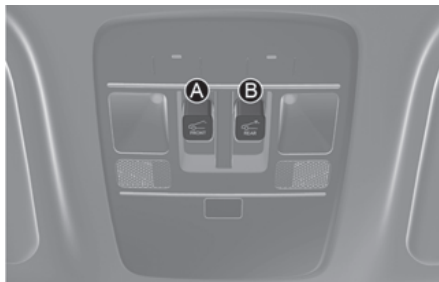

[A] Front
[B] Rear

The sunroof can only be operated when the Engine Start/Stop button is in the ON or START position.

The sunroof can be operated for approximately 3 minutes after the Engine Start/Stop button is in the ACC or OFF position. However, if the front door is open, the sunroof cannot be operated even within the 3 minute period.

WARNING

- Adjust the sunroof or sunshade when your vehicle stops. This could result in loss of control and a collision that may cause injury, or property damage.
- Do not leave the engine running and the key in your vehicle with unsupervised children. Unattended children could operate the sunroof, which could result in serious injury.
- Do not sit on the top of the vehicle. It may cause injury or vehicle damage.

NOTICE

Do not operate the sunroof when roof bars are installed on the vehicle or when there is luggage on the roof.

Sunshade (Front)/Power sunshade (Rear)

Use the power sunshade to block direct sunlight coming through the sunroof glass.

Front



Open or close the sunshade by hand.

i Information

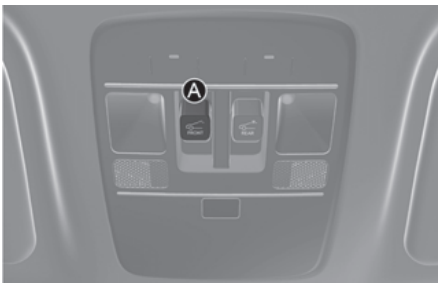

The sunshade opens automatically when the sunroof glass is opened by pushing the sunroof switch (A) rearward, but the sunshade does not close automatically when the sunroof glass is closed. Also, only the sunshade cannot be closed when the sunroof glass is opened.

NOTICE

Do not pull the sunshade up or down, or apply excessive force as such action may damage the sunshade or cause it to malfunction.

Rear

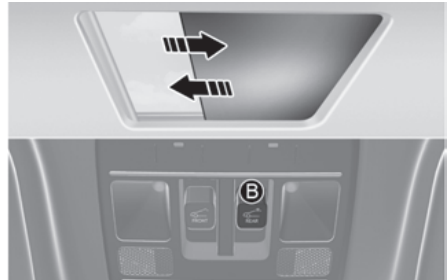

Push the power sunshade open switch (B), the power sunshade automatically slides open.

Push the power sunshade close switch (B), the power sunshade automatically closes.

NOTICE

Do not pull or push the power sunshade by hand as such action may damage the power sunshade or cause it to malfunction.

i Information

Wrinkles formed on the power sunshade are normal due to material characteristic.

Tilt open/close (Front)

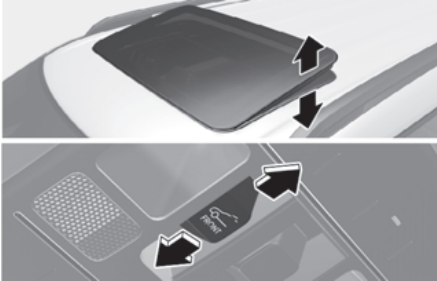

- (1) Tilt open
- (2) Tilt close

- Push the sunroof switch upward, the sunroof glass tilts open.
- Push the sunroof switch forward when the sunroof glass is tilt opened, the sunroof glass closes.

To stop the sunroof movement at any point, push the sunroof switch in any direction.

Slide open/close (Front)

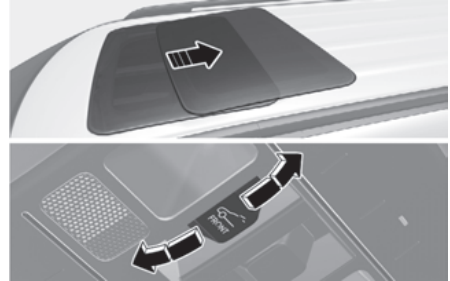

- Push the sunroof switch rearward, the sunshade and sunroof glass slide open. Push the sunroof switch forward, only the sunroof glass closes.
- Push the sunroof switch forward or rearward to the first detent position, the sunroof glass moves until the switch is released.
- Push the sunroof switch forward or rearward to the second detent position, the sunroof glass operates automatically (auto slide feature). To stop the sunroof movement at any point, push the sunroof switch in any direction.

Automatic reversal

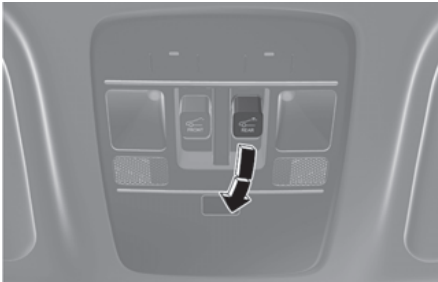
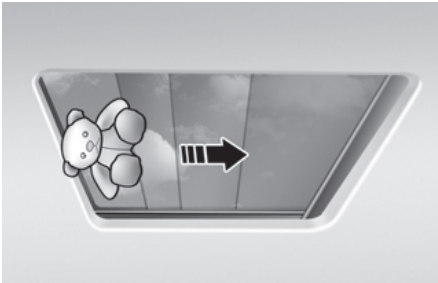

If the power sunshade or sunroof glass senses any obstacle while it is closing automatically, it will reverse direction then stop at a certain position.

The auto reverse function may not work if an object thin or soft is caught between the sliding power sunshade or sunroof glass and sunroof sash.

WARNING

- Make sure heads, hands, arms or any other body parts or objects are out of the way before operating the sunroof. Body parts or objects may get caught causing injuries or vehicle damage.
- Never deliberately use your body parts to test the automatic reversal function. The power sunshade or sunroof glass may reverse direction, but there is a risk of injury.

NOTICE

- Do not continue to push the sunroof switch after the sunroof is fully opened, closed, or tilted. Damage to the sunroof motor could occur.
- Continuous operations such as slide open/close, tilt open/close, etc. may cause the motor or sunroof system to malfunction.
- Regularly remove any accumulated dust on the sunroof rail.
- Dust accumulated between the sunroof and roof panel can make noise. Open the sunroof and remove dust regularly using a clean cloth.
- Do not try to open the sunroof when the temperature is below freezing or when the sunroof is covered with snow or ice. The sunroof may not work properly and may break if opened by force.
- Do not open or drive with the sunroof glass open immediately after rain or washing the vehicle. Water may wet the interior of the vehicle.
- Do not extend any luggage outside the sunroof while driving. Vehicle damage may occur if the vehicle suddenly stops.

WARNING

Do not extend your head, arms, body parts or objects outside the sunroof while driving. Injuries may occur if the vehicle suddenly stops.

Resetting the sunroof

Front

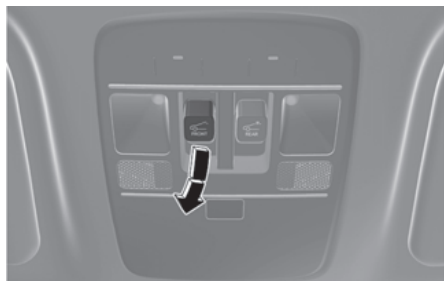

Rear



In some circumstances resetting the sunroof operation may need to be performed. Some instances where resetting the sunroof may be required include:

- When the sunroof fuse is replaced
- If the sunroof one-touch AUTO OPEN/CLOSE operation is not functioning properly

Sunroof resetting procedure:

1. It is recommended to perform the reset procedure with the vehicle engine running. Start the vehicle in P (Park).
2. Make sure the power sunshade or sunroof glass is in the fully closed position. If the power sunshade or sunroof glass is open, push the switch forward until the power sunshade and sunroof glass is fully closed.
3. Release the switch when the power sunshade or sunroof glass is fully closed.

4. Push the switch forward until the power sunshade or sunroof glass moves slightly. Then release the switch.
5. Once again push and hold the sunroof switch forward until the power sunshade or sunroof glass slides open and close. Do not release the switch until the operation is completed.

If you release the switch during operation, start the procedure again from step 2.

i Information

If the sunroof does not reset when the vehicle battery is disconnected or discharged, or the sunroof fuse is blown, the sunroof may not operate normally.

Sunroof open warning

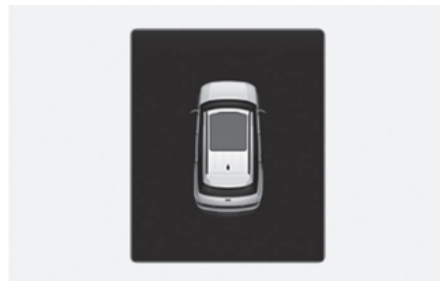

If the driver turns off the engine when the sunroof is not fully closed, the warning chime will sound for several seconds and the sunroof open warning will appear on the cluster display.

Close the sunroof securely when leaving your vehicle.

NOTICE

Make sure the sunroof is closed fully when leaving your vehicle. If the sunroof is left open, rain or snow may wet the interior of the vehicle.

Also, leaving the sunroof open when the vehicle is unattended may invite theft

Hood

Opening the hood

1. Park the vehicle and apply the parking brake.
2. Pull the release lever to unlatch the hood. The hood pops open slightly.

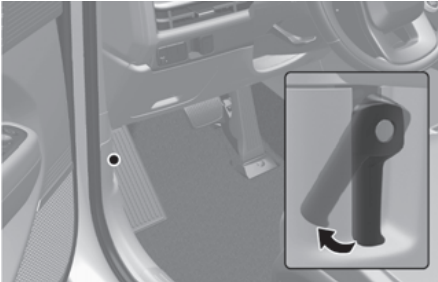

3. Go to the front of the vehicle, raise the hood slightly, push up the secondary hood release lever (1) inside of the hood center and lift the hood (2).

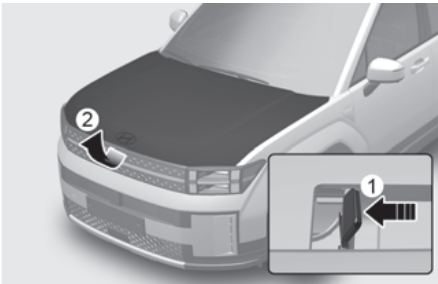

After the hood has been lifted halfway, it will raise completely by itself.

Closing the hood

1. Before closing the hood, check in and around the engine compartment to ensure the following:
 - Any tools or other loose objects have been removed.
 - All glove, rags, or other combustible material have been removed.
 - All filler caps are tightly and correctly installed.
2. Return the hood support rod to its stored location.
3. Lower the hood until it is about 12 in. (30 cm) above the closed position and then let it drop.
4. Check the hood has locked properly. If the hood is raised slightly, open it again and drop it from a little higher. Check again.

WARNING

- Before closing the hood, ensure all obstructions are removed from around the hood opening.
- Always double check to make sure that the hood is firmly latched before driving away. Check there is no hood open warning light or message displayed on the instrument cluster. Driving with the hood open may cause a total loss of visibility, resulting in a collision.
- Do not move the vehicle with the hood raised. It may block your vision and may result in a collision.

Power Liftgate

 if equipped

Power liftgate operating conditions

The power liftgate operates when the gear is in P (Park) with the engine running. However, the power liftgate will operate regardless of the gear position when the engine is off. Also, the liftgate can be opened only when vehicle speed is below 1.8 mph (3 km/h).

For safety, before attempting to open or close the liftgate, make sure the vehicle is in P (Park).

WARNING

- Never leave children or animals unattended in your vehicle. Children may operate the power liftgate. Doing so can result in injury to themselves or others and can damage the vehicle.
- Make sure that there are no people or objects in the path of the power liftgate or smart liftgate prior to use. Serious injury, damage to the vehicle or damage to surrounding objects (for example, walls, ceilings, vehicles, etc.) may result if contact with the liftgate occurs.

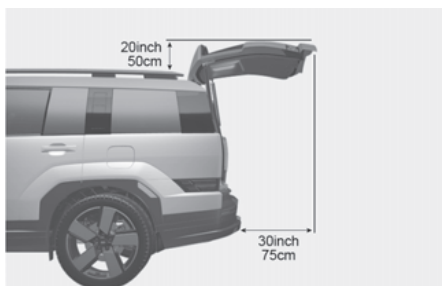

- The liftgate may not open or may close unintentionally injuring people around the liftgate under the following situation:
 - There is a lot of snow on the liftgate.
 - There is a heavy object on the liftgate such as a bicycle carrier, ladder, etc.

Do not open the liftgate before removing snow or heavy object on the liftgate.

NOTICE

- Do not close or open the liftgate manually. This may cause damage to the power liftgate. If it is necessary to close or open the liftgate manually when the battery is discharged or disconnected, do not apply excessive force.
- Do not operate the power liftgate more than 10 times continuously when the engine is not running. Use the power liftgate with the engine running when the power liftgate is used repeatedly to prevent battery discharge.
- Do not leave the power liftgate open for a long period of time. This may drain the battery.
- Do not apply excessive force when the power liftgate is operating. Doing so could result in vehicle damage.
- Do not grab or hold on to the liftgate support struts at any time. Damage to the liftgate support struts could result. Deformation of the liftgate support struts may cause vehicle damage and personal injury may occur.



- Do not modify or repair any part of the power liftgate by yourself. This must be done by an authorized HYUNDAI dealer.
- Do not operate the power liftgate under the following conditions. The power liftgate may not operate properly.
 - One side of the vehicle is lifted to inspect the vehicle or change a tire
 - Parking on an uneven road such as a slope, etc.
- Close the liftgate completely and lock all doors and liftgate using the central door lock button before using an automatic car wash.
- Do not spray high pressure water directly on the power liftgate outside open/close button. The liftgate may open unintentionally.

i Information

- If the liftgate is not fully closed and vehicle speed is at or above 1.8 mph (3 km/h), a warning will sound 10 times. Immediately park the vehicle at a safe place, close the liftgate, and check that the liftgate open warning on the cluster display is turned off.
- In cold and wet climates, the outside power liftgate open/close button may not work properly due to freezing conditions. If this occurs, remove the ice before using the outside power liftgate open/close button or use the power liftgate open/close button on the smart key or the instrument panel.
- Operating the power liftgate more than 5 times continuously could cause damage to the operating motor. If this occurs, the power liftgate will not operate to prevent the motor from overheating. If any of the power liftgate buttons are pressed to try to open the liftgate, the chime will sound 3 times, but the liftgate will remain closed. Allow the power liftgate system to cool for about 1 minute before operating the system again.

Operating the power liftgate

Power liftgate open (Smart key)

Type A



Type B



When the liftgate is closed, press the power liftgate open button for 1 second. The liftgate will open with a warning sound.

While the liftgate is opening, press the button to stop power liftgate operation.

Power liftgate open/close button (Instrument panel)

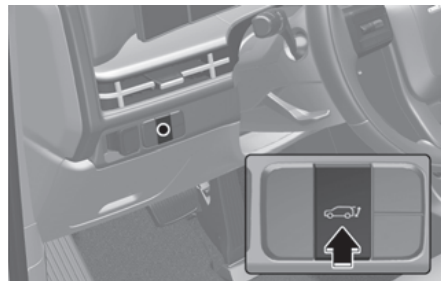

When the liftgate is closed, press the power liftgate open/close button for 1 second. The power liftgate opens with a warning sound.

While the liftgate is opening, press the button to stop liftgate operation.

When the power liftgate is opened, press and hold the power liftgate open/close button to close the liftgate. If you release the button while the liftgate is closing, power liftgate operation will stop with a warning sound for 5 seconds.

WARNING

Make sure that there are no people or objects in the path of the liftgate before pressing the open/close button inside the power liftgate and the smart key.

Otherwise, this may cause serious injury or damage to the vehicle or object.

**Power liftgate open/close button
(Outside the power liftgate)**

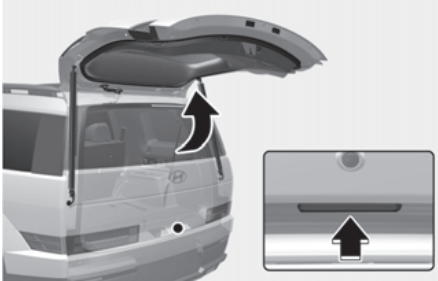

When the liftgate is closed, press the power liftgate open/close button to open the liftgate.

If the vehicle is locked, press the power liftgate open/close button with the smart key in your possession.

If the liftgate is unlocked, the liftgate will open or close with a warning sound when the power liftgate open/close button is pressed without carrying the smart key.

**Power liftgate open/close button
(Inside the power liftgate)**

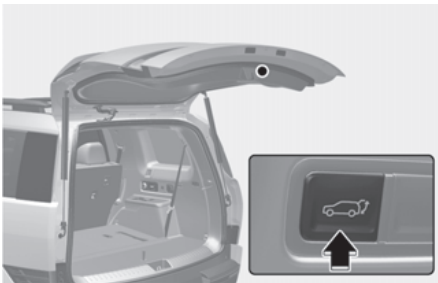

Press the power liftgate open/close button. The liftgate opens or closes automatically.

**Power liftgate lock button (Inside
the power liftgate)**



Press the power liftgate lock button while carrying the smart key. The liftgate closes and locks automatically. Additionally, all doors will lock.

The liftgate can be closed and locked, and all doors locked only when the button is pressed while the engine is off.

Automatic reversal

During power liftgate operation if the power liftgate senses any obstacle, the liftgate will stop or will fully open. The automatic reverse feature may not operate properly, or it may operate unexpectedly under the following circumstances:

- The automatic reverse feature may not detect the resistance if the detected resistance is below a certain level, or if the liftgate is almost fully closed near the latched position.
- The automatic reverse feature may operate if a strong impact is applied with no obstructions placed.

⚠ WARNING

Never intentionally place any object or part of your body in the path of the power liftgate to make sure the automatic reverse feature operates. Serious injury, or damage to the vehicle or object may occur.

i Information

The power liftgate may stop operating if the automatic reverse feature operates more than two times while attempting to open or close the liftgate. If this occurs, carefully open or close the liftgate manually, and then after 30 seconds try to operate the power liftgate automatically again.

Setting the power liftgate

To use each feature, you must select the opening speed or opening height from the settings menu. Deselect the settings when you do not want to use the feature.

Power liftgate opening speed

To adjust the power liftgate speed, select **Setup > Vehicle > Door > Power Liftgate Opening Speed > Normal/Fast** in the infotainment system. (Default setting is **Fast**)

Power liftgate opening height

To adjust the power liftgate opening height, select **Setup > Vehicle > Door > Power Liftgate Opening Height > Full Open/Level 3/Level 2/Level 1/User Height Setting** in the infotainment system.

User height setting

1. Position the liftgate manually to the height you prefer.
2. Press the power liftgate open/close button located inside the liftgate for more than 3 seconds.

If **User Height Setting** is selected for the power liftgate opening height, the power liftgate will automatically open to the height manually set by you.

i Information

- If the power liftgate opening height has not been manually set, the power liftgate will fully open when **User Height Setting** from the infotainment system is selected.
 - If one of the height setting (Full Open/Level 3/Level 2/Level 1) is selected from the settings menu in the infotainment system, and then **User Height Setting** is selected, the liftgate will open to the height manually set by you.
 - The power liftgate opening speed and opening height settings change according to the linked User Profile. If the User Profile is changed, power liftgate opening speed and opening height settings will change accordingly.
-

i Information

The infotainment system may change after software updates. For more information, refer to the user's manual provided in the infotainment system and the quick reference guide.

Resetting the power liftgate

In some circumstances resetting the power liftgate operation may need to be performed. Some instances where resetting the power liftgate may be required include:

- When the 12-volt battery is recharged
 - When the 12-volt battery is reinstalled after removal or replacement
 - When the related fuse is reinstalled after removal or replacement
1. With the engine off or running, put the gear in P (Park).
 2. Press the power liftgate open/close inner button and outer button simultaneously until a chime sounds.
 3. Slowly close the liftgate manually.
 4. Press the power liftgate open/close outer button. The power liftgate will open with a chime sound.

Wait until the liftgate fully opens to complete resetting. If the liftgate stops before it is fully open, resetting cannot be completed.

i Information

If the power liftgate does not operate properly after the above procedure, have the system inspected by an authorized HYUNDAI dealer.

Emergency liftgate safety release

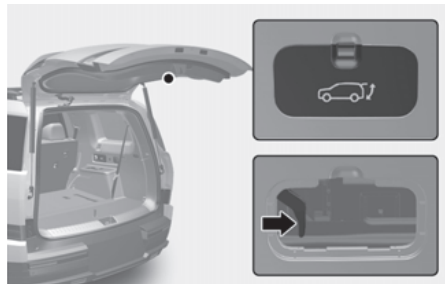

To unlock and open the liftgate manually from inside the luggage compartment, perform the following procedure:

1. Remove the cover at the bottom of the liftgate.
2. Slide the latch in the direction of the arrow to unlock the liftgate.
3. Push the liftgate to open.

! WARNING

- For emergencies, be fully aware of the location of the emergency liftgate safety release latch in the vehicle and how to open the liftgate if you are accidentally locked in the luggage compartment.
- No one, including animals, should be allowed to occupy the luggage compartment of the vehicle at any time. The luggage compartment is a very dangerous location in the event of a crash.
- Use the release latch for emergencies only. Use extreme caution, especially while the vehicle is in motion.

Smart Liftgate

 if equipped

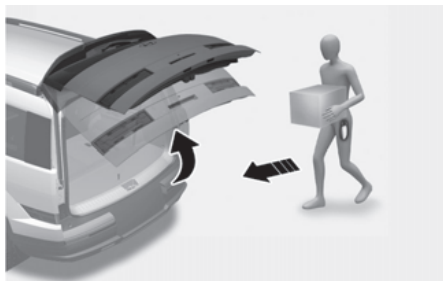

On a vehicle equipped with a smart key, the liftgate can be opened with hands-free activation using the smart liftgate system.

Using smart liftgate

The hands-free smart liftgate system can be used when:

- The smart liftgate option is enabled in the Settings menu in the infotainment system.
- The smart liftgate is activated 15 seconds after all the doors are closed and locked.
- The smart liftgate opens when the smart key is detected in the area behind the vehicle for 3 seconds.

i Information

The smart liftgate does not operate when:

- A door is not locked or closed.
- The smart key is detected within 15 seconds from when the doors were closed and locked.
- The smart key is detected within 15 seconds after the doors are closed and locked, and within 60 in. (1.5 m) from the front door handles. (for vehicles equipped with Welcome Light).
- The smart key is in the vehicle.

1. Settings

To use smart liftgate, it must be enabled from the Settings menu in the infotainment system. Select:

- **Setup > Vehicle > Door > Smart Liftgate**

i Information

The infotainment system may change after software updates. For more information, refer to the user's manual provided in the infotainment system and the quick reference guide.

2. Detect and Alert

The smart liftgate detecting area extends about 20-40 in. (50-100 cm) behind the vehicle. If you are positioned in the detecting area and are carrying the smart key, the hazard warning lights blink and the chime sounds before opening.

i Information

If you unintentionally enter the detecting area and the hazard warning lights and chime starts, move away from the vehicle with the Smart key. The liftgate remains closed.

3. Automatic opening

After the hazard warning lights blink and the chime sounds 6 times, the smart liftgate opens.

Deactivating smart liftgate

If you press any button on the smart key during the Detect and Alert stage, the smart liftgate is deactivated.

- If you press the door unlock button, the smart liftgate is deactivated temporarily. If you do not open any door for 30 seconds, the smart liftgate is activated again.
- If you press the liftgate open button for more than 1 second, the liftgate opens.
- The smart liftgate is still activated if you press the door lock button or liftgate open/close button as long as the smart liftgate is not in the Detect and Alert stage.

Detecting area



- The smart liftgate detecting area extends about 20-40 in. (50-100 cm) behind the vehicle. If you are positioned in the detecting area and are carrying the smart key, the hazard warning lights blink and the chime sounds for about 3 seconds to alert you that the liftgate opens.
- The alert stops once the Smart key is moved outside of the detecting area within the 3 second period.

i Information

- Smart liftgate may not operate properly if any of the following occur:
 - The Smart key is close to a radio transmitter such as a radio station or an airport which can interfere with normal operation of the transmitter.
 - The Smart key is near a mobile two way radio system or a mobile phone.
 - Another vehicle's Smart key is being operated close to your vehicle.
 - The temperature drops below zero degree.
- Smart liftgate detecting area may change when:
 - The vehicle is parked on an incline or slope.
 - One side of the vehicle is raised or lowered relative to the opposite side.

Fuel Filler Door

Opening the fuel filler door

1. Turn the engine off.
2. Make sure that the driver's door is unlocked.
3. Press the rear center edge (1) of the fuel filler door.



4. Pull the fuel filler door outward to access the fuel tank cap (2).

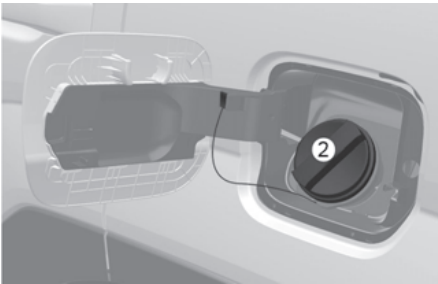

5. To remove the fuel tank cap (2), turn it counterclockwise. A hissing noise is heard because the pressure inside the tank equalizes.
6. Place the cap on the fuel filler door.

i Information

The fuel filler door unlocks when the driver's door is unlocked.

To unlock fuel filler door:

- Press the unlock button on your smart key.
- Press the central door unlock button on the driver's door.
- Pull out the driver's side inside door handle.

The fuel filler door locks when the driver's door is locked.

To lock the fuel filler door:

- Press the lock button on your smart key.
- Press the central door lock button on the driver's door.

All doors automatically lock after the vehicle speed exceeds 10 mph (15 km/h). Fuel filler door is also locked when the vehicle speed exceeds 10 mph (15 km/h).

i Information

If the fuel filler door does not open because ice has formed around it, tap lightly or push on the door to break the ice and release the door. Do not open the door. If necessary, spray around the door with an approved deicer fluid (do not use radiator antifreeze) or move the vehicle to a warm place and allow the ice to melt.

Closing the fuel filler door

1. To install the fuel tank cap, turn it clockwise until it "clicks" one time.
2. Close the fuel filler door until it is latched securely.

i Information

To lock the fuel filler door, make sure the fuel filler door is completely closed. Press the lock button on the smart key to lock your vehicle. The fuel filler door also locks.

If the fuel filler door is not completely closed when the vehicle is locked, the fuel filler door is not locked.

WARNING

Automotive fuel is highly flammable and explosive. Failure to follow these guidelines may result in serious injury or death:

- Read and follow all warnings posted at the gas station.
- Before refueling, note the location of the Emergency Fuel Shut-Off, if available, at the gas station.
- Before touching the fuel nozzle, eliminate the potential build-up of static electricity by touching a metal part of the vehicle, a safe distance away from the fuel filler neck, nozzle, or other gas source, with your bare hand.
- Do not use mobile phones while refueling. Electric current and/or electronic interference from cellular phones may potentially ignite fuel vapors and cause a fire.
- Do not get back into a vehicle once you have begun refueling. You can generate a buildup of static electricity by touching, rubbing, or sliding against any item or fabric capable of producing static electricity. Static electricity discharge may ignite fuel vapors causing a fire. If you must re-enter the vehicle, once again eliminate potentially dangerous static electricity discharge by touching a metal part of the vehicle, away from the fuel filler neck, nozzle, or other fuel source, with your bare hand.
- When using an approved portable fuel container, be sure to place the container on the ground prior to refueling. Static electricity discharge from the container may ignite fuel vapors causing a fire. Once refueling has begun, contact between your bare hand and maintain the vehicle until the filling is complete.
- Use only approved portable plastic fuel containers designed to carry and store fuel.
- When refueling, always shift the gear to the P (Park) position, apply the parking brake, and move the Engine Start/Stop button to the OFF position. Sparks produced by electrical components related to the engine may ignite fuel vapors causing a fire.

- Do not use matches or a lighter and do not smoke or leave a lit cigarette in your vehicle at a gas station, especially during refueling.
- Do not over-fill or top-off your vehicle tank, which may cause fuel spillage.
- If a fire breaks out during refueling, get away from the vehicle, and immediately contact a gas station employee and then contact the local fire department.
- If pressurized fuel sprays out, it can cover your clothes or skin and increase the risk of fire and burns. If the cap is venting fuel or if you hear a hissing sound, wait until the condition stops before completely removing the cap.
- Always check that the fuel cap is installed securely to prevent fuel spillage in the event of a collision.

NOTICE

- Do not spill fuel on the exterior surfaces. It may damage the paint.
- If the cap needs to be replaced, only use a genuine HYUNDAI cap or the fuel system or emission control system may malfunction.

i Information

Make sure to refuel your vehicle according to the "Fuel Requirements" section in chapter 9.

Head-up display (HUD)

 if equipped

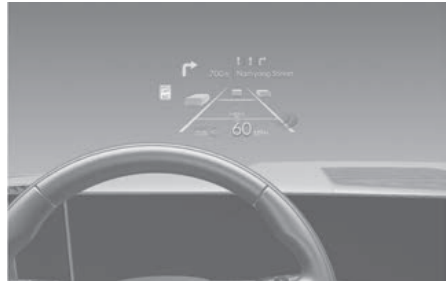

The Head-Up Display is an optional feature that allows the driver to view information projected onto a transparent screen while still keeping your eyes on the road ahead while driving.

Head-up display settings

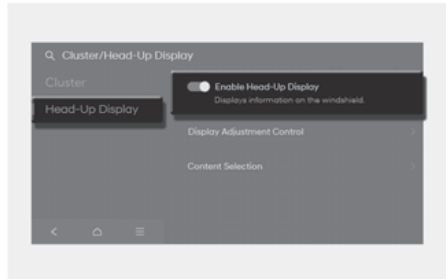

- Head-up display can be enabled from the Settings menu in the infotainment system. Select:
 - **Setup > Cluster/Head-Up Display > Head-Up Display > Enable Head-Up Display**

- After turning on the head-up display, you can change the settings of "**Display adjustment Control**" and "**Content selection**" of the Head-Up Display.

i Information

The infotainment system may change after software updates. For more information, refer to the user's manual provided in the infotainment system and the quick reference guide.

Head-up display information

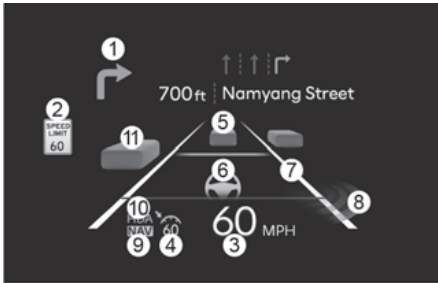

- (1) Turn by Turn (TBT) navigation
- (2) Traffic signs or speed limit
- (3) Speedometer
- (4) SCC set speed
- (5) SCC vehicle distance
- (6) Lane Following Assist
- (7) Lane Safety
- (8) Blind-Spot Safety
- (9) Highway Auto Speed Change
- (10) Highway Driving Assist
- (11) Surrounding vehicles (if equipped)

Precautions while using the head-up display

- It may sometimes be difficult to read information on the Head-Up Display in the following situations.
 - The driver is improperly positioned in the driver's seat
 - The driver wears polarizing-filter sunglasses
 - An object is located above the Head-Up Display cover
 - The vehicle is driven on a wet road
 - Any improper lighting accessory is installed inside the vehicle, or there is incoming light from outside of the vehicle
 - The driver wears glasses
 - The driver wears contact lenses

When it is difficult to read the Head-Up Display information, adjust the image height or brightness level from the Settings menu in the infotainment system.

- For your safety, make sure to stop the vehicle before adjusting the settings.
- Do not tint the front windshield glass or add other types of metallic coating. Otherwise, the Head-Up Display image may be invisible.
- Do not place any accessories on the dashboard or attach any objects on the windshield glass.
- When replacing the front windshield glass, replace it with a windshield glass designed for Head-Up Display operation. Otherwise, duplicated images may be displayed on the windshield glass.

! WARNING

The warning information of Blind-Spot Safety on the Head-Up Display are supplemental. Do not solely depend on them to change lanes. Always take a look around before changing lanes.

Vehicle system OTA update

The OTA (Over-the-Air) software update feature allows you to wirelessly update software to the latest version. Using this feature, you can keep your vehicle system up to date with the latest software.

Downloading software

The latest software can be downloaded automatically while driving. After the latest software has been successfully downloaded, you will receive a notification on your phone or the vehicle screen that the software update is available.

Approving software update

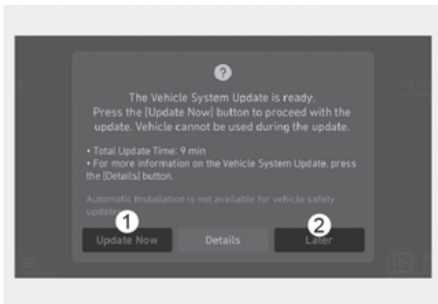

After the vehicle is turned off, the vehicle system will allow you to start the update.

- To start the update, press **Update Now** (1).
- To postpone the update, press **Later** (2).

Preparing software update

If you press the **Update Now** button on the screen, the vehicle will begin installing the update automatically. The following conditions must be satisfied:

- The vehicle must be off.
- The gear must be in P (Park).
- The Electronic Parking Brake (EPB) must be applied.
- The exterior lights must be turned off.
- The hood must be closed.
- The battery must be sufficient.
- The systems to be updated must not be running.

i Information

The battery and system status are automatically checked by the vehicle.

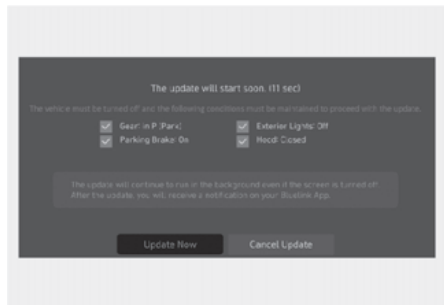

- To update immediately, press **Update Now**.
- To cancel the update, press **Cancel Update**.

Updating software

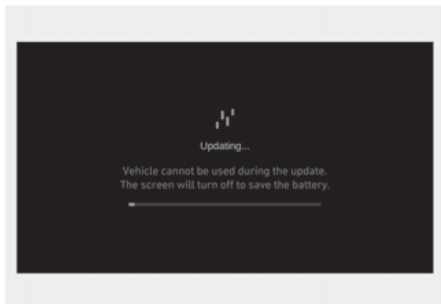

You can see the progress of the update on the screen.

After the update is complete, you will receive a notification on your phone or the vehicle screen that the software update is complete.

i Information

The screen turns off automatically after 3 minutes to save the battery. If the screen turns off automatically, you can check the update progress by pressing the Engine Start/Stop button.

i Information

- After the update starts, you can exit the vehicle.
- The OTA software update feature is only available for HYUNDAI Connected Services users.
- The update details may vary depending on the installed software version.
- Check the notice for the OTA software update on the HYUNDAI brand web.
- If the update fails, the update recovery will automatically proceed. If you want to retry the software update, even after a successful recovery, contact the HYUNDAI Call Center.
- If the software update or recovery fails, please contact the HYUNDAI Call Center. If there is a safety issue, you may be notified by the HYUNDAI Call Center to provide services such as emergency dispatch.
- After the update is complete, it may provide new functions or improvements. For more information, see the "OTA Software Update" page on the HYUNDAI brand web or scan the QR code on the screen.

NOTICE

- Observe the following restrictions during the update.
 - You cannot use the vehicle during the update. Be sure to have enough time for the update, and safely park the vehicle before starting the update process.
 - You cannot use remote features, including remote start.
 - If the update includes the digital key function, the door lock/unlock function via the digital key may not work. If the digital key function is updated by checking the notice, use the button on the smart key to lock or unlock the door.
 - The Rear Occupant Alert feature may not work. Check if there are any occupant in the rear seat. (Vehicles with that function)
- The update is automatically canceled if any vehicle conditions required for the update are changed before starting the update.
- Once the update has started, you cannot cancel the update.
- You cannot use the OTA software update feature if you modify or replace any vehicle software.
- Do not open the hood or replace the battery in the vehicle during the update. The update may fail.
- If a diagnostic tool of any kind is connected to the vehicle OBD (On-board Diagnostic) terminal, the vehicle cannot be updated. The vehicle can be updated by removing the diagnostic tool connected to the OBD terminal and then restarting the vehicle.
- If the update is not complete successfully, contact the HYUNDAI Call Center.

Exterior Lights

Lighting control

To operate the lights, turn the knob at the end of the control lever to one of the following positions:

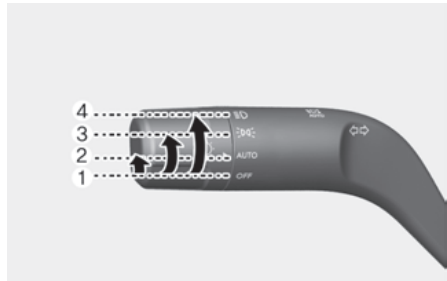

- (1) OFF
- (2) AUTO headlight
- (3) Parking light
- (4) Headlight

AUTO headlight

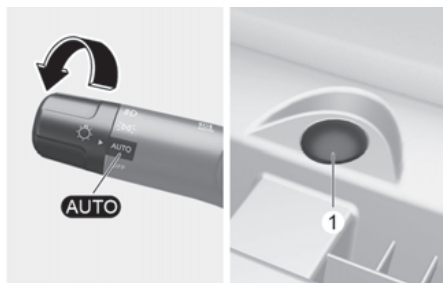

The headlights and parking lights are turned ON or OFF automatically depending on the amount of daylight as measured by the ambient light sensor (1) in front of the instrument panel.

Even with the AUTO headlight feature in operation, it is recommended to manually turn ON the headlights when driving at night or in a fog, driving in the rain, or when you enter dark areas, such as tunnels and parking facilities.

NOTICE

- Do not cover or spill anything on the sensor (1) located in front of the instrument panel.
- Do not clean the sensor using a window cleaner, the cleaner may leave a light film which could interfere with sensor operation.
- If your vehicle has window tint or other types of metallic coating on the front windshield, the AUTO headlight system may not work properly.

Parking light (P)



The parking light, license plate light, and instrument panel light are turned ON.

Headlight (H)

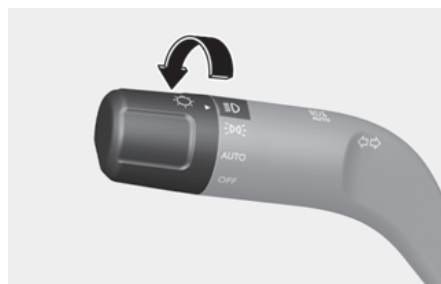

The headlight, parking light, license plate light, and instrument panel light are turned ON.

i Information

The Engine Start/Stop button must be in the ON position to turn on the headlight.

High beam operation

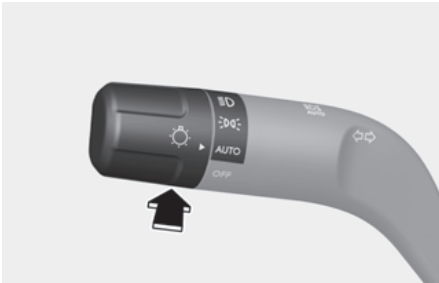

To turn on the high beam headlight, push the lever away from you. The lever returns to its original position.

The high beam indicator illuminates when the headlight high beams are switched on.

To turn off the high beam headlight, pull the lever toward you. The low beams turn on.

WARNING

Do not use high beam when there are other vehicles approaching you. Using high beam may obstruct the other driver's vision.

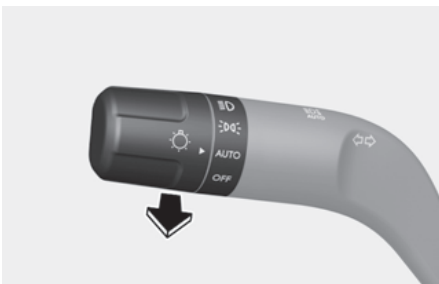

To flash the high beam headlight, pull the lever toward you, then release the lever. The high beams remain ON as long as you hold the lever.

Turn signals and lane change signals

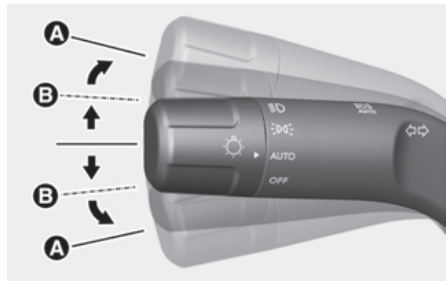

To signal a turn, push down on the lever for a left turn or up for a right turn in position (A).

If an indicator stays on and does not flash or if it flashes abnormally, one of the turn signal bulbs may be burned out and require replacement. Contact an authorized HYUNDAI dealer.

One touch turn signal

To use One Touch Turn Signal, push the turn signal lever up or down to position (B) and then release it.

The lane change signals blinks 3, 5 or 7 times.

You can enable the One Touch Turn Signal function or choose the number of blinking from the Settings menu in the infotainment system. Select:

Setup > Vehicle > Lights > One Touch Turn Signal > Off/3 flashes/5 flashes/7 flashes

Information

The infotainment system may change after software updates. For more information, refer to the user's manual provided in the infotainment system and the quick reference guide.

Battery saver function

To prevent the battery from being discharging, the system automatically turns off the parking lights when the driver turns the vehicle off and opens the driver's door.

To keep the lights on when the vehicle is turned off:

- (1) Open the driver's door.
- (2) Turn the parking lights OFF and ON again using the headlight switch.

Headlight delay function

If you place the Engine Start/Stop button to the ACC or OFF position with the headlights ON, the headlights (and/or parking lights) remain on for about 5 minutes. If the driver's door is opened and closed, the headlights are turned off after 15 seconds. Also, with the vehicle off if the driver's door is opened and closed, the headlights (and/or parking lights) are turned off after 15 seconds.

The headlights (and/or parking lights) can be turned off by pressing the lock button on the smart key twice or turning the headlight switch to the OFF or AUTO position.

You can enable the headlight delay function from the Settings menu in the infotainment system. Select:

Setup > Vehicle > Lights > Headlight Delay

i Information

The infotainment system may change after software updates. For more information, refer to the user's manual provided in the infotainment system and the quick reference guide.

i Information

If the driver exits the vehicle through another door besides the driver's door, the battery saver function does not operate and the headlight delay function does not turn OFF automatically.

To avoid battery discharge, turn OFF the headlights manually before exiting the vehicle.

Daytime Running Lights (DRL)

The Daytime Running Lights can make it easier for others to see the front of your vehicle during the day, especially after dawn and before sunset. The DRL system is ON when the headlight switch is in the OFF or the AUTO headlight position and the Electronic Parking Brake is released.

It turns off when:

- The headlights are ON.
- The parking brake is applied.
- The vehicle is turned off.
- The hazard warning flasher is ON.
- The turn signal lights are ON.
 - The corresponding side of the DRL where the turn signal light is on turns off.

Reverse guide light

 If equipped

When the gear is in R (Reverse), the reverse light turns on and the reverse guide light at the back of the vehicle lights the floor.

The light informs nearby drivers that your vehicle is backing up.

CAUTION

The left and right lengths of the light may differ depending on the number of passengers, loading, vehicle tilt status, etc.

Welcome system

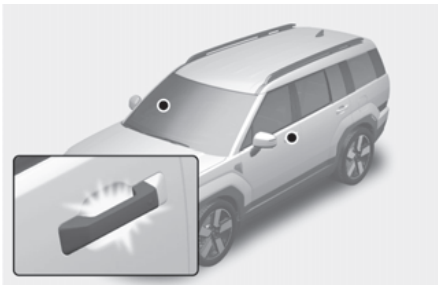

Welcome system helps keep the driver visible by turning on vehicle lights when the driver approaches the vehicle.

Dynamic welcome light

 If equipped

The dynamic welcome lights operate for about 7 seconds, and then the tail lamps are turned on.

When the door lock button or door unlock button on the smart key is pressed while the dynamic welcome light is on, the dynamic welcome light turns off immediately.

You can enable the dynamic welcome light function from the Settings menu in the infotainment system. Select:

Setup > Vehicle > Lights > Headlight delay in the infotainment system.

Door handle light

When all the doors (and liftgate) are closed and locked, the door handle light will turn on for about 15 seconds if:

- **Setup > Vehicle > Lights > Welcome Mirror/Light > On door unlock** is selected in the infotainment system,
 - The door lock button is pressed on the smart key.
 - The button of the outside door handle is pressed while carrying the smart key.
 - You put your hand in the outside door handle while carrying the smart key.

- The smart key is detected, and both **Lights > Welcome Mirror/Light > On door unlock** and **Lights > Welcome Mirror/Light > On driver approach** are selected.

You can activate or deactivate the Welcome Light function from the Settings menu in the infotainment system.

i Information

The infotainment system may change after software updates. For more information, refer to the user's manual provided in the infotainment system and the quick reference guide.

Headlight and parking light

When the headlight switch is in the headlight or AUTO position and all the doors (and liftgate) are closed and locked, the parking lights and headlights come on for about 15 seconds when the door unlock button is pressed on the smart key.

If you press the door lock or unlock button, the parking lights and headlights turn off immediately.

Select **Setup > Vehicle > Lights > Headlight delay** from the infotainment system to turn on this function.

Interior light

When the interior light switch is in the  position and all doors (and liftgate) are closed and locked, the room lamps come on for 30 seconds when:

- The door unlock button is pressed on the smart key.
- The button of the outside door handle is pressed while carrying the smart key. (button type)
- You put your hand in the outside door handle while carrying the smart key. (touch sensor type)

If you press the door lock or unlock button on the smart key, the lights turn off immediately.

i Information

The infotainment system may change after software updates. For more information, refer to the user's manual provided in the infotainment system and the quick reference guide.

High Beam Assist (HBA)

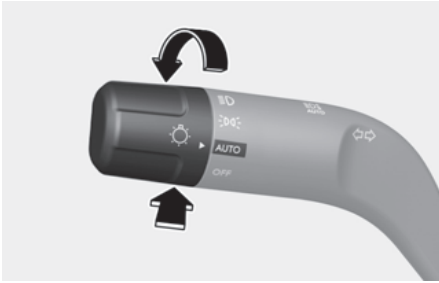

High Beam Assist automatically adjusts the headlights between high beam and low beam depending on the light detected from oncoming vehicles or vehicles in front using the front view camera.

i Information

Refer to the "Driver Assistance System Sensors" section in chapter 7 for the location and the general precautions of front view camera.

High Beam Assist settings

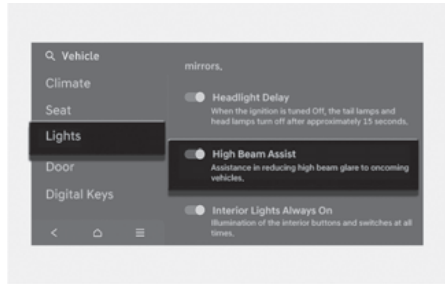

With the Engine Start/Stop button ON, go to the Settings menu to turn on High Beam Assist and deselect to turn off the function in the infotainment system. Select:

Setup > Vehicle > Lights > High Beam Assist

! WARNING

Only change the settings after parking your vehicle at a safe location.

High Beam Assist operation

- After selecting **High Beam Assist** from the settings menu to operate High Beam Assist:
 - Place the headlight switch in the AUTO position and push the turn signal lever toward the instrument cluster. High Beam Assist (☰D) indicator light illuminates.
 - When High Beam Assist is enabled, high beams turn on when the vehicle speed is above 20 mph (30 km/h) and the High Beam (☰D) indicator light illuminates. When the vehicle speed is below 12 mph (20 km/h), high beams do not turn on and the indicator light illuminates in white.
- When High Beam Assist is operating:
 - If the turn signal lever is pulled toward you when the high beams are off, the high beams turn on. When you let go of the turn signal lever, High Beam Assist operates again.
 - If the turn signal lever is pulled toward you when the high beams are on by High Beam Assist, the low beams turn on and High Beam Assist turns off.
 - If the turn signal lever is pushed away from you, the high beams turn on and High Beam Assist turns off.
 - If the headlight switch is moved from AUTO to another position (headlight/position/off), the corresponding light turns on and High Beam Assist turns off.
- When High Beam Assist is operating, high beam switches to low beam if:
 - The headlights of an oncoming vehicle are detected.
 - The tail lights of a front vehicle are detected.
 - The headlight or tail light of a motorcycle or a bicycle is detected.
 - The surrounding ambient light is bright enough so high beams are not required.
 - Streetlights or other lights are detected.

i Information

The images and colors in the instrument cluster may differ depending on the cluster type or theme selected from the settings menu.

High Beam Assist malfunction and limitations

High Beam Assist malfunction

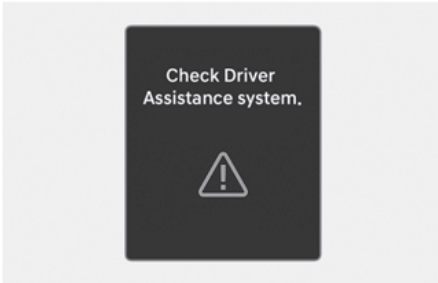

When High Beam Assist is not working properly, the "**Check Driver Assistance system**" warning message may appear, and the  warning light may illuminate on the instrument cluster. Contact an authorized HYUNDAI dealer.

Limitations of High Beam Assist

High Beam Assist may not work properly in the following situations if:

- The headlights from an oncoming or front vehicle is damaged or out of the detection range.
 - The headlights from an oncoming or front vehicle are covered with dust, snow, or water.
 - An oncoming or front vehicle's headlights are off but the fog lamps are on.
 - There are lights that have a similar shape as a vehicle's light ahead.
 - The headlights are not repaired or replaced properly.
 - The headlights are not aimed properly.
- You are driving on a narrow curved road, rough road, uphill, or downhill.
 - A front vehicle is partially visible at a crossroad or on a curved road.
 - There is a temporary reflector or flash ahead (construction area).
 - There is a traffic light, reflecting sign, LED sign, or reflectors ahead.
 - The road is wet or covered with snow or ice.
 - A vehicle suddenly appears from a curve.
 - The vehicle is tilted due to a flat tire or being towed.
 - The headlights from an oncoming or front vehicle is not detected because of exhaust fumes, smoke, fog, snow, blizzard, water spray on the road, or windshield condensation, etc.

Information

For more information on the limitations of the front view camera, refer to the "Forward Collision-Avoidance Assist (FCA)" section in chapter 7.

WARNING

- Always check road conditions, and if necessary, take appropriate actions to drive safely. It is your responsibility to operate your vehicle in a safe manner.
- If High Beam Assist does not operate properly, use the turn signal lever to switch between high beam and low beam.
- High Beam Assist may not operate for 15 seconds right after your vehicle is started or when the front view camera is initialized.

Interior Lights

WARNING

Do not use the interior lights when driving in the dark. The interior lights may obscure your view and result in a collision. Do not use the interior lights for extended periods when the vehicle is turned off. Otherwise, the battery discharges.

Interior lights auto off

The interior lights automatically go off about 10 minutes after the vehicle is turned off and the doors are closed. If a door is opened, the light go off 40 minutes after the vehicle is turned off. If the doors are locked by the smart key and the vehicle enters the armed stage of the theft alarm system, the lights go off five seconds later.

Front lights

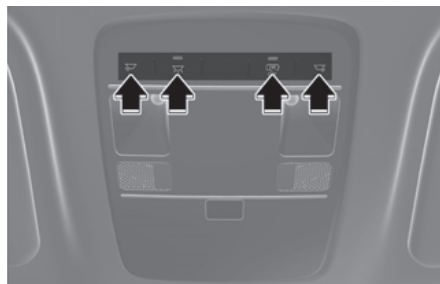

Map lamp ():

Touch either button to turn on or off the map lamp. This light produces a spot beam for convenient use as a map lamp at night or as a personal lamp for the driver and the front passenger.

Room lamp ():

Press the button to turn on the room lamp for the front and rear seats.

Door lamp ():

The front or rear room lamps come on when the front or rear doors are opened. When doors are unlocked by the smart key, the front and rear lamps come on for about 30 seconds as long as any door is not opened. The front and rear room lamps go out gradually after about 30 seconds when the door is closed. However, if the Engine Start/Stop button is in the ON position or all doors are locked, the front and rear lamps turn off. If a door is opened with the Engine Start/Stop button in the ACC or OFF position, the front and rear lamps stay on for about 10 minutes.

Rear personal lamps

Personal lamp



☾: Press the button to turn on and off the rear room lamp.

Vanity mirror lamp

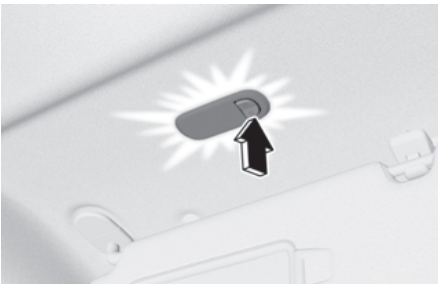

Push the switch to turn the lamp on or off.

- ☾: The lamp turns on if this button is pressed.
- : The lamp turns off if this button is pressed.

Glove box lamp

 If equipped

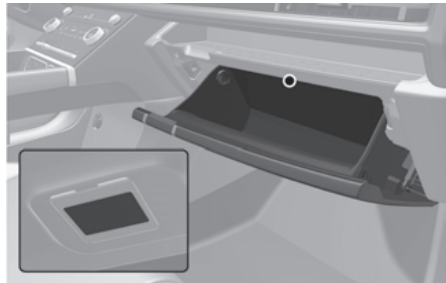

The glove box lamp turns on when the glove box is opened.

If the glove box is not closed, the lamp turns off after 20 minutes.

NOTICE

Close the glove box after use to prevent unnecessary battery discharge.

Two-way multi console lamp

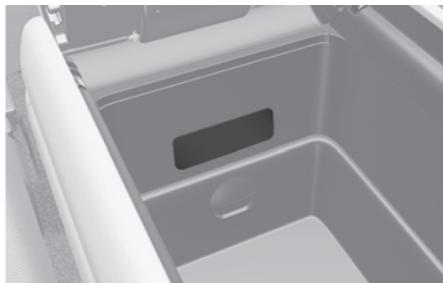

The two-way multi console lamp turns on when you turn on the interior button lights while the Engine Start/Stop button is in the ON position.

The two-way multi console lamp turns off when you turn off the interior button lights and the Engine Start/Stop button is in the ACC or OFF position.

i Information

For more information on the lighting control, refer to the "Lighting control" section in this chapter.

Interior button lights

The interior lighting including the button lighting are continuously on to make it easy to locate buttons and items during both day and night.

Set Daytime Lighting

- You can enable or disable the function from the infotainment system.
 - Exterior and interior button lighting: **Vehicle > Lights > Set Daytime Lighting > Activate Exterior Accent and Interior Controls Lighting**
 - Interior button lighting: **Vehicle > Lights > Set Daytime Lighting > Activate Interior Lighting**
 - To turn off the lighting: **Vehicle > Lights > Set Daytime Lighting > Off**

System operation

- When all doors are locked, opening a door after unlocking it briefly turns on the interior lighting.
- When the Engine Start/Stop button is in the ON position, it keeps the interior lighting on at all times.
- When the Engine Start/Stop button is in the Off position, the interior lighting briefly stays on. At this time, when the door is opened and closed, or locked, the interior lighting immediately turns off.

i Information

The infotainment system may change after software updates. For more information, refer to the user's manual provided in the infotainment system and the quick reference guide.

Mood lighting

 If equipped

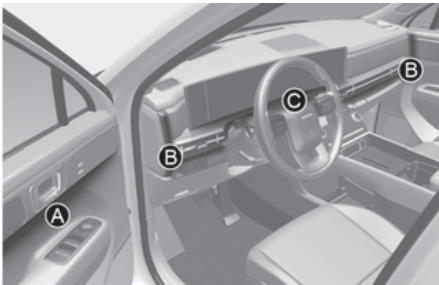

- [A] Driver seat door, passenger seat door
- [B] Dashboard
- [C] Bottom of the instrument cluster

To set the brightness and color of the mood lighting, select:

Setup > Vehicle > Lights > Ambient Lighting in the infotainment system.



- If the **Linked to Drive Mode** is selected, the mood lighting color changes according to the selected drive mode.
- If you do not want to use mood lighting, set **Brightness** to **0** in the infotainment system.

Information

- The mood lamps at both ends of the dashboard turn off to prevent reduced visibility of the side view mirror when the vehicle is not in P (Park).
- The infotainment system may change after software updates. For more information, refer to the user's manual provided in the infotainment system and the quick reference guide.
- The color of the mood lamp may seem different under some conditions depending on the color of the interior and the set mood color.

Cargo area lamp



- : The cargo area lamp is on. The lamp automatically go off about 20 minutes after the vehicle is turned off.
- : The cargo area lamp comes on when the liftgate is opened. The lamp automatically go off about 20 minutes after the vehicle is turned off and the liftgate is opened.
- : The cargo area lamp is off.

Wipers And Washers

Front windshield wiper/washer

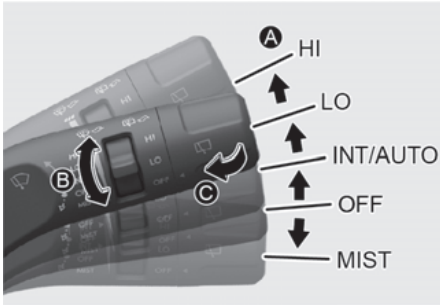

Rear windshield wiper/washer

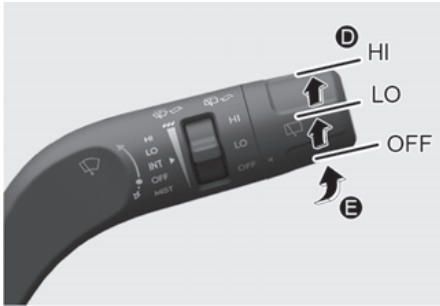

A. Wiper speed control (front)

- **HI:** High wiper speed
- **LO:** Low wiper speed
- **INT:** Intermittent wipe
- **AUTO** (if equipped): Auto control wipe
- **OFF:** Off
- **MIST:** Single wipe

B. Intermittent or Auto control wipe time adjustment

C. Wash with brief wipes (front)

D. Rear wiper control

- **HI:** High wiper speed
- **LO:** Low wiper speed
- **OFF:** Off

Front windshield wipers

Operates as follows when the engine is turned on.

- **HI:** The wiper runs at a higher speed.
- **LO:** The wiper runs at a lower speed.
- **INT:** Wiper operates intermittently at the same wiping intervals. To vary the speed setting, turn the speed control knob.
- **AUTO** (if equipped): The rain sensor located on the upper end of the windshield glass senses the amount of rainfall and controls the wiping cycle for the proper interval. The more it rains, the faster the wiper operates. When the rain stops, the wiper stops. To vary the speed setting, turn the speed control knob.
- **OFF:** Wipers are not in operation.
- **MIST:** For a single wiping cycle, push the lever downward and release. The wipers operate continuously if the lever is held in this position.

i Information

- If there is heavy accumulation of snow or ice on the windshield, defrost the windshield for about 10 minutes, or until the snow and/or ice is removed before using the windshield wipers to ensure proper operation.
- If you do not remove the snow and/or ice before using the wiper and washer, it may damage the wiper and washer system.
- If it snows while driving, the wiper may temporarily stop operation to prevent damage caused by accumulated snow at the upper and lower parts of the window. When the wiper stops operation, clear the accumulated snow from the parts.
- The wiper operation is stopped upon snow accumulation while driving. This is normal wiper operation. It is to prevent safety issues from happening when the wiper operation continues without removing snow.

AUTO (Automatic) control

 If equipped

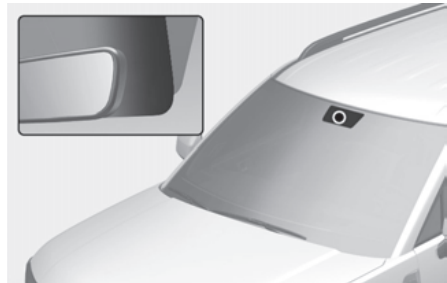

The rain sensor located on the upper end of the windshield glass senses the amount of rainfall and controls the interval of the wiping cycle.

To change the sensitivity setting, turn the sensitivity control knob.

If the wiper switch is set in the AUTO mode when the Engine Start/Stop button is in the ON position, the wiper operates once to perform a self-check of the system. Set the wiper to the OFF position when the wiper is not used.

WARNING

To prevent personal injury:

- Do not touch the upper end of the windshield glass facing the rain sensor.
- Do not wipe the upper end of the windshield glass with a damp or wet cloth.
- Do not put pressure on the windshield glass.

NOTICE

- When washing the vehicle, set the wiper switch in the OFF position to stop the auto wiper operation.
- Do not remove the sensor cover located on the upper end of the passenger side windshield glass.

Front windshield washers

In the OFF position, pull the lever gently toward you to spray washer fluid on the windshield and to run the wipers 1-3 cycles. The spray and wiper operation continues until you release the lever. If the washer does not work, you may need to add washer fluid to the washer fluid reservoir.

Recirculating air when washer fluid is used

When washer fluid is used, in order to reduce any objectionable scent of the washer fluid from entering the cabin, recirculation mode and air conditioning are automatically activated depending on the outside temperature. If you select fresh mode while the function is operating, the function resumes after a certain amount of time. It may not work in some conditions such as cold weather or vehicle OFF.

For more information, refer to the "Climate Control Additional Features" section in this chapter.

WARNING

When the outside temperature is below freezing, always warm the windshield using the defroster to prevent the washer fluid from freezing on the windshield and obscuring your vision that could lead to a collision resulting in serious injury or death.

Always use appropriate washer fluids in the winter season or cold weather.

NOTICE

To prevent damage:

- Do not operate the washer when the fluid reservoir is empty or when the windshield is dry.
- Do not operate the wipers when the windshield is dry.
- Do not attempt to move the wipers manually.
- Use anti-freezing washer fluids in the winter season or cold weather.

Rear window wipers and washers

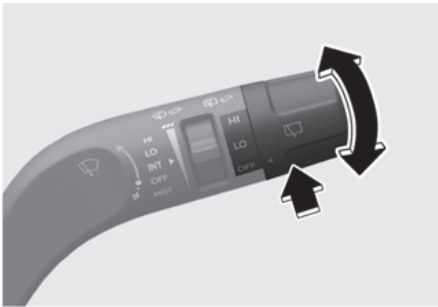

The rear window wiper and washer switch is located at the end of the wiper and washer switch lever. Turn the switch to the desired position to operate the rear wiper and washer.

- **HI:** High wiper speed
- **LO:** Low wiper speed
- **OFF:** Off

Push the lever away from you to spray rear washer fluid and to run the rear wipers 1-3 cycles. The spray and wiper operation continues until you release the lever.

Auto rear wiper

 If equipped



The rear wiper operates while the vehicle is in reverse with the front wiper on. You can select the function from the Settings menu in the infotainment system. Select:

Setup > Vehicle > Convenience > Auto Rear Wiper (in R)

For more information, refer to the "Recirculating air when washer fluid is used" section in this chapter.

i Information

The infotainment system may change after software updates. For more information, refer to the user's manual provided in the infotainment system and the quick reference guide.

Automatic Climate Control System

⁺ if equipped

Front



The actual shape of air conditioner may differ from the illustration.

- (1) Driver's temperature control
- (2) AUTO (automatic control)
- (3) Driver seat set temperature
- (4) Passenger's temperature control
- (5) SYNC
- (6) Passenger seat set temperature
- (7) DRIVER ONLY
- (8) Fan speed control
- (9) Mode selection
- (10) Front/Rear climate control selection
- (11) OFF
- (12) A/C (air conditioning)
- (13) Air intake control
- (14) Front windshield defroster
- (15) Rear window defroster

i Information

Screen distortion that occurs when you press the screen strongly is a normal phenomenon that can occur due to the characteristics of LCD.

3rd row

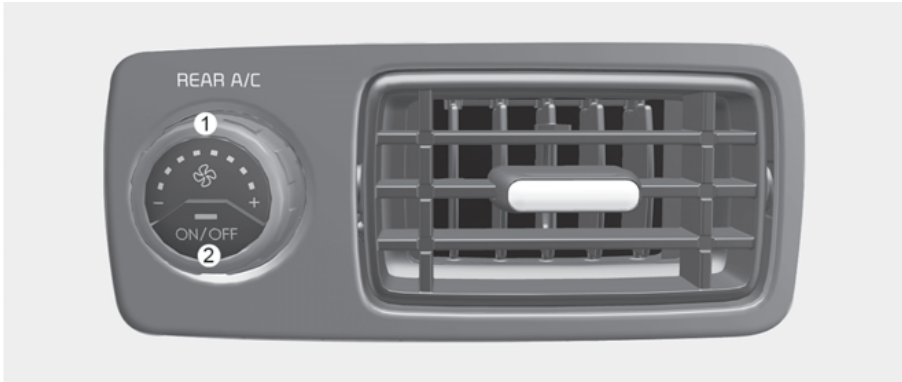

The actual shape of air conditioner may differ from the illustration.

- (1) Fan speed control
- (2) Rear A/C (air conditioning) ON/OFF

i Information

Heater/air conditioning can operate while the engine is turned off, but it may lower its efficiency and quickly discharge the battery. We recommend that you turn on the engine when operating the climate control.

! WARNING

- Do not sleep in your vehicle with the air conditioning ON. It may lead to serious injury or death.
 - Do not drive for a long time while the air conditioning is ON in a confined space as it may cause headaches or drowsiness.
-

Automatic heating and air conditioning

The Automatic Climate Control System is controlled by setting the desired temperature.

1. Press the AUTO button. The modes, fan speeds, air intake, and air conditioning are controlled automatically by the temperature setting.



You can control the fan speed in three stages by pressing the **AUTO** button during automatic operation.

Blower strength	AUTO button	Fan speed range
HIGH		2-8
MEDIUM		1-6
LOW		1-4

2. Turn the temperature control knob to set the desired temperature. If the temperature is set to the lowest setting, the air conditioning system operates continuously. After the interior has cooled sufficiently, adjust the knob to a higher temperature set point whenever possible.

To turn off the automatic operation, select any button of the following buttons:

- A/C button
- Mode selection button
- Front windshield defroster button (Press the button one more time to deselect the front windshield defroster function. The "AUTO" sign illuminates on the information screen once again.)
- Fan speed control button

The selected function is controlled manually while other functions operate automatically.

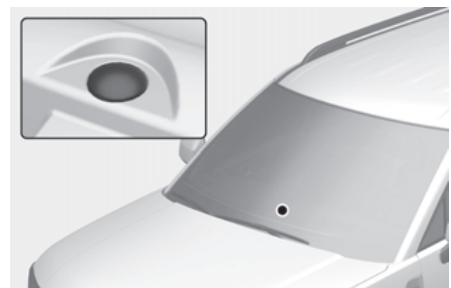

For your convenience and to improve the effectiveness of the climate control, use the AUTO button and set the temperature to 72 °F (22 °C).

i Information



Never place anything near the sensor to ensure better control of the heating and cooling system.

Manual heating and air conditioning

1. Start the engine.
2. Set the mode to the desired position.
For improving the effectiveness of heating and cooling, select:
 - Heating: 
 - Cooling: 
3. Set the temperature control to the desired position.
4. Set the air intake control to the outside (fresh) air position.
5. Set the fan speed control to the desired speed.
6. If air conditioning is desired, turn on the air conditioning system.
7. Press the AUTO button to convert to full automatic control of the system.

Mode selection

The mode selection button controls the direction of the air flow through the ventilation system.



Air flow direction

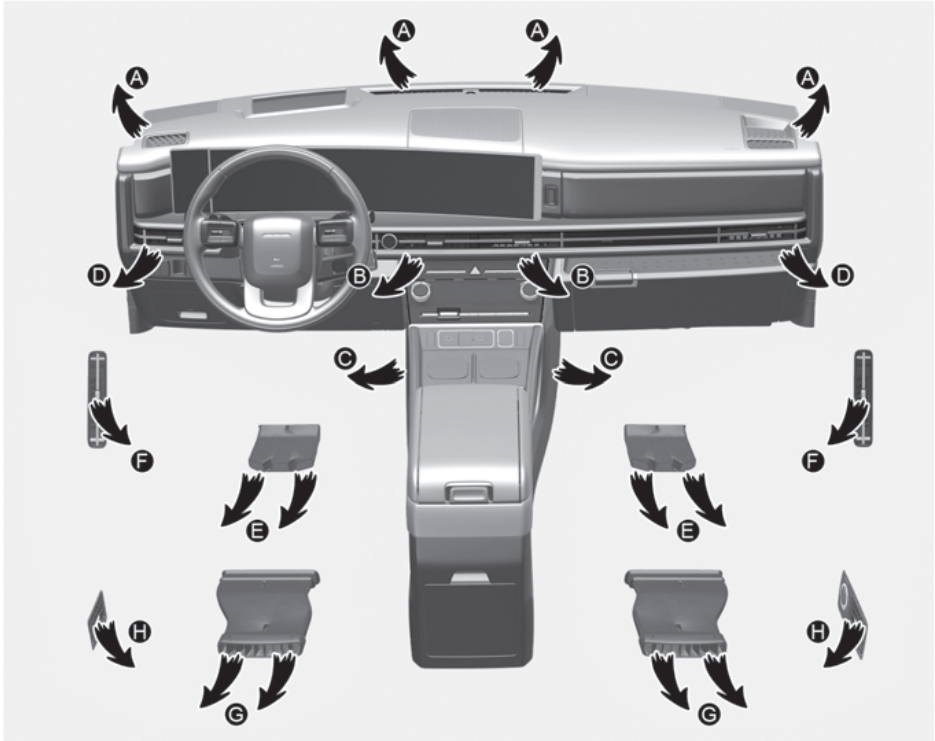

Symbol	Operation	Direction
	Air flow is directed toward the upper body and face. Additionally, each outlet can be controlled to direct the air discharged from the outlet.	B, D, F
	Air flow is directed toward the face and the floor.	B, C, D, E, F, G
	Most of the air flow is directed to the floor, with a small amount of the air being directed to the windshield and side window defrosters.	A, C, D, E, G
	Most of the air flow is directed to the floor and the windshield with a small amount directed to the side window defrosters.	A, C, D, E, G

3rd row outlet vents (G, H)

 if equipped

- The air flow of 3rd row outlet vents (G) is controlled by the front climate control system and delivered through the inside air duct of the floor.
- The air flow of the 3rd row outlet vents (G) may be weaker than the instrument panel vents for the long air duct.
- The air flow of 3rd row side vents (H) is controlled by the 3rd row seat air conditioning button and knob.

Front windshield defroster [A], [D]



Press the A/C button to manually turn on the system on (indicator light ON) and off.

Press the front windshield defroster button (indicator light ON) to turn on the front windshield defroster. If the windshield defogging is set, outside (fresh) mode is automatically selected and the air conditioning turns on according to the detected ambient temperature.

Press the front windshield defroster button once more (indicator light OFF) to turn the function off. Each climate control setting reverts to the setting prior to selecting the front windshield defrost.

Instrument panel vents

Front

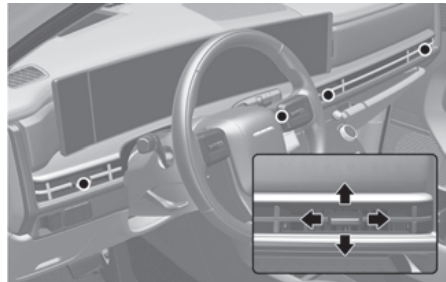

2nd row center

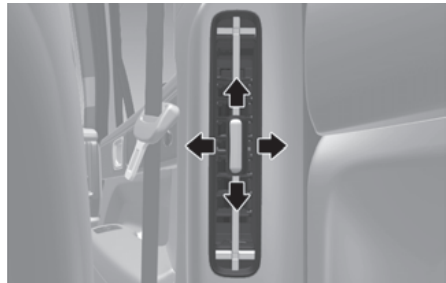

The instrument panel vent air flow can be directed up/down or left/right using the vent adjustment lever.

Move the lever all the way to the ⊗ direction to close, and to the ☰ direction to open the air vents.

Temperature control

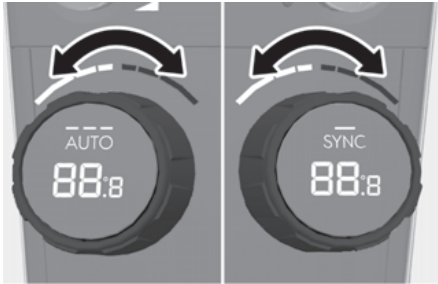

The temperature increases by turning the knob to the right (red side). The temperature decreases by turning the knob to the left (blue side).

Temperature conversion (°C ↔ °F)

To change the temperature unit from °C to °F or °F to °C:

Select **Setup > General > Units > Temperature Unit > °C/°F** in the infotainment system.

i Information

The infotainment system may change after software updates. For more information, refer to the user's manual provided in the infotainment system and the quick reference guide.

Driver only

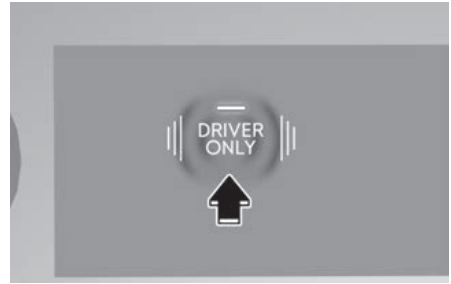

If you press the **DRIVER ONLY** button (indicator light ON), most of the air flow is directed toward the driver's seat.

i Information

Some of the airflow may be directed to other seating position to keep indoor air pleasant while using **DRIVER ONLY**.

When using the front windshield defroster, the air flow on the both sides of windshield continues to operate regardless of the activation of **DRIVER ONLY**.

SYNC (Adjusting the driver and passenger side temperature equally)



Adjusting the temperature equally

Press the **SYNC** button (indicator light ON) to adjust the driver and passenger side temperature equally.

Adjusting the temperature individually

Press the **SYNC** button (indicator light OFF) again to adjust the driver and passenger side temperature individually.

Air intake control

To select outside (fresh) air or recirculated air, press this button.

Recirculated air position



With the recirculated air selected, air from the passenger compartment is drawn through the climate control system.

Outside (fresh) air position



With the outside (fresh) air selected, air enters the vehicle from outside and is drawn through the climate control system.

i Information

Using the system in the fresh air position is recommended.

Prolonged operation of the heater in the recirculated air position (without air conditioning selected) can cause fogging of the windshield and side windows and the air within the passenger compartment will become stale.

In addition, prolonged use of the air conditioning with the recirculated air position selected will result in excessively dry air in the passenger compartment.

! WARNING

To prevent serious injury or death:

- Continued climate control system operation in the recirculated air position may allow humidity to increase inside the vehicle that could fog the windshield and the side windows and obscure visibility.
- Do not sleep in a vehicle with the air conditioning or heating system on.
- Continued climate use of recirculated air may cause drowsiness or sleepiness, and loss of vehicle control. Set the air intake control to the outside (fresh) air position while driving.

Fan speed control



- Press the **↓** button to increase fan speed and airflow.
- Press the **↑** button to decrease fan speed and airflow.

i Information

Operating the fan speed when the Engine Start/Stop button is in the ON position may cause the battery to discharge.

Air conditioning



Press the **A/C** button to manually turn on the air conditioning system (indicator light ON) and off.

OFF mode

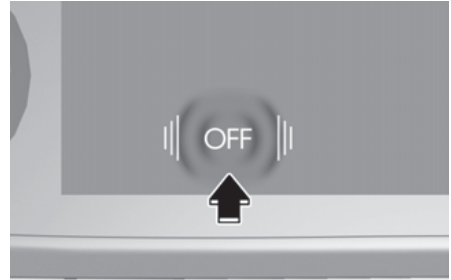

Press the **OFF** button to turn off the climate control system.

You can still operate the mode buttons and air intake buttons as long as the Engine Start/Stop button is in the ON position.

3rd row air conditioning

Control on 1st row

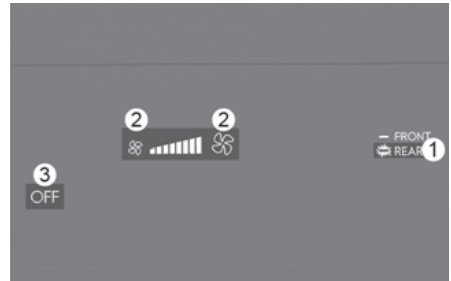

1. Press the 3rd row air conditioning FRONT/REAR button (1) located on the front climate control panel and set the fan speed to the desired speed with the fan speed button (2). (indicator light on the REAR button will illuminate).
2. To turn off the 3rd row air conditioning control system, press the OFF button (3).

i Information

If there is no button operation for 5 seconds, the rear climate control screen switches to the front climate control screen.

Control on 3rd row



- Press the air conditioning button (1) on the 3rd seat to start the system. (indicator light ON)

The air conditioning button on the front seat will also illuminate to inform the driver that the system is running in the 3rd row.

Press the air conditioning button (1) on the 3rd seat to turn off the system in the 3rd row. (indicator light OFF)

- Control the Fan speed control knob (2) from the 3rd seat to separately set the fan from the front seat.
- Water dripping on the ground of the vehicle is normal after the use of the air conditioning.

- Avoid prolonged operation of the air conditioning in the circulated air position when operating in/outside mode. Carefully adjust to let outdoor air circulate regularly.
- Use the air conditioning system every week for around 5 minutes at once to avoid the potential breakdown of the system.

- Open the windows for a short time to let the hot air inside the vehicle escape.

Excessive use of air conditioning during the hot summer may increase moisture outside the window due to the difference between the temperature of the outside and inside the vehicle. Change the air flow direction and adjust the air control to the lowest level.

- In humid weather, if the windows are open and the air conditioning is running, water droplets may form inside the vehicle and around the air vent. In this case, use the air conditioning system with the windows closed to prevent any potential damage to electrical equipment.

Avoid leaves, snow, or other objects to block the grill as the source of air for the heater and air conditioning flows into the grill. When cooling, foggy air can be seen as the outside air draws into the vehicle. This is a normal condition since the humid air flows into the vehicle while cooling the vehicle rapidly.



System operation

Ventilation

1. Set the mode to the  position.
2. Set the air intake control to the outside (fresh) air position.
3. Set the temperature control to the desired position.
4. Set the fan speed control to the desired speed.

Heating

1. Set the mode to the  position.
2. Set the air intake control to the outside (fresh) air position.
3. Set the temperature control to the desired position.
4. Set the fan speed control to the desired speed.
5. If desired, turn the air conditioning ON with the temperature control knob set to heat in order to dehumidify the air before it enters into the cabin.

If the windshield fogs up, set the mode to the  or  position.

Operation Tips

- To help keep dust or unpleasant fumes from entering the vehicle through the ventilation system, temporarily set the air intake control to the recirculated air position. Be sure to return the control to the fresh air position when the irritation has passed to keep fresh air in the vehicle. This can help keep the driver alert and comfortable.
- To prevent interior fog on the windshield, set the air intake control to the fresh air position and the fan speed to the desired position, turn on the air conditioning system, and adjust the temperature control to the desired temperature.

Air conditioning

1. Start the engine. Press the air conditioning button.
2. Set the mode to the  position.
3. Set the air intake control to the outside air or recirculated air position.
4. Adjust the fan speed control and temperature control as desired.

NOTICE

- When using the air conditioning system, monitor the temperature gauge closely while driving up hills or in heavy traffic when outside temperatures are high. Continue to use the fan but turn off the air conditioning system if the temperature gauge indicates the engine is overheating.
- Always use the air conditioning with the windows closed. In humid weather, if the windows are open and the air conditioning is running, water droplets may form inside the vehicle and potentially damage electrical equipment.

Air conditioning system operation tips

- If the vehicle has been parked in direct sunlight during hot weather, open the windows for a short time to let the hot air inside the vehicle escape.
- After sufficient cooling has been achieved, switch back from the recirculated air position to the fresh outside air position.
- To help reduce moisture inside of the windows on rainy or humid days, decrease the humidity inside the vehicle by operating the air conditioning system with the windows and sunroof closed.
- Use the air conditioning system every month for a few minutes to ensure maximum system performance.
- If you operate the air conditioner excessively, the difference between the temperature of the outside air and that of the windshield may cause the outer surface of the windshield to fog up, causing loss of visibility. In this case, set the mode selection button to the  position and set the fan speed control knob to the lowest speed setting.

System maintenance

Cabin air filter

The cabin air filter is installed behind the glove box. It filters the dust or other pollutants that enter the vehicle through the heating and air conditioning system. Have the cabin air filter replaced by an authorized HYUNDAI dealer according to the maintenance schedule. If the vehicle is being driven in severe conditions such as dusty or rough roads and/or if transporting pets or occupants smoke inside the vehicle, then more frequent cabin air filter inspections and changes are required.

Information

- Replace the filter according to the Maintenance Schedule.
 - If the car is being driven in severe conditions such as dusty, rough roads, more frequent cabin air filter inspections and changes are required.
 - When the air flow rate suddenly decreases, have the system inspected by an authorized HYUNDAI dealer.
-

Checking the amount of air conditioner refrigerant

If the amount of refrigerant is too low or too high, the performance of the air conditioning is reduced. Have the system inspected by an authorized HYUNDAI dealer.

NOTICE

- The refrigerant system should only be serviced by trained and certified technicians in a well-ventilated area to ensure proper and safe operation.
- Never repair the air conditioning evaporator (cooling coil) or replace with the one removed from a used or salvaged vehicle. A new replacement evaporator must be certified (and labeled) as meeting SAE Standard J2842.

WARNING



To prevent serious injury, have the air conditioning system be serviced by only trained and certified technicians. R-1234yf is flammable and operated at high pressure. Reclaim all refrigerants with proper equipment. Venting refrigerants directly to the atmosphere is harmful to individuals and environment.

Air conditioning refrigerant label



You can find out which air conditioning refrigerant is applied to your vehicle on the label located inside of the hood.

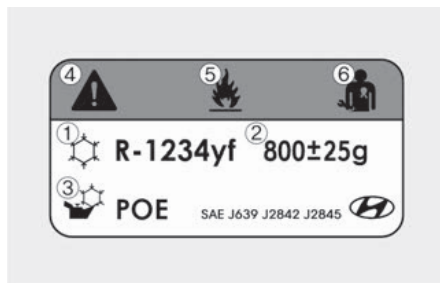



Each symbol and specification on the air conditioning refrigerant label is represented as the following:

- (1) Classification of refrigerant
- (2) Amount of refrigerant
- (3) Classification of Compressor lubricant
- (4) Caution
- (5) Flammable refrigerant
- (6) To require registered technician to service air conditioning system

Windshield Defrosting And Defogging

WARNING

Do not use the defrost-level  position during the cooling operation in extremely humid weather. The outer surface of the windshield may fog and reduce visibility, causing a collision that results in serious injury or death.

Set the mode selection button to the face-level  position and lower the fan speed.

- For maximum defrost performance, set the temperature control to the highest temperature setting and the fan speed control to the highest setting.
- If warm air to the floor is desired while defrosting or defogging, select the floor-defrost position.
- Before driving, clear all snow and ice from the windshield, rear window, side view mirrors, and all side windows.
- Clear all snow and ice from the hood and air inlet to improve heater and defroster efficiency and to reduce the probability of fogging up the inside of the windshield.

Automatic climate control system

To defog inside windshield

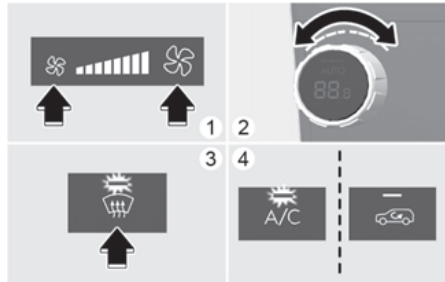

- (1) Select the desired fan speed.
- (2) Select the desired temperature.
- (3) Touch the defroster button
- (4) The air conditioning turns on according to the detected ambient temperature, the outside (fresh) air mode and higher fan speed are selected automatically.

If the air conditioning, outside (fresh) air mode and higher fan speed are not selected automatically, adjust the corresponding switch.

If the defrost switch is selected, the fan speed increases.

To defrost outside windshield

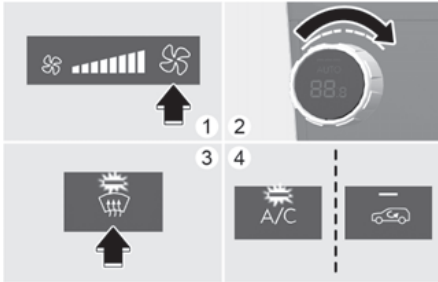

- (1) Set the fan speed to the highest position.
- (2) Set the temperature to the hottest (HI) position.
- (3) Touch the defroster button
- (4) The air conditioning turns on according to the detected ambient temperature and the outside (fresh) air mode is selected automatically.

If the defrost switch is selected, lower fan speed is adjusted to higher fan speed.

Rear window defroster

NOTICE

Never use sharp instruments or window cleaners containing abrasives to clean the window to prevent damage to the rear window defroster.

The defroster heats the window to remove frost, fog, and thin ice from the interior and exterior of the rear window, while the engine is running.

- To activate it, press the rear window defroster button located in the center control panel. The indicator on the rear window defroster button illuminates when the defroster is ON.



- To turn it off, press the rear window defroster button again.

i Information

- If there is heavy accumulation of snow on the rear window, brush it off before operating the rear defroster.
- The rear window defroster automatically turns off after about 20 minutes or when the Engine Start/Stop button is in the OFF position.

Side view mirror defroster

 if equipped

The side view mirror defrosters operate when you turn on the rear window defroster.

Climate Control Additional Features

i Information

The infotainment system may change after software updates. For more information, refer to the user's manual provided in the infotainment system and the quick reference guide.

Air conditioning auto-drying

The Air conditioning auto-drying feature dries the moisture in the air conditioner and reduces air conditioner odor. The blower motor automatically operates 30 minutes after the engine is turned off.

Turning Air conditioning auto-drying on or off

The Air conditioning auto-drying feature can be turned on and off by selecting **Vehicle > Climate > Climate Features > A/C Automatic Drying** from the infotainment system.

If the operating condition is satisfied after setting the feature, the operating condition appears on the infotainment system and the blower motor automatically operates.

When the Air conditioning auto-drying feature is activated, the air conditioner sets the fan speed to the third level, selects outside (fresh) mode, and directs the air flow toward the face.

Operating conditions

The Air conditioning auto-drying feature operates under the following conditions:

- The vehicle is turned off after operating the air conditioner for a certain period.
- The battery level is sufficient and the outside temperature is above a certain level.

Non-operating conditions

The Air conditioning auto-drying feature stops operating under the following conditions:

- The A/C Automatic Drying feature has operated for 10 minutes.
- The Engine Start/Stop button is pressed, or the engine is on.
- The climate control system is operated remotely.

i Information

The Air conditioning auto-drying feature reduces air conditioner odors but may not remove all odors.

Auto defogging system

 if equipped

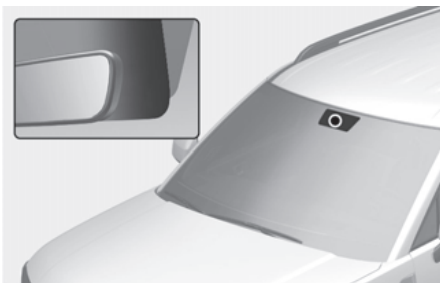

The Auto defogging reduces the possibility of fogging up the inside of the windshield by automatically sensing the moisture on inside the windshield.

The auto defogging system operates when the heater or air conditioning is on.

i Information

The Auto defogging system may not operate normally, when the outside temperature is below 14 °F (-10 °C).

When the Auto Defogging System operates, the /Auto indicator illuminates.

If high amount of humidity is detected in the vehicle, the Auto defogging system is enabled.

The following steps are performed automatically:

Step 1. Air conditioning turns on and Outside (fresh) mode is selected.

Step 2. Defrost level is selected.

Step 3. Fan speed is set to the highest level.

If the air conditioning is off or recirculated air is manually selected while Auto defogging system is ON, the Auto defogging system /Auto indicator blinks to signal that manual operation has been canceled.

Turning the Auto defogging system on or off

Climate control system

- On
 1. Press the front windshield defroster button for 3 seconds when the Engine Start/Stop button is in the ON position.
 2. The defroster button indicator blinks 6 times.
- Off
 1. Press the front windshield defroster button for 3 seconds when the Engine Start/Stop button is in the ON position.
 2. The defroster button indicator blinks 3 times.

Infotainment system

Auto Defogging System can be turned on and off by selecting **Vehicle > Climate > Defog/Defrost Options > Auto Defog** from the infotainment system.

i Information

- Do not select recirculated air while the Auto defogging system is operating.
- When Auto defogging system is operating, fan speed adjustment, temperature adjustment, and air intake control selection are all disabled.

NOTICE

Do not remove the sensor cover located on the top of the windshield glass. Damage may not be covered by your vehicle warranty.

Auto dehumidify

 If equipped

To increase cabin air quality and reduce windshield misting, recirculation mode switches off automatically after about 5 to 30 minutes, depending on the outside temperature, and the air intake changes to fresh mode.

Turning Auto dehumidify on or off

Climate control system

To turn the Auto dehumidify feature on or off, select Face level (↔) mode and press the air intake control (↻/↻) button at least 5 times within 3 seconds while pressing the A/C button. When Auto dehumidify is turned on, the air intake control button indicator blinks 6 times. When turned off, the indicator blinks 3 times.

Infotainment system

Auto dehumidify can be turned on and off by selecting **Vehicle > Climate > Automatic Ventilation > Automatic Dehumidify** from the infotainment system.

Recirculating air when washer fluid is used

 if equipped

Recirculation mode automatically activates to reduce the scent of the washer fluid entering the cabin when the windshield washer is used.

When it is shifted to the recirculation mode, the unpleasant scent may flow into the vehicle.

However, in cold weather to prevent the windshield from fogging up, the recirculation mode may not be selected.

Turning Activation on a washer fluid use on or off

Climate control system

To turn the Activate on washer fluid use feature on or off, select Floor level (ﻟﻮﺟﻪ) mode, and then press the air intake control (ﻣﻮﺩﻩ/ﻣﻮﺩﻩ) button 5 times within 3 seconds while pressing the A/C button.

When Activate on washer fluid use is turned on, the air intake control button indicator blinks 6 times. When turned off, the indicator blinks 3 times.

Infotainment system

Activate on washer fluid use can be turned on and off by selecting **Vehicle > Climate > Recirculate Air > Activate upon Washer Fluid Use** from the infotainment system.

Recirculating air when entering a tunnel

 if equipped

To prevent the inflow of polluted air into the vehicle when passing through a tunnel, the windows and climate control system are operated using the navigation map information and vehicle speed as follows:

To use this feature, it can be enabled from the infotainment system. Select: **Setup > Vehicle > Climate > Recirculate Air**

- **When Entering Tunnels:** The vehicle's windows automatically close, and the climate control system switches to recirculation mode for about 7 seconds before entering a tunnel.

The windows open to the previous position after passing through the tunnel. If the power window switch is operated before the windows open, the windows do not return to the previous position.

Operating conditions

- The climate control system's fresh mode is selected.
- The window(s) are open.
The windows close automatically only when your vehicle is applied with the automatic up/down window feature for all seats.

***i* Information**

- The activation time for the feature may differ because of the time gap between the GPS and vehicle speed.
 - The feature activates until you have passed through continuous tunnels.
 - When entering a tunnel, recirculation mode may cause fogging of the windshield. Use the front windshield defroster button.
If the humidity is high, it may automatically change to fresh air mode for safety reasons.
 - The feature does not operate in short tunnels.
 - The feature may not activate if the GPS is not working properly.
 - The infotainment system may change after software updates. For more information, refer to the user's manual provided in the infotainment system and the quick reference guide.
-

***i* Information**

Be careful not to get any body parts caught when the windows are closing.

Scheduled ventilation control

 If equipped

The Scheduled Ventilation Control releases hot air in the vehicle to lower cabin temperature before getting in the vehicle.

Depending on the outside ambient temperature, the blower is operated for 5 to 15 minutes while the vehicle is parked.

Turning Schedule Ventilation Control On or Off

The Schedule Ventilation Control can be turned on and off by selecting **Setup > Vehicle > Climate > Automatic Ventilation > Scheduled Ventilation** from the infotainment system. Also, the starting time can be set within 24 hours. Schedule Ventilation Control operates only once when the feature is set.

***i* Information**

The infotainment system may change after software updates. For more information, refer to the user's manual provided in the infotainment system and the quick reference guide.

Storage Compartment

WARNING

Never store cigarette lighters, propane cylinders, or other flammable/explosive materials in the vehicle. These items may catch fire and/or explode if the vehicle is exposed to hot temperatures for an extended period of time.

WARNING

Always keep the storage compartment covers closed securely while driving. Items inside your vehicle are moving as fast as the vehicle. If you have to stop or turn quickly, or if there is a collision, the items may fly out of the compartment and may cause an injury if they strike the driver or passengers.

NOTICE

To avoid possible theft, do not leave valuables in the storage compartments.

Two-way multi console



You can use this space to store small items etc.

- When sitting in the front seat, press button (1) to open the console cover towards the 1st row seats.
- When sitting in the 2nd row seats, press button (2) to open the console cover towards the 2nd row seats.

If you remove the internal storage box, you can use both the upper and lower trays to store larger items.

Remove the internal storage box and use the upper/lower tray to store large-sized items. You can store the removed storage box in the front tray.

WARNING

- After removing the storage box, do not pull the sliding tray lever when loading large items. This can damage your belongings.
- Avoid storing food items in the two-way multi console for extended periods.

CAUTION

Make sure body parts are out of the way when closing the console cover after use.

Glove box

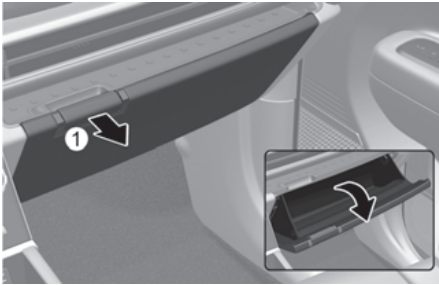

To open:

Pull the lever (1).

Always close the glove box door after use.

WARNING

An open glove box door may cause serious injury to a passenger in a collision, even if the passenger is wearing a seat belt.

Passenger seat open tray

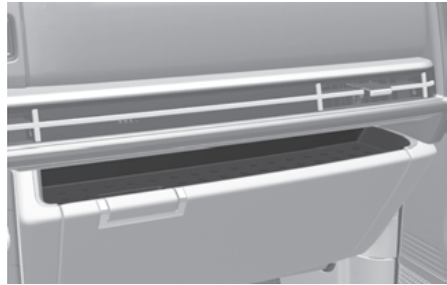

You can use this space to store small items etc.

WARNING

Do not put sharp objects in the tray. In a collision, they can come loose from the tray and injure occupants.

Passenger seat multi tray



You can use this space to store small items etc.

To open:

Push the button (1).

Always close the door after use.

WARNING

Do not put any sharp object in the open tray. It may seriously injure you in the event of a sudden stop or a collision.

Front tray

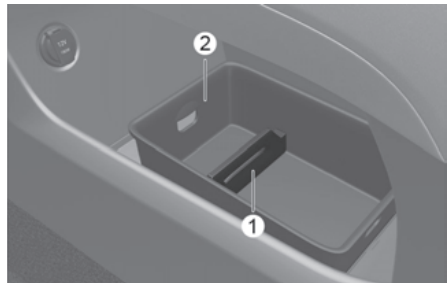

Use this tray to store the detachable front tray (2) from the console or larger items such as tissue boxes and wet wipes.

The removable partition (1) of the front tray (2) can be taken out for expanded use.

WARNING

Do not put sharp objects in the tray. In a collision, they can come loose from the tray and injure occupants.

Sliding tray

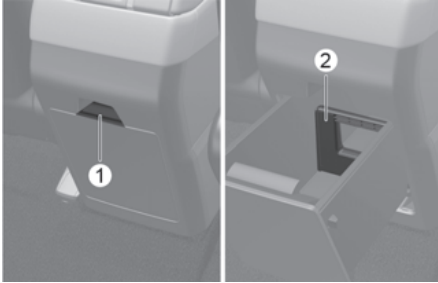

You can use this space to store long items etc.

To open:

Pull the lever (1).

You can use the removable partition (2) to segment the space as needed.

CAUTION

Avoid storing food items in the sliding tray for extended periods.

Cargo tray

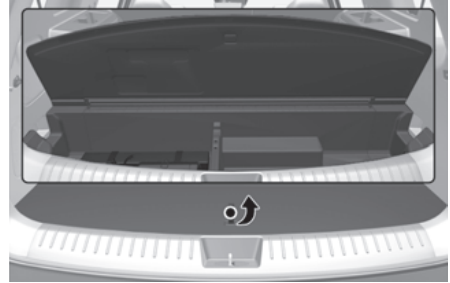

Use the cargo tray to organize and store small items such as tools. To use the tray, lift the luggage floor by the handle.

CAUTION

- When storing small or easily movable items, they may cause noise while driving.
- Do not store fragile items in the cargo tray.

Interior Features

Cup holder

Front



2nd row

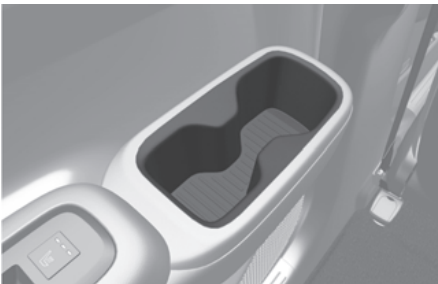

2nd row armrest (7-seater)

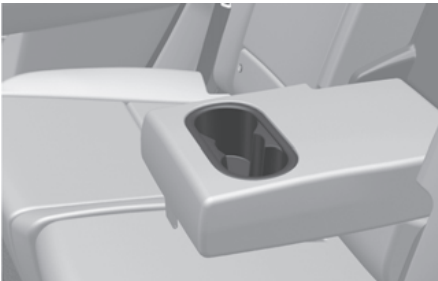

3rd row

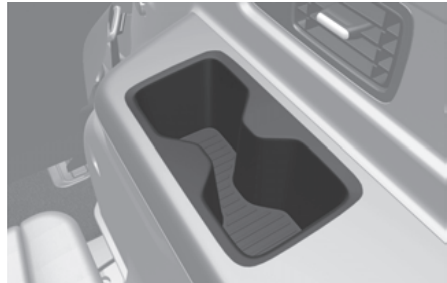

Cups or small beverages cups may be placed in the cup holders.

WARNING

- Avoid abrupt starting and braking when the cup holder is used to prevent spilling your drink. If hot liquid spills, you may be burned.
Such a burn to the driver may cause loss of vehicle control resulting in a collision.
- Only use soft cups in the cup holders.

WARNING

Keep cans or bottles out of direct sun light and do not put them in a hot vehicle. It may explode.

NOTICE

- Keep your drinks sealed while driving to prevent spilling.
- When cleaning spilled liquids, do not use hot air to blow out or dry the cup holder.

UV-C sterilizer system

 if equipped

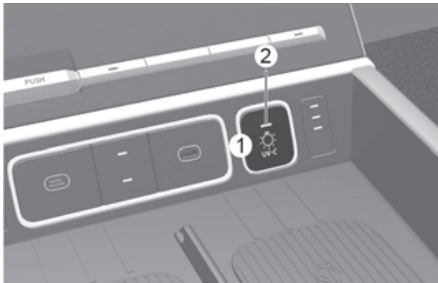

- (1) UV-C sterilizer system button
- (2) UV-C Indicator light
- (3) UV-C sterilizable multi tray open button

The passenger seat multi tray is equipped with an antibacterial sterilization system for personal belongings.

WARNING

- Press the button to turn UV-C function off when it is not in use. Being exposed to ultraviolet rays from UV-C LED may be harmful to your skin and eyes.
- Do not place magnetic items (magnets, etc.) near the front part of the UV-C tray cover. It may cause malfunction to the UV-C sensor and unnecessarily operate the UV-C function.

CAUTION

- Press the button to turn UV-C function off when it is not in use. Prolonged exposure under ultraviolet rays may change the color and shape of the object.
- Do not sterilize food. Food cannot be sterilized. Prolonged exposure to ultraviolet rays may damage the wrapping or container and affect the food inside.

Using UV-C sterilizer system





Place the item in the UV-C tray and turn it on. Within 10 minutes, up to 99.9% of germs on the surface can be removed.

1. Press the UV-C tray open button (3) to open the UV-C tray while the engine is running.
2. Place the item in the tray.
3. Close the tray cover and press the UV-C sterilizer system button (1).
 - UV-C sterilizer system indicator light (2) illuminates.
 - UV-C LED is turned on and sterilization begins.
 - After 10 minutes, the UV-C indicator light (2) turns off as sterilization is complete.
4. If you want to sterilize again, close the UV-C tray cover and press the UV-C sterilizer system button (1) again.

i Information

- Only place the item which requires sterilization. Storing other items in the storage box may reduce the sterilization effect.
- UV-C sterilizer system does not guarantee 99.9% sterilization. The sterilization effect varies depending on the degree of exposure to UV-C light and the shape of the item. For effective use, change the position of the item and run additional sterilization.
- UV-C indicator light (2) blinks or does not operate properly, visit an authorized HYUNDAI dealer.

Unit item certification number

Certification mark		Unit item certification number
KC		R-R-h17-MX5-LHD001
MET/NRTL		Listing#: E115727
CE		Ref No. 36-10672
FCC		TRE FCC23-0030
EPA		ESTABLISHMENT NUMBER : 100891-KOR-1

- This appliance is not intended for use by persons (including children) with reduced physical, sensory or mental capabilities, or lack of experience and knowledge, unless they have been given supervision or instruction concerning use of the appliance by a person responsible for their safety.
- For your safety, this appliance complies with the applicable standards and regulations (Low Voltage Directive, Electromagnetic Compatibility, Environmental, etc.)
- This product uses the vehicle's battery voltage and should be used only at DC 9 V-16 V

! WARNING

This product emits ultraviolet rays. Do not gaze upon the UV rays while using the product. Exposing the eyes or skin to UV rays may have harmful effect to the body.

Sunvisor

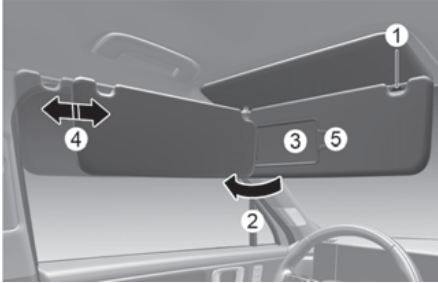

To use the sunvisor, pull it downward.

To use the sunvisor to block the sun from the side window, pull it downward, release it from the bracket (1) and swing it to the side (2) toward the window.

To use the vanity mirror, pull down the sunvisor and slide the mirror cover (3).

Adjust the sunvisor forward or backward (4) as needed. Use the ticket holder (5) to hold tickets.

Close the vanity mirror cover securely and return the sunvisor to its original position after use.

WARNING

Do not block your view when using the sunvisor.

Power outlet

Front



Cargo area

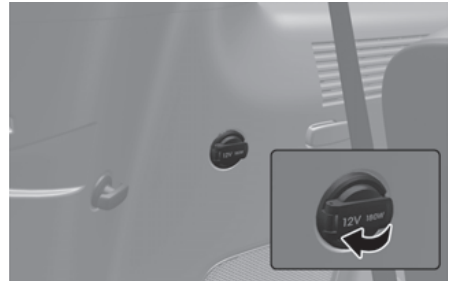

The power outlet is designed to provide power for mobile phones or other devices designed to operate with vehicle electrical systems. The devices should draw less than 12 V, 180 W with the engine running.

WARNING

Avoid electrical shocks. Do not place your fingers or foreign objects (pin, etc.) into a power outlet or touch the power outlet with a wet hand.

NOTICE

To prevent damage to the power outlets:

- Use the power outlet only when the engine is running and remove the accessory plug after use. Using the accessory plug for an extended period of time with the engine off may cause the battery to discharge.
- Only use 12 V electric accessories that are less than 180 W in the electric capacity.
- Adjust the air conditioner or heater to the lowest operating level when using the power outlet.
- Close the cover when not used.
- Some electronic devices may cause electronic interference when plugged into a vehicle's power outlet.
- Push the plug in as far as it goes. The plug may overheat and the fuse may open.
- Only connect devices with reverse current protection or the current from the device battery may cause the vehicle's electrical/electronic system to malfunction.

USB charger

The USB charger is designed to recharge batteries of small size electronic devices using a USB cable.

Front (type A)

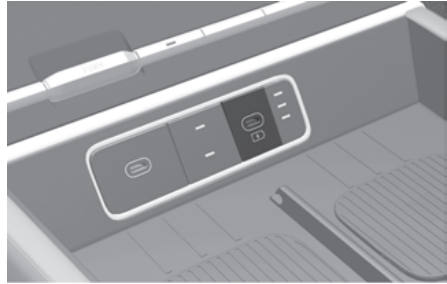

Front (type B)

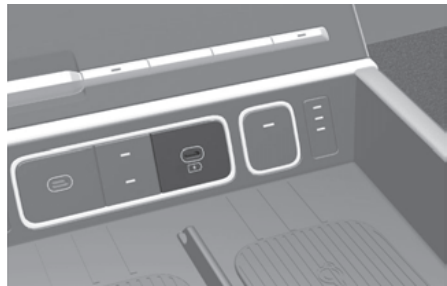

2nd row

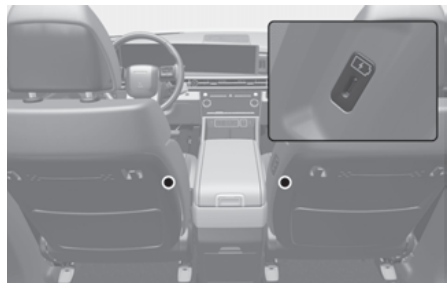

3rd row

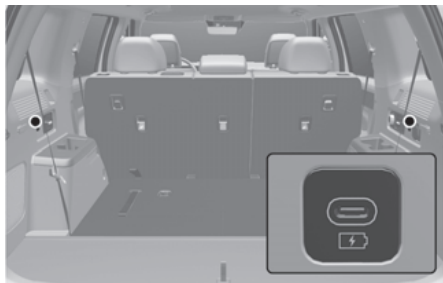

The USB charger is designed to recharge batteries of small size electronic devices using a USB cable.

Electronic devices can be charged when the engine is running.

i Information

- The battery charging state may be monitored on the electronic device.
- Disconnect the USB cable from the USB port after use.
- A smartphone or a tablet PC may get warmer during the recharging process. It does not indicate any malfunction with the charging system.
- A smartphone or a tablet PC that does not use a USB cable to charge should be charged using its own charger.
- Do not attempt to use the charging terminal either to turn on an audio or to play media with the infotainment system.
- Charging may not be possible when using a Type-C to A converter sold by a mobile phone manufacturer or commercially available.

NOTICE

- Use the USB charger when the engine is running. Using the USB charger for prolonged periods of time with the Engine Start/Stop button in the ON position (engine off) may cause the battery to discharge.
- To prevent damage to the USB charger:
 - Do not insert foreign objects or spill liquid into the outlet. The USB charging terminal may be damaged.
 - Do not use devices with working current exceeding 3,000 mA (3.0 A).
- When charging an electrical device by using an USB converting adapter (C to A type), use a genuine adapter specified for your vehicle. A commonly used adapter is not equipped with any measures to prevent over current and maintain stability.

Using an unspecified cable may damage the vehicle's USB charger or the connected devices. Contact an authorized HYUNDAI dealer for more information on accessories for HYUNDAI vehicles.
- The use of non-genuine parts may damage the USB port and infotainment system. Damage cannot be covered by your vehicle warranty.

Wireless smartphone charging system

 If equipped

Type A

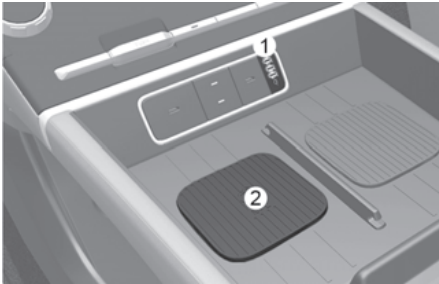

Type B

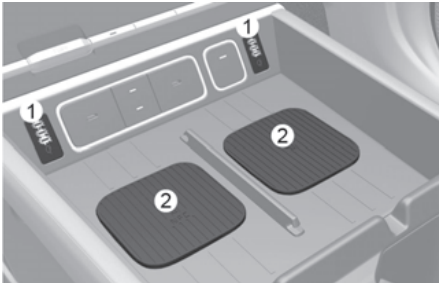

- (1) Indicator light
- (2) Charging pad

Charging your smartphone

The wireless smartphone charging system charges only Qi-enabled smartphones (📱). Visit your smartphone manufacturer's website to check whether your smartphone supports the Qi technology.

The wireless charging process starts when you put a Qi-enabled smartphone on the wireless charging unit with the screen facing up.

1. The wireless smartphone charger is available when all doors are closed, and when the Engine Start/Stop button is in the ON or START position.
2. Turn on the wireless charging function from the Settings menu in the infotainment system. Select:
Setup > Vehicle > Convenience > Wireless Charging System for Mobile Devices
3. Place the smartphone on the center of the wireless charging pad. The indicator light is orange when the smartphone is charging and turns blue when phone charging is complete.

Information

Remove other items, including the smart key and the card key from the wireless charging pad.

If your smartphone is not charging:

- Move the smartphone on the charging pad.
- Make sure the indicator light is orange.

The indicator light blinks orange for 10 seconds if there is a malfunction in the wireless charging system.

The system warns you with a message on the cluster display if the smartphone is still on the wireless charging unit after the vehicle is turned OFF and the front door is opened.

NOTICE

- The wireless smartphone charging system may not support smartphones that do not meet the Qi specification (Φ).
 - Wireless charging may stop temporarily when the smart key is used, or when starting the vehicle or locking/unlocking the doors.
 - When charging certain smartphones, the charging indicator may not change to blue when the smartphone is fully charged.
 - The wireless charging process may temporarily stop, when the temperature abnormally increases inside the wireless smartphone charging system. The wireless charging process does not restart, until the temperature falls.
 - The wireless charging process may stop when there is any metallic item, such as coin, between the wireless smartphone pad and smartphone.
 - For some manufacturer's smartphones, the system may not warn you even though the smartphone is left on the wireless charging unit. This is due to the particular characteristic of the smartphone and not a malfunction of the wireless charging.
 - When using a smartphone application, such as Android Auto, while charging, the charging process may be delayed or interrupted due to the smartphone overheating. This issue is not related to the wireless charging system but rather caused by the smartphone's self-heating. Therefore, disconnect the smartphone from the charging pad.
 - If the smartphone has a thick case, it may not charge.
 - Some magnetic items such as credit cards, phone cards, or transit cards may be damaged if left with the smartphone during the charging process.
 - When any smartphone without a wireless charging function or a metallic object is placed on the charging pad, a small noise may sound because the vehicle discerns compatibility of the object placed on the charging pad. It does not affect your vehicle or the smartphone.
 - If the Engine Start/Stop button is OFF, the charging stops.
-

AC Inverter

 If equipped

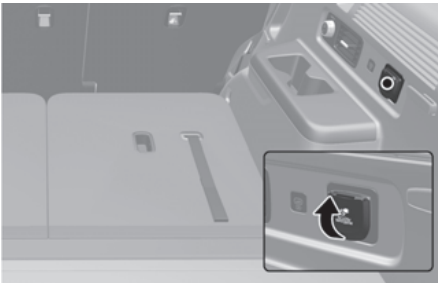

The AC inverter supplies 220 volts/200 watts (or 115 volts/150 watts) electric power to operate electric accessories or equipment.

Information

- Rated voltage : AC 220 volts or 115 volts
- Maximum electric power : 200 watts or 150 watts
- In order to avoid an electrical system failure, electric shock, etc., be sure to read owner's manual before use.
- Be sure to close the cover except the time of use.

WARNING

To reduce a risk of serious or fatal injuries:

- Do not use a heated electric device such as a coffeepot, toaster, heater, iron, etc.
- Do not insert foreign objects into the outlet and do not touch the outlet as you may get shocked.
- Do not let children touch the AC inverter.

NOTICE

- To prevent the battery from being discharged, do not use the AC inverter while the engine is not running.
- When not using the AC inverter, make sure to close the AC inverter cover.
- After using an electric accessory or equipment, pull the plug out. Leaving the accessory or equipment plugged in for a long time may cause battery discharge.
- Do not use an electric accessory or equipment the power consumption of which is greater than 220 volts/200 watts (or 115 volts/150 watts).
- Some electric accessories or equipment can cause electronic interference. It may cause excessive audio noise and malfunctions in other electric systems or devices in the vehicle.
- Do not use broken electric accessories or equipment, which may damage the AC inverter and electrical systems of the vehicle.
- Do not use two or more electric accessories or equipment at the same time. It may cause damage to the electrical systems of the vehicle.
- When the input voltage is lower, outlet LED will blink and the AC inverter will turn off automatically. If the input voltage goes up to normal, the AC inverter will turn on again.

Clock

The clock can be set from the infotainment system.

For more information, refer to the infotainment system manual.

WARNING

Do not attempt to adjust the clock while driving.

Coat hook

2nd row



These hooks are not designed to hold large or heavy items.

WARNING



Only hang soft clothing without heavy, sharp or breakable objects in the clothes pockets. In a collision or when the curtain airbag is inflated, the objects could move and cause serious injury.

Plastic bag hook

Front seat seatback



2nd row seat seatback

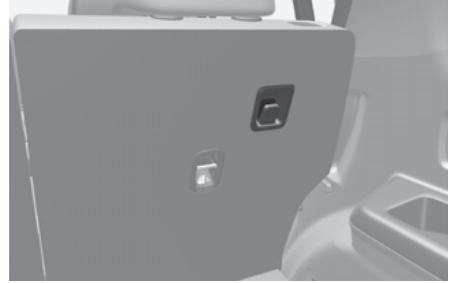

Hooks are located on the back of the 1st and 2nd row seatbacks.

NOTICE

Do not hang heavy items. It may cause damage to the hook.

WARNING

Do not hang hard, sharp, or fragile items on the shopping bag hook. In a collision, these items can cause severe injuries to passengers and damage to the vehicle.

Floor mat anchor(s)

ALWAYS use the Floor Mat Anchors to attach the front and 2nd row floor mats to the vehicle and prevent the mats from sliding forward.

WARNING

To prevent serious injury or death from a floor mat interfering with the brake or accelerator pedals:

- Remove any protective film on the carpet before installing a floor mat.
- Check floor mats are securely attached to the vehicle's floor mat anchor(s) before driving.
- Do not use ANY floor mat that cannot be firmly attached to the vehicle's floor mat anchors.
- Do not stack floor mats on top of another mat (e.g. all weather rubber mat on top of a carpeted floor mat). Only a single floor mat must be installed in each position.
- To avoid any interference with pedal operation, install only HYUNDAI floor mats designed for use in your vehicle.

Rear side sunshade

 If equipped

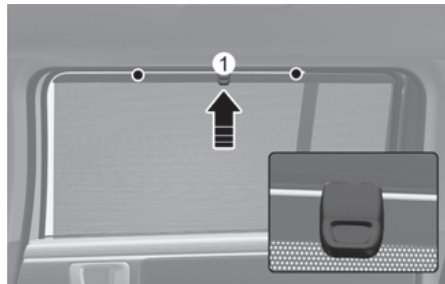

Use the rear side sunshade to block the light coming through the rear seat windows.

1. Lift the rear side sunshade by the hook (1).
2. Hang the rear side sunshade on both sides of the hook.

CAUTION

- Always hang both sides of the rear side sunshade on the hook. This could cause damage to the rear side sunshade if only one side of the sunshade is hooked.
- Do not let any foreign material get in between the vehicle and the rear side sunshade. The rear side sunshade may not be lifted up.

Cargo net holder

 if equipped



To keep items from shifting in the cargo area, use the 4 holders located in the cargo area side trim to attach the cargo net.

Make sure the cargo net is securely attached to the holders in the cargo board.

WARNING

- Avoid eye injury. Do not overstretch the cargo net. Always keep your face and body out of the cargo net's recoil path.
- Do not use the cargo net when the strap has visible signs of wear or damage.
- Use the cargo net to keep only light items from shifting in the cargo area.

Cargo security screen

 if equipped

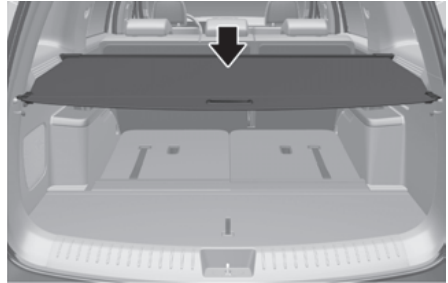

Use the cargo security screen to cover items stored in the cargo area.

Using the cargo security screen

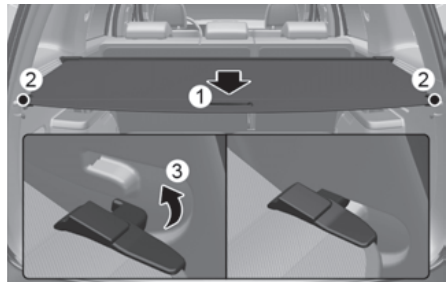

1. Pull the cargo security screen towards the rear of the vehicle by the handle (1).
2. Insert the guide pin (2) into the guide (3)

Information

Pull out the cargo security screen with the handle in the center to prevent the guide pin from falling out of the guide.

When the cargo security screen is not in use:

1. Pull the cargo security screen backward and up to release it from the guides.
2. The cargo security screen will automatically slide back in.

i Information

The cargo security screen may not automatically slide back in if the cargo security screen is not fully pulled out. Pull the cargo screen out all the way and then slowly allow the screen to retract back in.

NOTICE

Since the cargo security screen may be damaged or malformed, do not put luggage on it when it is used.

! WARNING

- Do not place objects on the cargo security screen. Such objects may be thrown around inside the vehicle and possibly injure vehicle occupants during a collision or when braking.
 - Never allow anyone to ride in the luggage compartment. It is designed for luggage only.
 - Maintain the balance of the vehicle and locate the weight as forward as possible.
-

Exterior Features

Roof side rails

+ if equipped

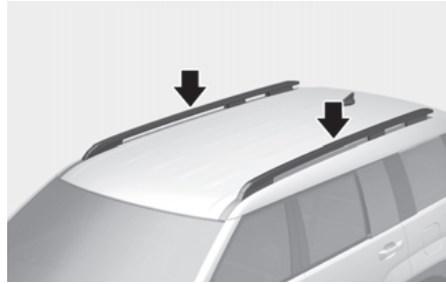

Your vehicle may come equipped with roof side rails. If your vehicle is equipped with roof side rails, you can add roof rack crossbars as an accessory (not shown).

i Information

- If the vehicle is equipped with a sunroof, do not position the cargo onto the roof side rails in such a way that it may interfere with sunroof operation.
 - Always take precautions to make sure the cargo does not damage the roof.
 - When carrying large objects on the roof side rails, make sure they do not exceed the overall roof length or width.
 - When carrying cargo on the roof side rails, take necessary precautions to make sure the cargo does not damage the roof of the vehicle.
 - When carrying large objects on the roof side rails, make sure they do not exceed the overall roof length or width.
-

WARNING

- Loading cargo or luggage in excess of the specified weight limit on the roof side rails may damage your vehicle.

ROOF SIDE RAILS	220 lbs. (100 kg) EVENLY DISTRIBUTED
-----------------	--------------------------------------

- Avoid sudden starts, braking, sharp turns, abrupt maneuvers, or high speeds that may result in loss of vehicle control or rollover resulting in a collision. The vehicle center of gravity is higher when items are loaded onto the roof side rails.
- Always drive slowly and turn corners carefully when carrying items on the roof side rails. Severe wind updrafts caused by passing vehicles or natural causes, can cause sudden upward pressure on items loaded on the roof side rails. This is especially true when carrying large, flat items such as wood panels or mattresses. This may cause the items to fall off the roof side rails and cause damage to your vehicle or others around you.
- To prevent damage or loss of cargo while driving, check frequently before or while driving to make sure the items on the roof side rails are securely fastened.

Hidden type assist handle

 if equipped



[A] Closed
[B] Open

Use the handle for safe boarding and alighting when loading cargo on the roof using the roof rack. To use the hidden type assist handle, follow these steps:

1. Engage the Electronic Parking Brake (EPB).
2. Press the lower part [B] of the hidden type assist handle cover to expose the handle.
3. After use, press the upper part [A] of the handle cover to return it to its original position.
4. By turning the lock mechanism (1) on the hidden type assist handle, you can lock or unlock the cover.

NOTICE

- When not using the hidden type assist handle, turn the lock mechanism (1) to secure the cover.
- When locking the cover, turn the lock mechanism (1) until you hear a 'click' to ensure it's fully engaged.

⚠ WARNING

When using the hidden type assist handle to load cargo on the vehicle's roof, make sure you're on a flat surface and have a firm grip on the handle to prevent falling and potential injuries.

i Information

When stepping on a tire and using the hidden type assist handle, be careful not to slip.

Infotainment System

NOTICE

- Do not install an aftermarket HID headlight. Your vehicle's audio and electronic devices may not function properly.
- Prevent chemicals such as perfume, cosmetic oil, sun cream, hand cleaner, and air freshener from contacting the interior parts because they may cause damage or discoloration.

USB port

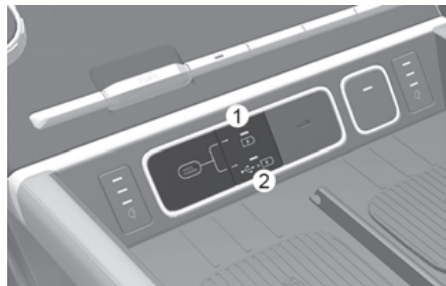

Press the USB port selection button while the vehicle is running. Press the upper portion of the button (1) to charge an electronic device. Press the lower portion of the button (2) to charge and listen to music with a media storage device. The USB port can be used after either indicator light turns on.

- You can use a USB cable to connect audio devices to the vehicle USB port.
- After connecting a media storage device such as a MP3 or USB to the USB port, you can listen to music through the vehicle's speakers or play it on the infotainment system.
- Small electronic devices can be charged.

i Information

- Some devices may not be charged through USB port.
- When using a portable audio device connected to the power outlet, noise may occur during playback. If this happens, disconnect the USB cable and use the portable audio device's power source.

NOTICE

- When connecting a Type-A USB or a memory device to a vehicle, use a genuine converting adapter (C to A type) specified for your vehicle. A commonly used adapter is not equipped with any measures to reduce noise, prevent overcurrent and maintain stability. Connecting an unspecified cable may damage the vehicle's USB port or the connected devices. Contact an authorized HYUNDAI dealer for more information on accessories for HYUNDAI vehicles.



- The use of non-genuine parts may damage the USB port and infotainment system. Damage cannot be covered by your vehicle warranty.

Antenna

Shark fin antenna



- Shark fin antenna receives transmitted signals such as AM/FM and GPS.
- Additional signals are transmitted and received according to vehicle options.

CAUTION

- Be careful of antenna damage by checking the height of the vehicle before entering low-ceiling spaces such as automated parking lots or automated washing machines.
- Be careful not to contact the antenna when loading cargo on the roof rack. Antenna transmission/reception performance may be degraded.

Steering wheel remote controls

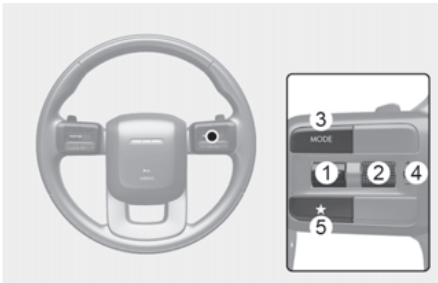

NOTICE

Do not operate multiple audio remote control buttons simultaneously.

SEEK/PRESET (^ / v) (1)

If the SEEK/PRESET switch is pressed up or down and held for 0.8 seconds or more, it functions in the following modes:

RADIO mode

It functions as the AUTO SEEK select button. It seeks until you release the button.

MEDIA mode

It functions as the FF/RW button.

If the SEEK/PRESET switch is pressed up or down, it functions in the following modes:

RADIO mode

It functions as the PRESET STATION UP/DOWN button.

MEDIA mode

It functions as the TRACK UP/DOWN button.

VOLUME (+ / -) (2)

- Rotate the VOLUME scroll up to increase volume.
- Rotate the VOLUME scroll down to decrease volume.

MODE (MODE) (3)

Press the MODE button to toggle through Radio or Media modes.

MUTE (M) (4)

Press the VOLUME scroll to mute or activate the sound.

CUSTOM (★) (5)

Press the CUSTOM button to set frequently used features.

Infotainment System

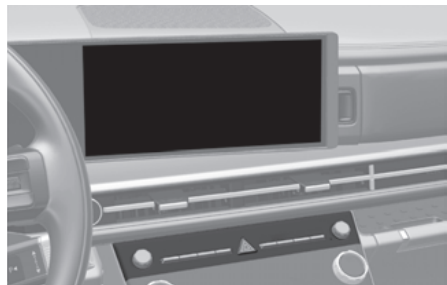

For more information, refer to the infotainment system manual.

Bluetooth® wireless technology

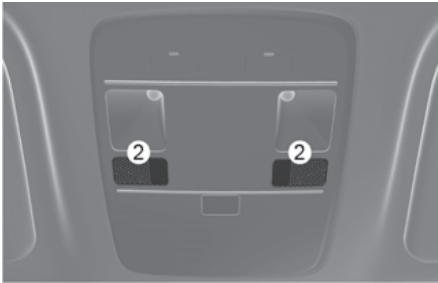
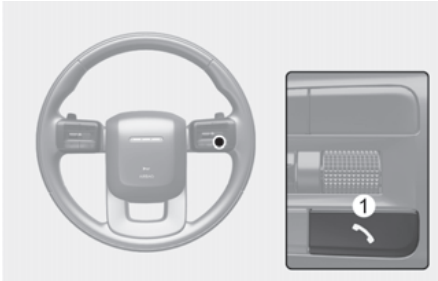

- (1) Call/Call end button
- (2) Microphone

For more information, refer to the infotainment system manual.

CAUTION

To prevent driver distraction, minimize your use of these features while driving. Distraction may cause a collision, resulting in serious injury or death.

Voice Recognition

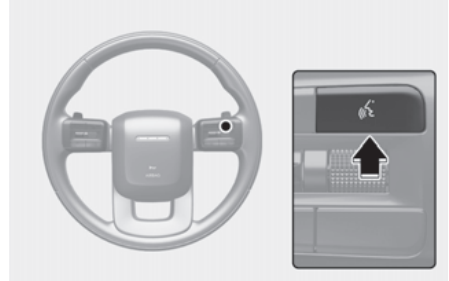

For more information, refer to the infotainment system manual.

6. Driving Your Vehicle

Before Driving	6-4
Before entering the vehicle.....	6-4
Before starting	6-4
Engine Start/Stop Button.....	6-5
Vehicle Auto-shut Off.....	6-10
Operating conditions.....	6-10
Deactivating conditions	6-10
System operation.....	6-10
Automatic Transmission	6-11
Automatic transmission operation	6-11
Cluster display message.....	6-15
Paddle shifter (manual shift mode)	6-16
Good driving practices	6-17
Braking system	6-18
Power-assist brakes.....	6-18
Disc brakes wear indicator	6-19
Electronic Parking Brake (EPB)	6-19
Auto hold	6-22
Anti-lock Brake System (ABS).....	6-24
Electronic Stability Control (ESC).....	6-26
Vehicle Stability Management (VSM).....	6-28
Hill-start Assist Control (HAC).....	6-29
Crosswind Stability Control (CSC).....	6-29
Downhill Brake Control (DBC).....	6-30
Brake Assistant System (BAS).....	6-32
Good braking practices	6-33
Four Wheel Drive (4WD)	6-33
Four wheel drive (4WD) mode	6-34
Emergency precautions	6-38
Regenerative Braking System (paddle Shifter)	6-39
Using the regenerative braking system	6-39
Regenerative braking system limitations.....	6-40
Smart Regeneration System.....	6-42
Smart regeneration system on/off	6-42
Smart regeneration system operating condition	6-42
Smart regeneration level settings.....	6-43

Pausing smart regeneration system	6-43
Front sensor	6-44
Smart regeneration system disabled.....	6-44
Precautions for smart regeneration system	6-44
Coasting.....	6-47
Drive Mode Integrated Control System	6-48
Drive mode features.....	6-49
TOW mode	6-50
Active air flap.....	6-51
Malfunction.....	6-51
Special Driving Conditions	6-52
Hazardous driving conditions.....	6-52
Rocking the vehicle.....	6-52
Smooth cornering.....	6-52
Driving at night.....	6-53
Driving in the rain	6-53
Driving in flooded areas	6-53
Highway driving.....	6-54
Winter Driving	6-54
Snow or icy conditions.....	6-54
Winter precautions.....	6-56
Trailer Towing.....	6-58
If you decide to pull a trailer	6-59
Trailer equipment and accessories	6-61
Driving with a trailer	6-62
Maintenance when towing a trailer	6-64
Vehicle Load Limit.....	6-65
The loading information label.....	6-65

 **WARNING**

Carbon monoxide (CO) gas is toxic. Breathing CO may cause unconsciousness and death.

Engine exhaust contains carbon monoxide that cannot be seen or smelled.

Do not inhale engine exhaust.

If at any time you smell engine exhaust inside the vehicle, open the windows immediately. Exposure to CO may cause unconsciousness and death by asphyxiation.

Make sure the exhaust system does not leak.

The exhaust system should be checked whenever the vehicle is raised to change the oil or for any other purposes. If you hear a change in the sound of the exhaust or drive over something that strikes the underneath side of the vehicle, have the exhaust system checked as soon as possible by an authorized HYUNDAI dealer.

Do not run the engine in an enclosed area.

Letting the engine idle in your garage, even with the garage door open, is a hazardous practice. Run the engine only long enough to start the engine and to move the vehicle out of the garage.

Avoid idling the engine for an extended period of time with people inside the vehicle.

If it is necessary to idle the engine for a long time with people inside the vehicle, be sure to do so only in an open area with the air intake set at "Fresh" and fan control set to high so fresh air is drawn into the interior.

Keep the air intakes clear.

To ensure proper operation of the ventilation system, keep the ventilation air intakes located in front of the windshield clear of snow, ice, leaves, or other obstructions.

If you must drive with the liftgate open:

Close all windows.

Open instrument panel air vents.

Set the air intake control at "Fresh", the air flow control at "Floor" or "Face", and the fan control set to high.

Before Driving

Before entering the vehicle

- Make sure all windows, outside mirror(s), and outside lights are clean and unobstructed.
- Remove frost, snow, or ice from both the front and rear windshield as well as the front side windows.
- Visually check the tires for uneven wear and damage.
- Check under the vehicle for any sign of leaks.
- Make sure there are no obstacles behind you if you intend to back up.

Before starting

- Make sure the hood, the liftgate, and the doors are securely closed and locked.
- Adjust the position of the seat and steering wheel.
- Adjust the inside and side view mirrors.
- Verify all the lights work.
- Fasten your seat belt. Check that all passengers have fastened their seat belts.
- Check the gauges and indicators in the instrument panel and the messages on the instrument display when the Engine Start/Stop button is in the ON position.
- Check that any items you are carrying are stored properly or fastened down securely.

WARNING

To reduce the risk of serious injury or death:

- Always wear your seat belt. All passengers must be properly belted whenever the vehicle is moving. For more information, refer to the "Seat Belts" section in chapter 3.
 - Always drive defensively. Do not assume that the other drivers are seeing your vehicle. They may not act as you expect. Be prepared to react to avoid a possible collision. Plan your movements anticipating the "worst-case" scenario.
 - Stay focused on driving. Driver distraction may cause a collision.
 - Leave plenty of space between you and the vehicle in front of you.
-

⚠ WARNING

Never drink or take drugs while driving. Drinking or taking drugs while driving is dangerous and may result in a collision, causing serious injury or death.

Drunk driving is the number one contributor to the highway death toll each year. Even a small amount of alcohol can affect your reflexes, perceptions, and judgment. Just one drink may reduce your ability to respond to changing conditions and emergencies and your reaction time gets worse with each additional drink.

Driving while under the influence of drugs is as dangerous or more dangerous than driving under the influence of alcohol.

You are much more likely to have a serious crash if you drink or take drugs while driving. If you are drinking or taking drugs, never drive. Do not ride with a driver who has been drinking or taking drugs. Choose a designated driver or call a taxi.

Engine Start/Stop Button



Whenever the front door is opened, the Engine Start/Stop button illuminates and goes off for a few seconds after the door is closed.

⚠ WARNING

To turn off the engine in an emergency: Press and hold the Engine Start/Stop button for more than 2 seconds. Or rapidly press and release the Engine Start/Stop button 3 times (within 3 seconds).

If the vehicle is still moving, you can restart the vehicle without depressing the brake pedal by pressing the Engine Start/Stop button with the gear in the N (Neutral) position.



WARNING

- Never press the Engine Start/Stop button while the vehicle is in motion except in an emergency. This may result in the vehicle turning off and loss of power assist for the steering and brake systems. This may cause loss of directional control and braking function, which could cause a collision.
 - Before leaving the driver's seat, always make sure the gear is in the P (Park) position, apply the parking brake, press the Engine Start/Stop button to the OFF position, and take the smart key with you. Unexpected vehicle movement may occur if these precautions are not followed.
 - Never reach through the steering wheel for the Engine Start/Stop button or any other control while the vehicle is moving. The presence of your hand or arm in this area may cause a loss of vehicle control resulting in a collision.
-

Engine Start/Stop button positions

Button Position	Action	Notes
OFF	To turn off the engine, press the Engine Start/Stop button with gear in P (Park). For rotary type shift gear vehicles, if the Engine Start/Stop button is pressed with the vehicle shifted to D (Drive), R (Reverse), or N (Neutral), the gear automatically shifts to P (Park).	Always stop the vehicle before pressing the Engine Start/Stop button to the OFF position.
ACC	Press the Engine Start/Stop button when the button is in the OFF position without depressing the brake pedal. Some electrical accessories are usable.	If you leave the Engine Start/Stop button in the ACC position for more than one hour, the battery power turns off automatically to prevent the battery from discharging.
ON	Press the Engine Start/Stop button while it is in the ACC position without depressing the brake pedal. The warning lights can be checked before the engine is started.	Do not leave the Engine Start/Stop button in the ON position when the engine is not running to prevent the battery from discharging.
START	To start the engine, depress the brake pedal and press the Engine Start/Stop button with the gear in the P (Park). For your safety, start the engine with the gear in the P (Park) position.	If you press the Engine Start/Stop button without depressing the brake pedal, the engine does not start and the Engine Start/Stop button changes as follows: OFF > ACC > ON > OFF or ACC

Starting the engine

WARNING

- Always wear appropriate shoes when operating your vehicle. Unsuitable shoes such as high heels, ski boots, sandals, and flip-flops may interfere with your ability to use the brake, accelerator, and clutch pedals. Do not drive barefoot.
 - Do not start your vehicle with the accelerator pedal depressed. Place your foot firmly on the brake pedal while starting your vehicle.
 - Wait until the engine is at normal idle before shifting gears and releasing the brake. Your vehicle may move suddenly if your vehicle is shifted while the engine RPM is high. It may cause damage to the transmission system.
-

Information

- The vehicle starts by pressing the Engine Start/Stop button, only when the smart key is in the vehicle.
 - The vehicle may not start even if the smart key is in the vehicle but it is not near you (e.g. in the cargo area).
 - When the Engine Start/Stop button is in the ACC or ON position, if any door is open, the system checks for the smart key. When the smart key is not in the vehicle, the  indicator blinks and the warning "**Key not in vehicle**" appears. When all doors are closed, the chime sounds for a few seconds. Keep the smart key in the vehicle.
-

1. Always carry the smart key with you.
2. Make sure the parking brake is applied.
3. Make sure the gear is in P (Park).
4. Depress the brake pedal.
5. Press the Engine Start/Stop button.

NOTICE

- Do not wait for the engine to warm up or race the engine while the vehicle remains stationary.
 - Start driving at moderate engine speeds. Do not rapidly accelerate and decelerate while driving.
-

Information

To prevent damage to the vehicle:

- Do not press the Engine Start/Stop button for more than 10 seconds except when the brake switch fuse is blown.

When the brake switch fuse is blown, a warning message appears on the cluster display. In this case, start the engine by pressing and holding the Engine Start/Stop button for 10 seconds with the Engine Start/Stop button in the ACC position.

Replace the fuse as soon as possible. For more information, refer to the "Fuses" section in chapter 9.

- If the engine stalls while the vehicle is moving, shift to N (Neutral) and use the Engine Start/Stop button to attempt to restart the engine.
 - Do not push or tow your vehicle to start the engine.
-

i Information

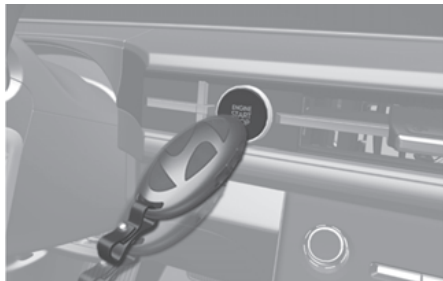

If the smart key battery is weak or the smart key does not work correctly, press the Engine Start/Stop button with the smart key.

Turning off the engine

1. Stop the vehicle and depress the brake pedal fully.
2. Make sure the gear is in P (Park).
3. Apply the parking brake.
4. Press the Engine Start/Stop button to the OFF position.
5. Take the key with you when you leave the vehicle.

Remotely starting the engine



You can start the vehicle using the Remote Start (Ω) button on the smart key.

To start the vehicle remotely:

1. Press the door lock (\square) button within 32 ft. (10 m) from the vehicle.
2. Press and hold the remote start (Ω) button for over 2 seconds within 4 seconds.

To turn off the engine:

Press the remote start (Ω) button once.

i Information

- The vehicle does not remotely start if the hood or liftgate is open.
- The vehicle must be in P (Park).
- The engine turns off if you get in the vehicle without a registered smart key or you do not get in the vehicle within 10 minutes.

Vehicle Auto-shut Off

 If equipped

If your vehicle is parked and the engine is left on for a long period of time, the engine will turn off automatically to help reduce fuel consumption and prevent accidents caused by carbon dioxide poisoning.

Operating conditions

Vehicle Auto-Shut Off timer operates when all the following conditions are satisfied:

- Vehicle speed is below 1.8 mph (3 km/h), and the gear is shifted to P (Park)
- The brake pedal and accelerator pedal are not depressed
- The driver's seat belt is unfastened
- The passenger seat is empty
- The infotainment system is being updated

Deactivating conditions

Vehicle Auto-Shut Off timer turns off when one of the situation occurs:

- Vehicle speed is above 1.8 mph (3 km/h)
- The gear is shifted to R (Reverse), D (Drive) or N (Neutral)
- The brake pedal or accelerator pedal is depressed
- The driver's seat belt is fastened
- A passenger is in the passenger's seat

System operation

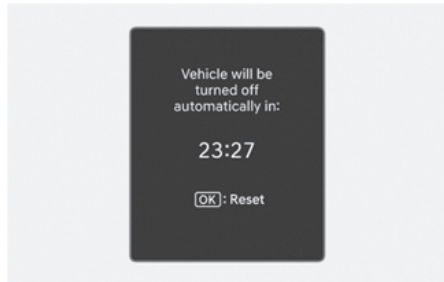

When all the conditions are satisfied, the Vehicle Auto-Shut Off operates and turns the engine off automatically after 60 minutes.

A timer appears on the cluster display 30 minutes before vehicle shuts off.

Resetting cluster timer

To reset the cluster timer, do one of following:

- Release the accelerator pedal or brake pedal after Vehicle Auto-Shut Off is complete.
- Press the **OK** button on the steering wheel while the timer appears on the cluster display.

WARNING

Do not leave a passenger or a pet in the vehicle in hot weather since the air conditioning system turns off when the engine is off.

Automatic Transmission

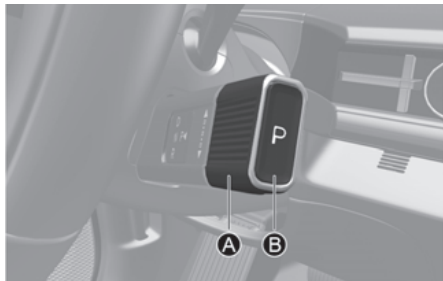

[A] Rotary gear shift dial
[B] P button

Depress the brake pedal whenever rotating the gear shift dial or shifting to P (Park).

Automatic transmission operation

The automatic transmission has six forward speeds and one reverse speed. The individual speeds are selected automatically in the D (Drive) position.

⚠ WARNING

The automatic transmission rotary gear shift dial or interior parts might get hot when a vehicle is parked outside during hot weather. Always be careful when the vehicle is hot.

The indicator on the instrument cluster displays the shift position when the Engine Start/Stop button is in the ON position.

⚠ WARNING

To reduce the risk of serious injury or death:

- ALWAYS check the surrounding areas near your vehicle for people, especially children, before shifting a vehicle into D (Drive) or R (Reverse).
- Before leaving the driver's seat, always make sure the vehicle is shifted to the P (Park) position, then apply the parking brake, then press the Engine Start/Stop button to the OFF position. Unexpected and sudden vehicle movement can occur if these precautions are not followed.
- When using the paddle shifter (manual shift mode), do not use engine braking (shifting from a high gear to lower gear) rapidly on slippery roads. The vehicle may slip causing a collision.

Transmission ranges

P (Park)

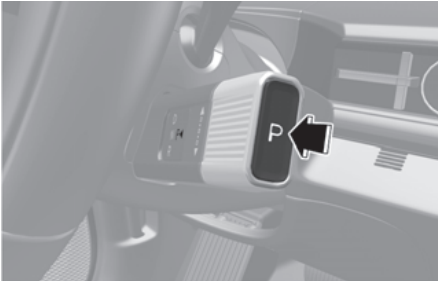

Always come to a complete stop before shifting into P (Park).

To shift the gear to P (Park), press the P (Park) button while depressing the brake pedal.

If you turn the engine off in R (Reverse), N (Neutral) or D (Drive), the gear automatically shifts to P (Park).

WARNING

- Shifting into P (Park) while the vehicle is in motion may cause you to lose control of the vehicle.
- After the vehicle has stopped, always make sure the vehicle is in P (Park), apply the parking brake, and turn the engine off.
- When parking on an incline, shift the gear to P (Park) and apply the parking brake to prevent the vehicle from rolling downhill.

Automatic gear shift to P (Park)

The gear is shifted to P (Park) automatically for safety reasons under the following conditions:

- When the engine is turned off with the gear in R (Reverse), D (Drive) or N (Neutral).
- When the driver's door is open with the engine running, the gear in R (Reverse), D (Drive) or N (Neutral) and the vehicle at a standstill.
- When the driver's door is open with the gear in N (Neutral) and the vehicle is off.

In situations the gear must be in P (Park), always check if the gear is shifted to P (Park) by checking the cluster display.

R (Reverse)

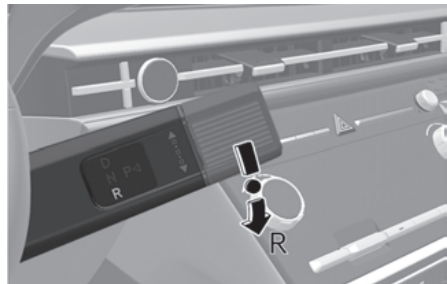

Use this position to drive the vehicle rearward.

To shift the gear to R (Reverse), rotate the rotary gear shift dial to R (Reverse) while depressing the brake pedal.

When the vehicle is stopped in the R (Reverse) position, if you open the driver's door, the gear automatically shifts to P (Park).

However, if the vehicle is in motion, the gear may not automatically shift to P (Park) to prevent automatic transmission damage.

NOTICE

Always come to a complete stop before shifting into or out of R (Reverse). You may damage the transmission if you shift into R (Reverse) while the vehicle is in motion.

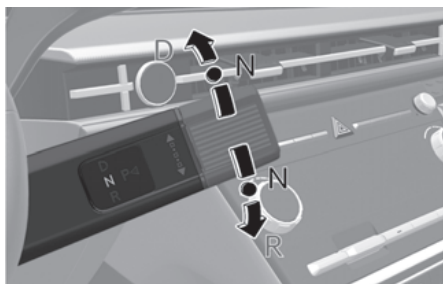
N (Neutral)

The wheels and transmission are not engaged.

To shift the gear to N (Neutral), rotate the rotary gear shift dial to N (Neutral) from R (Reverse) or D (Drive) while depressing the brake pedal.

Always depress the brake pedal when you are shifting from N (Neutral) to another gear.

If you turn the engine off in N (Neutral), the gear automatically shifts to P (Park).

However, if you need to stay in N (Neutral) with the engine off, refer to the following "To stay in N (Neutral) when vehicle is OFF" section.

CAUTION

Be sure to start the engine with the gear in P (Park).

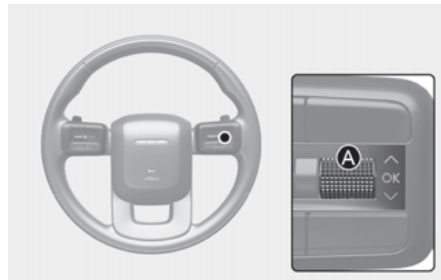
To stay in N (Neutral) when vehicle is OFF

If you want to stay in N (Neutral) after the engine is OFF (in the ACC state), do the following.

1. Turn off Auto Hold and apply the parking brake when the engine is running.
2. Rotate the shift dial to N (Neutral) while depressing the brake pedal.
3. When you take your foot off the brake pedal, the message "**Press and hold the OK button on the steering wheel to stay in Neutral**" appears on the cluster display.
4. Press and hold the OK button [A] on the steering wheel for more than 1 second.
5. When the message "**Neutral will stay engaged when the vehicle is Off**" appears on the cluster display, turn the vehicle off while depressing the brake pedal.

If you wish to cancel, change gear to P (Park), D (Drive) or R (Reverse). Otherwise, N (Neutral) will stay engaged when the vehicle is Off.

Also, if you open the driver's door, the gear automatically shifts to P (Park) and the Engine Start/Stop button changes to the OFF position.

NOTICE

With the gear in N (Neutral), the Engine Start/Stop button is in the ACC position. In the ACC position, the doors cannot be locked. The battery may discharge if left in the ACC position for a long time.

D (Drive)

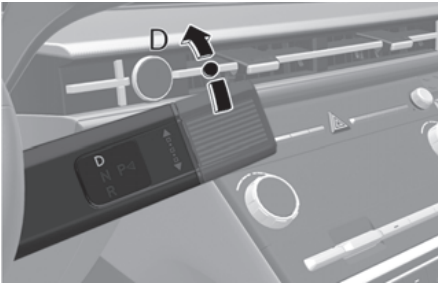

This is the normal driving position. The transmission automatically shifts through a 6 gear sequence, providing the best fuel economy and power.

To shift the gear to D (Drive), rotate the rotary gear shift dial to D (Drive) while depressing the brake pedal.

For extra power when passing another vehicle or driving uphill, depress the accelerator pedal further until you feel the transmission downshift to a lower gear.

When the vehicle is stopped in the D (Drive) position, if you open the driver's door, the gear automatically shifts to P (Park).

If the vehicle is moving in D (Drive), the gear may not automatically shift to P (Park) to protect the transmission damage.

NOTICE

Always come to a complete stop before shifting into D (Drive).

CAUTION

When you start after stopping on a steep incline, even if the gear is in D (Drive), if you do not depress the accelerator or brake pedal, the vehicle may roll backwards, which can cause a collision.

Shift-lock system

For your safety, the automatic transmission has a shift-lock system which prevents shifting the transmission from P (Park) into R (Reverse) or D (Drive) unless the brake pedal is depressed.

To shift from P (Park) or N (Neutral) into R (Reverse) or D (Drive):

1. Depress and hold the brake pedal.
2. Start the engine.
3. Shift the gear while depressing the brake pedal.

When the battery is discharged

You cannot shift gears, when the battery is discharged.

In emergencies, do the following to shift the gear to N (Neutral) on a level ground.

1. Connect the battery cables from another vehicle or from a another battery to the jump-starting terminals inside the engine compartment.

For more information, refer to the "Jump Starting" section in chapter 8.

2. Apply the parking brake with the Engine Start/Stop button in the ON position.
3. Shift the gear to the N (Neutral) position. Refer to the "Automatic transmission operation" in this chapter.

i Information

In situations when the gear needs to be shifted from P (Park) to N (Neutral) when the vehicle off, refer to the "To stay in N (Neutral) when vehicle is OFF" in this chapter.

Parking

Always come to a complete stop and continue to depress the brake pedal.

Shift the gear to P (Park), apply the parking brake, and press the Engine Start/Stop button to turn the vehicle off.

Take the smart key with you when leaving the vehicle.

⚠ WARNING

- When you stay in the vehicle with the engine running, be careful not to depress the accelerator pedal for a long period of time. The engine or exhaust system may overheat and start a fire.
- The exhaust gas and the exhaust system are very hot. Keep away from the exhaust system components.
- Do not stop or park over flammable materials, such as dry grass, paper or leaves. They may ignite and cause a fire.

Cluster display message

Press brake pedal to change gear

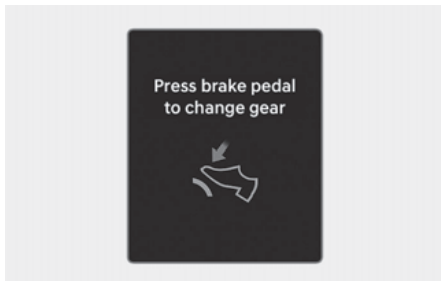

This message appears when the brake pedal is not depressed while shifting the gear.

Depress the brake pedal and then shift the gear.

Shift to P after stopping

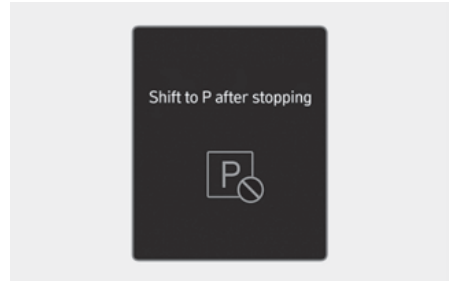

This message appears when the gear is shifted to P (Park) while the vehicle is moving.

Stop the vehicle before shifting to P (Park).

Shifter system malfunction



This message appears when the transmission or the shift dial does not properly operate in the P (Park) position.

Have your vehicle inspected by an authorized HYUNDAI dealer.

Check shifter dial

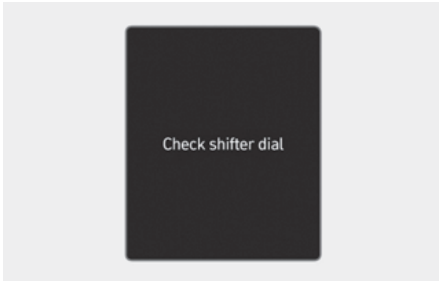

This message appears when there is a malfunction with the rotary gear shift dial. Have your vehicle inspected by an authorized HYUNDAI dealer.

Rotary shifter stuck

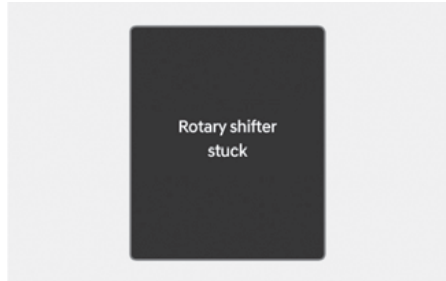

This message appears when the rotary gear shift dial does not return back to its normal position after rotating it. Have your vehicle inspected by an authorized HYUNDAI dealer.

Check P button

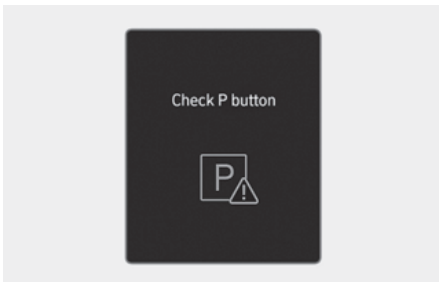

This message appears when there is a problem with the P button. Have your vehicle inspected by an authorized HYUNDAI dealer.

Paddle shifter (manual shift mode)

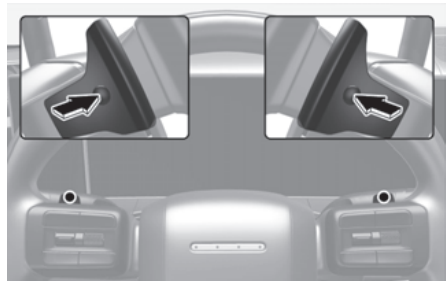

The paddle shifter is available when the gear is in the SPORT mode. Pull the [+] or [-] paddle shifter once to shift up or down one gear and the system changes from automatic shift mode to manual shift mode. To change back to automatic shift mode from manual shift mode, do one of the followings:

- Pull and hold the [+] paddle shifter.
- Shift the gear to D (Drive).

The manual shift mode also changes back to automatic shift mode in one of following situations:

- When the accelerator pedal is not depressed for more than 6 seconds while driving.
- When the vehicle speed decreases below 1 mph (2km/h).

i Information

If the [+] and [-] paddle shifters are pulled at the same time, gear shift may not occur.

Good driving practices

- Never shift the gear from P (Park) or N (Neutral) to any other position with the accelerator pedal depressed.
- Never shift the gear into P (Park) when the vehicle is in motion.

Be sure the vehicle is completely stopped before you attempt to shift into R (Reverse) or D (Drive).

- Do not shift the gear to N (Neutral) when driving. If the gear is shifted to N (Neutral) while driving, the vehicle loses the ability to provide engine braking. Doing so may increase the risk of a collision.

Also, shifting the gear back to D (Drive) while the vehicle is moving may severely damage the transmission.

- When driving uphill or downhill, always shift to D (Drive) for driving forward or shift to R (Reverse) for driving rearwards. After selecting D (Drive) or R (Reverse), check the gear position indicated on the cluster before driving. If the vehicle moves in the opposite direction of the selected gear, the engine may turn off and a serious collision might occur due to degraded brake performance.

- Do not drive with your foot resting on the brake pedal. Even light, but consistent pedal pressure can result in the brakes overheating, brake wear and possibly even brake failure.
- When driving in Manual shift mode, slow down before shifting to a lower gear. Otherwise, the lower gear may not be engaged if the engine RPMs are outside of the allowable range.
- When driving with paddle shifters, slow down before shifting to a lower gear. Otherwise, the lower gear may not be engaged if the engine RPMs are outside of the allowable range.
- Always apply the parking brake when leaving the vehicle. Do not depend on placing the transmission in P (Park) to keep the vehicle from moving.
- Exercise extreme caution when driving on a slippery surface. Be especially careful when braking, accelerating or shifting gears. On a slippery surface, an abrupt change in vehicle speed can cause the drive wheels to lose traction and may cause loss of vehicle control resulting in a collision.
- Optimum vehicle performance and economy is obtained by smoothly depressing and releasing the accelerator.



WARNING

To reduce the risk of serious injury or death:

- ALWAYS wear your seatbelt. In a collision, an unbelted occupant is significantly more likely to be seriously injured or killed than a properly belted occupant.
 - Avoid high speeds when cornering or turning.
 - Do not make quick steering wheel movements, such as sharp lane changes or fast, sharp turns.
 - The risk of rollover is greatly increased if you lose control of your vehicle at highway speeds.
 - Loss of control often occurs if two or more wheels drop off the roadway and the driver over steers to reenter the roadway.
 - In the event your vehicle leaves the roadway, do not steer sharply. Instead, slow down before pulling back into the travel lanes.
 - HYUNDAI recommends you follow all posted speed limits.
-

Braking system

Power-assist brakes

Your vehicle has power-assisted brakes that adjust automatically through normal usage.

If the engine is not running or is turned off while driving, the power assist for the brakes does not work. You can still stop your vehicle by applying greater force to the brake pedal than typical. The stopping distance, however, may be longer than with power brakes.

When the engine is not running, the reserve brake power is partially depleted each time the brake pedal is depressed. Do not pump the brake pedal when the power assist has been interrupted.

i Information

- When the brake pedal is depressed under certain driving conditions or weather conditions, you may temporarily hear a noise. This is normal and does not indicate a problem with your brakes.
 - While driving on a road with deicing chemicals, brake noise or abnormal tire wear may occur due to deicing chemicals. In a safe traffic condition, additionally apply the brakes to remove deicing chemicals on the brake discs and pads.
-

WARNING

Take the following precautions:

- Do not drive with your foot resting on the brake pedal. This will create abnormal high brake temperatures, excessive brake lining and pad wear, and increased stopping distances.
- When descending down a long or steep hill, use the paddle shifter and manually downshift to a lower gear in order to control your speed without using the brake pedal excessively. Applying the brakes continuously will cause the brakes to overheat and may result in a temporary loss of braking performance.
- Wet brakes may impair the vehicle's ability to safely slow down and the vehicle may also pull to one side when the brakes are applied. Applying the brakes lightly indicates whether they have been affected in this way. Always test your brakes in this fashion after driving through deep water. To dry the brakes, lightly tap the brake pedal to heat up the brakes while maintaining a safe forward speed until brake performance returns to normal. Avoid driving at high speeds until the brakes function correctly.

Disc brakes wear indicator

When your brake pads are worn and new pads are required, you may hear a high pitched warning sound from your front or rear brakes. You may hear this sound come and go or it may occur whenever you depress the brake pedal.

i Information

Always replace both the left and right brake pads on the front and rear axles at the same time.

Electronic Parking Brake (EPB)

Applying the parking brake

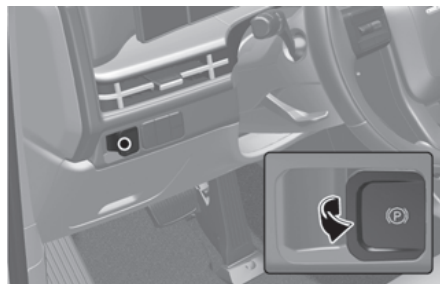

To apply EPB (Electronic Parking Brake):

1. Depress and hold the brake pedal.
2. Pull the EPB switch.

Make sure the Parking Brake warning light comes on.

EPB (Electronic Parking Brake) may be automatically applied when:

- Requested by other systems.
- The driver turns the vehicle off while Auto Hold is operating.

Emergency braking

If there is a problem with the brake pedal while driving, emergency braking is possible by pulling up and holding the EPB switch. Braking is possible only while you are holding the EPB switch. However, braking distance may be longer than normal.

WARNING

To reduce the risk of serious injury or death, do not operate the EPB while the vehicle is moving except in an emergency situation. It may damage the brake system and cause a collision.

i Information

During emergency braking, the Parking Brake warning light illuminates and you may hear a clicking noise.

NOTICE

If you notice a noise or burning smell when the EPB is used for emergency braking, have the system inspected by an authorized HYUNDAI dealer.

Releasing the parking brake

To release EPB (Electronic Parking Brake):

1. Move the Engine Start/Stop button to ON or START.
2. Press the EPB switch (2) while depressing the brake pedal (1).

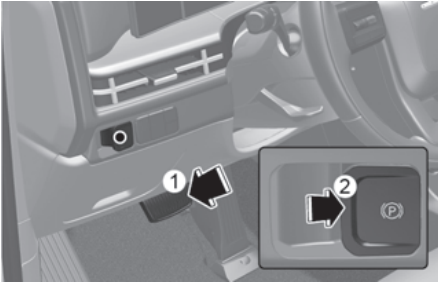

Make sure the Parking Brake warning light goes off.

To release EPB (Electronic Parking Brake) automatically:

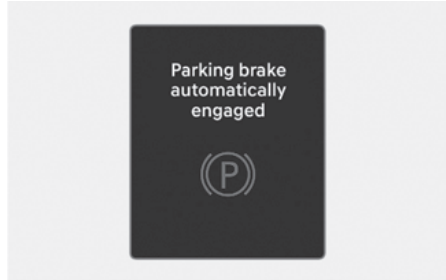

- Gear in P (Park) or in N (Neutral)
With the engine running, depress the brake pedal and shift out of P (Park) or N (Neutral) to R (Reverse) or D (Drive). Make sure the doors, hood, and liftgate are closed and the seat belt is fastened.
- Automatic transmission
 1. Start the engine.
 2. Fasten the driver's seat belt.
 3. Close the driver's door, hood, and liftgate.
 4. Press the accelerator pedal while the gear is in R (Rear), D (Drive) or manual mode.

Make sure the brake warning light goes off.

i Information

- You can engage EPB even though the Engine Start/Stop button is in the OFF position (only if battery power is available), but you cannot release it.
- Depress the brake pedal and release the parking brake manually with the EPB switch before you drive downhill or when backing up.

NOTICE

- If the Parking Brake warning light is still on even though the EPB has been released, have the system inspected by an authorized HYUNDAI dealer.
- Do not drive your vehicle with EPB applied. It may cause excessive brake pad and brake rotor wear.

Warning messages

To release EPB, fasten seatbelt and close door, hood and liftgate

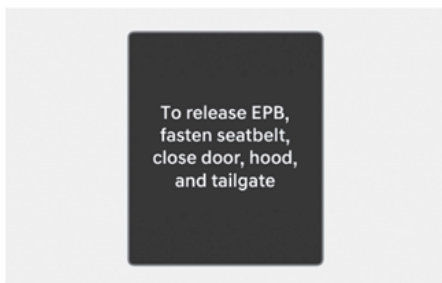

If the driver's seat belt is unfastened, or the hood, liftgate, doors are open, and you try to drive with EPB applied, a warning sounds and a message appears.

WARNING

To prevent serious injury or death from unintended vehicle movement:

- Always come to a complete stop and continue to depress the brake pedal before parking, shift the gear into P (Park), pull up the EPB switch, and move the Engine Start/Stop button to the OFF position. Take the key with you when leaving the vehicle.
- Never allow anyone who is unfamiliar with the vehicle to touch the EPB switch.
- Only release EPB when you are seated inside the vehicle with your foot firmly on the brake pedal.

NOTICE

Driving with the parking brake on may overheat the braking system and cause premature wear or damage to brake parts.

i Information

When leaving your keys with a parking attendant or assistant, be sure to inform him/her how to operate the EPB.

EPB malfunction

Electronic Parking Brake (EPB) warning light illuminates if the Engine Start/Stop button is in the ON position and goes off in about 3 seconds if the system is operating normally.

If the EPB warning light remains on, comes on while driving, or does not come on when the Engine Start/Stop button is ON, the EPB may have malfunctioned.

If this occurs, have the system inspected by an authorized HYUNDAI dealer.

The EPB warning light may illuminate when the ESC indicator light comes on to indicate that ESC is not working properly, but it does not indicate a malfunction of EPB.

NOTICE

- If the Parking Brake warning light does not illuminate or blinks after the EPB switch has been pulled, the EPB may not be applied.
- If the EPB warning light is still on or the Parking Brake warning light blinks, press the switch, and then pull it up. Repeat this one more time. If the EPB warning does not go off, have your vehicle towed on a flatbed tow truck to an authorized HYUNDAI dealer.

Parking brake warning light



This light illuminates when the Parking Brake is applied with the Engine Start/Stop button in the ON position or when the engine is running.

Before driving, make sure the parking brake is released and the parking brake warning light is OFF.

If the Parking Brake warning light remains on after the Parking Brake is released while the engine is running, there may be a malfunction in the brake system.

If possible, stop driving the vehicle immediately. If that is not possible, use extreme caution while operating the vehicle and only continue to drive the vehicle until you can reach a safe location.

Auto hold

Auto Hold maintains the vehicle in a standstill even though the brake pedal is not depressed after the driver brings the vehicle to a complete stop by depressing the brake pedal.

i Information

When the vehicle is restarted, the last setting for Auto Hold is applied.

To apply:

1. With the driver's door and hood closed, press the **AUTO HOLD** switch. The white **AUTO HOLD** indicator comes on and the system is in standby.

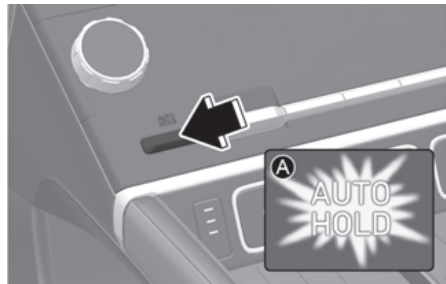

[A] White

2. When you stop the vehicle completely by depressing the brake pedal, Auto Hold maintains the brake pressure to hold the vehicle stationary. The indicator changes from white to green. The vehicle remains stationary even if you release the brake pedal.

To release:

If you depress the accelerator pedal with the gear in D (Drive) or manual shift mode or R (Reverse) (vehicle equipped with shift button), the Auto Hold is released automatically and the vehicle starts to move. The **AUTO HOLD** indicator changes from green to white.

⚠ WARNING

Always look around your vehicle before depressing the accelerator pedal to release Auto Hold.

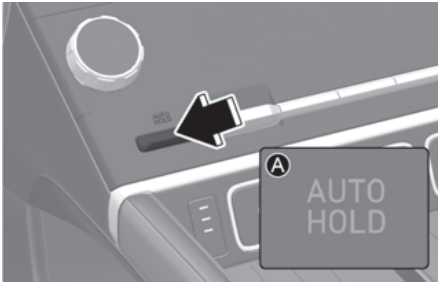
To cancel:

[A] Off

1. Depress and hold the brake pedal.
 2. Press the AUTO HOLD switch.
- The AUTO HOLD indicator turns off.

⚠ WARNING

To prevent unintended vehicle movement, always depress your foot on the brake pedal to cancel the Auto Hold before you:

- Drive downhill.
- Drive the vehicle in R (Reverse).
- Park the vehicle.

i Information

- The Auto Hold does not operate when:
 - EPB is applied.
- The Auto Hold automatically switches to EPB when:
 - The driver's door or hood is opened.
 - The vehicle is in a standstill for more than 10 minutes.
 - The vehicle is on a steep slope.
 - The vehicle moves several times.
 - The liftgate is opened. (for rotary gear shift dial type)

The Parking Brake warning light comes on, the AUTO HOLD indicator changes from green to white, and a warning sounds and a message appears to inform you that EPB has been automatically engaged. Before driving, depress the brake pedal, check the surrounding area, and release the parking brake manually with the EPB switch.

NOTICE

If the AUTO HOLD indicator changes to yellow, or the driver's door, hood, or liftgate open detection system malfunctions, Auto Hold does not work properly. Contact an authorized HYUNDAI dealer.

Warning messages

Parking brake automatically engaged

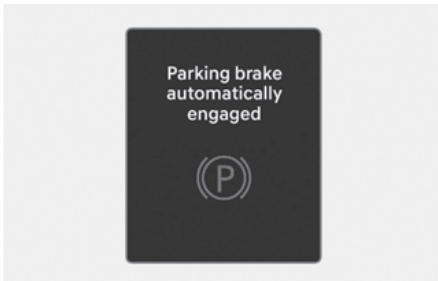

When EPB is applied while Auto Hold is activated, a warning sounds and a message appears.

Press brake pedal to deactivate AUTO HOLD

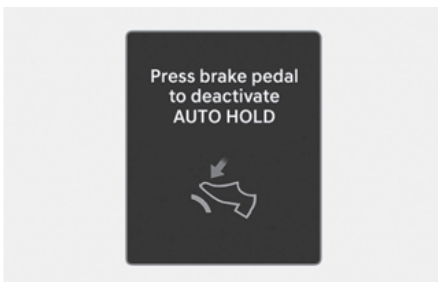

If you did not apply the brake pedal when you release Auto Hold by pressing the AUTO HOLD switch, a warning sounds and a message appears.

AUTO HOLD turning Off! Press brake pedal

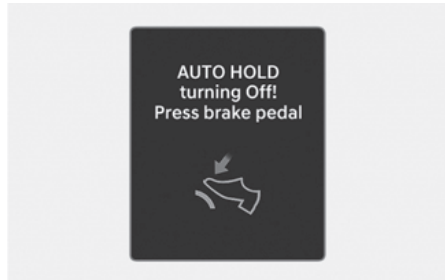

When the conversion from Auto Hold to EPB is not working properly, a warning sounds and a message appears.

Anti-lock Brake System (ABS)

WARNING

Anti-Lock Braking System (ABS) or Electronic Stability Control (ESC) system will not prevent collisions due to improper or dangerous driving maneuvers. Even though vehicle control is improved during emergency braking, always maintain a safe distance between you and objects ahead of you. Always reduce the vehicle speed in extreme road conditions.

The braking distance for vehicles equipped with ABS or ESC may be longer than for those without these systems in the following road conditions:

- Rough, gravel, or snow-covered roads.
- On roads where the road surface is pitted or has different surface height.
- Tire chains are installed on your vehicle.

Never test the safety features of an ABS or ESC equipped vehicle by high speed driving or cornering. It may cause a collision and endanger the safety of yourself or others.

ABS is an electronic braking system that helps prevent a braking skid. ABS allows the driver to steer and brake at the same time.

Using ABS

To obtain the maximum benefit from your ABS in an emergency situation, do not attempt to modulate your brake pressure and do not try to pump your brakes. Depress your brake pedal as hard as possible.

When you apply your brakes under conditions that may lock the wheels, you may hear sounds from the brakes, or feel a corresponding sensation in the brake pedal. This is normal and it means your ABS is active.

ABS does not reduce the time or distance to stop the vehicle.

Always maintain a safe distance from the vehicle in front of you.

ABS does not prevent a skid that results from sudden changes in direction, such as trying to take a corner too fast or making a sudden lane change. Always drive at a safe speed for the road and weather conditions.

ABS cannot prevent a loss of stability. Always steer moderately when braking hard. Severe or sharp steering wheel movement can still cause your vehicle to veer into oncoming traffic or off the road.

On loose or uneven road surfaces, operation of the anti-lock brake system may result in a longer stopping distance than for vehicles equipped with a conventional brake system.

The ABS (ABS) warning light stays on for several seconds after the Engine Start/Stop button is in the ON position.

During that time, ABS goes through self-diagnosis and the light goes off if everything is normal. If the light stays on, contact an authorized HYUNDAI dealer as soon as possible.

WARNING

If the ABS (ABS) warning light is on and stays on, you may have a problem with the ABS. Your power brakes work normally. To reduce the risk of serious injury or death, contact your authorized HYUNDAI dealer as soon as possible.

i **Information**

When you drive on a road having poor traction, such as an icy road, and apply your brakes continuously, ABS is active continuously and the ABS (ABS) warning light may illuminate. Pull your vehicle over to a safe place and turn off the vehicle.

Restart the vehicle. If the ABS warning light is off, your ABS system is normal.

If not, contact an authorized HYUNDAI dealer as soon as possible.

i **Information**

When you jump start your vehicle because of a drained battery, the ABS (ABS) warning light may turn on at the same time. It does not mean your ABS is malfunctioning. Have the battery recharged before driving the vehicle.

Electronic Stability Control (ESC)

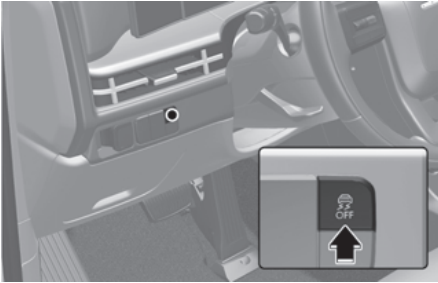

Electronic Stability Control helps stabilize the vehicle during cornering maneuvers.

ESC checks where you are steering and where the vehicle is actually going. ESC applies braking pressure to any one of the vehicle's brakes and intervenes in the engine management system to assist the driver with keeping the vehicle on the intended path. It is not a substitute for safe driving practices. Always adjust your speed and driving to the road conditions.

WARNING

Never drive too fast for the road conditions when cornering. ESC does not prevent a collision.

Excessive speed in turns, abrupt maneuvers, and hydroplaning on wet surfaces may result in severe collisions.

ESC operation

ESC ON condition

When the Engine Start/Stop button is in the ON position, ESC and the ESC OFF indicator lights illuminate for about three seconds. After both lights go off, ESC is enabled.

When operating



When ESC is operating, the ESC indicator light blinks:

- When you apply your brakes under conditions that may lock the wheels, you may hear sounds from the brakes, or feel a corresponding sensation in the brake pedal.
- If Smart Cruise Control has been used when ESC activates, Smart Cruise Control automatically disengages. Refer to the “Smart Cruise Control (SCC)” section in chapter 7.
- When moving out of the mud or driving on a slippery road, the engine RPM (revolutions per minute) may not increase even if you depress the accelerator pedal all the way. This is to maintain the stability and traction of the vehicle and does not indicate a problem.

ESC OFF condition



To cancel ESC operation:

- State 1
Press the ESC OFF button briefly. The ESC OFF indicator light and the message, "Traction Control disabled" illuminate.
The traction control function of ESC (engine management) is disabled, but the brake control function of ESC (braking management) still operates.
- State 2
Press and hold the ESC OFF button continuously for more than 3 seconds. The ESC OFF indicator light and the message, "Traction & Stability Control disabled" illuminate and a warning chime sounds. Both the traction control function of ESC (engine management) and the brake control function of ESC (braking management) are disabled.
If the Engine Start/Stop button is moved to the OFF position when ESC is off, ESC remains off. Upon restarting the vehicle, ESC automatically turns on again.

Indicator lights



When the Engine Start/Stop button is in the ON position, the ESC indicator light illuminates, then goes off if the ESC system is operating normally.

The ESC indicator light blinks whenever ESC is operating.

If the ESC indicator light stays on, have your vehicle inspected by an authorized HYUNDAI dealer as soon as possible.

The ESC OFF (OFF) indicator light comes on when ESC is turned off.

WARNING

When ESC is blinking, this indicates ESC is active:

- Drive slowly and Never attempt to accelerate.
- Never turn off ESC while the ESC indicator light is blinking. You may lose control of the vehicle and crash.

NOTICE

Driving with wheels and tires with different sizes may cause the ESC system to malfunction. Before replacing tires, make sure all four tires and wheels are the appropriate size for your vehicle. Never drive the vehicle with different sized wheels and tires installed.

ESC OFF usage

When Driving

The ESC OFF mode should only be used briefly to help free the vehicle if stuck in snow or mud, by temporarily stopping operation of ESC, to maintain wheel torque.

To turn off ESC while driving, press the ESC OFF button while driving on a flat road surface.

NOTICE

To prevent damage to the transmission:

- Do not allow wheel(s) of one axle to spin excessively while the ESC, ABS, and Parking Brake warning lights appear. The repairs would not be covered by the vehicle warranty. Reduce engine power and do not spin the wheel(s) excessively while these lights appear.
 - When operating the vehicle on a dynamometer, make sure ESC is turned off (ESC OFF light illuminated).
-

i Information

Turning ESC off does not affect ABS or standard brake system operation.

Vehicle Stability Management (VSM)

Vehicle Stability Management is a function of the Electronic Stability Control (ESC) system. It helps the vehicle stay stable when accelerating or braking suddenly on wet, slippery, and rough roads where traction over the four tires can suddenly become uneven.

WARNING

VSM is not a substitute for safe driving practices. To prevent serious injury or death:

- Always monitor the speed and the distance to the vehicle ahead of you.
 - Never drive too fast for the road conditions. Excessive speed in bad weather or on slippery and uneven roads may result in severe collisions.
-



VSM operation

When operating

When you apply your brakes under conditions that can activate ESC, you may hear sounds from the brakes, or feel a corresponding sensation in the brake pedal. This is normal and it means your VSM is active.

i Information

VSM does not operate when:

- Driving on a banked road such as gradient or incline.
 - Driving in reverse.
 - The ESC OFF () indicator light is on.
 - The MDPS (Motor Driven Power Steering) warning light () is on or blinks.
-

VSM OFF condition

To cancel VSM operation, press the ESC OFF button. ESC OFF (🚫) indicator light illuminates.

To turn on VSM again, press the ESC OFF button again. The ESC OFF (🚫) indicator light goes out.

WARNING

If the ESC OFF (🚫) indicator light or MDPS (🚫) warning light stays illuminated or blinks, your vehicle may have a malfunction with the VSM system. Have the vehicle inspected by an authorized HYUNDAI dealer as soon as possible.

Hill-start Assist Control (HAC)

Hill-Start Assist Control helps prevent the vehicle from rolling backwards when starting from a stop on a hill.

WARNING

Always be ready to depress the accelerator pedal when starting from a stop on an uphill slope. Hill-Start Assist Control activates only for about 2 seconds.

Information

- Hill-Start Assist Control does not operate when the gear is shifted to P (Park) or N (Neutral).
- Hill-Start Assist Control activates even when the ESC (Electronic Stability Control) is off. It does not activate, if the ESC is not operating normally.

Crosswind Stability Control (CSC)

Crosswind Stability Control (CSC) works with Electronic Stability Control (ESC) and Motor Driven Power Steering (MDPS) to stabilize the vehicle when it is being shaken or pushed outward due to strong crosswind.

CSC operation

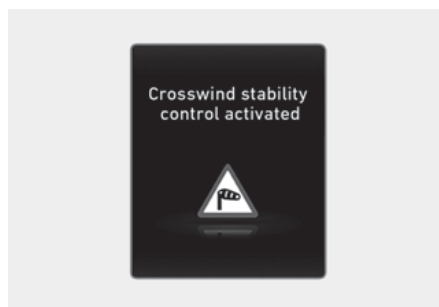

- When driving over a bridge or next to a large truck or bus, strong crosswinds may cause the vehicle to shake or pushed outward. The CSC automatically adjusts the vehicle posture and steering wheel to correct the course of the vehicle.
- When activated, the ESC (🚫) indicator light illuminates and warning message appears on the Cluster display with a warning sound.
- When activated, the driver may feel a slight vibration of the vehicle and awkwardness of the steering wheel, due to the braking and MDPS.

CSC off

Crosswind Stability Control may not operate, or may cancel its operation in the following conditions:

- Vehicle speed is about below 45 mph (70 km/h) or about above 112 mph (180 km/h).
- When the driver makes a sharp turn.
- When the brake pedal is depressed past a certain level.
- Driving on a bumpy road, ice, snow, or slippery surface such due to ice, snow, or rain.
- When ESC OFF (🚫) indicator illuminates by turning off the ESC (ESC OFF state 2).
- ESC is activated.
- Driving assistance system (FCA, BCA, LKA, LFA, etc.) are activated.

CSC malfunction

- When ESC has problems, CSC does not operate.
- When MDPS has problems, CSC may partially operate.
- If the ESC (🚫) or MDPS (🚫!) warning light stays illuminated or blinks, have the vehicle inspected by an authorized HYUNDAI dealer.

⚠️ WARNING

Crosswind Stability Control is only a supplementary system to assist the driver. The driver should be responsible for the control of the vehicle.

Always hold the steering wheel while driving and depress the brake pedal to reduce speed if necessary.

Downhill Brake Control (DBC)

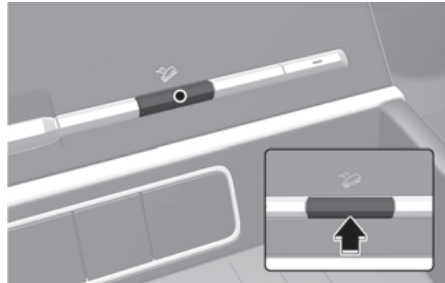





Downhill Brake Control assists when descending down a steep hill without having to depress the brake pedal.

The system automatically applies the brakes to maintain vehicle speed below a certain speed and allows the driver to concentrate on steering the vehicle down hill.

The system is turned off whenever the engine is turned off.

Press the button to turn on the system and press the button again to turn it off.

System operation

Mode	Indicator	Description
Standby	 Green Light on	Press the Downhill Brake Control button when vehicle speed is under 37 mph (60 km/h). Downhill Brake Control turns on and enters the standby mode. The system does not turn on if vehicle speed is over 37 mph (60 km/h).
Activated	 Green Light blink	In the standby mode, Downhill Brake Control activates under the following conditions: <ul style="list-style-type: none"> • The hill is steep enough. The brake pedal or accelerator pedal is not depressed. • Vehicle speed is within 2-25 mph (4-40 km/h) range. Within the activation speed range 2-25 mph (4-40 km/h) when forward or 1.5-5 mph (2.5-8 km/h) when reverse, the driver can control the vehicle speed by depressing the brake pedal or accelerator pedal.
Deactivated	 Green Light off	Downhill Brake Control will turn off or standby under the following conditions: <ul style="list-style-type: none"> • The Downhill Brake Control button is pressed again. • Vehicle speed is over 37 mph (60 km/h).
	 Green Light on	Downhill Brake Control is deactivated but maintains the standby mode under the following conditions: <ul style="list-style-type: none"> • The hill is not steep enough. • Vehicle speed is between 25-37 mph (40-60 km/h).
System malfunction	 Yellow Light on	The yellow warning light illuminates when the system may have malfunctioned or may not work properly during activation. If this occurs, Downhill Brake Control is deactivated. Contact an authorized HYUNDAI dealer as soon as possible.

Downhill Brake Control disabled. Control vehicle speed

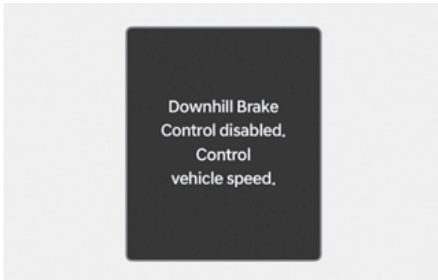

If Downhill Brake Control is not working properly, this warning message appears on the cluster display and you may hear a warning sound. If this occurs, control the vehicle speed by depressing the brake pedal.

⚠ WARNING

Always turn off Downhill Brake Control on normal roads. The system might activate inadvertently from the standby mode when driving through speed bumps or making sharp curves.

i Information

- Downhill Brake Control may not deactivate on steep inclines even though the brake pedal or accelerator pedal is depressed.
 - Downhill Brake Control may not always maintain vehicle speed at a certain speed.
 - Downhill Brake Control does not operate when:
 - The gear is in P (Park).
 - ESC is activated.
 - Noise or vibration may occur from the brakes when Downhill Brake Control is activated.
 - The rear stop light comes on when Downhill Brake Control is activated.
-

Brake Assistant System (BAS)

The Brake Assistant System provides additional pressure when the brake pedal is momentarily and strongly pressed in situations where sudden braking is required while driving.

The Brake Assistant System reduces the time for ABS (Anti-Lock Brake System) control to engage and consequently reduces the braking distance, by providing additional pressure up to the point of ABS intervention.

⚠ WARNING

The system may not operate depending on driver's driving habit, driving speed, the degree to which the brake pedal is depressed and the road surface condition.

Good braking practices

WARNING

Whenever leaving the vehicle or parking, always come to a complete stop and continue to depress the brake pedal. Shift the gear to the P (Park) position, then apply the EPB, and press the Engine Start/Stop button to the OFF position.

Vehicles parked with the EPB not applied or not fully engaged may roll inadvertently and may cause injury to the driver and others. ALWAYS apply the parking brake before exiting the vehicle.

Wet brakes can be dangerous! The brakes may get wet if the vehicle is driven through standing water or if it is washed. Your vehicle will not stop as quickly if the brakes are wet. Wet brakes may cause the vehicle to pull to one side.

To dry the brakes, apply the brakes slightly until the braking action returns to normal. If the braking action does not return to normal, stop as soon as it is safe to do so. Have your vehicle inspected by an authorized HYUNDAI dealer.

DO NOT drive with your foot resting on the brake pedal. Even light, but constant pedal pressure can result in the brakes overheating, brake wear, and possibly even brake failure.

If a tire goes flat while you are driving, apply the brakes gently and keep the vehicle pointed straight ahead while you slow down. When you are moving slowly enough for it to be safe to do so, pull off the road and stop in a safe location.

Keep your foot firmly on the brake pedal when the vehicle is stopped to prevent the vehicle from rolling forward.

Four Wheel Drive (4WD)

 if equipped

The Four Wheel Drive (4WD) system delivers engine power to all front and rear wheels for maximum traction. 4WD is useful when extra traction is required on roads such as slippery, muddy, wet, or snow-covered roads.

4WD may also be used for occasional off-road use such as established unpaved roads and trails. Always reduce the speed to a level that is appropriate for those conditions.

WARNING

To reduce the risk of serious injury or death:

- Do not drive in conditions that exceed the vehicle's intended design such as challenging off-road conditions.
- Avoid high speeds when cornering or turning.
- Do not make quick steering wheel movements, such as sharp lane changes or fast, sharp turns.
- The risk of a rollover is greatly increased if you lose control of your vehicle at highway speeds.
- Loss of control often occurs if two or more wheels drop off the roadway and the driver over steers to reenter the roadway.
- In the event your vehicle leaves the roadway, do not steer sharply. Instead, slow down before pulling back into the travel lanes.

i Information



- Do not drive in water if the water level is higher than the bottom of the vehicle.
 - Check your brake condition once you are out of mud or water. Depress the brake pedal several times as you move slowly until you feel normal braking condition return.
 - Shorten your scheduled maintenance interval if you drive in off-road conditions such as sand, mud, or water (refer to the "Maintenance under severe usage and low mileage conditions" section in chapter 9).
 - Always wash your vehicle thoroughly after off-road use, especially the bottom of the vehicle.
 - Make sure that a full time 4WD vehicle is towed by a flat-bed tow truck.
-

Four wheel drive (4WD) mode

Four Wheel Drive (4WD) mode selection

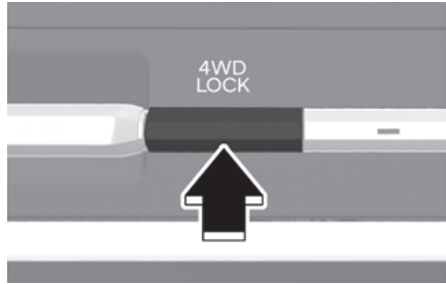
Selection button



Transfer mode	Indicator light	Description
<p>4WD AUTO (4WD LOCK is deactivated)</p>	 (not illuminated)	<ul style="list-style-type: none"> • 4WD Auto is used when driving on roads in normal conditions, roads in urban areas, and on highways. • All wheels are in operation when your vehicle travels at a constant speed. Required traction forces on front and rear wheels may differ depending on road conditions and driving conditions, which are automatically controlled by the system. • The cluster displays how the four wheels' traction forces are distributed.
<p>4WD LOCK</p>	 (illuminated)	<ul style="list-style-type: none"> • 4WD Lock mode maximizes the vehicle's traction under extreme driving conditions such as unpaved off-road, sandy roads, and muddy roads. • 4WD Lock mode operates only when travelling at 37 mph (60 km/h) or less. When traveling over 37 mph (60 km/h), the mode switches to 4WD Auto. • When 4WD Lock mode illuminates, the cluster does not display the front/rear wheel traction force distribution status. • Press the 4WD Lock mode switch again to switch back to 4WD Auto.

WARNING

If the 4WD (⚠️) warning light stays illuminated on the instrument cluster, your vehicle may have a malfunction with the 4WD system. Have the vehicle inspected by an authorized HYUNDAI dealer as soon as possible.

NOTICE

- Maintain the 4WD Auto mode when driving on roads in normal conditions.
- Driving on normal roads with the 4WD Lock mode on, especially when cornering may cause mechanical noise or vibration. Driving in this mode for prolonged periods may damage parts of the power train. The noise and vibration disappear when the 4WD Lock mode is deactivated.

i Information

When the 4WD Lock mode is deactivated, a sensation may be felt as the driving power is delivered entirely to the front wheels.

Auto 4WD mode (Normal driving)

If the 4WD system determines there is a need for four wheel drive, the engine's driving power is distributed to all four wheels automatically.

For safe 4WD operation

Before driving

Make sure all passengers always wear their seat belts.

Driving on snow-covered or icy roads

- Start off slowly by applying the accelerator pedal gently.
- Use snow tires or tire chains.
- Keep a sufficient distance between your vehicle and the vehicle in front.
- Use engine braking during deceleration.
- Avoid speeding, rapid acceleration, sudden brake applications, and sharp turns to prevent skids.

Driving in sand or mud

- Maintain slow and constant speeds.
- Use tire chains when driving in mud if necessary.
- Keep a sufficient distance between your vehicle and the vehicle in front.
- Reduce the vehicle speed and always check the road condition.
- Avoid speeding, rapid acceleration, sudden brake applications, and sharp turns to prevent getting stuck.

i Information

When the vehicle is stuck in snow, sand, or mud, place a non-slip material under the drive wheels to provide traction OR slowly spin the wheels in forward and reverse causing a rocking motion that may free the vehicle. Avoid running the engine continuously at high RPM to prevent damage to the 4WD system.

Transmission overheated

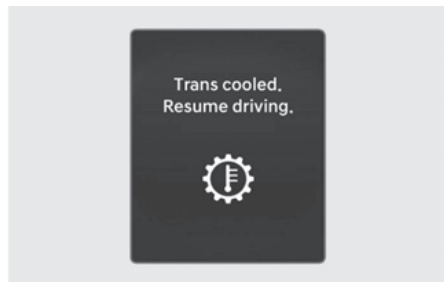

- When driving on muddy and sandy roads under the severe condition, the transmission could be overheated.
- When the transmission is overheated, the safe protection mode engages and the "**Transmission hot! Park with engine On**" warning message appears on the cluster display with a chime.
- If this occurs, pull over to a safe location, stop the vehicle with the engine running, apply the brakes and shift the vehicle to P (Park), and allow the transmission to cool.

- If you ignore this warning, the driving condition may become worse. You may experience abrupt shifts, frequent shifts, or jerkiness. To return to the normal driving condition, stop the vehicle and depress the brake pedal or shift to P (Park). Then allow the transmission to cool for a few minutes with the engine on, before driving off.
- When the message "**Transmission cooled down. Resume driving**" appears you can continue to drive your vehicle.
- If the warning messages in the cluster display continue to blink, for your safety, we recommend that the system be inspected by an authorized HYUNDAI dealer.

Driving up or down hills

- Driving uphill
 - Before starting off, check if it is possible to drive uphill.
 - Drive as straight as possible.
- Driving downhill
 - Do not change gears while driving downhill. Select a gear before driving downhill.
 - Drive slowly when using engine braking while driving downhill.
 - Drive straight as possible.

WARNING

- Exercise extreme caution driving up or down steep hills. The vehicle may roll over in the grade, terrain, and water/mud conditions.
- Do not drive across steep hills. A slight change in the wheel angle may destabilize the vehicle. A stable vehicle may lose stability if the vehicle stops its forward motion. Your vehicle may roll over, resulting in a serious injury or death.

Driving through water

- Try to avoid driving in deep standing water. It may stall your engine and clog your exhaust pipes.
- If you need to drive in water, stop your vehicle, set the vehicle in 4WD Lock mode, and drive under 5 mph (8 km/h).
- Do not change gears while driving in water.

Additional driving conditions

- Become familiar with the off-road conditions before driving.
- Always pay attention when driving off-road and avoid dangerous areas.
- Drive slowly when driving in heavy wind.
- Reduce vehicle speed when cornering. The center of gravity of 4WD vehicles is higher than conventional 2WD vehicles. The vehicle is more likely to roll over if you turn the steering wheel too quickly.
- Always hold the steering wheel firmly when you are driving off-road.

WARNING

Do not grab the inside of the steering wheel when you are driving off-road. You may hurt your arm by a sudden steering maneuver or from steering wheel rebound due to an impact with objects on the ground. You may lose control of the steering wheel that may lead to serious injury or death.

Emergency precautions

Tires

Do not use tires or wheels with different size and type from the one installed on your vehicle. It may affect the safety and performance of your vehicle, which could cause steering failure or rollover causing serious injury.

When replacing the tires, be sure to equip all four tires with the same size, type, tread, brand, and load-carrying capacity. If you equip your vehicle with any tire/wheel combination not recommended by HYUNDAI for off-road driving, do not use these tires for highway driving.

WARNING

Never start or run the engine while a full-time 4WD vehicle is raised on a jack. The vehicle may slip or roll off of a jack causing serious injury or death.

Towing

4WD vehicles must be towed with all the wheels off the ground. For more information, refer to the "Towing" section in chapter 8.

Dynamometer testing

A full-time 4WD vehicle must be tested on a special four wheel chassis dynamometer.

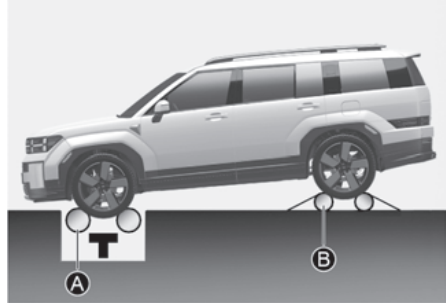

[A] : Roll tester (Speedometer)
[B] : Temporary free roller

If a 2WD roll tester must be used:

1. Check the tire pressures recommended for your vehicle.
2. Place the front wheels on the roll tester for a speedometer test as shown in the illustration.
3. Release the parking brake.
4. Place the rear wheels on the temporary free roller as shown in the illustration.

NOTICE

- Never engage the parking brake while performing the test.
- When the vehicle is lifted up, do not operate the front and rear wheel separately. All four wheels should be operated.

WARNING

Keep away from the front of the vehicle while the vehicle is in gear on the dynamometer. The vehicle may jump forward and cause serious injury or death.

Regenerative Braking System (paddle Shifter)

Regenerative braking system operates the paddle shifter to control the regenerative braking intensity (0-3 level) of the vehicle in ECO mode. It improves the fuel economy of the vehicle and helps the driver to have a better driving experience.

i Information

The regenerative braking system uses the electric motor to apply the brake. The electric motor converts the kinetic energy generated from decelerating the vehicle to electricity and charges the high voltage battery.

Using the regenerative braking system

Operating the paddle shifter

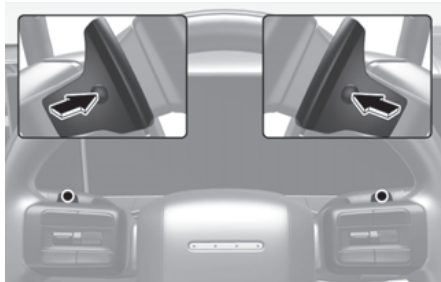

- Pull the left paddle shifter (-) once to raise the regenerative braking intensity level by 1. It increases decelerating intensity.
- Pull the right paddle shifter (+) once to lower the regenerative braking intensity level by 1. It decreases decelerating intensity.

- While the smart regeneration system is ON: Pull and hold the right paddle shifter (+) for over 1 second to turn off the smart regeneration system. (For more information, refer to the "Smart Regeneration System" section in this chapter.)
- While the smart regeneration system is OFF: Pull and hold the right paddle shifter (+) for over 1 second to turn on the smart regeneration system. The regenerative braking level appears as "AUTO".

Checking the amount of regenerative braking



The selected regenerative braking level appears on the instrument cluster.

⚠ CAUTION

- When the vehicle is turned on, the regenerative braking level starts with 0 and only operates with the gear in D (Drive).

- When the gear is shifted to P (Park), R (Reverse) or N (Neutral), the regenerative braking is deactivated, when shifted to D (Drive) the regenerative braking operates as level previously set.
- When ABS and ESC are operating, the regenerative braking is deactivated.
- A difference in deceleration occurs depending on the vehicle speed, even in the same regenerative braking level. The difference is noticeable in city driving, but there is not much difference during high speed driving.

⚠ CAUTION

The vehicle does not come to a complete stop with the regenerative braking level 1-3 by operating the paddle shifter. The vehicle moves slowly with the regenerative braking level decreasing when the vehicle speed is about 6 mph (10 km/h). Depress the brake pedal to stop the vehicle.

Regenerative braking system limitations

Regenerative braking intensity cannot be changed using the paddle shifter in the following situations when:

- The **+** and **-** paddle shifters are pulled at the same time.
- The vehicle is decelerating by depressing the brake pedal.
- Smart Cruise Control is activated.

⚠ CAUTION

Depending on the charging state of the battery and motor (overcharge, high/low temperature), the use of the system may be limited. Check the road conditions ahead and depress the brake pedal for deceleration if necessary.

Initial setting of the regenerative braking level differs according to the selected Drive mode.

Drive mode	Paddle shifter operation	Paddle shifter function
ECO	+	Regenerative braking intensity level decrease
	-	Regenerative braking intensity level increase
SPORT	+	Manual shift +
	-	Manual shift -

For more information, refer to the "Drive Mode Integrated Control System" section in this chapter.

System limitation warning

**Regenerative braking not available.
Battery fully charged**



Regenerative braking is temporarily limited to protect the battery because the high voltage battery is fully charged.

- Hydraulic braking using the brake pedal can be used normally.
- Regenerative braking limitation lasts longer if the battery temperature is too low or too high.

Paddle switch regeneration conditions not met



The system is limited and a warning appears in the following situations. Use the system again after normal driving.

- When the motor or battery temperature is high/low or there is transmission malfunction.
- When regenerative braking is operated while ABS, Cruise Control or Smart Cruise Control is activated.

Smart Regeneration System

The smart regeneration system recognizes vehicle-to-vehicle distance, speed and road gradient, and controls the regenerative braking level while coasting.

It reduces unnecessary depressing of pedals to improve fuel efficiency and driver convenience.

i Information

- Coasting is the process of driving a vehicle without the brake pedal and the accelerator pedal depressed. Coasting uses the inertia of driving energy instead of the vehicle power.
- The regenerative braking system uses the electric motor to apply the brake. The electric motor converts the kinetic energy generated from decelerating the vehicle to electricity and charges the high voltage battery.

Smart regeneration system on/off

Operate the paddle shifter as shown below to use the smart regeneration system.

- **Turning on the smart regeneration system:**
Select **Setup > Vehicle > ECO Vehicle > Smart Regeneration System** from the infotainment system, shift the gear to D (Drive), and pull and hold the left paddle shifter (-) for over a second.

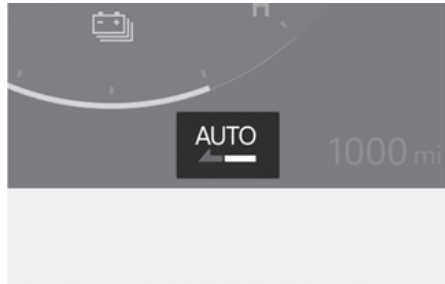

The smart regeneration system is ON and the regenerative braking level appears as "AUTO".

- **Turning off the smart regeneration system:**
Select **Setup > Vehicle > ECO Vehicle > Smart Regeneration System** from the infotainment system, pull and hold the left paddle shifter (-) for over a second. The regenerative braking level 1 to 3 appears instead of "AUTO" on the instrument cluster and the smart regeneration system turns off.

Smart regeneration system operating condition

When the regenerative braking level 1 to 3 appears as "AUTO" and the vehicle speed is above 3 mph (5 km/h), the system automatically controls the regenerative braking level under the following conditions.

- The road gradient changes.
- Distance from the vehicle ahead reduces or increases.
- Speed of the vehicle ahead reduces or increases.

⚠ CAUTION

- When the forward safety warning light is ON, the smart regeneration system does not work properly. Depress the brake pedal for deceleration.
- The function that adjusts the regenerative braking intensity depending on the road gradient is only effective when the regenerative braking level is 0. Braking intensity does not significantly change depending on the road gradient if the regenerative braking level is 1 or above.

Smart regeneration level settings



When the smart regeneration system is ON, the regenerative braking level appears as "AUTO" on the instrument cluster. The "AUTO" appears in grey in the ready state. The system automatically controls the regenerative braking level (2) according to the smart regeneration system operating conditions. If the front radar detects a vehicle in front, the indicator light (3) appears in green.

Smart regeneration default setting

The default braking level of the smart regeneration system can be changed. Set the default braking level to the lowest and let the system adjust the braking intensity automatically.

To change the smart regeneration default setting, pull the left or right paddle shifter to adjust the level from 1 to 3 while the smart regeneration system is ON.

Pausing smart regeneration system

The smart regeneration system is temporarily turned off in the following conditions. While the system is turned off, adjust your vehicle speed depending on the road conditions.

- The vehicle is turned back ON after turning OFF.
- The gear is shifted to N (Neutral), R (Reverse) or P (Park).
- The drive mode is changed to SPORT mode.
- Smart Cruise Control is activated.
- ESC (Electronic Stability Control) is operating/ABS (Anti-lock Brake System) is operating.
- The motor and battery temperature is high or low or there is a malfunction with the battery or transmission.
- SOC (State of Charge) is high.

Front sensor



[A] Front radar

Front radar detects the distance between your vehicle and the vehicle ahead to control the regenerative braking intensity.

Smart regeneration system disabled

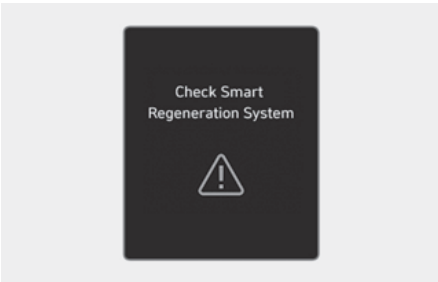

If the rear radar is covered by any foreign material, such as snow, rain, or dirt, the detecting performance may decrease and disable the smart regeneration system.

The "Check Smart Regeneration System" warning message may appear on the instrument cluster.

Also the regenerative braking level appears instead of "AUTO".

Remove such foreign material and turn on the system again by pulling and holding the left paddle shifter (-) for over a second.

If the system does not operate normally after anything covering the sensor is removed, have your vehicle inspected by an authorized HYUNDAI dealer.

Precautions for smart regeneration system

The smart regeneration system is not a substitute for proper and safe driving.

To prevent serious injury or death:

General precautions

- Always maintain a safe distance from the vehicles ahead and adjust your vehicle speed to the road conditions.
- The smart regeneration system cannot detect pedestrians, vehicles making a sudden stops and vehicles coming from the opposite lane.
- Vehicles frequently changing lanes may cause a delay or may cause the smart regeneration system to react to a vehicle in an adjacent lane.
- Depress the brake pedal when stopping the vehicle.
- Depress the brake pedal to decelerate in the following conditions when:
 - The front part of the vehicle is lifted up because of the cargo loaded on the rear part of the vehicle.
 - The steering wheel is being steered.
 - The vehicle is being driven in the center of the lane.
 - The vehicle is being driven on a narrow or curved road.
- The smart regeneration system may not operate normally if there is interference from strong electromagnetic waves.

Sensor precautions

- If there is impact on or near the radar, the radar may be damaged or not be properly aligned near the radar, even though a warning message does not appear on the instrument cluster, the system may not operate properly. Have your vehicle inspected by an authorized HYUNDAI dealer.
- Always keep the sensor and the surrounding clean.
- Do not install a license plate frame or other objects such as bumper sticker, film, bumper guard, or bumper wrap near the radar.
- Use only genuine HYUNDAI parts to repair the bumper where the radar is located.
- Smart regeneration system may not work properly if the bumper has been replaced, or the surroundings of the radar has been damaged or painted.
- Do not spray the front radar or the surrounding area directly with high pressure water.

Vehicle detection precautions

Detecting vehicle ahead

- The smart regeneration system may not detect the vehicle ahead or may suddenly detect the vehicle ahead, such as when the smart regeneration system responds slowly, or when driving uphill, or when driving through a curve. The regenerative braking intensity may increase and decelerate your vehicle.
- Some vehicles in your lane may not be detected by the sensor:
 - Narrow vehicles, such as motorcycles or bicycles
 - Vehicles offset to one side
 - Slow-moving vehicles or sudden decelerating vehicles
 - Vehicles with small rear profile, such as trailers with no loads

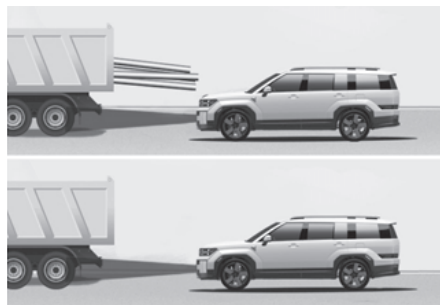

- When the vehicle in front of the foregoing vehicle is at a stop and the foregoing vehicle changes the lane, the front sensors may be unable to recognize the stopped vehicle.

Driving on curves

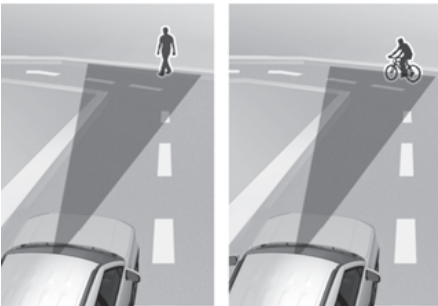

On curves, the smart regeneration system may not detect a vehicle in the same lane, and may accelerate the vehicle by lowering the regenerative braking intensity automatically. Your vehicle speed may decelerate by increasing regenerative braking intensity automatically if a vehicle is detected in an adjacent lane or when a vehicle ahead is detected suddenly. Apply the brake pedal or accelerator pedal depending on the road and driving conditions.

Driving on hills

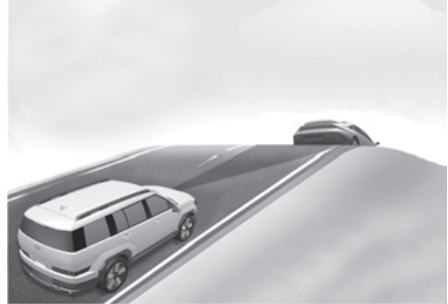

During uphill or downhill coasting, the smart regeneration system may not detect a moving vehicle in your lane, and cause your vehicle to accelerate. Also, your vehicle speed decelerates when a vehicle ahead is detected suddenly. Apply the brake pedal or accelerator pedal depending on the road and driving conditions.

Changing lanes



When a vehicle moves into your lane from an adjacent lane, it cannot be detected by the sensor until it is in the sensor's detection range. The smart regeneration system may not immediately detect the vehicle when your vehicle changes lanes abruptly.

Coasting

+ if equipped

When an upcoming decelerating event is predicted by analyzing the navigation path and road information, the driver is informed of when to release the accelerator pedal (single notification sound and indicator on cluster) to reduce unnecessary fuel consumption and minimize brake use.

i Information

Deceleration events: change of direction (right/left/U-turn), roundabout, highway entrance/exit, liftgate

Coasting setting

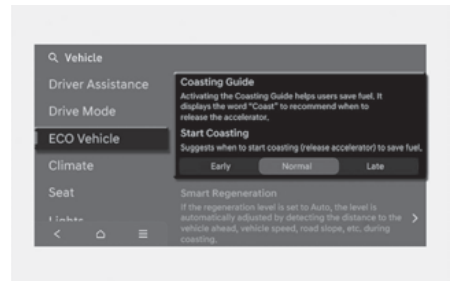

- The Coasting function must be turned ON from the infotainment system. Select:
 - **Setup > Vehicle > ECO Vehicle > Coasting Guide**
- For more information, scan the QR code in a separately supplied simple manual.
- When the coasting is turned ON and the conditions are met, the "**Coasting**" message will appear on the instrument cluster. The coasting starts when the accelerator pedal is depressed and released.

Coasting operating conditions

The Coasting function operates under the following conditions:

- A destination is selected in the navigation system
- ECO is selected for driving mode
- ECO or Smart is selected for Powertrain in the MY DRIVE MODE menu from the infotainment system. If Smart is selected, driver acceleration should be mild
- The gear is in D (Drive)
- The Smart Cruise Control button is OFF
- The accelerator or brake pedal is not depressed
- The vehicle's speed is within 20-100 mph (30-160 km/h) range

i Information

- The Coasting operation may be affected by the size of tires and the amount of pressure.
- The Start Coasting is designed to be used perfectly for every condition.
- Depending on the driving condition (road slope, distance, etc.), Coasting operation will not activate even if the above conditions are met.

Drive Mode Integrated Control System

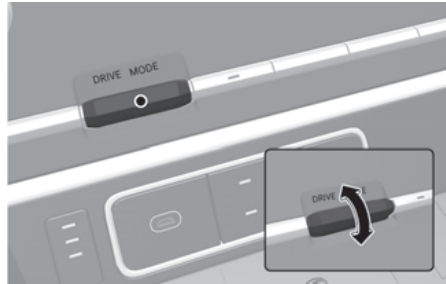

The drive mode can be selected according to the driver's preference or road condition.

The system resets to ECO mode, when the engine is restarted.

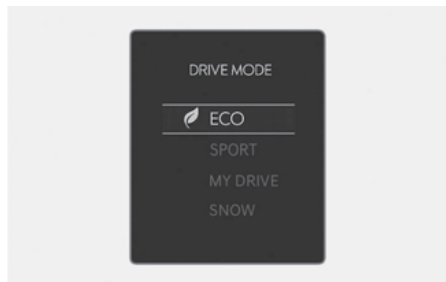

The mode changes, as the following, whenever the DRIVE MODE button is toggled.

ECO ↔ SPORT ↔ MY DRIVE ↔ SNOW
(if equipped)

Drive mode features

ECO mode

ECO mode helps improve fuel economy for eco-friendly driving.

Fuel economy varies according to the driver's driving habit and road condition.

- When ECO mode is selected, the ECO indicator illuminates on the instrument cluster.
- When ECO mode is activated:
 - The acceleration response may be slightly reduced if the accelerator pedal is depressed moderately.
 - The air conditioner performance may be limited.
 - The shift pattern of the transmission may change.
 - Engine noise may be louder at some transmission shifts as downshift requires pressing down more on the accelerator pedal.

The above situations are normal conditions when ECO mode is activated to help improve fuel economy.

SPORT mode

SPORT mode provides sporty but firm riding.

In SPORT mode, the energy efficiency may decrease.

- When the SPORT mode is selected, the SPORT indicator illuminates on the instrument cluster.

MY DRIVE MODE

In MY DRIVE MODE, you can adjust the vehicle performance for each function. To set **MY DRIVE MODE**, select **Setup > Vehicle > Drive Mode > MY DRIVE MODE** in the infotainment system.

	MY DRIVE MODE
Powertrain	ECO/SPORT/SMART
Steering	SPORT

i Information

The infotainment system may change after software updates. For more information, refer to the user's manual provided in the infotainment system and the quick reference guide.

SMART mode

SMART mode selects the proper driving mode among SMART ECO/SMART SPORT by judging the driver's driving habits (for example, mild or dynamic) from the brake pedal depression or the steering wheel operation.

- **Various driving situations, which you may encounter in SMART mode**
 - The driving mode automatically changes to SMART ECO mode after a certain period of time, when you gently depress the accelerator pedal (Your driving is categorized to be mild.).
 - The driving mode automatically changes to SMART SPORT, when you abruptly accelerate the vehicle or repetitively operate the steering wheel (Your driving is categorized to be sporty.). In this mode, your vehicle drives in a lower gear for abrupt accelerating or decelerating and increases the engine brake performance.

- The driving mode automatically changes to SMART SPORT mode with the same driving patterns, when the vehicle starts to drive on an upward slope of a certain angle. The driving mode automatically returns to SMART ECO mode, when the vehicle enters a leveled road.
 - The driving mode automatically changes to SMART SPORT mode only in harsh driving situations. In most of the normal driving situations, the driving mode sets to be in SMART ECO mode.
- **Limitation of SMART mode**

SMART may be limited in following situations.

 - The driver is using the paddle shifter to manually shift gear. (The system prioritizes the driver's manual shifting)
 - Smart Cruise Control is activated.
 - The transmission oil temperature is either extremely low or extremely high.

i Information

When you dynamically drive the vehicle in SMART mode by abruptly decelerating or sharply curving, the driving mode changes to SPORT mode. However, it may adversely affect fuel economy.

SNOW mode (for 4WD vehicle)

If equipped

SNOW mode helps to drive on slippery roads.

The motor's driving power is properly distributed to the wheels, to help start the vehicle stably on slippery roads or keep tires from slipping.

- The drive mode resets to ECO mode when the vehicle is restarted.

TOW mode

If equipped

When towing a trailer, switching to TOW mode enables smooth driving by changing the shifting pattern to suit heavy loads.

Operating button

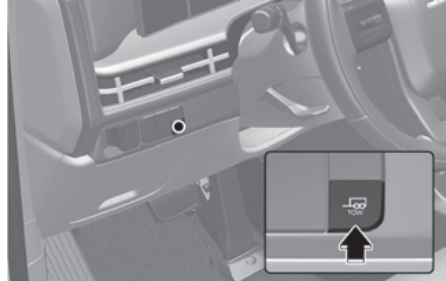

Press the Tow mode button to turn on or off the function.

Setting features

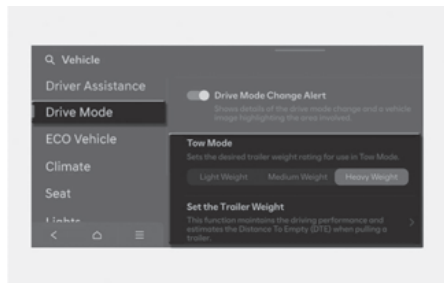

When the gear is in P (Park), select **Setup > Vehicle > Drive Mode > Tow Mode** from the infotainment system to set the weight of trailer to be towed.

Active air flap

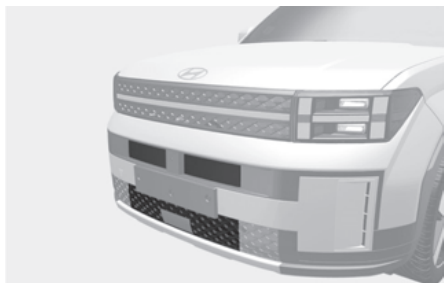

Active air flap system controls the air flap below the front bumper to cool the vehicle parts and improve energy efficiency.

i Information

Active air flap system could be activate regardless of the vehicle condition. (Parking, driving, etc.)

Malfunction

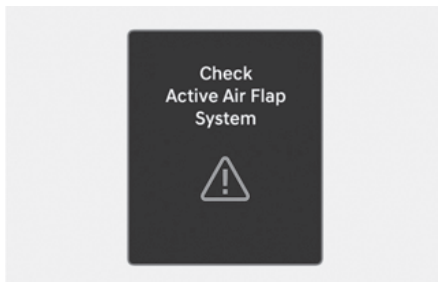

The active air flap system may not operate normally if the air flap is temporarily opened due to foreign factors or if the controller is contaminated by snow or rain, etc.

When "**Check Active Air Flap system**" is popped up on display, stop the vehicle in a safe place and check the status of the air flap.

Start the vehicle after performing the necessary work like foreign matter removal and waiting 10 minutes. If the pop-up remains up, contact an authorized HYUNDAI dealer.

CAUTION

- Regardless of the pop-up, if the air flaps aren't in the same position, stop the vehicle and wait for 10 minutes and start the vehicle and inspect the air flap.
- The active air flap system is actuated by motors. Do not disturb actuation or apply force excessively. It may cause failure.

Special Driving Conditions

Hazardous driving conditions

When hazardous driving conditions are encountered such as water, snow, ice, mud, and sand:

- Drive cautiously and allow for longer braking distances.
- Avoid abrupt braking or steering.
- If your vehicle is stuck in snow, mud, or sand, use the second gear. Accelerate slowly to avoid unnecessary wheel spin.
- Put sand, rock salt, tire chains, or other non-slip materials under the wheels to provide additional traction if stuck in ice, snow, or mud.



WARNING

Downshifting with an automatic transmission while driving on slippery surfaces may cause a crash. The sudden change in tire speed may cause the tires to skid. Be careful when downshifting on slippery surfaces.

Rocking the vehicle

If it is necessary to rock the vehicle to free it from snow, sand, or mud, first turn the steering wheel right and left to clear the area around your front wheels. Then, shift back and forth between R (Reverse) and a forward gear.

Try to avoid spinning the wheels, and do not race the engine.

To prevent transmission wear, wait until the wheels stop spinning before shifting gears. Release the accelerator pedal while shifting, and press lightly on the accelerator pedal while the transmission is in gear. Slowly spinning the wheels in forward and reverse directions causes a rocking motion that may free the vehicle.



WARNING

Always turn off the ESC system before rocking the vehicle. If the vehicle is stuck and excessive wheel spin occurs, the temperature in the tires may increase very quickly. If the tires become damaged, a tire blow out or tire explosion may occur - you and others may be injured. Do not attempt this procedure if people or objects are near the vehicle.

If you attempt to free the vehicle, the vehicle may overheat quickly, possibly causing an engine compartment fire or other damage. Try to avoid spinning the wheels as much as possible to prevent overheating of the tires or the engine. **DO NOT** allow the vehicle to spin the wheels above 35 mph (56 km/h).

If you are still stuck after rocking the vehicle a few times, have the vehicle pulled out by a tow vehicle to avoid engine overheating, possible damage to the transmission, and tire damage. Refer to the "Towing" section in chapter 8.

Smooth cornering

Avoid braking or gear changing in corners, especially when roads are wet. Ideally, cornering should be taken under gentle acceleration.

Driving at night

Night driving presents more hazards than driving in the daylight. Here are some important tips to remember:

- Slow down and keep more distance between you and other vehicles, because it may be more difficult to see at night, especially in areas where there are no street lights.
- Adjust your mirrors to reduce the glare from other drivers' headlights.
- Keep your headlights clean and properly aimed. Dirty or improperly aimed headlights can make it much more difficult to see at night.
- Avoid staring directly at the headlights of oncoming vehicles. You may be temporarily blinded, and it takes several seconds for your eyes to readjust to the darkness.

Driving in the rain

Rain and wet roads can make driving dangerous. When driving in the rain or on slick pavement:

- Slow down and allow extra following distance. A heavy rainfall makes it harder to see and increases the distance needed to stop your vehicle.
- Turn OFF your Cruise Control. (if equipped)
- Replace your windshield wiper blades when they show signs of streaking or missing areas on the windshield.
- Make sure your tires have enough tread. If your tires do not have enough tread, making a quick stop on wet pavement may cause a skid and possibly lead to a collision. Refer to the "Tires And Wheels" section in chapter 9.
- Turn on your headlights to make it easier for others to see you. Using your headlights when using your windshield wipers is required in some jurisdictions.

- Driving too fast through large puddles may affect your brakes. If you must go through puddles, try to drive through them slowly.
- If you believe your brakes are wet, apply them several times while the vehicle is moving slowly.

Hydroplaning

If the road is wet enough and you are driving fast enough, your vehicle may have little or no contact with the road surface and actually ride on the water. The best advice is SLOW DOWN when the road is wet.

The risk of hydroplaning increases as the depth of tire tread decreases, refer to the "Tires And Wheels" section in chapter 9.

Driving in flooded areas

Avoid driving through flooded areas unless you are sure the water is not deeper than the bottom of the wheel hub. If you are not sure, turn around and find a different route.

Drive through any water slowly. Allow adequate stopping distance because the brake performance can be reduced.

After driving through water, dry the brakes by gently applying them several times while the vehicle is moving slowly.

Highway driving

Tires

Adjust the tire inflation pressure, as specified. Under-inflation may overheat or damage the tires.

Do not install worn-out or damaged tires, which may reduce traction or fail.

i Information

Never over-inflate your tires above the maximum inflation pressure, as specified on your tires.

Fuel, engine coolant and engine oil

Driving at higher speeds on the highway consumes more fuel and is less efficient than driving at a slower, more moderate speed. Maintain a moderate speed to conserve fuel when driving on the highway.

Check both the engine coolant level and the engine oil before driving.

Drive belt

A loose or damaged drive belt may overheat the engine.

Winter Driving

Snow or icy conditions

You need to keep sufficient distance between your vehicle and the vehicle in front.

Apply the brakes gently. Speeding, rapid acceleration, sudden brake applications, and sharp turns are very hazardous practices. When decelerating, use engine braking to the fullest extent. Sudden brake applications on snowy or icy roads may cause the vehicle to skid.

To drive your vehicle in deep snow, it may be necessary to use snow tires or to install tire chains on your tires.

Always carry emergency equipment. You may want to carry tire chains, tow straps or chains, a flashlight, emergency flares, sand, a shovel, jumper cables, a window scraper, gloves, ground cloth, coveralls, a blanket, etc.

Snow tires

⚠ WARNING

Snow tires should be equivalent in size and type to the vehicle's standard tires. Otherwise, the safety and handling of your vehicle may be adversely affected.

Use snow tires when the road temperature is below 45 °F (7 °C). If you mount snow tires on your vehicle, be sure to use the same inflation pressure as the original tires. Mount snow tires on all four wheels to balance your vehicle's handling in all weather conditions. The traction provided by snow tires on dry roads may not be as high as your vehicle's original equipment tires. Check with the tire dealer for maximum speed recommendations.

Tire chains

Wire chain

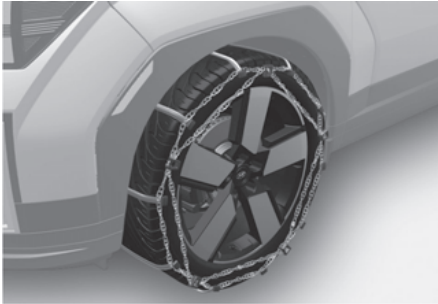

Fabric-type chain

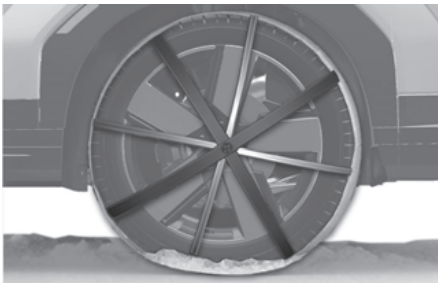

Since the sidewalls of radial tires are thinner than other types of tires, they may be damaged by mounting some types of tire chains on them. Therefore, the use of snow tires is recommended

instead of tire chains. If tire chains must be used, use genuine HYUNDAI Parts and install the tire chains after reviewing the instructions provided with the tire chains. Damage to your vehicle caused by improper tire chain use is not covered by your vehicle manufacturer's warranty.

235/60R18 255/45R20	Wire chain (Under 0.47 in. (12 mm) thickness) or Fabric-type chain
------------------------	--

When using tire chains, attach them to the front wheels.

WARNING

The use of tire chains may adversely affect vehicle handling:

- Drive less than 20 mph (30 km/h) or the chain manufacturer's recommended speed limit, whichever is lower.
- Drive carefully and avoid bumps, holes, sharp turns, and other road hazards, which may cause the vehicle to bounce.
- Avoid sharp turns or locked wheel braking.
- Install tire chains only in pairs and on the front tires. Installing tire chains on the tires provides a greater driving force, but does not prevent side skids.

Information

Do not install studded tires without first checking local and municipal regulations for possible restrictions against their use.

Chain installation

When installing tire chains, follow the manufacturer's instructions and mount them as tightly possible. Drive slowly (less than 20 mph (30 km/h) or the chain manufacturer's recommended speed limit) with chains installed. If you hear the chains contacting the body or chassis, stop and tighten them. If they still make contact, slow down until the noise stops. Remove the tire chains as soon as you begin driving on cleared roads.

When mounting snow chains, park the vehicle on level ground away from traffic. Turn on the vehicle's Hazard Warning Flasher and place a triangular emergency warning device behind the vehicle (if available). Always place the vehicle in P (Park), apply the parking brake, and turn off the engine before installing snow chains.

 **CAUTION**

When using tire chains:

- Wrong size chains or improperly installed chains may damage your vehicle's brake lines, suspension, body, and wheels.
- Use SAE "S" class or wire chains.
- If you hear noise caused by chains contacting the body, retighten the chains to prevent contact with the vehicle body.
- To prevent body damage, retighten the chains after driving 0.3-0.6 mi. (0.5-1.0 km).
- Do not use tire chains on vehicles equipped with aluminum wheels. If unavoidable, use a wire type chain.
- Use wire chains less than 0.47 in. (12 mm) thick to prevent damage to the chain's connection.

Winter precautions

Use high quality ethylene glycol coolant

Your vehicle is delivered with high quality ethylene glycol coolant in the cooling system. It is the only type of coolant that should be used because it helps prevent corrosion in the cooling system, lubricates the water pump, and prevents freezing. Be sure to replace or replenish your coolant in accordance with the "Scheduled Maintenance Services" in chapter 9. Before winter, have your coolant tested to make sure that its freezing point is sufficient for the temperatures anticipated during the winter.

Check battery and cables

Winter temperatures may affect the battery performance. Inspect the battery and cables, as specified in chapter 9. The battery charging level can be checked by an authorized HYUNDAI dealer or in a service station.

Change to "winter weight" oil if necessary

In some regions in winter, it is recommended to use the "winter weight" oil with lower viscosity. In addition, replace the engine oil and filter if it is close to the next maintenance interval. Fresh engine oil ensures optimum engine operation during the winter months. For more information, refer to chapter 10. When you are not sure about a type of winter weight oil, contact an authorized HYUNDAI dealer.

Check spark plugs and ignition system

Inspect the spark plugs, as specified in chapter 9. If necessary, replace them. Also check all ignition wirings and components for any cracks, wear, and damage.

To prevent locks from freezing

Spray approved de-icing fluid or glycerin into key holes. When a lock opening is already covered with ice, spray approved de-icing fluid over the ice to remove it. When an internal part of a lock freezes, try to thaw it with a heated key. Carefully use the heated key to avoid an injury.

Use approved window washer anti-freeze solution

Add window washer anti-freeze solution, as specified on the window washer container. Window washer anti-freeze solution is available from an authorized HYUNDAI dealer, and most vehicle accessory outlets.

i Information

Do not use engine coolant or other types of anti-freeze solution, to prevent any damage to the vehicle paint.

Do not let your parking brake freeze

Under some conditions, your parking brake may freeze in the engaged position. This is most likely to happen when there is an accumulation of snow or ice around or near the rear brakes or the brakes are wet. When there is the risk that your parking brake may freeze: temporarily apply the parking brake with the gear in P (Park), then block the rear wheels, and then release the parking brake.

Do not let ice and snow accumulate underneath

Under some conditions, snow and ice may build up under the fenders and interfere with the steering. When driving in such conditions during the severe winter, check underneath the vehicle on a regular basis, to make sure that the front wheels and the steering components are not blocked.

Carry emergency equipment

In accordance with weather conditions, carry appropriate emergency equipment, while driving. Some of the items you may want to carry include tire chains, tow straps or chains, flashlight, emergency flares, sand, shovel, jumper cables, window scraper, gloves, ground cloth, coveralls, blanket, etc.

Do not place objects or materials in the engine compartment

Putting objects or materials in the engine compartment may cause an engine failure or a fire, because they may block the engine cooling. Such damage is not covered by the manufacturer's warranty.

Drive your vehicle when water vapor condenses and accumulates inside the exhaust pipes

When the vehicle is stopped for a long time in winter while the engine is running, water vapor may condense and accumulate inside the exhaust pipes. Water in the exhaust pipes may cause noise, etc., but it is drained driving at medium to high speed.

Trailer Towing

Towing a trailer requires experience. The combination of the vehicle and trailer itself is not as responsive as the vehicle by itself. Towing a trailer also requires additional equipment and adequate planning before a trip. Plan your trip according to the speed limits for towing a trailer that may differ from country to country. Always follow the posted speed limits while towing a trailer. Remember that driving your vehicle with a trailer is different from normal driving. Driving with a trailer causes changes to acceleration, braking, handling and stability, and fuel economy. For safety of you and passengers, do not overload your vehicle or trailer. Refer to the table in this section for the maximum towing capacity and payload.

This section contains important trailering recommendations and safety rules. Many of these recommendations are important considerations for the safety of you and your passengers. Be sure to read this section carefully and plan ahead before towing a trailer.

WARNING

To prevent serious injury or death:

- If you do not use the correct equipment and/or drive improperly, you can lose control of the vehicle when you are pulling a trailer. For example, if the trailer is too heavy, the braking performance may be reduced. You and your passengers could be seriously or fatally injured. Pull a trailer only if you have followed all the steps in this section.
- Before towing, make sure the total trailer weight, GCW (Gross Combination Weight), GVW (Gross Vehicle Weight), GAW (Gross Axle Weight) and trailer tongue load are all within the limits.

Information

- Do not install any equipment on the vehicle that blocks the license plate and cannot be easily removed or repositioned.
- When a trailer is not used, detach it from the vehicle so that the license plate is visible.

WARNING

- Always have your eyes on the road when towing a trailer. When a trailer is connected to the tow hitch harness installed to your vehicle, the following functions are turned off automatically:
 - Forward/Side Safety function of Forward Collision-Avoidance Assist
 - Lane Keeping Assist
 - Blind-Spot Collision-Avoidance Assist
 - Safe Exit Assist
 - Lane Following Assist
 - Highway Driving Assist
 - Rear Cross-Traffic Collision-Avoidance Assist
 - Reverse Parking Distance Warning
 - Parking Collision-Avoidance Assist
 - Remote Smart Parking Assist

For more information on each function, refer to chapter 7.

The tow hitch harness installed to your vehicle must be a genuine HYUNDAI parts. For more information, consult an authorized HYUNDAI dealer products.

- If a trailer or hitch mounted carrier is attached, it may adversely affect the performance of the rear corner radar.

- If a trailer, carrier or other attachment is installed around the rear corner radar, Blind-Spot Collision-Avoidance Assist, Safe Exit Warning, Rear Cross-Traffic Collision-Avoidance Assist may not operate properly, or it may operate unexpectedly.

If you decide to pull a trailer

- Consider using a sway control. You can ask a trailer hitch dealer about sway control.
- Hyundai recommends that you contact an authorized HYUNDAI dealer for further information on additional requirements such as towing kit etc.
- Do not exceed 60 mph (100 km/h) or the posted towing speed limit, whichever is lower, when towing a trailer. Note that towing speed limits differ by country. Always be aware of the posted towing speed limit.
- Do not exceed 45 mph (70 km/h) or the posted towing speed limit, whichever is lower on a long uphill grade.
- Trailer instability is more likely to occur when descending steep or long downhill grades. Pay close attention and slow your vehicle speed when descending a long downhill grade. Allow more time and distance for braking and do not brake suddenly. Use the Paddle Shifter (-) (Regenerative Braking System in ECO mode or manual shift mode in SPORT mode) to reduce your vehicle speed and also to help prevent brakes from overheating.
- Carefully observe the weight and load limits provided in the following pages.

Towing load limits

Your vehicle can tow a trailer if you carefully observe the towing load limits, use proper equipment, and follow the towing guidelines. Check the load limits before driving.

Total trailer weight

Do not exceed the maximum allowable weight of the trailer, cargo, and everything in or on it. Refer to the table on the following page for the maximum allowable trailer weight.

WARNING

Exceeding the load limit or improperly loading your vehicle and trailer can cause a collision, resulting in serious injury or death.

Be sure to check the loading of your vehicle and trailer carefully before driving.

Trailer weight

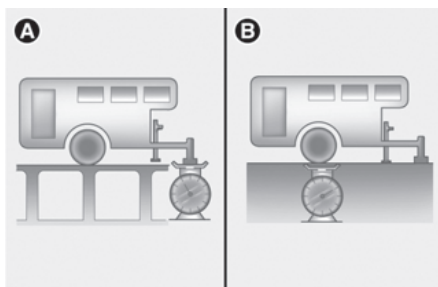

[A] Tongue load

[B] Total trailer weight

Check if the total load is within limits at a public scale. If a public scale is not available, add the estimated weight of your cargo load to the weight of your trailer (as specified by your trailer manufacturer). In addition, measure the tongue load with an appropriate scale or tongue gauge, or estimate it based on the cargo distribution.

Tongue load

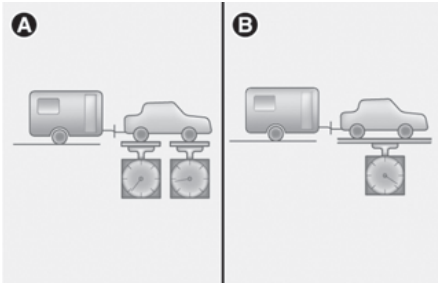

[A] Gross axle weight
[B] Gross vehicle weight

The tongue load is extremely important when setting up your trailer for towing with your vehicle. Excessive tongue load reduces front tire traction and steering control. For example, too little tongue load can make the trailer unstable, causing the trailer to sway because the weight of the trailer is shifted to the rear. The tongue load measured at the hitch when fully loaded should be within 10-15 % of the total weight of the trailer. Be sure to check the load of your vehicle and trailer before driving. Check if the total load is within limits at a public scale. In addition, measure the tongue load with an appropriate scale or tongue gauge. If a public scale is not available, estimate the weight of your cargo load and add the value to the weight of your trailer (as specified by the trailer manufacturer). Refer to the trailer's manual for additional information. Never exceed the gross vehicle weight rating (GVWR) for your vehicle.

How to weigh the trailer loads at a public scale

Fully load the vehicle and trailer before going to the public scale. You and passengers should remain in the vehicle when performing the measurement.

1. Measure the front gross axle weight.
2. Measure the gross vehicle weight.
3. Measure the rear gross axle weight.
4. Measure the gross combined weight (vehicle and trailer).

5. Measure the hitched trailer weight.

6. Measure the unhitched trailer weight.

To calculate the tongue load, subtract (5) from (6).

After you have loaded your trailer, weigh the trailer and then the tongue separately, to see if the weights are proper. If not, you can correct them simply by moving some items around in the trailer.

WARNING

To prevent serious injury or death:

- Never load a trailer with more weight in the rear than in the front. The front should be loaded with about 60 % of the total trailer load. The rear should be loaded with about 40 % of the total trailer load.
- Never exceed the maximum weight limits of the trailer or trailer towing equipment. Check weights and loading at a commercial scale or highway patrol office equipped with scales.

Information

With increasing altitude the engine performance decreases. From 0.6 mi. (1 km) above sea level and for every 0.6 mi.. (1 km) thereafter 10 % of vehicle/trailer weight (trailer weight + gross vehicle weight) must be deducted.

Towing a trailer - Maximum towing limits

For more information on the reference weight and distance when towing a trailer, refer to the "Reference Weight And Distance When Towing A Trailer" section in chapter 10.

Trailer equipment and accessories

Hitches

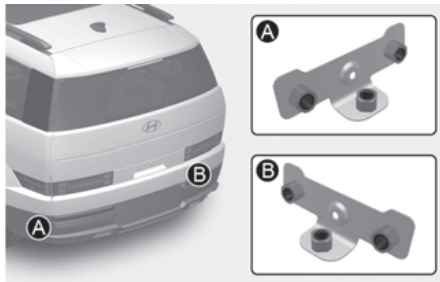

i Information

Make sure that all equipment is properly installed and maintained, and that it meets your country's regulations. Hyundai recommends that you have all trailer hitch equipment installed at an authorized HYUNDAI dealer with factory-recommended accessory parts that are specifically designed for your vehicle.

Here are some rules to follow about hitches:

- The bumpers on your vehicle are not intended for hitches. Do not attach rental hitches or other bumper-type hitches to them. Use only a frame mounted hitch that does not attach to the bumper.

- Any part of the rear license plate or lighting devices of the vehicle must not be obscured by the mechanical coupling device. If the rear number plate and/or lighting devices can be obscured partially by any part of the mechanical coupling device, mechanical coupling devices that cannot be easily removed or repositioned without use of any tools, except an easily operated (an effort not exceeding 20 Nm (15 lbf.ft) release key that is supplied by the manufacturer of the coupling device, are not permitted for use. Note that the mechanical coupling device that is fitted and not used must always be removed or repositioned if the rear number plate and/or rear lighting devices are obscured by any part of the mechanical coupling device.

- A HYUNDAI trailer hitch accessory is available at an authorized HYUNDAI dealer.

Safety chains

Always attach chains between your vehicle and your trailer.

Instructions about safety chains may be provided by the hitch manufacturer or trailer manufacturer. Follow the manufacturer's recommendation when attaching safety chains. Always leave just enough slack so you can turn with your trailer. And, never allow safety chains to drag on the ground.

Trailer brakes

Your country's regulations may require trailers to have their own braking system if the loaded weight of the trailer exceeds certain minimums that can vary from country to country. Read and follow the instructions for the trailer's braking system when it is installed, adjusted, and maintained properly. Never attempt to tap into your vehicle's hydraulic braking system.

WARNING

Do not use a trailer with its own brakes unless you are absolutely certain that you have properly set up the brake system. This is not a task for amateurs. Use an experienced, competent trailer shop for this work.

Driving with a trailer

Towing a trailer requires a certain amount of experience. Before driving, acquaint yourself with the feel of handling and braking with the added weight of the trailer. And always keep in mind that the vehicle you are driving is now longer and not nearly as responsive as your vehicle is by itself.

Before you start, check the trailer hitch and platform, safety chains, electrical connector(s), lights, tires, and brakes. During your trip, occasionally check the load is secure, and that the lights and trailer brakes are still working.

Following distance

Stay at least twice as far behind the vehicle ahead as you would when driving your vehicle without a trailer. This can help you avoid situations that require heavy braking and sudden turns.

Passing distance

You need more passing distance when you are towing a trailer. Because of the increased vehicle length, you may need to go much farther beyond the passed vehicle before you can return to your lane.

Backing up

Hold the bottom of the steering wheel with one hand. Then, to move the trailer to the left, move your hand to the left. To move the trailer to the right, move your hand to the right. Always back up slowly and, if possible, have someone guide you.

Making turns

When you are turning with a trailer, make wider turns than normal. Do this so your trailer does not strike soft shoulders, curbs, road signs, trees, or other objects. Avoid jerky or sudden maneuvers. Signal well in advance.

Turn signals

When you tow a trailer, your vehicle has to have a different turn signal flasher and extra wiring. The green arrows on your instrument panel will flash whenever you signal a turn or lane change. Properly connected, the trailer lights will also flash to alert other drivers you're about to turn, change lanes, or stop.

When towing a trailer, the green arrows on your instrument panel flashes for turns even if the bulbs on the trailer are burned out. Thus, you may think drivers behind you are seeing your signals when, in fact, they are not. It's important to check occasionally to make sure the trailer bulbs are still working. Check the lights every time you disconnect and then reconnect the wires.

WARNING

Do not connect a trailer lighting system directly to your vehicle's lighting system. Use an approved trailer wiring harness. Failure to do so may result in damage to the vehicle electrical system and/or personal injury. Contact an authorized HYUNDAI dealer for assistance.

Driving on hills

On a long uphill grade, shift down and reduce your vehicle speed to around 45 mph (70 km/h) to reduce the possibility of engine and transmission overheating. If you do not shift down, you might have to use the brakes and your brakes may overheat and may not operate efficiently.

If your trailer weighs more than the maximum trailer weight without trailer brakes and you have an automatic transmission, drive in D (Drive) when towing a trailer.

Operating your vehicle in D (Drive) when towing a trailer can minimize heat build-up and extend the life of your transmission.

NOTICE

To prevent engine and/or transmission overheating:

- When towing a trailer on steep grades (in excess of 6 %) pay close attention to the engine coolant temperature gauge to ensure the engine does not overheat. If the needle of the coolant temperature gauge moves towards "H" (HOT), pull over and stop as soon as it is safe to do so, and allow the engine to idle until it cools down. You may proceed once the engine has cooled sufficiently.
- If you tow a trailer with the maximum gross vehicle weight and maximum trailer weight, it can cause the engine or transmission to overheat. When driving in such conditions, allow the engine to idle until it cools down. You may proceed once the engine or transmission has cooled sufficiently.

- When towing a trailer, your vehicle speed may be much slower than the general flow of traffic, especially when climbing an uphill grade. Use the right hand lane when towing a trailer on an uphill grade. Choose your vehicle speed according to the maximum posted speed limit for vehicles with trailers, the steepness of the grade, and your trailer weight.

Parking on hills

Generally, if you have a trailer attached to your vehicle, you should not park your vehicle on a hill.

If you ever have to park your trailer on a hill:

1. Pull the vehicle into the parking space. Turn the steering wheel in the direction of the curb (right if headed down hill, left if headed up hill).
2. Shift the gear to P (Park).
3. Apply the parking brake and shut off the vehicle.
4. Place wheel chocks under the trailer wheels on the down hill side of the wheels.
5. Start the vehicle, hold the brakes, shift to neutral, release the parking brake and slowly release the brakes until the trailer chocks absorb the load.
6. Reapply the brakes and parking brake.
7. Shift the gear to P (Park) when the vehicle is parked on an uphill grade and in R (Reverse) on a downhill.
8. Shut off the vehicle and release the vehicle brakes but apply the parking brake.



WARNING

To prevent serious injury or death:

- Do not get out of the vehicle without applying the parking brake firmly. If you have left the vehicle running, the vehicle may move suddenly. You and others may be seriously or fatally injured.
 - Do not apply the accelerator pedal to hold the vehicle on an uphill.
-

Driving the vehicle after it has been parked on a hill

1. With the gear in P (Park) or N (Neutral), apply your brakes and hold the brake pedal down while you:
 - Start your vehicle.
 - Shift into gear.
 - Release the parking brake.
2. Slowly remove your foot from the brake pedal.
3. Drive slowly until the trailer is clear of the chocks.
4. Stop and have someone pick up and store the chocks.

Maintenance when towing a trailer

Your vehicle needs servicing more often when you regularly pull a trailer. Important items to pay particular attention to include automatic transmission fluid, axle lubricant, and cooling system fluid. Brake condition is another important item to frequently check. If you are trailering, it is a good idea to review these items before you start your trip. Do not forget to maintain your trailer and hitch. Follow the maintenance schedule that accompanies your trailer and check it periodically. Preferably, conduct checking at the start of each day's driving. Most importantly, all hitch nuts and bolts must be tight.

NOTICE

To prevent vehicle damage:

- Due to higher load during trailer usage, overheating might occur on hot days or during uphill driving. If the coolant gauge indicates over-heating, switch off the air conditioner and stop the vehicle in a safe area to cool down the engine.
 - Do not switch off the engine while the coolant gauge indicates overheating. (Keep the engine idle to cool down the engine)
 - When towing check transmission fluid more frequently.
 - If your vehicle is not equipped with an air conditioner, you should install a condenser fan to improve engine performance when towing a trailer.
-

Vehicle Load Limit

Two labels on your driver's door sill show how much weight your vehicle was designed to carry: the Tire and Loading Information Label and the Certification Label.

Before loading your vehicle, familiarize yourself with the following terms for determining your vehicle's weight ratings, from the vehicle's specifications and the Certification Label:

Base Curb Weight

This is the weight of the vehicle including a full tank of fuel and all standard equipment. It does not include passengers, cargo, or optional equipment.

Vehicle Curb Weight

This is the weight of your new vehicle when you picked it up from your dealer plus any aftermarket equipment.

Cargo Weight

This figure includes all weight added to the Base Curb Weight, including cargo and optional equipment.

GAW (Gross Axle Weight)

This is the total weight placed on each axle (front and rear) - including vehicle curb weight and all payload.

GAWR (Gross Axle Weight Rating)

This is the maximum allowable weight that can be carried by a single axle (front or rear). These numbers are shown on the Certification Label. The total load on each axle must never exceed its GAWR.

GVW (Gross Vehicle Weight)

This is the Base Curb Weight plus actual Cargo Weight plus passengers.

GVWR (Gross Vehicle Weight Rating)

This is the maximum allowable weight of the fully loaded vehicle (including all options, equipment, passengers and cargo). The GVWR is shown on the Certification Label located on the driver's door sill.

The loading information label

Type A

TIRE AND LOADING INFORMATION RENSEIGNEMENTS SUR LES PNEUS ET LE CHARGEMENT				
SEATING CAPACITY NOMBRE DE PLACES		TOTAL 7	FRONT AVANT 2	REAR ARRIÈRE 5
The combined weight of occupants and cargo should never exceed 480 kg or 1058 lb. Le poids total des occupants et du chargement ne doit jamais dépasser				
TIRE PNEU	SIZE DIMENSIONS	COLD TIRE PRESSURE PRESSION DES PNEUS À FROID		SEE OWNER'S MANUAL FOR ADDITIONAL INFORMATION VOIR LE MANUEL DE L'USAGER POUR PLUS DE RENSEIGNEMENTS
FRONT AVANT	235/60R18	240kPa, 35psi		
REAR ARRIÈRE	235/60R18	240kPa, 35psi		
SPARE DE SECOURS	NONE AUCUN			

Type B

TIRE AND LOADING INFORMATION RENSEIGNEMENTS SUR LES PNEUS ET LE CHARGEMENT				
SEATING CAPACITY NOMBRE DE PLACES		TOTAL 6	FRONT AVANT 2	REAR ARRIÈRE 4
The combined weight of occupants and cargo should never exceed 480 kg or 1058 lb. Le poids total des occupants et du chargement ne doit jamais dépasser				
TIRE PNEU	SIZE DIMENSIONS	COLD TIRE PRESSURE PRESSION DES PNEUS À FROID		SEE OWNER'S MANUAL FOR ADDITIONAL INFORMATION VOIR LE MANUEL DE L'USAGER POUR PLUS DE RENSEIGNEMENTS
FRONT AVANT	255/45R20	250kPa, 36psi		
REAR ARRIÈRE	255/45R20	250kPa, 36psi		
SPARE DE SECOURS	NONE AUCUN			

The label located on the driver's door jamb shows the original tire size, cold tire pressures recommended for your vehicle, the number of people that can be in your vehicle and vehicle capacity weight.

Vehicle capacity weight

- 1,058 lbs. (480 kg)

Vehicle capacity weight is the maximum combined weight of occupants and cargo. If your vehicle is equipped with a trailer, the combined weight includes the tongue load.

Seating capacity

- Total: 6 persons (Front seat: 2 persons, Rear seat: 4 persons)
- Total: 7 persons (Front seat: 2 persons, Rear seat: 5 persons)

Seating capacity is the maximum number of occupants including a driver that your vehicle may carry. However, the seating capacity may be reduced based upon the weight of all of the occupants, and the weight of the cargo being carried or towed. Do not overload the vehicle because there is a limit to the total weight, or load limit including occupants and cargo that the vehicle can carry.

Towing capacity

With brake system: 2,000 lbs. (907 kg)

Without brake system: 1,654 lbs. (750 kg)

Towing capacity is the maximum trailer weight including its cargo weight that your vehicle can tow.

Cargo capacity









The cargo capacity of your vehicle increases or decreases depending on the weight, the number of occupants, and the tongue load, if your vehicle is equipped with a trailer.

Steps for determining correct load limit

1. Locate the statement "The combined weight of occupants and cargo should never exceed XXX kg or XXX lbs." on your vehicle's placard.
2. Determine the combined weight of the driver and passengers that will be riding in your vehicle.
3. Subtract the combined weight of the driver and passengers from XXX kg or XXX lbs.
4. The resulting figure equals the available amount of cargo and luggage load capacity. For example, if the "XXX" amount equals 1400 lbs. and there will be five 150 lb passengers in your vehicle, the amount of available cargo and luggage load capacity is 650 lbs. ($1400 - 750 (5 \times 150) = 650$ lbs.)
5. Determine the combined weight of luggage and cargo being loaded on the vehicle. That weight may not safely exceed the available cargo and luggage load capacity calculated in Step 4.
6. If your vehicle will be towing a trailer, load from your trailer will be transferred to your vehicle. Consult this manual to determine how this reduces the available cargo and luggage load capacity of your vehicle.

 **WARNING**

Do not overload the vehicle because there is a limit to the total weight, or load limit, including occupants and cargo that the vehicle can carry. Overloading may shorten the life of the vehicle. If the GVWR or the GAWR is exceeded, parts on the vehicle may break, and it may change the handling of your vehicle. These may cause you to lose control and result in a crash.

<p>Example 1</p>	<p> Maximum Load (1400 lbs.) (635 kg)</p>	<p>≥</p>	<p> Passenger Weight (150 lbs. × 2 = 300 lbs.) (68 kg × 2 = 136 kg)</p>	<p>+</p>	<p> Cargo Weight (1100 lbs.) (499 kg)</p>
<p>Example 2</p>	<p> Maximum Load (1400 lbs.) (635 kg)</p>	<p>≥</p>	<p> Passenger Weight (150 lbs. × 5 = 750 lbs.) (68 kg × 5 = 340 kg)</p>	<p>+</p>	<p> Cargo Weight (650 lbs.) (295 kg)</p>
<p>Example 3</p>	<p> Maximum Load (1400 lbs.) (635 kg)</p>	<p>≥</p>	<p> Passenger Weight (172 lbs. × 5 = 860 lbs.) (78 kg × 5 = 390 kg)</p>	<p>+</p>	<p> Cargo Weight (540 lbs.) (245 kg)</p>

Certification label



The certification label is located on the driver's door sill at the center pillar and shows the maximum allowable weight of the fully loaded vehicle. This is called the GVWR (Gross Vehicle Weight Rating). The GVWR includes the weight of the vehicle, all occupants, fuel, and cargo.

This label also tells you the maximum weight that can be supported by the front and rear axles, called Gross Axle Weight Rating (GAWR).

The total weight of the vehicle, including all occupants, accessories, cargo, and trailer tongue load must not exceed the Gross Vehicle Weight Rating (GVWR) or the Gross Axle Weight Rating (GAWR). To find out the actual loads on your front and rear axles, you need to go to a weigh station and weigh your vehicle. Be sure to spread out your load equally on both sides of the centerline.

WARNING

- Never exceed the GVWR for your vehicle, the GAWR for the front or rear axle and the vehicle capacity weight. Exceeding these ratings may affect your vehicle's handling and braking ability, and cause a collision.
- Do not overload your vehicle. Overloading your vehicle may cause heat buildup in your vehicle's tires, possible tire failure, increased stopping distances, and poor vehicle handling. All of which may result in a collision.

WARNING

If you carry items inside your vehicle (e.g., suitcases, tools, packages, or anything else), they are moving as fast as the vehicle. If you have to stop or turn quickly, or if there is a collision, the items may cause an injury if they strike the driver or a passenger.

- Put items in the cargo area of your vehicle. Try to spread the weight evenly.
- Do not stack items like suitcases inside the vehicle above the top of the seats.
- Do not leave an unsecured child restraint in your vehicle.
- When you carry cargo inside the vehicle, secure it.

7. Driver Assistance System

Before Using Driver Assistance System	7-4
Driver assistance system settings	7-5
Forward Collision-Avoidance Assist (FCA)	7-6
Forward Collision-Avoidance Assist settings.....	7-9
Forward Collision-Avoidance Assist Operation	7-11
Forward Collision-Avoidance Assist Malfunction and Limitations.....	7-22
Lane Keeping Assist (LKA).....	7-32
Lane Keeping Assist settings.....	7-32
Lane Keeping Assist Operation	7-33
Lane Keeping Assist Malfunction and Limitations	7-35
Blind-Spot Collision-Avoidance Assist (BCA)	7-38
Blind-Spot Collision-Avoidance Assist settings.....	7-39
Blind-Spot Collision-Avoidance Assist Operation	7-40
Blind-Spot Collision-Avoidance Assist Malfunction and Limitations.....	7-43
Safe Exit Assist (SEA).....	7-47
Safe Exit Assist settings	7-48
Safe Exit Assist operation	7-48
Safe Exit Assist malfunction and limitations.....	7-50
Manual Speed Limit Assist (MSLA).....	7-52
Manual Speed Limit Assist Operation	7-52
Intelligent Speed Limit Assist (ISLA)	7-54
Intelligent Speed Limit Assist Settings.....	7-55
Intelligent Speed Limit Assist Operation.....	7-56
Intelligent Speed Limit Assist Malfunction and Limitations	7-58
Driver Attention Warning (DAW)	7-60
Driver Attention Warning Settings.....	7-61
Inattentive Driving Warning Operation	7-61
Driver Attention Warning Malfunction and Limitations	7-63
Forward Attention Warning (FAW).....	7-66
Forward Attention Warning settings	7-66
Forward Attention Warning operation	7-67
Forward Attention Warning malfunction and limitations	7-68
Blind-Spot View Monitor (BVM)	7-70
Blind-Spot View Monitor Settings	7-70
Blind-Spot View Monitor Operation	7-70

Blind-Spot View Monitor Malfunction	7-71
Smart Cruise Control (SCC).....	7-71
Smart Cruise Control Settings	7-72
Smart Cruise Control Operation	7-73
Smart Cruise Control Malfunction and Limitations	7-81
Emergency Stop (ES).....	7-87
Emergency Stop operation.....	7-87
Emergency Stop malfunction and limitations.....	7-88
Navigation-based Smart Cruise Control (NSCC).....	7-89
Navigation-based Smart Cruise Control Settings.....	7-89
Navigation-based Smart Cruise Control Operation.....	7-90
Limitations of Navigation-based Smart Cruise Control	7-91
Lane Following Assist (LFA).....	7-94
Lane Following Assist Settings	7-94
Lane Following Assist Operation	7-95
Lane Following Assist Malfunction and Limitations	7-98
Highway Driving Assist (HDA).....	7-98
Highway Driving Assist settings	7-99
Highway Driving Assist Operation	7-100
Highway Driving Assist Malfunction and Limitations	7-108
Rear View Monitor (RVM).....	7-110
Rear View Monitor settings	7-110
Rear View Monitor Operation.....	7-111
Rear View Monitor Malfunction and Limitations	7-113
Surround View Monitor (SVM)	7-113
Surround View Monitor settings	7-114
Surround View Monitor Operation.....	7-115
Surround View Monitor Malfunction and Limitations	7-117
Rear Cross-Traffic Collision-Avoidance Assist (RCCA)	7-118
Rear Cross-traffic Collision-Avoidance assist settings.....	7-118
Rear Cross-Traffic Collision-Avoidance Assist Operation	7-119
Rear Cross-Traffic Collision-Avoidance Assist Malfunction and Limitations	7-122
Parking Distance Warning (PDW)	7-127
Parking Distance Warning settings	7-128
Parking Distance Warning Operation	7-128

7. Driver Assistance System

Parking Distance Warning Malfunction and Limitations.....	7-131
Reverse Parking Collision-Avoidance Assist (PCA).....	7-134
Reverse Parking Collision-Avoidance Assist settings	7-134
Reverse Parking Collision-Avoidance Assist Operation.....	7-135
Reverse Parking Collision-Avoidance Assist Malfunction and Limitations	7-136
Remote Smart Parking Assist (RSPA).....	7-140
Remote Smart Parking Assist Settings.....	7-141
Remote Smart Parking Assist Operation.....	7-142
Remote Smart Parking Assist Malfunction and Limitations	7-147
Driver Assistance System Sensors	7-153
Cameras.....	7-153
Radars.....	7-154
Ultrasonic sensors.....	7-155
Declaration Of Conformity.....	7-157
Front radar.....	7-157
Front corner radar (if equipped)/Rear corner radar	7-157

Before Using Driver Assistance System

WARNING

Always maintain a safe distance from the vehicles ahead and adjust your vehicle speed to the road conditions. Driver Assistance system may not operate in all situations and cannot avoid all collisions.

To prevent serious injury or death:

- Control your vehicle at all times. In some cases, the Driver Assistance system may provide unanticipated braking or steering.
 - Never attempt to activate any Driver Assistance system by intentionally driving toward people, animals, objects, or other vehicles.
 - The steering, braking, and acceleration inputs from you may override the responses from driver assistance system.
 - Do not use Driver Assistance system when towing a trailer or using a hitch mounted carrier.
 - Do not use Driver Assistance system if you believe the sensors or the systems may not be functioning properly.
-

Information

Due to the infotainment software version, the description of each function of the driver assistance system may differ from the owner's manual.

Limitations of Driver Assistance System

Nearby vehicles, road conditions, or other factors may delay the response from Driver Assistance system or cause these systems not to function, including:

- Lane-restricted driving situations (tollbooths, construction zones, etc.)
- Curves, hills, or other road features that may detect vehicles in adjacent lanes or not detect vehicles ahead in the roadway
- If other vehicles, pedestrians, or cyclists are not detected
- Driving in inclement weather, such as heavy rain, snow or icy conditions
- Interference from strong electromagnetic waves
- Streets with railroad tracks or other embedded metal objects
- If anything is blocking or covering a sensor
- If any camera, radar, or sensor is damaged

Driver assistance system settings

Warning Methods

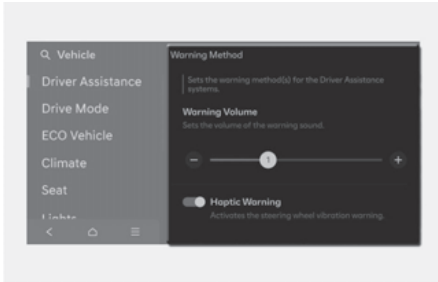

The Warning Methods can be set with the engine on. Select **Setup > Vehicle > Driver Assistance > Warning Method** from the infotainment system to change the following settings:

- **Warning Volume:** Adjusts the volume of the warning sound.
- **Haptic Warning:** Activate the steering wheel vibration warning.
- **Lane Safety Audible Warning Off:** Turns off the Lane Safety Audible Warning, even when both warning volume and haptic warning are on.
- **Driving Safety Priority:** Lowers all other audio volumes when the Driving Safety system sounds a warning.
- **Parking Safety Priority:** Lowers all other audio volumes when the Parking Assist view is active.

CAUTION

For safety, the warning method is different depending on each function of the driver assistance system.

Please check how each function warns you.

Information

- If you change the Warning Methods, it can be applied to each function of the driver assistance system. Please check and change it in each function.
- If the vehicle is restarted, Warning Methods will maintain the last setting.
- The setting menu may not exist based on vehicle specification.
- If you turn off the **Warning Volume**, for your safety, the function may warn you with a low volume, except **Lane Keeping Assist, Blind-Spot Collision-Avoidance Assist and Rear Cross-Traffic Collision-Avoidance Assist**.
- The **Warning Volume** and **Haptic Warning** cannot be turned off at the same time. When one of the warning is turned off the other is activated.
- The **Lane Safety Audible Warning Off** can be set when both the Warning Volume and the Haptic Warning are on.

Forward Collision-Avoidance Assist (FCA)

 if equipped

Basic function

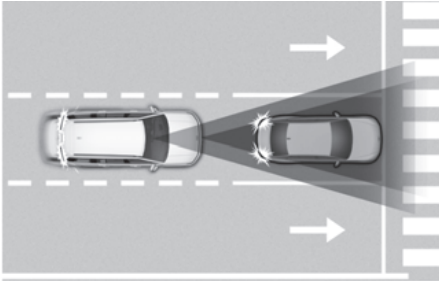

Forward Collision-Avoidance Assist uses the front view camera and front radar to help detect a vehicle, a pedestrian, or a cyclist ahead on the road. The function may warn you with a warning message on the instrument cluster and an audible warning if a collision is imminent. If necessary, it may assist with braking your vehicle to help reduce collision speed and avoid a collision.

In addition, when driving at high speeds, Forward Collision-Avoidance Assist will help detect vehicles in front and adjacent lanes. If a collision is imminent when changing lanes, Forward Collision-Avoidance Assist will apply emergency braking to help reduce collision speed or help avoid a collision. (if equipped)

Junction Turning function

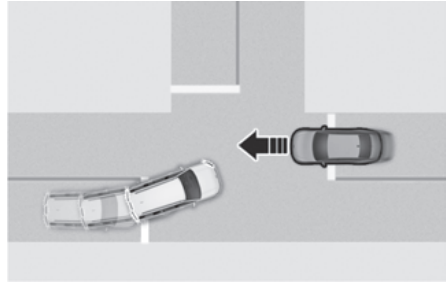

Junction Turning function can help avoid a collision with an oncoming vehicle or powered two-wheeler in an adjacent lane when turning left at a crossroad with the turn signal on by applying emergency braking.

Direct Oncoming function

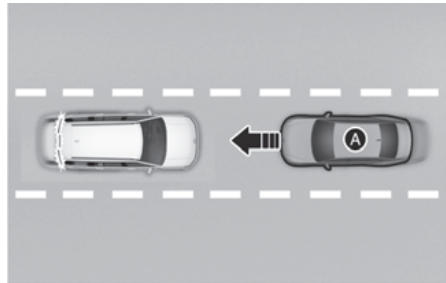

[A] Oncoming vehicle

Direct Oncoming function helps reduce the speed at the collision when a vehicle or powered two-wheeler approaching from the opposite side is detected.

Junction Crossing function

 if equipped

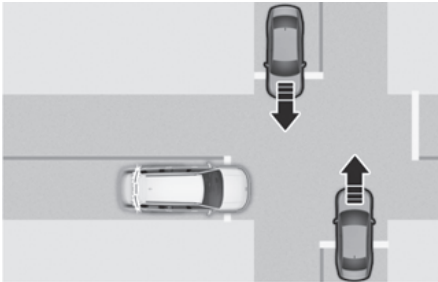

Junction Crossing function can help avoid a collision with oncoming vehicles on the left or right side when crossing an intersection by applying emergency braking.

Lane-Change Oncoming function

 if equipped

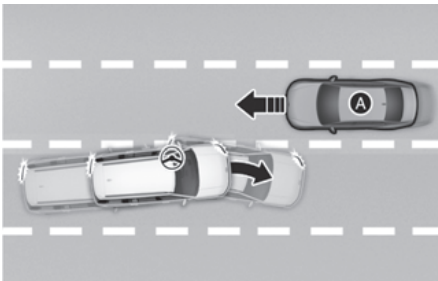

[A] Oncoming vehicle

Lane-Change Oncoming function helps avoid a collision with an oncoming vehicle or powered two-wheeler when changing lanes by assisting the driver's steering.

Lane-Change Side function

 if equipped

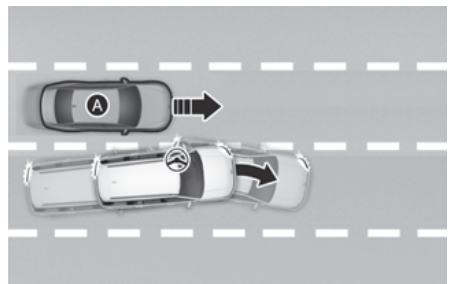
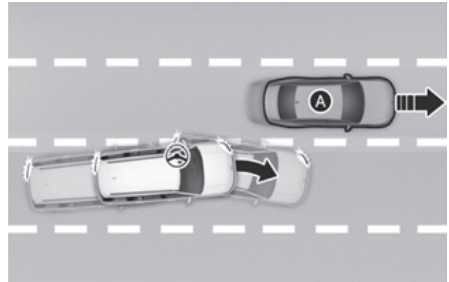

[A] Front-side vehicle

Lane-Change Side function helps avoid a collision with the vehicle or powered two-wheeler ahead in the next lane when changing lanes by assisting the driver's steering.

Evasive Steering Assist function

 if equipped

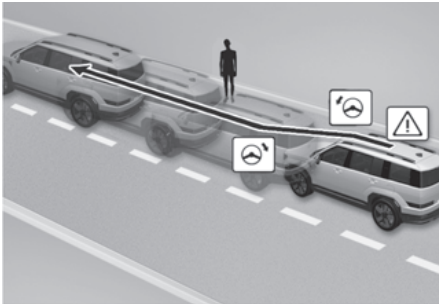

- **Driver steering assist**
Evasive Steering Assist function helps avoid a collision with a vehicle, powered two-wheeler, pedestrian or cyclist ahead in the same lane. When a risk of collision is detected, Evasive Steering Assist function will warn the driver and if the driver steers to avoid collision it will assist the driver's steering.
- **Evasive steering assist**
Evasive Steering Assist function helps avoid a collision with a powered two-wheeler, pedestrian or cyclist ahead in the same lane. When a risk of collision is detected, Evasive Steering Assist function will warn the driver and if there is space to avoid collision in the lane, it will assist the driver's steering.
Evasive Steering Assist function operates when there is a collision risk and sufficient operating area between your vehicle and the detected pedestrian or cyclist ahead.

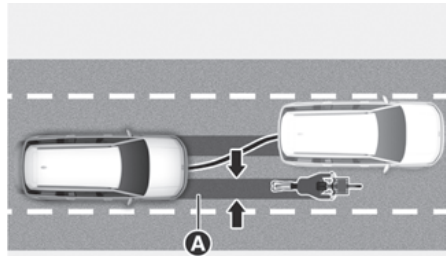

[A] Operating Area of Evasive Steering Assist function

Information

Forward Collision-Avoidance Assist uses the following sensors:

- Front view camera
- Front radar
- Front corner radar (if equipped)
- Rear corner radar

Refer to the "Driver Assistance System Sensors" section in this chapter for the location.

Forward Collision-Avoidance Assist settings

Forward Safety

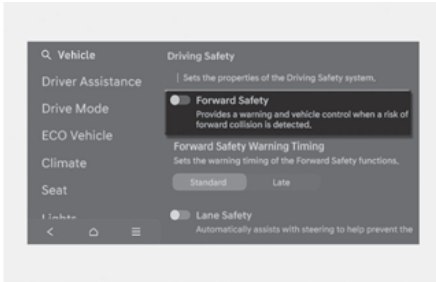

With the engine on, select **Setup > Vehicle > Driver Assistance > Driving Safety** in the infotainment system to set whether to use each function.

- If "**Forward Safety**" is selected, Forward Collision-Avoidance Assist will warn the driver with a warning message, an audible warning depending on the collision risk levels. Braking assist will be applied depending on the collision risk levels. If "**Forward Safety**" is deselected, Forward Safety will turn off. The warning light (警告) will illuminate on the cluster.

CAUTION

- The settings for Forward Safety include 'Basic function', 'Junction Turning', and 'Direct Oncoming'.

Forward Safety Warning Timing

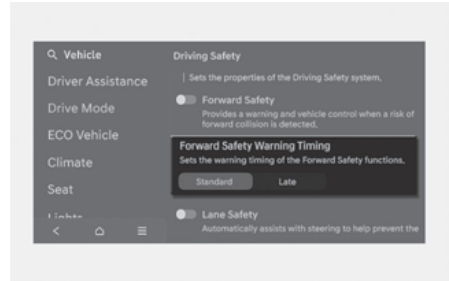

With the Engine Start/Stop button ON, select **Setup > Vehicle > Driver Assistance > Driving Safety > Forward Safety Warning Timing** from the Settings menu to change the initial warning activation time. Warning Timing is set to **Standard** at the factory.

WARNING

- Even though **Standard** is selected for Warning Timing if the vehicle ahead of you suddenly stops, the initial warning activation time may not seem late.
- Select **Late** for Warning Timing when traffic is light and your vehicle speed is slow.

Information

When the engine is restarted, the Warning Timing maintains its last setting.

Forward Cross-Traffic Safety

 if equipped

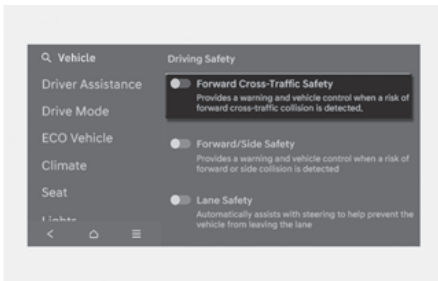

With the engine on, select **Setup > Vehicle > Driver Assistance > Forward Cross-Traffic Safety** in the infotainment system to turn on Junction Crossing function and deselect to turn off the function.

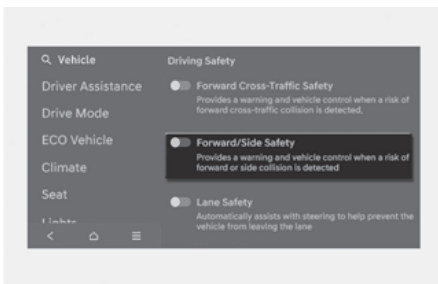

Forward/Side Safety

 if equipped



With the engine on, select **Setup > Vehicle > Driver Assistance > Forward/Side Safety** in the infotainment system to set whether to use each function.

- If "**Forward/Side Safety**" is selected, Forward Collision-Avoidance Assist will warn the driver with a warning message, an audible warning depending on the collision risk levels. Steering assist will be applied depending on the collision risk levels. If "**Forward/Side Safety**" is deselected, Forward Safety will turn off. The warning light () will illuminate on the cluster.

The driver can monitor Forward Collision-Avoidance Assist On/Off status in the infotainment system. If the warning light  or  remains ON when Forward Collision-Avoidance Assist is on, have your vehicle inspected by an authorized HYUNDAI dealer.

WARNING

When the vehicle is restarted, Forward Safety, Forward Cross-Traffic Safety, and Forward/Side Safety will always turn on. Although you can turn off these functions again, please keep in mind you cannot be assisted with the functions when you turned them off. The driver should always be aware of the surroundings and drive safely.

⚠ CAUTION

- The setting for **Forward Safety** include 'Basic function', 'Junction Turning function', and 'Direct Oncoming function' (if equipped).
- The setting for **Forward-Cross Traffic Safety** includes 'Junction Crossing function'.
- The setting for **Forward/Side Safety** includes 'Lane-Change Oncoming function', 'Lane-Change Side function', and 'Evasive Steering Assist function' (if equipped).
- If **Forward Safety** is deselected, Junction Crossing function does not operate even when **Forward-Cross Traffic Safety** and **Forward/Side Safety** are selected (if equipped).

⚠ CAUTION

When the vehicle and the trailer are connected electrically, a warning message appears on the instrument cluster, and Forward/Side Safety function of Forward Collision-Avoidance Assist is deactivated. The function resumes after the trailer connector is disconnected. (When using HYUNDAI genuine parts)

i Information

You can set the following Warning Methods:

- Warning Volume/Haptic Warning/Driving Safety Priority

For more information, refer to the "Driver assistance system settings" section in this chapter.

Forward Collision-Avoidance Assist Operation

Basic function

The basic function for Forward Collision-Avoidance Assist is to warn and help control the vehicle depending on the collision risk level: 'Collision Warning', 'Emergency Braking' and 'Stopping vehicle and ending brake control'.

Collision Warning



- To warn the driver of a collision, Forward Safety warning light (⚠) blinking, the "**Collision Warning**" warning message will appear on the cluster, an audible warning will sound, and the steering wheel will vibrate.
- If a vehicle or powered two-wheeler is detected in front, the function will operate when your vehicle speed is between about 6-124 mph (10-200 km/h).
- If a pedestrian or cyclist is detected in front, the function will operate when your vehicle speed is between about 6-53 mph (10-85 km/h).

Emergency Braking



To warn the driver that emergency braking will be assisted, Forward Safety warning light (⚠️) blinking, the "Emergency Braking" warning message will appear on the cluster, an audible warning will sound, and the steering wheel will vibrate.

Emergency Braking will operate under the following conditions:

- Vehicle or powered two-wheeler:

	Driving Vehicle	Stopped Vehicle
Weak braking power	About 6-124 mph (10-200 km/h)	
Strong braking power	About 6-80 mph (10-130 km/h)	About 6-47 mph (10-75 km/h) About 6-62 mph (10-100 km/h)*1

*1 If Forward Collision-Avoidance Assist judges that avoiding a collision is difficult even by changing the driving lane, braking is assisted more earlier. (if equipped)

- Pedestrian or cyclist:

The function will operate when your vehicle speed is between about 6-40 mph (10-65 km/h).

CAUTION

The function operation range may decrease due to the front traffic condition or the surroundings of the vehicle.

When driving at night, the powered two-wheeler recognition performance is degraded, so Forward Collision-Avoidance Assist may be temporarily limited or may not work.

Stopping vehicle and ending brake control



- When the vehicle is stopped due to emergency braking, the "Drive carefully" warning message will appear on the instrument cluster. For your safety, the driver should depress the brake pedal immediately and check the surroundings.
- Brake control will end after the vehicle is stopped by emergency braking for about 2 seconds.

i Information

Press the hazard warning flasher to turn off the audible warning of the collision warning or emergency braking system.

Junction Turning function

Junction Turning function will warn and help control the vehicle depending on the collision risk level: 'Collision Warning', 'Emergency Braking' and 'Stopping vehicle and ending brake control'

Collision Warning



- To warn the driver of a collision, Forward Safety warning light (🚗) blinking, the "**Collision Warning**" warning message will appear on the cluster, an audible warning will sound, and the steering wheel will vibrate.
- The function will operate when your vehicle speed is between about 6-19 mph (10-30 km/h) and the oncoming vehicle or powered two-wheeler speed is between about 19-44 mph (30-70 km/h).

Emergency Braking

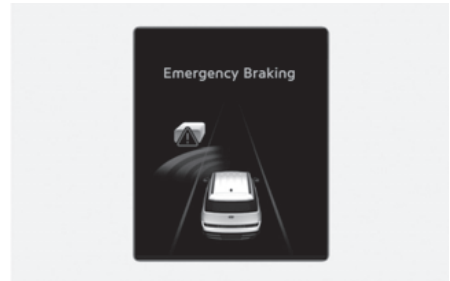

- To warn the driver that emergency braking will be assisted, Forward Safety warning light (🚗) blinking, the "**Emergency Braking**" warning message will appear on the cluster, an audible warning will sound, and the steering wheel will vibrate.
- In emergency braking situation, braking is assisted with strong braking power by the function to help prevent collision with the oncoming vehicle.
- The function will operate when your vehicle speed is between about 6-19 mph (10-30 km/h) and the oncoming vehicle or powered two-wheeler speed is between about 19-44 mph (30-70 km/h).

Stopping vehicle and ending brake control



- When the vehicle is stopped due to emergency braking, the "**Drive carefully**" warning message will appear on the cluster.

For your safety, the driver should depress the brake pedal immediately and check the surroundings.

- Brake control will end after the vehicle is stopped by emergency braking for about 2 seconds.

i Information

Press the hazard warning flasher to turn off the audible warning of the collision warning or emergency braking system.

Direct Oncoming function

Direct Oncoming function will warn and control the vehicle depending on the collision risk level: 'Collision Warning', 'Emergency Braking' and 'Stopping vehicle and ending brake control'.

Collision Warning



- To warn the driver of a collision, Forward Safety warning light (🚦) blinking, the "**Collision Warning**" warning message will appear on the instrument cluster, an audible warning will sound and the steering wheel will vibrate.
- The function will operate when:
 - Your vehicle speed is between about 19-80 mph (30-130 km/h) or 6-80 mph (10-130 km/h) (if equipped)
 - Oncoming vehicle or powered two-wheeler speed is about above 6 mph (10 km/h)

Emergency Braking



- To warn the driver that emergency braking will be assisted, Forward Safety warning light (警告) blinking, the "Emergency Braking" warning message will appear on the instrument cluster, an audible warning will sound and the steering wheel will vibrate.
- In emergency braking situation, braking is assisted with strong braking power by the function to help prevent collision with the oncoming vehicle.
- The function will operate when your vehicle speed is between about 19-80 mph (30-130 km/h) and the detected oncoming vehicle or powered two-wheeler speed is about above 6 mph (10 km/h).

Stopping vehicle and ending brake control



- When the vehicle is stopped due to emergency braking, the "Drive carefully" warning message will appear on the instrument cluster. For your safety, the driver should depress the brake pedal immediately and check the surroundings.
- Brake control will end after the vehicle is stopped by emergency braking for about 2 seconds.

CAUTION

- If your vehicle or the oncoming vehicle or powered two-wheeler is not driving straight, Direct Oncoming function warning and control may be late or may not operate.
- When driving at night, the powered two-wheeler recognition performance is degraded, so Forward Collision-Avoidance Assist may be temporarily limited or may not work.

Information

Press the hazard warning flasher to turn off the audible warning of the collision warning or emergency braking system.

Junction Crossing function

 if equipped

Junction Crossing function will warn and control the vehicle depending on collision risk level: 'Collision Warning', 'Emergency Braking' and 'Stopping vehicle and ending brake control'.

Collision Warning



- To warn the driver of a collision, Forward Safety warning light (🚨) blinking, the **"Collision Warning"** warning message will appear on the instrument cluster, an audible warning will sound and the steering wheel will vibrate.
- The function will operate when your vehicle speed is between about 6-34 mph (10-55 km/h) and the crossing vehicle speed is between about 6-37 mph (10-60 km/h).

Emergency Braking



- To warn the driver that emergency braking will be assisted, Forward Safety warning light (🚨) blinking, the **"Emergency Braking"** warning message will appear on the instrument cluster, an audible warning will sound and the steering wheel will vibrate.
- In emergency braking situation, braking is assisted with strong braking power by the function to help prevent collision with the crossing vehicle.
- The function will operate when your vehicle speed is between about 6-34 mph (10-55 km/h) and the crossing vehicle speed is between about 6-25 mph (10-40 km/h).

Stopping vehicle and ending brake control



- When the vehicle is stopped due to emergency braking, the "**Drive carefully**" warning message will appear on the instrument cluster.

For your safety, the driver should depress the brake pedal immediately and check the surroundings.

- Brake control will end after the vehicle is stopped by emergency braking for about 2 seconds.

CAUTION

If the collision angle with the crossing vehicle is beyond a certain range, Junction Crossing function warning and control may be late or may not operate.

Information

Press the hazard warning flasher to turn off the audible warning of the collision warning or emergency braking system.

Lane-Change Oncoming function

 if equipped

Lane-Change Oncoming function will warn and control the vehicle depending on collision risk level: 'Collision Warning' and 'Emergency Steering'.

Collision Warning



- To warn the driver of a collision, Emergency Steering warning light () blinking, the "**Collision Warning**" warning message will appear on the instrument cluster, an audible warning will sound and the steering wheel will vibrate.
- The function will operate when your vehicle speed is between about 25-90 mph (40-145 km/h) and the oncoming vehicle or powered two-wheeler speed is about above 6 mph (10 km/h) and the relative speed with your vehicle is about below 124 mph (200 km/h).

Emergency Steering



- To warn the driver that emergency steering will be assisted, Emergency Steering warning light (🚗) blinking, the "**Emergency Steering**" warning message will appear on the instrument cluster, an audible warning will sound and the steering wheel will vibrate.
- In emergency steering situation, steering is assisted by the function to help prevent collision with the oncoming vehicle.
- The function will operate when your vehicle speed is between about 25-90 mph (40-145 km/h) and the oncoming vehicle or powered two-wheeler speed is about above 6 mph (10 km/h) and the relative speed with your vehicle is about below 124 mph (200 km/h).

Lane-Change Side function

⊕ if equipped

Lane-Change Side function will warn and control the vehicle depending on collision risk level: 'Collision Warning' and 'Emergency Steering'

Collision Warning



- To warn the driver of a collision, Emergency Steering warning light (🚗) blinking, the "**Collision Warning**" warning message will appear on the instrument cluster, an audible warning will sound and the steering wheel will vibrate.
- The function will operate when your vehicle speed is between about 25-90 mph (40-145 km/h).

Emergency Steering

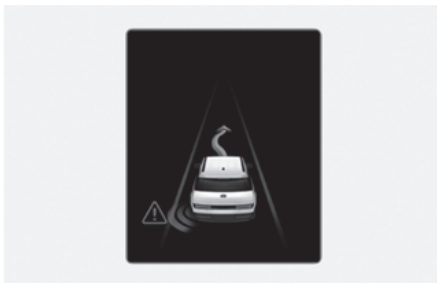

- To warn the driver that emergency steering will be assisted, Emergency Steering warning light (🚨) blinking, the "Emergency Steering" warning message will appear on the instrument cluster, an audible warning will sound and the steering wheel will vibrate.
- In emergency steering situation, steering is assisted by the function to help prevent collision with the front-side vehicle.
- The function will operate when your vehicle speed is between about 25-90 mph (40-145 km/h) and front-side vehicle and powered two-wheeler is driving.

⚠ CAUTION

- Lane-Change Side function does not operate if the vehicle speed of the preceding vehicle or powered two-wheeler from the front side is 0 mph (0 km/h).
- The detecting range of the front corner radar and the rear corner radar is determined by a standard road width, therefore, on a narrow road, Lane-Change Side function may detect other vehicles two lanes over and warn you. In contrast, on a wide road, Lane-Change Side function may not be able to detect a vehicle driving in the next lane and may not warn you.
- Lane-Change Side function will be canceled under the following circumstances:
 - Your vehicle enters the next lane by a certain distance.
 - Your vehicle is away from the collision risk.
 - The steering wheel is sharply steered.
 - The brake pedal is depressed.
 - Forward Collision-avoidance assist is operating.
- After Lane-Change Side function operation or lane change, you must drive to the center of the lane. Lane-Change Side function will not operate if the vehicle is not driven in the center of the lane.

i Information

When an additional collision is expected, Lane-Change Side function will not assist with steering and only warn the driver of a collision.

Evasive Steering Assist function

 If equipped

Evasive Steering Assist function will warn and control the vehicle with 'Emergency steering'.

Emergency Steering (Driver steering assist)



- To warn the driver that emergency steering will be assisted, Emergency Steering warning light (🚨) blinking, the "**Emergency Steering**" message will appear on the instrument cluster, an audible warning will sound and the steering wheel will vibrate.
- If there is a risk of collision with a vehicle, powered two-wheeler, pedestrian and cyclist in front, the steering will be assisted to help prevent collision when the driver steers the vehicle to avoid collision.
- The function will operate when your vehicle speed is between about 25-53 mph (40-85 km/h).

Emergency Steering (Evasive steering assist)



- To warn the driver that emergency steering will be assisted, Emergency Steering warning light (🚨) blinking, the "**Emergency Steering**" message will appear on the instrument cluster, an audible warning will sound and the steering wheel will vibrate.
- If there is a high risk of collision with a pedestrian, cyclist or powered two-wheeler in front, and the vehicle speed to operate emergency braking is within the operation range, the steering will be assisted to help prevent collision when there is space to avoid collision in the driving lane.
- The function will operate when your vehicle speed is between about 40-47 mph (65-75 km/h).
- The pedestrian or cyclist moves in the same direction as your vehicle, or in the opposite direction. In addition, there is sufficient space for an evasive movement for your vehicle. However, this function may not operate for pedestrians or cyclists moving in the horizontal direction.

CAUTION

- The steering wheel may turn automatically when emergency steering is operating.
- Emergency steering will automatically cancel when risk factors disappear. If necessary, the driver must steer the vehicle.
- Emergency steering may not operate or may cancel during operation if the steering wheel is held tight or steered in the opposite direction.
- When steering is assisted to avoid collision with a vehicle, powered two-wheeler, pedestrian and cyclist, Evasive steering assist will be cancelled if collisions with other objects (vehicles, powered two-wheeler, pedestrians, or cyclists) are expected.
- Emergency steering will be canceled if space to avoid collision in the driving lane is insufficient.
- When driving at night, the detecting performance of powered two-wheeler may decrease and temporarily limit or disable Front Collision-Avoidance Assist.

Information

For more information on warning messages, refer to Collision Warning in "Forward Collision-Avoidance Assist Operation" section in this chapter.

WARNING

- For your safety, only change the Settings after parking the vehicle at a safe location.
- Forward Collision-Avoidance Assist does not operate in all situations and cannot avoid all collisions.
- The driver has the responsibility to control the vehicle. Do not solely depend on Forward Collision-Avoidance Assist. Rather, maintain a safe braking distance, and if necessary, depress the brake pedal to reduce driving speed or to stop the vehicle.
- Never deliberately operate Forward Collision-Avoidance Assist on people, objects, etc. It may cause serious injury or death.
- Forward Collision-Avoidance Assist may not operate if the driver depresses the brake pedal to avoid collision.
- During Forward Collision-Avoidance Assist operation, the vehicle may stop suddenly injuring passengers and shifting loose objects. Always have the seat belt on and keep loose objects secured.
- If any other system's warning message appears or audible warning is generated, Forward Collision-Avoidance Assist warning message may not be displayed and audible warning may not be generated.
- You may not hear the warning sound of Forward Collision-Avoidance Assist if the surrounding is noisy.
- Forward Collision-Avoidance Assist may turn off or may not operate properly or may operate unnecessarily depending on the road conditions and the surroundings.
- Even if there is a problem with Forward Collision-Avoidance Assist, the vehicle's basic braking performance will operate properly.

- During emergency braking, braking control by Forward Collision-Avoidance Assist will automatically cancel when the driver excessively depresses the accelerator pedal or sharply steers the vehicle.
-

CAUTION

- Depending on the condition of the vehicle, powered two-wheeler, pedestrian, or cyclist in front and the surroundings, the speed range to operate Forward Collision-Avoidance Assist may reduce. Forward Collision-Avoidance Assist may only warn the driver, or it may not operate.
 - Forward Collision-Avoidance Assist will operate under certain conditions by judging the risk level based on the condition of the oncoming vehicle, driving direction, speed and surroundings.
 - Only Forward Collision-Avoidance Assist warning and collision mitigation are possible depending on the detectable distance.
-



Information

- In a situation where collision is imminent, braking may be assisted by Forward Collision-Avoidance Assist when braking is insufficient by the driver.
 - The images and colors in the instrument cluster may differ depending on the instrument cluster type or theme selected from the settings menu.
-

Forward Collision-Avoidance Assist Malfunction and Limitations

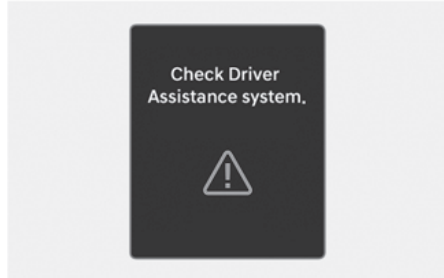
Forward Collision-Avoidance Assist malfunction



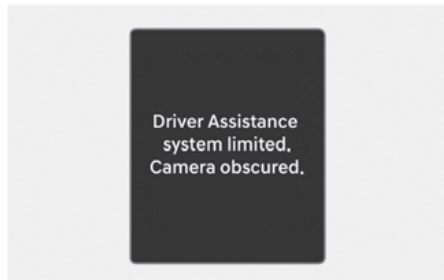

When Forward Collision-Avoidance Assist is not working properly, the **Check Driver Assistance system.** warning message will appear, and the , , or  warning lights will illuminate on the instrument cluster. Have your vehicle inspected by an authorized HYUNDAI dealer.

Forward Collision-Avoidance Assist disabled

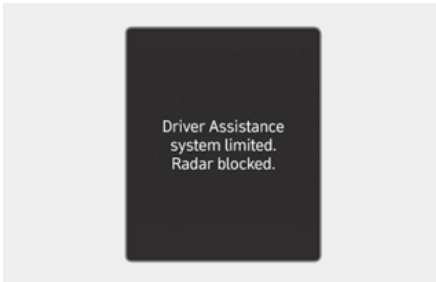



When the front windshield where the front view camera is located, front radar cover, bumper (if equipped) or sensor is covered with foreign material, such as snow or rain, it can reduce the detecting performance and temporarily limit or disable Forward Collision-Avoidance Assist.

If this occurs the **"Driver Assistance system limited. Camera obscured."** or the **"Driver Assistance system limited. Radar blocked."** warning message, and the , , or the  warning lights will illuminate on the instrument cluster.

Forward Collision-Avoidance Assist will operate properly when snow, rain or foreign material is removed.

If Forward Collision-Avoidance Assist does not operate properly after obstruction (snow, rain, or foreign material) is removed (including trailer, carrier, etc., from the rear bumper), have your vehicle inspected by an authorized HYUNDAI dealer.

WARNING

- Even though the warning message or warning light does not appear on the instrument cluster, Forward Collision-Avoidance Assist may not properly operate.
- Forward Collision-Avoidance Assist may not properly operate in an area (for example, open terrain), where any objects are not detected after turning ON the vehicle.

Limitations of Forward Collision-Avoidance Assist

Forward Collision-Avoidance Assist may not operate properly, or it may operate unexpectedly under the following circumstances:

- The detecting sensor or the surroundings are contaminated or damaged
- The temperature around the front view camera is high or low due to surrounding environment
- The camera lens is contaminated due to tinted, filmed or coated windshield, damaged glass, or sticky foreign material (sticker, bug, etc.) on the glass

- Moisture is not removed or frozen on the windshield
- Washer fluid is continuously sprayed, or the wiper is on
- Driving in heavy rain or snow, or thick fog
- The field of view of the front view camera is obstructed by sun glare
- Street light or light from an oncoming traffic is reflected on the wet road surface, such as a puddle on the road
- An object is placed on the dashboard
- Your vehicle is being towed
- The surrounding is very bright
- The surrounding is very dark, such as in a tunnel, etc.
- The brightness changes suddenly, for example when entering or exiting a tunnel
- The brightness outside is low, and the headlights are not on or are dim
- Driving through steam, smoke or shadow
- Only part of the vehicle, powered two-wheeler, pedestrian or cyclist is detected
- The vehicle or powered two-wheeler in front is a bus, heavy truck, truck with an unusually shaped cargo, trailer, etc.
- The vehicle or powered two-wheeler in front has no tail lights, tail lights are located unusually, etc.
- The brightness outside is low, and the tail lights are not on or are dim
- The rear of the front vehicle is small or the vehicle does not look normal, such as when the vehicle is tilted, overturned, or the side of the vehicle is visible, etc.
- The front vehicle's ground clearance is low or high
- A vehicle, powered two-wheeler, pedestrian or cyclist suddenly cuts in front
- The bumper around the front radar is impacted, damaged or the front radar is out of position
- The temperature around the front radar is high or low
- Driving through a tunnel or iron bridge
- Driving in vast areas where there are few vehicles or structures (for example, desert, meadow, suburb, etc.)
- Driving near areas containing metal substances, such as a construction zone, railroad, etc.
- A material is near that reflects very well on the front radar, such as a guardrail, nearby vehicle, etc.
- The cyclist in front is on a bicycle made of material that does not reflect on the front radar
- The vehicle or powered two-wheeler in front is detected late
- The vehicle or powered two-wheeler in front is suddenly blocked by an obstacle
- The vehicle or powered two-wheeler in front suddenly changes lane or suddenly reduces speed
- The vehicle or powered two-wheeler in front is bent out of shape
- The vehicle in front is covered with snow
- You are departing or returning to the lane
- Unstable driving

- You are on a roundabout and the vehicle or powered two-wheeler in front is not detected
- You are continuously driving in a circle
- The vehicle in front has an unusual shape
- The vehicle in front is driving uphill or downhill
- The pedestrian or cyclist is not fully detected, for example, if the pedestrian is leaning over or is not fully walking upright
- The pedestrian or cyclist is wearing clothing or equipment that makes it difficult to detect



The illustration above shows the image the front view camera and front radar are capable of detecting as a vehicle, pedestrian and cyclist.

- The pedestrian or cyclist in front is moving very quickly
 - The pedestrian or cyclist in front is short or is posing a low posture
 - The pedestrian or cyclist in front has impaired mobility
 - The pedestrian or cyclist in front is moving intersected with the driving direction
 - There is a group of pedestrians, cyclists or a large crowd in front
 - The pedestrian or cyclist is wearing clothing that easily blends into the background, making it difficult to detect
- The pedestrian or cyclist is difficult to distinguish from the similarly shaped structure in the surroundings
 - You are driving by a pedestrian, cyclist, traffic signs, structures, etc., near the intersection
 - Driving in a parking lot
 - Driving through a tollbooth, construction area, unpaved road, partial paved road, uneven road, speed bumps, etc.
 - Driving on an incline road, curved road, etc.
 - Driving through a roadside with trees or streetlights
 - The adverse road conditions cause excessive vehicle vibrations while driving
 - Your vehicle height is low or high due to heavy loads, abnormal tire pressure, etc.
 - Driving through a narrow road where trees or grass are overgrown
 - There is interference by electromagnetic waves, such as driving in an area with strong radio waves or electrical noise

Junction Crossing, Lane-Change Oncoming, Lane-Change Side, Evasive Steering Assist function

 If equipped

- The temperature around the front corner radar or rear corner radar is high or low
- A trailer or carrier is installed around the rear corner radar
- The front corner radar or rear corner radar is covered with snow, rain, dirt, etc.
- The bumper around the front corner radar or rear corner radar is covered with objects, such as a bumper sticker, bumper guard, bike rack, etc.
- The bumper around the front corner radar or rear corner radar is impacted, damaged or the radar is out of position
- The front corner radar or rear corner radar is blocked by other vehicles, walls or pillars
- Driving on a highway (or motorway) ramp or driving through a tollgate
- Driving on a road where the guardrail or wall is in double structure
- The other vehicle drives very close behind your vehicle, or the other vehicle passes by your vehicle in close proximity
- The speed of the other vehicle is very fast that it passes by your vehicle in a short time
- Your vehicle passes by the other vehicle
- Your vehicle has started at the same time as the vehicle next to you and has accelerated
- The vehicle in the next lane moves two lanes away from you, or when the vehicle two lanes away moves to the next lane from you
- A motorcycle or bicycle is detected
- A vehicle such as a flat trailer is detected
- A big vehicle such as a bus or truck is detected
- A small moving obstacle such as a pedestrian, animal, shopping cart or a baby stroller is detected
- A vehicle with low height such as a sports car is detected
- The lane is difficult to see due to foreign material, such as rain, snow, dust, sand, oil and water puddles
- The color of the lane marking is not distinguishable from the road
- There are markings on the road near the lane or the markings on the road looks similar to the lane markings
- The shadow is on the lane marking by a median strip, trees, guardrail, noise barriers, etc.
- The lane number increases or decreases, or the lane markings are crossing
- There are more than two lane markings on the road
- The lane markings are complicated or a structure substitutes for the lines, such as a construction area
- There are road markings, such as zigzag lanes, crosswalk markings and road signs
- The lane suddenly disappears, such as at the intersection
- The lane is very wide or narrow
- There is a curb or road edges without a lane
- The vehicle in front is driving with one side on the lane marking
- The distance to the front vehicle is extremely short

Limitations of Evasive Steering Assist

Evasive Steering Assist function may not work properly in the following situations when:

- The pedestrians or cyclists are positioned outside of the operating area.

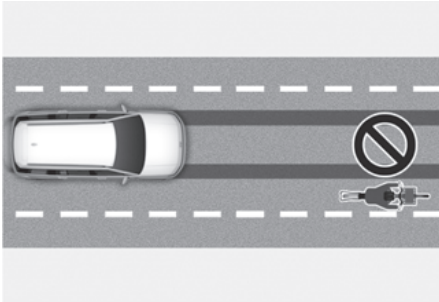

- The pedestrians or cyclists are moving laterally.

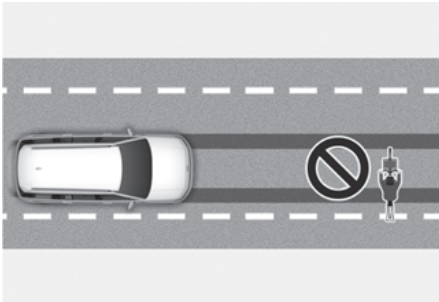

- The pedestrians or cyclists are positioned inside of the operating area, but there is not enough space available for evasive steering.

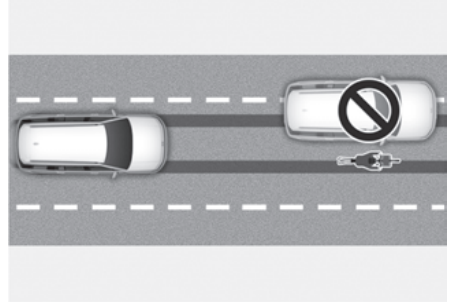

⚠ WARNING

• **Driving on a curved road**

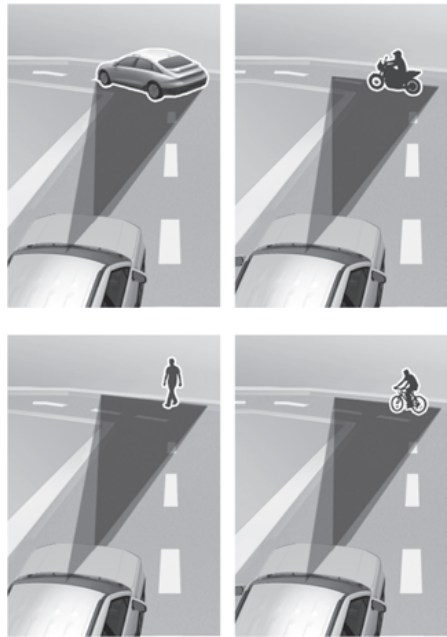
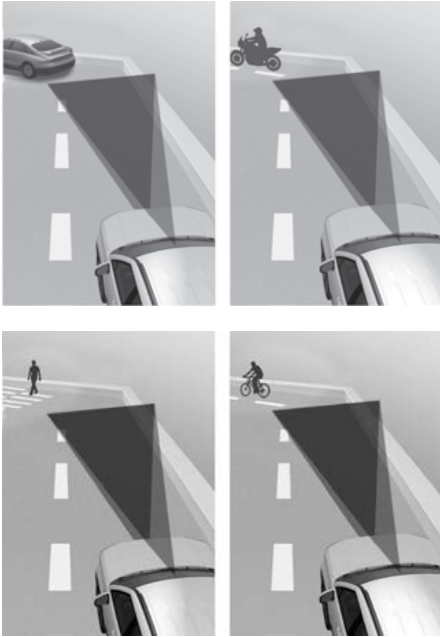

Forward Collision-Avoidance Assist may not detect other vehicles, powered two-wheelers, pedestrians or cyclists in front of you when driving on curved roads adversely affecting the performance of the sensors. This may result in no warning, braking assist or steering assist (if equipped) when necessary.

When driving on a curve, you must maintain a safe braking distance, and if necessary, depress the brake pedal to reduce your driving speed in order to maintain a safe distance.

Forward Collision-Avoidance Assist may detect a vehicle, powered two-wheeler, pedestrian or cyclist in the next lane or outside the lane when driving on a curved road.

If this occurs, Forward Collision-Avoidance Assist may unnecessarily warn the driver and control the brake or steering (if equipped). Always check the traffic conditions around the vehicle.

- Driving on an inclined road

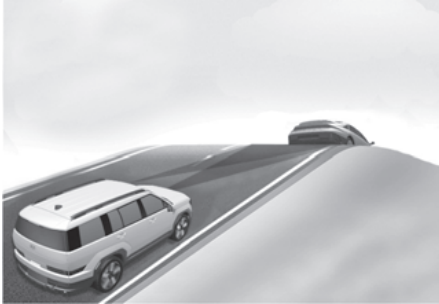

Forward Collision-Avoidance Assist may not detect other vehicles, powered two-wheelers, pedestrians or cyclists in front of you while driving uphill or downhill, adversely affecting the performance of the sensors.

This may result in unnecessary warning, braking assist or steering assist (if equipped) or no warning, braking assist or steering assist (if equipped) when necessary.

Also, vehicle speed may rapidly decrease when a vehicle, powered two-wheeler, pedestrian or cyclist ahead is suddenly detected.

Always have your eyes on the road while driving uphill or downhill and if necessary, steer your vehicle and depress the brake pedal to reduce your driving speed in order to maintain a safe distance.

• Changing lanes



[A] Your vehicle
[B] Lane changing vehicle

When a vehicle or powered two-wheeler moves into your lane from an adjacent lane, it cannot be detected by the sensor until it is in the sensor's detection range. Forward Collision-Avoidance Assist may not immediately detect the vehicle or powered two-wheeler when the vehicle or powered two-wheeler changes lanes abruptly. In this case, you must maintain a safe braking distance, and if necessary, steer your vehicle and depress the brake pedal to reduce your driving speed in order to maintain a safe distance.

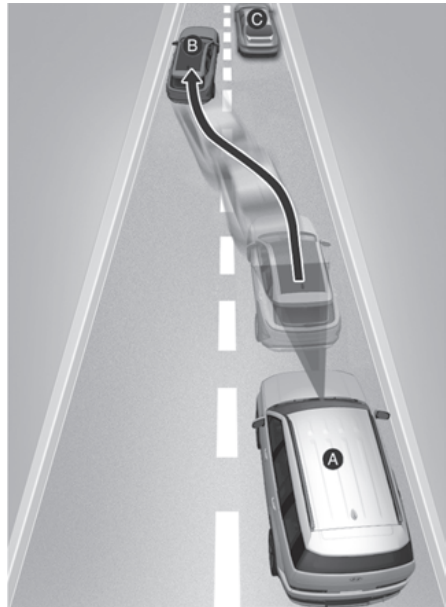

[A] Your vehicle
[B] Lane changing vehicle
[C] Same lane vehicle

When a vehicle in front of you merges out of the lane, Forward Collision-Avoidance Assist may not immediately detect the vehicle or powered two-wheeler that is now in front of you. In this case, you must maintain a safe braking distance, and if necessary, steer your vehicle and depress the brake pedal to reduce your driving speed in order to maintain a safe distance.

- **Detecting vehicle**

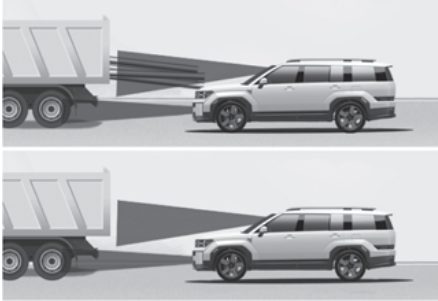

If the vehicle in front of you has cargo that extends rearward from the cab, or when the vehicle in front of you has higher ground clearance, additional special attention is required. Forward Collision-Avoidance Assist may not be able to detect the cargo extending from the vehicle. In these instances, you must maintain a safe braking distance from the rearmost object, and if necessary, steer your vehicle and depress the brake pedal to reduce your driving speed in order to maintain distance.

WARNING

- When you are towing a trailer or another vehicle, turn off Forward Collision-Avoidance Assist for safety reasons.
- Forward Collision-Avoidance Assist may operate if objects that are similar in shape or characteristics to vehicles, powered two-wheelers, pedestrians and cyclists are detected.
- Forward Collision-Avoidance Assist does not operate on bicycles, or smaller wheeled objects, such as luggage bags, shopping carts, or strollers.
- Forward Collision-Avoidance Assist may not operate properly if interfered by strong electromagnetic waves.
- Forward Collision-Avoidance Assist may not operate for 15 seconds after the vehicle is started, or the front view camera is initialized.

i **Information**

For limitations in the driver's blind spot areas and precautions for the rear corner radars, refer to the "Blind-Spot Collision-Avoidance Assist (BCA)" section in this chapter.

Lane Keeping Assist (LKA)

Lane Keeping Assist uses the front view camera to help detect lane markings (or road edges) while driving over a certain speed. Lane Keeping Assist may warn you if your vehicle leaves the lane without using the turn signal and may steer the vehicle to help prevent it from departing its travel lane.

WARNING

Always monitor your vehicle speed and the distance to vehicles ahead on the road. Lane Keeping Assist is not a substitute for safe driving practices, but a supplemental function only.

Information

Lane Keeping Assist uses the following sensor:

- Front view camera

Refer to the "Driver Assistance System Sensors" section in this chapter for the location.

Lane Keeping Assist settings

Lane Safety

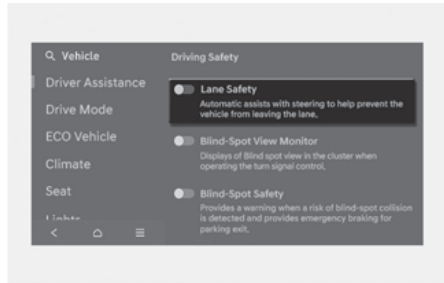

With the engine on, select **Setup** > **Vehicle** > **Driver Assistance** > **Driving Safety** > **Lane Safety** in the infotainment system to set whether to use each function.

If **Lane Safety** is selected, Lane Keeping Assist automatically assists the driver's steering when lane departure is detected to help prevent the vehicle from moving out of its lane. If **Lane Safety** is deselected, Lane Keeping Assist turns off.

WARNING

- Lane Keeping Assist does not control the steering wheel when the vehicle is driven in the middle of the lane.
- The driver should always be aware of the surroundings. If **Lane Safety** is deselected, Lane Keeping Assist cannot assist you.

CAUTION

When the vehicle and the trailer are connected electrically, a warning message appears on the instrument cluster, and Lane Keeping Assist is deactivated. The function resumes after the trailer connector is disconnected. (When using HYUNDAI genuine parts)

i Information

You can set the following Warning Methods:

- Warning Volume/Haptic Warning/Lane Safety Audible Warning Off/Driving Safety Priority

For more information, refer to the "Driver assistance system settings" section in this chapter.

Lane Keeping Assist Operation

Turning Lane Keeping Assist On/Off

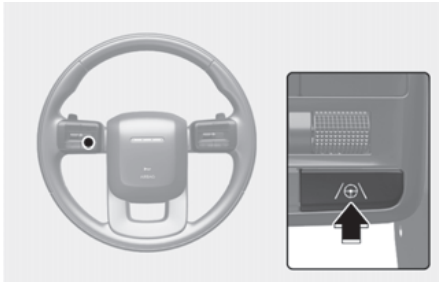

- With the engine on, press and hold the Lane Driving Assist button (\oplus) located on the steering wheel to turn on Lane Keeping Assist. The (\oplus) indicator light illuminates on the instrument cluster.

i Information

When the Lane Driving Assist button is pressed and held, the Lane Safety setting turns off and the (\oplus) indicator light turns off on the instrument cluster.

Warning and control

Lane Keeping Assist will warn and control the vehicle with Lane Departure Warning and Lane Keeping Assist.

Left



Right



Lane Departure Warning

- To warn the driver that the vehicle is departing from the projected lane in front, the green (\oplus) indicator light blinks on the instrument cluster, the lane line blinks on the instrument cluster depending on which direction the vehicle is veering, an audible warning sounds, and the steering wheel vibrates.
- Lane Keeping Assist operates when your vehicle speed is between about 40-120 mph (60-200 km/h).

Lane Keeping Assist

- To warn the driver that the vehicle is departing from the projected lane in front, the green () indicator light blinks on the cluster, and the steering wheel makes adjustments to keep vehicle inside the lane.
- Lane Keeping Assist operates when your vehicle speed is between about 40-120 mph (60-200 km/h).

Hands-off warning

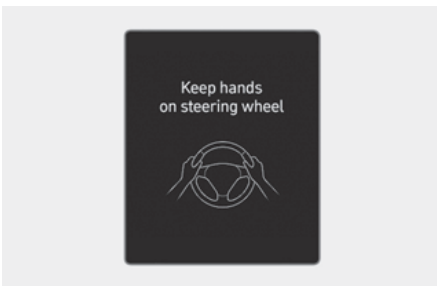

If the driver takes their hands off the steering wheel for several seconds, the "Keep hands on steering wheel" warning message appears on the instrument cluster, and an audible warning sounds in stages.

WARNING

- The steering wheel may not be assisted if the steering wheel is held very tight or the steering wheel is steered over a certain degree.
- Lane Keeping Assist does not operate at all times. It is the responsibility of the driver to safely steer the vehicle and to maintain the vehicle in its lane.
- The hands-off warning message may appear late depending on road conditions. Always have your hands on the steering wheel while driving.
- If the steering wheel is held very lightly, the hands-off warning message may appear because Lane Keeping Assist may not recognize that the driver has their hands on the steering wheel.
- If you attach objects to the steering wheel, the hands-off warning may not work properly.

Information

- You can steer your vehicle even when steering is assisted by Lane Keeping Assist.
- It may require more or less force to turn the steering wheel when Lane Keeping Assist is providing steering assistance.

Lane undetected



Lane detected



- When lane markings (or road edges) are detected, the lane lines on the instrument cluster changes from grey to white.
- When the lane markings (or road edges) are detected and Highway Lane Change Assist is on, the lane lines on the cluster may change to green. (if equipped)
- The images and colors in the instrument cluster may differ depending on the instrument cluster type or theme selected from the instrument cluster.
- For more information on instrument cluster settings, refer to the "Cluster display control" section in chapter 4.

Lane Keeping Assist Malfunction and Limitations

Lane Keeping Assist malfunction

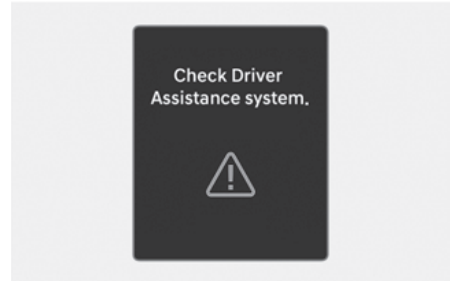

When Lane Keeping Assist is not working properly, the "**Check Driver Assistance system.**" warning message appears, the master (⚠) warning light and the yellow Lane Safety (LKA) indicator light illuminates on the instrument cluster. If this occurs, have your vehicle inspected by an authorized HYUNDAI dealer.

Lane Keeping Assist disabled

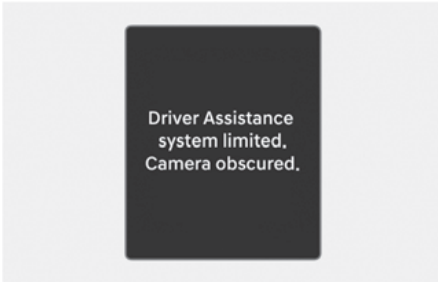

When the front windshield where the front view camera is located, or sensor is covered with foreign material, such as snow or rain, it can reduce the detecting performance and temporarily limit or disable Lane Keeping Assist.

If this occurs, the "**Driver Assistance system limited. Camera obscured.**" warning message and master (⚠) light or Lane Safety (🚧) warning light appears on the instrument cluster.

Lane Keeping Assist operates properly when snow, rain or foreign material is removed.

If Lane Keeping Assist does not operate properly after it is removed, have your vehicle inspected by an authorized HYUNDAI dealer.

WARNING

Even though the warning message or warning light does not appear on the instrument cluster, Lane Keeping Assist may not properly operate.

Limitations of Lane Keeping Assist

Lane Keeping Assist may not operate properly or may operate unexpectedly under the following circumstances:

- The lane is contaminated or difficult to detect because:
 - The lane markings (or road edge) are covered with rain, snow, dirt, oil, etc.
 - The color of the lane marking (or road edge) is not distinguishable from the road
 - There are markings (or road edges) on the road near the lane or the markings (or road edges) on the road look similar to the lane markings (or road edge)
 - The lane marking (or road edge) is indistinct or damaged
 - The shadow is on the lane marking (or road edge) by a median strip, trees, guardrail, noise barriers, etc.
- The lane number increases or decreases, or the lane markings (or road edges) are crossing
- There are more than two lane markings (or road edges) on the road
- The lane markings (or road edges) are complicated or a structure substitutes for the lines, such as a construction area
- There are road markings, such as zigzag lanes, crosswalk markings and road signs

- The lane suddenly disappears, such as at the intersection
- The lane (or road width) is very wide or narrow
- There is a road edge without a lane
- There is a boundary structure in the roadway, such as a tollbooth, sidewalk, curb, etc.
- The distance to the front vehicle is extremely short or the vehicle in front is covering the lane marking (or road edge)
- If any other system's warning message appears or audible warning is generated, Lane Keeping Assist warning message may not be displayed and audible warning may not be generated.
- You may not hear the warning sound of Lane Keeping Assist if the surrounding is noisy.
- If you attach objects to the steering wheel, steering may not be assisted properly.
- Lane Keeping Assist may not operate for 15 seconds after the vehicle is started, or the front view camera is initialized.
- Lane Keeping Assist will not operate when:
 - The turn signal or hazard warning flasher is turned on.
 - The vehicle is not driven in the center of the lane when Lane Keeping Assist is turned on or right after changing a lane.
 - ESC (Electronic Stability Control) or VSM (Vehicle Stability Management) is activated.
 - The vehicle is driven on a sharp curve.
 - Vehicle speed is below 35 mph (55 km/h) or above 130 mph (210 km/h).
 - The vehicle makes sudden lane changes.
 - The vehicle brakes suddenly.

Information

For more information on the limitations of the front view camera, refer to the "Forward Collision-Avoidance Assist (FCA)" section in this chapter.

WARNING

Take the following precautions when using Lane Keeping Assist:

- The driver has the responsibility to safely drive and control the vehicle. Do not solely rely on Lane Keeping Assist.
- The operation of Lane Keeping Assist can be cancelled or not work properly depending on road conditions and surroundings. Always be cautious while driving.
- Refer to the "Limitations of Lane Keeping Assist" if the lane is not detected properly.
- When you are towing a trailer or another vehicle, turn off Lane Keeping Assist for safety reasons.
- If the vehicle is driven at high speed, the steering wheel will not be controlled. The driver must always follow the speed limit when using Lane Keeping Assist.
- Driving stability may decrease when the vehicle is overloaded or the weight distribution is uneven. This may degrade the Lane Keeping Assist performance.

Blind-Spot Collision-Avoidance Assist (BCA)

 if equipped

Blind-Spot Collision-Avoidance Assist detects approaching vehicles in the driver's blind spot areas and warn you of a possible collision with a warning light and a warning sound.

If there is a collision risk when exiting a parallel space, Blind-Spot Collision-Avoidance Assist may assist with braking your vehicle to help avoid a collision.

Blind-Spot Collision-Avoidance Assist helps detect and informs the driver that a vehicle is in the blind spot.

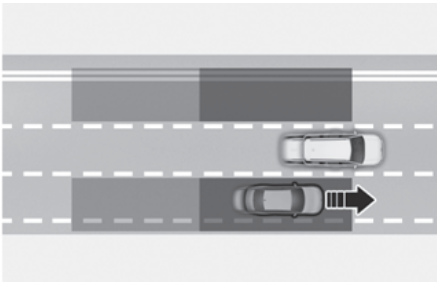

CAUTION

The detecting range may vary depending on the speed of your vehicle. Even if there is a vehicle in the blind spot area, Blind-Spot Collision-Avoidance Assist may not warn you when you pass by at high speeds.

Blind-Spot Collision-Avoidance Assist helps detect and informs the driver that a vehicle is approaching at high speed from the blind spot area.

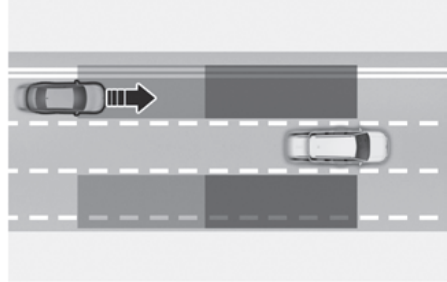

CAUTION

Warning timing may vary depending on the speed of the vehicle approaching at high speed.

When you are driving forward out of a parking space, if Blind-Spot Collision-Avoidance Assist judges that there is a collision risk with an approaching vehicle in the blind spot, it can help avoid collision by applying the brake.

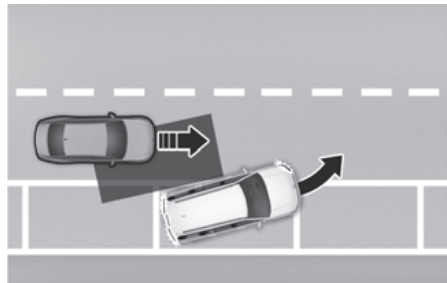

i Information

Blind-Spot Collision-Avoidance Assist uses the following sensor:

- Rear corner radars

Refer to the "Driver Assistance System Sensors" section in this chapter for the location.

Blind-Spot Collision-Avoidance Assist settings

Blind-Spot Safety

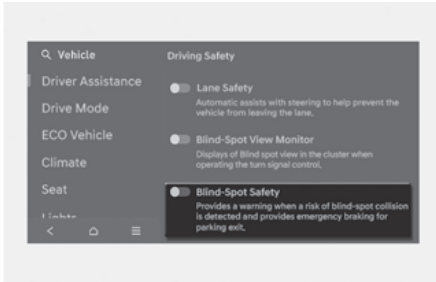

With the engine on, select **Setup > Vehicle > Driver Assistance > Driving Safety > Blind-Spot Safety** in the infotainment system to set whether to use each function.

- If **Blind-Spot Safety** is selected, Blind-Spot Collision Avoidance Assist warns the driver with a warning message, an audible warning depending on the collision risk levels. Braking assist is applied for parking exit depending on the collision risk levels.

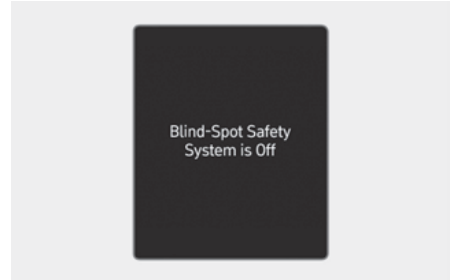

When the vehicle is restarted with Blind-Spot Collision-Avoidance Assist off, the **"Blind-Spot Safety System is Off"** message will appear on the instrument cluster.

If you select **"Blind-Spot Safety"**, warning light on the side view mirror will blink for three seconds. In addition, if the vehicle is turned on, when **"Blind-Spot Safety"** is selected, the warning light on the side view mirror blinks for three seconds.

WARNING

The driver should always be aware of the surroundings and drive safely. If **"Blind-Spot Safety"** is deselected, Blind-Spot Collision-Avoidance Assist cannot assist you.

i Information

If the vehicle is restarted, Blind-Spot Collision-Avoidance Assist maintains the last setting.

CAUTION

When the vehicle and the trailer are connected electrically, a warning message appears on the instrument cluster, and Lane Keeping Assist is deactivated. The function resumes after the trailer connector is disconnected. (When using HYUNDAI genuine parts)

Information

You can set the following Warning Methods:

- Warning Volume/Haptic Warning/Driving Safety Priority

For more information, refer to the "Driver assistance system settings" section in this chapter.

Blind-Spot Collision-Avoidance Assist Operation

Collision Warning (while driving)



To warn the driver a vehicle is detected, the warning light on the side view mirror illuminates. Vehicle detection operates under following conditions.

- Your vehicle speed: above 12 mph (20 km/h)
- Vehicle in the blind spot area: above 7 mph (10 km/h)

Collision Warning operates when the turn signal is turned on in the direction of the detected vehicle.

- To warn the driver of a collision, the warning light on the side view mirror blinks. At the same time, an audible warning sounds.
- When the turn signal is turned off, the collision warning is canceled and Blind-Spot Collision Avoidance Assist returns to vehicle detection state.

Collision Warning operates under following conditions.

- Your vehicle speed: above 25 mph (40 km/h)
- Vehicle in the blind spot area: above 7 mph (10 km/h)

WARNING

- The detecting range of the rear corner radar is determined by a standard road width, therefore, on a narrow road, Blind-Spot Collision-Avoidance Assist may detect other vehicles two lanes over and warn you. In contrast, on a wide road, Blind-Spot Collision-Avoidance Assist may not be able to detect a vehicle driving in the next lane and may not warn you.
- When the hazard warning flasher is on, the collision warning by the turn signal will not operate.

Information

The images and colors in the instrument cluster may differ depending on the instrument cluster type or theme selected from the settings menu.

Collision-Avoidance Assist (while exiting parallel spot)

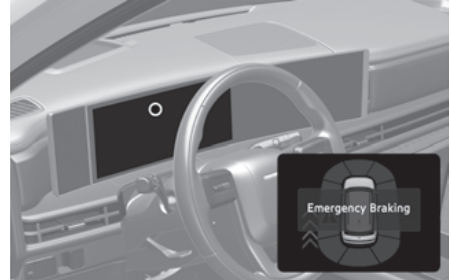

- To warn the driver of a collision, the warning light on the side view mirror will blink and a warning message will appear on the instrument cluster. At the same time, an audible warning will sound, warning light will blink and the steering wheel will vibrate.
- Emergency Braking will be assisted to help prevent collision with the vehicle in the blind spot area.
- Blind-Spot Collision-Avoidance Assist will operate when your vehicle speed is below 2 mph (3 km/h) and the speed of the vehicle in the blind spot area is above 3 mph (5 km/h).
- When the vehicle is stopped due to emergency braking, the "**Drive carefully**" warning message will appear on the instrument cluster.

For your safety, the driver should depress the brake pedal immediately and check the surroundings.

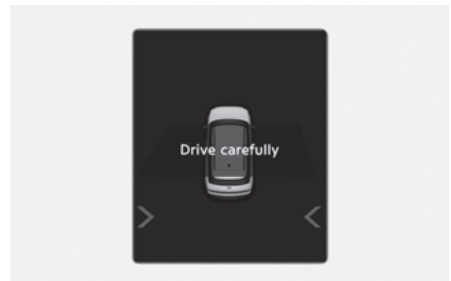

- Brake control will end after approximately 2 seconds of emergency brake control.
- During braking control by the Blind-Spot Collision-Avoidance Assist, braking control will end when the driver operates the brake pedal with sufficient force.

WARNING

Take the following precautions when using Blind-Spot Collision-Avoidance Assist:

- For your safety, only change the Settings after parking the vehicle at a safe location.
 - If any other system's warning message appears or audible warning is generated, Blind-Spot Collision-Avoidance Assist's warning message may not be displayed and audible warning may not be generated.
 - You may not hear the warning sound of Blind-Spot Collision-Avoidance Assist if the surrounding is noisy.
 - Blind-Spot Collision-Avoidance Assist may not operate if the driver applies the brake pedal to avoid a collision.
 - When Blind-Spot Collision-Avoidance Assist is operating, braking control by the function will automatically cancel when the driver excessively depresses the accelerator pedal or sharply steers the vehicle.
 - During Blind-Spot Collision-Avoidance Assist operation, the vehicle may stop suddenly injuring passengers and shifting loose objects. Always have the seat belt on and keep loose objects secured.
- Even if there is a problem with Blind-Spot Collision-Avoidance Assist, the vehicle's basic braking will function normally.
 - Blind-Spot Collision-Avoidance Assist does not operate in all situations and cannot avoid all collisions.
 - Blind-Spot Collision-Avoidance Assist may warn the driver late or may not warn the driver depending on the road and driving conditions.
 - Driver should maintain control of the vehicle at all times. Do not depend on Blind-Spot Collision-Avoidance Assist. Maintain a safe braking distance, and if necessary, depress the brake pedal to reduce driving speed or to stop the vehicle.
 - Never operate Blind-Spot Collision-Avoidance Assist on people, animal, objects, etc. It may cause serious injury or death.

WARNING

The brake control may not operate properly depending on the status of ESC (Electronic Stability Control).

There will only be a warning when:

- The ESC (Electronic Stability Control) warning light is on
 - ESC (Electronic Stability Control) is engaged in a different function
-

Blind-Spot Collision-Avoidance Assist Malfunction and Limitations

Blind-Spot Collision-Avoidance Assist malfunction

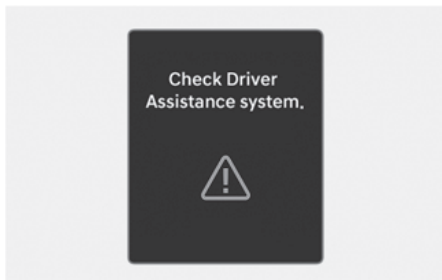

When Blind-Spot Collision-Avoidance Assist is not working properly, the "**Check Driver Assistance system.**" warning message will appear on the instrument cluster for several seconds, and the master (⚠) warning light will appear on the instrument cluster. If this occurs, have your vehicle inspected by an authorized HYUNDAI dealer.

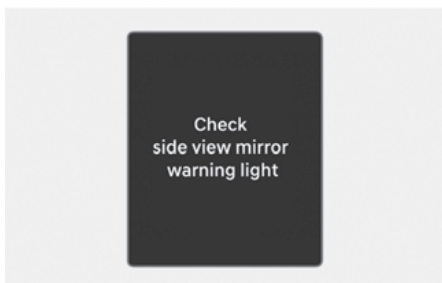

When the side view mirror warning light is not working properly, the "**Check side view mirror warning light**" warning message will appear on the instrument cluster for several seconds, and the master (⚠) warning light will illuminate on the instrument cluster. If this occurs, have your vehicle inspected by an authorized HYUNDAI dealer.

Blind-Spot Collision-Avoidance Assist disabled

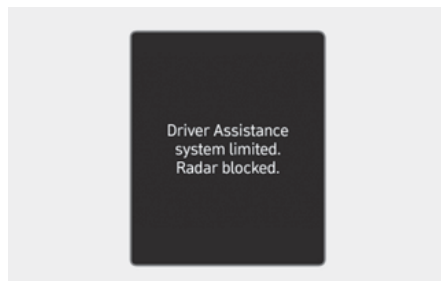

When the rear bumper around the rear corner radar or sensor is covered with foreign material, such as snow or rain, or installing a trailer or carrier, it can reduce the detecting performance and temporarily limit or disable Blind-Spot Collision-Avoidance Assist.

If this occurs, the "**Driver Assistance system limited. Radar blocked.**" warning message will appear on the instrument cluster.

Blind-Spot Collision-Avoidance Assist will operate properly when such foreign material or trailer, etc., is removed, and then the vehicle is restarted.

If Blind-Spot Collision-Avoidance Assist does not operate properly after it is removed, have your vehicle inspected by an authorized HYUNDAI dealer.

⚠ WARNING

- Even though the warning message does not appear on the instrument cluster, Blind-Spot Collision-Avoidance Assist may not properly operate.
- Blind-Spot Collision-Avoidance Assist may not properly operate in an area (for example, open terrain) where any objects are not detected right after the vehicle is turned on, or when the detecting sensor is blocked with foreign material right after the vehicle is turned on.

CAUTION

Turn off Blind-Spot Collision-Avoidance Assist to install or remove a trailer, carrier, or another attachment. Turn on Blind-Spot Collision-Avoidance Assist when finished.

Limitations of Blind-Spot Collision-Avoidance Assist

Blind-Spot Collision-Avoidance Assist may not operate properly, or it may operate unexpectedly under the following circumstances:

- There is inclement weather, such as heavy snow, heavy rain, etc.
- The rear corner radar is covered with snow, rain, dirt, etc.
- The temperature around the rear corner radar is high or low
- Driving on a highway ramp
- The road pavement (or the peripheral ground) abnormally contains metallic components (for example, possibly due to subway construction)
- There is a fixed object near the vehicle, such as sound barriers, guardrails, central dividers, entry barriers, street lamps, signs, tunnels, walls, etc. (including double structures)
- Driving in vast areas where there are few vehicles or structures (for example, desert, meadow, suburb, etc.)
- Driving through a narrow road where trees or grass are overgrown
- Driving on a wet road surface, such as a puddle on the road
- The other vehicle drives very close behind your vehicle, or the other vehicle passes by your vehicle in close proximity
- The speed of the other vehicle is very fast that it passes by your vehicle in a short time
- Your vehicle passes by the other vehicle
- Your vehicle changes lane
- Your vehicle has started at the same time as the vehicle next to you and has accelerated
- The vehicle in the next lane moves two lanes away from you, or when the vehicle two lanes away moves to the next lane from you
- A trailer, carrier or other attachment is installed around the rear corner radar
- The bumper around the rear corner radar is covered with objects, such as a bumper sticker, bumper guard, bike rack, etc.
- The bumper around the rear corner radar is impacted, damaged or the radar is out of position
- Your vehicle height is low or high due to heavy loads, abnormal tire pressure, etc.

Blind-Spot Collision-Avoidance Assist may not operate properly, or it may operate unexpectedly when the following objects are detected:

- A motorcycle or bicycle is detected
- A vehicle such as a flat trailer is detected
- A big vehicle such as a bus or truck is detected
- A moving obstacle such as a pedestrian, animal, shopping cart or a baby stroller is detected
- A vehicle with low height such as a sports car is detected

Braking control may not work, driver's attention is required in the following circumstances:

- The vehicle severely vibrates while driving over a bumpy road, uneven road or concrete patch
- Driving on a slippery surface due to snow, water puddle, ice, etc.
- The tire pressure is low or a tire is damaged
- The braking system has been modified
- The vehicle makes abrupt lane changes

i Information

For more information on the limitations of the front view camera, refer to the "Forward Collision-Avoidance Assist (FCA)" and "Lane Keeping Assist (LKA)" section in this chapter.

! WARNING

- **Driving on a curved road**

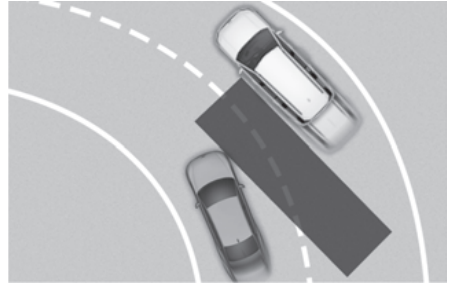

Blind-Spot Collision-Avoidance Assist may not operate properly when driving on a curved road. The function may not detect the vehicle in the next lane.

Always pay attention to road and driving conditions while driving.

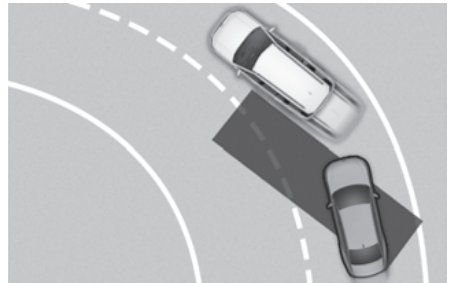

Blind-Spot Collision-Avoidance Assist may not operate properly when driving on a curved road. The function may recognize a vehicle in the same lane.

Always pay attention to road and driving conditions while driving.

- **Driving on an inclined road**

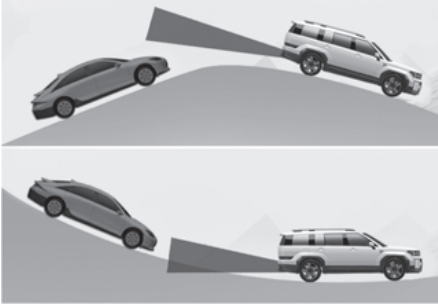

Blind-Spot Collision-Avoidance Assist may not operate properly when driving on a slope. The function may not detect the vehicle in the next lane or may incorrectly detect the ground or structure. Always pay attention to road and driving conditions while driving.

- **Driving where the road is merging/dividing**

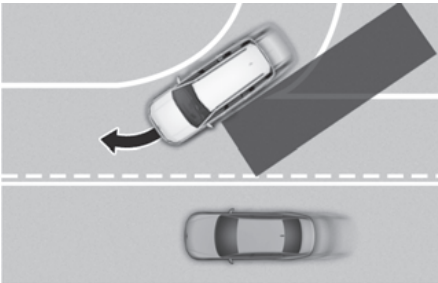

Blind-Spot Collision-Avoidance Assist may not operate properly when driving where the road merges or divides. The function may not detect the vehicle in the next lane.

Always pay attention to road and driving conditions while driving.

- **Driving where the heights of the lanes are different**

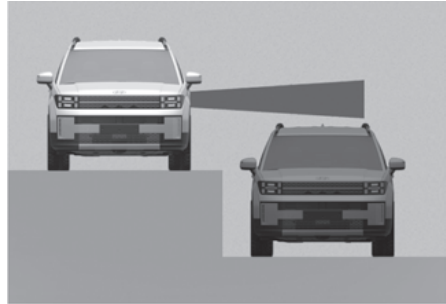

Blind-Spot Collision-Avoidance Assist may not operate properly when driving where the heights of the lanes are different. The function may not detect the vehicle on a road with different lane heights (underpass joining section, grade separated intersections, etc.). Always pay attention to road and driving conditions while driving.

⚠ WARNING

- When you are towing a trailer or another vehicle, make sure that you turn off Blind-Spot Collision-Avoidance Assist.
- Blind-Spot Collision-Avoidance Assist may not operate properly if interfered by strong electromagnetic waves.
- Blind-Spot Collision-Avoidance Assist may not operate for 15 seconds after the vehicle is started, or the front view camera or rear corner radars are initialized.

Safe Exit Assist (SEA)

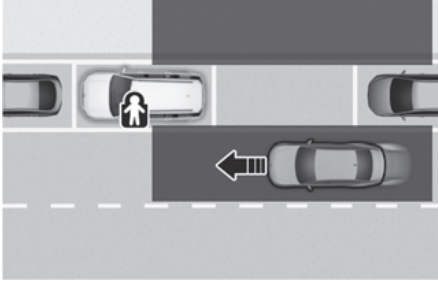

While your vehicle is stopped, if Safe Exit Assist detects a vehicle approaching the rear corner of your vehicle and a passenger opens a door, Safe Exit Assist may warn you with a warning message and a warning sound to help avoid a collision.



When the electronic child safety lock (🔒) button is in the LOCK position and an approaching vehicle from the rear area is detected, the electronic child safety lock button will not unlock even if the driver presses the button to prevent the rear doors from opening.

⚠ CAUTION

- Warning timing may vary depending on the speed of the approaching vehicle.
- Do not use Safe Exit Assist instead of the electronic child safety lock button. To protect rear seat passengers, use the electronic child safety lock button. For more information on, refer to the "Electronic child safety lock" section in chapter 5.

i Information

Safe Exit Assist uses the following sensor:

- Rear corner radars

Refer to the "Driver Assistance System Sensors" section in this chapter for the location.

Safe Exit Assist settings

Safe Exit

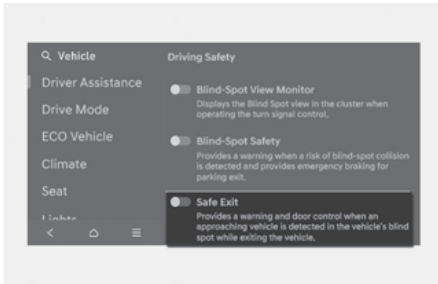

With the engine on, select **Setup > Vehicle > Driver assistance > Driving Safety > Safe Exit** from the Settings menu to turn on Safe Exit Assist and deselect to turn off the function.

WARNING

The driver should always be aware of their surroundings. If "**Safe Exit**" is deselected, Safe Exit Assist cannot assist you.

Information

If the vehicle is restarted, Safe Exit Assist will maintain the previous setting.

CAUTION

When the vehicle and the trailer are connected electrically, a warning message appears on the instrument cluster, and Safe Exit Assist is deactivated. The function resumes after the trailer connector is disconnected. (When using HYUNDAI genuine parts)

Information

You can set the following Warning Methods:

- Warning Volume/Driving Safety Priority

For more information, refer to the "Driver assistance system settings" section in this chapter.

Safe Exit Assist operation

Safe Exit Assist

Collision warning when exiting vehicle

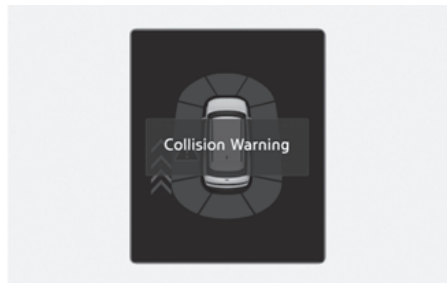

- When an approaching vehicle from the rear is detected at the moment a door is opened, the "**Collision Warning**" warning message appears on the instrument cluster, and an audible warning sounds.

- Safe Exit Assist warns the driver when your vehicle speed is below 1.8 mph (3 km/h), and the speed of the approaching vehicle from the rear is above 4 mph (6 km/h).

Safe Exit Assist linked with Electronic child safety lock



- When Electric child safety lock is operating and an approaching vehicle from the rear area is detected, the rear doors cannot be unlocked even if the driver tries to unlock the rear doors using the electronic child safety lock button. The warning light on the side view mirror will blink and the "**Check traffic in the blind spot, then try again**" warning message will appear on the instrument cluster.
- Safe Exit Assist will warn the driver when vehicle speed is below 1.8 mph (3 km/h) and the speed of the approaching vehicle from the rear is above 4 mph (6 km/h).

i Information

For more information on electric child safety lock (🔒) button, refer to the "Electronic child safety lock" section in chapter 5.

⚠ CAUTION

If the driver presses the electronic child safety lock (🔒) button again within 10 seconds after the warning message appears, Safe Exit Assist judges that the driver has unlocked the doors acknowledging the rear status. The electronic child safety lock will turn off (button indicator OFF) and the rear doors will unlock. Always check the surroundings before turning off the electronic child safety lock button.

i Information

If a rear door is opened from the outside, it will open regardless of Safe Exit Assist operation.

WARNING

Take the following precautions when using Safe Exit Assist:

- For your safety, change the Settings after parking the vehicle at a safe location.
- If any other system's warning message appears or an audible warning is generated, Safe Exit Assist warning message may not be displayed and an audible warning may not be generated.
- You may not hear the warning sound of Safe Exit Assist if the surroundings are noisy.
- Safe Exit Assist does not operate in all situations and cannot prevent all collisions.
- Safe Exit Assist may warn the driver late or may not warn the driver depending on the road and driving conditions. Always check vehicle surroundings.
- The driver and passengers are responsible for collisions that occur while exiting the vehicle. Always check the surroundings before you exit the vehicle.
- Never deliberately test Safe Exit Assist. Doing so may lead to serious injury or death.

Information

- After the engine is turned off, Safe Exit Assist operates about for 3 minutes, but turns off immediately if the doors are locked.
- The images and colours in the instrument cluster may differ depending on the instrument cluster type or theme selected from the settings menu.

Safe Exit Assist malfunction and limitations

Safe Exit Assist malfunction

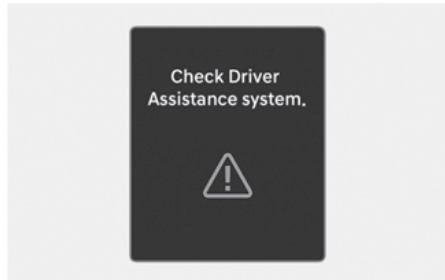

When Safe Exit Assist is not working properly, the "**Check Driver Assistance system.**" warning message appears on the instrument cluster for several seconds, and the master () warning light illuminates on the instrument cluster. If this occurs, have your vehicle inspected by an authorized HYUNDAI dealer.

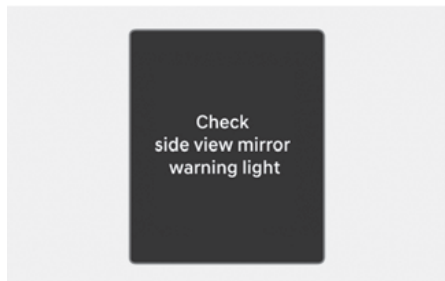

When the side view mirror warning light is not working properly, the "**Check side view mirror warning light**" warning message appears on the instrument cluster for several seconds, and the master () warning light illuminates on the instrument cluster. If this occurs, have your vehicle inspected by an authorized HYUNDAI dealer.

Safe Exit Assist disabled

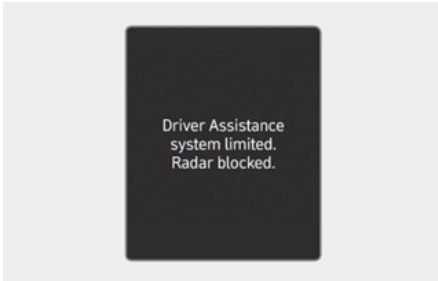

When the rear bumper around the rear corner radar or sensor is covered with foreign material, such as snow or rain, or installing a trailer or carrier, it can reduce the detecting performance and temporarily limit or disable Safe Exit Assist.

If this occurs, the "**Driver Assistance system limited. Radar blocked.**" warning message appears on the cluster display. for several seconds, and the master (⚠) warning light illuminates on the instrument cluster. But, it is not a malfunction.

Safe Exit Assist operates properly when such foreign material or trailer, etc., is removed, and then the vehicle is restarted.

If Safe Exit Assist does not operate properly after it is removed, have your vehicle inspected by an authorized HYUNDAI dealer.

⚠ WARNING

- Even though the warning message does not appear on the instrument cluster, Safe Exit Assist may not properly operate.
- Safe Exit Assist may not properly operate in an area (for example, open terrain) where objects are not detected immediately after the vehicle is turned on, or when the detecting sensor is blocked with foreign material immediately after the vehicle is turned on.

⚠ CAUTION

Turn off Safe Exit Assist to install or remove a trailer, carrier, or another attachment. Turn on Safe Exit Assist when finished.

Limitations of Safe Exit Assist

Safe Exit Assist may not operate properly, or it may operate unexpectedly under the following circumstances:

- Getting out of the vehicle where trees or grass are overgrown
- Getting out of the vehicle where the road is wet
- The approaching vehicle is very fast or very slow

i Information

For more information on the limitations of the rear corner radar, refer to the "Blind-Spot Collision-Avoidance Assist (BCA)".

! WARNING

- Safe Exit Assist may not operate properly with interference from strong electromagnetic waves.
- Safe Exit Assist may not operate for about 3 seconds after the vehicle is started, or the rear corner radars are initialised.

Manual Speed Limit Assist (MSLA)

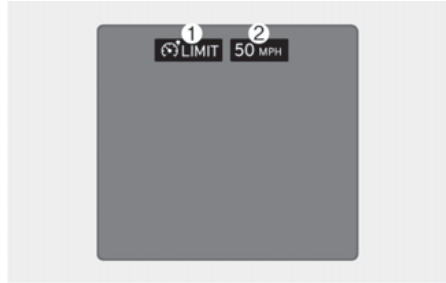

- (1) Speed Limit indicator
- (2) Set speed

You can set the speed limit when you do not want to drive over a specific speed.

If you drive over the preset speed limit, Manual Speed Limit Assist will operate (set speed limit will blink and chime will sound) until the vehicle speed returns within the speed limit.

Manual Speed Limit Assist Operation

Setting speed limit

1. Press and hold the Driving Assist (🚗) button at the desired speed. The Speed Limit (LIMIT) indicator will appear on the cluster.

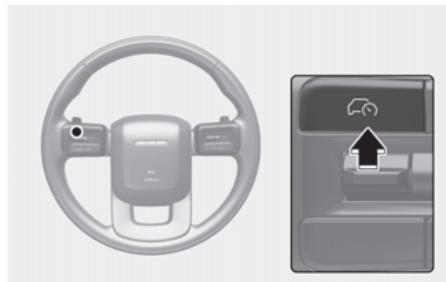

2. Push the **+** switch up or **-** switch down, and release it at the desired speed.

Push the **+** switch up or **-** switch down and hold it. The speed will increase or decrease to the nearest multiple of five (multiple of ten in km/h) at first, and then increase or decrease by 5 mph (10 km/h).

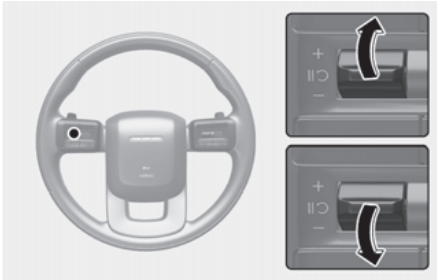

3. The set speed limit will be displayed on the cluster.

If you would like to drive over the preset speed limit, depress the accelerator pedal beyond the pressure point to activate the kickdown function.

The set speed limit will blink and chime will sound until you return the vehicle speed within the speed limit.



i Information

When the accelerator pedal is not depressed beyond the pressure point, vehicle speed will maintain within the speed limit.

Temporarily pausing Manual Speed Limit Assist

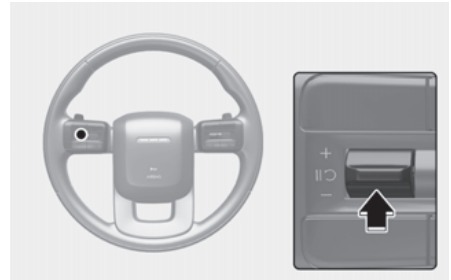

Press the **LIMIT** switch to temporarily pause the set speed limit. The set speed limit will turn off but the Speed Limit (**LIMIT**) indicator will stay on.

Resuming Manual Speed Limit Assist

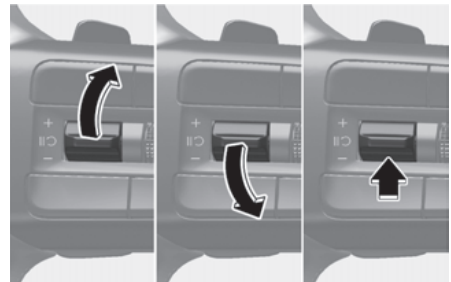

To resume Manual Speed Limit Assist after the function was paused, operate the **+**, **-**, **LIMIT** switch.

If you push the **+** switch up or **-** switch down, vehicle speed will be set to the current speed on the instrument cluster.

If you press the **LIMIT** switch, vehicle speed will resume to the preset speed.

Turning off Manual Speed Limit Assist

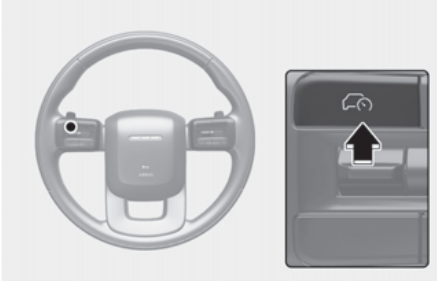

Press the Driving Assist (🚗) button to turn Manual Speed Limit Assist off. The Speed Limit (🚗LIMIT) indicator will go off. Always press the Driving Assist (🚗) button to turn Manual Speed Limit Assist off when not in use.

WARNING

Take the following precautions when using Manual Speed Limit Assist:

- Always set the vehicle speed to the speed limit in your state.
- Keep Manual Speed Limit Assist off when the function is not in use, to avoid inadvertently setting a speed. Check that the Speed Limit (🚗LIMIT) indicator is off.
- Manual Speed Limit Assist does not substitute for proper and safe driving. It is the responsibility of the driver to always drive safely and be aware of unexpected and sudden situations. Pay attention to the road conditions at all times.

Intelligent Speed Limit Assist (ISLA)

Intelligent Speed Limit Assist uses information of road signs detected from the front view camera and uses the navigation system data to inform you of the speed limit and help maintain within the speed limit on the road.

WARNING

- Intelligent Speed Limit Assist may not operate properly if used in other countries.
- Intelligent Speed Limit Assist may not operate properly if the navigation system is not updated regularly. For more information, scan the QR code in a separately supplied simple manual.

Information

Intelligent Speed Limit Assist uses the following sensor:

- Front view camera

Refer to the "Driver Assistance System Sensors" section in this chapter for the location.

Intelligent Speed Limit Assist Settings

Speed Limit

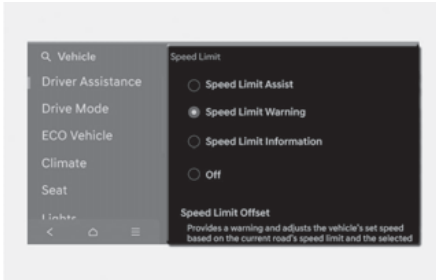

With the engine on, select or deselect **Setup > Vehicle > Driver Assistance > Speed Limit** from the infotainment system to set whether to use each function.

- **Select Country:** When the navigation system is not available, you can manually select the country to set the speed limit.
- **Speed Limit Offset:** Speed Limit Offset can be adjusted.

Speed Limit Warning and Speed Limit Assist will warn the driver and adjust the driving speed when vehicle speed exceeds the speed at which the set Offset is added to speed limit.

- **Speed Limit Assist:** Intelligent Speed Limit Assist will inform the driver of speed limit and additional road signs, and warn the driver if the vehicle speed is faster than the speed limit. In addition, Intelligent Speed Limit Assist will inform the driver to change set speed of Manual Speed Limit Assist and/or Smart Cruise Control to help the driver stay within the speed limit.
- **Speed Limit Warning:** Intelligent Speed Limit Assist will inform the driver of speed limit. In addition, Intelligent Speed Limit Assist will warn the driver when the vehicle is driven faster than the speed limit.
- **Speed Limit Information:** Intelligent Speed Limit Assist will inform the driver the current speed limit of the road.
- **Off:** Intelligent Speed Limit Assist will turn off.

WARNING

- For your safety, only change the Settings after parking the vehicle at a safe location.
- Intelligent Speed Limit Assist does not substitute for proper and safe driving. It is the responsibility of the driver to always drive safely and be aware of unexpected and sudden situations. Pay attention to the road conditions at all times.

Information

- Speed Limit Assist function operates based on the Offset setting added to the speed limit. If you want to change the set speed according to the speed limit, adjust the offset to '0'.
- The setting of 'Speed Offset' is not reflected in Navigation-based Smart Cruise Control (NSCC).

Intelligent Speed Limit Assist Operation

Warning and control

Intelligent Speed Limit Assist will warn and control the vehicle speed by "Displaying speed limit", "Warning overspeed" and "Changing set speed".

i Information

- Intelligent Speed Limit Assist warning and control are described based on the Offset adjust to "0". For details on Offset setting, refer to the "Intelligent Speed Limit Assist Settings".

i Information

- If speed limit information of the road cannot be recognized, '---' sign will be displayed. Please refer to "Limitations of Intelligent Speed Limit Assist" if the road signs are difficult to recognize.
- Intelligent Speed Limit Assist provides additional road sign information in addition to speed limit. The additional road sign information provided may vary according to your state.
- The images and colors in the instrument cluster may differ depending on the instrument cluster type or theme selected from the instrument cluster.

Displaying speed limit



Speed limit information is displayed on the instrument cluster.

Warning overspeed



When driving at a speed higher than the displayed speed limit, the speed limit is displayed in red.

Changing set speed



If the speed limit of the road changes during the operation of Manual Speed Limit Assist or Smart Cruise Control, an arrow in the direction of up or down is displayed to inform the driver that the set speed needs to be changed. At this time, the driver can change the set speed according to the speed limit by using the + or - switch on the steering wheel.

Set Speed Auto Change (if equipped with navigation)



Manual Speed Limit Assist or Smart Cruise Control assists the vehicle to adjust its speed according to the speed limit. When the cruising speed is set as same as the speed limit, the vehicle automatically adjusts its speed if the speed limit changes. The function operates on the road which has a speed limit of 45 mph (70 km/h) or higher. When the function is active, the cruising speed on the instrument cluster appears in green.

WARNING

- If you want to drive below the speed limit, adjust the Offset under **0** or use the - switch on the steering wheel to lower the set speed.
- Even after changing the set speed according to the speed limit of the road, the vehicle can still be driven over the speed limit. If necessary, depress the brake pedal to reduce your driving speed.
- If the speed limit of the road is under 20 mph (30 km/h), the set speed change function will not work.
- Intelligent Speed Limit Assist operates using the speed units in the instrument cluster set by the driver. If the speed unit is not set to the speed unit used in your state, Intelligent Speed Limit Assist may not operate properly.

Information

- For more information on Manual Speed Limit Assist operation, refer to the "Manual Speed Limit Assist (MSLA)" section in this chapter.
- For more information on Smart Cruise Control operation, refer to the "Smart Cruise Control (SCC)" section in this chapter.

Intelligent Speed Limit Assist Malfunction and Limitations

Intelligent Speed Limit Assist malfunction

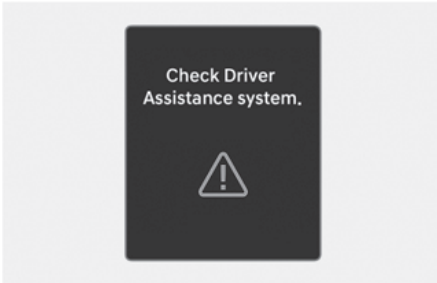

When Intelligent Speed Limit Assist is not working properly, the "**Check Driver Assistance system.**" warning message will appear on the instrument cluster for several seconds, and the master (⚠) warning light and (☒) warning light will illuminate on the instrument cluster. If this occurs, have your vehicle inspected by an authorized HYUNDAI dealer.

Intelligent Speed Limit Assist disabled

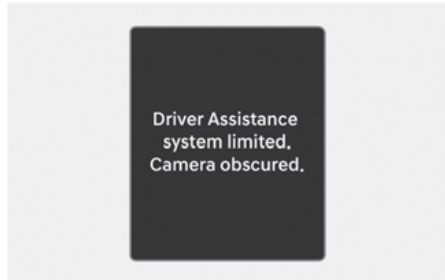

When the front windshield where the front view camera is located is covered with foreign material, such as snow or rain, it can reduce the detecting performance and temporarily limit or disable Intelligent Speed Limit Assist. If this occurs, the "**Driver Assistance system limited. Camera obscured.**" warning message, the (⚠) and (☒) warning lights will appear on the instrument cluster.

Intelligent Speed Limit Assist will operate properly when snow, rain or foreign material is removed.

If Intelligent Speed Limit Assist does not operate properly after it is removed, have your vehicle inspected by an authorized HYUNDAI dealer.

WARNING

- Even though the warning message or warning light does not appear on the instrument cluster, Intelligent Speed Limit Assist may not properly operate.

Limitations of Intelligent Speed Limit Assist

Intelligent Speed Limit Assist may not operate properly, or it may operate unexpectedly under the following circumstances:

- The road sign is contaminated or indistinguishable
- The road sign is difficult to see due to bad weather, such as rain, snow, fog, etc.
- The road sign is not clear or damaged
- The road sign is partially obscured by surrounding objects or shadow
- The road signs do not conform to the standard
- The text or illustration on the road sign is different from the standard
- The road sign is installed between the main line and the exit road or between diverging roads
- There is no conditional road signs on the road sign located on the exit road
- A sign is attached to another vehicle
- The distance between the vehicle and the road signs is too far
- The vehicle encounters illuminant road signs
- Intelligent Speed Limit Assist incorrectly recognizes numbers or illustrations in the street signs or other signs as the speed limit
- A road sign near the road you are driving is detected
- The other traffic sign or signboards are alongside the road sign
- Multiple signs are installed close together
- The minimum speed limit sign is misrecognized
- The minimum speed limit sign is on the road
- The brightness changes suddenly, for example when entering or exiting a tunnel or passing under a bridge
- Headlights are not used or the brightness of the headlights are weak at night or in the tunnel
- Road signs are difficult to recognize due to the reflection of sunlight, street lights, or oncoming vehicles
- The navigation information or GPS information contain errors.
- The driver does not follow the guide of the navigation.
- The driver is driving on a new road that is not in the navigation system yet.
- The field of view of the front view camera is obstructed by sun glare
- Driving on a road that is sharply curved or continuously curved
- Driving through speed bumps, or driving up and down or left to right on steep inclines
- The vehicle is shaking heavily
- Driving on a newly opened road
- The navigation software is being updated while driving
- The navigation is restarted while driving

 **WARNING**

- Intelligent Speed Limit Assist is a supplemental function that helps the driver comply with the speed limit on the road, and may not display the correct speed limit or control the driving speed properly.
 - Always set the vehicle speed to the speed limit in your area.
 - Intelligent Speed Limit Assist may not operate for 15 seconds after the vehicle is started, or the front camera is initialized.
-

 **Information**

For more information on the limitations of the front view camera, refer to the "Forward Collision-Avoidance Assist (FCA)" section in this chapter.

Driver Attention Warning (DAW)

Inattentive driving warning

Driver Attention Warning monitors your driving pattern while driving. When the driver's attention level is below a certain level, Driver Attention Warning recommends a break to help with safe driving.

Leading vehicle departure alert function

Leading Vehicle Departure Alert function will inform the driver when a detected vehicle in front departs.

 **Information**

Driver Attention Warning uses the following sensor:

- Front view camera

Refer to the "Driver Assistance System Sensors" section in this chapter for the location.

Driver Attention Warning Settings

Leading Vehicle Departure Alert

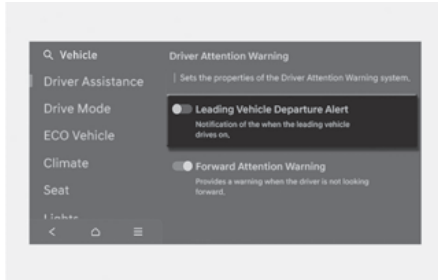

With the engine on, select or deselect **Setup > Vehicle > Driver Assistance > Driver Attention Warning** and then enable **Leading Vehicle Departure alert** in the infotainment system to set whether to use each function.

- If '**Leading Vehicle Departure Alert**' is selected, the function will inform the driver when a detected vehicle in front departs from a stop.

i Information

When the engine is restarted, Driver Attention Warning maintains the last setting.

i Information

You can set the following Warning Methods:

- Driving Safety Priority

For more information, refer to the "Driver assistance system settings" section in this chapter.

Inattentive Driving Warning Operation

Inattentive Driving Warning

The basic function of Driver Attention Warning is to warn the driver "**Consider taking a break**".

Taking a break

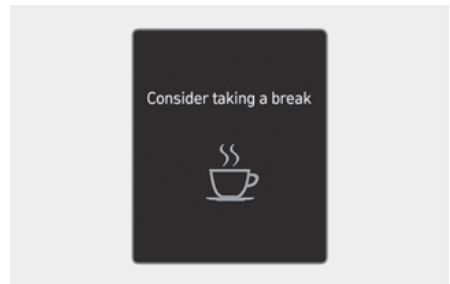

- The "**Consider taking a break**" message will appear and the inattentive driving (☹️) warning light will blink on the cluster with a warning sound to suggest that the driver take a break, when the driver's attention level is below a certain level.
- Driver Attention Warning will not suggest a break when the total driving time is shorter than 4 minutes or 4 minutes has not passed after the last break was suggested.

! WARNING

For your safety, change the Settings after parking the vehicle at a safe location.

CAUTION

- Driver Attention Warning may suggest a break depending on the driver's driving pattern or habits, even if the driver doesn't feel fatigue.
 - Driver Attention Warning is a supplemental function and may not be able to determine whether the driver is inattentive.
 - A driver who feels fatigued should take a break at a safe location, even though there is no break suggestion by Driver Attention Warning.
-

Information

For more information on instrument cluster settings, refer to the "Cluster Display" section in chapter 4.

Leading Vehicle Departure Alert function



When a detected vehicle in front departs from a stop, Leading Vehicle Departure Alert will inform the driver by displaying the "**Leading vehicle is driving away**" message on the instrument cluster and an audible warning will sound.

WARNING

- If any other system's warning message is displayed or audible warning is generated, Leading Vehicle Departure Alert's warning message may not be displayed and audible warning may not be generated.
 - The driver has the responsibility to safely drive and control the vehicle.
-

CAUTION

- Leading Vehicle Departure Alert is a supplemental function and may not alert the driver whenever the front vehicle departs from a stop.
 - Always check the front of the vehicle and road conditions before departure.
-

i Information

The images and colors in the instrument cluster may differ depending on the cluster type or theme selected in the infotainment system.

Driver Attention Warning Malfunction and Limitations

Driver Attention Warning malfunction

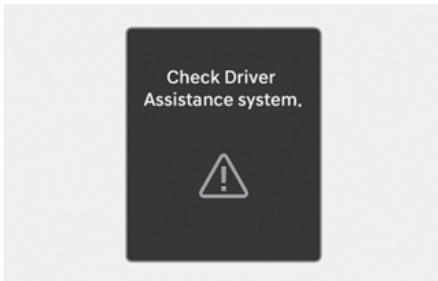

When Driver Attention Warning is not working properly, the "**Check Driver Assistance system.**" warning message will appear on the cluster for several seconds, and the master (⚠) warning light and the driver's attention (🚦) warning light will appear on the instrument cluster. If this occurs, have your vehicle inspected by an authorized HYUNDAI dealer.

Driver Attention Warning disabled

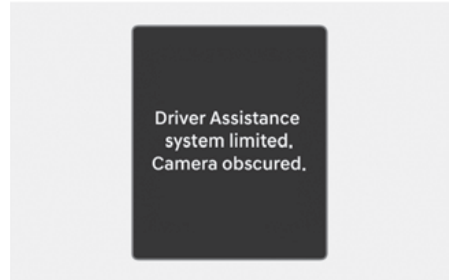

When the front windshield where the front view camera is located is covered with foreign material, such as snow or rain, it can reduce the detecting performance and temporarily limit or disable Driver Attention Warning.

If this occurs, the "**Driver Assistance system limited. Camera obscured.**" warning message, the master (⚠) warning light, and the driver's attention (🚦) warning light will appear on the instrument cluster.

Driver Attention Warning will operate properly when snow, rain or foreign material is removed. If Driver Attention Warning does not operate properly after it is removed, have your vehicle inspected by an authorized HYUNDAI dealer.

WARNING

- Driver Attention Warning may not properly operate in an area (for example, open terrain) where any objects are not detected right after turning ON the vehicle.

Limitations of Driver Attention Warning

Driver Attention Warning may not work properly in the following situations:

- The vehicle is driven violently
- The vehicle intentionally crosses over lanes frequently
- The vehicle is controlled by Driver Assistance system, such as Lane Keeping Assist
- Lanes are blurred or erased

Leading Vehicle Departure Alert function

• When the vehicle cuts in

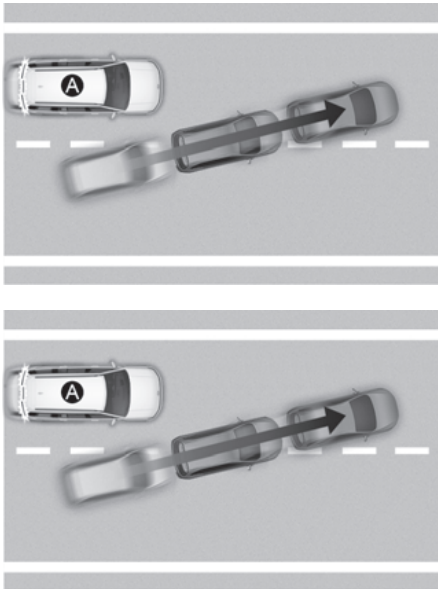

[A] Your vehicle
[B] Front vehicle

If a vehicle cuts in front of your vehicle, Leading Departure Alert may not operate properly.

• When the vehicle ahead sharply steers

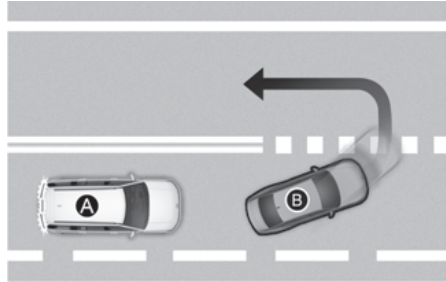

[A] Your vehicle
[B] Front vehicle

If the vehicle in front makes a sharp turn, such as to turn left or right or make a U- turn, etc., Leading Vehicle Departure Alert may not operate properly.

• When the vehicle ahead abruptly departs

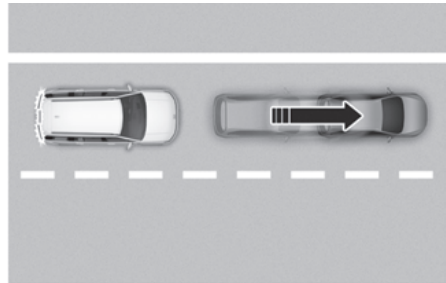

If the vehicle in front abruptly departs, Leading Vehicle Departure Alert may not operate properly.

- **When a pedestrian or bicycle is between you and the vehicle ahead**



If there is a pedestrian(s) or bicycle(s) in between you and the vehicle in front, Leading Vehicle Departure Alert may not operate properly.

- **When in a parking lot**

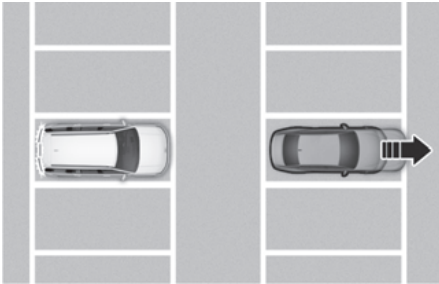

If a vehicle parked in front drives away from you, Leading Vehicle Departure Alert may alert you that the parked vehicle is driving away.

- **When driving at a tollbooth or intersection, etc.**

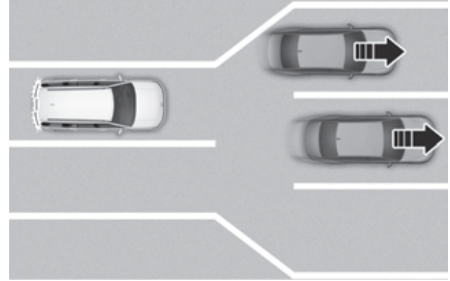

If you pass a tollbooth or intersection with lots of vehicles or you drive where lanes are merged or divided frequently, Leading Vehicle Departure Alert may not operate properly.

WARNING

Driver Attention Warning may not operate for about 15 seconds after the vehicle is started, or the front view camera is initialized.

i **Information**

For more information on the precautions of the front view camera, refer to the "Forward Collision-Avoidance Assist (FCA)" section in this chapter.

Forward Attention Warning (FAW)

 If equipped

Forward Attention Warning uses the in-cabin camera to help prevent the driver from being distracted while driving with an audible warning and warning light.

i Information

Forward Attention Warning uses the following sensor:

- In-cabin camera

Refer to the "Driver Assistance System Sensors" section in this chapter for the location.

Forward Attention Warning settings

Forward Attention Warning

With the engine on, select or deselect **Setup > Vehicle > Driver Assistance > Driver Attention Warning > Forward Attention Warning** in the infotainment system to set whether to use the function.

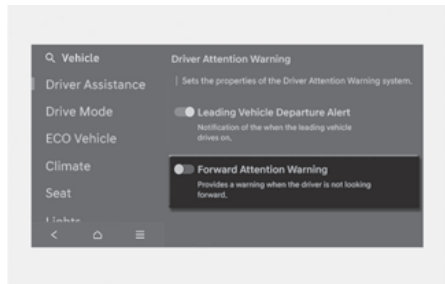

If "**Forward Attention Warning**" is enabled, the function warns the driver when the driver's gaze is not focused on the road.

i Information

- When the vehicle is restarted, Forward Attention Warning maintains the last setting.
- Even if Forward Attention Warning is turned off, the in-cabin camera still operates to detect the driver's forward attention under the condition Emergency Stop can operate (i.e., if Smart Cruise Control and Lane Following Assist are turned on).

Forward Attention Warning operation

Operating conditions

Forward Attention Warning will operate when the following conditions are satisfied:

- Vehicle speed is above 0.6 mph (1 km/h)
- The gear is in D (Drive) or N (Neutral)

Forward Attention Warning



Forward Attention Warning determines whether the driver is focused on the road depending on information, such as the amount of time the driver is looking elsewhere, the amount of time the eyes are closed, how frequently the driver yawns, etc. If Forward Attention Warning judges the driver is not focused, the **"Keep eyes on the road and drive carefully"** warning message will appear on the cluster, and an audible warning will sound.

WARNING

If any other system's warning message is displayed or audible warning is generated, Forward Attention Warning's warning message may not be displayed and audible warning may not be generated.

CAUTION

- Forward Attention Warning may warn the driver even though the driver is focused on the road because of driving style and driving pattern.
- Forward Attention Warning is a supplemental function and may not determine whether the driver is distracted while driving.
- The driver is responsible for safe driving and must focus on the road.

Information

- The In-cabin camera does not transmit recorded videos outside of the vehicle or store the video.
- The Warning method for Forward Attention Warning can not be changed.

Forward Attention Warning malfunction and limitations

Forward Attention Warning malfunction

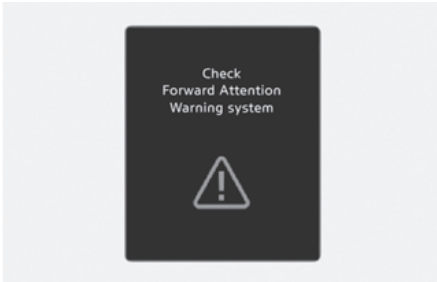

When Forward Attention Warning is not working properly, the "**Check Forward Attention Warning system**" warning message will appear on the cluster. If this occurs, have the vehicle inspected by an authorized HYUNDAI dealer.

Forward Attention Warning disabled

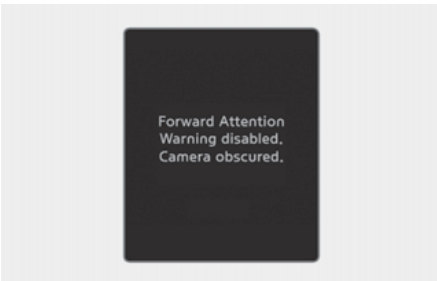

When there is an object right in front of the in-cabin camera or between the driver and the camera for a certain period of time, Forward Attention Warning does not operate properly, and the "**Forward Attention Warning disabled. Camera obscured**" warning message appears on the instrument cluster, and an audible warning sounds.

If the object is removed or the camera is able to detect the driver's face, the function will operate normally. If Forward Attention Warning does not operate properly after the object is removed, have your vehicle inspected by an authorized HYUNDAI dealer.

CAUTION

- Do not impact the surface of the camera or around the camera. If the in-cabin camera is damaged, Forward Attention Warning may not work properly.
- Do not place anything on the camera or in front of the camera while driving. The in-cabin camera may not operate properly.
- When cleaning the camera, wipe with a soft and clean cloth to prevent damages on the surface of the camera lens. In addition, you should not use sharp tools near the camera, or use chemicals to clean the camera.
- Always keep the camera and around the area of the in-cabin camera clean and dry.
- Do not apply foreign objects, such as a sticker, around the infrared LED located near the camera.

i Information

- Two red lights may appear on the camera in the following conditions when:
 - The outside brightness is dim or driving at night
 - The vehicle drives inside a building, such as a basement parking lot, garage or tunnel
 - The camera case is partially broken

⚠ WARNING

Do not look toward the camera within 8 in. (20 cm) for longer than a minute.

Limitations of Forward Attention Warning

Forward Attention Warning may not operate properly, or it may operate unexpectedly under the following circumstances:

- The driver is wearing sunglasses, special glasses, infrared cutoff glasses, refracting glasses or thick glasses
- The driver has heavy eye makeup (eyeliner, mascara, color makeup, false eyelash) or eye piercing
- The driver's view is blocked by his/her hair, hat, etc.
- The driver is winking or wearing an eye patch on one eye
- The driver's face is covered partially by a mask, muffler, etc.
- The driver's view is blocked by incoming light from outside of the vehicle
- Light from outside, sunlight or infrared LED light of the camera is reflected by glasses or sunglasses
- The driver turns or lowers his/her head so that the face or an eye is hidden from the camera
- The driver shakes his/her head up and down, or adverse road conditions cause excessive vehicle vibrations while driving
- The driver is improperly positioned in the driver's seat so that the driver's face is not detected
- The driver is too tall or short
- The camera is blocked by the driver's grip on the steering wheel
- More than two people are looking at the instrument cluster simultaneously from the driver's seat
- The driver's eyes are narrowed due to laughing or sun glare
- Misrecognize a picture or mannequin that has a similar size of the driver's face
- There are other devices using infrared light in the vehicle

Blind-Spot View Monitor (BVM)

 If equipped

Left



Right



Blind-Spot View Monitor uses the wide-side view cameras to display the rear blind spot areas of your vehicle on the instrument cluster when the turn signal is turned on to help with safe lane changes.

Information

Blind-Spot View Monitor uses the following sensors:

- Wide-side view cameras (camera located at bottom of the mirror)

Refer to the "Driver Assistance System Sensors" section in this chapter for the location.

Blind-Spot View Monitor Settings

Setting features

Blind-Spot View

With the engine on, select **Setup** > **Vehicle** > **Driver Assistance** > **Driving Safety** and then enable **Blind-Spot View Monitor** in the infotainment system to turn on the Blind-Spot View Monitor feature.

Blind-Spot View Monitor Operation

Operating switch

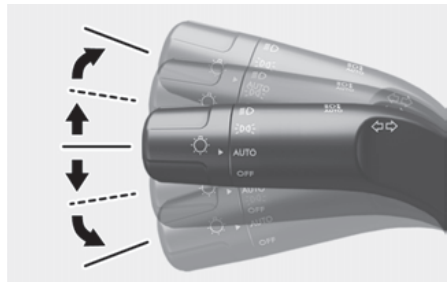

Turn signal switch

Blind-Spot View Monitor will turn on and off when the turn signal is turned on and off.

Blind-Spot View Monitor

Operating conditions

When the left or right side turn signal turns on, the image in that direction is displayed on the instrument cluster.

Off conditions

- When the turn signal turns off, the image on the instrument cluster will turn off.
- When the hazard warning flasher is on, Blind-Spot View Monitor will turn off, regardless of the turn signal status.
- When other important warning is displayed on the instrument cluster, Blind-Spot View Monitor may turn off.

Blind-Spot View Monitor Malfunction

When Blind-Spot View Monitor is not working properly, or the cluster display flickers, or the camera image does not display properly, have your vehicle inspected by an authorized HYUNDAI dealer.

WARNING

- The image shown on the instrument cluster may differ from the actual distance of the object. Make sure to directly check the vehicle's surroundings for safety.
- Always keep the camera lens clean. If the lens is covered with foreign material, it may adversely affect camera performance and Blind-Spot View Monitor may not operate properly.

Smart Cruise Control (SCC)

Smart Cruise Control helps maintain a set distance and speed from the vehicle ahead.

Overtaking Acceleration Assist

When Smart Cruise Control judges you are attempting to overtake a vehicle in front, Smart Cruise Control help with accelerating.

Based on Driving Style

 if equipped

Smart Cruise Control will operate based on the driver's driving style, such as inter-vehicle distance, acceleration, reaction speed.

Information

Smart Cruise Control uses the following sensors:

- Front view camera
- Front radar
- Front corner radar (if equipped)

Refer to the "Driver Assistance System Sensors" section in this chapter for the location.

Smart Cruise Control Settings

Smart Cruise Control

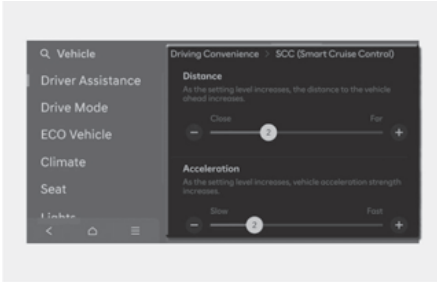

With the engine on, select **Setup > Vehicle > Driver Assistance > Driving Convenience > Smart Cruise Control** from the Settings menu in the infotainment system, you can change the vehicle distance, the acceleration, and the reaction speed manually.

Based on Driving Style

 if equipped

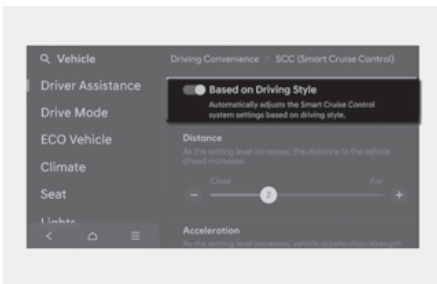

Smart Cruise Control operates based on your driving style, such as vehicle distance, acceleration, and reaction speed.

With the engine on, select **Setup > Vehicle > Driver Assistance > Driving Convenience > Smart Cruise Control > Based on Driving Style** from the Settings menu in the infotainment system.

Information

- If the **Based on Driving Style** is supported, you can select it from the **Vehicle > Driver Assistance > Driving Convenience > Smart Cruise Control**.
- Based on driving style setting continuously learns when the driver drives the vehicle.
- When Based on driving style is deactivated, the driver's driving style such as vehicle distance, acceleration, reaction speed will maintain in the same stage.

Information

You can set the following Warning Methods:

- Warning Volume/Haptic Warning/Driving Safety Priority

For more information, refer to the "Driver assistance system settings" section in this chapter.

Smart Cruise Control Operation

Operating conditions

Basic function

Smart Cruise Control operates when the following conditions are satisfied.

- The gear is in D (Drive)
- Your vehicle speed is within the operating speed range
 - 5-110 mph (10-180 km/h): when there is no vehicle in front
 - 0-110 mph (0-180 km/h): when there is a vehicle in front
- ESC (Electronic Stability Control) or ABS (Anti-Lock Braking System) is on

Smart Cruise Control does not operate in the following conditions.

- Your vehicle is in power down mode (Ⓜ indicator on)
- The driver's door is opened
- EPB (Electronic Parking Brake) is applied
- ESC (Electronic Stability Control) or ABS (Anti-Lock Braking System) is controlling the vehicle
- Forward Collision-Avoidance Assist brake control is operating
- Remote Smart Parking Assist brake control is operating (if equipped)
- Hands-off warning for Lane Keeping Assist and Highway Driving Assist is on

i Information

When stopped behind another vehicle, the driver can turn on Smart Cruise Control while the brake pedal is depressed.

Operating conditions for Acceleration Assist

Overtaking Acceleration Assist operates when the turn signal indicator is turned on to the left while Smart Cruise Control is operating, and the following conditions are satisfied:

- Your vehicle speed is above 40 mph (60 km/h)
- A vehicle is detected in front of your vehicle

Overtaking Acceleration Assist does not operate in the following conditions.

- The hazard warning flasher is on
- Vehicle speed is reduced to maintain distance with the vehicle in front

WARNING

- When the turn signal indicator is turned on to the left while there is a vehicle ahead, the vehicle may accelerate temporarily. Pay attention to the road conditions at all times.

Turning on Smart Cruise Control

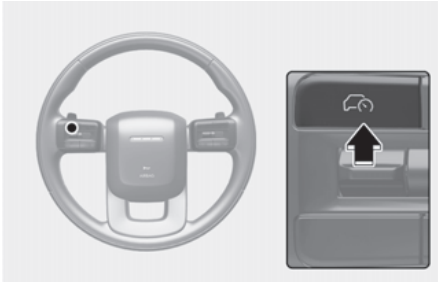

- Press the Driving Assist button to turn on Smart Cruise Control. The speed will be set to the current speed on the instrument cluster.
- If there is no vehicle in front of you, the set speed will be maintained, but if there is a vehicle in front of you, the speed may decrease to maintain the distance to the vehicle ahead. If the vehicle ahead accelerates, your vehicle will travel at a steady cruising speed after accelerating to the set speed.

i Information

If your vehicle speed is between 0-20 mph (0-30 km/h) when you press the Driving Assist button, Smart Cruise Control speed will be set to 20 mph (30 km/h).

Setting vehicle distance

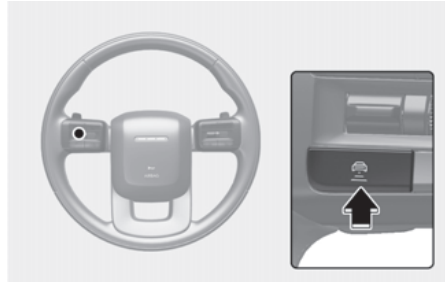

Press the button repeatedly to cycle through the headway settings from **Distance 4** → **Distance 3** → **Distance 2** → **Distance 1** → **Distance 4**.

If you drive at 56 mph (90 km/h), the distance is maintained as follows:

- Distance 4: about 172 ft. (52.5 m)
- Distance 3: about 130 ft. (40 m)
- Distance 2: about 106 ft. (30 m)
- Distance 1: about 82 ft. (25 m)

i Information

The distance is set to the last set distance when the vehicle is restarted, or when Smart Cruise Control was temporarily canceled.

Increasing set speed



- Push the + switch up and release it immediately. The set speed will increase by 1 mph (1 km/h) each time the switch is operated in this manner.
- Push the + switch up and hold it while monitoring the set speed on the instrument cluster. The set speed will increase by 5 mph (10 km/h) each time the switch is operated in this manner. Release the switch when the desired speed is shown, and the vehicle will accelerate to that speed. You can increase the set speed to 110 mph (180 km/h).

WARNING

Check the driving condition before using the + switch. Driving speed may sharply increase when you push up and hold the + switch.

Information

The driving speed may not reach the set speed depending on the vehicle characteristics and driving conditions.

Decreasing set speed

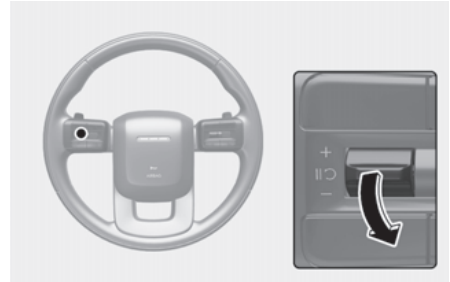

- Push the - switch down and release it immediately. The set speed will decrease by 1 mph (1 km/h) each time the switch is operated in this manner.
- Push the - switch down and hold it while monitoring the set speed on the cluster. The set speed will decrease by 5 mph (10 km/h) each time the switch is operated in this manner. Release the switch at the speed you want to maintain. You can decrease the set speed to 20 mph (30 km/h).

Temporarily canceling Smart Cruise Control

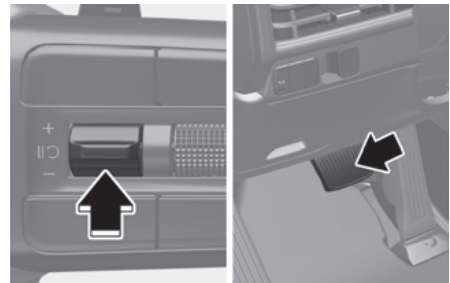

Press the  switch or depress the brake pedal to temporarily cancel Smart Cruise Control.

Resuming Smart Cruise Control

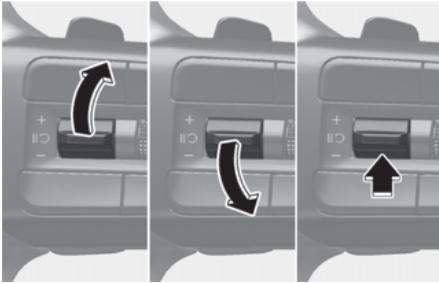

To resume Smart Cruise Control after the function was canceled, operate the +, - or **SCC** switch.

If you push the + switch up or - switch down, vehicle speed will be set to the current speed on the instrument cluster.

If you press the **SCC** switch, vehicle speed will resume to the preset speed.

WARNING

Check the driving condition before using the **SCC** switch. Driving speed may sharply increase or decrease when you press the **SCC** switch.

Turning off Smart Cruise Control

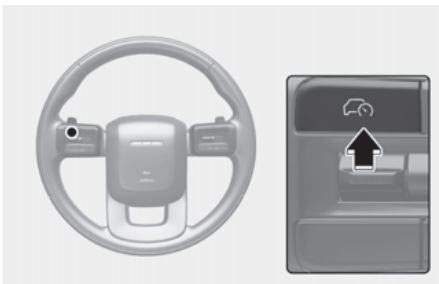

To turn Smart Cruise Control off, press the Driving Assist () button.

Information

If your vehicle is equipped with Manual Speed Limit Assist, press and hold the Driving Assist () button to turn off Smart Cruise Control. However Manual Speed Limit Assist will turn on.

WARNING

Do not use the switches and buttons at the same time. Smart Cruise Control may not operate properly.

Display and Control

Basic function

You can see the status of the Smart Cruise Control operation in the Driving Assist view on the instrument cluster. For more information, refer to the "View modes" section in chapter 4.

Smart Cruise Control will be displayed as below depending on the status of the function.

Operating



Temporarily cancelled



- When operating
 - (1) Whether there is a vehicle ahead and the selected distance level
 - (2) Set speed
 - (3) Whether there is a vehicle ahead and the target vehicle distance
- When temporarily cancelled
 - (1) Your vehicle (gray)
 - (2) Previous set speed (gray)
 - (3) Whether there is a vehicle ahead (gray) (if equipped)

i Information

- The distance of the front vehicle on the instrument cluster is displayed based on the actual distance between your vehicle and the vehicle ahead.
- The target distance may vary according to the vehicle speed and the set distance level. If the vehicle speed is low, even though the vehicle distance have changed, the change of the target vehicle distance may be small.
- The images and colors in the instrument cluster may differ depending on the instrument cluster type or theme selected in the infotainment system.

Accelerating temporarily



If you want to speed up temporarily without altering the set speed while Smart Cruise Control is operating, depress the accelerator pedal. While the accelerator pedal is depressed, the set speed, distance level and target distance will blink on the instrument cluster.

However, if the accelerator pedal is depressed insufficiently, the vehicle may decelerate.

⚠ WARNING

Be careful when accelerating temporarily, because the speed and distance is not controlled automatically even if there is a vehicle in front of you.

Based on Driving Style operation

+ if equipped



When Based on driving style is operating, the vehicle distance level and target distance will be displayed white based on the driving style.

Temporarily canceling Smart Cruise Control

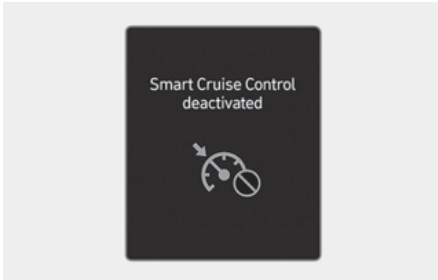

- The vehicle speed is above 120 mph (180 km/h)
- The vehicle is stopped for a certain period of time
- The accelerator pedal is continuously depressed for a certain period of time
- The conditions for the Smart Cruise Control to operate is not satisfied

If Smart Cruise Control is temporarily canceled automatically, the "**Smart Cruise Control deactivated**" warning message will appear on the instrument cluster, and an audible warning will sound to warn the driver.

i Information

If Smart Cruise Control is temporarily canceled while the vehicle is at a standstill with the function activated, EPB (Electronic Parking Brake) maybe applied.

! WARNING

When Smart Cruise Control is temporarily canceled, distance with the front vehicle will not be maintained. Always have your eyes on the road while driving, and if necessary, depress the brake pedal to reduce your driving speed in order to maintain a safe distance.

Smart Cruise Control conditions not satisfied

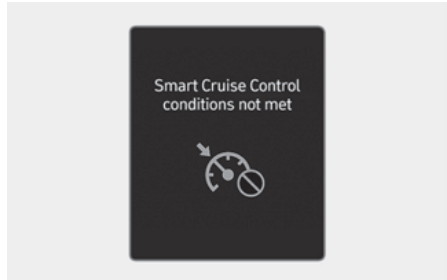

If the Driving Assist button, + switch, - switch or II⊙ switch is operated when Smart Cruise Control operating conditions are not satisfied, the "**Smart Cruise Ctrl. conditions not met**" will appear on the instrument cluster, and an audible warning will sound.

In traffic situation

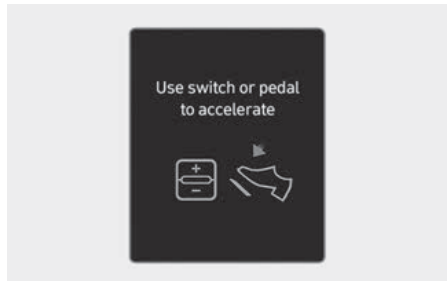

In traffic, your vehicle will stop if the vehicle ahead of you stops. Also, if the vehicle ahead of you starts moving, your vehicle will start as well. In addition, after the vehicle has stopped and a certain time have passed, the "**Use switch or pedal to accelerate**" message will appear on the instrument cluster. Depress the accelerator pedal or operate the + switch, - switch or II⊙ switch to start driving.

Warning road conditions ahead



In the following situation, the "**Watch for surrounding vehicles**" warning message will appear on the instrument cluster, and an audible warning will sound to warn the driver of road conditions ahead.

- The vehicle in front disappears when Smart Cruise Control is maintaining the distance with the vehicle ahead while driving below a certain speed.

WARNING

Always pay attention to vehicles or objects that may suddenly appear in front of you, and if necessary, depress the brake pedal to reduce your driving speed in order to maintain a safe distance.

Collision Warning



While Smart Cruise Control is operating, when the collision risk with the vehicle ahead is high, the "**Collision Warning**" warning message will appear on the instrument cluster, an audible warning will sound, and the steering wheel will vibrate to warn the driver. Always have your eyes on the road while driving, and if necessary, depress the brake pedal to reduce your driving speed in order to maintain a safe distance.

WARNING

In the following situations, Smart Cruise Control may not warn the driver of a collision.

- The distance from the front vehicle is near, or the vehicle speed of the front vehicle is faster or similar with your vehicle
- The speed of the front vehicle is very slow or is at a standstill
- The accelerator pedal is depressed right after Smart Cruise Control is turned on



WARNING

Take the following precautions when using Smart Cruise Control:

- Smart Cruise Control does not substitute for proper and safe driving. It is the responsibility of the driver to always check the speed and distance to the vehicle ahead.
 - Smart Cruise Control may not recognize unexpected and sudden situations or complex driving situations, so always pay attention to driving conditions and control your vehicle speed.
 - Keep Smart Cruise Control off when the function is not in use to avoid inadvertently setting a speed.
 - Do not open the door or leave the vehicle when Smart Cruise Control is operating, even if the vehicle is stopped.
 - Always be aware of the selected speed and headway distance.
 - Keep a safe distance according to road conditions and vehicle speed. If the headway distance is too close during high-speed driving, a serious collision may result.
 - When maintaining distance with the vehicle ahead, if the front vehicle disappears, Smart Cruise Control may suddenly accelerate to the set speed. Always be aware of unexpected and sudden situations from occurring.
 - Vehicle speed may decrease on an upward slope and increase on a downward slope.
 - Always be aware of situations such as when a vehicle cuts in suddenly.
 - When you are towing a trailer or another vehicle, turn off Smart Cruise Control for safety reasons.
 - Turn off Smart Cruise Control when your vehicle is being towed.
 - Smart Cruise Control may not operate properly if interfered by strong electromagnetic waves.
 - Smart Cruise Control may not detect an obstacle in front and lead to a collision. Always look ahead cautiously to prevent unexpected and sudden situations from occurring.
 - Vehicles moving in front of you with a frequent lane change may cause a delay in Smart Cruise Control reaction or may cause Smart Cruise Control to react to a vehicle actually in an adjacent lane. Always drive cautiously to prevent unexpected and sudden situations from occurring.
 - Always be aware of the surroundings and drive safely, even though a warning message does not appear or an audible warning does not sound.
 - If any other system's warning message is displayed or warning sound is generated, Smart Cruise Control warning message may not be displayed and warning sound may not be generated.
 - You may not hear the warning sound of Forward Collision-Avoidance Assist if the surrounding is noisy.
 - The vehicle manufacturer is not responsible for any traffic violation or crashes caused by the driver.
 - Always set the vehicle speed under the speed limit in your area.
-

CAUTION

- The vehicle must be driven sufficiently to reflect the actual driving style of the driver, such as inter-vehicle distance, acceleration and reaction speed.
- If you are driving in special conditions, such as snow, rain, fog or steep slopes, the vehicle may not be driven according to the driver's driving style.

Information

- Smart Cruise Control may not operate for few seconds after the vehicle is started or the front view camera or front radar is initialized.
- You may hear a sound when the brake is controlled by Smart Cruise Control.

Smart Cruise Control Malfunction and Limitations

Smart Cruise Control malfunction

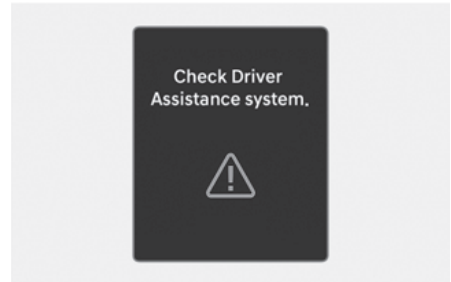

When Smart Cruise Control is not working properly, the "**Check Driver Assistance system.**" warning message will appear, and the "" warning light will illuminate on the instrument cluster. Have your vehicle inspected by an authorized HYUNDAI dealer.

Smart Cruise Control disabled

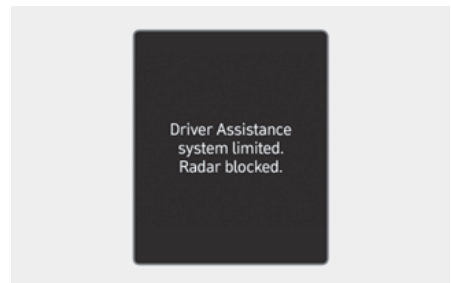

When the front radar cover or sensor is covered with snow, rain, or foreign material, it can reduce the detecting performance and temporarily limit or disable Smart Cruise Control.

If this occurs the "**Driver Assistance system limited. Radar blocked.**" warning message will appear for a certain period of time on the instrument cluster.

Smart Cruise Control will operate properly when snow, rain or foreign material is removed.

WARNING

Even though the warning message does not appear on the instrument cluster, Smart Cruise Control may not properly operate.

CAUTION

Smart Cruise Control may not properly operate in an area (for example, open terrain), where there is nothing to detect after turning ON the vehicle.

Limitations of Smart Cruise Control

Smart Cruise Control may not operate properly, or it may operate unexpectedly under the following circumstances:

- The detecting sensor or the surroundings are contaminated or damaged
- Washer fluid is continuously sprayed, or the wiper is on
- The camera lens is contaminated due to tinted, filmed or coated windshield, damaged glass, or sticky foreign material (sticker, bug, etc.) on the glass
- Moisture is not removed or frozen on the windshield
- The field of view of the front view camera is obstructed by sun glare
- Street light or light from an oncoming vehicle is reflected on the wet road surface, such as a puddle on the road
- The temperature around the front view camera is high or low
- An object is placed on the dashboard
- The surrounding is very bright
- The surrounding is very dark, such as in a tunnel, etc.
- The brightness changes suddenly, for example when entering or exiting a tunnel
- The brightness outside is low, and the headlights are not on or are not bright
- Driving in heavy rain or snow, or thick fog
- Driving through steam, smoke or shadow
- Only part of the vehicle is detected
- The vehicle in front has no tail lights, tail lights are located unusually, etc.
- The brightness outside is low, and the tail lights are not on or are not bright
- The rear of the front vehicle is small or does not look normal (for example, tilted, overturned, etc.)
- The front vehicle's ground clearance is low or high
- A vehicle suddenly cuts in front
- Your vehicle is being towed
- Driving through a tunnel or iron bridge
- Driving near areas containing metal substances, such as a construction zone, railroad, etc.

- An object reflecting off the front radar such as a guardrail, nearby vehicle, etc.
- The bumper around the front radar is impacted, damaged or the front radar is out of position
- The temperature around the front radar is high or low
- Driving in vast areas where there are few vehicles or structures (for example, desert, meadow, suburb, etc.)
- The vehicle in front is made of material that does not reflect on the front radar
- Driving near a highway interchange or tollbooth
- Driving on a slippery surface due to snow, water puddle, ice, etc.
- Driving on a curved road
- The vehicle in front is detected late
- The vehicle in front is suddenly blocked by an obstacle
- The vehicle in front suddenly changes lane or suddenly reduces speed
- The vehicle in front is bent out of shape
- The front vehicle's speed is fast or slow
- With a vehicle in front, your vehicle changes lane at low speed
- The vehicle in front is covered with snow
- Unstable driving
- You are on a roundabout and the vehicle in front is not detected
- You are continuously driving in a circle
- Driving in a parking lot
- Driving through a construction area, unpaved road, partial paved road, uneven road, speed bumps, etc.
- Driving on an incline road, curved road, etc.
- Driving through a roadside with trees or streetlights
- The adverse road conditions cause excessive vehicle vibrations while driving
- Your vehicle height is low or high due to heavy loads, abnormal tire pressure, etc.
- Driving through a narrow road where trees or grass are overgrown
- There is interference by electromagnetic waves, such as driving in an area with strong radio waves or electrical noise

- **Driving on a curved road**



On curves, Smart Cruise Control may not detect a vehicle in the same lane, and may accelerate to the set speed. Also, vehicle speed may rapidly decrease when the vehicle ahead is detected suddenly.

Select the appropriate set speed on curves and apply the brake pedal or accelerator pedal according to the road and driving conditions ahead.



Your vehicle speed can be reduced due to a vehicle in the adjacent lane.

Apply the accelerator pedal and select the appropriate set speed. Check to be sure that the road conditions permit safe operation of the Smart Cruise Control.

- **Driving on an inclined road**



During uphill or downhill driving, the Smart Cruise Control may not detect a moving vehicle in your lane, and cause your vehicle to accelerate to the set speed. Also, vehicle speed will rapidly decrease when the vehicle ahead is detected suddenly.

Select the appropriate set speed on inclines and apply the brake pedal or accelerator pedal according to the road and driving conditions ahead.

- Changing lanes



[A] Your vehicle

[B] Lane changing vehicle

When a vehicle moves into your lane from an adjacent lane, it cannot be detected by the sensor until it is in the sensor's detection range. Smart Cruise Control may not immediately detect the vehicle when the vehicle changes lanes abruptly. In this case, you must maintain a safe braking distance, and if necessary, depress the brake pedal to reduce your driving speed in order to maintain a safe distance.

- Situations when detecting are limited

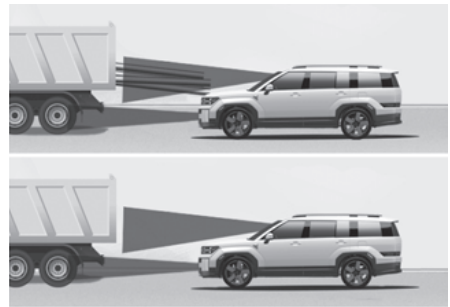
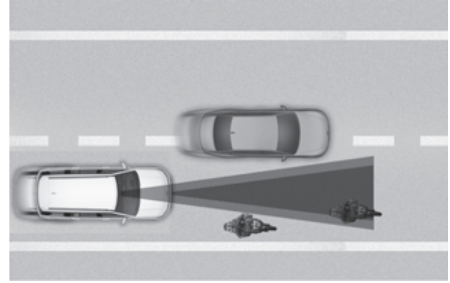

In the following cases, some vehicles, pedestrians or animals in your lane cannot be detected by the sensor:

- Vehicles offset to one side
- Slow-moving vehicles or sudden decelerating vehicles
- Vehicles with higher ground clearance or vehicles carrying loads that stick out of the back of the vehicle
- Vehicles that has the front lifted due to heavy loads
- Vehicles within about 6 ft. (2 m) from your vehicle
- Oncoming vehicles
- Stopped vehicles

- Vehicles with small rear profile, such as trailers
- Narrow vehicles, such as motorcycles or bicycles
- Special vehicles
- Animals and pedestrians
- Adjust your vehicle speed by depressing the brake pedal according to the road and driving conditions ahead.
- In the following cases, the vehicle in front cannot be detected by the sensor:
 - You are steering your vehicle
 - Driving on narrow or sharply curved roads
- When a vehicle ahead disappears at an intersection, your vehicle may accelerate.
Always pay attention to road and driving conditions while driving.

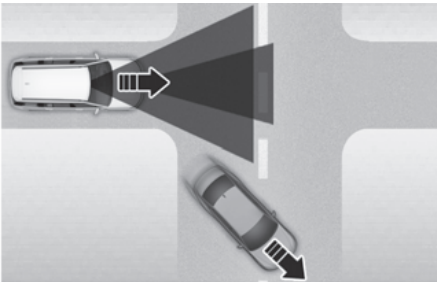

- When a vehicle in front of you merges out of the lane, Smart Cruise Control may not immediately detect the new vehicle that is now in front of you.
Always pay attention to road and driving conditions while driving.

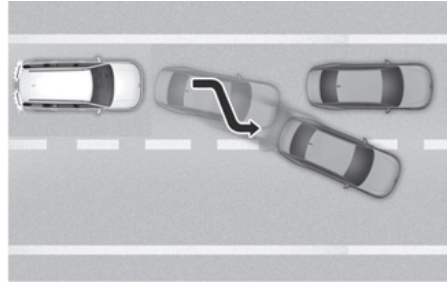

- Always look out for pedestrians when your vehicle is maintaining a distance with the vehicle ahead.

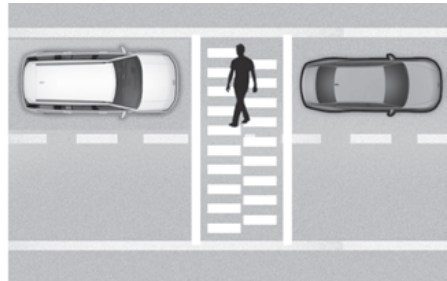

Emergency Stop (ES)

 if equipped

If Emergency Stop judges the driver is unresponsive, the function helps stop your vehicle within the driving lane by centering the vehicle in the lane and assisting in braking.

i Information

Emergency Stop uses the following sensors:

- Front view camera
- Front radar

Refer to the "Driver Assistance System Sensors" section in this chapter for the location.

Emergency Stop operation

Operating conditions

Emergency Stop operates if all the following conditions are met:

- Smart Cruise Control is on.
- Lane Following Assist is on.
- The function judges you are unresponsive.

The function judges you are unresponsive if:

- You do not have your hands on the steering wheel after the hands-off warning is continuously displayed.
- Your eyes are not focused on the road after inattentive driving warning is continuously displayed (if equipped).

i Information

- Emergency Stop also works together with Navigation-based Smart Cruise Control (NSCC) and Highway Driving Assist (HDA).
- For more information and limitations of the Smart Cruise Control, refer to the "Smart Cruise Control (SCC)" section in this chapter.
- For more information and limitations of the Lane Following Assist, refer to the "Lane Following Assist (LFA)" section in this chapter.

Emergency stopping

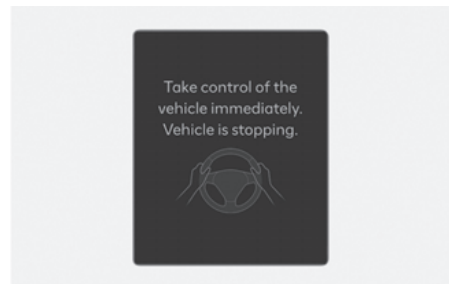

To warn you that Emergency Stop is operating the "**Take control of the vehicle immediately. Vehicle is stopping.**" warning message appears on the instrument cluster, an audible warning sounds, and the steering wheel vibrates.

Emergency Stop provides steering and braking assist to stop the vehicle within the driving lane.

i Information

When Emergency Stop is operating, the vehicle distance setting of Smart Cruise Control is changed to Distance 4. The vehicle distance setting is set to the last distance setting after Emergency Stop is deactivated.

After stopping

After the vehicle is stopped by Emergency Stop, a warning message appears on the instrument cluster, an audible warning sounds, and the hazard warning flasher blinks. After your vehicle has stopped, the following is performed:

- Doors are unlocked.
- SOS call is made. (if served)
- EPB (Electronic Parking Brake) is applied.

Deactivating Emergency Stop



If the function judges you have responded, Emergency Stop is deactivated when one of the following condition is met:

- You are focused on the road and the steering wheel is controlled.
- You strongly and continuously depress the accelerator pedal.
- You strongly depress the brake pedal.
- You press the Lane Driving Assist button (/⊕\).
- You press the Driving Assist button (↶↷).
- You press the hazard warning flasher button after your vehicle has stopped.
- The front door is opened.

i Information

The vehicle needs to be restarted to reactivate Smart Cruise Control after the vehicle is stopped and Emergency Stop is deactivated.

CAUTION

Smart Cruise Control operation is limited if the in-cabin camera is unable to detect your face.

Emergency Stop malfunction and limitations

Emergency Stop malfunction

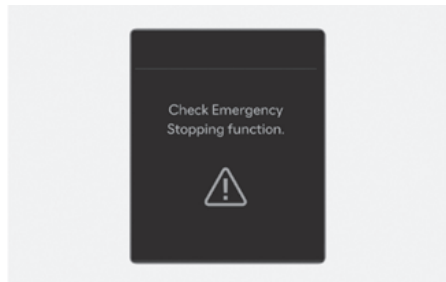

When Emergency Stop is not working properly, the "**Check Emergency Stopping function.**" warning message appears, and the master (△) warning light illuminates on the instrument cluster. If this occurs, have your vehicle inspected by an authorized HYUNDAI dealer.

Limitations of Emergency Stop

For more information on the limitations of Emergency Stop, refer to the "Smart Cruise Control (SCC)" and "Lane Following Assist (LFA)" sections in this chapter.

Navigation-based Smart Cruise Control (NSCC)

 if equipped

Navigation-based Smart Cruise Control can help drive at a certain speed according to the road conditions when driving on highways by using road information from the navigation system while Smart Cruise Control is operating.

i Information

- Navigation-based Smart Cruise Control is available only on controlled access roads.
 - Controlled access roads are roads with limited entrances and exits that allow uninterrupted high speed traffic flow.

Available highway (Controlled access road)

USA	Select Interstate Highway and U.S. (Federal) and State Highways
Canada	Select Provincial and Territorial Highways

- Additional highways may be available in future navigation system updates.
- Navigation-based Smart Cruise Control does not operate on interchanges or junctions.

Highway Auto Curve Slowdown

If vehicle speed is high, Highway Auto Curve Slowdown function will temporarily decelerate your vehicle or limit acceleration to help you drive safely on a curve based on the curve information from the navigation.

Navigation-based Smart Cruise Control Settings

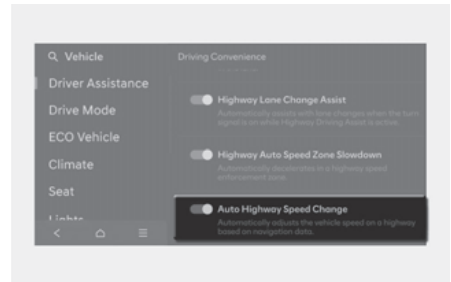

With the engine on, select **Setup** > **Vehicle** > **Driver Assistance** > **Driving Convenience** > **Highway Auto Speed Change** from the infotainment system to turn on Navigation based Smart Cruise Control and deselect to turn off the function.

i Information

When there is a problem with Navigation-based Smart Cruise Control, the function cannot be set in the infotainment system.

Navigation-based Smart Cruise Control Operation

Operating conditions

Navigation-based Smart Cruise Control is ready to operate if all of the following conditions are satisfied:

- Select "**Highway Auto Speed Change**" from the infotainment system.
- Smart Cruise Control is operating
- Driving on main roads of highways

i Information

For more information on how to operate Smart Cruise Control, refer to the "Smart Cruise Control (SCC)" section in this chapter.

Navigation-based Smart Cruise Control display and control

When Navigation-based Smart Cruise Control operates, it will be displayed on the instrument cluster as follows:



Navigation-based Smart Cruise Control standby

If the operating conditions are satisfied, the green **NAV** indicator light illuminates.

Navigation-based Smart Cruise Control operating

While the speed is being controlled, the green **NAV** indicator light blinks.

Temporarily canceled or interrupted by the driver

If Navigation-based Smart Cruise Control cannot control the vehicle, such as when Smart Cruise Control is temporarily canceled or the navigation system is searching for a route, the gray **NAV** indicator light illuminates.

When the driver depresses the accelerator pedal, the white **NAV** indicator light blinks.

! WARNING



"**Drive carefully**" warning message will appear in the following circumstances:

- Navigation-based Smart Cruise Control is not able to slow down your vehicle to a safe speed

i Information

The images and colors in the instrument cluster may differ depending on the instrument cluster type or theme selected from the infotainment system.

Highway Curve Zone Auto Slowdown

- Depending on the curve ahead on the highway, the vehicle will decelerate, and after passing the curve, the vehicle will accelerate to Smart Cruise Control set speed.
- Vehicle deceleration time may differ depending on the vehicle speed and the degree of the curve on the road. The higher the driving speed, deceleration will start faster.

Limitations of Navigation-based Smart Cruise Control

Navigation-based Smart Cruise Control may not operate properly under the following circumstances:

- The navigation is not working properly
- Map information is not transmitted due to infotainment system's abnormal operation
- Speed limit and road information in the navigation is not updated
- The map information and the actual road is different because of real-time GPS data or map information error
- The navigation searches for a route while driving
- GPS signals are blocked in areas such as a tunnel
- A road that divides into two or more roads and joins again
- The driver goes off course from the route set in the navigation
- The route to the destination is changed or cancelled by resetting the navigation
- The vehicle enters a service station or rest area
- Android Auto or Car Play is operating
- The navigation cannot detect the current vehicle position (for example, elevated roads including overpass adjacent to general roads or nearby roads exist in a parallel way)
- The navigation is being updated while driving
- The navigation is being restarted while driving
- The speed limit of some sections changes according to the road situations
- Driving on a road under construction
- Driving in lane-restricted driving situations

- There is bad weather, such as heavy rain, heavy snow, etc.
- Driving on a road that is sharply curved

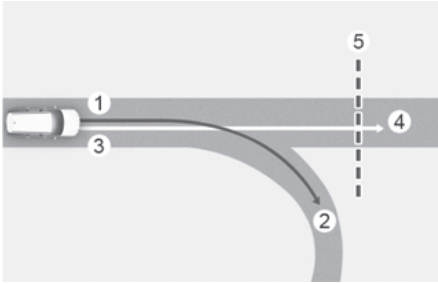

- (1) Set route
- (2) Branch line
- (3) Driving route
- (4) Main road
- (5) Curved road section

- When there is a difference between the navigation set route (branch line) and the driving route (main road), Highway Curve Zone Auto Slowdown function may not operate until the driving route is recognized as the main road.

- When the vehicle's driving route is recognized as the main road by maintaining the main road instead of the navigation set route, Highway Curve Zone Auto Slowdown function will operate. Depending on the distance to the curve and the current vehicle speed, vehicle deceleration may not be sufficient or may decelerate rapidly.

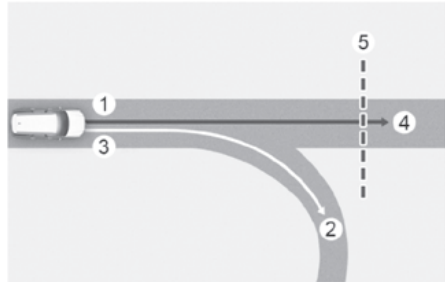

- (1) Set route
- (2) Branch line
- (3) Driving route
- (4) Main road
- (5) Curved road section

- When there is a difference between the navigation route (main road) and the driving route (branch line), Highway Curve Zone Auto Slowdown function will operate based on the curve information on the main road.

- When it is judged that you are driving out of the route by entering the highway interchange or junction, Highway Curve Zone Auto Slowdown function will not operate.

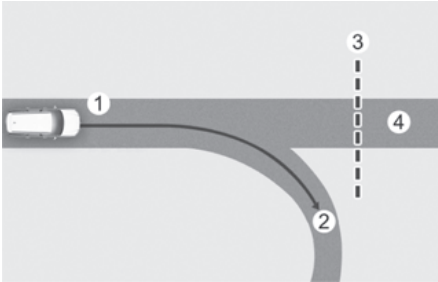

(1) Driving route

(2) Branch line

(3) Curved road section

(4) Main road

- If there is no destination set on the navigation, Highway Curve Zone Auto Slowdown function will operate based on the curve information on the main road.
- Even if you depart from the main road, Highway Curve Zone Auto Slowdown function may temporarily operate due to navigation information of the highway curve section.

WARNING

- Navigation-based Smart Cruise Control is not a substitute for safe driving practices, but a convenience function. Always have your eyes on the road, and it is the responsibility of the driver to avoid violating traffic laws.
- The navigation's speed limit information may differ from the actual speed limit information on the road. It is the driver's responsibility to check the speed limit on the actual driving road or lane.
- Navigation-based Smart Cruise Control will automatically be canceled when you leave the highway main road. Always pay attention to road and driving conditions while driving.
- Navigation-based Smart Cruise Control may not operate due to the existence of leading vehicles and the driving conditions of the vehicle. Always pay attention to road and driving conditions while driving.
- When you are towing a trailer or another vehicle, turn off Navigation-based Smart Cruise Control for safety reasons.
- After you pass through a tollbooth on a highway, Navigation-based Smart Cruise Control will operate based on the first lane. If you enter one of the other lanes, Navigation-based Smart Cruise Control might not operate properly.

- The vehicle will accelerate if the driver depresses the accelerator pedal while Navigation-based Smart Cruise Control is operating, and the function will not decelerate the vehicle. However, if the accelerator pedal is depressed insufficiently, the vehicle may decelerate.
 - If the driver accelerates and releases the accelerator pedal while Navigation-based Smart Cruise Control is operating, the vehicle may not decelerate sufficiently or may rapidly decelerate to a safe speed.
 - If the curve is too large or too small, Navigation-based Smart Cruise Control may not operate.
-

i Information

- A time gap could occur between the navigation's guidance and when Navigation-based Smart Cruise Control operation starts and ends.
 - The speed information on the instrument cluster and navigation may differ.
 - Even if you are driving at a speed lower than Smart Cruise Control set speed, acceleration may be limited by the curve sections ahead.
 - If Navigation-based Smart Cruise Control is operating while leaving the main road to enter an interchange, junction, rest area, etc., the function may operate for a certain period of time.
 - Deceleration by Navigation-based Smart Cruise Control may feel it is not sufficient due to road conditions such as uneven road surfaces, narrow lanes, etc.
-

Lane Following Assist (LFA)

Lane Following Assist helps detect lane markings and/or a vehicle ahead on the road, and helps center your vehicle in the lane.

i Information

Lane Following Assist uses the following sensor:

- Front view camera

Refer to the "Driver Assistance System Sensors" section in this chapter for the location.

Lane Following Assist Settings

! CAUTION

When the vehicle and the trailer are connected electrically, a warning message appears on the instrument cluster, and Lane Following Assist is deactivated. The function resumes after the trailer connector is disconnected. (When using HYUNDAI genuine parts)

i Information

You can set the following Warning Methods:

- Warning Volume/Driving Safety Priority

For more information, refer to the "Driver assistance system settings" section in this chapter.

Lane Following Assist Operation

Turning Lane Following Assist On/Off

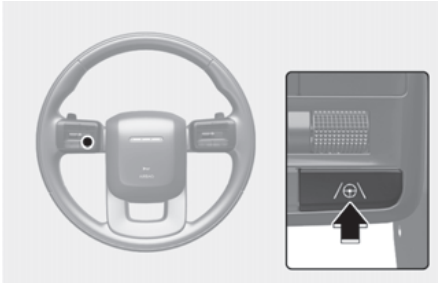

With the engine on, shortly press the Lane Driving Assist button located on the steering wheel to turn on Lane Following Assist. The gray or green (⊕) indicator light will illuminate on the instrument cluster.

Press the button again to turn off the function.

Lane Following Assist



If the vehicle ahead and/or both lane markings are detected and your vehicle speed is below 110 mph (180 km/h), the green (⊕) indicator appears on the cluster, and Lane Following Assist helps center the vehicle in the lane by assisting the steering wheel.

CAUTION

When the steering wheel is not assisted, the white (⊕) indicator light blinks and changes to gray.

Hands-off warning

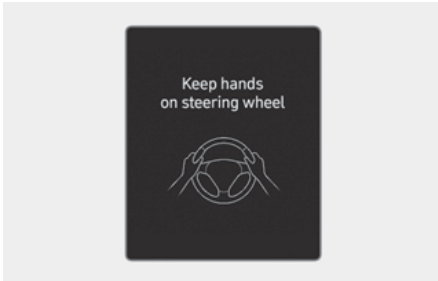

If the driver takes their hands off the steering wheel for several seconds, the "**Keep hands on steering wheel**" warning message will appear and an audible warning will sound in stages.

First stage: Warning message

Second stage: Warning message (red steering wheel) with a warning sound

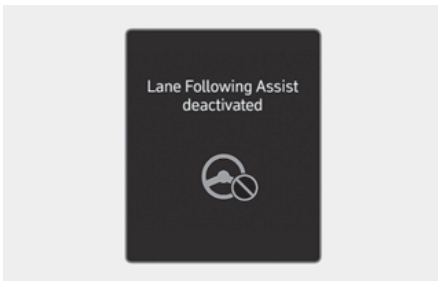

If the driver still does not have their hands on the steering wheel after the hands-off warning, the "**Lane Following Assist deactivated**" warning message will appear and Lane Following Assist will be automatically canceled.

WARNING

- The steering wheel may not be assisted if the steering wheel is held very tight or the steering wheel is steered over a certain degree.
 - Lane Following Assist does not operate at all times. It is the responsibility of the driver to safely steer the vehicle and to maintain the vehicle in its lane.
 - The hands-off warning message may appear late depending on road conditions. Always have your hands on the steering wheel while driving.
 - If the steering wheel is held very lightly the hands-off warning message may appear because Lane Following Assist may not recognize that the driver has their hands on the steering wheel.
 - If you attach objects to the steering wheel, the hands-off warning may not work properly.
 - Driving stability may decrease when the vehicle is overloaded or the weight distribution is uneven. This may degrade the Lane Keeping Assist performance.
-

i Information

- For more information on instrument cluster settings, refer to the "Cluster display control" section in chapter 4.
- When both lane markings are detected, the lane lines on the instrument cluster will change from gray to white.

Lane undetected



Lane detected



- If lane markings are not detected, steering wheel control by Lane Following Assist can be limited depending on whether a vehicle is in front or the driving conditions of the vehicle.
 - Even though the steering is assisted by Lane Following Assist, the driver may control the steering wheel.
 - The steering wheel may feel heavier or lighter when the steering wheel is assisted by Lane Following Assist than when it is not.
-
- The images and colors in the instrument cluster may differ depending on the cluster type or theme selected in the infotainment system.

Lane Following Assist Malfunction and Limitations

Lane Following Assist malfunction

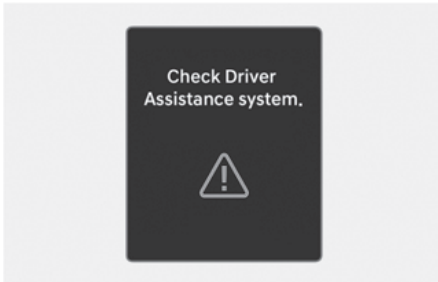

When Lane Following Assist is not working properly, the "**Check Driver Assistance system.**" warning message will appear on the instrument cluster for several seconds, and the master (⚠️) warning light appears on the instrument cluster. If this occurs, have your vehicle inspected by an authorized HYUNDAI dealer.

Limitations of Lane Following Assist

For more information on Lane Following Assist limitations, refer to the "Lane Keeping Assist (LKA)" section in this chapter.

Highway Driving Assist (HDA)

if equipped

Highway Driving Assist

Highway Driving Assist helps maintain a set distance and speed from the vehicle ahead while driving on a highway main section and helps center the vehicle in the lane.

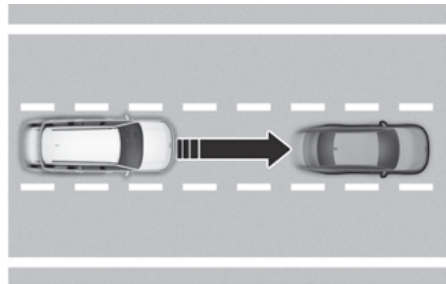

Highway Lane Change Assist

+ if equipped

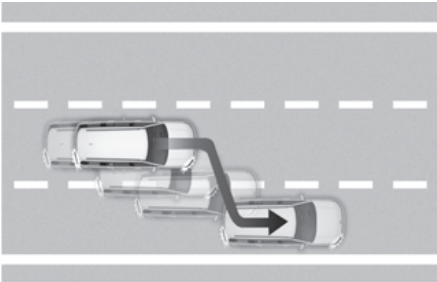

Highway Lane Change Assist function helps change lanes to the direction the driver slightly moves the turn signal switch if the function judges that lane change is possible.

i Information

- Highway Driving Assist is available only on controlled access roads.
 - Controlled access roads are roads with limited entrances and exits that allow uninterrupted high speed traffic flow.

Available highway (Controlled access road)

USA	Select Interstate Highway and U.S. (Federal) and State Highways
Canada	Select Provincial and Territorial Highways

- Additional highways may be available in future navigation system updates.
- Highway Driving Assist does not operate on interchanges or junctions.

i Information

Highway Driving Assist uses the following sensors:

- Front view camera
- Front radar
- Front corner radar (if equipped)
- Rear corner radar (if equipped)

Refer to the "Driver Assistance System Sensors" section in this chapter for the location.

Highway Driving Assist settings

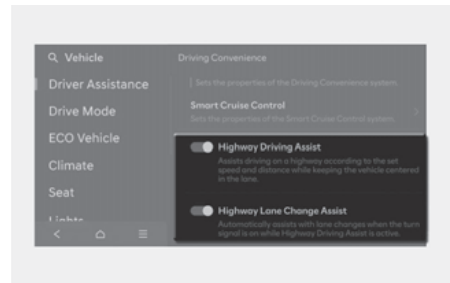

With the engine on, select or deselect **Setup > Vehicle > Driver Assistance > Driving Convenience > Highway Driving Assist** from the infotainment system to set whether to use each function.

Basic function

If **Highway Driving Assist** is selected, it helps maintain distance from the vehicle ahead, maintain the set speed, and helps center the vehicle in the lane.

Highway Lane Change Assist

 if equipped

If **Highway Lane Change Assist** is selected, it helps the driver change lanes.

i Information

- When **Highway Driving Assist** is deselected, the setting for Highway Lane Change Assist cannot be changed.
- If there is a problem with the functions, the settings cannot be changed. Have the vehicle inspected by an authorized HYUNDAI dealer.
- If the vehicle is restarted, the functions will maintain the last setting.

i Information

For your safety, only change the settings after parking the vehicle at a safe location.

CAUTION

When the vehicle and the trailer are connected electrically, a warning message appears on the instrument cluster, and Highway Driving Assist is deactivated. The function resumes after the trailer connector is disconnected. (When using HYUNDAI genuine parts)

i Information

You can set the following Warning Methods:

- Warning Volume/Driving Safety Priority
- For more information, refer to the "Driver assistance system settings" section in this chapter.

Highway Driving Assist Operation

Basic function

Displaying operating status

You can see the status of the Highway Driving Assist operation in the Driving Assist view on the instrument cluster. For more information, refer to the "View modes" section in chapter 4.

Highway Driving Assist will be displayed as below depending on the status of the function.

Operating state



Standby state



1. Highway Driving Assist indicator, whether there is a vehicle ahead and the selected distance level are displayed.
 - Highway Driving Assist indicator (HDA)
 - Green HDA: Operating state
 - Gray HDA: Standby state
 - White HDA blink: Accelerator depressed state
 - Not displayed : Off
2. Set speed
3. Lane Following Assist indicator
4. Whether there is a vehicle ahead and the selected headway
5. Whether the lane is detected or not

i Information

- For more information on the display refer to the "Smart Cruise Control (SCC)" and "Lane Following Assist (LFA)" sections in this chapter.
- The images and colors in the instrument cluster may differ depending on the instrument cluster type or theme selected from infotainment system.

Highway Driving Assist operation

Highway Driving Assist operates when:

- Driving on the main road of highways, and turning on Highway Driving Assist by pressing the Driving Assist button
- Entering the main road of highways while Lane Following assist and Smart Cruise Control are operating

Restarting after stopping

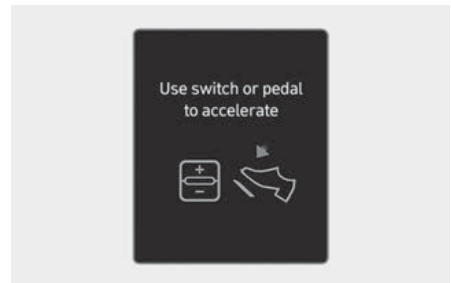

When Highway Driving Assist is operating, your vehicle will stop if the vehicle ahead of you stops. Also, if the vehicle ahead of you starts moving within 30 seconds after the stop, your vehicle will start as well. In addition, after the vehicle has stopped and 30 seconds have passed, the **"Use switch or pedal to accelerate"** message will appear on the instrument cluster. Depress the accelerator pedal or operate the + switch, - switch or  switch to start driving.

Hands-off warning

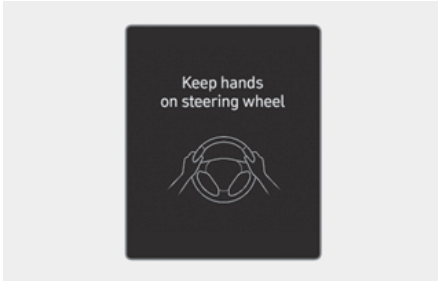

If the driver takes their hands off the steering wheel for several seconds, the **"Keep hands on steering wheel"** warning message will appear and an audible warning will sound in stages.

First stage: Warning message

Second stage: Warning message (red steering wheel) and audible warning

If the driver still does not have their hands on the steering wheel after the handsoff warning, Emergency Stop (ES) will operate. For more information, refer to the "Emergency Stop (ES)" section in this chapter.

Driving to one side within lane

 if equipped

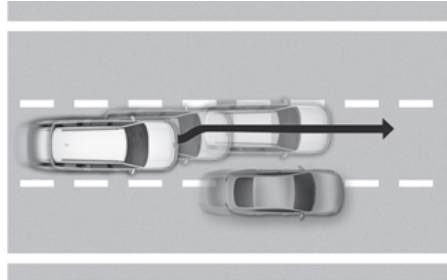

When vehicle speed is above 40 mph (60 km/h), if a vehicle around you is driving at a close distance, your vehicle will control steering in the opposite direction of the vehicle to assist in safe driving.

If there are detected vehicles on both sides of the lane that are driving close to you, your vehicle does not control steering in either direction.

Highway Driving Assist standby

When the Smart Cruise Control is temporarily canceled while Highway Driving Assist is operating, Highway Driving Assist will be in the standby state. At this time, Lane Following Assist will operate properly.

i Information

- Driving Speed Limit helps you drive below 40 mph (60 km/h). At this time, the vehicle decelerates due to the vehicle ahead. After the vehicle has decelerated, it cannot automatically accelerate.
- Driving Speed Limit will cancel in the following circumstances:
 - When the driver grabs the steering wheel again
 - When the driver turns on Lane Following Assist by pressing the Lane Driving Assist button (/⊕\)
 - When +, -, ||⊙ switch or  button is operated, or the accelerator pedal or the brake pedal is depressed

Highway Lane Change Assist

 if equipped

Displaying operating status

You can see the status of the Highway Lane Change Assist function operation in the Driving Assist view on the instrument cluster. For more information, refer to the "View modes" section in chapter 4.

Highway Lane Change Assist function will be displayed as below depending on the status of the function.





Ready/Operating



Standby/Canceled



1. Highway Lane Change Assist indicator

- Green  on : Ready state
- Green  blink : Operating state
- Grey  on : Standby state
- White  blink : Canceled state (display only a certain time)

2. Lane line

The lane line is displayed same as the Highway Lane Change Assist indicator (1). However, if the function is on standby, it displays whether the lane line is detected.

3. Green arrow and shade

The green arrow is displayed when a certain amount of time has passed after the function has started operating, and until the lane change has completed.

4. Message

- Message is displayed when the function does not operate even though the turn signal is used.
- Message is displayed when the function is canceled while operating.

Highway Lane Change Assist ready to operate

While Highway Lane Change Assist function is on, the function will be ready to operate when all the following conditions are satisfied:

- Highway Driving Assist is operating
- Lane Following Assist is operating
- A vehicle in the rear area of your vehicle is detected more than once after the vehicle is turned on
- Your vehicle speed is above 20 mph (30 km/h)
- When your vehicle is between 20-40 mph (30-60 km/h), a vehicle is detected in the rear area of your vehicle's left and right side lanes, and there is no risk of collision when changing a lane
- Hands-off warning is not displayed on the instrument cluster
- Hazard warning flasher is off

To turn on Highway Lane Change Assist

Highway Lane Change Assist function will turn on when the following conditions are satisfied.

- The Driving Assist button or Lane Driving Assist button is used to turn on Highway Driving Assist.

i Information

- While Lane Change Assist function is turned on (indicator on), Lane Following Assist will not cancel even if the turn signal indicator or hazard warning flasher is operating.
- Lane Change Assist function turns off automatically when driven in the following road conditions:
 - One driving lane
 - A road with no structure, such as a medium strip, guardrails, etc.
 - There is a pedestrian or cyclist on the road ahead
- When the function is in the ready state, and vehicle speed is below 15.5 mph (25 km/h), the function will change to the standby state.
- When your vehicle is between 20-40 mph (30-60 km/h), and a vehicle is not detected in the rear area of your vehicle's left and right side lanes, the function will change to the standby state.
- If there is a risk of collision, the function will change to the standby state.

! WARNING

When Highway Lane Change Assist function turns off while operating, steering assist will be temporarily canceled. Always be cautious while driving.

Highway Lane Change Assist operation

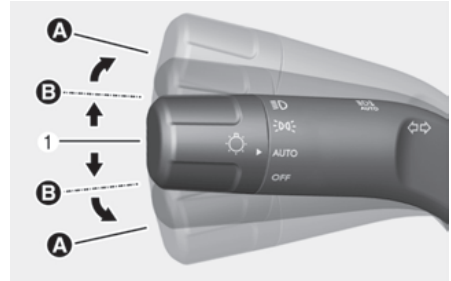

(1) Center

Highway Lane Change Assist function will operate, when you push the turn signal lever up or down to the A or B position while the function is in the ready state (↔↔ indicator is green), and all of the following conditions are satisfied:

- The driver has his/her hand on the steering wheel
- There is no collision risk in the direction of lane change
- There is a single dotted lane line in the direction of lane change
- There are no Forward Collision-Avoidance Assist and Blind Spot Collision-Avoidance Assist warnings
- The vehicle is driven in the middle of the lane (should not be driving close to one side of the lane)
- The road you are driving on, or the road you are about to change lane is a road that the function can operate

i Information

- Highway Lane Change Assist operates when the turn signal lever is positioned at A. If the turn signal lever is released to the center (1) before stepping on the lane, Highway Lane Change Assist cancels. If the turn signal lever is released to the center (1) after stepping on the lane, Highway Lane Change Assist changes the lane and turns off the turn signal after lane change is complete.
- When the turn signal lever is placed at B position for a certain period of time, the green arrow will appear. At this time, even when the lever is released and returns to its original position (1), lane change will still be assisted.

While lane change is being made by the function, the turn signal indicator will blink even when the turn signal lever is not held, and the turn signal indicator will turn off when lane change is complete.

Highway Lane Change Assist standby

Highway Lane Change Assist function will be in the standby state when one of the ready state condition is not satisfied, or when entering or driving on one of the following roads:

- Road within a certain distance from the tollbooth on the main road of the highway
- The road ahead ends without an interchange or junction
- Road with sharp curves
- Road with narrow lanes

Highway Lane Change Assist cancel

The function will be canceled when:

- The turn signal lever is moved to the "A" position while the Highway Lane Change Assist function is operating and placed in the center (1) before stepping on the lane line
- The turn signal lever is turned on in the opposite direction of lane change
- The steering wheel is steered sharply

 **WARNING**

- While Highway Driving Assist is operating, the function will cancel if one of the following occurs:
 - Highway Driving Assist is turned off
 - Lane Following Assist or Smart Cruise Control is turned off or temporarily canceled
 - Hands-off warning message is displayed on the instrument cluster
 - The hazard warning flasher is turned on
 - Forward Collision-Avoidance Assist or Blind-Spot Collision-Avoidance Assist warning message is displayed
 - Possible collision is detected in the next lane, even though there are no Forward Collision-Avoidance Assist and Blind-Spot Collision-Avoidance Assist warning
 - The target lane to make a lane change disappears
 - The target lane to make a lane change is not detected
 - There is a problem with turn signal lights
 - Highway Lane Change Assist function is off (The function turns off when the function is turned off from the settings menu, when the road changes to a one-way road, when there is a intersection or crosswalk ahead, when you enter a road with no structure, such as a medium strip, guardrail, etc., or when there is a pedestrian or cyclist on the driving lane.)
 - Your vehicle speed is below 15.5 mph (25 km/h)
 - When your vehicle is between 20-40 mph (30-60 km/h), and a vehicle is not detected in the rear area of your vehicle's left and right side lanes
 - If there is a risk of collision with a vehicle in the rear area of your vehicle
 - While the function is operating, when the function is canceled, depending on the driving conditions, the vehicle may drive to the middle of the driving lane or steering assist may stop. Always pay attention to road and driving conditions while driving.
 - The function may not operate properly on roads with pedestrians or cyclists, such as an intersection or crosswalk. Always pay attention to road and driving conditions while driving.
-

Highway Driving Assist Malfunction and Limitations

Highway Driving Assist malfunction

Type A

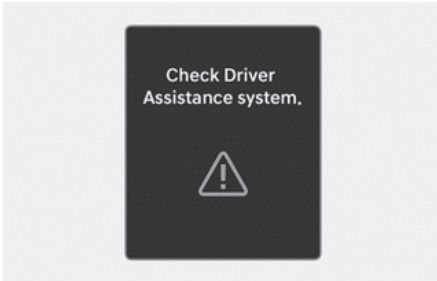

Type B

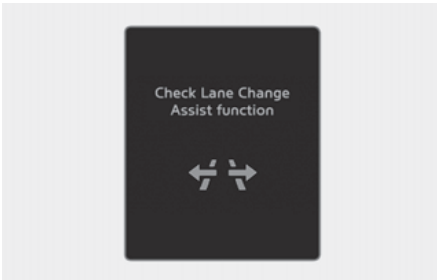

When Highway Driving Assist is not working properly, the "**Check Driver Assistance system.**" or "**Check Lane Change Assist function**" warning message and Master (⚠) warning light appears on the instrument cluster. If this occurs, have your vehicle inspected by an authorized HYUNDAI dealer.

WARNING

- The driver is responsible for controlling the vehicle and safe driving.
- Always have your hands on the steering wheel while driving.
- Highway Driving Assist is a supplemental function that assists the driver in driving the vehicle and is not a complete autonomous driving system. Always check road conditions, and if necessary, take appropriate actions to drive safely.
- Always have your eyes on the road, and it is the responsibility of the driver to avoid violating traffic laws. The vehicle manufacturer is not responsible for any traffic violation or crashes caused by the driver.
- Highway Driving Assist may not be able to recognize all traffic situations. Highway Driving Assist may not detect possible collisions due to limitations of the function. Always be aware of the limitations of the function. Obstacles such as vehicles, motorcycles, bicycles, pedestrians, or unspecified objects or structures such as guardrails, tollbooth, etc., that may collide with the vehicle may not be detected.
- Highway Driving Assist will turn off automatically under the following situations:
 - Driving on roads that Highway Driving Assist does not operate, such as a rest area, intersection, junction, etc.
 - The navigation does not operate properly such as when the navigation is being updated or restarted

- Highway Driving Assist may inadvertently operate or turn off depending on road conditions (navigation information) and surroundings.
 - Lane Following Assist function may be temporarily disabled when the front view camera cannot detect lanes properly or the hands-off warning is on.
 - You may not hear the warning sound of Highway Driving Assist if the surrounding is noisy.
 - If the vehicle is driven at high speed above a certain speed at a curve, your vehicle may drive to one side or may depart from the driving lane.
 - When you are towing a trailer or another vehicle, turn off Highway Driving Assist for safety reasons.
 - The hands-off warning message may appear early or late depending on how the steering wheel is held or road conditions. Always have your hands on the steering wheel while driving.
 - For your safety, please read the owner's manual before using the Highway Driving Assist.
 - Highway Driving Assist will not operate when the vehicle is started, or when the detecting sensors or navigation is being initialized.
-

Limitation of Highway Driving Assist

Highway Driving Assist and Highway Lane Change function may not operate properly, or may not operate under the following circumstances:

- The map information and the actual road is different because the navigation is not updated
- The map information and the actual road is different because of real-time GPS data or map information error
- The infotainment system is overloaded by simultaneously performing functions such as route search, video playback, voice recognition, etc.
- GPS signals are blocked in areas such as a tunnel
- The driver goes off course or the route to the destination is changed or canceled by resetting the navigation
- The vehicle enters a service station or rest area
- Android Auto or Car Play is operating
- The navigation cannot detect the current vehicle position (for example, elevated roads including overpass adjacent to general roads or nearby roads exist in a parallel way)
- White single dotted lane line or road edge cannot be detected
- The road is temporarily controlled due to construction, etc.
- There is no structure, such as a medium strip, guardrails, etc., on the road
- There is a changeable lane in the direction of lane change
- If a trailer, carrier, etc., is installed

***i* Information**

For more information on the limitations of the front view camera and front radar, refer to the "Forward Collision-Avoidance Assist (FCA)" section in this chapter.

Rear View Monitor (RVM)

 If equipped

Rear View Monitor displays the area behind your vehicle to help with safe parking.

Information

Rear View Monitor uses the following sensor:

- Wide-rear view camera

Refer to the "Driver Assistance System Sensors" section in this chapter for the location.

Rear View Monitor settings

Camera settings

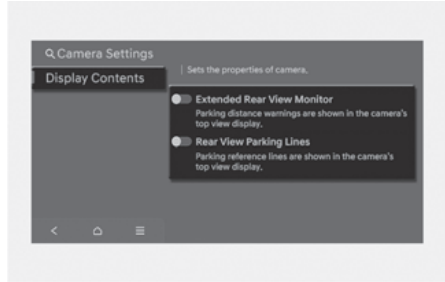

- You can change Rear View Monitor "**Display Contents**" by touching the setup icon () on the screen while Rear View Monitor is operating, or by selecting **Setup > Display > Camera Settings > Display Contents** in the infotainment system while the vehicle is on.
- In the "**Display Contents**", you can change settings for **Extended Rear View Monitor** and **Rear View Parking Lines**.

Extend rear camera use

When the '**Extended Rear View Monitor**' is selected, parking Guide Lines is displayed in the rear view.

Rear view reference lines

If **Rear View Parking Lines** is selected, the rear view parking guide lines and rear top view guide lines will be displayed at the rear view area of the infotainment system screen.

i Information

- The horizontal guide lines of the Rear View Parking Guidance shows the distance of 1.6 ft. (0.5 m), 3.3 ft. (1 m) and 7.6 ft. (2.3 m) from the vehicle.
- The horizontal marking of the Rear Top View Parking Guidance shows the liftgate opening distance and 4.9 ft. (1.5 m) from the vehicle.

i Information

You can set the following Warning Methods:

- Parking Safety Priority

For more information, refer to the "Driver assistance system settings" section in this chapter.

Rear View Monitor Operation

Parking/View button

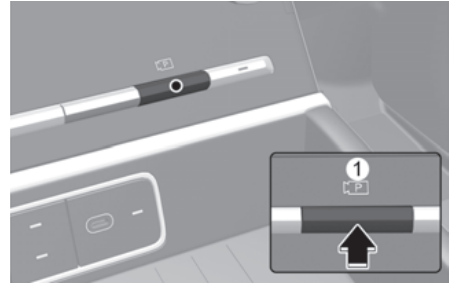

Press the Parking/View button (1) while the gear is in P (Park), D (Drive) or N (Neutral) to turn on the Rear View Monitor.

Rear view

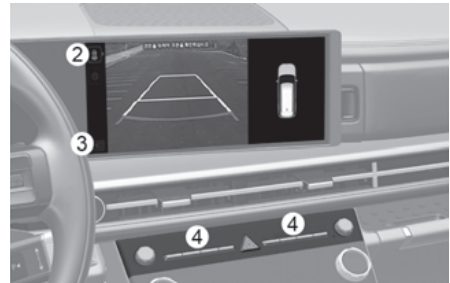

Operating conditions

- The gear is shifted to R (Reverse).
- The Parking/View button (1) is pressed while the gear is in P (Park), N (Neutral) or D (Drive), and vehicle speed is 6 mph (10 km/h) or less.

Touch the Change View button (2) to select rear view or rear top view.

Off conditions

- The gear is shifted to P (Park).
- The Parking/View button (1) or the Infotainment system screen button (3) is Pressed.
- The gear is in N (Neutral) or D (Drive) and the vehicle speed is above 6 mph (10 km/h).
- The previous button  (4) is selected on the rear view menu.

Information

When the gear is in R (Reverse), the rear view does not turn off.

Extended Rear View Monitor

The rear view will maintain showing on the screen to help you when parking.

Operating conditions

The gear is in P (Park), N (Neutral) or D (Drive), and vehicle speed is 6 mph (10 km/h) or less.

Off conditions

- When vehicle speed is above 6 mph (10 km/h), the rear view will turn off.
- Shift the gear to P (Park), the rear view will turn off.
- Press the Parking/View button (1), the rear view will turn off.

Information

- The rear view does not turn off regardless of the mode when the gear is in R (Reverse).
 - The rear view is always displayed when the gear is in R (Reverse).
 - The rear parking guide lines are displayed in rear view and rear top view mode. (When selecting **Setup > Vehicle > Driver Assistance > Parking Safety > Camera Settings > Display Contents > Rear View Parking Lines** in the infotainment system)
-

Rear View Monitor Malfunction and Limitations

Rear View Monitor malfunction

When Rear View Monitor is not working properly, or the screen flickers, or the camera image does not display properly, have your vehicle inspected by an authorized HYUNDAI dealer.

Limitations of Rear View Monitor

WARNING

- The wide-rear view camera does not cover the complete area behind the vehicle. The driver should always check the rear area directly through the inside rearview mirror and outer side view mirror before parking or backing up.
- The perceived distance on the screen may differ from the actual distance as the Rear View Monitor displays the calibrated video of the wide rear view camera. Also, the parking guide lines may be different from the actual distance if the vehicle is tilted due to cargo load or position. Make sure to directly check the vehicle's surroundings for safety.
- Always keep the wide-rear view camera lens clean. If the lens is covered with foreign material, it may adversely affect camera performance and Rear View Monitor may not operate properly. However, do not use chemical solvents such as strong detergents containing high alkaline or volatile organic solvents (gasoline, acetone, etc.). This may damage the camera lens.

Surround View Monitor (SVM)

 if equipped

Surround View Monitor uses the wide view cameras and displays images around your vehicle through the infotainment system to help with safe parking.

Information

Surround View Monitor uses the following sensors:

- Wide-front view camera
- Wide-side view cameras
- Wide-rear view camera

Refer to the "Driver Assistance System Sensors" section in this chapter for the location.

Surround View Monitor settings

Camera settings

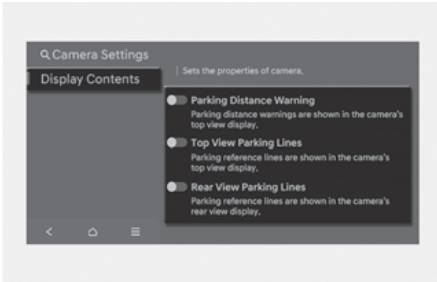

- You can change Surround View Monitor "**Display Contents**" by touching the setup icon (⚙️) on the screen while Surround View Monitor is operating, or by selecting **Setup > Vehicle > Driver Assistance > Parking Safety > Camera Settings** in the infotainment system while the vehicle is on.
- In the "**Display Contents**", you can change settings for **Parking Distance Warning**, **Top View Parking Lines** and **Rear View Parking Lines**.

i Information

You can set the following Warning Methods:

- Parking Safety Priority

For more information, refer to the "Driver assistance system settings" section in this chapter.

Parking Distance Warning

When the **Parking Distance Warning** is selected, parking distance warning appears on the top view area of the Surround View Monitor screen.

Top View Parking Guidance

When the **Top View Parking Lines** is selected, parking guidance appears on the top view area of the Surround View Monitor screen when the front top view and rear top view is displayed.

- The image will be displayed only when Parking Distance Warning is warning the driver.

i Information

The horizontal marking of the Rear Top View Parking Guidance shows the liftgate opening distance of 6.6 ft. (2 m) from the vehicle.

Rear View Parking Guidance

When the **Rear View Parking Lines** is selected, parking guidance is displayed in the rear view.

i Information

The horizontal guide lines show the distance of 1.6 ft. (0.5 m), 3.3 ft. (1 m) and 7.6 ft. (2.3 m).

Surround View Monitor Auto On

With the engine on, select **Setup > Vehicle > Driver Assistance > Parking Safety > Surround View Monitor Auto On** in the infotainment system to use the function.

If **Surround View Monitor Auto On** is selected, the front parking assist view screen appears when the Parking Distance Warning warns you while driving in D (Drive).

Surround View Monitor Operation

Parking/View button

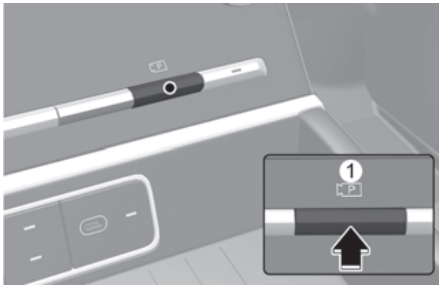

Press the Parking/View button (1) to turn on Surround View Monitor.

Press the button again to turn off the function.

Front view

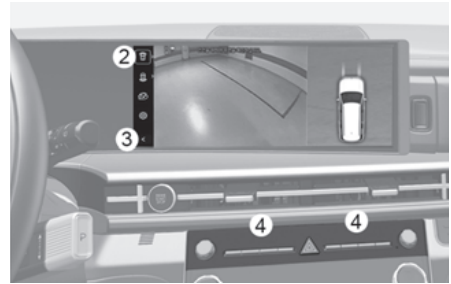

The front view appears on the screen when the gear is in N (Neutral) or D (Drive) to assist in parking.

You may select top view, front view, and side view using the change view button (2).

Operating conditions

- The gear is shifted to N (Neutral) or D (Drive) from R (Reverse) and the vehicle speed is 6 mph (10 km/h) or less.
- The Parking/View button (1) is pressed, while the gear is in P (Park), N (Neutral) or D (Drive), and vehicle speed is 6 mph (10 km/h) or less.
- **Surround View Monitor Auto On** function is operated.
When **Driver Assistance > Parking Safety > Surround View Monitor Auto On** is selected in the infotainment system, the front view while parking appears.
- The rear view is selected by pressing the change view button (2) after pressing.

i Information

When the front view is activated, the latest used view mode is displayed.

Off conditions

- The gear is shifted from N (Neutral) or D (Drive) to P (Park) or R (Reverse).
- The Parking/View button (1) or the Infotainment system button (4) is pressed.
- Vehicle speed is above 6 mph (10 km/h).
- The previous button  (3) is selected.

Information

Surround View Monitor will turn off when vehicle speed is above 6 mph (10 km/h). However, Surround View Monitor will not turn on again although vehicle speed drops below 6 mph (10 km/h).

Rear view

The rear view appears on the screen to assist in parking.

You may select top view, rear view, and side view using the change view button (2).

Operating conditions

- The gear is shifted to R (Reverse).
- The rear view is selected by pressing the change view button (2) after pressing the Parking/View button (1), while the gear is in P (Park), N (Neutral) or D (Drive), and vehicle speed is 6 mph (10 km/h) or less.

Off conditions

- The gear is shifted from R (Reverse) to P (Park).
- The Parking/View button (1) is pressed, while the gear is in P (Park).

Information

When the gear is in R (Reverse), the rear view does not turn off even if the infotainment system button (4) is pressed.

3D view

The 3D view shows the image around the vehicle from various angles.

You can change angles by tapping the screen. Press the 3D View button again to return to the initial angle.

Operating conditions

When the 3D view is selected by pressing the change view button (2):

- The gear is in P (Park), N (Neutral) or D (Drive) when vehicle speed is below 6 mph (10 km/h).
- The Surround View Monitor is turned on when the gear is in R (Reverse).

Off conditions

When the gear is in P (Park), N (Neutral) or D (Drive):

- The gear is shifted to P (Park) from N (Neutral) or D (Drive).
- The Parking/View button (1) or the Infotainment system button (4) is pressed.
- Vehicle speed is above 6 mph (10 km/h).

When the gear is in R (Reverse):

- The gear is shifted to P (Park).

i Information

3D view does not display guide lines.

Surround View Monitor Malfunction and Limitations

Surround View Monitor malfunction

When Surround View Monitor is not working properly, or the screen flickers, or the camera image does not display properly, have your vehicle inspected by an authorized HYUNDAI dealer.

Limitations of Surround View Monitor

- When the vehicle is stopped for a long time in winter or when the vehicle is parked in an indoor parking lot, the exhaust fumes may temporarily blur the image.
- The screen may be displayed abnormally, and an icon will appear at the top view area of the screen under the following circumstances:
 - The liftgate is opened
 - The driver or front passenger door is opened
 - The side view mirror is folded

! WARNING

- Always look around your vehicle to make sure there are no objects or obstacles before moving the vehicle. What you see on the screen may differ from the actual vehicle's location.
- The image shown on the screen may differ from the actual distance of the object. Also, the parking guide lines may not be accurate if the vehicle is tilted due to cargo load or position. Make sure to directly check the vehicle's surroundings for safety.
- Surround View Monitor is designed to be used on a flat surface. Therefore, if used on roads with different heights such as curbs and speed bumps, the image in the screen may not display correctly.
- Always keep the camera lens clean. If the lens is covered with foreign material, it may adversely affect camera performance and Surround View Monitor may not operate properly. However, do not use chemical solvents such as strong detergents containing high alkaline or volatile organic solvents (gasoline, acetone, etc.). This may damage the camera lens.

i Information

Surround View Monitor uses the cameras installed on the vehicle to show images around the vehicle through the infotainment system. The image shown on the screen may look unnatural depending on the surroundings.

Rear Cross-Traffic Collision-Avoidance Assist (RCCA)

Rear Cross-Traffic Collision-Avoidance Assist helps detect vehicles approaching from the rear left or right while your vehicle is reversing and warns you of a possible collision with a warning message and a warning sound. Also, Rear Cross-Traffic Collision-Avoidance Assist may assist with braking your vehicle to help avoid a collision.

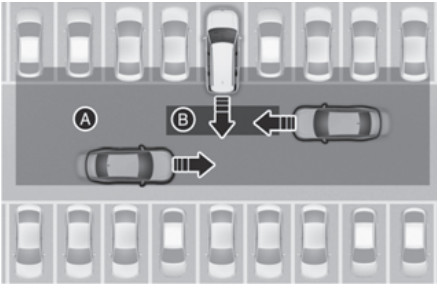

- [A] Rear Cross-Traffic Collision Warning operating range
- [B] Rear Cross-Traffic Collision-Avoidance Assist operating range

CAUTION

Warning timing may vary depending on the speed of the approaching vehicle.

Information

Rear Cross-Traffic Collision-Avoidance Assist uses the following sensor:

- Rear corner radars

Refer to the "Driver Assistance System Sensors" section in this chapter for the location.

Rear Cross-traffic Collision-Avoidance assist settings

Rear Cross-Traffic Safety

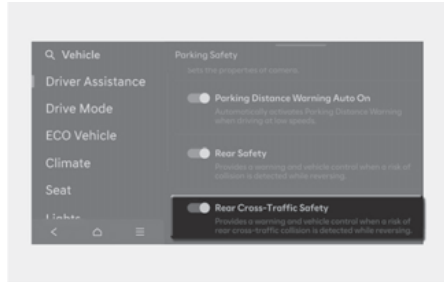

With the engine on, select **Setup** > **Vehicle** > **Driver Assistance** > **Parking Safety** > **Rear-Cross Traffic Safety** in the infotainment system to turn on Rear Cross-Traffic Collision-Avoidance Assist and deselect to turn off the function.

WARNING

When the vehicle is restarted, Rear Cross-Traffic Collision-Avoidance Assist always turn on. However, if 'Off' is selected after the vehicle is restarted, the driver should always be aware of the surroundings and drive safely.

CAUTION

When the vehicle and the trailer are connected electrically, a warning message appears on the instrument cluster, and Rear Cross-Traffic Collision-Avoidance Assist is deactivated. The function resumes after the trailer connector is disconnected. (When using HYUNDAI genuine parts)

i Information

You can set the Warning Timing and following Warning Methods:

- Warning Volume/Haptic Warning

For more information, refer to the "Driver assistance system settings" section in this chapter.

Rear Cross-Traffic Collision-Avoidance Assist Operation

Rear Cross-Traffic Collision-Avoidance Assist will warn and help control the vehicle depending on collision risk level: 'Collision Warning', 'Emergency Braking' and 'Stopping vehicle and ending brake control'.

Collision Warning

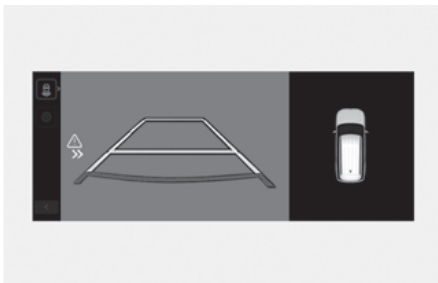

- To warn the driver of an approaching vehicle from the rear left/right side of your vehicle, the warning light on the side view mirror will blink and a warning will appear on the instrument cluster. At the same time, an audible warning will sound. If Rear View Monitor is operating, a warning will also appear on the infotainment system.
- Rear Cross-Traffic Collision-Avoidance Assist will operate when all the following conditions are satisfied:
 - The gear is shifted to R (Reverse)
 - Vehicle speed is below 5 mph (8 km/h)
 - The approaching vehicle is within about 82 ft. (25 m) from the left and right side of your vehicle
 - The speed of the vehicle approaching from the left and right is above 3 mph (5 km/h)

i Information

- If the operating conditions are satisfied, there will be a warning whenever the vehicle approaches from the left or right side even though your vehicle speed is 0 mph (0 km/h).
- The images and colors in the instrument cluster may differ depending on the instrument cluster type or theme selected from the instrument cluster.

Emergency Braking

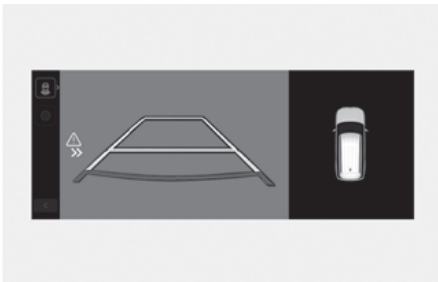
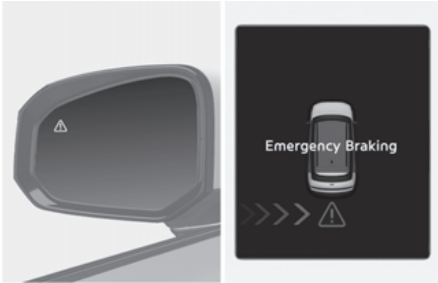

- Rear Cross-Traffic Collision-Avoidance Assist will operate when all the following conditions are satisfied:
 - The gear is shifted to R (Reverse)
 - Vehicle speed is below 5 mph (8 km/h)
 - The approaching vehicle is within approximately 5 ft. (1.5 m) from the left and right side of your vehicle
 - The speed of the vehicle approaching from the left and right is above 3 mph (5 km/h)
 - Emergency Braking is assisted to help prevent collision with approaching vehicles from the left and right.

WARNING

Brake control will end when:

- The approaching vehicle is out of the detecting range
- The approaching vehicle passes behind your vehicle
- The approaching vehicle does not drive toward your vehicle
- The approaching vehicle speed slows down
- The driver depresses the brake pedal with sufficient power

Stopping vehicle and ending brake control



- When the vehicle is stopped due to emergency braking, the "**Drive carefully**" warning message will appear on the instrument cluster.
 - For your safety, the driver should depress the brake pedal immediately and check the surroundings.
 - Brake control will end after approximately 2 seconds of emergency brake control.
 - During emergency braking, braking control by Rear Cross-Traffic Collision-Avoidance Assist will automatically cancel when the driver excessively depresses the brake pedal.
- ! **WARNING**
- Take the following precautions when using Rear Cross-Traffic Collision-Avoidance Assist:
- For your safety, only change the Settings after parking the vehicle at a safe location.
 - If any other system's warning message is displayed or audible warning is generated, Rear Cross-Traffic Collision-Avoidance Assist warning message may not be displayed and audible warning may not be generated.
 - You may not hear the warning sound of Rear Cross-Traffic Collision-Avoidance Assist if the surrounding is noisy.
 - Rear Cross-Traffic Collision-Avoidance Assist may not operate if the driver applies the brake pedal to avoid collision.
 - During Rear Cross-Traffic Collision-Avoidance Assist operation, the vehicle may stop suddenly injuring passengers and shifting loose objects. Always have the seat belt on and keep loose objects secured.
 - Even if there is a problem with Rear Cross-Traffic Collision-Avoidance Assist, the vehicle's basic braking will function normally.
 - When Rear Cross-Traffic Collision-Avoidance Assist is operating, braking control by the function will automatically cancel when the driver excessively depresses the accelerator pedal.

- Rear Cross-Traffic Collision-Avoidance Assist does not operate in all situations or cannot avoid all collisions.
- Rear Cross-Traffic Collision-Avoidance Assist may warn the driver late or may not warn the driver depending on the road and driving conditions.
- The driver has the responsibility to control the vehicle. Do not solely depend on Rear Cross-Traffic Collision-Avoidance Assist. Rather, maintain a safe braking distance, and if necessary, depress the brake pedal to reduce driving speed or to stop the vehicle.
- Never deliberately operate Rear Cross-Traffic Collision-Avoidance Assist on people, animal, objects, etc. It may cause serious injury or death.

CAUTION

The brake control may not operate properly depending on the status of ESC (Electronic Stability Control).

There will only be a warning when:

- The ESC (Electronic Stability Control) warning light is on
- ESC (Electronic Stability Control) is engaged in a different function

Information

If braking is assisted by Rear Cross-Traffic Collision-Avoidance Assist, the driver must immediately depress the brake pedal and check vehicle surroundings.

- Brake control will end when the driver depresses the brake pedal with sufficient power.
- After shifting the gear to R (Reverse), braking control will operate once for left and right vehicle approach.

Rear Cross-Traffic Collision-Avoidance Assist Malfunction and Limitations

Rear Cross-Traffic Collision-Avoidance Assist malfunction

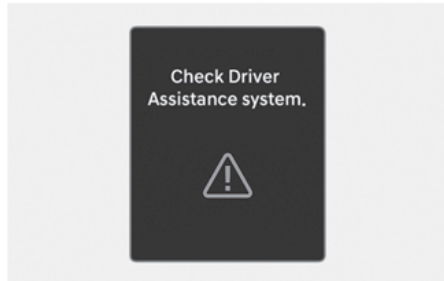

When Rear Cross-Traffic Collision-Avoidance Assist is not working properly, the "**Check Driver Assistance system.**" warning message appears on the instrument cluster for several seconds, and the master () warning light illuminates on the instrument cluster. If this occur, have vehicle inspected by an authorized HYUNDAI dealer.

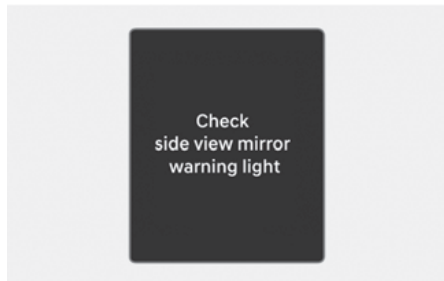

When the side view mirror warning light is not working properly, the "**Check side view mirror warning light**" warning message appears on the instrument cluster for several seconds, and the master (△) warning light illuminates on the instrument cluster. If this occur, have your vehicle inspected by an authorized HYUNDAI dealer.

Rear Cross-Traffic Collision-Avoidance Assist disabled

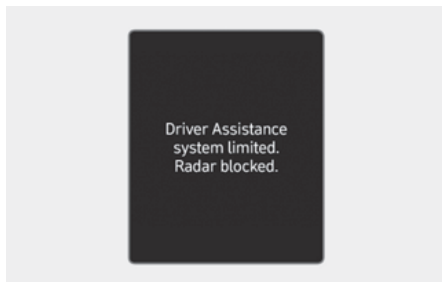

When the rear bumper around the rear-side radar or sensor is covered with foreign material, such as snow or rain, or installing a trailer or carrier, it can reduce the detecting performance and temporarily limit or disable Rear Cross-Traffic Collision-Avoidance Assist.

If this occurs, the "**Driver Assistance system limited. Radar blocked.**" warning message appears on the instrument cluster.

Rear Cross-Traffic Collision-Avoidance Assist will operate properly when such foreign material or trailer, etc., is removed.

If Rear Cross-Traffic Collision-Avoidance Assist does not operate properly after it is removed, have your vehicle inspected by an authorized HYUNDAI dealer.

! WARNING

- Even though the warning message does not appear on the instrument cluster, Rear Cross-Traffic Collision-Avoidance Assist may not operate properly.
- Rear Cross-Traffic Collision-Avoidance Assist may not operate properly in an area (for example, open terrain), where any objects are not detected after turning ON the vehicle.

! CAUTION

Turn off Rear Cross-Traffic Collision-Avoidance Assist to install or remove a trailer, carrier, or another attachment. Turn on Rear Cross-Traffic Collision-Avoidance Assist when finished.

Limitations of Rear Cross-Traffic Collision-Avoidance Assist

Rear Cross-Traffic Collision-Avoidance Assist may not operate properly, or it may operate unexpectedly under the following circumstances:

- Departing from where trees or grass are overgrown
- Departing from where roads are wet
- Speed of the approaching vehicle is fast or slow

Braking control may not work, driver's attention is required in the following circumstances:

- The vehicle severely vibrates while driving over a bumpy road, uneven road or concrete patch
- Driving on a slippery surface due to snow, water puddle, ice, etc.
- The tire pressure is low or a tire is damaged
- The braking system has been modified
- Remote Smart Parking Assist is operating (if equipped)

***i* Information**

For more information on the limitations of the rear corner radar, refer to the "Blind-Spot Collision-Avoidance Assist (BCA)" section in this chapter.

⚠ WARNING

- **Driving near a vehicle or structure**

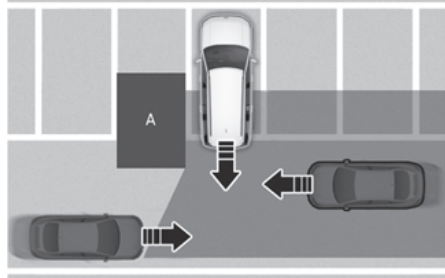

[A] Structure

Rear Cross-Traffic Collision-Avoidance Assist may be limited when driving near a vehicle or structure, and may not detect the vehicle approaching from the left or right. If this occurs, the function may not warn the driver or control the brakes when necessary.

Always check your surroundings while backing up.

- When the vehicle is in a complex parking environment

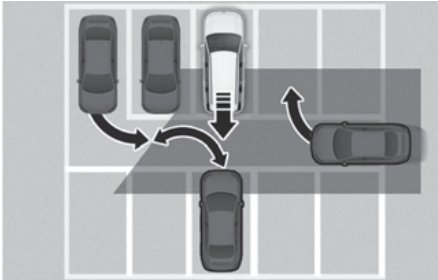

Rear Cross-Traffic Collision-Avoidance Assist may detect vehicles which are parking or pulling out near your vehicle (for example, a vehicle leaving beside your vehicle, a vehicle parking or pulling out in the rear area, a vehicle approaching your vehicle making a turn, etc.). If this occurs, the function may unnecessarily warn the driver and control the brake.

Always check your surroundings while backing up.

- When the vehicle is parked diagonally

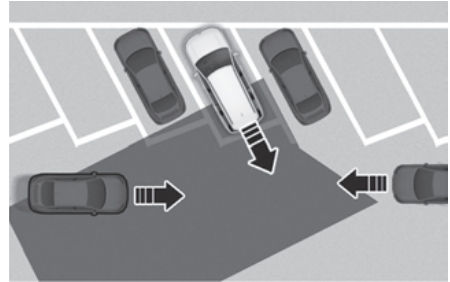

Rear Cross-Traffic Collision-Avoidance Assist may be limited when backing up diagonally, and may not detect the vehicle approaching from the left or right. If this occurs, the function may not warn the driver or control the brakes when necessary.

Always check your surroundings while backing up.

- When the vehicle is on or near a slope

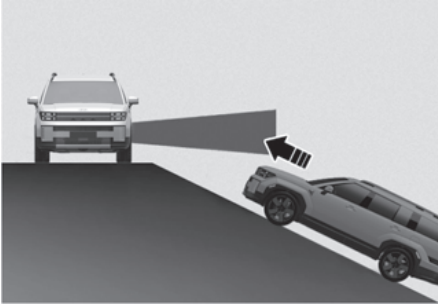

Rear Cross-Traffic Collision-Avoidance Assist may be limited when the vehicle is on an uphill or downhill slope, or near it, and may not detect the vehicle approaching from the left or right. If this occurs, the function may not warn the driver or control the brakes when necessary.

Always check your surroundings while backing up.

- Pulling into the parking space where there is a structure

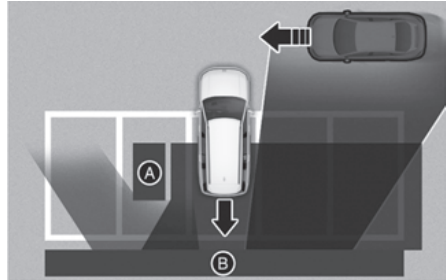

- [A] Structure
- [B] Wall

Rear Cross-Traffic Collision-Avoidance Assist may detect vehicles passing by in front of you when parking in reverse into a parking space with a wall or structure in the rear or side area. If this occurs, the function may unnecessarily warn the driver and control the brake.

Always check your surroundings while backing up.

- When the vehicle is parked rearward

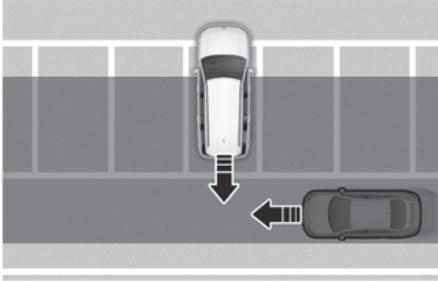

Rear Cross-Traffic Collision-Avoidance Assist may detect vehicles passing by behind you when parking in reverse into a parking space. If this occurs, the function may unnecessarily warn the driver and control the brake.

Always check your surroundings while backing up.

WARNING

- When you are towing a trailer or another vehicle, turn off Rear Cross-Traffic Collision-Avoidance Assist for safety reasons.
- Rear Cross-Traffic Collision-Avoidance Assist may not operate properly if interfered by strong electromagnetic waves.
- Rear Cross-Traffic Collision-Avoidance Assist may not operate for 3 seconds after the vehicle is started, or the rear corner radars are initialized.

Parking Distance Warning (PDW)

Parking Distance Warning uses the front, side, and rear ultrasonic sensors to detect and warns you if a person, animal, or object is within a certain distance when your vehicle is stopped or driving at low speed.

Information

Parking Distance Warning uses the following sensors:

- Front ultrasonic sensors
- Rear ultrasonic sensors
- Front side ultrasonic sensors (if equipped)
- Rear side ultrasonic sensors (if equipped)

Refer to the "Driver Assistance System Sensors" section in this chapter for the location.

Parking Distance Warning settings

Parking Distance Warning Auto On

To use **Parking Distance Warning Auto On**, select **Setup > Vehicle > Driver Assistance > Parking Safety > Parking Distance Warning Auto On** in the infotainment system.

i Information

When **Parking Distance Warning Auto On** is selected, the Parking Safety button indicator (P[▲]) stays on.

i Information

You can set the following Warning Methods:

- Warning Volume

For more information, refer to the "Driver assistance system settings" section in this chapter.

⚠ CAUTION

When the vehicle and the trailer are connected electrically, a warning message appears on the instrument cluster, and Reverse Parking Distance Warning is deactivated. The function resumes after the trailer connector is disconnected. (When using HYUNDAI genuine parts)

Parking Distance Warning Operation

Parking Safety button

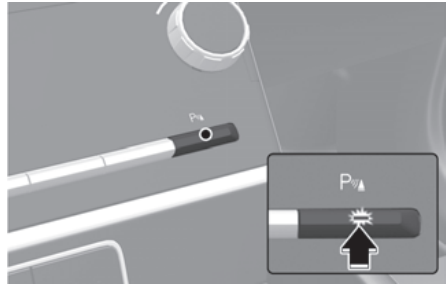

Press the Parking Safety (P[▲]) button to turn on Forward/Reverse Parking Distance Warning. Press the button again to turn off the function.

- When the gear is shifted to R (Reverse), Parking Distance Warning automatically turns on (Parking Safety button indicator on).

Forward Parking Distance Warning

Forward Parking Distance Warning operates under the following conditions.







- The gear is shifted from R (Reverse) to D (Drive) with Reverse Parking Distance Warning on
- The gear is in D (Drive) and the Parking Safety (P^W) button indicator light is on
- Shift to D (Drive) when the function is off
(Only when **Vehicle > Driver Assistance > Parking Safety > Parking Distance Warning Auto On** is selected in the infotainment system.)

i Information

- Forward Parking Distance Warning operates only when the vehicle's forward speed is below 6 mph (10 km/h).
- Forward Parking Distance Warning is deactivated if the vehicle speed reaches above 18 mph (30 km/h). It may not reactivate although the vehicle speed drops below 6 mph (10 km/h).
(Only when **Vehicle > Driver Assistance > Parking Safety > Parking Safety** is not selected in the infotainment system.)
- When the gear is shifted to R (Reverse), 'Forward Parking Distance Warning' does not warn about objects detected near the front inside area, and only warns about objects detected near the front outside area within 24 in. (60 cm).

Warning indicator and sound

The corresponding indicator illuminates whenever each ultrasonic sensor detects a person or object in its sensing range. Also an audible warning sounds.

Distance from Object	Warning Indicator		Warning Sound
	Cluster	Infotainment	
24-48 in. (60-120 cm)			Buzzer beeps intermittently (front inside)
12-24 in. (30-60 cm)			Beeps more frequently
within 12 in. (30 cm)			Beeps continuously

- When more than two objects are detected at the same time, the closest one is warned with an audible warning.
- The shape of the indicator in the illustration may differ from the actual vehicle.
- The front outer side warnings turn on when the vehicle is in R (Reverse).

Side Parking Distance Warning

 if equipped

Side Parking Distance Warning operates under the following conditions.







- The gear is shifted to R (Reverse).
- The gear is shifted from R (Reverse) to D (Drive).
- The gear is in D (Drive) and the Parking Safety (PWA) button indicator light is on
- Shift to D (Drive) when the function is off
(Only when **Vehicle > Driver Assistance > Parking Safety > Parking Distance Warning Auto On** is selected in the infotainment system.)

i Information

- Side Parking Distance Warning operates when the vehicle's forward speed is below 6 mph (10 km/h).
- Side Parking Distance Warning operated only when Forward or Rearward Parking Distance Warning is on.

Warning indicator and sound

The corresponding indicator illuminates whenever each ultrasonic sensor detects a person or object in its sensing range.

Distance from Object	Warning Indicator		Warning Sound
	Cluster	Infotainment	
24-48 in. (60-120 cm)			-
12-24 in. (30-60 cm)			-
within 12 in. (30 cm)			Beeps continuously

- If an object located within 12 in. (30 cm) from the side of the vehicle's path is detected, an audible warning sounds.
- If an object outside the side of the vehicle's path is detected, the warning indicator is displayed.
- The shape of the indicator in the illustration may differ from the actual vehicle.







Reverse Parking Distance Warning

Reverse Parking Distance Warning operates under the following conditions.

- The gear is shifted to R (Reverse).

Warning indicator and sound

The corresponding indicator illuminates whenever each ultrasonic sensor detects a person or object in its sensing range. Also an audible warning sounds.

Distance from Object	Warning Indicator		Warning Sound
	Cluster	Infotainment	
24-48 in. (60-120 cm)			Buzzer beeps intermittently
12-24 in. (30-60 cm)			Beeps more frequently
within 12 in. (30 cm)			Beeps continuously

- When more than two objects are detected at the same time, the closest one is warned with an audible warning.
- The shape of the indicator in the illustration may differ from the actual vehicle.

Parking Distance Warning Malfunction and Limitations

Parking Distance Warning Malfunction and Limitations

After starting the vehicle, a beep sounds when the gear is shifted to R (Reverse) to indicate Parking Distance Warning is operating properly.

However, if one or more of the following occurs, first check whether the ultrasonic sensor is damaged or blocked with foreign material. If it still does not work properly, have your vehicle inspected by an authorized HYUNDAI dealer.

- The audible warning does not sound.
- The buzzer sounds intermittently.
- The "**Check Driver Assistance system.**" warning message appears on the instrument cluster.

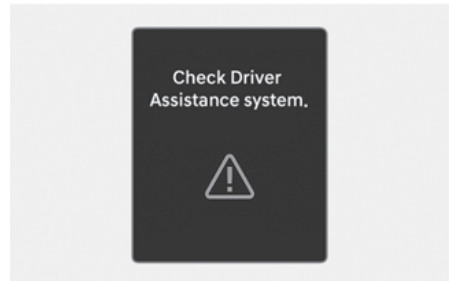

Parking Distance Warning disabled

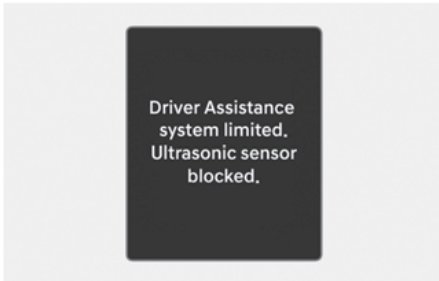

If this occurs the "**Driver Assistance system limited. Ultrasonic sensor blocked.**" warning message appears on the instrument cluster. Parking Distance Warning operates properly when snow, rain or foreign material is removed. If Parking Distance Warning does not operate properly after obstruction (snow, rain, or foreign material) is removed (including trailer, carrier, etc., from the rear bumper), have your vehicle inspected by an authorized HYUNDAI dealer.

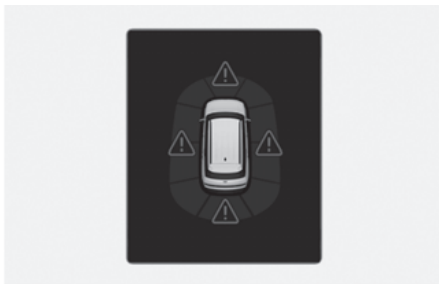

When the Parking Distance Warning is operating, if the function is not working normally or the ultrasonic sensor is blocked, the master warning light (⚠) appears in the direction of the corresponding sensor. You can check the warning in the Utility view on the cluster.

Limitations of Parking Distance Warning

- Parking Distance Warning may not operate properly when:
 - There is excessive moisture or frost on the sensor
 - Sensor is covered with foreign substance, such as snow or water (Parking Distance Warning operates properly when such substance is removed.)
 - The weather is extremely hot or cold
 - The sensor or sensor assembly is disassembled
 - The surface of the sensor is pressed hard or hit with a hard object
 - The surface of the sensor is scratched with a sharp object
 - The sensors or its surrounding area is directly sprayed with high pressure washer
 - Objects generating ultrasonic waves, such as vehicle horns, loud motorcycle engines, or truck air brakes, are near your vehicle.

- Parking Distance Warning may malfunction when:
 - Heavy rain or water spray is present
 - Water flows on the surface of the sensor
 - Affected by another vehicle's sensors
 - The sensor is covered with snow or ice
 - Driving on uneven road, gravel roads or bushes
 - Objects that generate ultrasonic waves are near the sensor
 - License plate is installed in a different spot from the original location
 - The vehicle bumper height or ultrasonic sensor installation has been modified
 - Attaching equipment or accessories next to the ultrasonic sensors
- The following objects may not be detected:
 - Sharp or slim objects, such as ropes, chains or small poles.
 - Narrow objects, such as corners of a square column
 - Objects, which tend to absorb sensor frequency, such as clothes, spongy material or snow.
 - Objects smaller than 40 in. (100 cm) in length and narrower than 6 in. (14 cm) in diameter.
 - Pedestrians, animals or objects that are very close to the ultrasonic sensors
 - An object in the Side space between the front corner ultrasonic sensor and the rear corner ultrasonic sensor or an object approaching the Side space

WARNING

- Parking Distance Warning is a supplemental function. The operation of Parking Distance Warning can be affected by several factors (including environmental conditions). It is the responsibility of the driver to always check the front and rear views before and while parking.
- Your new vehicle warranty does not cover any crashes or damage to the vehicle due to the malfunction of Parking Distance Warning.
- Pay close attention when driving near objects, pedestrians, and especially children. Some objects may not be detected by the ultrasonic sensors, due to the objects distance, size or material, all of which can limit the effectiveness of the sensor.
- Parking Distance Warning does not warn you in the order of detection. It varies depending on the speed of the vehicle or the shape of a person, animal, or object.
- If the Parking Distance Warning does not operate properly, have your vehicle inspected by an authorized HYUNDAI dealer.

Reverse Parking Collision-Avoidance Assist (PCA)

 If equipped

Reverse Parking Collision-Avoidance Assist helps detect pedestrians or objects behind the vehicle and may warn you or assist you with braking to help avoid a collision while your vehicle is reversing.

Information

Reverse Parking Collision-Avoidance Assist uses the following sensors:

- Wide-rear view camera
- Rear ultrasonic sensors

Refer to the "Driver Assistance System Sensors" section in this chapter for the location.

Reverse Parking Collision-Avoidance Assist settings

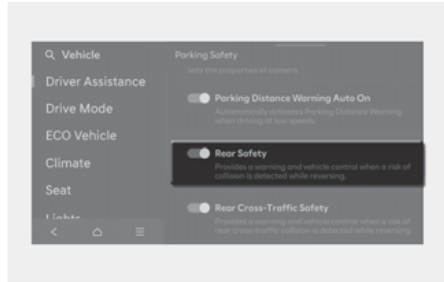

With the engine on, select or deselect **Vehicle > Driver Assistance > Parking Safety** in the infotainment system to set whether to use each function.

- If "**Rear Safety**" is selected, Parking Collision-Avoidance Assist warns the driver and assists with braking when a collision with a pedestrian or an object is imminent from behind.

CAUTION

When the vehicle and the trailer are connected electrically, a warning message appears on the instrument cluster, and Parking Collision-Avoidance Assist is deactivated. The function resumes after the trailer connector is disconnected. (When using HYUNDAI genuine parts)

Information

You can set the following Warning Methods:

- Warning Volume/Haptic Warning

For more information, refer to the "Driver assistance system settings" section in this chapter.

Reverse Parking Collision-Avoidance Assist Operation

Turning Parking Collision Avoidance Assist On/Off

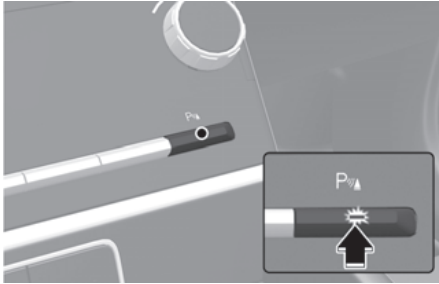

Press and hold the Parking Safety (PWA) button more than 2 seconds, to turn the Parking Collision-Avoidance Assist on or off.

Operating conditions

If Reverse Parking Collision-Avoidance Assist detects a risk of collision behind the vehicle with a pedestrian or an object, Reverse Parking Collision-Avoidance Assist warns the driver with an audible warning and warning message on the cluster. If Surround View Monitor is operating, a warning appears on the infotainment screen.

If collision is imminent, Reverse Parking Collision-Avoidance Assist assists you with braking.

Select "**Rear Safety**" from the "**Parking Safety**" menu of the infotainment system. Parking Collision-Avoidance Assist is enabled when the following conditions are satisfied:

- The liftgate and door are closed
- The parking brake is released
- A trailer is not connected
- The gear is shifted to R (Reverse)
- Vehicle speed is below 6 mph (10 km/h) (detecting pedestrians)
- Vehicle speed is below 2.4 mph (4 km/h) (detecting objects)
- Parking Collision-Avoidance Assist components such as the wide-rear view camera and the rear ultrasonic sensors are in normal conditions

When Reverse Parking Collision-Avoidance Assist activates, a line appears behind the vehicle image in the instrument cluster.

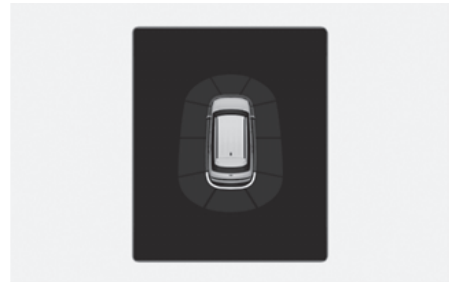

i Information

Reverse Parking Collision-Avoidance Assist operates only once after shifting the gear to R (Reverse). To reactivate Parking Collision-Avoidance Assist, shift the gear from another gear to R (Reverse).

Off conditions

If collision is imminent, Reverse Parking Collision-Avoidance Assist assists you with braking. Braking assist is released after 5 minutes. Immediately depress the brake pedal and check vehicle surroundings. Braking assist is also released in the following conditions when:

- The gear is shifted to P (Park) or D (Drive)
- The brake pedal is depressed with sufficient power

i Information

When Parking Collision-Avoidance Assist is activated while reversing, braking control will be released after 5 minutes and the parking brake will be engaged.

Reverse Parking Collision-Avoidance Assist Malfunction and Limitations

Reverse Parking Collision-Avoidance Assist malfunction

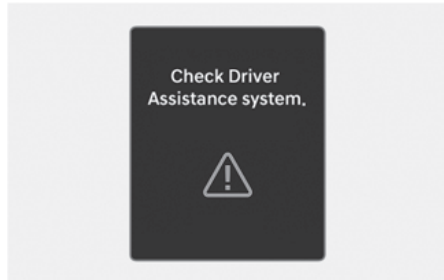

When Reverse Parking Collision-Avoidance Assist or other related functions are not working properly, the "**Check Driver Assistance system.**" warning message appears on the instrument cluster, and Reverse Parking Collision-Avoidance Assist turns off automatically. Have your vehicle inspected by an authorized HYUNDAI dealer.

Reverse Parking Collision-Avoidance Assist disabled

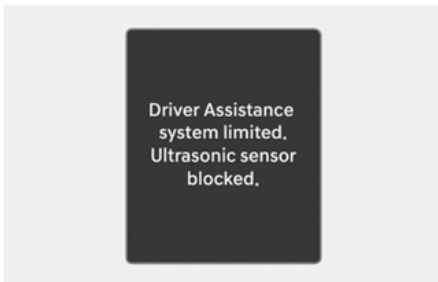
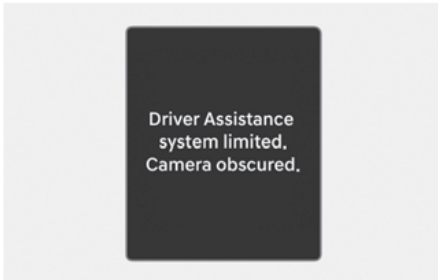

The "**Driver Assistance system limited. Camera obscured.**" or "**Driver Assistance system limited. Ultrasonic sensor blocked.**" warning message appears on the instrument cluster if the following situations occur:

- The wide-rear view camera or rear ultrasonic sensor(s) is covered with foreign material, such as snow or rain, etc.
- There is inclement weather, such as heavy snow, heavy rain, etc.

If this occurs, Reverse Parking Collision-Avoidance Assist may turn off or may not operate properly. Check whether the wide-rear view camera and rear ultrasonic sensors are clean.

Limitations of Reverse Parking Collision-Avoidance Assist

Reverse Parking Collision-Avoidance Assist may not assist braking or warn the driver even if there are pedestrians or objects under the following circumstances:

- Problems with vehicle
 - Any non-factory equipment or accessory is installed
 - Your vehicle is unstable due to a crash or other causes
 - Bumper height or rear ultrasonic sensor installation has been modified
 - Wide-rear view camera(s) or ultrasonic sensor(s) is damaged
 - Wide-rear view camera(s) or the ultrasonic sensor(s) is stained with foreign material, such as snow, dirt, etc.
 - Wide-rear view camera(s) is obscured by a light source or by inclement weather, such as heavy rain, fog, snow, etc.
- Problems with the surroundings
 - The surrounding is very bright or very dark
 - Outside temperature is very high or very low
 - The wind is either strong (above 12 mph (20 km/h)) or blowing perpendicular to the rear bumper
 - Objects generating excessive noise, such as vehicle horns, loud motorcycle vehicles or truck air brakes, are near your vehicle
 - An ultrasonic sensor with similar frequency is near your vehicle
 - The road is slippery or inclined
 - The image of the pedestrian in the front view camera is indistinguishable from the background

- Problems with pedestrian or object
 - The pedestrians are difficult to detect
 - There is ground height difference between the vehicle and the pedestrian
 - The pedestrian is near the rear edge of the vehicle
 - The pedestrian is not standing upright
 - The pedestrian is either very short or very tall to detect
 - The pedestrian or cyclist is wearing clothing that easily blends into the background, making it difficult to detect
 - The pedestrian is wearing clothing that does not reflect ultrasonic waves well
 - Size, thickness, height, or shape of the object does not reflect ultrasonic waves well (for example, low object, narrow object, circular pillar, small pillar, corners of a square pillar, bush, curbs, carts, edge of a wall, etc.)
 - The pedestrian or the object is moving
 - The pedestrian or the object is very close to the rear of the vehicle
 - There is a large object such as a wall is behind the pedestrian or the object
 - The object is not located at the front or rear center of your vehicle
 - The object is not parallel to the rear bumper
 - The sensors cannot detect the pedestrians and objects
- Problems with driving condition
 - The driver drives the vehicle immediately after shifting to R (Reverse) or D (Drive)
 - The driver accelerates or circles the vehicle
 - The vehicle is driven immediately after starting the vehicle

WARNING

Take the following precautions when using Reverse Parking Collision-Avoidance Assist:

- Always exercise extreme caution while driving. The driver is responsible for braking and safe driving.
 - Always pay attention to road and traffic conditions while driving, whether or not there is a warning.
 - Always look around your vehicle to make sure there are no pedestrians or objects before moving the vehicle.
 - The performance of Reverse Parking Collision-Avoidance Assist may vary under certain conditions. If vehicle speed is above 2 mph (4 km/h), Reverse Parking Collision-Avoidance Assist will provide collision avoidance assist only when pedestrians are detected. Always look around and pay attention when driving your vehicle.
 - Reverse Parking Collision-Avoidance Assist may operate differently under certain conditions. If the vehicle moves forward and backward repeatedly, Reverse Parking Collision-Avoidance Assist may fail to assist braking or to warn the driver. Always pay attention when driving your vehicle.
 - Some objects may not be detected by the rear ultrasonic sensors due to the objects distance, size or material, all of which can limit the effectiveness of the sensor.
 - Reverse Parking Collision-Avoidance Assist may not operate properly or may operate unnecessarily depending on the road conditions and the surroundings.
 - Do not solely rely on Parking Collision-Avoidance Assist. Doing so may lead to vehicle damage or injuries.
-

CAUTION

- Noise may be heard when sudden braking occurs to avoid a collision.
 - If any other warning sound such as the seat belt warning chime is already generated, Parking Collision-Avoidance Assist warning may not sound.
 - Parking Collision-Avoidance Assist may not work properly if the bumper has been damaged, replaced or repaired.
 - Parking Collision-Avoidance Assist may not operate properly if interfered by strong electromagnetic waves.
 - Playing the vehicle audio system at high volume may prevent passengers from hearing Parking Collision-Avoidance Assist warning sounds.
 - Turn off Parking Collision-Avoidance Assist when towing a trailer. If towing and moving in reverse, Parking Collision-Avoidance Assist will activate as it detects the trailer.
 - The brake control may not operate properly depending on the status of ESC (Electronic Stability Control).
There will only be a warning when:
 - The ESC (Electronic Stability Control) warning light is on
 - ESC (Electronic Stability Control) is engaged in a different function
-

CAUTION

Take the following precautions to maintain optimal performance of the detecting sensors:

- Always keep the wide-rear view cameras and ultrasonic sensors clean.
- Do not use any cleanser containing acid or alkaline detergents when cleaning the camera lens. Use only a mild soap or neutral detergent, and rinse thoroughly with water.
- Do not spray the wide-rear view cameras or the rear ultrasonic sensors or their surrounding area directly with a high pressure washer. It may cause the wide angle cameras or the ultrasonic sensors to malfunction.
- Do not apply objects, such as a bumper sticker or a bumper guard, near the wide angle cameras or ultrasonic sensors or apply paint to the bumper. Doing so may adversely affect the performance of Parking Collision-Avoidance Assist.

- Never disassemble or apply impact on the wide angle cameras or the ultrasonic sensors components.
- Do not apply unnecessary force on the wide-rear view cameras or the ultrasonic sensors. Reverse Parking Collision-Avoidance Assist may not operate properly if the wide angle cameras or the ultrasonic sensor(s) is forcibly moved out of proper alignment. Have your vehicle inspected by an authorized HYUNDAI dealer.

i Information

Reverse Parking Collision-Avoidance Assist can detect a pedestrian or an object when:

- A pedestrian is standing behind the vehicle
- A large obstacle, such as a vehicle, is parked in the rear center of your vehicle

Remote Smart Parking Assist (RSPA)

+ if equipped

Remote Smart Parking Assist uses the front, front side, rear side, and rear ultrasonic sensors to help detect parking spaces and control vehicle steering, speed, gear shifts, and help enter and exit parking spaces remotely from outside your vehicle.

Function	Description
Remote Operation	Remotely moving forward or backward 

- Remote Smart Parking and Remote Operation function may be operated from outside the vehicle using the smart key.
- When Remote Smart Parking Assist operates, Parking Distance Warning and Surround View Monitor will also operate. For more information, refer to the "Parking Distance Warning (PDW)" and "Surround View Monitor (SVM)" sections in this chapter.

***i* Information**

Remote Smart Parking Assist uses the following sensors:

- Front ultrasonic sensors
- Rear ultrasonic sensors
- Front side ultrasonic sensors
- Rear side ultrasonic sensors

Refer to the "Driver Assistance System Sensors" section in this chapter for the location.

Remote Smart Parking Assist Settings

CAUTION

When the vehicle and the trailer are connected electrically, a warning message appears on the instrument cluster, and Remote Smart Parking Assist is deactivated. The function resumes after the trailer connector is disconnected. (When using HYUNDAI genuine parts)

***i* Information**



You can set the following Warning Methods:





- Warning Volume

For more information, refer to the "Driver assistance system settings" section in this chapter.

Remote Smart Parking Assist Operation

Remote Smart Parking Assist button

Parking/View button	Smart key
	

Location	Name	Symbol	Description
Inside vehicle	Parking/View button		Press and hold the Parking/View button to turn on Remote Smart Parking Assist. Also, Forward/Reverse Parking Distance warning will automatically turn on.
Smart key	Remote Start button		Press the Remote Start button after the door is locked with the vehicle off to start the vehicle remotely. Press the Remote Start button while Remote Smart Parking or Remote Operation function is operating to end function operation.
	Forward button		When using the Remote Operation function, the vehicle moves in the direction of the button while the button is pressed.
	Backward button		

Remote Operation

Operating order

Remote Operation operates in the following order:

1. Getting ready to remotely move forward and backward
2. Remotely moving forward and backward

1. Getting ready to remotely move forward and backward

There are two ways to operate Remote Operation function.

Method (1): Using the function with vehicle off

1. Within a certain range from the vehicle press the door lock (🔒) button on the smart key and lock all doors.

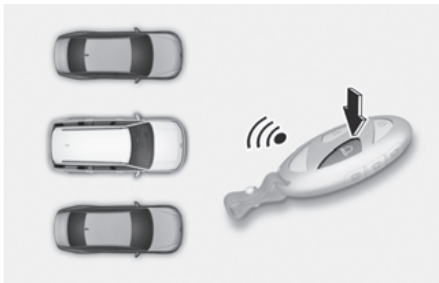

2. Press and hold the Remote Start button (🔌) within 4 seconds until the vehicle starts.
3. For more information on remotely starting the vehicle, refer to the "Remotely starting the engine" section in chapter 6.

Method (2): Using the function with vehicle on

- Park the vehicle in front of the space where you want to use Remote Operation function, and shift the gear to P (Park).
- Press and hold the Parking/View (📄) button to turn on Smart Parking Assist. A message "**Under Remote Control**" will appear on the infotainment system.

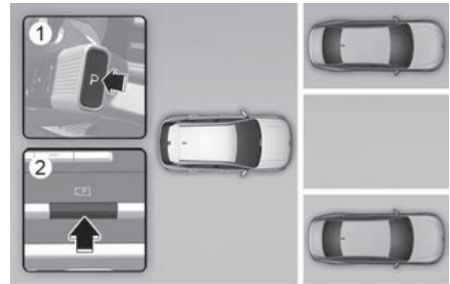

- Get out of the vehicle with the smart key and close all doors and liftgate.

i Information

'Agree' must be selected on the infotainment system and the infotainment system has to operate properly to use Remote Operation function.

2. Remotely moving forward and backward

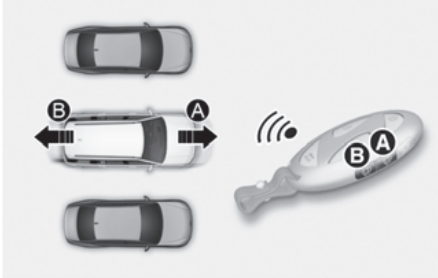

[A] Forward
[B] Backward

1. Press and hold one of the Forward (A) or Backward (B) button on the smart key.
 - Remote Smart Parking Assist will automatically control the steering wheel, vehicle speed and gearshift. The vehicle will move in the direction of the button pressed.
 - While Remote Operation function is operating, if the you let the button go, the vehicle will stop and function control will pause. The function will start operating again when the button is pressed and held again.
2. Hold down the Forward (A) or Backward (B) button until the vehicle reaches the target location.
3. When Remote Operation is done, get in the vehicle with the smart key or press the Remote Start (Hold) button on the smart key from outside the vehicle.
4. The message will appear on the infotainment system. The vehicle will automatically shift to P (Park) and engage the parking brake.
5. When the Remote Start (Hold) button is pressed, the vehicle will turn off. If the driver is in the vehicle, the vehicle will retain ON position.

i Information

- Remote Operation can control the vehicle remotely using the smart key outside the vehicle.
- Check that all smart keys are outside the vehicle when using Remote Operation function.
- Remote Operation function will operate only when the smart key is within 13 ft. (4 m) from the vehicle. If there is no vehicle movement even when the Forward or Backward button is pressed on the smart key, check the distance to the vehicle and press the button again.
- The detecting range of the smart key may vary depending on the surroundings that are affected by radio waves such as transmission tower, broadcast station, etc.
- When remotely moving forward using method (1), it is recognized as an exit situation, and the vehicle moves 13 ft. (4 m) to check for pedestrians, animals or objects around the vehicle. After confirmation, the steering wheel is controlled according to the condition ahead.
- When remotely moving forward using method (2), it is recognized as a parking situation, and will immediately control the steering wheel according to the condition ahead to assist with entering the parking space and aligning the vehicle. However, performance may reduce depending on the pedestrians, animals, shape of objects, location, etc., around the vehicle.
- For moving remotely backward, both method (1) and (2) aligns the steering wheel first, and then will only move the vehicle straight.

WARNING

- When using Remote Operation function, make sure that all passengers have gotten out of the vehicle.
- If the vehicle's battery is discharged or Remote Smart Parking Assist malfunctions when parked in a narrow parking space, Remote Operation function will not operate. Always park your vehicle in a space wide enough for you to get in or out of your vehicle.
- Please note that depending on the parking space, you may not be able to exit from the space you have entered by using Remote Operation function.
- After parking, the surrounding may change due to the movement of surrounding vehicles. If this occurs, Remote Operation function may not operate.
- Before leaving the vehicle, close windows and sunroofs, and make sure the vehicle is off before locking the doors.

Remote Operation function operation status

Operation Status	Smart Key LED	Hazard Warning Light
Under control	Green LED continuously blinks	-
Pause	Red LED continuously blinks	Blinks
Off	Red LED illuminates for 4 seconds and then turns off	Blinks 3 times and turns off
Complete	Green LED illuminates for 4 seconds and then turns off	Blinks 1 time and turns off

i Information

- Operation status by the hazard warning light may not be applicable based on the regulation of your state.
- If the smart key is not within the operating range from the vehicle (about 13 ft. (4 m)), the smart key LED will not illuminate or blink. Use the smart key within the operating range.

How to turn off Remote Operation function while operating

- Press the Parking/View (P) button while the infotainment system guides the driver using method 2.
- Shift the gear from P (Park) to any other position while the infotainment system guides the driver using method 2.
- Press the Parking Safety (P) button or select "Cancel" on the infotainment system.
- Press the Remote Start (R) button on the smart key while the vehicle is being controlled by Remote Operation function. Remote Operation function will turn off. At this time, the vehicle will turn off.
- Get on the vehicle with the smart key. Remote Operation function will turn off. At this time, the vehicle will remain on.

The function will pause in the following conditions when:

- There is a pedestrian, animal or object in the direction the vehicle is moving
- The door or liftgate is open
- The Forward (F) or Backward (B) button is not continuously pressed
- Simultaneously pressing multiple buttons on a smart key
- The smart key is not operated within 13 ft. (4 m) from the vehicle
- Button of another smart key is pressed in addition to the operating smart key
- Parking Collision-Avoidance Assist or Rear Cross-Traffic Collision-Avoidance Assist operates while the vehicle is being controlled in the reverse direction.
- The vehicle moves 22 ft. (7 m) while the smart key is pressed with Remote Operation function (maximum travel distance per button press)

The function will cancel in the following conditions when:

When Remote Operation function is canceled, the vehicle will automatically stop, shift the gear to P (Park) and engage EPB (Electronic Parking Brake).

- The steering wheel is steered
- The gear is shifted while the vehicle is moving
- Operating EPB while the vehicle is moving
- The hood is open
- The brake pedal or accelerator pedal is depressed when all the doors are closed
- The smart key is outside the vehicle when the brake pedal is depressed while the driver's door is open
- Rapid acceleration occurs
- Vehicle skid occurs
- The wheel is stuck by an obstacle and cannot move
- About 3 minutes and 50 seconds has passed after Remote Operation function has started to operate

- The slope of the road exceeds the operational range
- The function is paused for more than 1 minute
- The total travel distance of the vehicle has exceeded 45 ft. (14 m) after Remote Operation function operation
- The steering wheel, gearshift, braking, and drive controls are not working properly
- There is a problem with the smart key or the smart key battery is low
- ABS, TCS or ESC system operates due to slippery road conditions
- The alarm of the Theft Alarm System sounds

Remote Smart Parking Assist Malfunction and Limitations

Remote Smart Parking Assist malfunction

Remote Smart Parking Assist check

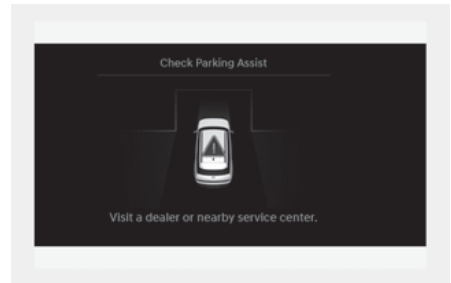

When Remote Smart Parking Assist is not working properly, the "**Check Parking Assist**" warning message will appear on the infotainment system. If the message appears, stop using Remote Smart Parking Assist, and have your vehicle inspected by an authorized HYUNDAI dealer.

Remote Smart Parking Assist canceled

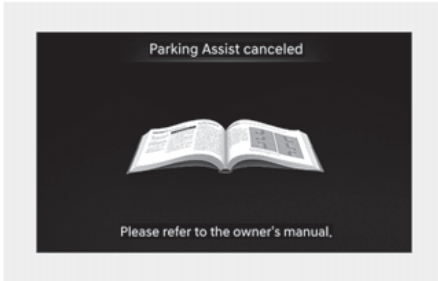

When Remote Parking Assist is operating, the function can be canceled, and the **"Parking Assist Canceled"** warning message may appear regardless of the parking order. Other messages may appear depending on the situations. Follow the instructions provided on the infotainment system while parking your vehicle with Remote Parking Assist. Always look around and pay attention when using Remote Smart Parking Assist.

Remote Smart Parking Assist standby

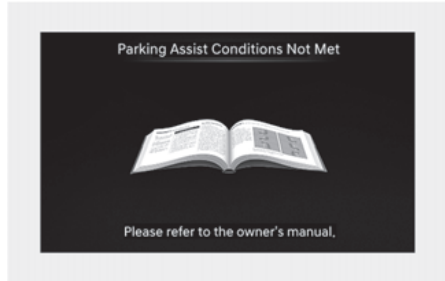

When **"Parking Assist Conditions Not Met"** message appears when Parking/View (ⓁⓅ) button has been pressed and held while Remote Smart Parking Assist is in standby. After a while, press and hold the Parking/View (ⓁⓅ) button again to see if Remote Smart Parking Assist works.

The message appears even when the smart key's battery is low. Check the smart key battery level.

Limitations of Remote Smart Parking Assist

In the following circumstances, Remote Smart Parking Assist performance to park or exit the vehicle may be limited, there may be a risk of collision, or Remote Smart Parking Assist may turn off. Park or exit the vehicle manually if necessary.

- Accessories are attached to the steering wheel, or steering components are modified
- The vehicle is installed with a snow chain, spare tire or different size wheel
- Tire pressure is lower or higher than the standard tire pressure
- Your vehicle is loaded with cargo longer or wider than your vehicle or a trailer is connected to your vehicle
- Wheel alignment has problems or suspension components are modified
- Braking system components such as brake discs, calipers, etc., are modified
- Your vehicle is leaned severely to one side
- Your vehicle is equipped with a trailer hitch
- The license plate is installed differently from the original location
- There is a person, animal or object above or below the ultrasonic sensor when Remote Smart Parking Assist is activated
- The parking space is curved or diagonal
- There is an obstacle such as a person, animal or object (trash can, bicycle, motorcycle, shopping cart, narrow pillar, etc.) near the parking space
- There is a circular pillar or narrow pillar, or a pillar surrounded by objects such as fire extinguisher, etc., near the parking space
- The road surface is bumpy (curbstone, speed bump, etc.)
- The road is slippery
- The parking space is near a vehicle with higher ground clearance or big, such as a truck, etc.
- The parking space is Inclined
- There is heavy wind
- Operating Remote Smart Parking Assist on uneven roads, gravel roads, bushes, etc.
- The performance of the ultrasonic sensor is affected by extremely hot or cold weather
- The ultrasonic sensor is covered with snow or water
- An object that generates ultrasonic waves is nearby
- A wireless device with a transmission function operates near the ultrasonic sensors
- Your vehicle is affected by another vehicle's Parking Distance Warning
- The sensor is mounted or positioned incorrectly by an impact to the bumper

- When the ultrasonic sensor cannot detect the following objects:
 - Sharp or slim objects, such as ropes, chains or small poles
 - Objects smaller than 40 in. (100 cm) in length and narrower than 6 in. (14 cm) in diameter
 - Objects which tend to absorb sensor frequency, such as clothes, spongy material or snow
 - A narrow object such as a corner of a square pillar
 - Person, animal or object near the ultrasonic sensor

Remote Smart Parking Assist may not operate properly under the following circumstances:

- Parking on inclines

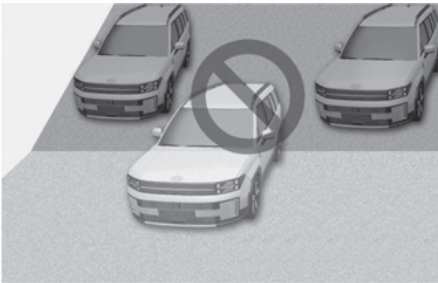

Park manually when parking on inclines.

- Parking on uneven road



Remote Smart Parking Assist may cancel when the vehicle slips, or the vehicle cannot move due to road conditions such as pebbles or fragmented stones.

- Parking behind a truck

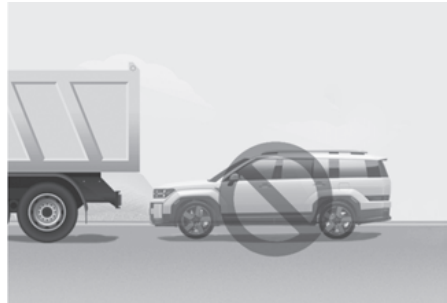

Do not use Remote Smart Parking Assist around vehicles with higher ground clearance, such as a bus, truck, etc. It may lead to a collision.

- Parking near a pillar

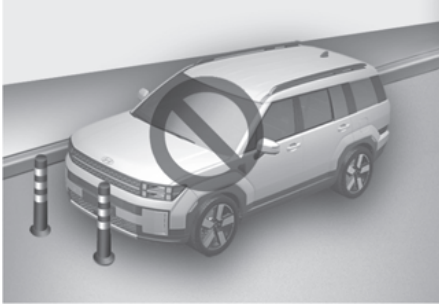

Remote Smart Parking Assist performance may reduce or collision with an obstacle may occur when there is a narrow object, circular pillar, square pillar, or a pillar surrounded by objects such as a fire extinguisher, etc., near the parking space. The driver should park the vehicle manually.

- Parking in a parking space with a vehicle on one side only

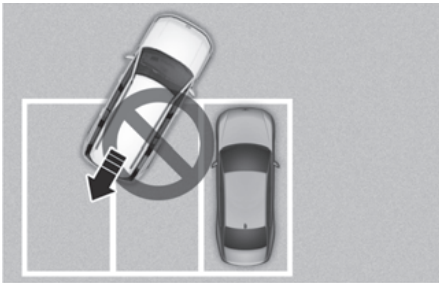

If Remote Smart Parking Assist is used, when parking in a parking space with a vehicle only on one side, your vehicle may cross the parking line to avoid the parked vehicle.

- Parking diagonal

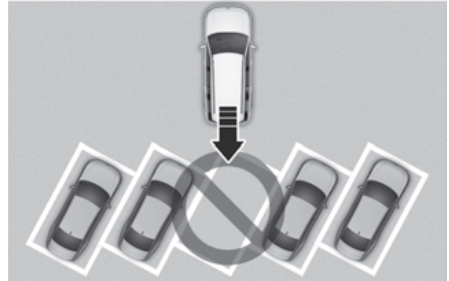

Remote Operation may not operate properly in a diagonal parking space.

- Parking in snow



Snow may interfere with sensor operation, or Remote Smart Parking Assist may cancel if the road is slippery while parking.



WARNING

Take the following precautions when using Remote Smart Parking Assist:

- The driver is responsible for safe parking and exit when using Remote Smart Parking Assist.
 - When using Remote Smart Parking Assist, stay out of the way in the direction the vehicle moves for your safety.
 - Always check surroundings when using Remote Smart Parking Assist. You may collide with pedestrians, animals, or objects if they are near the sensor or are in the sensor's blind spot area.
 - A collision may occur if a pedestrian, animal, or object suddenly appears while Remote Smart Parking Assist is operating.
 - Do not use Remote Smart Parking Assist when under the influence of alcohol.
 - Do not let children or other people to use the smart key.
 - If Remote Smart Parking Assist is used continuously for a long period, it may adversely affect Remote Smart Parking Assist performance.
 - Remote Smart Parking Assist may not operate properly if the vehicle needs wheel alignment adjustment such as when the vehicle tilts to one side. Have your vehicle inspected by an authorized HYUNDAI dealer.
- Noise may be heard when braking occurs by Remote Smart Parking Assist or when the brake pedal is depressed by the driver.
 - Remote Smart Parking Assist may suddenly apply the brake to avoid collision.
 - Use Remote Smart Parking Assist only in a parking space that is large enough for the vehicle to move safely.
-

NOTICE

- If the 3rd stage warning (continuous beep) of the Forward/Reverse Parking Distance Warning sounds while Remote Smart Parking Assist is operating, it means the obstacle detected is close to your vehicle. At this time, Remote Smart Parking Assist will temporarily stop operating. Make sure there are no pedestrians, animals, or objects around your vehicle.
 - Depending on brake operation, the stop lights may come on while the vehicle is moving.
 - If the vehicle is remotely started that has been parked in cold weather for a long time, the operation of Remote Smart Parking function may be delayed or canceled depending on vehicle condition.
-

Driver Assistance System Sensors

The Driver Assistance system on your vehicle uses cameras and sensors to help detect potential hazards in the vicinity of your vehicle.

Cameras

Front view camera



The front view camera is mounted near the top of the windshield inside your vehicle.

Wide-front view camera

+ if equipped



The wide-front view camera is mounted on the front grill outside your vehicle.

Wide-side view camera

+ if equipped



The wide-side view cameras are mounted to the bottom of the side view mirrors outside your vehicle.

Wide-rear view camera



The wide-rear view camera is mounted above the license plate holder outside your vehicle.

WARNING

To prevent serious injury or death:

- Never disassemble the camera sensors or camera sensor assemblies.
- Only have the detecting sensor replaced or repaired by an authorized HYUNDAI dealer.
- Never install any accessories, stickers, or tint the front windshield.
- Always keep the camera dry.
- Never place any reflective objects (e.g. white paper, mirror) on the dashboard.
- Do not use any cleanser containing acid or alkaline detergents when cleaning the camera lenses. Use only a mild soap or neutral detergent, and rinse thoroughly with water.

In-cabin camera

+ if equipped

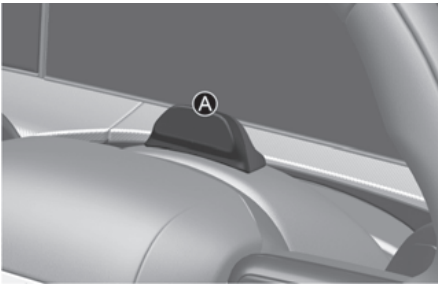

The in-cabin camera is mounted to the steering wheel.

CAUTION

Always keep the in-cabin camera in good condition to maintain optimal performance of Forward Attention Warning.

Radars

Front radar

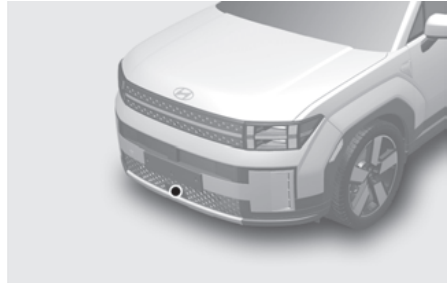

The front radar is mounted behind the front grill.

Front corner radar

+ if equipped

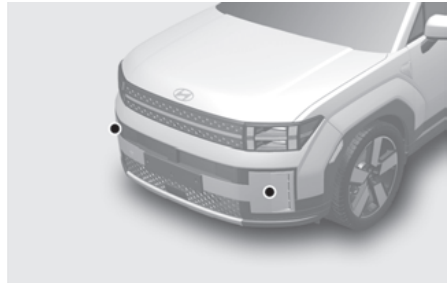

The front corner radars are mounted near the front corners of your vehicle above.

Rear corner radar

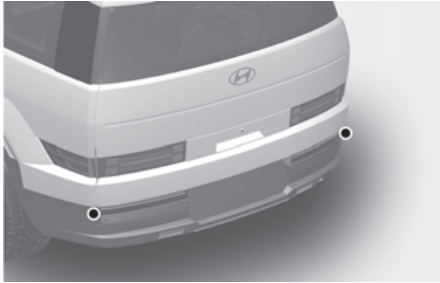

The rear corner radars are mounted near the rear corners of your vehicle above the bumper.

WARNING

To prevent serious injury or death:

- Never disassemble the radar or radar assembly, and never apply any impact on it.
- If there is impact on or near the radar, the sensors may be damaged or not be properly aligned near the radar, even though a warning message does not appear on the instrument cluster, Driver Assistance system may not operate properly. Have the vehicle inspected by an authorized HYUNDAI dealer.
- If the radars have been replaced or repaired, have the vehicle inspected by an authorized HYUNDAI dealer.
- Use only genuine HYUNDAI parts to repair the bumper where the radar is located.

- Do not install a license plate frame or other objects such as bumper sticker, film, bumper guard, or bumper wrap near the radar.
- Driver Assistance system may not work properly if the bumper has been replaced, or the surroundings of the radar has been damaged or painted.
- If a trailer or hitch mounted carrier is attached, it may adversely affect the performance of the rear corner radar or Driver Assistance system may not operate.

Ultrasonic sensors

Front ultrasonic sensors

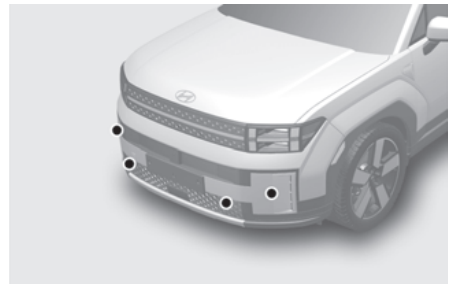

These ultrasonic sensors are mounted to the bumper outside your vehicle.

Front side ultrasonic sensors

 if equipped

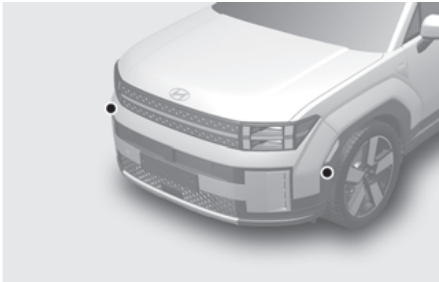

These ultrasonic sensors are mounted near the front wheels outside your vehicle.

Rear ultrasonic sensors

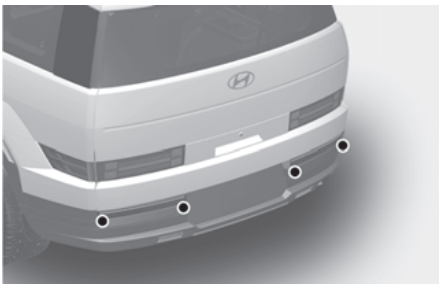

These ultrasonic sensors are mounted to the bumper outside your vehicle.

Rear side ultrasonic sensors

 if equipped



These ultrasonic sensors are mounted near the rear wheels outside your vehicle.

WARNING

To prevent serious injury or death:

- Always keep the ultrasonic sensors clean.
- Do not spray the ultrasonic sensors or the surrounding area directly with high pressure water.
- Do not apply objects such as bumper sticker or bumper guard, near the ultrasonic sensors or never apply paint to the bumper or other locations.
- Never disassemble or strike the ultrasonic sensors components.
- Do not modify the vehicle bumper height or ultrasonic sensor installations. Any non-factory installed equipment or accessories may also interfere with the sensor performance.
- If the ultrasonic sensors have been forcibly moved out of proper alignment or are damaged, have the vehicle inspected by an authorized HYUNDAI dealer.

Declaration Of Conformity

Front radar

The radio frequency components (Front Radar) complies :



FCC ID
: 2A30Z-MRR-35

This device complies with Part 15 of the FCC Rules. Operation is subject to the following two conditions:

- (1) this device may not cause harmful interference, and
- (2) this device must accept any interference received, including interference that may cause undesired operation.

CAUTION TO USERS

Changes or modifications not expressly approved by the party responsible for compliance could void the user's authority to operate the equipment.

Front corner radar (if equipped)/Rear corner radar

The radio frequency components (Rear Corner Radar) complies:



FCC ID : LTQ2H5TR

This device complies with Part 15 of the FCC Rules. Operation is subject to the following two conditions:

- (1) this device may not cause harmful interference, and
- (2) this device must accept any interference received, including interference that may cause undesired operation.

CAUTION TO USERS

Changes or modifications not expressly approved by the party responsible for compliance could void the user's authority to operate the equipment.

8. Emergency Situations

Hazard Warning Flasher	8-2
In Case Of An Emergency While Driving.....	8-2
If the engine stalls while driving	8-2
If the engine stalls at a crossroad or crossing.....	8-2
If you have a flat tire while driving.....	8-3
If The Engine Will Not Start.....	8-3
Jump Starting	8-4
If The Engine Overheats.....	8-7
Tire Pressure Monitoring System (TPMS)	8-8
Check tire pressure	8-9
Tire pressure monitoring system	8-9
Low Tire Pressure Warning Light.....	8-10
Low tire pressure position and tire pressure telltale	8-11
TPMS Malfunction Indicator	8-12
Changing a tire with TPMS	8-12
If You Have A Flat Tire (with Tire Mobility Kit).....	8-13
Introduction.....	8-14
Notes on the safe use of the Tire Mobility Kit.....	8-14
Components of the Tire Mobility Kit	8-16
Using the Tire Mobility Kit when a tire is flat	8-17
How to adjust tire pressure	8-20
Towing.....	8-21
Towing service	8-21

Hazard Warning Flasher

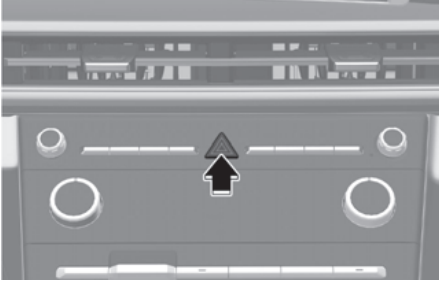

The hazard warning flashers warn other drivers to exercise extreme caution when approaching, overtaking, or passing your vehicle.

It should be used whenever making emergency repairs or when stopped near the edge of a roadway.

To turn on or off the hazard warning flasher, press the hazard warning flasher button with the Engine Start/Stop button in any position. The hazard warning flasher button is located in the center fascia panel. All turn signal lights flash simultaneously.

- The hazard warning flasher operates whether your vehicle is running or not.
- The turn signals do not work when the hazard flasher is on.

In Case Of An Emergency While Driving

If the engine stalls while driving

- Reduce the speed gradually, keeping a straight line. Move cautiously off the road to a safe place.
- Turn on your hazard warning flasher.
- Try to start the engine again. If your vehicle does not start, contact an authorized HYUNDAI dealer or seek other qualified assistance.

If the engine stalls at a crossroad or crossing

If the engine stalls at a crossroad or intersection, if safe to do so, shift the gear to N (Neutral) and then push the vehicle to a safe location.

If you have a flat tire while driving

If a tire goes flat while you are driving:

- Take your foot off the accelerator pedal and let the vehicle slow down while driving straight ahead. Do not apply the brakes immediately or attempt to pull off the road because this may cause loss of vehicle control resulting in a collision. When the vehicle has slowed to such a speed that it is safe to do so, brake carefully and pull off the road. Drive off the road as far as possible and park on a firm, level ground. If you are on a divided highway, do not park in the median area between the two traffic lanes.
- When the vehicle is stopped, press the hazard warning flasher button, shift the gear to P (Park), apply the parking brake, and move the Engine Start/Stop button to the OFF position.
- Have all passengers get out of the vehicle. Make sure they all get out on the side of the vehicle that is away from traffic.
- When replacing a flat tire, follow the instructions provided later in this chapter.

If The Engine Will Not Start

- Be sure to shift the gear to N (Neutral) or P (Park). The engine starts only when the gear is in N (Neutral) or P (Park).
- Turn on the interior light. If the light dims or goes out when you operate the starter, the battery is drained.

Refer to the instructions in "Jump Starting" provided in this chapter.

- Check the fuel level and add fuel if necessary.

If the vehicle still does not start, contact an authorized HYUNDAI dealer for assistance.

NOTICE

Starting the vehicle by pushing or pulling may cause the catalytic converter to overload and damage the emission control system.

Jump Starting

Jump starting can be dangerous if done incorrectly. Follow the jump starting procedure in this section to avoid serious injury or damage to your vehicle. If in doubt about how to properly jump start your vehicle, have a service technician or towing service do it for you.

WARNING

To prevent **SERIOUS INJURY** or **DEATH** to you or bystanders, always follow these precautions when working near or handling the battery:



Always read and follow instructions carefully when handling a battery.



Wear eye protection designed to protect the eyes from acid splashes.



Keep all flames, sparks, or smoking materials away from the battery.



Hydrogen is always present in battery cells, is highly combustible, and may explode if ignited.



Keep batteries out of reach of children.



Batteries contain sulfuric acid that is highly corrosive. Do not allow acid to contact your eyes, skin, or clothing. If acid gets into your eyes, flush your eyes with clean water for at least 15 minutes and get immediate medical attention. If acid gets on your skin, thoroughly wash the area. If you feel pain or a burning sensation, get medical attention immediately.

- When lifting a plastic-cased battery, excessive pressure on the case may cause battery acid to leak. Lift with a battery carrier or with your hands on opposite corners.
- Do not attempt to jump start your vehicle if your battery is frozen.
- NEVER attempt to recharge the battery when the vehicle's battery cables are connected to the battery.
- The electrical ignition system works with high voltage.
NEVER touch these components with the vehicle running or when the Start/Stop button is in the ON position.
- The electrical ignition system works with high voltage. NEVER touch these components Engine Start/Stop button in the ON or START position.

Jump starting procedure

1. Position the vehicles close enough that the jumper cables can reach. Do not allow the vehicles to touch.
2. Avoid fans or any moving parts in the engine compartment at all times, even when the vehicles are turned off.
3. Turn off all electrical devices such as radios, lights, air conditioning, etc. Put the vehicles in P (Park) and apply the parking brake. Turn both vehicles OFF.
4. Open the engine hood.

⚠ CAUTION

Before jump starting, make sure to correctly identify the positive (+) and negative (-) terminals to avoid reverse polarity connections.

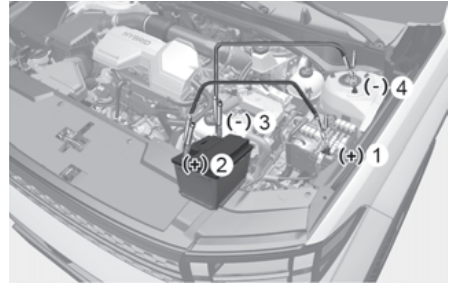

5. Connect the jumper cables in the exact sequence shown in the illustration. First connect one jumper cable to the red, positive (+) battery terminal of your vehicle (1).
6. Connect the other end of the jumper cable to the red, positive (+) battery/jumper terminal of the assisting vehicle (2).
7. Connect the second jumper cable to the black, negative (-) battery/jumper terminal of the assisting vehicle (3).
8. Connect the other end of the second jumper cable to the chassis ground of your vehicle (4).

Do not allow the jumper cables to contact anything except the correct battery or jumper terminals or the correct ground. Do not lean over the battery when making connections.

⚠ WARNING

Do not connect the jumper cable to the negative (-) jumper terminal of the discharged battery. A spark could cause the battery to explode and lead to a personal injury or vehicle damage.

9. Start the engine of the assisting vehicle and let it run at approximately 2,000 RPM for a few minutes. Then start your vehicle.
10. Keep your vehicle operating for at least 30 minutes at idle or driving to make sure your battery receives enough charge to be able to start on its own after the vehicle is shut off. A completely discharged battery may require as long as 60 minutes runtime to fully recharge. If the vehicle is run for less, the vehicle may not restart.

If your vehicle does not start after a few attempts, it probably requires service. Have your vehicle inspected by an authorized HYUNDAI dealer.

Disconnect the jumper cables in the exact reverse order you connected them:

1. Disconnect the jumper cable from the chassis ground of your vehicle (4).
2. Disconnect the other end of the jumper cable from the black, negative (-) battery/jumper terminal of the assisting vehicle (3).
3. Disconnect the second jumper cable from the red, positive (+) battery/jumper terminal of the assisting vehicle (2).
4. Disconnect the other end of the jumper cable from the red, positive (+) battery terminal of your vehicle (1).

i Information



An inappropriately disposed battery may be harmful to the environment and human health. Always dispose of a used battery according to your local law(s) or regulations.

NOTICE

To prevent damage to your vehicle:

- Only use a 12-volt power supply (battery or jumper system) to jump start your vehicle.
 - Do not attempt to jump start your vehicle by push-starting.
-

WARNING

While jump starting your vehicle, avoid the positive (+) and negative (-) cables to come in contact. A spark could cause personal injury.

If The Engine Overheats

If your temperature gauge indicates overheating, you experience a loss of power, hear loud pinging or knocking, or the engine may be overheating. If this happens, you must:

1. Pull off the road and stop as soon as it is safe to do so.
2. Shift the gear to P (Park) and apply the parking brake. If the air conditioning is ON, turn it OFF.
3. If engine coolant is running out under the vehicle or steam is coming out from the hood, stop the engine. Do not open the hood until the coolant has stopped running or the steaming has stopped. If there is no visible loss of engine coolant and no steam, leave the engine running and check to make sure the engine cooling fan is operating. If the fan is not running, turn off the engine.

WARNING



While the engine is running, keep hands, clothing, and tools away from the moving parts such as cooling fan and drive belt to prevent serious injury.

4. Check for coolant leaking from the radiator, hoses, or under the vehicle. (If air conditioning has been used, it is normal for cold water to be draining from it when you stop.)
5. If engine coolant is leaking out, stop the engine immediately and call the nearest authorized HYUNDAI dealer for assistance.

WARNING



Never remove the engine coolant cap or the drain plug while the engine and radiator are hot.

Hot coolant and steam may blow out under pressure, causing serious injury. Turn off the engine and wait until the engine cools down. Use extreme care when removing the coolant cap. Wrap a thick towel around it, and turn it counterclockwise slowly to the first stop. Step back while the pressure is released from the cooling system. When you are sure all the pressure has been released, press down on the cap, using a thick towel, and continue turning counterclockwise to remove it.

- If you cannot find the cause of the overheating, wait until the engine temperature has returned to normal. Then, if coolant has been lost, carefully add coolant to the reservoir to bring the fluid level in the reservoir up to the halfway mark.
- Proceed with caution, keeping alert for further signs of overheating. If overheating happens again, contact an authorized HYUNDAI dealer for assistance.

NOTICE

- Serious loss of coolant indicates a leak in the cooling system. Have the system inspected by an authorized HYUNDAI dealer as soon as possible.
- When the engine overheats from low engine coolant, suddenly adding engine coolant may cause cracks in the engine. To prevent damage, add engine coolant slowly in small quantities. It may require several refilling cycles to properly fill the engine cooling system. If necessary, contact an authorized HYUNDAI dealer.

Tire Pressure Monitoring System (TPMS)

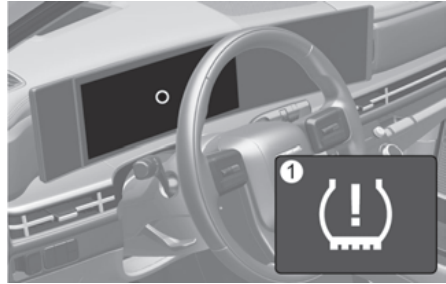

- Low Tire Pressure Telltale/TPMS Malfunction Indicator
- Low Tire Pressure Position Telltale and Tire Pressure Telltale (Shown on the cluster display)

Check tire pressure



- You can check the tire pressure in the utility view mode in the cluster display. Refer to the "View modes" section in chapter 4.
- Tire pressure appears after a few minutes of driving. If the tire pressure does not appear when the vehicle is stopped, the message, "**Drive to display**" appears.
- The displayed tire pressure values may differ from those measured with a tire pressure gauge.
- You can change the tire pressure unit from the Settings menu in the infotainment system. Select:
 - **Setup > General > Units > Tire Pressure Unit > psi, kpa, bar**

i Information

The infotainment system may change after software updates. For more information, refer to the user's manual provided in the infotainment system and the quick reference guide.

Tire pressure monitoring system

WARNING

Over-inflation or under-inflation can reduce tire life, adversely affect vehicle handling, and lead to sudden tire failure that may cause loss of vehicle control resulting in a collision.

Each tire, including the spare (if provided), should be checked monthly when cold and inflated to the inflation pressure recommended by the vehicle manufacturer on the vehicle placard or tire inflation pressure label. (If your vehicle has tires of a different size than the size indicated on the vehicle placard or tire inflation pressure label, you should determine the proper tire inflation pressure for those tires.)

As an added safety feature, your vehicle has been equipped with a tire pressure monitoring system (TPMS) that illuminates a low tire pressure telltale when one or more of your tires is significantly under-inflated. Accordingly, when the low tire pressure telltale illuminates, you should stop and check your tires as soon as possible, and inflate them to the proper pressure. Driving on a significantly under-inflated tire causes the tire to overheat and can lead to tire failure.

Under-inflation also reduces fuel efficiency and tire tread life, and may affect the vehicle's handling and stopping ability.

Please note that the TPMS is not a substitute for proper tire maintenance, and it is the driver's responsibility to maintain correct tire pressure, even if under-inflation has not reached the level to trigger illumination of the TPMS low tire pressure telltale.

Your vehicle has also been equipped with a TPMS malfunction indicator to indicate when the system is not operating properly. The TPMS malfunction indicator is combined with the low tire pressure telltale. When the system detects a malfunction, the telltale flashes for approximately one minute and then remains continuously illuminated. This sequence continues upon subsequent vehicle start-ups as long as the malfunction exists.

When the malfunction indicator is illuminated, the system may not be able to detect or signal low tire pressure as intended. TPMS malfunctions may occur for a variety of reasons, including the installation of replacement or alternate tires or wheels on the vehicle that prevent the TPMS from functioning properly.

Always check the TPMS malfunction telltale after replacing one or more tires or wheels on your vehicle to ensure that the replacement or alternate tires and wheels allow the TPMS to continue to function properly.

NOTICE

Have the system inspected by an authorized HYUNDAI dealer if:

1. The Low Tire Pressure Telltale/TPMS Malfunction Indicator does not illuminate for 3 seconds when the Engine Start/Stop button is moved to the ON position or the engine is running.
 2. The TPMS Malfunction Indicator remains illuminated after blinking for about 1 minute.
 3. The Low Tire Pressure Position Telltale remains illuminated.
-

Low Tire Pressure Warning Light



Low tire pressure position and tire pressure telltale



TPMS is not a substitute for manually checking the tire pressure with a tire gauge. Changes in temperature affect tire pressure. Refer to "Check tire inflation pressure" in the Maintenance chapter for proper tire inflation and tire pressure measurement procedure.

When the tire pressure monitoring system warning indicators illuminate and a warning message appears on the cluster display, one or more of your tires are significantly under-inflated. The Low Tire Pressure Position Telltale indicates which tire is significantly under-inflated by illuminating the corresponding parking light.

If either telltale illuminates, immediately reduce the vehicle speed, avoid hard cornering and anticipate increased stopping distances. Stop and check your tires as soon as possible. Inflate the tires to the proper pressure as indicated on the vehicle's placard or tire inflation pressure label located on the driver's side center pillar outer panel.

If you cannot reach a service station or the tire cannot hold the newly added air, replace the low pressure tire with the spare tire.

The Low Tire Pressure Telltale remains on and the TPMS Malfunction Indicator may blink for one minute and then remain illuminated (when the vehicle is driven about 10 minutes at the speed above 15.5 mph (25 km/h)) until you have the low pressure tire repaired and replaced on the vehicle.

WARNING

In winter or cold weather, the Low Tire Pressure Telltale may be illuminated if the tire pressure was adjusted to the recommended tire inflation pressure in warm weather. It does not mean your TPMS is malfunctioning because the decreased temperature leads to a proportional lowering of tire pressure.

When you drive your vehicle from a warm area to a cold area or from a cold area to a warm area, or the outside temperature is greatly higher or lower, check the tire inflation pressure and adjust the tires to the recommended tire inflation pressure.

WARNING

Low pressure damage

Significantly low tire pressure makes the vehicle unstable and may contribute to loss of vehicle control and increased braking distances.

Continued driving on low pressure tires may cause the tires to overheat and fail.

TPMS Malfunction Indicator



The TPMS Malfunction Indicator illuminates after it blinks for about one minute when there is a problem with the Tire Pressure Monitoring System.

Have the system inspected by an authorized HYUNDAI dealer as soon as possible.

NOTICE

If there is a malfunction with the TPMS, the individual tire pressures on the cluster display are not be available. Have the system inspected by an authorized HYUNDAI dealer as soon as possible.

NOTICE

The TPMS Malfunction Indicator may illuminate after blinking for one minute if the vehicle is near electric power supply cables or radio transmitters such as police stations, government and public offices, broadcasting stations, military installations, airports, transmitting towers, etc.

Additionally, the TPMS Malfunction Indicator may illuminate if snow chains are used or if electronic devices such as computers, chargers, remote starters, navigation, etc. are near the vehicle. This may interfere with normal operation of the TPMS.

Changing a tire with TPMS

If you have a flat tire, the Low Tire Pressure and Position telltales come on. Have the flat tire repaired by an authorized HYUNDAI dealer as soon as possible or replace the flat tire with the spare tire.

NOTICE

Do not use a puncture-repair kit not approved by HYUNDAI. Tire sealant not approved by HYUNDAI or the equivalent sealant specified for your vehicle may damage the tire pressure sensor.

The spare tire (if equipped) does not come with a tire pressure monitoring sensor. When the low pressure tire or the flat tire is replaced with the spare tire, the Low Tire Pressure Telltale remains on.

Also, the TPMS Malfunction Indicator illuminates after blinking for one minute if the vehicle is driven at the speed above 15.5 mph (25 km/h) for about 10 minutes.

Once the original wheel equipped with a tire pressure monitoring sensor is reinflated to the recommended pressure and reinstalled on the vehicle, the Low Tire Pressure Telltale and TPMS Malfunction Indicator goes off within a few minutes of driving.

If the indicators do not turn off after a few minutes, visit an authorized HYUNDAI dealer.

Each wheel is equipped with a tire pressure sensor mounted inside the tire behind the valve stem (except for the spare tire). You must use TPMS specific wheels. It is recommended that you always have your tires serviced by an authorized HYUNDAI dealer.

You may not be able to identify a tire with low pressure by simply looking at it. Always use a good quality tire pressure gauge to measure. Note that a tire that is hot (from being driven) has a higher pressure measurement than a tire that is cold.

A cold tire means the vehicle has been sitting for 3 hours and driven for less than 1 mi. (1.6 km) in that 3 hour period.

Allow the tire to cool before measuring the inflation pressure. Always make sure the tire is cold before inflating to the recommended pressure.

WARNING

- The TPMS cannot alert you to severe and sudden tire damage caused by external factors such as nails or road debris.
- If you feel any vehicle instability, immediately take your foot off the accelerator pedal, apply the brakes gradually with light force, and slowly move to a safe position off the road.

WARNING

Tampering with, modifying, or disabling the Tire Pressure Monitoring System (TPMS) components may interfere with the system's ability to warn the driver of low tire pressure conditions and/or TPMS malfunctions and may void the warranty.

If You Have A Flat Tire (with Tire Mobility Kit)

 if equipped



- (1) Compressor
- (2) Sealant bottle

For safe operation, carefully read and follow the instructions in this manual before use.

The Tire Mobility Kit is a temporary fix to the tire, have the tire replaced by an authorized HYUNDAI dealer as soon as possible.

CAUTION

When two or more tires are flat, do not use the Tire Mobility Kit because the sealant provided with the Tire Mobility Kit must be used for only one flat tire.

WARNING

- Do not use the Tire Mobility Kit to repair punctures in the tire walls. This can result in a crash due to tire failure.
- Have your tire repaired as soon as possible. The tire may lose air pressure at any time after inflating with the Tire Mobility Kit.

Introduction

With the Tire Mobility Kit you stay mobile even after experiencing a tire puncture.

The compressor and sealing compound system effectively and comfortably seals most punctures in a passenger car tire caused by nails or similar objects and reinflates the tire.

After you ensure that the tire is properly sealed you can drive cautiously on the tire (distance up to 120 mi. (200 km)) at a maximum speed of 50 mph (80 km/h) in order to reach a service station or tire dealer for tire replacement.

It is possible that some tires, especially with larger punctures or damage to the sidewall, cannot be sealed completely.

Air pressure loss in the tire may adversely affect tire performance.

For this reason, you should avoid abrupt steering or other driving maneuvers, especially if the vehicle is heavily loaded or if a trailer is in use.

The Tire Mobility Kit is not designed or intended as a permanent tire repair method and is to be used for one tire only.

This instruction shows you step by step how to temporarily seal the puncture simply and reliably.

Read the section "Notes on the safe use of the Tire Mobility Kit".

Notes on the safe use of the Tire Mobility Kit

- Park your vehicle at the side of the road so that you can work with the Tire Mobility Kit away from moving traffic.
- To be sure your vehicle does not move, even when you are on level ground, always apply your parking brake.
- Only use the Tire Mobility Kit for sealing/inflation passenger car tires. Only punctured areas located within the tread region of the tire can be sealed using the tire mobility kit.
- Do not use on motorcycles, bicycles or any other type of tires.
- When the tire and wheel are damaged, do not use Tire Mobility Kit.
- Use of the Tire Mobility Kit may not be effective for tire damage larger than about 0.16 in (4 mm).
Contact an authorized HYUNDAI dealer if the tire cannot be made roadworthy with the Tire Mobility Kit.
- Do not use the Tire Mobility Kit if a tire is severely damaged by driving run flat or with insufficient air pressure.
- Only punctured areas located within the tread region of the tire can be sealed using the Tire Mobility Kit.
- Do not remove any foreign objects such as nails or screws that have penetrated the tire.

- Provided the vehicle is outdoors, leave the vehicle running. Otherwise operating the compressor may eventually drain the car battery.
- Never leave the Tire Mobility Kit unattended while it is being used.
- Do not leave the compressor running for more than 10 minutes at a time or it may overheat.
- Do not use the Tire Mobility Kit if the ambient temperature is below -22 °F (-30 °C).
- In case of skin contact with the sealant, wash the area thoroughly with plenty of water. If the irritation persists, seek medical attention.
- In case of eye contact with the sealant, flush your eyes for at least 15 minutes. If the irritation persists, seek medical attention.
- In case of swallowing the sealant, rinse the mouth and drink plenty of water. However, never give anything to an unconscious person and seek medical attention immediately.
- Long time exposure to the sealant may cause damage to bodily tissue such as kidney, etc.

Components of the Tire Mobility Kit

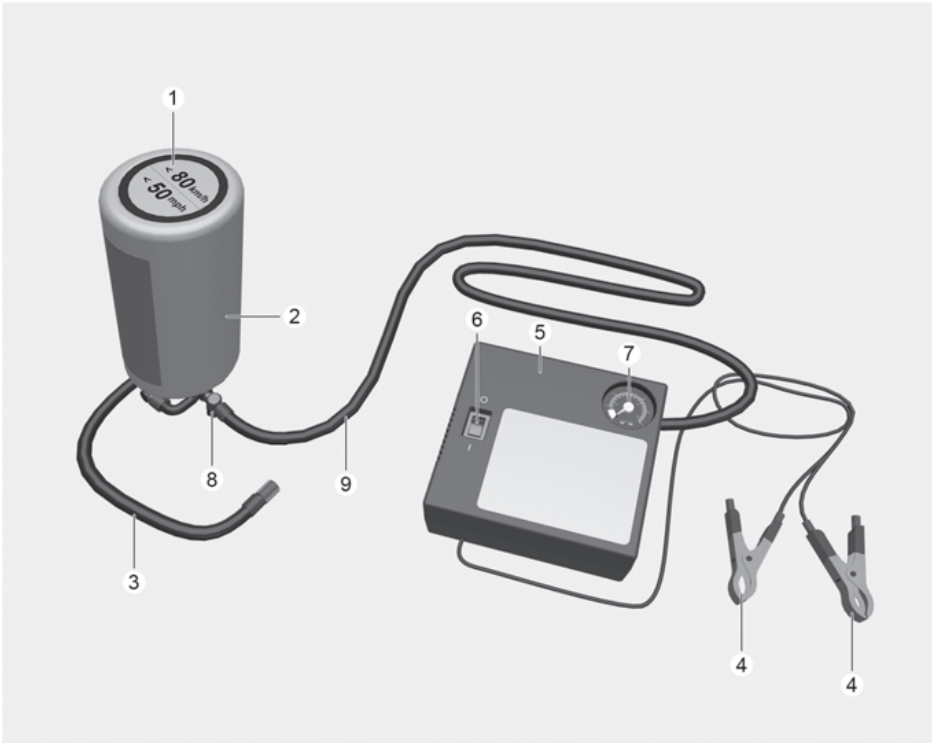

- (1) Speed restriction label
- (2) Sealant bottle
- (3) Filling hose
- (4) Connectors and cable for terminal connection
- (5) Compressor
- (6) ON/OFF switch
- (7) Pressure gauge for displaying the tire inflation pressure
- (8) Button for reducing the tire inflation pressure
- (9) Filling hose from sealant bottle to wheel

Strictly follow the specified sequence, otherwise the sealant may escape under high pressure.

WARNING

Do not use the tire sealant after the sealant has expired (the expiration date is pasted on the sealant container). This can increase the risk of tire failure.

⚠ WARNING**Sealant**

- Keep out of reach of children.
- Avoid contact with eyes.
- Do not swallow.

Using the Tire Mobility Kit when a tire is flat**⚠ CAUTION**

Detach the speed restriction label (1) from the sealant bottle (2), and place it in a highly visible place inside the vehicle such as on the steering wheel to remind the driver not to drive too fast.

⚠ CAUTION

If only the tire pressure needs to be adjusted, refer to the "How to adjust tire pressure" section in this chapter.

Before using the Tire Mobility Kit, be fully aware of the explanation on the sealant.

1. Shake the sealant bottle (2).
2. Connect the filling hose on the compressor to the sealant bottle (A). Keep the sealant bottle upright so the filling hose is heading upwards.

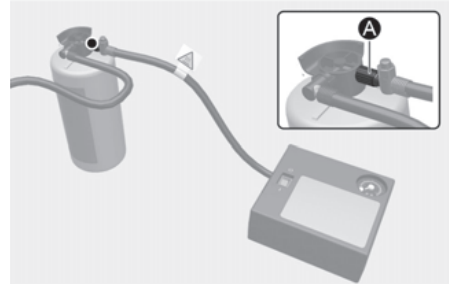

3. Unscrew the valve cap from the valve of the defective wheel and screw the filling hose (3) of the sealant bottle onto the tire valve.

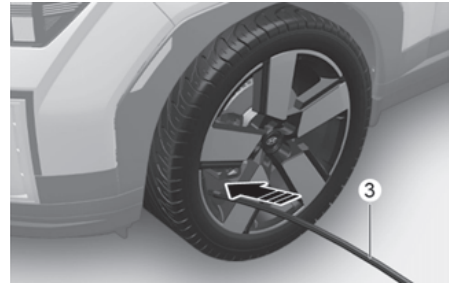
**⚠ CAUTION**

Securely install the sealant filling hose to the valve. If not, sealant may flow backward, possibly clogging the filling hose.

4. Ensure that the compressor is switched OFF.
5. Open the engine hood.
6. Remove the engine compartment fuse box cover.

Connect the cables (4) to the (+) jumper terminal in the engine compartment fuse panel and the (-) jumper terminal in numerical order.

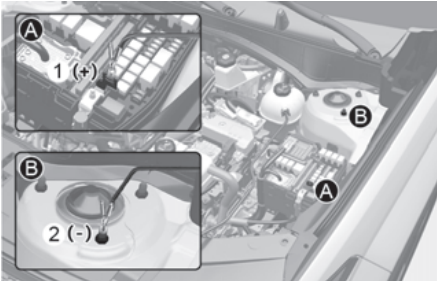

- (1) RED cable : (+) jumper terminal in the engine compartment fuse panel
- (2) BLACK cable : (-) jumper terminal

CAUTION

- TMK cable connection can be dangerous if done incorrectly. Therefore, to avoid harm to yourself or damage to the TMK or battery, follow the TMK cable connection procedures.
 - When disconnecting the TMK cables, disconnect the BLACK (-) cable first from the jumper terminal and then disconnect the RED (+) cable.
 - Be careful for battery sparks when connecting or disconnecting the battery cables.
-

7. With the engine ON, switch on the compressor and let it run for about 5-7 minutes to fill the sealant up to proper pressure. (refer to the "Tires And Wheels" section in chapter 10). The inflation pressure of the tire after filling is unimportant and can be checked/corrected later.

Be careful not to overinflate the tire and stay away from the tire when filling it.

CAUTION

Do not attempt to drive your vehicle if the tire pressure is below 29 psi (200 kPa). This could result in a crash due to sudden tire failure.

8. Switch off the compressor.
9. Detach the hoses from the sealant bottle connector and from the tire valve.

Return the Tire Mobility Kit to its storage location in the vehicle.

WARNING

Do not leave your engine running in a poorly ventilated area for extended periods of time. Carbon monoxide poisoning and suffocation can occur.

10. Immediately drive about 4-6 mi. (7-10 km or about 10 minutes) to evenly distribute the sealant in the tire.

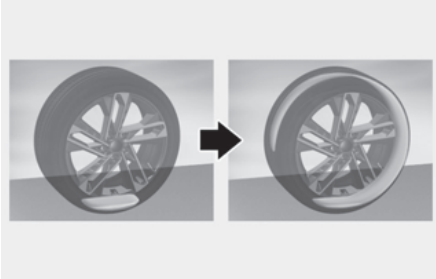

Do not exceed a speed of 50 mph (80 km/h). If possible, do not fall below a speed of 12 mph (20 km/h).

While driving, if you experience any unusual vibration, ride disturbance or noise, reduce your speed and drive with caution until you can safely pull off of the side of the road.

Call for road side service or towing.

11. After driving about 4-6 mi. (7-10 km or about 10 minutes), stop at a safety location.
12. Connect the filling hose (9) of the compressor directly to the tire valve.



13. Remove the engine compartment fuse box cover.

Connect cables (4) to the jumper terminals in numerical order.

14. Adjust the tire inflation pressure to the recommended tire inflation.

With the engine running, proceed as follows:

- To increase the inflation pressure: Switch on the compressor. To check the current inflation pressure setting, briefly switch off the compressor.
- To reduce the inflation pressure: Press the button (9) on the compressor.

NOTICE

Do not let the compressor run for more than 10 minutes, otherwise the device may overheat and may be damaged.

i Information

The pressure gauge may show higher than actual reading when the compressor is running. To get an accurate tire pressure, the compressor needs to be turned off.

⚠ CAUTION

- If the tire inflation pressure is not maintained, drive the vehicle a second time, refer to step 9. Then repeat steps 10 to 13.
- Use of the Tire Mobility Kit may not be effective for tire damage larger than about 0.16 in. (4 mm).

Contact an authorized HYUNDAI dealer if the tire cannot be made roadworthy with the Tire Mobility Kit.

WARNING

The tire inflation pressure must be inflated to the proper pressure, refer to the "Tires And Wheels" section of the complete Owner's Manual. If it is not inflated, do not continue to drive.

Call for road side service or towing.

CAUTION

Tire pressure sensor

The sealant on the tire pressure sensor and wheel should be removed when you replace the tire with a new one and inspect the tire pressure sensors. Have this done at an authorized HYUNDAI dealer.

Information

When reinstalling the repaired or replaced tire and wheel on the vehicle, tighten the wheel nut to 79-94 lbf-ft (11-13 kgf-m).

How to adjust tire pressure

1. Park your vehicle in a safe location.
2. Connect the filling hose (9) of the compressor directly to the tire valve.



3. Remove the engine compartment fuse box cover.

Connect cables (4) to the jumper terminals in numerical order.

4. Adjust the tire inflation pressure to the recommended tire inflation.

With the engine running, proceed as follows:

- To increase the inflation pressure: Switch on the compressor. To check the current inflation pressure setting, briefly switch off the compressor.
- To reduce the inflation pressure: Press the button (9) on the compressor.

NOTICE

Do not let the compressor run for more than 10 minutes, otherwise the device may overheat and may be damaged.

i Information

- The pressure gauge may show higher than actual reading when the compressor is running. To get an accurate tire reading, the compressor needs to be turned off.
- When reinstalling the repaired or replaced tire and wheel on the vehicle, tighten the wheel nut to 79-94 lbf-ft (11-13kgf-m).

CAUTION

Do not use the sealant when the tire pressure only needs to be adjusted.

WARNING

The tire inflation pressure must be inflated to the proper pressure, refer to the "Tires And Wheels" section in chapter 10. If it is not inflated, do not continue to drive.

Call for road side service or towing.

Towing

Towing service

Flatbed Towing

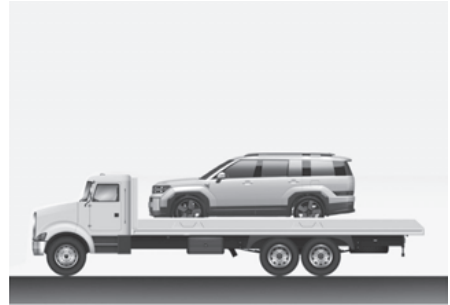

Wheel lift Towing

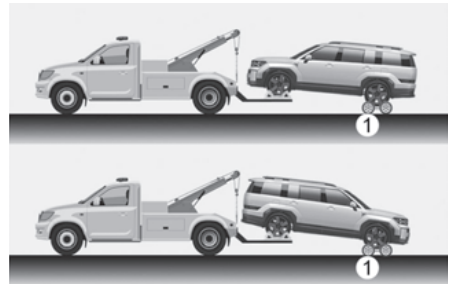

(1) Dollies

If towing is necessary, contact an authorized HYUNDAI dealer or a commercial tow-truck service.

4WD vehicles must be towed with a wheel lift and dollies or flatbed with all the wheels off the ground.

2WD vehicles can be towed with the rear wheels on the ground (without dollies) and the front wheels off the ground.

The use of wheel dollies or flatbed is recommended. If any of the loaded wheels or suspension components are damaged or the vehicle is towed with the front wheels on the ground, use a towing dolly under the front wheels.

NOTICE

To prevent damage when towing:

- Do not lift using the trailer hitch or body and chassis parts.
- Do not tow the vehicle with the front wheels on the ground.

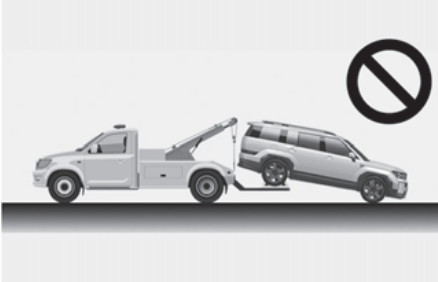

- Do not tow vehicles with sling-type equipment. Only use wheel lift or flatbed equipment.

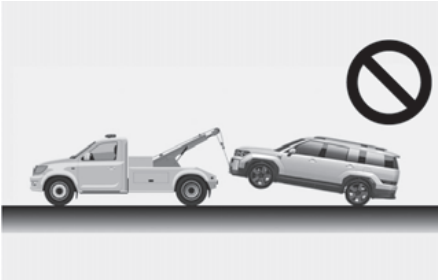

When towing your vehicle without wheel dollies:

1. Release the parking brake before turning off the engine.
2. Place the Engine Start/Stop button to the OFF position.
3. Change the gear to N (Neutral) while depressing the brake pedal.
4. Place the Engine Start/Stop button to the ACC position.

⚠ WARNING

If your vehicle is equipped with a rollover sensor, move the Engine Start/Stop button in the OFF or ACC position when the vehicle is being towed. The side impact and curtain air bag may deploy if the sensor detects the situation as a rollover.

i Information

Always shift the gear to N (Neutral) to prevent damage to the transmission before towing.

9. Maintenance

Engine Compartment.....	9-4
Maintenance Services.....	9-5
Guide to hyundai genuine parts.....	9-5
Owner's responsibility.....	9-6
Owner maintenance precautions.....	9-6
Owner Maintenance.....	9-7
Owner maintenance schedule.....	9-7
Scheduled Maintenance Services.....	9-10
Normal maintenance schedule.....	9-12
Maintenance under severe usage and low mileage conditions.....	9-15
Explanation Of Scheduled Maintenance Items.....	9-17
Engine oil and filter.....	9-17
HSG (Hybrid Starter & Generator) belts.....	9-17
Fuel lines, fuel hoses and connections.....	9-17
Fuel filter.....	9-17
Vapor hose and fuel filler cap.....	9-17
Vacuum crankcase ventilation hoses.....	9-17
Air cleaner filter.....	9-17
Spark plugs.....	9-18
Cooling system.....	9-18
Engine coolant/battery system coolant.....	9-18
Automatic Transmission fluid.....	9-18
Brake hoses and lines.....	9-18
Brake fluid.....	9-18
Parking brake.....	9-18
Brake discs, pads, calipers, and rotors.....	9-19
Exhaust pipe and muffler.....	9-19
Drive shaft and related.....	9-19
Suspension mounting bolts.....	9-19
Steering gear box, linkage & boots/lower arm ball joint.....	9-19
Air conditioning refrigerant.....	9-19
Engine Oil.....	9-19
Checking the engine oil level.....	9-19
Checking the engine oil and filter.....	9-20
Engine Coolant/Battery System Coolant.....	9-21
Checking the coolant level.....	9-21

Changing coolant	9-24
Brake Fluid.....	9-24
Checking the brake fluid level	9-24
Washer Fluid.....	9-25
Checking the washer fluid level	9-25
Hybrid Starter & Generator (HSG) Belt	9-26
Checking the Hybrid Starter & Generator (HSG) belt	9-26
Air Cleaner	9-26
Filter replacement	9-26
Cabin Air Filter.....	9-27
Filter inspection	9-27
Filter replacement	9-27
Wiper Blades	9-28
Blade inspection	9-28
Blade replacement	9-29
Battery	9-30
For longer battery life.....	9-31
Battery capacity label	9-32
Battery recharging	9-32
Reset items	9-33
Tires And Wheels.....	9-34
Tire Care	9-34
Recommended cold tire inflation pressures	9-35
Check tire inflation pressure.....	9-35
Tire rotation	9-36
Wheel alignment and tire balance	9-37
Tire replacement	9-37
Wheel replacement	9-38
Tire traction.....	9-38
Tire maintenance.....	9-38
Tire sidewall labeling.....	9-38
Tire terminology and definitions	9-42
All season tires.....	9-45
Summer tires	9-45
Snow tires	9-45

9. Maintenance

Radial-ply tires	9-45
Low aspect ratio tires	9-46
Fuses.....	9-47
Instrument panel fuse replacement	9-48
Engine compartment panel fuse replacement.....	9-48
Fuse panel description	9-50
Light Bulbs	9-58
Headlight, parking light, turn signal light, daytime running light (DRL) replacement	9-59
Side repeater light replacement	9-60
Rear combination light replacement.....	9-60
High mounted stop light replacement	9-61
License plate light replacement	9-61
Interior light replacement	9-61
Appearance Care	9-62
Exterior care	9-62
Interior care.....	9-67
Emission Control System	9-70
1. Crankcase emission control system.....	9-70
2. Evaporative emission control system including onboard refueling vapor recovery (ORVR)	9-70
3. Exhaust emission control system	9-71
Fuel Requirements	9-72
Gasoline engine.....	9-72
California Perchlorate Notice	9-74

Engine Compartment

Smartstream G1.6 T-GDi HEV

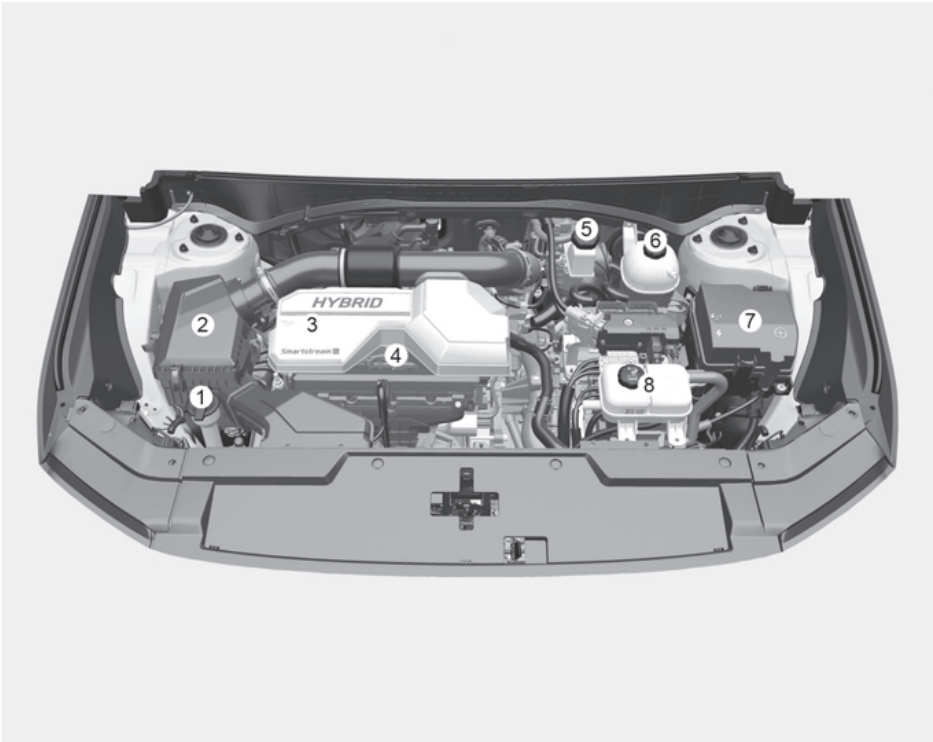

The actual engine compartment in the vehicle may differ from the illustration.

- (1) Windshield washer fluid reservoir
- (2) Air cleaner
- (3) Engine oil filler cap
- (4) Engine oil dipstick
- (5) Brake fluid reservoir
- (6) Engine coolant reservoir
- (7) Fuse box
- (8) Battery system coolant reservoir

Maintenance Services

Exercise the utmost care to prevent damage to your vehicle and injury to yourself whenever performing any maintenance or inspection procedures.

Have your vehicle maintained and repaired by an authorized HYUNDAI dealer. An authorized HYUNDAI dealer meets HYUNDAI's high service quality standards and receives technical support from HYUNDAI in order to provide you with a high level of service satisfaction.

Guide to hyundai genuine parts

1. What are HYUNDAI Genuine Parts?

HYUNDAI Genuine Parts are the parts used by HYUNDAI Motor Company to manufacture vehicles. They are designed and tested for the optimum safety, performance, and reliability for our customers.



2. Why Hyundai Genuine Parts?

HYUNDAI Genuine Parts are engineered and built to meet rigid manufacturing requirements. Damage caused by using imitation, counterfeit, or used salvage parts is not covered under the HYUNDAI New Vehicle Limited Warranty or any other HYUNDAI warranty.

In addition, any damage to or failure of HYUNDAI Genuine Parts caused by the installation or failure of an imitation, counterfeit or used salvage part are not covered by any HYUNDAI Warranty.



3. How can you tell if you are purchasing HYUNDAI Genuine Parts?

Look for the HYUNDAI Genuine Parts Logo on the package (see below).

HYUNDAI Genuine Parts exported to the U.S. are packaged with labels written only in English.

HYUNDAI Genuine Parts are only sold through authorized HYUNDAI Dealerships.

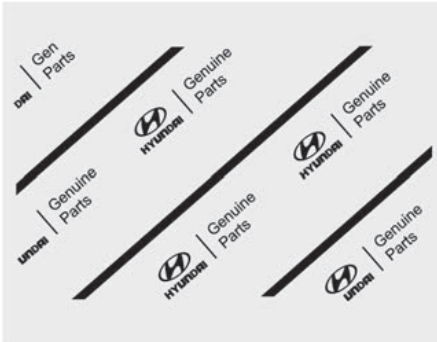

Owner's responsibility

Maintenance service and record retention are the owner's responsibility.

Retain documents that show proper maintenance has been performed on your vehicle in accordance with the scheduled maintenance service charts on the following pages. You need this information to establish your compliance with the servicing and maintenance requirements of your vehicle warranties.

Detailed warranty information is provided in your Owner's Handbook & Warranty Information booklet.

Repairs and adjustments required as a result of improper maintenance or a lack of required maintenance are not covered.

Owner maintenance precautions

Inadequate, incomplete, or insufficient servicing may result in operational problems with your vehicle that could cause vehicle damage or a collision that results in serious injury or death.

Your vehicle must not be modified in any way. Such modifications may adversely affect the performance, safety, or durability of your vehicle and may, in addition, violate conditions of the limited warranties covering the vehicle.

NOTICE

Improper owner maintenance during the warranty period may affect warranty coverage. For more information, read the separate Owner's Handbook & Warranty Information Booklet provided with the vehicle.

Owner Maintenance

WARNING

Performing maintenance on the vehicle can be dangerous. If you lack sufficient knowledge, experience, or proper tools and equipment to do the work, have it done by an authorized HYUNDAI dealer. Before performing maintenance:

- Park your vehicle on level ground. Shift the vehicle to P (Park), apply the parking brake, and move the Engine Start/Stop button to the OFF position.
- Block the tires (front and back) to prevent the vehicle from moving. Remove loose clothing or jewelry that can become entangled in moving parts.
- If you must run the engine during maintenance, do it in an outdoor area or in an area with plenty of ventilation.
- Keep flames, sparks, or smoking materials away from the battery and fuel-related parts.

WARNING

Do not touch metal parts (including strut bars) while the engine is operating or hot to prevent serious injury. Turn off the engine and wait until the metal parts cool down before working on the vehicle.

The following lists are vehicle checks and inspections that should be performed by the owner or an authorized HYUNDAI dealer at the frequencies indicated to help ensure safe and dependable operation of your vehicle.

Any adverse conditions should be brought to the attention of your authorized HYUNDAI dealer as soon as possible.

These Owner Maintenance vehicle checks are generally not covered by warranties and you may be charged for labor, parts, and lubricants used.

Owner maintenance schedule

When you stop for fuel:

- Check the windshield washer fluid level.
- Check for low or under-inflated tires.

While operating your vehicle:

- Note any changes in the sound of the exhaust or any smell of exhaust fumes in the vehicle.
- Check for vibrations in the steering wheel. Notice if there is any increased steering effort or looseness in the steering wheel, or change in its straight-ahead position.
- Notice if your vehicle constantly turns slightly or "pulls" to one side when traveling on a smooth, level road.
- When stopping, listen and check for unusual sounds, pulling to one side, increased brake pedal travel, or "hard-to-push" brake pedal.
- If any slipping or changes in the operation of your transmission occurs, check the transmission fluid level.
- Check the transmission P (Park) function.
- Check the parking brake.
- Check for fluid leaks under your vehicle (water dripping from the air conditioning system during or after use is normal).

At least monthly:

- Check the coolant level in the engine coolant reservoir.
- Check the operation of all exterior lights, including the headlights, brake lights, turn signals, and hazard warning flashers.
- Check the inflation pressures of all tires including the spare for tires that are worn, show uneven wear, or are damaged.
- Check for loose wheel nuts.

WARNING

Be careful when checking your coolant level if the engine is hot. This may result in coolant being blown out of the opening and cause serious burns and other injuries.

At least twice a year:

- Check the radiator, heater, and air conditioning hoses for leaks or damage.
- Check the windshield washer spray and wiper operation. Clean the wiper blades with a clean cloth dampened with washer fluid.
- Check the headlight alignment.
- Check the muffler, exhaust pipes, shields, and clamps.
- Check the seat belts for wear and function.

At least once a year:

- Clean the body and door drain holes.
- Lubricate the door hinges and hood hinges.
- Lubricate the door, hood locks, and latches.
- Lubricate the door rubber weather strips.
- Check the air conditioning system.
- Inspect and lubricate the automatic transmission linkage and controls.
- Clean the battery and terminals.
- Check the brake fluid level.

Scheduled Maintenance Services

If any of the following conditions apply, follow the Maintenance Under Severe Usage Conditions.

- Repeatedly driving short distance of less than 5 mi. (8 km) in normal temperature or less than 10 mi. (16 km) in freezing temperature
- Extensive engine idling or low speed driving for long distances
- Driving on rough, dusty, muddy, unpaved, graveled or salt-spread roads
- Driving in areas using salt or other corrosive materials or in very cold weather
- Driving in the condition of inflowing sand or dust into engine
- Driving in heavy traffic area
- Driving on uphill, downhill, or mountain roads
- Using for towing or camping, and driving with loads on the roof
- Driving as a patrol car, taxi, other commercial use of vehicle towing
- Frequently driving under high speed or rapid acceleration/deceleration
- Frequently driving in stop-and-go conditions
- Engine oil usage which is not recommended (mineral type, semi-synthetic, lower grade spec, etc.)

i Information

After driving more than 10 years or 100,000 mi., use severe maintenance schedule.

i Information

- Engine oil is consumed while driving and the engine oil level should be checked on regular basis.
 - The engine oil change interval under normal operating conditions is based on the use of engine oil that meets the recommended engine specification for your vehicle. If any other type of engine oil is used, replace the engine oil according to the maintenance schedule under severe operating conditions.
 - The vehicle may be equipped with Oil Life Management System that predicts engine oil life based on the driver's driving history and alerts the driver to change engine oil.
 - If the deterioration of the engine oil increases depending on the driver's driving severity, the remaining oil life alert appears on the cluster display before the normal engine oil replacement interval. Have the engine oil and filter changed by an authorized HYUDNAI dealer.
 - Oil Life Management System works when the recommended engine oil is used. So, if recommended engine oil is not used, replace the engine oil according to the maintenance schedule under severe usage conditions. Also, check the amount of engine oil regularly as this system assumes that the engine oil is being filled normally.
 - Always reset the remaining engine oil life whenever the engine oil is changed. Otherwise, the indication of remaining Oil life in the Oil Life Management System may not be accurate. To reset the Oil Change Reminder, select **Setup > Vehicle > Convenience > Oil Change Reminder > RESET** from the infotainment system. Then, select **"Yes"** when the message **"Has the engine oil changed? Press [Yes] to reset the oil life."** appears on the screen.
 - If there is no alert until the maximum maintenance interval, have your vehicle inspected by an authorized HYUDNAI dealer.
-

Normal maintenance schedule

I: Inspect and if necessary, adjust, correct, clean or replace.

R: Replace or change.

MAINTENANCE INTERVALS	Number of months or driving distance, whichever comes first												
	Months	12	24	36	48	60	72	84	96	108	120	132	144
	Miles×1,000	8	16	24	32	40	48	56	64	72	80	88	96
	Km×1,000	13	26	39	52	65	78	91	104	117	130	143	156
MAINTENANCE ITEM													
HSG belts* ₁		Inspect every 8,000 mi. (13,000 km) or 12 months Replace every 64,000 mi. (104,000 km) or 48 months											
Engine oil and engine oil filter ^{*2*3}		R	R	R	R	R	R	R	R	R	R	R	R
Fuel additives * ₄		Add every 8,000 mi. (13,000 km) or 12 months											
Air cleaner filter		I	I	R	I	I	R	I	I	R	I	I	R
Spark plugs		Replace every 48,000 mi. (78,000 km)											
Rotate Tires (includes tread wear inspection and tire pressure check)		Rotate tires every 8,000 mi. (13,000 km) or 12 months											
Climate control air filter		Replace every 16,000 mi. (25,000 km) or 12 months											
Engine coolant		At first, replace at 120,000 mi. (200,000 km) or 120 months. After that, replace every 24,000 mi. (40,000 km) or 24 months											
Inverter coolant		At first, replace at 120,000 mi. (200,000 km) or 120 months. After that, replace every 24,000 mi. (40,000 km) or 24 months											
Intercooler, in/out hose		At first, Inspect at 5,000 mi. (8,000 km) or 6 months. After that, Inspect every 20,000 mi. (32,000 km) or 24 months											

*1 Inspect HSG belt for evidence of cuts, crocks, excessive wear or oil saturation and replace if necessary. If drive belt noise occurs, readjust drive belt tension before replacement.

*2 Requires <API SN PLUS (or above) Full synthetic> grade engine oil. If a lower grade engine oil (mineral oil including Semi-synthetic) is used, then the engine oil and engine oil filter must be replaced as indicated severe maintenance condition.

*3 Never add any additives to the engine oil. Engine oil additives can change the properties of engine oil and may cause serious engine failure.

*4 If TOP TIER Detergent Gasoline is not available, one bottle of additive is recommended. Additives are available from your authorized HYUNDAI dealer along with information on how to use them. Do not mix other additives.

I: Inspect and if necessary, adjust, correct, clean or replace.

R: Replace or change.

MAINTENANCE INTERVALS	Number of months or driving distance, whichever comes first													
	Months	12	24	36	48	60	72	84	96	108	120	132	144	
	Miles×1,000	8	16	24	32	40	48	56	64	72	80	88	96	
	Km×1,000	13	26	39	52	65	78	91	104	117	130	143	156	
MAINTENANCE ITEM														
Battery condition	I	I	I	I	I	I	I	I	I	I	I	I	I	
Brake lines, hoses and connections	I	I	I	I	I	I	I	I	I	I	I	I	I	
Disc brakes and pads	I	I	I	I	I	I	I	I	I	I	I	I	I	
Steering gear rack, linkage and boots	I	I	I	I	I	I	I	I	I	I	I	I	I	
Driveshaft and boots		I		I		I		I		I		I		
Suspension mounting bolts	I	I	I	I	I	I	I	I	I	I	I	I	I	
Air conditioner refrigerant	I	I	I	I	I	I	I	I	I	I	I	I	I	
Air conditioner compressor	I	I	I	I	I	I	I	I	I	I	I	I	I	
Exhaust pipe and muffler	I	I	I	I	I	I	I	I	I	I	I	I	I	
Automatic transmission fluid	No check, No service required													
Vapor hose, fuel filler cap and fuel tank				I					I				I	

Maintenance

I: Inspect and if necessary, adjust, correct, clean or replace.

R: Replace or change.

MAINTENANCE INTERVALS	Number of months or driving distance, whichever comes first												
	Months	12	24	36	48	60	72	84	96	108	120	132	144
	Miles × 1,000	8	16	24	32	40	48	56	64	72	80	88	96
	Km × 1,000	13	26	39	52	65	78	91	104	117	130	143	156
MAINTENANCE ITEM													
Fuel tank air filter * ⁵		I			I				I				I
Fuel lines, hoses and connections			I			I				I			I
Parking brake			I			I				I			I
Brake fluid	Inspect every 8,000 mi. (13,000 km) or 12 months, Replace every 48,000 mi. (78,000 km) or 48 months												
Rear differential oil (4WD) * ⁶					I					I			I
Transfer case oil (4WD) * ⁶					I					I			I
Propeller shaft			I			I				I			I

*1 Fuel filter & Fuel tank air filter are considered to be maintenance free but periodic inspection is recommended for this maintenance schedule depends on fuel quality. If there are some important safety matters like fuel flow restriction, surging, loss of power, hard starting problem, etc. replace the fuel filter immediately regardless of maintenance schedule and consult an authorized HYUNDAI dealer for details.

*2 Transfer case oil/Rear differential oil should be changed anytime they have been submerged in water.

Maintenance under severe usage and low mileage conditions

The following items must be serviced more frequently on the vehicles mainly used under severe and low mileage driving conditions. Refer to the chart below for the appropriate maintenance intervals.

R: Replace

I: Inspect and if necessary, adjust, correct, clean or replace

Maintenance item	Maintenance operation	Maintenance intervals	Driving condition
Engine oil and engine oil filter	R	Replace every 5,000 mi. (8,000 km) or 6 months	D, H, I, L
Air cleaner filter	R	Replace more frequently depending on the condition	C, E
Spark plugs	R	Replace more frequently depending on the condition	A, B, F, G, H, I, K
HSG (Hybrid Starter & Generator) belt	R	Every 30,000 mi. (48,000 km) or 24 months	B, C, D, E, I, K
	I	Every 5,000 mi. (8,000 km) or 6 months	B, C, D, E, I, K
Automatic transmission fluid	R	Every 60,000 mi. (96,000 km)	A, C, F, G, H, I, J, K
Steering gear rack, linkage and boots	I	Inspect more frequently depending on the condition	C, D, E, F, G, H, I
Front suspension ball joints	I	Inspect more frequently depending on the condition	C, D, E, F, G
Disc brakes and pads, calipers and rotors	I	Inspect more frequently depending on the condition	C, D, E, G, H
Parking brake	I	Inspect more frequently depending on the condition	C, D, G, H
Driveshaft and boots	I	Inspect more frequently depending on the condition	C, D, E, F, G, H, I, J
Propeller shaft	I	Inspect more frequently depending on the condition	C, D, E, F, G, H, I, J

Maintenance item	Maintenance operation	Maintenance intervals	Driving condition
Climate control air filter (for evaporator and blower unit)	R	Replace more frequently depending on the condition	C, E, G
Rear differential oil (4WD)	R	Replace every 72,000 mi. (120,000 km)	C, D, E, G, H, I, J
Transfer case oil (4WD)	R	Replace every 72,000 mi. (120,000 km)	C, D, E, G, H, I, J

Severe driving conditions

A: Repeatedly driving short distance of less than 5 mi. (8 km) in normal temperature or less than 10 mi. (16 km) in freezing temperature

B: Extensive engine idling or low speed driving for long distances

C: Driving on rough, dusty, muddy, unpaved, graveled or salt-spread roads

D: Driving in areas using salt or other corrosive materials or in very cold weather

E: Driving in the condition of inflowing sand or dust into engine

F: Driving in heavy traffic area

G: Driving on uphill, downhill, or mountain roads

H: Using for towing or camping, and driving with loads on the roof

I: Driving as a patrol car, taxi, other commercial use of vehicle towing

J: Frequently driving under high speed or rapid acceleration/deceleration

K: Frequently driving in stop-and-go conditions

L: Engine oil usage which is not recommended (Mineral type, Semi-synthetic, Lower grade spec, etc.)

Explanation Of Scheduled Maintenance Items

Engine oil and filter

The engine oil and filter should be changed at the intervals specified in the maintenance schedule. If the vehicle is driven in severe conditions, more frequent oil and filter changes are required.

HSG (Hybrid Starter & Generator) belts

The HSG belt should be changed at the intervals specified in the maintenance schedule.

WARNING

Always turn off the engine before inspecting the HSG belt.

Fuel lines, fuel hoses and connections

Check the fuel lines, fuel hoses, and connections for leakage and damage. Have an authorized HYUNDAI dealer replace any damaged or leaking parts immediately.

Fuel filter

The fuel filter is considered to be maintenance free but periodic inspection is recommended depending on the fuel quality. If there is fuel flow restriction, surging, loss of power, or hard starting, contact an authorized HYUNDAI dealer to have the fuel filter replaced immediately.

Vapor hose and fuel filler cap

The vapor hose and fuel filler cap should be inspected at intervals specified in the maintenance schedule. Your HYUNDAI dealer helps determine if replacement is needed.

Vacuum crankcase ventilation hoses

Visually check for proper installation, chafing, cracks, deterioration, and any leakage. Replace any deteriorated or damaged parts immediately.

Air cleaner filter

The air cleaner filter should be replaced by an authorized HYUNDAI dealer.

Spark plugs

Be sure to install new spark plugs with the correct heat range.

When installing new spark plugs, make sure the ignition coils are clean and free of any oil or debris. Clean and wipe off the bottom portion of the ignition coil to prevent any contamination with the spark plug during installation.



WARNING

Do not remove spark plugs from the vehicle when the engine is hot. You may damage the engine and may also risk burn injury.

Cooling system

Check the cooling system components such as radiator, coolant reservoir, hoses, and connections for leakage and damage. Replace any damaged parts.

Engine coolant/battery system coolant

The coolant should be changed at the intervals specified in the maintenance schedule.

Automatic Transmission fluid

The automatic transmission fluid level does not need to be checked under normal usage conditions.

Have the automatic transmission fluid changed by an authorized HYUNDAI dealer according to the maintenance schedule.

i Information

The color of a new automatic transmission fluid is red. As the vehicle is driven, the automatic transmission fluid begins to look darker.

This is normal and the automatic transmission fluid does not need to be replaced based on the color change.

NOTICE

Only use the automatic transmission fluid specified in the "Recommended Lubricants And Capacities" section in chapter 10 to prevent transmission damage.

Brake hoses and lines

Visually check for proper installation, chafing, cracks, deterioration, and any leakage. Replace any deteriorated or damaged parts immediately.

Brake fluid

Check the brake fluid level in the brake fluid reservoir. The level should be between the MIN and the MAX marks on the side of the reservoir. Use only hydraulic brake fluid conforming to DOT 4 specification.

Parking brake

Inspect the parking brake system including the cables.

Brake discs, pads, calipers, and rotors

Check the pads, the disc, and the rotor for any excessive wear-out. Inspect calipers for any fluid leakage.

Exhaust pipe and muffler

Visually inspect the exhaust pipes, muffler and hangers for cracks, deterioration, or damage. Start the engine and listen carefully for any exhaust gas leakage. Tighten connections or replace parts as necessary.

Drive shaft and related

Check the drive shaft, boots, clamps, rubber couplings, and center-bearing rubber for cracks, deterioration, or damage. Replace any damaged parts and if necessary, repack the grease.

Suspension mounting bolts

Check the suspension connections for looseness or damage. Retighten to the specified torque.

Steering gear box, linkage & boots/lower arm ball joint

With the vehicle stopped and the engine off, check for excessive free-play in the steering wheel. Check the linkage for bends or damage. Check the dust boots and ball joints for deterioration, cracks, or damage.

Replace any damaged parts.

Air conditioning refrigerant

Check the air conditioning lines and connections for leakage and damage.

Engine Oil

Checking the engine oil level

Engine oil is used for lubricating, cooling, and operating various hydraulic components in the engine. Engine oil consumption while driving is normal, and it is necessary to check and refill the engine oil regularly. Also, check and refill the oil level within the recommended maintenance schedule to prevent deterioration of oil performance.

Check the engine oil following the below procedure.

1. Follow all of the oil manufacturer's precautions.
2. Make sure the vehicle is on the level ground in P (Park) with the parking brake applied.
3. Turn on the engine and warm the engine up until the coolant temperature reaches a constant normal temperature.
4. Turn off the engine, remove the oil filler cap and pull the dipstick out. Wait for 15 minutes for the oil to return to the oil pan.
5. Wipe the dipstick clean and re-insert it fully.

6. Pull the dipstick out again and check the level. The level should be between F (Full) and L (Low).

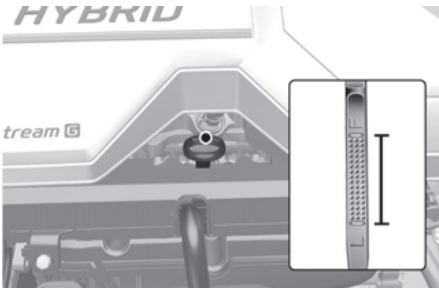

7. If the oil level is below the L, add enough oil to bring the level to F.

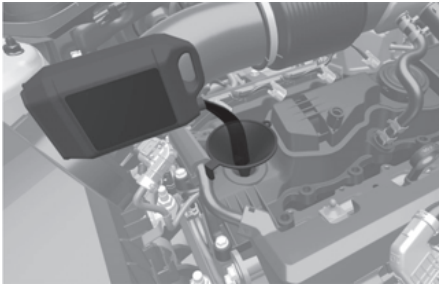

Use only the specified engine oil (Refer to the "Recommended Lubricants And Capacities" section in chapter 10).

NOTICE

To prevent damage to your engine:

- Do not spill engine oil when adding or changing engine oil. Wipe off spilled oil immediately.
- The engine oil consumption may increase while you break in the new vehicle, and it should stabilize after driving 4,000 mi. (6,000 km).
- The engine oil consumption may be affected by driving habits, climate conditions, traffic conditions, and oil quality. Inspect the engine oil level regularly and refill if necessary.

Checking the engine oil and filter



- The lubrication, rust prevention, cooling, and cleaning effect of the engine oil will gradually degrade during its use. Have the engine oil and filter changed by an authorized HYUNDAI dealer according to the Oil Life Management System instructions or the Maintenance Schedule at the beginning of this chapter.
- To keep the engine in optimal condition, use the recommended engine oil and filter. If the recommended engine oil and filter are not used, replace them according to the Maintenance Schedule Under Severe Usage Conditions.
- The purpose of the maintenance schedule for engine oil replacement is to prevent oil deterioration and it is irrelevant to oil consumption. Check and refill engine oil regularly.

i Information

If the oil pressure is low, due to insufficient engine oil, the Engine Oil Pressure (🛢️) warning light illuminates. The enhanced engine protection system that limits the engine's power, is activated and the Malfunction Indicator Lamp (🛢️) illuminates. After sufficient engine oil is added, the engine oil pressure warning light and the enhanced engine protection system will turn off after the engine is restarted.

NOTICE

Never add any additives to the engine oil. Engine oil additives can change its properties and may cause engine failure.

⚠️ WARNING

Allow the engine to cool before replacing the oil.

Engine Coolant/Battery System Coolant

The high pressure cooling system has a reservoir filled with year-round antifreeze coolant.

Check the antifreeze protection and coolant level at least once a year, before the winter season or before traveling to a colder climate.

Checking the coolant level

Engine Coolant



Battery system Coolant

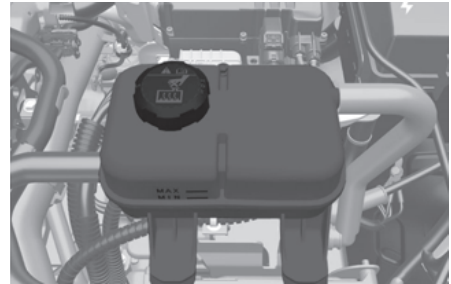

i Information

Battery system : Inverter, HSG, LDC

Check the condition and connections of all cooling system hoses and heater hoses. Replace any swollen or deteriorated hoses.

The coolant level should be filled between the MAX and the MIN marks on the side of the coolant reservoir when the engine is cool.

If the coolant level is low, add enough distilled (deionized) water mixed with antifreeze to bring the level to the MAX mark. If frequent additions are required, have your vehicle inspected by an authorized HYUNDAI dealer for a cooling system inspection.

WARNING



Never remove the engine coolant reservoir cap, radiator cap, or drain plug while the engine and radiator are hot. Hot coolant and steam may blow out under pressure, causing serious injury.

Turn the vehicle off and wait until the engine cools down. Use extreme care when removing the engine coolant cap and radiator cap. Wrap a thick towel around it, and turn it counterclockwise slowly to the first stop. Step back while the pressure is released from the cooling system. When you are sure all the pressure has been released, press down on the cap, using a thick towel, and continue turning counterclockwise to remove it.

i Information

The coolant level is influenced by the engine temperature. Before checking or refilling the coolant, turn off the engine and allow the engine to cool.

WARNING



The electric motor for the cooling fan may continue to operate or start up when the engine is not running and can cause serious injury. Keep hands, clothing and tools away from the rotating fan blades of the cooling fan.

Always turn off the vehicle unless the vehicle has to be inspected with the engine on. The cooling fan may operate automatically if the negative (-) battery terminal is not disconnected.

WARNING

Make sure the coolant cap is properly closed after refilling coolant. Otherwise, the engine may be overheated while driving.

1. Check if the coolant cap label is straight in front.

Engine compartment front view



2. Make sure that the tiny protrusions inside the coolant cap is securely interlocked.



Recommended coolant

- When adding coolant, use only deionized water, distilled water, or soft water for your vehicle and never mix hard water in the coolant filled at the factory.
- An incorrect coolant mixture may result in severe malfunction or engine damage.
- The engine in your vehicle has aluminum engine parts and must be protected by a phosphate-based ethylene glycol coolant to prevent corrosion and freezing.
- Do not use alcohol or methanol coolant or mix them with the specified coolant.
- Do not use a solution that contains more than 60 % antifreeze or less than 35 % antifreeze, which could reduce the effectiveness of the solution.

For mixing percentage, refer to the following table:

Ambient Temperature	Mixture Percentage (volume)	
	Antifreeze	Water
5 °F (-15 °C)	35	65
-25 °C (-13 °F)	40	60
-31 °F (-35 °C)	50	50
-49 °F (-45 °C)	60	40

i Information

If in doubt about the mix ratio, a 50 % water and 50 % antifreeze mix is the easiest to mix together as it will be the same quantity of each. It is suitable to use for most temperature ranges of -31 °F (-35 °C) and higher.

Changing coolant

Have the coolant changed by an authorized HYUNDAI dealer according to the Maintenance Schedule at the beginning of this chapter.

WARNING

Do not use engine coolant or antifreeze in the washer fluid reservoir.

Engine coolant can severely obscure visibility when sprayed on the windshield and may cause loss of vehicle control resulting in an accident.

Engine coolant may also cause damage to paint and body trim.

NOTICE

To prevent damage to engine parts, put a thick towel around the engine coolant reservoir cap before refilling the coolant to prevent the coolant from overflowing into engine parts, such as the alternator.

Brake Fluid

Checking the brake fluid level

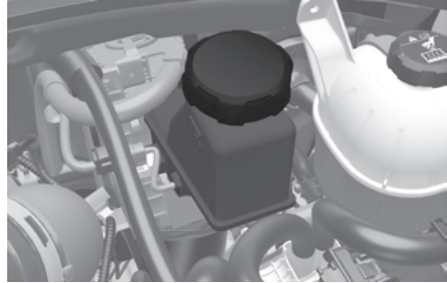

Check the fluid level in the reservoir periodically. The fluid level must be between the MAX and the MIN marks on the side of the reservoir.

Before removing the reservoir cap and adding brake fluid, clean the area around the reservoir cap thoroughly to prevent brake fluid contamination.

If the level is low, add the specified brake fluid to the MAX level. If the fluid level is excessively low or frequent additions are required, have the brake system inspected by an authorized HYUNDAI dealer.

WARNING

If brake fluid comes in contact with your eyes, flush your eyes with clean water for at least 15 minutes and get immediate medical attention.

NOTICE

- Do not allow brake fluid to contact the vehicle's body paint, because paint damage may occur.
- Never use brake fluid that has been exposed to open air for an extended time and dispose of it properly.
- Do not use the wrong type of brake fluid. A few drops of mineral based oil such as engine oil in your brake system may damage the brake system parts.

i Information

Use only the brake fluid specified in the "Recommended Lubricants And Capacities" section in chapter 10.

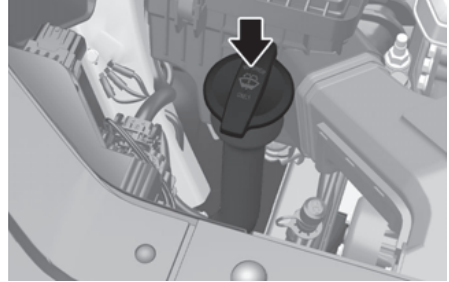
Washer Fluid**Checking the washer fluid level**

Check the fluid level in the washer fluid reservoir and add fluid if necessary. Plain water can be used during summer months if washer fluid is not available. However, use washer fluid with antifreeze in cold climates to prevent freezing.

⚠ WARNING

To prevent serious injury or death:

- Do not use engine coolant or antifreeze in the washer fluid reservoir. Engine coolant can severely limit your visibility when sprayed on the windshield and may cause loss of vehicle control resulting in a collision.
- Do not allow sparks or flame to contact the washer fluid or the washer fluid reservoir. Washer fluid may contain alcohol and can be flammable.
- Do not drink washer fluid and avoid contact with skin.

Hybrid Starter & Generator (HSG) Belt

Checking the Hybrid Starter & Generator (HSG) belt

Have the Hybrid Starter & Generator (HSG) belt inspected or replaced according to the Maintenance Schedule in this chapter by an authorized HYUNDAI dealer.

CAUTION

When the HSG belt is worn out or damaged, replace the belt.

Otherwise, it may cause engine overheating or battery discharge.

Information

- Turn the engine off while you inspect the engine or Hybrid Starter & Generator (HSG) belt. Otherwise it may result in serious injury.
- Keep hands, clothing etc. away from the Hybrid Starter & Generator (HSG) belt.

Air Cleaner

Filter replacement

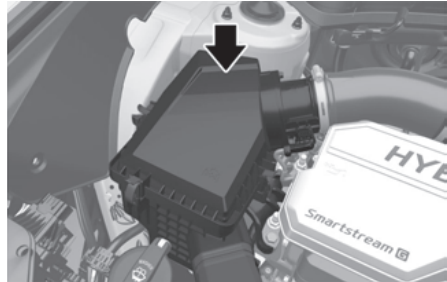

The air cleaner filter can be cleaned for inspection using compressed air. Do not attempt to wash or rinse it, because water can damage the filter. If soiled, replace the air cleaner filter.

1. Loosen the air cleaner cover attaching clips.

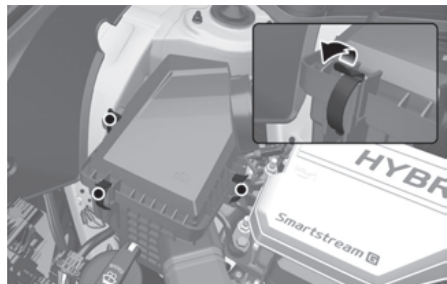

2. Open the cover.

3. Pull out and replace the air cleaner filter

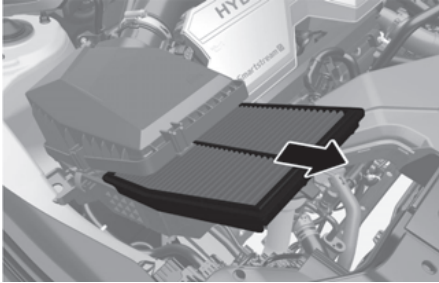

4. Lock the cover with the attaching clips.
5. Check that the cover is firmly installed.

i Information

If the vehicle is operated in extremely dusty or sandy areas, replace the element more often than the usual recommended intervals (refer to the "Maintenance under severe usage and low mileage conditions" section in this chapter).

NOTICE

- Do not drive with the air cleaner filter removed. This may result in excessive engine wear.
- When removing the air cleaner filter, be careful that dust or dirt does not enter the air intake. It may cause damage.
- Use HYUNDAI genuine parts or the equivalent specified for your vehicle. Use of non-genuine parts may damage the air flow sensor.

Cabin Air Filter

Filter inspection

The cabin air filter must be replaced according to the Maintenance Schedule. If the vehicle operates in severely air-polluted cities or on dusty rough roads for a long time, have it inspected more frequently and replaced immediately. Replace the cabin air filter by following the procedure below and be careful to avoid damaging other components.

Filter replacement

1. Open the glove box and remove the support rod (1).

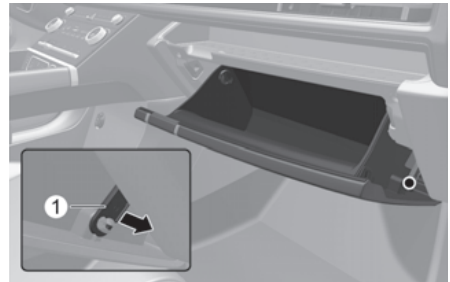

2. Push in both sides of the glove box to release the glove box stopper pins and allow the glove box to hang open.

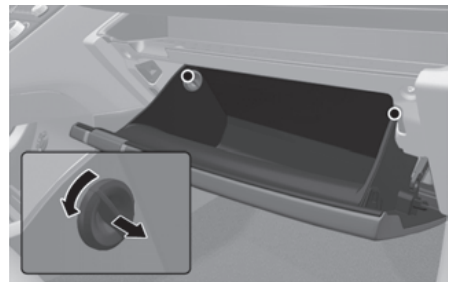

3. Press and hold the lock on the right side of the cover.



4. Pull out the cover.
5. Replace the cabin air filter.
6. Reassemble in the reverse order of disassembly.

NOTICE

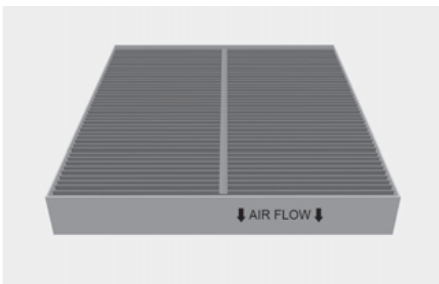

Install a new cabin air filter with the arrow symbol (↓) facing down, to improve effectiveness.

Wiper Blades

Blade inspection

Contamination of the windshield or wiper blades with foreign substances may reduce the effectiveness of the windshield wipers.

Common sources of contamination are insects, tree sap, and hot wax treatments used by some commercial car washes. If the blades are not wiping properly, clean both the window and the blades with glass cleaner or mild detergent, and rinse thoroughly with clean water. Replace blades as needed.

NOTICE

To prevent damage to the wiper blades, arms, or other components, do not:

- Use gasoline, kerosene, paint thinner, or other solvents on or near them.
- Attempt to move the wipers manually.

Blade replacement

When the wipers no longer clean adequately, the blades may be worn or cracked. Replace the wipers with new ones.

NOTICE

To prevent damage:

- Never use non-specified wiper blades.
- Lift the wiper arms when in the top wiping position.
- Always return the wiper arms to the windshield before driving.

Front windshield wiper blade replacement

1. Within 20 seconds of turning off the engine, lift and hold the wiper lever up to the MIST position for about 2 seconds until the wipers move to the top wipe position.

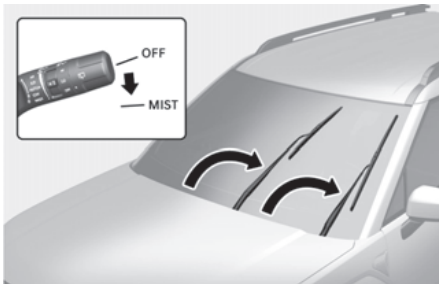

2. Lift the wipers off the windshield.

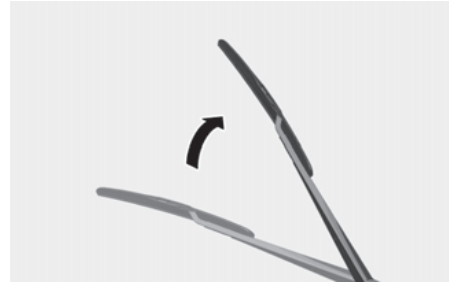

3. Lift up the wiper blade clip (1). Then pull down the wiper blade (2).

Remove the wiper blade from the wiper arm.

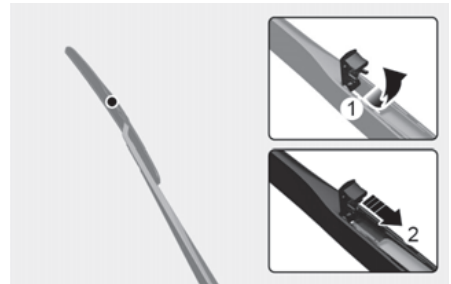

4. Install a new wiper blade assembly in the reverse order of removal.

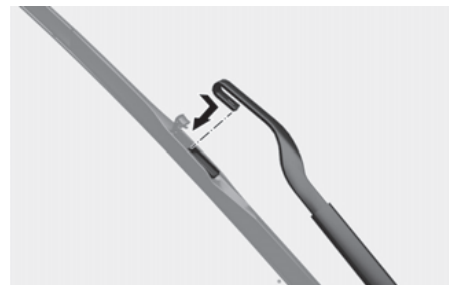

5. With the Engine Start/Stop button in the ON position, turn the wiper switch to any ON position to return the wipers to the bottom resting position.

Rear window wiper blade replacement

1. Within 20 seconds after the engine is turned off, pull down the wiper lever to MIST position for over 2 seconds until the wiper moves down to the bottom middle part.
2. Raise the wiper arm.

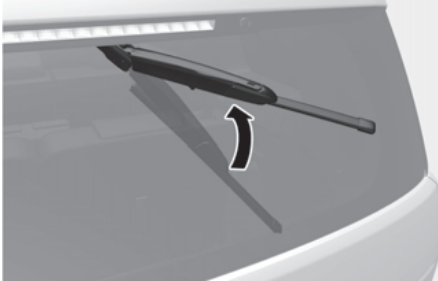

3. Press the wiper blade slot (1). Then remove the wiper blade (2).

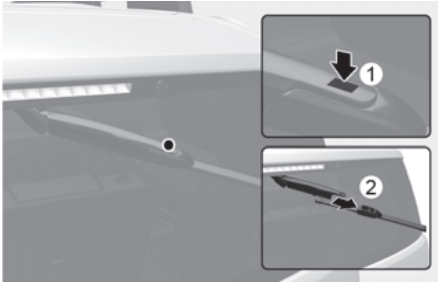

4. Install a new wiper blade assembly in the reverse order of removal.

If the replacement is complete, put down the wiper arm onto the rear windshield, and turn the Engine Start/Stop button to ON and operate the wipers to check the blade is installed correctly.

NOTICE

The rear wiper may not operate for about 10 seconds if the wiper is operated without washer fluid or the blades are frozen to prevent damage to the motor.

Battery

⚠ WARNING

To prevent serious injury or death to you or bystanders when working near or handling the battery:

Always read and follow instructions carefully when handling a battery.



Wear eye protection designed to protect the eyes from acid splashes.



Keep all flames, sparks, or smoking materials away from the battery.



Hydrogen is always present in battery cells, is highly combustible, and may explode if ignited.



Keep batteries out of reach of children.



Batteries contain sulfuric acid that is highly corrosive. Do not allow acid to contact your eyes, skin, or clothing.

If acid gets into your eyes, flush your eyes with clean water for at least 15 minutes and get immediate medical attention. If acid gets on your skin, thoroughly wash the area. If you feel pain or a burning sensation, get medical attention immediately.



- Lift a battery with a battery carrier or with your hands on opposite corners. When lifting a plastic-cased battery, excessive pressure on the case may cause battery acid to leak.
- Do not attempt to jump start your vehicle if your battery is frozen.
- Never attempt to recharge the battery when the vehicle's battery cables are connected to the battery.
- The electrical ignition system works with high voltage. Never touch these components with the engine running or when the Engine Start/Stop button is in the ON position.

NOTICE

To prevent battery damage:

- Always fully charge the battery and store indoors when you do not plan to use the vehicle for a long time if the outside temperature is low enough to cause the battery to freeze.
- Always fully charge the battery to prevent battery case damage in low temperature areas.
- Prevent liquid from wetting the battery terminals. The performance of the battery may be degraded, and may cause injury. Be cautious when loading liquid in the liftgate.
- Do not tilt the battery.
- If you connect unauthorized electronic devices to the battery, the battery may be discharged. Never use unauthorized devices.

For longer battery life

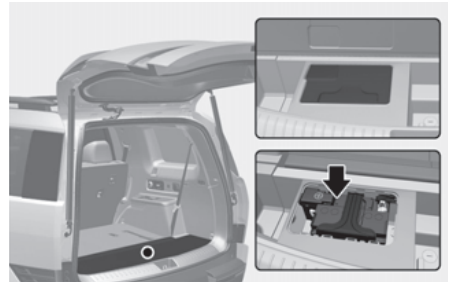

- Keep the battery securely mounted.
- Keep the battery top clean and dry.
- Keep the terminals and connections clean, tight, and coated with petroleum jelly or terminal grease.
- Rinse any spilled electrolyte from the battery immediately with a solution of water and baking soda.
- If the vehicle is not going to be used for an extended period of time, disconnect the battery cables.

Battery capacity label



The actual battery label in the vehicle may differ from the illustration.

- (1) AGM70L-DIN : The HYUNDAI model name of battery
- (2) 12V : The nominal voltage
- (3) 70Ah (20HR) : The nominal capacity (in Ampere hours)
- (4) RC 120min : The nominal reserve capacity (in min.)
- (5) CCA 760A (SAE/EN) : The cold-test current in amperes

i Information

For vehicles with power liftgate, note that the power liftgate needs to be reset after the battery has been replaced. For more information, refer to the "Power Liftgate" section in chapter 5.

Battery recharging

By battery charger

Your vehicle has a maintenance-free, calcium-based battery.

- If the battery becomes discharged over a short time (because, for example, the headlights or interior lights are left on while the vehicle is not used), recharge it by slow charging (trickle) for 10 hours.
- If the battery gradually discharges because of high electrical load while the vehicle is being used, recharge at 20-30 A for two hours.

! WARNING

To prevent the risk of serious injury or death from explosions or acid burns:

- Before performing maintenance or recharging the battery, turn off all accessories and stop the engine.
- Keep all flames, sparks, or smoking materials away from the battery.
- Always work outdoors or in an area with plenty of ventilation.
- Wear eye protection when checking the battery during charging. Do not contact the battery. This may result in serious injury.
- Remove the battery from the vehicle and place it in a well ventilated area.
- Watch the battery during charging, and stop or reduce the charging rate if the battery cells begin boiling violently.
- Remove the negative battery cable first and install it last when the battery is disconnected. Disconnect the battery charger in the following order:
 1. Turn off the battery charger main switch.
 2. Unhook the negative clamp from the negative battery terminal.
 3. Unhook the positive clamp from the positive battery terminal.

NOTICE**AGM battery**

Absorbent Glass Mat (AGM) batteries are maintenance-free and should be serviced by an authorized HYUNDAI dealer. Only charge using fully automatic battery chargers that are specifically for AGM batteries.

⚠ CAUTION

Do not open or remove the cap on top of the battery. This may cause leaks of internal electrolyte that could result in severe injury.

By jump starting

After a jump start from a good battery, drive the vehicle for 30 minutes or operate at idle for at least 60 minutes before it is shut off. The vehicle may not restart if you shut it off before the battery has a chance to adequately recharge. Refer to the "Jump Starting" section in chapter 8 for more information on jump starting procedures.

***i* Information**

An inappropriately disposed battery may be harmful to the environment and human health. Dispose of the battery according to your local law(s) or regulations.

Reset items

The following items may need to be reset after the battery has been discharged or disconnected:

- Auto up/down window (refer to chapter 5)
- Power Liftgate (refer to chapter 5)
- Utility view (refer to chapter 5)
- Automatic Climate Control System (refer to chapter 5)
- Integrated Memory System (refer to chapter 5 of the complete Owner's Manual)
- Clock (refer to chapter 5)
- Infotainment System (refer to the infotainment system manual)

Tires And Wheels

WARNING

Tire failure may cause loss of vehicle control and result in a collision. To reduce risk of serious injury or death:

- Inspect your tires monthly for proper inflation as well as wear and damage.
 - The recommended cold tire pressure for your vehicle can be found in this manual and on the tire label located on the driver's side center pillar. Always use a tire pressure gauge to measure tire pressure. Tires with too much or too little pressure wear unevenly causing poor handling.
 - Check the pressure of the spare every time you check the pressure of the other tires on your vehicle.
 - Replace tires that are worn, show uneven wear, or are damaged. Worn tires may cause loss of braking effectiveness, steering control, or traction.
 - Always replace tires with the same size, type, construction, and tread pattern as each tire that was originally supplied with this vehicle. Using tires and wheels other than the recommended sizes may cause unusual handling characteristics, poor vehicle control, or negatively affect your vehicle's Anti-Lock Brake System (ABS).
-

Tire Care

For proper maintenance, safety, and maximum fuel economy, always maintain the recommended tire inflation pressures and stay within the load limits and weight distribution recommended for your vehicle.



All specifications (sizes and pressures) can be found on a label attached to the driver's side center pillar.

Information

For more information on the label, refer to the "The loading information label" section in chapter 6.

Recommended cold tire inflation pressures

Check all tire pressures (including the spare) when the tires are cold. "Cold tires" mean the vehicle has not been driven for at least three hours or driven less than 1 mile (1.6 km).

Warm tires normally exceed the recommended cold tire pressures by 4 to 6 psi (28 to 41 kPa). Do not release air from warm tires to adjust the pressure. The tires are under-inflated. For the recommended inflation pressure, refer to the "Tires And Wheels" section in chapter 10.

WARNING

- Recommended pressures must be maintained for the best ride, vehicle handling, and minimum tire wear.
- Over-inflation or under-inflation can reduce tire life, adversely affect vehicle handling, and lead to sudden tire failure that may result in loss of vehicle control resulting in a collision.
- Severe under-inflation may lead to severe heat build-up, causing blowouts, tread separation, and other tire failures that result in loss of vehicle control resulting in a collision. This risk is much higher on hot days and when driving for a long time at high speeds.
- Under-inflation may cause excessive wear, poor handling, and reduced fuel economy. Wheel deformation is also possible. Keep your tire pressures at the proper levels. If a tire frequently needs refilling, have it inspected by an authorized HYUNDAI dealer.
- Over-inflation produces a harsh ride, excessive wear at the center of the tire tread, and a greater possibility of damage from road hazards.

Check tire inflation pressure

Check your tires, including the spare tire, at least once a month.

How to check

Use a good quality tire pressure gauge to check the tire pressure. You cannot tell if your tires are properly inflated simply by looking at them. Radial tires may look properly inflated when they are under-inflated.

Remove the valve cap from the tire valve stem. Press the tire gauge firmly onto the valve to get a pressure measurement. If the cold tire inflation pressure matches the recommended pressure on the tire and loading information label, no further adjustment is necessary. If the pressure is low, add air until it reaches the recommended pressure.

Be sure to put the valve caps back on the valve stems. Without the valve cap, dirt or moisture may get into the valve core and cause air leakage. If a valve cap is missing, install a new one as soon as possible.

If you overfill the tire, release air by pushing on the metal stem in the center of the tire valve. Recheck the tire pressure with the tire gauge. Be sure to put the valve caps back on the valve stems. Without the valve cap, dirt or moisture may get into the valve core and cause air leakage. If a valve cap is missing, install a new one as soon as possible.

Tire rotation

To equalize tread wear, HYUNDAI recommends that the tires be rotated according to the maintenance schedule or sooner if irregular wear develops.

During rotation, check the tires for correct balance.

When rotating tires, check for uneven wear and damage. Abnormal wear is usually caused by incorrect tire pressure, improper wheel alignment, out-of-balance wheels, severe braking, or severe cornering. Look for bumps or bulges in the tread or side of the tire. Replace the tire if you find any of these conditions. Replace the tire if fabric or cord is visible. After rotation, be sure to bring the front and rear tire pressures to specification and check wheel nut torque (proper torque is 79.6-94.0 lbf.ft [11.0-13.0 kgf.m]).

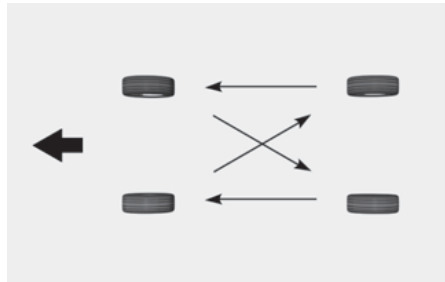

Disc brake pads should be inspected for wear whenever tires are rotated.

i Information

When installing an unsymmetrical tire, install the side marked "outside" facing out.

! WARNING

- Do not use the compact spare tire for tire rotation.
 - Do not mix bias ply and radial ply tires under any circumstances. This may cause unusual handling characteristics that may cause loss of vehicle control and result in a collision.
-

Wheel alignment and tire balance

The wheels on your vehicle were aligned and balanced carefully at the factory, and you may not need to have your wheels aligned again. If you notice unusual tire wear or your vehicle pulling to one side, the alignment may need to be adjusted.

If you notice your vehicle vibrating when driving on a smooth road, your wheels may need to be rebalanced.

NOTICE

Only use approved wheel weights or your vehicle's aluminum wheels may be damaged.

Tire replacement



[A]Tread wear indicator

If the tire is worn evenly, a tread wear indicator appears as a solid band across the tread. This shows there is less than 1/16 in. (1.6 mm) of tread left on the tire. Replace the tire when this happens.

Do not wait for the band to appear across the entire tread before replacing the tire.

⚠ WARNING

To reduce the risk of serious injury or death:

- Replace tires that are worn, show uneven wear, or are damaged. Worn tires may cause loss of braking effectiveness, steering control, and traction.
- Always replace tires with the same size as each tire that was originally supplied with this vehicle. Using tires and wheels other than the recommended sizes may cause unusual handling characteristics, poor vehicle control, or negatively affect your vehicle's Anti-Lock Brake System (ABS).
- When replacing tires (or wheels), it is recommended to replace the two front or two rear tires (or wheels) as a pair. Replacing just one tire may seriously affect your vehicle's handling.
- Tires degrade over time, even when they are not being used. Regardless of the remaining tread, HYUNDAI recommends that tires be replaced after six (6) years.
- Driving in hot climates or excessive loading may accelerate the tire aging process.

Wheel replacement

When replacing the metal wheels for any reason, make sure the new wheels are equivalent to the original factory units in diameter, rim width, and offset.

Tire traction

Tire traction can be reduced if you drive on worn tires or the tires that are improperly inflated, or on slippery road surfaces. Replace the tires when tread wear indicators appear. To reduce the possibility of losing control, slow down whenever there is rain, snow, or ice on the road.

Tire maintenance

In addition to proper inflation, correct wheel alignment helps decrease the tire wear. If you find a tire is worn unevenly, have your dealer check the wheel alignment. When you have new tires installed, make sure they are balanced. This may increase ride comfort and tire life. Additionally, a tire must always be rebalanced if it is removed from the wheel.

Tire sidewall labeling

This information identifies and describes the fundamental characteristics of the tire and also provides the tire identification number (TIN) for safety standard certification. The TIN can be used to identify the tire in case of a recall.

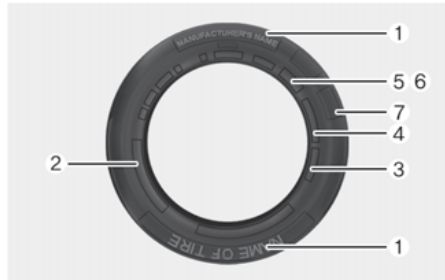

1. Manufacturer or brand name

Manufacturer or brand name is shown.

2. Tire size designation

A tire's sidewall is marked with a tire size designation. You need this information when selecting replacement tires for your vehicle. The following explains what the letters and numbers in the tire size designation mean.

Example tire size designation:

(These numbers are provided as an example only. Your tire size designator may vary depending on your vehicle.)

235/60R18 102H

235 - Tire width in millimeters.

60 - Aspect ratio. The tire's section height as a percentage of its width.

R - Tire construction code (Radial).

18 - Rim diameter in inches.

102 - Load Index, a numerical code associated with the maximum load the tire can carry.

H - Speed Rating Symbol. See the speed rating chart in this section for additional information.

Wheel size designation

Wheels are also marked with important information that you need if you ever have to replace one.

Example wheel size designation:

7.5J X 18

7.5 - Rim width in inches.

J - Rim contour designation.

18 - Rim diameter in inches.

Tire speed ratings

The chart below lists many of the different speed ratings currently being used for passenger vehicle tires. The speed rating is part of the tire size designation on the sidewall of the tire. This symbol corresponds to that tire's designed maximum safe operating speed.

Speed Rating Symbol	Maximum Speed
S	112 mph (180 km/h)
T	118 mph (190 km/h)
H	130 mph (210 km/h)
V	149 mph (240 km/h)
W	168 mph (270 km/h)
Y	186 mph (300 km/h)

3. Checking tire life (TIN: Tire Identification Number)

Any tires that are over six years old, based on the manufacturing date, (including the spare tire) must be replaced by new ones. You can find the manufacturing date on the tire sidewall (possibly on the inside of the wheel), displaying the DOT Code. The DOT Code is a series of numbers on a tire consisting of numbers and English letters. The manufacturing date is designated by the last four digits (characters) of the DOT code.

DOT: XXXX XXXX OOOO

The front part of the DOT shows a plant code number, tire size, and tread pattern and the last four numbers indicate the week and year manufactured.

For example:

DOT XXXX XXXX 1524 represents that the tire was produced in the 15th week of 2024.

4. Tire ply composition and material

The number of layers or plies of rubber-coated fabric in the tire. Tire manufacturers also must indicate the materials in the tire, which include steel, nylon, polyester, and others. The letter "R" means radial ply construction. The letter "D" means diagonal or bias ply construction; and the letter "B" means belted-bias ply construction.

5. Maximum permissible inflation pressure

This number is the greatest amount of air pressure that should be put in the tire. Do not exceed the maximum permissible inflation pressure. Refer to the Tire and Loading Information label for recommended inflation pressure.

6. Maximum load rating

This number indicates the maximum load in kilograms and pounds that can be carried by the tire. When replacing the tires on the vehicle, always use a tire that has the same load rating as the factory installed tire.

7. DOT Tire Quality Grading (U.S. Vehicles)

The tires on your vehicle meet all U.S. Federal Safety Requirements. All tires are also graded for treadwear, traction, and temperature performance according to Department of Transportation (DOT) standards.

Uniform tire quality grading

Quality grades can be found where applicable on the tire sidewall between tread shoulder and maximum section width.

For example:

TREADWEAR 200

TRACTION AA

TEMPERATURE A

Tread wear

The tread wear grade is a comparative rating based on the wear rate of the tire when tested under controlled conditions on a specified government test course. For example, a tire graded 150 would wear one-and-a-half times (1½) as well on the government course as a tire graded 100.

The relative performance of tires depends upon the actual conditions of their use, however, and may depart significantly from the norm due to variations in driving habits, service practices, and differences in road characteristics and climate.

These grades are molded on the sidewalls of passenger vehicle tires. The tires available as standard or optional equipment on your vehicle may vary depending on the grade.

Traction - AA, A, B & C

The traction grades, from highest to lowest, are AA, A, B, and C. Those grades represent the tire's ability to stop on wet pavement as measured under controlled conditions on specified government test surfaces of asphalt and concrete. A tire marked C may have poor traction performance.

WARNING

The traction grade assigned to this tire is based on straight ahead braking traction tests, and does not include acceleration, cornering, hydroplaning, or peak traction characteristics.

Temperature - A, B & C

The temperature grades are A (the highest), B and C representing the tire's resistance to the generation of heat and its ability to dissipate heat when tested under controlled conditions on a specified indoor laboratory test wheel.

Sustained high temperature may cause the material of the tire to degenerate and reduce tire life, and excessive temperature may lead to sudden tire failure. The grade C corresponds to a level of performance that all passenger car tires must meet the Federal Motor Vehicle Safety Standard No. 109. Grades A and B represent higher levels of performance on the laboratory test wheel than the minimum required by law.

WARNING

The temperature grade for this tire is established for a tire that is properly inflated and not overloaded. Excessive speed, under-inflation, over-inflation, or excessive loading, either separately or in combination, may cause heat build-up and possible sudden tire failure.

Tire terminology and definitions

Air pressure

The amount of air inside the tire pressing outward on the tire. Air pressure is expressed in pounds per square inch (psi) or kilopascal (kPa).

Accessory weight

This means the combined weight of optional accessories. Some examples of optional accessories are dual clutch transmission, power seats, and air conditioning.

Aspect ratio

The relationship of a tire's height to its width.

Belt

A rubber coated layer of cords that is located between the plies and the tread. Cords may be made from steel or other reinforcing materials.

Bead

The tire bead contains steel wires wrapped by steel cords that hold the tire onto the rim.

Bias ply tire

A pneumatic tire in which the plies are laid at alternate angles less than 90 degrees to the centerline of the tread.

Cold tire pressure

The amount of air pressure in a tire, measured in pounds per square inch (psi) or kilopascals (kPa) before a tire has built up heat from driving.

Curb weight

This means the weight of a motor vehicle with standard and optional equipment including the maximum capacity of fuel, oil and coolant, but without passengers and cargo.

DOT markings

A code molded into the sidewall of a tire signifying that the tire is in compliance with the U.S. Department of Transportation motor vehicle safety standards. The DOT code includes the Tire Identification Number (TIN), an alphanumeric designator which can also identify the tire manufacturer, production plant, brand and date of production.

GVWR

Gross Vehicle Weight Rating

GAWR FRT

Gross Axle Weight Rating for the Front Axle.

GAWR RR

Gross Axle Weight Rating for the Rear axle.

Intended outboard sidewall

The side of an asymmetrical tire, that must always face outward when mounted on a vehicle.

Kilopascal (kPa)

The metric unit for air pressure.

Light Truck (LT) tire

A tire designated by its manufacturer as primarily intended for use on lightweight trucks or multipurpose passenger vehicles.

Load ratings

The maximum load that a tire is rated to carry for a given inflation pressure.

Load index

An assigned number ranging from 1 to 279 that corresponds to the load carrying capacity of a tire.

Maximum inflation pressure

The maximum air pressure to which a cold tire may be inflated. The maximum air pressure is molded onto the sidewall.

Maximum load rating

The load rating for a tire at the maximum permissible inflation pressure for that tire.

Maximum loaded vehicle weight

The sum of curb weight; accessory weight; vehicle capacity weight; and production options weight.

Normal occupant weight

The number of occupants a vehicle is designed to seat multiplied by 150 lbs. (68 kg).

Occupant distribution

Designated seating positions.

Outward facing sidewall

An asymmetrical tire has a particular side that faces outward when mounted on a vehicle. The outward facing sidewall bears white lettering or bears manufacturer, brand, and/or model name molding that is higher or deeper than the same moldings on the inner facing sidewall.

Passenger (P-Metric) tire

A tire used on passenger cars and some light duty trucks and multipurpose vehicles.

Ply

A layer of rubber-coated parallel cords.

Pneumatic tire

A mechanical device made of rubber, chemicals, fabric and steel or other materials, that, when mounted on an automotive wheel provides the traction and contains the gas or fluid that sustains the load.

Pneumatic options weight

The combined weight of installed regular production options weighing over 5 lbs. (2.3 kg) in excess of the standard items which they replace, not previously considered in curb weight or accessory weight, including heavy duty breaks, ride levelers, roof rack, heavy duty battery, and special trim.

Recommended inflation pressure

Vehicle manufacturer's recommended tire inflation pressure as shown on the tire placard.

Radial ply tire

A pneumatic tire in which the ply cords that extend to the beads are laid at 90 degrees to the centerline of the tread.

Rim

A metal support for a tire and upon which the tire beads are seated.

Sidewall

The portion of a tire between the tread and the bead.

Speed rating

An alphanumeric code assigned to a tire indicating the maximum speed at which a tire can operate.

Traction

The friction between the tire and the road surface. The amount of grip provided.

Tread

The portion of a tire that comes into contact with the road.

Treadwear indicators

Narrow bands, sometimes called "wear bars", that show across the tread of a tire when only 1/16 in. of tread remains.

UTQGS

Uniform Tire Quality Grading Standards is a tire information system that provides consumers with ratings for a tire's traction, temperature and treadwear. Ratings are determined by tire manufacturers using government testing procedures. The ratings are molded into the sidewall of the tire.

Vehicle capacity weight

The number of designated seating positions multiplied by 150 lbs. (68 kg) plus the rated cargo and luggage load.

Vehicle maximum load on the tire

Load on an individual tire due to curb and accessory weight plus maximum occupant and cargo weight.

Vehicle normal load on the tire

Load on an individual tire that is determined by distributing to each axle its share of the curb weight, accessory weight, and normal occupant weight and dividing by 2.

Vehicle placard

A label permanently attached to a vehicle showing the original equipment tire size and recommended inflation pressure.

All season tires

HYUNDAI specifies all season tires on some models to provide good performance for use all year round, including snowy and icy road conditions. All season tires are identified by ALL SEASON and/or M+S (Mud and Snow) on the tire sidewall. Snow tires have better snow traction than all season tires and may be more appropriate in some areas.

Summer tires

HYUNDAI specifies summer tires on some models to provide superior performance on dry roads. Summer tire performance is substantially reduced in snow and ice. Summer tires do not have the tire traction rating M+S (Mud and Snow) on the tire side wall. If you plan to operate your vehicle in snowy or icy conditions, HYUNDAI recommends the use of snow tires or all season tires on all four wheels.

Snow tires

If you use snow tires, they should be the same size and have the same load capacity as the original tires. Snow tires should be installed on all four wheels. Otherwise, poor handling may result. Snow tires should carry 4 psi (28 kPa) more air pressure than the pressure recommended for the standard tires on the tire label located on the driver's side center pillar, or up to the maximum pressure shown on the tire sidewall, whichever is less. Do not drive faster than 75 mph (120 km/h) when your vehicle is equipped with snow tires.

Radial-ply tires

Radial-ply tires provide improved tread life, road hazard resistance and smoother high speed ride. The radial-ply tires used on this vehicle are of belted construction, and are selected to complement the ride and handling characteristics of your vehicle. Radial-ply tires have the same load carrying capacity, as bias-ply or bias belted tires of the same size, and use the same recommended inflation pressure. Mixing of radial-ply tires with bias-ply or bias belted tires is not recommended. Any combinations of radial-ply and bias-ply or bias belted tires when used on the same vehicle will seriously deteriorate vehicle handling. The best rule to follow is to use identical radial-ply tires as a pair for the the front tires and rear tires.

Longer wearing tires can be more susceptible to irregular tread wear. It is very important to follow the tire rotation interval in this chapter to achieve the tread life potential of these tires. Cuts and punctures in radial-ply tires are repairable only in the tread area, because of sidewall flexing. Consult your tire dealer for radial-ply tire repairs.

WARNING

Do not mix bias ply and radial ply tires under any circumstances. This may cause unusual handling characteristics that may cause loss of vehicle control and result in a collision.

Low aspect ratio tires

The aspect ratio is lower than 50 on low aspect ratio tires.

Because low aspect ratio tires are optimized for handling and braking, their sidewall is a little stiffer than a standard tire. Also low aspect ratio tires tend to be wider and consequently have a greater contact patch with the road surface. In some instances they may generate more road noise compared with standard tires.

CAUTION

Low aspect wheels and tires are easily damaged. To reduce the risk of damage:

- When driving on rough roads, passing over a pothole, speed bump, manhole, or curb stone, drive the vehicle slowly not to damage the tires and wheels. Damage is not covered by your vehicle warranty.
 - Inspect the tire condition and pressure every 1,800 mi. (3,000 km).
 - It is difficult to visually inspect for tire damage with your eyes. If any damage is found, contact your authorized HYUNDAI dealer to replace the tire.
-

Fuses

Blade type



Cartridge type



Multi type

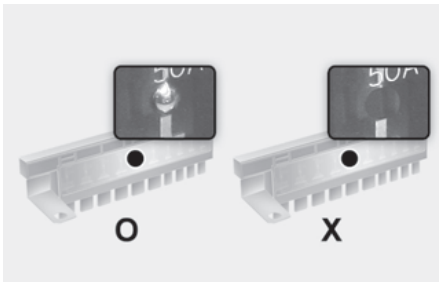

A vehicle's electrical system is protected from electrical overload damage by fuses.

This vehicle has 2 (or 3) fuse panels, one located in the driver's side panel bolster, the other in the engine compartment.

If any of your vehicle's lights, accessories, or controls do not work, check the appropriate circuit fuse. If a fuse has blown, the element inside the fuse is melted or broken.

If the electrical system does not work, first check the driver's side fuse panel. Before replacing a blown fuse, turn off the engine and all switches, and then disconnect the negative battery cable. Always replace a blown fuse with one of the same rating.

If the replacement fuse blows, this indicates an electrical problem. Avoid using the system involved and contact an authorized HYUNDAI dealer.

WARNING

Never replace a fuse with anything but another fuse of the same rating.

- A higher capacity fuse may cause damage and possibly cause a fire.
- Do not install a wire or aluminum foil instead of the proper fuse - even as a temporary repair. It may cause extensive wiring damage and possibly a fire.

NOTICE

Do not use a screwdriver or any other metal object to remove fuses because it may cause a short circuit and damage the system.

Instrument panel fuse replacement

1. Turn off the vehicle.
2. Turn off all other switches.
3. Open the fuse panel cover.

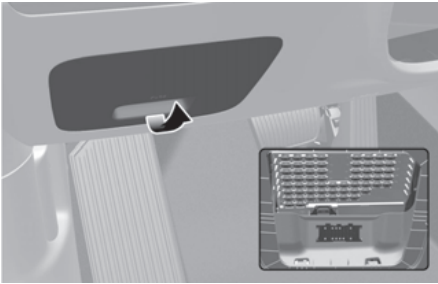

4. Refer to the label on the inside of the fuse panel cover to locate the suspected fuse location.
5. Pull the suspected tool straight out. Use the removal tool (1) provided in the engine compartment fuses panel cover.

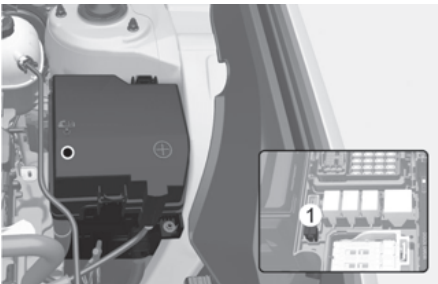

6. Check the removed fuse and replace it if it is blown. Spare fuses are provided in the instrument panel fuse panels (or in the engine compartment fuse panel).

7. Push in a new fuse of the same rating, and make sure it fits tightly in the clips. If it is not tight, contact an authorized HYUNDAI dealer.

In an emergency, if you do not have a spare fuse, use a fuse of the same rating from a circuit you may not need for operating the vehicle.

If the headlights or other electrical components do not work and the fuses are undamaged, check the fuse panel in the engine compartment.

Engine compartment panel fuse replacement

Blade fuse/Cartridge fuse

1. Turn off the vehicle.
2. Turn off all other switches.
3. Remove the fuse panel cover by pressing the tap and pulling up.
4. Refer to the label on the inside of the fuse panel cover to locate the suspected fuse location.
5. Pull the suspected fuse straight out. Use the removal tool provided in the engine compartment fuses panel cover.

Blade type



Cartridge type

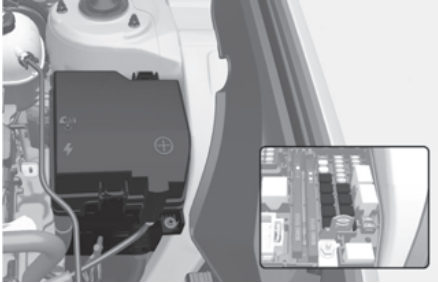

6. Check the removed fuse and replace it if it is blown. To remove or insert the fuse, use the fuse puller in the engine compartment fuse panel.
7. Push in a new fuse of the same rating, and make sure it fits tightly in the clips. If it is not tight, contact an authorized HYUNDAI dealer.

NOTICE

Always securely install the fuse panel cover. Water may contact the fuse and cause an electrical failure.

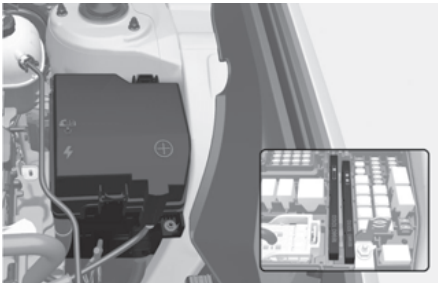
Multi fuse

If the multi fuse or midi fuse is blown, contact an authorized HYUNDAI dealer.

Instrument panel fuse panel

Fuse Name	Fuse Rating	Circuit Protected
MODULE7	10A	Steering Tilt & Telescopic Unit, E/R Junction Block (RLY.11), Data Link Connetor, Hazard Switch, Multifunction Switch, Rain Sensor, In Cabin Camera (ICC) Unit, Front A/C Control Module, UIP (Ultrasonic Intrusion Protect) Sensor, Driver Door Module, Power Tailgate Unit, Driver/Passenger Power Outside Mirror, Driver/Passenger Smart Key Outside Handle, Driver Lumbar Support Unit, Driver/Passenger Power Seat Switch, Driver/Passenger Power Seat Module, 2ND Power Seat Control Module LH/RH, 2ND Seat Heater Control Module, Passenger Air Ventilation Seat Control Module, UIP (Ultrasonic Intrusion Protect) Siren, Electronic Refrigerant Reduced Pressure Valve
S/HEATER (RR LH)	20A	2ND Power Seat Control Module LH
P/SEAT (PASS)	30A	Passenger Power Seat Switch, Passenger Power Seat Module
P/SEAT (RR RH)1	25A	2ND Power Seat Control Module RH
P/SEAT (DRV)1	30A	Driver Power Seat Module, Driver Power Seat Switch
INVERTER	30A	AC Inverter Module
AAF	15A	Active Air Flap (Upper LH/RH, Lower)
E-SHIFTER1	10A	Electronic ATM Shift Lever
S/HEATER (RR RH)	20A	2ND Seat Heater Control Module, 2ND Power Seat Control Module RH
S/HEATER (FRT)	25A	[W/O Power Seat] Passenger Seat Heater Control Module, [With Power Seat] Passenger Air Ventilation Seat Control Module
P/WINDOW (RH)	30A	Rear Safety Power Window Module RH, [LHD] Passenger Safety Power Window Module [RHD] Driver Safety Power Window Module
P/WINDOW (LH)	30A	Rear Safety Power Window Module LH, [LHD] Driver Safety Power Window Module [RHD] Passenger Safety Power Window Module
P/SEAT (RR LH)1	25A	2ND Power Seat Control Module LH

Fuse Name	Fuse Rating	Circuit Protected
A/C2	7.5A	E/R Junction Block (RLY.2, RLY.8), Front A/C Control Module, In-car Temperature Sensor, Front A/C Control Panel, Electronic A/C Compressor (Signal)
REAR A/C	10A	Rear A/C Control Module
MODULE6	7.5A	AC Inverter Module, AC Inverter Outlet, Head Lamp LH/RH, 12V Lithium Auxiliary Battery
WASHER	15A	Multifunction Switch
MODULE5	7.5A	BDC, E/R Junction Block (RLY.10)
AIR BAG2	10A	SRS Control Module
BRAKE SWITCH	7.5A	BDC, Stop Lamp Switch
CCU	10A	CCU
CHILD LOCK	15A	Child Lock/Unlock Relay
DOOR LOCK	20A	Door Lock Relay, Door Unlock Relay, Dead Lock Relay, ICM Relay Box (Fuel Lid Unlock Relay)
BDC1	10A	Driver/Passenger Smart Key Outside Handle, BDC, Front/Rear UWB Unit LH/RH, Bluetooth Unit, Interior UWB Unit
P/SEAT (RR RH)1	25A	2ND Power Seat Control Module RH
P/SEAT (RR LH)1	25A	2ND Power Seat Control Module LH
wireless DCU	10A	DCU
AMP	25A	AMP
P/SEAT (DRV)2	10A	[With 7Cell] Driver Lumbar Support Unit [W/O 7Cell] Driver Power Seat Switch
MEMORY	10A	ADAS Unit (Driving - RHD), Cluster Unit, ADAS Unit (Parking) Rear A/C Control Module, Fingerprint Recognition Unit, BDC, Infotainment Jack Assembly, Front A/C Control Module, Front A/C Control Panel, Head-Up Display, Mood Lamp Unit, Driver/Passenger Mood Lamp, Rear Door Mood Lamp LH/RH, Driver/Passenger Door Mood Lamp, Mood Lamp (Monitor)
MULTIMEDIA	25A	CCNC Head Unit
SUNROOF1	20A	Front Sunroof Motor

Fuse Name	Fuse Rating	Circuit Protected
HEATED MIRROR	7.5A	Driver/Passenger Power Outside Mirror
SUNROOF2	20A	Roller Blind Motor
START	7.5A	BDC, VDCU
BDC2	7.5A	BDC, BMS Control Module
MODULE4	10A	Driver/Passenger Power Seat Module, AMP, Crash Pad Switch, 2ND Power Seat Control Module LH/RH, Head Lamp LH/RH, Overhead Console Assembly, Electro Chromic Mirror, CCNC Head Unit, UVC Lamp, Fingerprint Recognition, Front A/C Control Panel, Front A/C Control Module, Wireless Charger Connector #1/ #2
MODULE8	10A	Multifunction Switch, Driver Door Module
AIR BAG1	10A	SRS Control Module
MODULE3	10A	CDCU, ADAS Unit (Driving/Parking), Crash Pad Switch, Floor Console Switch, AWD ECM, Steering Tilt & Telescopic Unit, In Cabin Camera (ICC) Unit, Front View Camera (ADAS), Front Corner Radar LH/RH, Smart Cruise Control Unit, Rear Corner Radar LH/RH
E-SHIFTER2	10A	Electronic ATM Shift Lever
MODULE2	10A	CCU, DCU, Stop Lamp Switch
CLUSTER	7.5A	Cluster Unit, Head-Up Display
MDPS2 ^{*1}	7.5A	MDPS Unit
USB CHARGER	15A	Infotainment Jack Assembly, Luggage USB Charger, Connector LH/RH, Driver/Passenger USB Charger Connector
IG3 2	10A	CCU, CDM Unit
MODULE1	10A	AMP, ADAS Unit (Parking - LHD), BDC, CCU, DCU, CCNC Keyboard, CCNC Head Unit, ADAS Unit (Driving)

*1 MDPS (Motor Driven Power Steering) is the same as EPS (Electric Power Steering)

Engine compartment fuse panel

Type	Fuse Name	Fuse Rating	Circuit Protected
MULTI	IEB1	40A	IEB Unit
	TRAILER1	40A	Trailer Connector
	POWER TAILGATE	40A	Power Liftgate Module
	CVVD	50A	CVVD Actuator
	B+5	50A	PDC (Fuse : F29/F36/F38/F46/F48/F49/F53/F56)
	IG1	50A	PCB Block (ACC Relay, IG1 Relay)
	AUX BATT	60A	12 V Lithium Auxiliary Battery
	COOLING FAN1	100A	Cooling Fan Motor
	IG2	40A	PCB Block (IG2 Relay)
	VDCU1	40A	VDCU
	IG3 1	40A	E/R Junction Block (RLY.6)
	B+3	60A	PDC (Fuse - F2/F9/F10/F17/F25/F26/F33/F34/F43/F44/F51/F52 /F58/F59)
	B+6	60A	PCB Block (Main Relay, Wiper Relay, Fuse : F19/F20/F21/F22)
	IEB2	60A	IEB Unit
MDPS1 ^{**}	100A	MDPS Unit	

Type	Fuse Name	Fuse Rating	Circuit Protected
FUSE	VDCU4	20A	VDCU
	HPCU3	10A	HPCU
	HPCU1	10A	HPCU
	HEAD LAMP LH	30A	Head Lamp LH
	HEAD LAMP RH	30A	Head Lamp RH
	REAR HEATED	40A	E/R Junction Block (RLY.4)
	B+1	50A	PDC (IPS4, IPS5, IPS6, IPS7)
	B+2	40A	PDC (IPS11, IPS12)
	BLOWER	60A	E/R Junction Block (RLY.11)
	TRAILER3	60A	Trailer Connector
	BATTERY C/FAN	20A	E/R Junction Block (RLY.10)
	4WD	20A	4WD ECM
	TRAILER2	20A	Trailer Connector
	AMS	10A	12V Battery Sensor
	VDCU2	20A	VDCU
	PTC HEATER2	60A	E/R Junction Block (RLY.8)
	PTC HEATER1	60A	E/R Junction Block (RLY.2)
	B+4	60A	PDC (Fuse : F4/F12/F20/F37/F47/F54/F55, IPS13, Long Term Load Latch Relay (Fuse : F5/F21)
	BATTERY MANAGEMENT	10A	BMS Control Module**
	OPCU1	20A	OPU (Signal - Oil Pump Unit)
	FUEL PUMP1	20A	E/R Junction Block (RLY.3)
	EWP1	10A	Electronic Water Pump (Engine)
	A/C1	10A	Front A/C Control Module, Rear A/C Control Module, Rear Blower Motor**
WIPER FRT2	10A	BDC, PCM, PCB Block (Wiper Front (LOW) Relay)**	

*1 MDPS (Motor Driven Power Steering) is the same as EPS (Electric Power Steering)

Engine compartment fuse panel (PCB block)

Fuse Name	Fuse Rating	Circuit Protected
POWER OUTLET1	20A	Luggage Power Outlet
POWER OUTLET2	20A	Front Power Outlet
WIPER FRT1	30A	Wiper Front (LOW) Relay, Front Wiper Motor**
SENSOR3	15A	Canister Close Valve
ECU1	20A	ECM
IGN COIL	20A	Ignition Coil #1, #2, #3, #4
WIPER RR	15A	Rear Wiper Motor, E/R Junction Block (RLY.7)**
SENSOR 1	15A	Oxygen Sensor (UP/DOWN)
OPCU2	15A	OPU (Signal - Oil Pump Unit)
ECU3	10A	ECM, CVVD Actuator
FUEL PUMP2	10A	E/R Junction Block (RLY.3)
SENSOR2	10A	Purge Control Solenoid Valve, Oil Control Valve #1/#2 (Intake/Exhaust), Oil Pump Solenoid Valve, Active Purge Pump, Evaporative Leak Check Monitor, Active Air Flap
EWP2	7.5A	Electronic Water Pump, Electronic Water Pump (Engine)
HPCU2	10A	HPCU
IEB3	10A	IEB Unit
ECU2	15A	ECM
TCU1	15A	TCM
ECU4	10A	ECM
HORN	15A	Horn Relay
TCU2	10A	TCM
VDCU3	10A	VDCU

Light Bulbs

Contact an authorized HYUNDAI dealer to replace most vehicle light bulbs. It is difficult to replace vehicle light bulbs because other parts of the vehicle must be removed before you can get to the bulb. This is especially true for removing the headlight assembly to get to the bulb(s).

Removing/installing the headlight assembly may result in damage to the vehicle.

WARNING

- Prior to replacing a light bulb, depress the brake pedal, shift to P (Park), apply the parking brake, move the Engine Start/Stop button to the OFF position, and take the key with you when leaving the vehicle to avoid sudden movement of the vehicle and to prevent possible electric shock.
 - Be aware the bulbs may be hot and may burn your fingers.
-

NOTICE

- Be sure to replace the burned-out bulb with one of the same wattage to prevent damage to the fuse or electrical wiring system.
 - To prevent damage, do not clean the headlight lens with chemical solvents or strong detergents.
-

i Information

Light desiccant (if equipped)

This vehicle is equipped with desiccant to reduce fogging inside the headlight, Daytime Running Light, parking light, tail light, and rear turn signal light due to moisture. The desiccant is consumable and its performance may change based on the used period or environment. If fogging inside the headlight, Daytime Running Light, parking light, tail light, and rear turn signal light due to moisture continues for a long time, contact an authorized HYUNDAI dealer.

i Information

The headlight and tail light lenses could appear to have condensation inside if the vehicle is washed after driving or if the vehicle is driven in wet weather. This condition is caused by a higher temperature inside the light and a cooler outside temperature. Moisture that condenses in the light is removed after driving with the light on. If the moisture is not removed, contact an authorized HYUNDAI dealer.

i Information

- A normally functioning light may flicker momentarily to stabilize the vehicle's electrical control system.

If the light goes out, or continues to flicker, contact an authorized HYUNDAI dealer.

- The parking light may not turn on when the parking light switch is turned on, but the parking light and headlight switch may turn on when the headlight switch is turned on. This may be caused by network failure or vehicle electrical control system malfunction. If this occurs, contact an authorized HYUNDAI dealer.

i Information

Adjust the headlight aim after a collision or the headlight is replaced.

Headlight, parking light, turn signal light, daytime running light (DRL) replacement

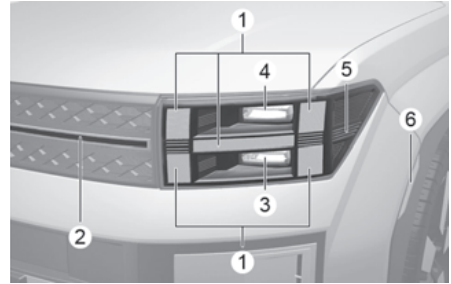

- (1) Parking light/Turn signal light/Daytime Running Light (DRL)
- (2) Auxiliary light
- (3) Headlight (High/Sub-low)
- (4) Headlight (Low)
- (5) Front side marker
- (6) Front side retro-reflector

If the LED light does not operate, contact an authorized HYUNDAI dealer for replacement.

The LED light cannot be replaced as a single unit. A skilled technician should check or repair the LED light, for it may damage related parts of the vehicle.

Side repeater light replacement

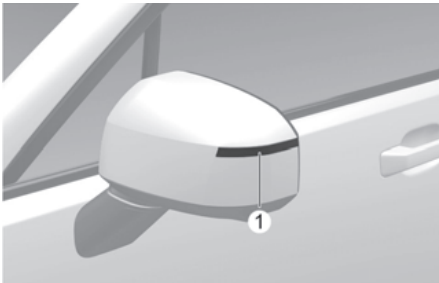

If the LED light 1 does not operate, contact an authorized HYUNDAI dealer for replacement.

The LED light cannot be replaced as a single unit. A skilled technician should check or repair the LED light, for it may damage related parts of the vehicle.

Rear combination light replacement

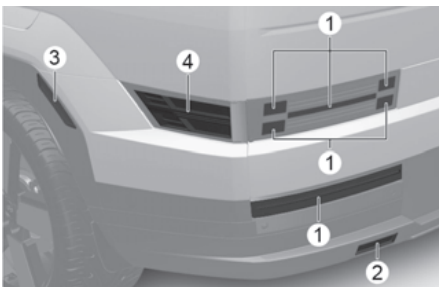

- (1) Parking light/Turn signal light/Stop light
- (2) Reverse light (bulb)
- (3) Rear side retro-reflector
- (4) Rear side marker

If the LED light does not operate, have your vehicle inspected by an authorized HYUNDAI dealer.

The LED light cannot be replaced as a single unit. A skilled technician should

check or repair the LED light, for it may damage related parts of the vehicle.

Replacing reverse light (bulb)

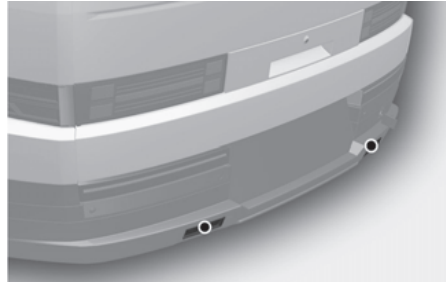

1. Apply the parking brake and turn off the engine.
2. Turn off all the lamps and open the liftgate panel.
3. Remove the clip on the liftgate panel.
4. Remove the socket from the assembly by turning the socket counterclockwise until the tabs on the socket align with the slots on the assembly.

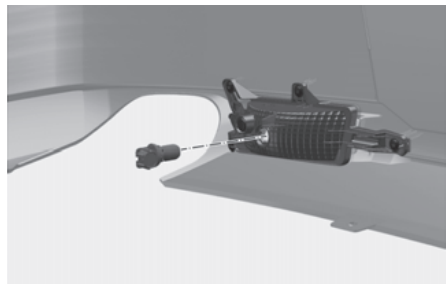

5. Remove the bulb from the socket by pressing it in and rotating it counterclockwise until the tabs on the bulb align with the slots in the socket. Pull the bulb out of the socket.
6. Install a new bulb and reinstall in the reverse order.

High mounted stop light replacement

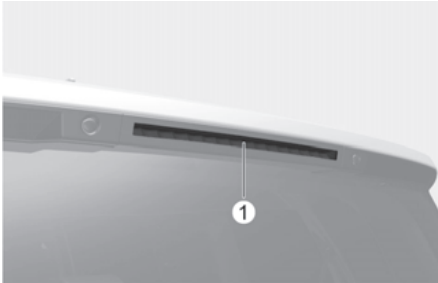

If the LED light 1 does not operate, contact an authorized HYUNDAI dealer for replacement.

The LED light cannot be replaced as a single unit. A skilled technician should check or repair the LED light, for it may damage related parts of the vehicle.

License plate light replacement

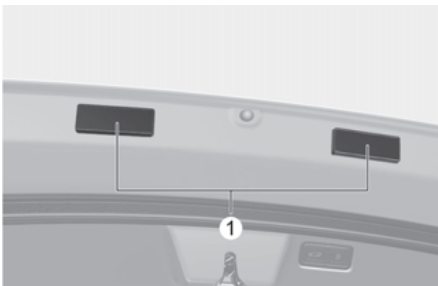

If the LED light does not operate, contact an authorized HYUNDAI dealer for replacement.

The LED light cannot be replaced as a single unit. A skilled technician should check or repair the LED light, for it may damage related parts of the vehicle.

Interior light replacement

Map lamp, Personal lamp, Multi console storage lamp, Vanity mirror lamp, Glove box lamp, Cargo area lamp

Map lamp

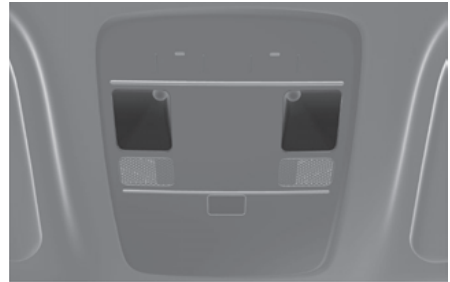

Personal lamp



Multi console storage lamp

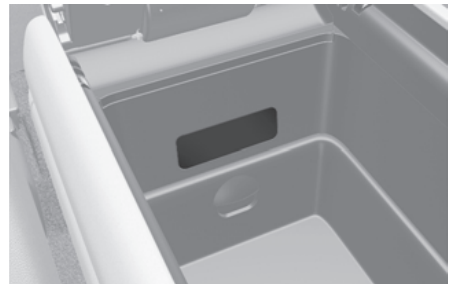

Vanity mirror lamp



Glove box lamp

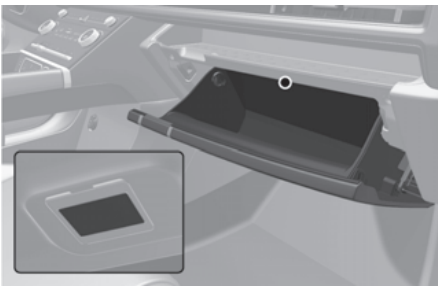

Cargo area lamp



If the LED light does not operate, contact an authorized HYUNDAI dealer for replacement.

The LED light cannot be replaced as a single unit. A skilled technician should check or repair the LED light, for it may damage related parts of the vehicle.

Appearance Care

Exterior care

Exterior general caution

It is very important to follow the label directions when using any chemical cleaner or polish. Read all warning and caution statements that appear on the label.

Finish maintenance

Washing

To help protect your vehicle's finish from rust and deterioration, with a frequency of at least once a month with lukewarm or cold water.

If you use your vehicle for off-road driving, wash it after each off-road trip. Pay special attention to the removal of any accumulation of salt, dirt, mud, and other foreign materials. Make sure the drain holes in the lower edges of the doors and rocker panels are kept clear and clean.

Insects, tar, tree sap, bird droppings, industrial pollution, and similar deposits may damage your vehicle's finish if not removed immediately.

Even prompt washing with plain water may not completely remove all these deposits. Use a mild soap, safe for use on painted surfaces.

After washing, rinse the vehicle thoroughly with lukewarm or cold water. Do not allow soap to dry on the finish.

NOTICE

High pressure water may damage front and rear cameras, sensors, vehicle trim, and boots (rubber or plastic covers) or connectors.

⚠ WARNING

After washing the vehicle, dry the brakes by applying them lightly while maintaining a slow forward speed.

NOTICE

- Do not use strong soap, chemical detergents, or hot water, and do not wash the vehicle in direct sunlight or when the body of the vehicle is warm.
- To prevent damage to the plastic parts, do not clean with chemical solvents or strong detergents.

NOTICE

- Water washing in the engine compartment including high pressure water washing may cause the failure of electrical circuits located in the engine compartment.
- Never allow water or other liquids to come in contact with electrical/electronic components inside the vehicle to prevent damage.

NOTICE

Matte paint finish vehicle (if equipped)
To prevent damage the matte finish:

- Do not go through an automatic car wash with rotating brushes.
- Avoid using a steam cleaner. High temperature steam may leave stains that are difficult to remove.
- Use a soft cloth (e.g. microfiber towel or sponge) when washing your vehicle and dry with a microfiber towel. When you hand wash your vehicle, do not use a cleaner that finishes with wax. If the vehicle surface is too dirty (sand, dirt, dust, contaminant, etc.), clean the surface with water before washing the vehicle.

Waxing

A good coat of wax helps protect your paint from contaminants.

Wax the vehicle when water no longer beads on the paint.

Always wash and dry the vehicle before waxing. Use a good quality liquid or paste wax, and follow the manufacturer's instructions. Wax all metal trim to protect it and to maintain its luster.

Removing oil, tar, and similar materials with a spot remover usually strips the wax from the finish. Be sure to re-wax these areas even if the rest of the vehicle does not yet need waxing.

NOTICE

- Do not wipe dust or dirt off the body with a dry cloth to prevent scratching the finish.
 - Do not use steel wool, abrasive cleaners, or strong detergents containing highly alkaline or caustic agents on chrome-plated or anodized aluminum parts to prevent discoloration or paint deterioration.
-

NOTICE

Matte paint finish vehicle (if equipped)

Do not use any polish protector such as detergent, abrasive, or polish. If wax is applied, remove the wax immediately using a silicone remover. If any tar or tar contaminant is on the surface, use a tar remover to clean.

Be careful not to apply too much pressure on the painted area.

Finish damage repair

Deep scratches or stone chips on the painted surface must be repaired promptly. Exposed metal quickly rusts and may develop into a major repair expense.

i Information

If your vehicle is damaged and requires any metal repair or replacement, make sure the body shop applies anti-corrosion materials to the parts repaired or replaced.

NOTICE

Matte paint finish vehicle (if equipped)

It is impossible to modify only repaint the damaged area. The whole part must be repainted as necessary. If the vehicle is damaged and painting is required, contact an authorized HYUNDAI dealer.

Bright-metal maintenance

- To remove road tar and insects, use a tar remover, not a scraper or other sharp object.
- To protect the surfaces of bright metal parts from corrosion, apply a coating of wax or chrome preservative and rub to a high luster.
- During winter weather or in coastal areas, cover the bright metal parts with a heavier coating of wax or preservative. If necessary, coat the parts with non-corrosive petroleum jelly or other protective compound.

Underbody maintenance

Corrosive materials used for ice and snow removal and dust control may collect on the underbody. If these materials are not removed, accelerated rusting may occur on underbody parts such as fuel lines, frame, floor pan, and exhaust system, even though they have been treated with rust protection.

Thoroughly flush the vehicle underbody and wheel openings with lukewarm or cold water once a month, after off-road driving and at the end of each winter. Pay special attention to these areas because it is difficult to see all the mud and dirt. It does more harm than good to wet down the road grime without removing it. The lower edges of doors, rocker panels, and frame members have drain holes that must not be allowed to clog with dirt. Trapped water in these areas may cause rusting.

Aluminum wheel maintenance

The aluminum wheels are coated with a clear protective finish.

NOTICE

- Do not use abrasive cleaner, polishing compound, solvent, or wire brushes on aluminum wheels.
- Use only a mild soap or neutral detergent, and rinse thoroughly with water. Also, clean the wheels after driving on salted roads.
- Do not wash the wheels with high-speed car wash brushes.
- Do not use any cleaners containing acid or alkaline detergents.

Corrosion protection

Protecting your vehicle from corrosion

By using the most advanced design and construction practices to combat corrosion, HYUNDAI produces vehicles of the highest quality. However, this is only part of the job. To achieve the long-term corrosion resistance your vehicle can deliver, the owner's cooperation and assistance are also required.

Common causes of corrosion

The most common causes of corrosion on your vehicle are:

- Road salt, dirt, and moisture that is allowed to accumulate underneath the vehicle.
- Removal of paint or protective coatings by stones, gravel, abrasion, minor scrapes, and dents that leave unprotected metal exposed to corrosion

High-corrosion areas

If you live in an area where your vehicle is regularly exposed to corrosive materials, corrosion protection is particularly important. Some of the common causes of accelerated corrosion are road salts, dust control chemicals, ocean air, and industrial pollution.

Moisture breeds corrosion

Moisture creates the conditions in which corrosion is most likely to occur. For example, corrosion is accelerated by high humidity, particularly when temperatures are just above freezing. In such conditions, the corrosive material is kept in contact with the vehicle surfaces by moisture that is slow to evaporate.

Mud is particularly corrosive because it is slow to dry and holds moisture in contact with the vehicle. Although the mud appears to be dry, it can still retain moisture and promote corrosion.

High temperatures may also accelerate corrosion of parts that are not properly ventilated so the moisture can be dispersed. For all these reasons, it is particularly important to keep your vehicle clean and free of mud or accumulation of other materials. This applies not only to the visible surfaces but particularly to the underside of the vehicle.

To help prevent corrosion

Keep your vehicle clean

The best way to prevent corrosion is to keep your vehicle clean and free of corrosive materials. Attention to the underside of the vehicle is particularly important.

- If you live in a high-corrosion area - where road salts are used, near the ocean, areas with industrial pollution, acid rain, and the like, take extra care to prevent corrosion. In winter, hose off the underside of your vehicle at least once a month and be sure to clean the underside thoroughly when winter is over.
- When cleaning underneath the vehicle, pay particular attention to the components under the fenders and other areas that are hidden from view. Do a thorough job. Just dampening the accumulated mud rather than washing it away may accelerate corrosion rather than prevent it. Water under high pressure and steam are particularly effective in removing accumulated mud and corrosive materials.
- When cleaning lower door panels, rocker panels, and frame members, make sure that drain holes are kept open so that moisture can escape and not be trapped inside to accelerate corrosion.

Keep your garage dry

Do not park your vehicle in a damp, poorly ventilated garage. This creates a favorable environment for corrosion.

This is particularly true if you wash your vehicle in the garage or drive it into the garage when it is still wet or covered with snow, ice, or mud. Even a heated garage may contribute to corrosion unless it is well ventilated so moisture is dispersed.

Keep paint and trim in good condition

Scratches or chips in the finish must be covered with "touch-up" paint as soon as possible to reduce the possibility of corrosion. If bare metal is showing through, the attention of a qualified body and paint shop is recommended.

Bird droppings are highly corrosive and may damage painted surfaces in just a few hours. Always remove bird droppings as soon as possible.

Interior care

Interior general precautions

Prevent caustic solutions such as perfume and cosmetic oil, from contacting the interior parts because they may cause damage or discoloration. If they do contact the interior parts, wipe them off immediately. Refer to the instructions for the proper way to clean vehicle interior surfaces.

NOTICE

- Never allow water or other liquids to come in contact with electrical/electronic components inside the vehicle because this may damage them.
 - When cleaning leather products (steering wheel, seats, etc.), use neutral detergents or low alcohol content solutions. If you use high alcohol content solutions or acid/alkaline detergents, the color of the leather may fade or the surface may get stripped off.
-

Cleaning the upholstery and interior trim

Vehicle interior surfaces

+ if equipped

Remove dust and loose dirt from interior surfaces with a whisk broom or a vacuum cleaner.

If necessary, clean interior surfaces with a mixture of warm water and mild non-detergent cleaner (test all cleaners on a concealed area before use).

Fabric

+ if equipped

Remove dust and loose dirt from fabric with a whisk broom or vacuum cleaner. Clean with a mild soap solution recommended for upholstery or carpets. Remove fresh spots immediately with a fabric spot cleaner. If you do not pay attention to fresh spots immediately, the fabric may be stained and its color may be affected. Also, its fire-resistant properties may be reduced if the material is not properly maintained.

NOTICE

Using anything but recommended cleaners and procedures may affect the fabric's appearance and fire-resistant properties.

Leather

 if equipped

- Features of seat leather
 - Leather is made from the outer skin of an animal, which goes through a special process to be available for use. Because it is a natural product, each part differs in thickness or density.
Wrinkles may appear as a natural result of stretching and shrinking depending on the temperature and humidity.
 - The seat is made of stretchable fabric to improve comfort.
 - The parts contacting the body are curved and the side supporting area is high which provides driving comfort and stability.
 - Wrinkles may appear naturally from usage. It is not a fault of the products.

NOTICE

- Wrinkles or abrasions that appear naturally from usage are not covered by warranty.
- Belts with metallic accessories, zippers, or keys inside the back pocket may damage the seat fabric.
- Be sure not to wet the seat. It may change the nature of natural leather.
- Jeans or clothes that could bleach may contaminate the surface of the seat covering fabric.
- Caring for the leather seats
 - Vacuum the seat periodically to remove dust and sand on the seat. It prevents abrasion or damage of the leather and maintain its quality.
 - Wipe the natural leather seat cover often with a dry or soft cloth.
 - Use of proper leather protector may prevent abrasion of the cover and helps maintain the color. Be sure to read the instructions and consult a specialist when using leather coating or protective agent.
 - Light colored (beige, cream beige) leather may be easily contaminated and the stains may be noticeable.
 - Avoid wiping with a wet cloth. It may cause the surface to crack.

- Cleaning the leather seats
 - Remove all spills instantly.
 - For Cosmetic products (sunscreen, foundation, etc.)
Apply cleansing cream on a cloth and wipe the contaminated spot. Wipe off the cream with a damp loth and then wipe with a dry cloth.
 - For Beverages (coffee, soft drink, etc.)
Apply a small amount of neutral detergent and wipe until it does not smear.
 - For oil
Remove oil instantly with an absorbable cloth and wipe with stain remover used only for natural leather.
 - For chewing gum
Harden the gum with ice and remove it gradually.
 - Handling prime napa leather (if equipped)
Try to avoid excessive sunlight and heat exposure. Excessive sunlight and heat exposure naturally fades and dries out napa leather, causing wrinkles and discoloration. If the napa leather is wet with liquid, immediately clean it with lint-free cloth to minimize damage. Do not scratch the napa leather surface with a sharp object. If your napa leather seat is bright colored, it may be contaminated or stained from dyed materials such as jeans.
-

Interior wooden trim

- Use a wooden furniture protector (e.g. wax, coating compound) to clean the interior wooden trim.
- Sharp objects (for example, driver, knife), adhesive materials, or tapes may damage the interior wooden trim.
- Any strong impacts may damage the interior wooden trim.
- If the coating finish over the interior wooden trim is removed, moisture may damage or change wood traits.
- If the interior wooden trim is damaged, you may get a splinter from the wood surface. Have the damaged interior wooden trim replaced by an authorized HYUNDAI dealer.

Cleaning the seat belt webbing

Clean the belt webbing with any mild soap solution recommended for cleaning upholstery or carpet. Follow the instructions provided with the soap.

⚠ WARNING

Do not bleach or re-dye the webbing because this may weaken the seat belt.

Cleaning the interior window glass

If the interior glass surfaces need to be cleaned, use a glass cleaner. Follow the directions on the glass cleaner container.

NOTICE

Do not scrape or scratch the inside of the rear window. This may result in damage to the rear window defroster grid.

Emission Control System

The emission control system of your vehicle is covered by a written limited warranty. Please see the warranty information contained in the Owner's Handbook & Warranty Information booklet in your vehicle.

Your vehicle is equipped with an emission control system to meet all applicable emission regulations. There are three emission control systems, as follows:

- (1) Crankcase emission control system
- (2) Evaporative emission control system
- (3) Exhaust emission control system

In order to ensure the proper function of the emission control systems, it is recommended that you have your vehicle inspected and maintained by an authorized HYUNDAI dealer in accordance with the maintenance schedule in this manual.

NOTICE

For the Inspection and Maintenance Test (with Electronic Stability Control (ESC) system)

- To prevent the vehicle from misfiring during dynamometer testing, turn the Electronic Stability Control (ESC) system off by pressing the ESC button (ESC OFF light illuminated).
 - After dynamometer testing is completed, turn the ESC system back on by pressing the ESC button again.
-

1. Crankcase emission control system

The positive crankcase ventilation system is employed to prevent air pollution caused by blow-by gases being emitted from the crankcase. This system supplies fresh filtered air to the crankcase through the air intake hose. Inside the crankcase, the fresh air mixes with blow-by gases, which then pass through the PCV valve into the induction system.

2. Evaporative emission control system including onboard refueling vapor recovery (ORVR)

The Evaporative Emission Control System is designed to prevent fuel vapors from escaping into the atmosphere. The ORVR system is designed to allow the vapors from the fuel tank to be loaded into a canister while refueling at the gas station, preventing the escape of fuel vapors into the atmosphere.

Canister

Fuel vapors generated inside the fuel tank are absorbed and stored in the onboard canister. When the engine is running, the fuel vapors absorbed in the canister are drawn into the surge tank through the purge control solenoid valve.

Purge Control Solenoid Valve (PCSV)

The purge control solenoid valve is controlled by the Engine Control Module (ECM). When the engine coolant temperature is low during idling, the PCSV closes so that evaporated fuel is not taken into the engine. After the engine warms up during ordinary driving, the PCSV opens to introduce evaporated fuel to the engine.

3. Exhaust emission control system

The Exhaust Emission Control System controls exhaust emissions while maintaining good vehicle performance.

When the engine starts or fails to start, excessive attempts to restart the engine may cause damage to the emission system.

Engine exhaust (carbon monoxide) precautions

- Carbon monoxide is present with other exhaust fumes. If you smell exhaust fumes in your vehicle, drive with all the windows fully open. Have your vehicle inspected and repaired immediately.
- Do not operate the engine in confined or closed areas (such as garages) any more than what is necessary to move the vehicle in or out of the area.
- When the vehicle is stopped in an open area for more than a short time with the engine running, adjust the ventilation system (as needed) to draw outside air into the vehicle.
- Never sit in a parked or stopped vehicle for an extended time with the engine running.
- When the engine stalls or fails to start, excessive attempts to restart the engine may cause damage to the emission control system.

For more information, refer to "Driving Your Vehicle" at the beginning of chapter 6.

! WARNING

Engine exhaust gases contain carbon monoxide (CO). Though colorless and odorless, it is dangerous and could be lethal if inhaled. Follow the instructions on this page to avoid CO poisoning.

Operating precautions for catalytic converters

 if equipped

! WARNING

The exhaust system and catalytic system are very hot while the engine is running or immediately after the engine is turned off. To avoid serious injury or death:

- Do not park, idle, or drive the vehicle over or near flammable objects, such as grass, vegetation, paper, leaves, etc. A hot exhaust system may ignite flammable items under your vehicle.
- Keep away from the exhaust system and catalytic converter or you may get burned.

Also, do not remove the heat sink around the exhaust system, do not seal the bottom of the vehicle, and do not coat the vehicle for corrosion control. It may present a fire risk under certain conditions.

Your vehicle is equipped with a catalytic converter emission control device.

NOTICE

To prevent damage to the catalytic converter and to your vehicle, take the following precautions:

- Use only UNLEADED FUEL for gasoline engines.
- Do not operate the vehicle when there are signs of engine malfunction, such as misfire or a noticeable loss of performance.
- Do not misuse or abuse the engine. Examples of misuse are coasting with the engine off and descending steep grades in gear with the engine off.
- Do not operate the engine at high idle speed for extended an extended period of time (5 minutes or more).
- Do not modify or tamper with any part of the engine or emission control system. Have all inspections and adjustments made by an authorized HYUNDAI dealer.
- Avoid driving with an extremely low fuel level.

Running out of fuel may cause the engine to misfire, damaging the catalytic converter.

Failure to follow these precautions may void your vehicle warranty.

Fuel Requirements

Gasoline engine

Unleaded

Your new vehicle is designed to perform optimally with unleaded fuel having an octane number $((R+M)/2)$ of 87 (Research Octane Number 91) or higher.

Your new vehicle is designed to obtain maximum performance with UNLEADED FUEL, as well as minimize exhaust emissions and spark plug fouling.

Gasoline containing ethanol and methanol

Gasohol, a mixture of gasoline and ethanol (also known as grain alcohol) are being marketed along with or instead of leaded or unleaded gasoline. For example, "E15" is a gasohol comprised of 15% ethanol and 85% gasoline.

Do not use gasohol containing more than 15% ethanol, and do not use gasoline or gasohol containing any methanol. Do not use gasohol containing more than 15% ethanol, and do not use gasoline or gasohol containing any methanol. Never use leaded fuel or leaded gasohol. Use of these fuels may damage the fuel system, engine control system, and emission control system.

Discontinue using gasohol of any kind if problems occur. "E85" fuel is an alternative fuel comprised of 85% ethanol and 15% gasoline, and is manufactured exclusively for use in Flexible Fuel Vehicles. "E85" is not compatible with your vehicle. Use of "E85" may result in poor engine performance and damage to your vehicle's engine and fuel system.

NOTICE

Damage to the fuel system or performance issues caused by the use of these fuels may not be covered by your New Vehicle Limited Warranty.

Using Fuel Additives (except Detergent Fuel Additives)

Using fuel additives such as:

- Silicone fuel additive
- Ferrocene (iron-based) fuel additive
- Other metallic-based fuel additives

May result in cylinder misfire, poor acceleration, engine stalling, damage to the catalyst, or abnormal corrosion, and may cause damage to the engine resulting in a reduction in the overall life of the powertrain.

- The Malfunction Indicator Lamp (MIL) may illuminate.

NOTICE

Damage to the fuel system or performance issues caused by the use of these fuel additives may not be covered by your New Vehicle Limited Warranty.

Gasoline containing MMT

Some gasoline contains harmful manganese-based fuel additives such as MMT (Methylcyclopentadienyl Manganese Tricarbonyl).

HYUNDAI does not recommend the use of gasoline containing MMT.

This type of fuel can reduce vehicle performance and affect your emission control system.

The malfunction indicator lamp on the cluster may come on.

Detergent Fuel Additives

HYUNDAI recommends that you use good quality gasolines treated with detergent additives such as TOP TIER Detergent Gasoline, which help prevent deposit formation in the engine. These gasolines will help the engine run cleaner and enhance performance of the Emission Control System. For more information on TOP TIER Detergent Gasoline, go to the website (www.toptiergas.com).

For customers who do not use TOP Tier Detergent Gasoline regularly, and have problems starting or the engine does not run smoothly, detergent-based fuel additives that you can purchase separately may be added to the gasoline. If TOP TIER Detergent Gasoline is not available, one bottle of additive added to the fuel tank according to the maintenance schedule is recommended (refer to the "Scheduled Maintenance Services" section in this chapter).

Additives are available from your authorized HYUNDAI dealer along with information on how to use them.

NOTICE

Never add any fuel system cleaning agents or other additives to the fuel tank other than HYUNDAI fuel additives to prevent damage to the engine and engine components.

Contact an authorized HYUNDAI dealer for additional information.

California Perchlorate Notice

Notice to California Vehicle
Dismantlers: The airbag module, safety
belt pretensioners, and remote batteries
must be disposed of according to Title 22
California Code of Regulations Section
67384.10 (a). Special handling may be
necessary. See:
www.dtsc.ca.gov/hazardouswaste/perchlorate. Contact an authorized HYUNDAI
dealer for handling and disposal.

10. Vehicle Information, Reporting Safety Defects, And Consumer Information

Dimensions	10-2
Engine.....	10-2
Bulb Wattage	10-3
Tires And Wheels	10-4
Air Conditioning System	10-5
Volume And Weight.....	10-5
Reference Weight And Distance When Towing A Trailer	10-6
Recommended Lubricants And Capacities	10-7
Recommended SAE viscosity number	10-8
Vehicle Identification Number (VIN).....	10-9
Vehicle Certification Label.....	10-9
Tire Specification And Pressure Label.....	10-9
Engine Number	10-10
Refrigerant Label	10-10
Air Conditioner Compressor Label	10-10
Operation In Foreign Countries	10-11
Hyundai Vehicle Owner Privacy Policy	10-12
Vehicle Data Collection And Event Data Recorders	10-13
Reporting Safety Defects.....	10-14
FCC statement	10-15
Consumer Information.....	10-16
Open Source Software Notice	10-17

Dimensions

Items		in (mm)	
Overall length		190.2 (4,830)	
Overall width		74.8 (1,900)	
Overall height	Without Roof rack	67.72 (1,720)	
	With Roof rack	69.69 (1,770)	
Tread		Front	Rear
		18" : 64.80 (1,646)	18" : 65.20 (1,656)
		20" : 64.45 (1,637)	20" : 64.84 (1,647)
Wheelbase		110.8 (2,815)	

Engine

Engine	Displacement cu. in (cc)	Bore x Stroke in. (mm)	Firing order	No. of cylinders
Smartstream G1.6 T-GDi HEV	97.52 (1,598)	2.98 x 3.5 (75.6 x 89.0)	1-3-4-2	4, in-line

Bulb Wattage

Light bulb		Bulb type	Wattage	
Front	Headlight	High	LED	
		Low	LED	
	Daytime Running Light (DRL) / Parking light		LED	LED
	Turn signal light		LED	LED
	Side marker		LED	LED
	Side repeater light (Side mirror)		LED	LED
Rear	Tail light		LED	LED
	Tail/Stop light		LED	LED
	Turn signal light		LED	LED
	Reverse light		W16W	16W
	Side marker		LED	LED
	License plate light		LED	LED
	High mounted stop light		LED	LED
Interior	Map lamp		LED	LED
	Rear personal lamp		LED	LED
	Glove box lamp		LED	LED
	Vanity mirror lamp		LED	LED
	Cargo area lamp		LED	LED

Tires And Wheels

Items	Tire size	Wheel size	Inflation pressure psi (kPa)				Wheel nut torque lbf-ft (kgf-m, N-m)
			Normal load		Maximum load		
			Front	Rear	Front	Rear	
Full size tire	235/60 R18	7.5J X 18	35 (240)				79-94 (11-13, 107-127)
	255/45 R20	8.5J X 20	36 (250)				

NOTICE

- It is permissible to add 3 psi (20 kPa) to the standard tire pressure specification if colder temperatures are expected soon. Tires typically lose 1 psi (7 kPa) for every 12 °F (7 °C) temperature drop. If extreme temperature variations are expected, recheck your tire pressure as necessary to keep them properly inflated.
- Tire inflation pressures may vary depending on changes in elevation. If driving in areas of higher or lower elevation, be sure to check and adjust for proper tire inflation.
- Do not exceed the maximum inflation pressure, as found on the sidewall of the tire(s).

CAUTION

When replacing tires, ALWAYS use the same size, type, brand, construction, and tread pattern supplied with the vehicle. If not, it can damage the related parts or make it work irregularly.

Air Conditioning System

Items		Weight of volume	Classification
Refrigerant oz. (g)	Front	22.05 ± 0.88 (625 ± 25)	R-1234yf
	Front+Rear	28.22 ± 0.88 (800 ± 25)	
Compressor lubricant oz. (g)	Front	5.29 ± 0.35 (150 ± 10)	POE
	Front+Rear	8.11 ± 0.35 (230 ± 10)	

Contact an authorized HYUNDAI dealer for more details.

Volume And Weight

Items		2WD	4WD
Gross vehicle weight lbs. (kg)		5,655 (2,565)	5,799 (2,630)
Cargo area volume (SAE) cu. ft (ℓ)	Behind 1st row	79.56 (2,253)	
	Behind 2nd row	40.54 (1,148)	
	Behind 3rd row	14.58 (413)	

Reference Weight And Distance When Towing A Trailer

The following table indicates the maximum trailer weight for your vehicle. Do not exceed the maximum allowable trailer weight. The maximum trailer weight includes the weight of the trailer, any cargo, and equipment or items attached to the trailer. The towing load in excess of these limits can seriously affect vehicle steering and performance, and may damage the motor and drivetrain.

Item		With trailer package
Maximum trailer weight lbs. (kg)	With brake system	2,000 (907)
	Without brake system	1,654 (750)
Maximum tongue weight *1 lbs. (kg)		280 (127)

*1 Tongue weight should be between allowable 10-15%

Any additional weight, cargo, or accessories in your vehicle will reduce the maximum trailer weight and corresponding tongue load limits.

Recommended Lubricants And Capacities

To help achieve proper engine and powertrain performance and durability, use only lubricants of the proper quality. The correct lubricants also help promote the engine efficiency that results in improved fuel economy.

These lubricants and fluids are recommended for use in your vehicle.

Lubricant	Volume	Classification
Engine oil **2 (drain and refill) Recommends 	5.07 US qt. (4.8 ℓ)	SAE 0W-20, API SN PLUS/SP or ILSAC GF-6 ³
Automatic transmission fluid	6.3 US qt. (6.0 ℓ)	SK ATF SP4M-1, MICHANG ATF SP4M-1, S-OIL ATF SP4M-1 or other brands meeting the above specification approved by HYUNDAI Motor Co.
Coolant	9.4 US qt. (8.9 ℓ)	MIXTURE, Antifreeze with water (Ethylene glycol base coolant for aluminum radiator)
Brake fluid *4	As required	DOT-4
Rear differential oil (4WD) *5	0.56 ~ 0.67 US qt. (0.53 ~ 0.63 ℓ)	HYPOID GEAR OIL API GL-5, SAE 75W/85 (SK HCT-5 GEAR OIL 75W/85 or EQUIVALENT)
Transfer case oil (4WD) *5	0.66 - 0.72 US qt. (0.62 ~ 0.68 ℓ)	
Fuel	17.7 US gal. (67 ℓ)	Refer to the "Fuel Requirements" section in chapter 9.

*1 Refer to the Recommended SAE viscosity number.

*2 Engine oils labeled Energy Conserving Oil are now available. Along with other additional benefits, they contribute to fuel economy by reducing the amount of fuel necessary to overcome engine friction. Often, these improvements are difficult to measure in everyday driving, but in a year's time, they can offer significant cost and energy savings.

*3 Requires <API SN PLUS (or above) Full synthetic> grade engine oil. If a lower grade engine oil (mineral oil including Semi-synthetic) is used, then the engine oil and engine oil filter must be replaced as indicated severe maintenance condition.

*4 To maintain the best braking performance and ABS/ESC performance, use genuine brake fluid that conform to specifications. (SAE J1704 DOT-4 LV, FMVSS 116 DOT-4, ISO4925 CLASS-6)

*5 If the transfer case/rear differential is submerged, visit an authorized HYUNDAI genuine products to replace the differential oil.

NOTICE

Severe engine and transmission damage may result from the use of poor quality fuels and lubricants that do not meet HYUNDAI specifications. Always use high quality fuels and lubricants that meet the specifications listed in the recommended table.

Recommended SAE viscosity number

NOTICE

- Always be sure to clean the area around any filler plug, drain plug, or dipstick before checking or draining any lubricant. This is especially important in dusty or sandy areas and when the vehicle is used on unpaved roads. Cleaning the plug and dipstick areas will prevent dirt and grit from entering the engine and other mechanisms that could be damaged.
- Never add any additives to the engine oil. Engine oil additives can change the properties of engine oil and may cause serious engine failure.

Engine oil viscosity (thickness) has an effect on fuel economy and cold weather operating (engine start and engine oil flowability). Lower viscosity engine oils can provide better fuel economy and cold weather performance, however, higher viscosity engine oils are required for satisfactory lubrication in hot weather. Using oils of any viscosity other than those recommended may result in engine damage.

When choosing an oil, consider the range of temperature your vehicle is operated in before the next oil change. Proceed to select the recommended oil viscosity from the chart.

Temperature Range for SAE Viscosity Numbers										
Temperature	°C	-30	-20	-10	0	10	20	30	40	50
	(°F)	-10	0	20	40	60	80	100	120	
Smartstream G1.6 T-GDi HEV	0W20									



An engine oil displaying this API Certification Mark conforms to the international Lubricant Specification Advisory Committee (ILSAC). It is recommended to only use engine oils that uphold this API Certification Mark.

Vehicle Identification Number (VIN)

Frame number

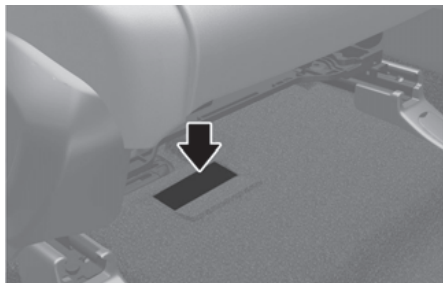

The vehicle identification number (VIN) is the number used in registering your vehicle and in all legal matters pertaining to its ownership, etc.

The number is punched on the floor under the right front seat. To check the number, open the cover.

VIN label (if equipped)

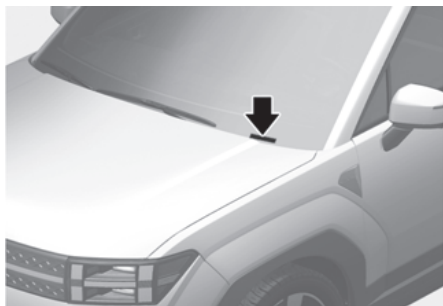

The VIN is also on a plate attached to the top of the left side dashboard. The number on the plate can easily be seen through the windshield from outside.

Vehicle Certification Label



The vehicle certification label attached on the driver's side center pillar gives the vehicle identification number (VIN).

Tire Specification And Pressure Label



The tires supplied on your new vehicle are chosen to provide the best performance for normal driving.

The tire label located on the driver's side center pillar gives the tire pressures recommended for your vehicle.

Engine Number

Smartstream G1.6 T-GDi HEV

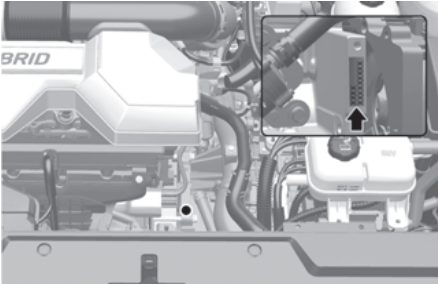

The engine number is stamped on the engine block as shown in the illustration.

Refrigerant Label



The refrigerant label provides information such as refrigerant type and amount. (R-1234yf)

Air Conditioner Compressor Label

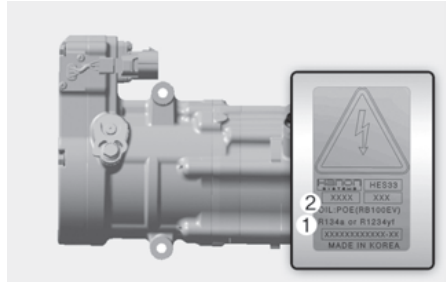

A compressor label informs you the type of compressor your vehicle is equipped with such as model, supplier part number, production number, refrigerant (1) and refrigerant oil (2).

Operation In Foreign Countries

If you are going to drive your vehicle in another country, be sure to:

- Observe all regulations regarding registration and insurance.
- Determine that acceptable fuel is available.

Hyundai Vehicle Owner Privacy Policy

Your Hyundai vehicle may be equipped with technologies and services that use information collected, generated, recorded, or stored by the vehicle. Hyundai has created a Vehicle Owner Privacy Policy to explain how these technologies and services collect use and share this information.

You may read our Vehicle Owner Privacy Policy on the Hyundaiusa.com website at: <https://www.hyundaiusa.com/owner-privacy-policy.aspx>

If you would like to receive a hard copy of our Vehicle Owner Privacy Policy, please contact our Customer Care Center at:

Hyundai Customer Care

P.O. Box 20850

Fountain Valley, CA 92728 800-633-5151

consumeraffairs@hmmausa.com

Hyundai's Customer Care representatives are available Monday through Friday, between the hours of 6:00 AM and 5:00 PM PST and Saturday between 6:30 AM and 3:00 PM PST (English).

For Customer Care assistance in Spanish or Korean, representatives are available Monday through Friday between 6:30 AM and 3:00 PM PST.

Vehicle Data Collection And Event Data Recorders

This vehicle is equipped with an event data recorder (EDR). The main purpose of an EDR is to record, in certain crash or near crash-like situations, such as an air bag deployment or hitting a road obstacle, data that will assist in understanding how a vehicle's systems performed. The EDR is designed to record data related to vehicle dynamics and safety systems for a short period of time, typically 30 seconds or less.

The EDR in this vehicle is designed to record such data as:

- How various systems in your vehicle were operating;
- Whether or not the driver and passenger safety belts were buckled/fastened;
- How far (if at all) the driver was depressing the accelerator and/or brake pedal; and,
- How fast the vehicle was traveling.

These data can help provide a better understanding of the circumstances in which crashes and injuries occur.

NOTE: EDR data are recorded by your vehicle only if a non-trivial crash situation occurs; no data are recorded by the EDR under normal driving conditions and no personal data (for example, name, gender, age, and crash location) are recorded. However, other parties, such as law enforcement, could combine the EDR data with the type of personally identifying data routinely acquired during a crash investigation.

To read data recorded by an EDR, special equipment is required, and access to the vehicle or the EDR is needed. In addition to the vehicle manufacturer, other parties, such as law enforcement, that have the special equipment, can read the information if they have access to the vehicle or the EDR.

Reporting Safety Defects

If you believe that your vehicle has a defect which could cause a crash or could cause injury or death, you should immediately inform the National Highway Traffic Safety Administration (NHTSA) in addition to notifying HYUNDAI MOTOR AMERICA.

To contact NHTSA, you may call the Vehicle Safety Hotline toll-free at 1-888-327-4236 (TTY: 1-800-424-9153);

go to <http://www.safercar.gov>;

download the SaferCar mobile application;

or write to: Administrator, NHTSA

1200 New Jersey Ave, SE,

West Building Washington, D.C. 20590.

You can also obtain other information about motor vehicle safety from

<http://www.safercar.gov>.

If NHTSA receives similar complaints, it may open an investigation, and if it finds that a safety defect exists in a group of vehicles, it may order a recall and remedy campaign. However, NHTSA cannot become involved in individual problems between you, your dealer, or HYUNDAI MOTOR AMERICA.

FCC statement

The following regulatory statement applies to all Radio Frequency (RF) devices equipped in this vehicle:

This device complies with Part 15 of the FCC Rules and with Innovation, Science and Economic Development Canada license-exempt RSS standard(s).

Operation is subject to the following two conditions:

1. This device may not cause harmful interference, and
2. This device must accept any interference received, including interference that may cause undesired operation.

Le present appareil est conforme aux CNR d` Innovation, Science and Economic Development applicables aux appareils radio exempts de licence. L'exploitation est autorisee aux deux conditions suivantes:

1. l'appareil ne doit pas produire de brouillage, et
2. l'utilisateur de l'appareil doit accepter tout brouillage radioelectrique subi, meme si le brouillage est susceptible d'en compromettre le fonctionnement.

La operacion de este equipo esta sujeta a las siguientes dos condiciones:

1. es posible que este equipo o dispositivo no cause interferencia perjudicial y
2. este equipo o dispositivo debe aceptar cualquier interferencia, incluyendo la que pueda causar su operacion no deseada.

i Information

Changes or modifications not expressly approved by the party responsible for compliance could void the user's authority to operate the equipment.

Consumer Information

This consumer information has been prepared in accordance with regulations issued by the National Highway Traffic Safety Administration of the U.S. Department of Transportation. Your HYUNDAI dealer will help answer any questions you may have as you read this information.

HYUNDAI motor vehicles are designed and manufactured to meet or exceed all applicable safety standards.

For your safety, however, we strongly urge you to read and follow all directions in this Owner's Manual, particularly the information under the headings "**NOTICE**", "**CAUTION**", and "**WARNING**".

If, after reading this manual, you have any questions regarding the operation of your vehicle, please contact the Hyundai Customer Care Center:

Hyundai Customer Care

P.O. Box 20850

Fountain Valley, CA 92728

800-633-5151

consumeraffairs@hmausa.com

Hyundai's Customer Care Center representatives are available Monday through Friday, between the hours of 6:00 AM and 5:00 PM PST

and Saturday between 6:30 AM and 3:00 PM PST (English).

For Customer Care assistance in Spanish or Korean, representatives are available Monday through Friday between 6:30 AM and 3:00 PM PST.

Open Source Software Notice

This vehicle contains software with open source licenses.

Open source software information including the source code, copyright notices and referred license terms may be obtained on the website.

<https://www.hyundai.com/worldwide/opensource>

HYUNDAI Motor Company will provide the open source code to you in storage medium such as CD-ROM for minimum charge covering the cost of performing source distribution upon email request to opensource@hyundai.com within a period of 3 years from the date of product purchase.

Index

A

Accessing your vehicle 5-6
 Immobilizer System 5-13
 Smart Key 5-6
Active air flap 6-51
 Malfunction 6-51
Advanced rear occupant alert (ROA) 5-41
 Advanced rear occupant alert operation 5-41
 Advanced rear occupant alert precautions 5-42
 Advanced rear occupant alert settings 5-41
 Declaration of conformity 5-43
Air cleaner 9-26
 Filter replacement 9-26
Air conditioner compressor label 10-10
Air conditioning system 10-5
Air ventilation seats 3-32
Appearance care 9-62
 Exterior care 9-62
 Interior care 9-67
Automatic climate control system 5-117
 Automatic heating and air conditioning 5-119
 Manual heating and air conditioning 5-120
 System maintenance 5-128
 System operation 5-127
Automatic transmission 6-11
 Automatic transmission operation 6-11
 Cluster display message 6-15
 Good driving practices 6-17
 Paddle shifter (manual shift mode) 6-16

B

Battery 9-30
 Battery capacity label 9-32
 Battery recharging 9-32
 For longer battery life 9-31
 Reset items 9-33
Before driving 6-4
 Before entering the vehicle 6-4
 Before starting 6-4
Before using driver assistance system 7-4
 Driver assistance system settings 7-5
Blind-Spot Collision-Avoidance Assist (BCA) 7-38
 Blind-Spot Collision-Avoidance Assist Malfunction and Limitations 7-43
 Blind-Spot Collision-Avoidance Assist Operation 7-40
 Blind-Spot Collision-Avoidance Assist settings 7-39
Blind-Spot View Monitor (BVM) 7-70
 Blind-Spot View Monitor Malfunction 7-71
 Blind-Spot View Monitor Operation 7-70
 Blind-Spot View Monitor settings 7-70

Brake fluid	9-24
Checking the brake fluid level	9-24
Braking system	6-18
Anti-lock Brake System (ABS)	6-24
Auto hold	6-22
Brake Assistant System (BAS)	6-32
Crosswind Stability Control (CSC)	6-29
Disc brakes wear indicator	6-19
Downhill Brake Control (DBC)	6-30
Electronic Parking Brake (EPB)	6-19
Electronic Stability Control (ESC)	6-26
Good braking practices	6-33
Hill-start Assist Control (HAC)	6-29
Power-assist brakes	6-18
Vehicle Stability Management (VSM)	6-28
Bulb wattage	10-3

C

Cabin air filter	9-27
Filter inspection	9-27
Filter replacement	9-27
California perchlorate notice	9-74
Center console overview	2-6
Child Restraint System (CRS)	3-44
Children Always in the Rear	3-44
Installing a Child Restraint System	3-46
Selecting a Child Restraint System	3-45
Climate control additional features	5-132
Air conditioning auto-drying	5-132
Auto defogging system	5-133
Auto dehumidify	5-134
Recirculating air when entering a tunnel	5-135
Recirculating air when washer fluid is used	5-135
Scheduled ventilation control	5-136
Cluster display	4-31
Cluster display control	4-31
View modes	4-31
Coasting	6-47
Consumer information	10-16
Convenience Features	5-1

D

Declaration of conformity	7-157
Front corner radar/Rear corner radar	7-157
Front radar	7-157
Dimensions	10-2
Door locks	5-33
Auto Door Lock/Unlock Features	5-36
Electronic child safety lock	5-37

Operating Door Locks from Outside the Vehicle	5-33
Operating Door Unlocks from Inside the Vehicle	5-35
Drive mode integrated control system	6-48
Drive mode features	6-49
TOW mode	6-50
Driver Assistance System	7-1
Driver assistance system sensors	7-153
Cameras	7-153
Radars	7-154
Ultrasonic sensors	7-155
Driver Attention Warning (DAW)	7-60
Driver Attention Warning Malfunction and Limitations	7-63
Driver Attention Warning Operation	7-61
Driver Attention Warning Settings	7-61
Driving your hybrid vehicle	1-9
Cluster display messages	1-22
Energy flow	1-13
Hybrid system gauge	1-18
Special features	1-11
Starting your vehicle	1-9
Stopping your vehicle	1-10
Warning and indicator lights	1-20
Driving Your Vehicle	6-1
Dual wide sunroof	5-79
Automatic reversal	5-82
Resetting the sunroof	5-83
Slide open/close (Front)	5-81
Sunroof open warning	5-83
Sunshade (Front)/Power sunshade (Rear)	5-80
Tilt open/close (Front)	5-81

E

Emergency Situations	8-1
Emergency Stop (ES)	7-87
Emergency Stop malfunction and limitations	7-88
Emergency Stop operation	7-87
Emission control system	9-70
Crankcase emission control system	9-70
Evaporative emission control system including onboard refueling vapor recovery (ORVR)	9-70
Exhaust emission control system	9-71
Engine	10-2
Engine compartment	9-4
Engine compartment overview	2-9
Engine coolant/Battery system coolant	9-21
Changing coolant	9-24
Checking the coolant level	9-21
Engine number	10-10
Engine oil	9-19
Checking the engine oil and filter	9-20
Checking the engine oil level	9-19

Engine Start/Stop button	6-5
Explanation of scheduled maintenance items	9-17
Air cleaner filter	9-17
Air conditioning refrigerant	9-19
Automatic Transmission fluid	9-18
Brake discs, pads, calipers, and rotors	9-19
Brake fluid	9-18
Brake hoses and lines	9-18
Cooling system	9-18
Drive shaft and related	9-19
Engine coolant/battery system coolant	9-18
Engine oil and filter	9-17
Exhaust pipe and muffler	9-19
Fuel filter	9-17
Fuel lines, fuel hoses and connections	9-17
HSG (Hybrid Starter & Generator) belts	9-17
Parking brake	9-18
Spark plugs	9-18
Steering gear box, linkage & boots/lower arm ball joint	9-19
Suspension mounting bolts	9-19
Vacuum crankcase ventilation hoses	9-17
Vapor hose and fuel filler cap	9-17
Exterior features	5-152
Hidden type assist handle	5-153
Roof side rails	5-152
Exterior lights	5-100
Battery saver function	5-103
Daytime Running Lights (DRL)	5-103
Headlight delay function	5-103
High beam operation	5-102
Interior button lights	5-111
Lighting control	5-100
Reverse guide light	5-104
Turn signals and lane change signals	5-102
Welcome system	5-104
Exterior overview (Front view)	2-2
Exterior overview (Rear view)	2-3

F

Fingerprint authentication system	5-28
Fingerprint authentication system operation	5-30
Fingerprint authentication system settings	5-28
Limitations of fingerprint authentication system	5-31
Remotely starting the vehicle	5-32
When purchasing a used vehicle	5-32
Forward Attention Warning (FAW)	7-66
Forward Attention Warning malfunction and limitations	7-68
Forward Attention Warning operation	7-67
Forward Attention Warning settings	7-66

Forward Collision-Avoidance Assist (FCA)	7-6
Forward Collision-Avoidance Assist Malfunction and Limitations	7-22
Forward Collision-Avoidance Assist Operation	7-11
Forward Collision-Avoidance Assist settings	7-9
Four wheel drive (4WD)	6-33
4 wheel drive (4WD) mode	6-34
Emergency precautions	6-38
Fuel filler door	5-94
Closing the fuel filler door	5-95
Opening the fuel filler door	5-94
Fuel requirements	9-72
Gasoline engine	9-72
Fuses	9-47
Engine compartment panel fuse replacement	9-48
Fuse panel description	9-50
Instrument panel fuse replacement	9-48

H

Hazard warning flasher	8-2
Head-up display (HUD)	5-96
Head-up display information	5-97
Head-up display settings	5-96
Precautions while using the head-up display	5-97
High Beam Assist (HBA)	5-106
High Beam Assist malfunction and limitations	5-108
High Beam Assist operation	5-107
High Beam Assist settings	5-106
Highway Driving Assist (HDA)	7-98
Highway Driving Assist Malfunction and Limitations	7-108
Highway Driving Assist Operation	7-100
Highway Driving Assist settings	7-99
Hood	5-84
Closing the hood	5-84
Opening the hood	5-84
Hybrid driving system	1-24
e-Handling (Electrically Assisted Handling Performance)/e-EHA (Electrically Evasive Handling Assist)	1-24
e-Ride (Electrically-controlled Ride Comfort)	1-25
Hybrid Electric Vehicle (HEV) system	1-7
Hybrid starter & Generator (HSG) belt	9-26
Checking the Hybrid Starter & Generator (HSG) belt	9-26
Hyundai Digital Key	5-14
Digital key (Card key)	5-22
Digital key (smartphone)	5-14
Limitations of the system	5-27
Used vehicle/Digital key maintenance	5-26
HYUNDAI Motor America	1-3
Hyundai vehicle owner privacy policy	10-12

If the engine overheats	8-7
If the engine will not start	8-3
If you have a flat tire (with Tire Mobility Kit)	8-13
Components of the Tire Mobility Kit	8-16
How to adjust tire pressure	8-20
Introduction	8-14
Notes on the safe use of the Tire Mobility	8-14
Using the Tire Mobility Kit when a tire is flat	8-17
Important safety precautions	3-3
Airbag Hazards	3-3
Always Wear Your Seat Belt	3-3
Control Your Speed	3-4
Driver Distraction	3-3
Keep Your Vehicle In Proper Operating Condition - Inspecting Your Tires	3-4
Never Drink or Take Drugs and Drive.	3-4
Reducing the Risk of a Rollover	3-4
Restrain All Children	3-3
In case of an emergency while driving	8-2
If the engine stalls at a crossroad or crossing	8-2
If the engine stalls while driving	8-2
If you have a flat tire while driving	8-3
Index	11-1
Infotainment system	5-154
Antenna	5-155
Bluetooth® wireless technology	5-157
Infotainment System	5-156
Steering wheel remote controls	5-156
USB port	5-154
Voice Recognition	5-157
Instrument Cluster	4-1
Instrument cluster	4-2
Cluster display messages	4-23
Gauges and meters	4-4
Instrument cluster control	4-3
Transmission shift indicator	4-8
Warning and indicator lights	4-9
Integrated memory system	5-45
Recalling memory positions	5-45
Resetting the integrated memory system	5-46
Seat easy access operation	5-46
Storing memory positions	5-45
While resetting integrated memory system	5-46
Intelligent Speed Limit Assist (ISLA)	7-54
Intelligent Speed Limit Assist Malfunction and Limitations	7-58
Intelligent Speed Limit Assist Operation	7-56
Intelligent Speed Limit Assist Settings	7-55

Interior features	5-140
AC Inverter	5-148
Cargo net holder	5-151
Cargo tray	5-151
Clock	5-149
Coat hook	5-149
Cup holder	5-140
Floor mat anchor(s)	5-150
Plastic bag hook	5-149
Power outlet	5-143
Rear side sunshade	5-150
Sunvisor	5-143
USB charger	5-144
UV-C sterilizer system	5-141
Wireless smartphone charging system	5-146
Interior lights	5-109
Cargo area lamp	5-112
Front lights	5-109
Glove box lamp	5-110
Interior lights auto off	5-109
Mood lighting	5-112
Rear personal lamps	5-110
Two-way multi console lamp	5-111
Vanity mirror lamp	5-110
Interior overview	2-4
Introduction	1-1, 1-2

J

Jump starting	8-4
----------------------------	-----

L

Lane Following Assist (LFA)	7-94
Lane Following Assist Malfunction and Limitations	7-98
Lane Following Assist Operation	7-95
Lane Following Assist Settings	7-94
Lane Keeping Assist (LKA)	7-32
Lane Keeping Assist Malfunction and Limitations	7-35
Lane Keeping Assist Operation	7-33
Lane Keeping Assist settings	7-32
Light bulbs	9-58
Headlight, parking light, turn signal light, daytime running light (DRL) replacement	9-59
High mounted stop light replacement	9-61
Interior light replacement	9-61
License plate light replacement	9-61
Rear combination light replacement	9-60
Side repeater light replacement	9-60

M

Maintenance	9-1
Maintenance services	9-5
Guide to hyundai genuine parts	9-5
Owner maintenance precautions	9-6
Owner's responsibility	9-6
Manual Speed Limit Assist (MSLA)	7-52
Manual Speed Limit Assist Operation	7-52
Mirrors	5-51
Inside rearview mirror	5-51
Reverse parking aid	5-70
Side view mirrors	5-67

N

Navigation-based Smart Cruise Control (NSCC)	7-89
Limitations of Navigation-based Smart Cruise Control	7-91
Navigation-based Smart Cruise Control Operation	7-90
Navigation-based Smart Cruise Control Settings	7-89

O

Open source software notice	10-17
Operation in Foreign Countries	10-11
Owner maintenance	9-7
Owner maintenance schedule	9-7

P

Parking Distance Warning (PDW)	7-127
Parking Distance Warning Malfunction and Limitations	7-131
Parking Distance Warning Operation	7-128
Parking Distance Warning settings	7-128
Picture Index	2-1
Power liftgate	5-85
Automatic reversal	5-88
Emergency liftgate safety release	5-90
Operating the power liftgate	5-87
Power liftgate operating conditions	5-85
Resetting the power liftgate	5-90
Setting the power liftgate	5-89

R

Rear Cross-Traffic Collision-Avoidance Assist (RCCA)	7-118
Rear Cross-Traffic Collision-Avoidance Assist Malfunction and Limitations	7-122
Rear Cross-Traffic Collision-Avoidance Assist Operation	7-119
Rear Cross-traffic Collision-Avoidance assist settings	7-118
Rear occupant alert (ROA)	5-40
Rear View Monitor (RVM)	7-110
Rear View Monitor Malfunction and Limitations	7-113
Rear View Monitor Operation	7-111

Rear View Monitor settings	7-110
Recommended lubricants and capacities	10-7
Recommended SAE viscosity number	10-8
Reference weight and distance when towing a trailer	10-6
Refrigerant label	10-10
Regenerative braking system (paddle shifter)	6-39
Regenerative braking system limitations	6-40
Using the regenerative braking system	6-39
Remote Smart Parking Assist (RSPA)	7-140
Remote Smart Parking Assist Malfunction and Limitations	7-147
Remote Smart Parking Assist Operation	7-142
Remote Smart Parking Assist Settings	7-141
Reporting safety defects	10-14
FCC statement	10-15
Reverse Parking Collision-Avoidance Assist (PCA)	7-134
Reverse Parking Collision-Avoidance Assist Malfunction and Limitations	7-136
Reverse Parking Collision-Avoidance Assist Operation	7-135
Reverse Parking Collision-Avoidance Assist settings	7-134

S

Safe Exit Assist (SEA)	7-47
Safe Exit Assist malfunction and limitations	7-50
Safe Exit Assist operation	7-48
Safe Exit Assist settings	7-48
Safety messages	1-4
Safety precautions for hybrid system	1-26
Countermeasures for accidents or fire	1-31
Hybrid vehicle components	1-26
When the hybrid vehicle shuts off	1-30
Scheduled maintenance services	9-10
Maintenance under severe usage and low mileage conditions	9-15
Normal maintenance schedule	9-12
Seat belts	3-33
Additional Seat Belt Safety Precautions	3-41
Care of Seat Belts	3-43
Pretensioner seat belt	3-39
Seat Belt Restraint System	3-35
Seat Belt Safety Precautions	3-33
Seat Belt Warning Light	3-34
Seat warmers	3-30
Seats	3-5
Front Seats	3-11
Head Restraints	3-26
Rear Seats	3-18
Safety Precautions	3-10
Seats & Safety System	3-1
Smart Cruise Control (SCC)	7-71
Smart Cruise Control Malfunction and Limitations	7-81
Smart Cruise Control Operation	7-73
Smart Cruise Control Settings	7-72

Smart liftgate	5-91
Deactivating smart liftgate	5-92
Detecting area	5-93
Using smart liftgate	5-91
Smart regeneration system	6-42
Front sensor	6-44
Pausing smart regeneration system	6-43
Precautions for smart regeneration system	6-44
Smart regeneration level settings	6-43
Smart regeneration system disabled	6-44
Smart regeneration system on/off	6-42
Smart regeneration system operating condition	6-42
Special driving conditions	6-52
Driving at night	6-53
Driving in flooded areas	6-53
Driving in the rain	6-53
Hazardous driving conditions	6-52
Highway driving	6-54
Rocking the vehicle	6-52
Smooth cornering	6-52
Steering wheel	5-47
Haptic warning/Steering wheel vibration warning	5-50
horn	5-49
Motor Driven Power Steering (MDPS)	5-47
Steering wheel grip sensor	5-50
Steering wheel heater	5-48
Tilt/telescopic steering	5-47
Steering wheel control overview	2-8
Storage compartment	5-137
Cargo tray	5-139
Front tray	5-138
Glove box	5-138
Passenger seat multi tray	5-138
Passenger seat open tray	5-138
Sliding tray	5-139
Two-way multi console	5-137
Sunroof	5-75
Automatic reversal	5-77
Resetting the sunroof	5-78
Slide open/close	5-76
Sunroof open warning	5-79
Sunshade	5-75
Tilt open/close	5-76
Supplemental restraint system - airbags	3-53
Additional Safety Precautions	3-75
Airbag Warning Labels	3-75
How does the Airbag System Operate?	3-59
Occupant Classification System (OCS)	3-63
SRS Care	3-74
SRS Components	3-55

SRS Warning Light 3-63
 What to Expect After an Airbag Inflates 3-62
 Where are the Airbags? 3-56
 Why didn't My Airbag Go Off In a Collision? 3-70
Surround View Monitor (SVM) 7-113
 Surround View Monitor Malfunction and Limitations 7-117
 Surround View Monitor Operation 7-115
 Surround View Monitor settings 7-114

T

Theft-alarm system 5-38
Tire Pressure Monitoring System (TPMS) 8-8
 Changing a tire with TPMS 8-12
 Check tire pressure 8-9
 Low tire pressure position and tire pressure telltale 8-11
 Low Tire Pressure Warning Light 8-10
 Tire pressure monitoring system 8-9
 TPMS Malfunction Indicator 8-12
Tire specification and pressure label 10-9
Tires and wheels 9-34, 10-4
 All season tires 9-45
 Check tire inflation pressure 9-35
 Low aspect ratio tires 9-46
 Radial-ply tires 9-45
 Recommended cold tire inflation pressures 9-35
 Snow tires 9-45
 Summer tires 9-45
 Tire Care 9-34
 Tire maintenance 9-38
 Tire replacement 9-37
 Tire rotation 9-36
 Tire sidewall labeling 9-38
 Tire terminology and definitions 9-42
 Tire traction 9-38
 Wheel alignment and tire balance 9-37
 Wheel replacement 9-38
Towing 8-21
 Towing service 8-21
Trailer towing 6-58
 Driving with a trailer 6-62
 If you decide to pull a trailer 6-59
 Maintenance when towing a trailer 6-64
 Trailer equipment and accessories 6-61

V

Vehicle auto-shut off	6-10
Deactivating conditions	6-10
Operating conditions	6-10
System operation	6-10
Vehicle Break-in Process	1-6
Vehicle certification label	10-9
Vehicle data collection and event data recorders	10-13
Vehicle handling instructions	1-5
Vehicle Identification Number (VIN)	10-9
Vehicle Information, Reporting Safety Defects, and Consumer Information	10-1
Vehicle load limit	6-65
The loading information label	6-65
Vehicle modifications	1-5
Vehicle settings (infotainment system)	4-35
Setting your vehicle	4-35
Vehicle system OTA update	5-98
Approving software update	5-98
Downloading software	5-98
Preparing software update	5-98
Updating software	5-99
Volume and weight	10-5

W

Washer fluid	9-25
Checking the washer fluid level	9-25
Windows	5-71
Power windows	5-72
Windshield defrosting and defogging	5-130
Automatic climate control system	5-130
Rear window defroster	5-131
Winter driving	6-54
Snow or icy conditions	6-54
Winter precautions	6-56
Wiper blades	9-28
Blade inspection	9-28
Blade replacement	9-29
Wipers and washers	5-113
Front windshield washers	5-115
Front windshield wipers	5-113
Rear window wipers and washers	5-116