

# OWNER'S MANUAL

Operation  
Maintenance  
Specifications

All information in this Owner's Manual is current at the time of publication. However, HYUNDAI reserves the right to make changes at any time so that our policy of continual product improvement may be carried out.

This manual applies to all HYUNDAI models and includes descriptions and explanations of optional as well as standard equipment. As a result, you may find material in this manual that does not apply to your specific vehicle.

## CAUTION: MODIFICATIONS TO YOUR HYUNDAI

Your HYUNDAI should not be modified in any way. Such modifications may adversely affect the performance, safety or durability of your HYUNDAI and may, in addition, violate conditions of the limited warranties covering the vehicle. Certain modifications may also be in violation of regulations established by the U.S. Department of Transportation and other federal or state agencies.

## TWO-WAY RADIO INSTALLATION

Your vehicle is equipped with a Tire Pressure Monitoring System, Passenger Occupant Classification System and other CAN bus systems. It is possible for an improperly installed/adjusted high powered two-way radio to adversely affect electronic systems. For this reason, we recommend that you carefully follow the radio manufacturer's instructions if you choose to install one of these devices.

## SAFETY AND VEHICLE DAMAGE WARNING

This manual includes information titled as DANGER, WARNING, CAUTION and NOTICE.

These titles indicate the following:



### DANGER

**DANGER** indicates a hazardous situation that, if not avoided, will result in death or serious injury.



### WARNING

**WARNING** indicates a hazardous situation that, if not avoided, could result in death or serious injury.



### CAUTION

**CAUTION** indicates a hazardous situation that, if not avoided, could result in minor or moderate injury.

### NOTICE

**NOTICE** indicates a situation that, if not avoided, could result in vehicle damage.

---

## HYUNDAI VEHICLE OWNER PRIVACY POLICY

Your Hyundai vehicle may be equipped with technologies and services that use information collected, generated, recorded or stored by the vehicle. Hyundai has created a Vehicle Owner Privacy Policy to explain how these technologies and services collect use and share this information.

You may read our Vehicle Owner Privacy Policy on the Hyundaiusa.com website at: <https://www.hyundaiusa.com/owner-privacy-policy.aspx>

If you would like to receive a hard copy of our Vehicle Owner Privacy Policy, please contact the Hyundai Customer Care Center at:

Hyundai Customer Care  
P.O. Box 20850  
Fountain Valley, CA 92728  
800-633-5151  
[consumeraffairs@hmausa.com](mailto:consumeraffairs@hmausa.com)

Hyundai's Customer Care Center representatives are available Monday through Friday, between the hours of 6:00 AM and 5:00 PM PST and Saturday between 6:30 AM and 3:00 PM PST (English).

For Customer Care assistance in Spanish or Korean, representatives are available Monday through Friday between 6:30 AM and 3:00 PM PST.

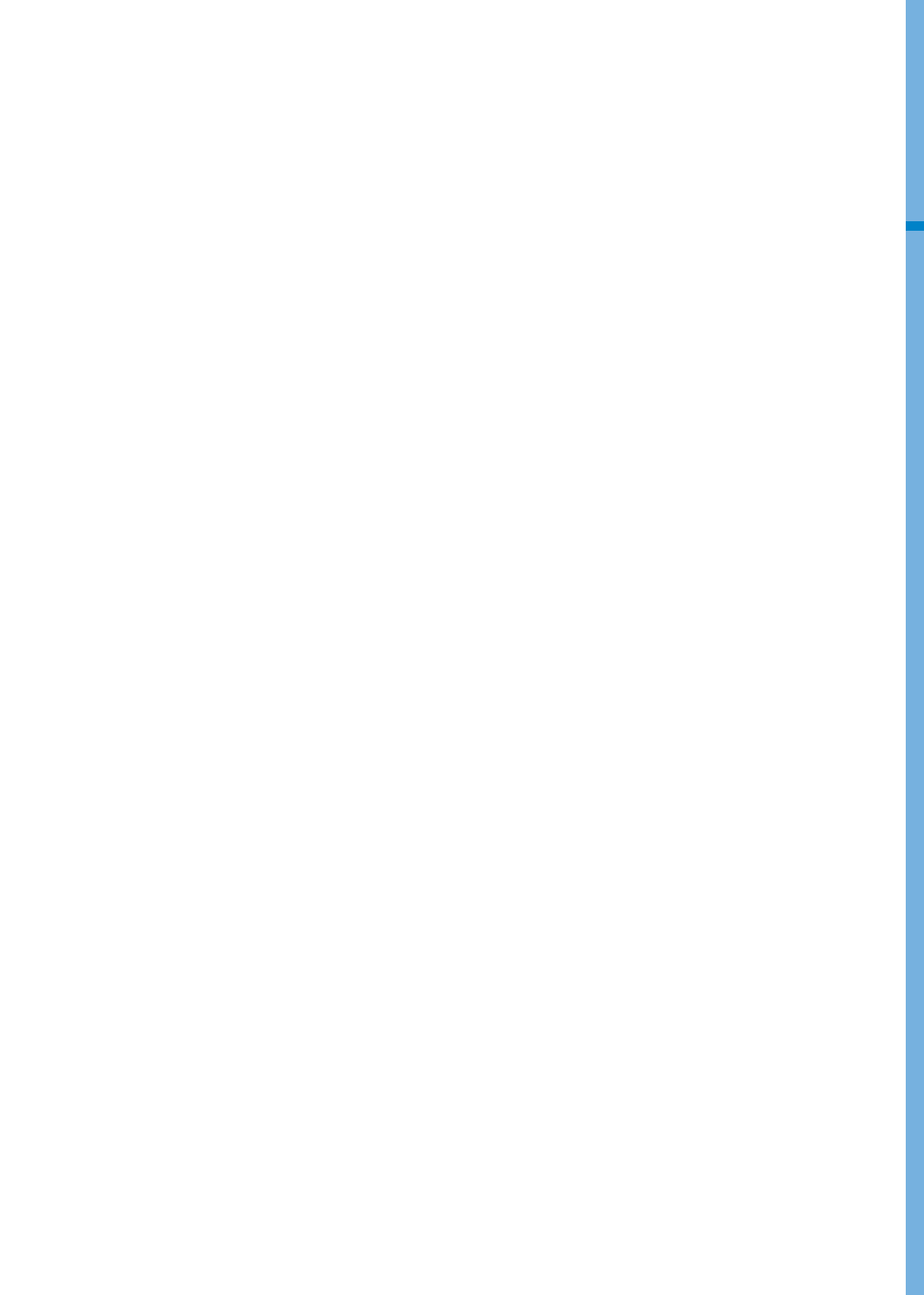

# Table of Contents

Foreword / Hybrid System Overview	1
Vehicle Information	2
Seats & Safety System	3
Instrument Cluster	4
Convenience Features	5
Driving Your Vehicle	6
Driver Assistance System	7
Emergency Situations	8
Maintenance	9
Index	I



# 1. Foreword / Hybrid System Overview

Introduction.....	1-2
HYUNDAI Motor America .....	1-2
Guide to Hyundai Genuine Parts .....	1-3
How to Use This Manual.....	1-4
Safety Messages .....	1-4
Fuel Requirements.....	1-5
Vehicle Modifications .....	1-7
Vehicle Break-in Process .....	1-7
Vehicle Data Collection and Event Data Recorders .....	1-8
HEV (Hybrid Electric Vehicle) System .....	1-9
Driving the Hybrid Vehicle .....	1-10
Starting the Vehicle.....	1-10
Special Features .....	1-10
Hybrid System Gauge .....	1-12
Warning and Indicator Lights .....	1-13
Cluster Display Messages.....	1-14
Energy Flow .....	1-17
Safety Precautions for Hybrid System.....	1-20
Hybrid Vehicle Components .....	1-20
High Voltage Cut-off Switch.....	1-22
Hybrid Battery Cooling Duct .....	1-23
Countermeasures for Accidents or Fire.....	1-24
When the Hybrid Vehicle Shuts Off .....	1-25

## INTRODUCTION

Congratulations, and thank you for choosing HYUNDAI. We are pleased to welcome you to the growing number of discerning people who drive HYUNDAs. We are very proud of the advanced engineering and high-quality construction of each HYUNDAI we build.

Your Owner's Manual will introduce you to the features and operation of your new HYUNDAI. To become familiar with your new HYUNDAI, so that you can fully enjoy it, read this Owner's Manual carefully before driving your new vehicle.

This manual contains important safety information and instructions intended to familiarize you with your vehicle's controls and safety features so you can safely operate your vehicle.

This manual also contains information on maintenance designed to enhance safe operation of the vehicle. It is recommended that all service and maintenance on your car be performed by an authorized HYUNDAI dealer. HYUNDAI dealers are prepared to provide high-quality service, maintenance and any other assistance that may be required.

This Owner's Manual should be considered a permanent part of your vehicle, and should be kept in the vehicle so you can refer to it at any time. The manual should stay with the vehicle if you sell it to provide the next owner with important operating, safety and maintenance information.

## HYUNDAI MOTOR AMERICA



### CAUTION

**Severe engine and transmission damage may result from the use of poor quality fuels and lubricants that do not meet HYUNDAI specifications. You must always use high quality fuels and lubricants that meet the specifications listed on Page 2-11 in the Vehicle Specifications section of the Owner's Manual.**

Copyright 2025 HYUNDAI Motor America. All rights reserved. No part of this publication may be reproduced, stored in any retrieval system or transmitted in any form or by any means without the prior written permission of HYUNDAI Motor America.

## GUIDE TO HYUNDAI GENUINE PARTS

### 1. What are HYUNDAI Genuine Parts?

HYUNDAI Genuine Parts are the same parts used by HYUNDAI Motor Company to manufacture vehicles. They are designed and tested for the optimum safety, performance, and reliability for our customers.



### 2. Why Hyundai Genuine Parts?

HYUNDAI Genuine Parts are engineered and built to meet rigid manufacturing requirements. Damage caused by using imitation, counterfeit or used salvage parts is not covered under the HYUNDAI New Vehicle Limited Warranty or any other HYUNDAI warranty.

In addition, any damage to or failure of HYUNDAI Genuine Parts caused by the installation or failure of an imitation, counterfeit or used salvage part is not covered by any HYUNDAI Warranty.



### 3. How can you tell if you are purchasing HYUNDAI Genuine Parts?

Look for the HYUNDAI Genuine Parts Logo on the package (see below).

HYUNDAI Genuine Parts exported to the U.S. are packaged with labels written only in English.

HYUNDAI Genuine Parts are only sold through authorized HYUNDAI Dealerships.

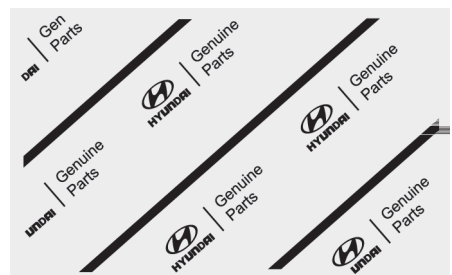

## HOW TO USE THIS MANUAL

We want to help you get the greatest possible driving pleasure from your vehicle. Your Owner's Manual can assist you in many ways. To gain an overview of the contents of your Owner's Manual, use the Table of Contents in the front of the manual. The first page of each Chapter includes a detailed Table of Contents of the topics in that Chapter.

To quickly locate information about your vehicle, use the Index in the back of the manual. It is an alphabetical list of what is in this manual and the page number where it can be found.

For your convenience, we have incorporated tabs on the right-hand page edges. These tabs are coded with the Chapter titles to assist you with navigating through the manual.

## SAFETY MESSAGES

Your safety, and the safety of others, is very important. This Owner's Manual provides you with many safety precautions and operating procedures. This information alerts you to potential hazards that may hurt you or others, as well as damage your vehicle.

Safety messages found on vehicle labels and in this manual describe these hazards and what to do to avoid or reduce the risks.

Warnings and instructions contained in this manual are for your safety. Failure to follow safety warnings and instructions can lead to serious injury or death.

Throughout this manual DANGER, WARNING, CAUTION, NOTICE and the SAFETY ALERT SYMBOL will be used.



This is the safety alert symbol. It is used to alert you to potential physical injury hazards. Obey all safety messages that follow this symbol to avoid possible injury or death. The safety alert symbol precedes the signal words DANGER, WARNING and CAUTION.



### **DANGER**

**DANGER** indicates a hazardous situation that, if not avoided, will result in death or serious injury.



### **WARNING**

**WARNING** indicates a hazardous situation that, if not avoided, could result in death or serious injury.



### **CAUTION**

**CAUTION** indicates a hazardous situation that, if not avoided, could result in minor or moderate injury.

### **NOTICE**

**NOTICE** indicates a situation that, if not avoided, could result in vehicle damage.

## **FUEL REQUIREMENTS**

Your new vehicle is designed to obtain maximum performance with UNLEADED FUEL, as well as minimize exhaust emissions and spark plug fouling.

Your new vehicle is designed to perform optimally using unleaded fuel having an octane number ((R+M)/2) of 87 (Research Octane Number 91) or higher. (Do not use methanol blended fuels)

### **NOTICE**

To prevent damage to the engine and engine components, never add any fuel system cleaning agents to the fuel tank other than what has been specified.

Consult an authorized HYUNDAI dealer for additional information.



### **WARNING**

- Do not “top off” after the nozzle automatically shuts off when refueling.
- Always check that the fuel cap is installed securely to prevent fuel spillage in the event of an accident.

### **Gasoline containing alcohol or methanol**

Gasohol, a mixture of gasoline and ethanol (also known as grain alcohol) are being marketed along with or instead of leaded or unleaded gasoline. For example, “E15” is a gasohol comprised of 15% ethanol and 85% gasoline.

Do not use gasohol containing more than 15% ethanol, and do not use gasoline or gasohol containing any methanol. Either of these fuels may cause drivability problems and damage to the fuel system, engine control system and emission control system.

Discontinue using gasohol of any kind if drivability problems occur.

“E85” fuel is an alternative fuel comprised of 85 percent ethanol and 15 percent gasoline, and is manufactured exclusively for use in Flexible Fuel Vehicles. “E85” is not compatible with your vehicle. Use of “E85” may result in poor engine performance and damage to your vehicle’s engine and fuel system. HYUNDAI recommends that customers do not use fuel with an ethanol content exceeding 15 percent.

#### **NOTICE**

**To prevent damage to your vehicle’s engine and fuel system:**

- **Never use gasohol which contains methanol.**
- **Never use gasohol containing more than 15% ethanol.**
- **Never use leaded fuel or leaded gasohol.**
- **Never use “E85” fuel.**

**Your New Vehicle Limited Warranty does not cover damage to the fuel system or any performance problems caused by the use of “E85” fuel.**

### **Using Fuel Additives (except Detergent Fuel Additives)**

Using fuel additives such as:

- Silicone fuel additive
- Ferrocene (iron-based) fuel additive
- Other metallic-based fuel additives

may result in cylinder misfire, poor acceleration, engine stalling, damage to the catalyst, or abnormal corrosion, and may cause damage to the engine resulting in a reduction in the overall life of the powertrain.

- The Malfunction Indicator Lamp (MIL) may illuminate.

#### **NOTICE**

**Damage to the fuel system or performance problem caused by the use of these fuels or fuel additives may not be covered by your New Vehicle Limited Warranty.**

### **Gasoline containing MMT**

Some gasoline contains harmful manganese-based fuel additives such as MMT (Methylcyclopentadienyl Manganese Tricarbonyl).

HYUNDAI does not recommend the use of gasoline containing MMT.

This type of fuel can reduce vehicle performance and affect your emission control system.

The malfunction indicator lamp on the cluster may come on.

### ***Detergent Fuel Additives***

HYUNDAI recommends that you use good quality gasolines treated with detergent additives such as TOP TIER Detergent Gasoline, which help prevent deposit formation in the engine. These gasolines will help the engine run cleaner and enhance performance of the Emission Control System. For more information on TOP TIER Detergent Gasoline, please go to the website ([www.toptiergas.com](http://www.toptiergas.com)).

For customers who do not use TOP Tier Detergent Gasoline regularly, and have problems starting or the engine does not run smoothly, detergent-based fuel additives that you can purchase separately may be added to the gasoline. If TOP TIER Detergent Gasoline is not available, one bottle of additive added to the fuel tank according to the maintenance schedule is recommended (refer to the Maintenance Schedule in chapter 9).

Additives are available from your authorized HYUNDAI dealer along with information on how to use them. Do not mix other additives.

### ***Operation in foreign countries***

If you are going to drive your vehicle in another country, be sure to:

- Observe all regulations regarding registration and insurance.
- Determine that acceptable fuel is available.

## **VEHICLE MODIFICATIONS**

- This vehicle should not be modified. Modification of your vehicle could affect its performance, safety or durability and may even violate governmental safety and emissions regulations.  
In addition, damage or performance problems resulting from any modification may not be covered under warranty.
- If you use unauthorized electronic devices, it may cause the vehicle to operate abnormally, wire damage, battery discharge and fire. For your safety, do not use unauthorized electronic devices.

## **VEHICLE BREAK-IN PROCESS**

By following a few simple precautions for the first 600 miles (1,000 km) you may add to the performance, economy and life of your vehicle.

- Do not race the engine.
- While driving, avoid sudden acceleration.
- Do not maintain a single speed for long periods of time, either fast or slow. Varying engine speed is needed to properly break-in the engine.
- Avoid hard stops, except in emergencies, to allow the brakes to seat properly.
- Don't tow a trailer during the first 1,200 miles (2,000 km) of operation.
- Fuel economy and engine performance may vary depending on vehicle break-in process and stabilize after driving about 4,000 miles (6,000 km). Engine may consume more oil during the vehicle break-in period.



## **WARNING**

### **CALIFORNIA PROPOSITION 65 WARNING**

Items contained in motor vehicles or emitted from them are known to the State of California to cause cancer and birth defects or reproductive harm.

These include:

- Gasoline and its vapors
- Engine exhaust
- Used engine oil
- Interior passenger compartment components and materials
- Component parts which are subject to heat and wear

In addition, battery posts, terminals and related accessories contain lead, lead compounds and other chemicals known to the State of California to cause cancer and reproductive harm.

For more information go to <https://www.p65warnings.ca.gov/passenger-vehicle>

## **VEHICLE DATA COLLECTION AND EVENT DATA RECORDERS**

This vehicle is equipped with an event data recorder (EDR). The main purpose of an EDR is to record, in certain crash or near crash-like situations, such as an air bag deployment or hitting a road obstacle, data that will assist in understanding how a vehicle's systems performed. The EDR is designed to record data related to vehicle dynamics and safety systems for a short period of time, typically 30 seconds or less. The EDR in this vehicle is designed to record such data as:

- How various systems in your vehicle were operating;
- Whether or not the driver and passenger safety belts were buckled/ fastened;
- How far (if at all) the driver was depressing the accelerator and/or brake pedal; and,
- How fast the vehicle was traveling.

These data can help provide a better understanding of the circumstances in which crashes and injuries occur. **NOTE:** EDR data is recorded by your vehicle only if a non-trivial crash situation occurs; no data are recorded by the EDR under normal driving conditions and no personal data (for example, name, gender, age, and crash location) are recorded. However, other parties, such as law enforcement, could combine the EDR data with the type of personally identifying data routinely acquired during a crash investigation.

To read data recorded by an EDR, special equipment is required, and access to the vehicle or the EDR is needed. In addition to the vehicle manufacturer, other parties, such as law enforcement, that have the special equipment, can read the information if they have access to the vehicle or the EDR.

## HEV (HYBRID ELECTRIC VEHICLE) SYSTEM

The HYUNDAI Hybrid Electric Vehicle (HEV) uses both the gasoline engine and the electric motor for power. The electric motor is run by a high-voltage HEV battery.

Depending on the driving conditions, the HEV computer selectively operates between the engine and the electric motor or even both at the same time.

Fuel efficiency increases when the engine is at idle, or when the vehicle is driven by the electric motor with the HEV battery.

The HEV battery charge must be maintained, so at times the engine will come on even at idle to act as a generator. Charging also occurs when decelerating or by regenerative braking.

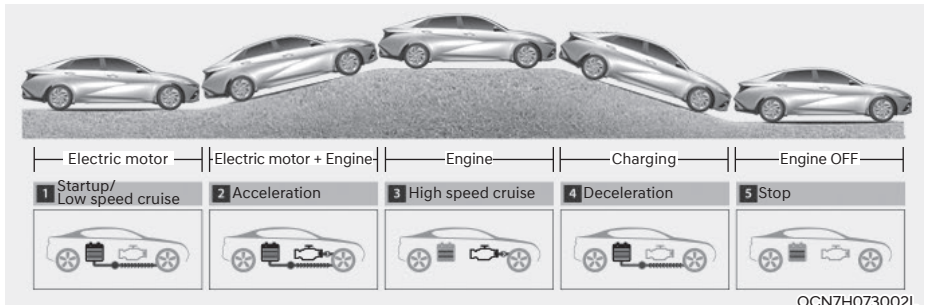

## DRIVING THE HYBRID VEHICLE

### Starting the Vehicle

#### **Vehicles with smart key system**

1. Carry the smart key or leave it inside the vehicle.
2. Make sure the parking brake is firmly applied.
3. Make sure the shift lever is in P (Park). With the shift lever in N (Neutral), you cannot start the vehicle.
4. Depress the brake pedal.
5. Turn on the vehicle. If the hybrid system starts, the “READY” indicator will come on.

Whether the engine is cold or warm, it should be started without depressing the accelerator.

**After following the start procedures, “READY” indicator on the instrument cluster will turn on. For more details, please check chapter 6.**

#### **ECONOMICAL and SAFE OPERATION of Hybrid system**

- Drive smoothly. Accelerate at a moderate rate and maintain a steady cruising speed. Do not make “jack-rabbit” starts. Do not race between stoplights.
- Avoid heavy traffic whenever possible. Always maintain a safe distance from other vehicles so you can avoid unnecessary braking. This also reduces brake wear.
- The regenerative brake generates energy when the vehicle decelerates.
- When the hybrid battery power is low, the hybrid system automatically recharges the hybrid battery.
- When the engine is running with the shift lever in N (Neutral), the hybrid system cannot generate electricity. The hybrid battery cannot recharge with the shift lever in N (Neutral).

### **i** Information

**In the hybrid system, the engine automatically runs and stops. When the hybrid system operates, the “READY” indicator is illuminated.**

**In the following situation, the engine may operate automatically.**

- **When the engine is ready to run**
- **When the hybrid battery is being charged**
- **Depending on the temperature condition of the hybrid battery**

### Special Features

Hybrid vehicles sound different than gasoline engine vehicles. When the hybrid system operates, you may hear a sound from the hybrid battery system behind the rear seat. If you apply the accelerator pedal rapidly, you may hear an unconventional sound. When you apply the brake pedal, you may hear a sound from the regenerative brake system. When the hybrid system is turned off or on, you may hear a sound in the engine compartment. If you depress the brake pedal repeatedly when the hybrid system is turned on, you may hear a sound in the engine compartment. None of these sounds indicate a problem. These are normal characteristics of hybrid vehicles.

If any of following occur, it’s a normal condition if you hear a motor sound in the engine compartment:

- After turning off the hybrid system, the brake pedal is released.
- When the hybrid system is turned off, the brake pedal is applied.
- When the driver door is opened.

When the hybrid system is turned ON, the gasoline engine may run or may not. In this situation, you may feel a vibration. This does not indicate a malfunction. When the “READY” indicator illuminates, the hybrid system is ready to begin driving. Even if the engine is off, you can operate the vehicle as long as the “READY” indicator is illuminated.

### NOTICE

The hybrid system contains many electronic components. High voltage components, such as cables and other parts, may emit electromagnetic waves. Even when the electromagnetic cover blocks electromagnetic emissions, electromagnetic waves may have an effect on electronic devices. When your vehicle is not used for a long period of time, the hybrid system will discharge. You need to drive the vehicle several times a month. Have driving at least for 1 hour or 10 miles (16 km). When the hybrid battery is discharged, or when it is impossible to jump start the vehicle, contact your authorized HYUNDAI dealer.



### WARNING

- When you start the hybrid system with the shift lever in P (Park), the “READY” indicator illuminates on the instrument cluster. The driver can drive the vehicle, even when the gasoline engine is off.
- When you leave the vehicle, you should turn OFF the hybrid system or locate the shift lever in P (Park). When you depress the accelerator pedal by mistake, or when the shift lever is not in P (Park), the vehicle will abruptly move, possibly resulting in serious injury or death.

### Virtual Engine Sound System (VESS)

The Virtual Engine Sound System generates engine sound for pedestrians to hear vehicle sound because there is limited sound while motor power is used.

- If the gear shifts out of P (Park) after start-up, the VESS sound is output.
- When the gear is shifted to R (Reverse), an additional warning sound will be heard.

### What does regenerative braking do?

It uses an electric motor when decelerating and when braking. It transforms kinetic energy to electrical energy in order to charge the high voltage battery.

### Battery

- The vehicle is composed of a high voltage battery that drives the motor and air conditioner, and an integrated 12 V lithium ion battery with the HEV battery that drives the lamps, wipers, and audio system.
- The integrated 12 V battery is automatically charged when the vehicle is in the ready (READY) mode.

### Hybrid System Gauge Power gauge

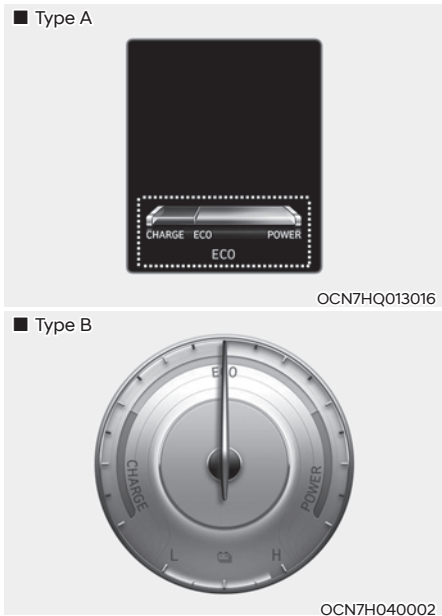

The hybrid system gauge indicates whether the current driving condition is fuel efficient or not.

- **CHARGE:**  
Shows that the energy made by the vehicle is being converted to electrical energy. (Regenerated energy)
- **ECO:**  
Shows that the vehicle is being driven in an Eco-friendly manner.
- **POWER:**  
Shows that the vehicle is exceeding the Eco-friendly range.

According to the hybrid system gauge area, the “EV” indicator comes on or off.

- “EV” indicator ON : Vehicle is driven using the electric motor or the gasoline engine is stopped.
- “EV” indicator OFF : Vehicle is driven using the gasoline engine.

### Hybrid battery SOC (State of Charge) gauge



This gauge indicates the remaining hybrid battery power. If the SOC is near the “L (Low)” level, the vehicle automatically operates the engine to charge the battery.

However, if the Service Indicator (⚠) and Malfunction Indicator Lamp (MIL) (⚠) turn on when the SOC gauge is near the “L (Low)” level, have the vehicle checked by an authorized HYUNDAI dealer.

## Warning and Indicator Lights

### Ready indicator

**READY**

#### This indicator illuminates:

When the vehicle is ready to be driven.

- ON : Normal driving is possible.
- OFF : Normal driving is not possible, or a problem has occurred.
- Blinking : Emergency driving.

When the ready indicator goes OFF or blinks, there is a problem with the system. If this occurs, have your vehicle inspected by an authorized HYUNDAI dealer.

### EV mode indicator

**EV**

#### This indicator illuminates:

When the vehicle is driven by the electric motor.

### Service warning light



#### This warning light illuminates:

- When you set the ignition switch to the ON position.
  - The service warning light illuminates for approximately 3 seconds and then turns off when all checks have been performed.
- When there is a problem with the hybrid vehicle control system or hardware.

When the warning light illuminates while driving, or does not go OFF after starting the vehicle, have the vehicle inspected by an authorized HYUNDAI dealer.

### Regenerative brake warning light



#### This warning light illuminates:

When the regenerative brake does not operate and the brake does not perform well. This causes the Brake Warning light (red) and Regenerative Brake Warning Light (yellow) to illuminate simultaneously.

If this occurs, drive safely and have your vehicle inspected by an authorized HYUNDAI dealer. The operation of the brake pedal may be more difficult than normal and the braking distance may increase.

### Cluster Display Messages

#### **Ready to start driving**



This message is displayed when the vehicle is ready to be driven.

#### **Check regenerative brakes**

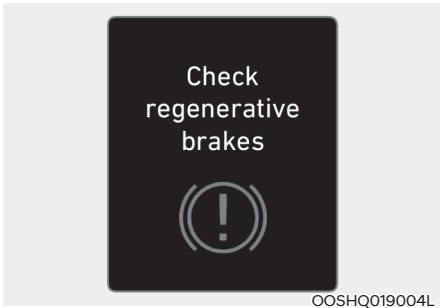

This message is displayed when the brake performance is low or the regenerative brake does not work properly due to a problem in the brake system.

If this occurs, it may take longer for the brake pedal to operate and the braking distance may become longer.

#### **Stop vehicle and check brakes**



This message is displayed when a problem occurs in the brake system. If this occurs, park the vehicle in a safe location and tow your vehicle to the nearest authorized HYUNDAI dealer and have the vehicle inspected.

#### **Check Hybrid system**

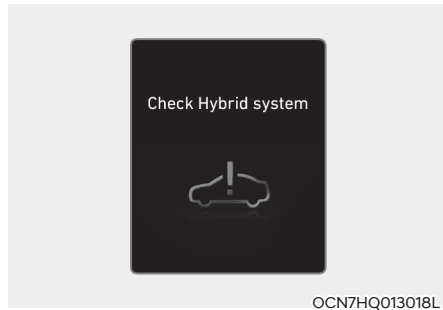

This message is displayed when there is a problem with the hybrid control system. Refrain from driving when the warning message is displayed.

If this occurs, have your vehicle inspected by an authorized HYUNDAI dealer.

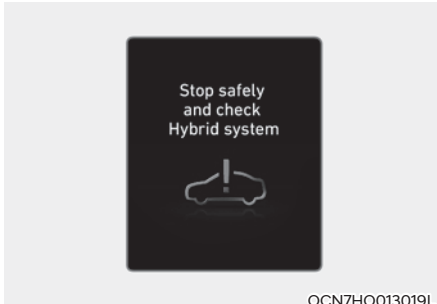
**Stop safely and check Hybrid system**

This message is displayed when there is a problem with the hybrid control system. The “” indicator will blink and a warning chime will sound until the problem is solved. Refrain from driving when the warning message is displayed. If this occurs, have your vehicle inspected by an authorized HYUNDAI dealer.

**Check Hybrid system. Do not start engine**

This message is displayed when the hybrid battery power (SOC) level is low. A warning chime will sound until the problem is solved. Refrain from driving when the warning message is displayed. If this occurs, have your vehicle inspected by an authorized HYUNDAI dealer.

**Stop safely and check power supply**

This message is displayed when a problem occurs in the power supply system.

If this occurs, park the vehicle in a safe location and tow your vehicle to the nearest authorized HYUNDAI dealer and have the vehicle inspected.

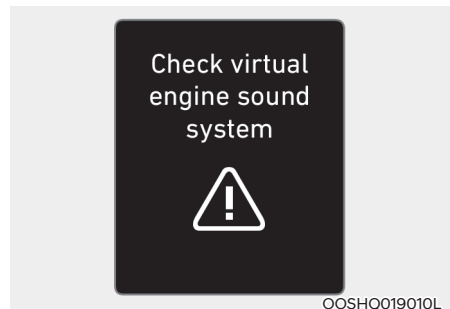
**Check virtual engine sound system**

This message is displayed when there is a problem with the Virtual Engine Sound System (VESS).

If this occurs, have your vehicle inspected by an authorized HYUNDAI dealer.

**Refill inverter coolant**

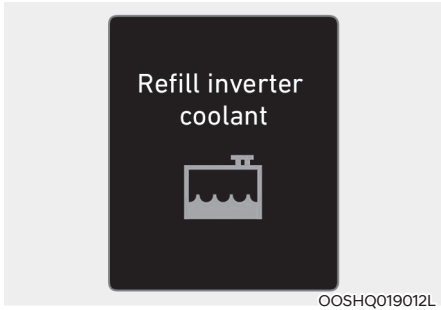

This message is displayed when the inverter coolant is nearly empty. You should refill the inverter coolant.

**Park with engine On to charge battery**



This message is displayed when the hybrid battery power (SOC) level is low. If this occurs, park the vehicle in a safe location and wait until the hybrid battery is charged.

**Start engine to avoid battery discharge**

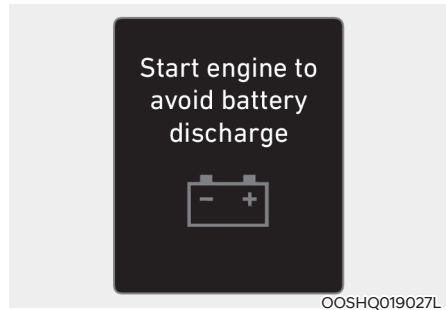

This message is displayed to inform the driver the 12 V battery may be discharged if the ignition switch is in ON position (without the **READY** indicator ON). Set the vehicle to the ready (**READY**) mode to prevent the 12 V battery from being discharged.

## Energy Flow

The hybrid system displays the energy flow in various operating modes. While driving, the current energy flow is specified in 11 modes.

### Vehicle stop

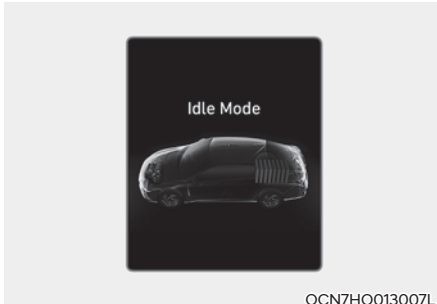

The vehicle is stopped.  
(No energy flow)

### EV propulsion

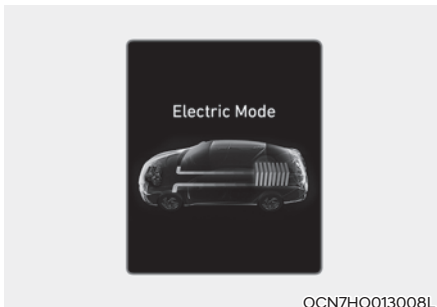

Only the motor power is used to drive the vehicle.  
(Battery → Wheel)

### Power assist



Both the motor and the engine power are used to drive the vehicle.  
(Battery & Engine → Wheel)

### Engine only propulsion

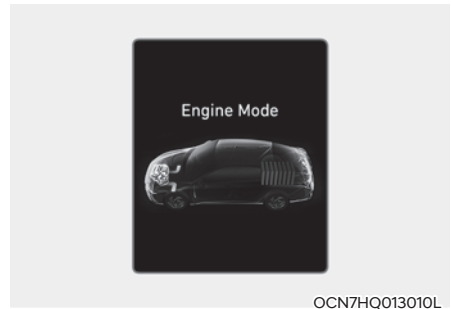

Only the engine power is used to drive the vehicle.  
(Engine → Wheel)

### Engine generation

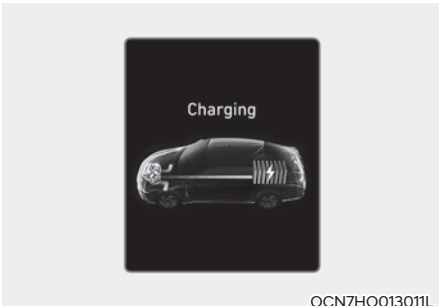

When the vehicle is stopped, the high-voltage battery is charged up by the engine.  
(Engine → Battery)

### Regeneration



The high-voltage battery is charged up by the regenerative brake system.  
(Wheel → Battery)

### Engine brake

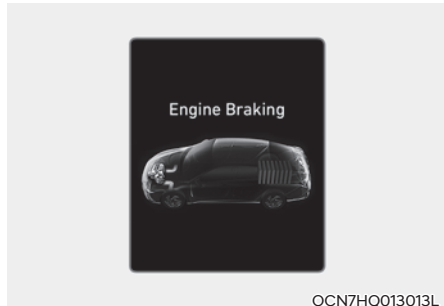

The engine braking is used to decelerate the vehicle.  
(Wheel → Engine)

### Power reserve

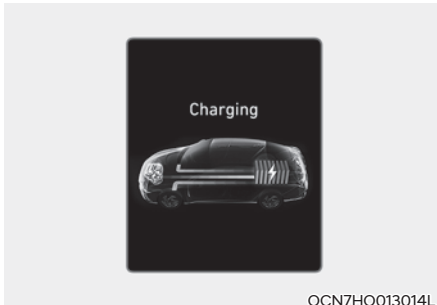

The engine is simultaneously used to drive the vehicle and to charge up the high-voltage battery.  
(Engine → Wheel & Battery)

**Engine generation/motor drive**

The engine charges up the high-voltage battery. The motor power is used to drive the vehicle.

(Engine → Battery → Wheel)

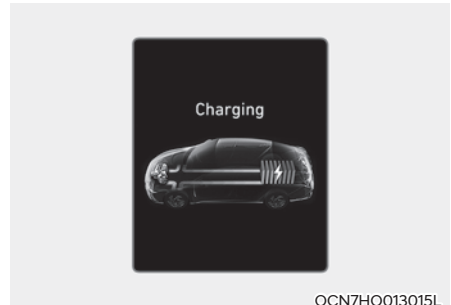
**Engine brake/regeneration**

The engine braking is simultaneously used to decelerate the vehicle and to charge up the high-voltage battery.

(Wheel → Engine & Battery)

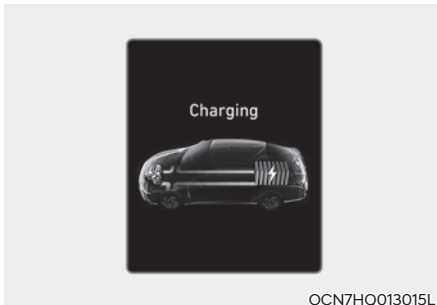
**Engine generation/regeneration**

The engine and regenerative brake system charges up the high-voltage battery.

(Engine & Wheel → Battery)

**Start engine to avoid battery discharge**

If the engine is not turned on with the ignition switch in ACC or ON for a while, the battery can be discharged. Please turn on the engine to prevent 12 V battery from discharge.

## SAFETY PRECAUTIONS FOR HYBRID SYSTEM

### Hybrid Vehicle Components

#### High voltage battery system

■ HPCU (Hybrid Power Control Unit) \*1

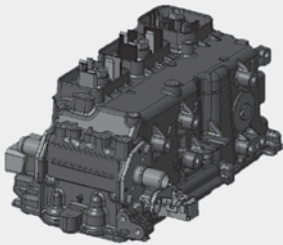

OCN7HQ013027

■ High voltage battery system \*2

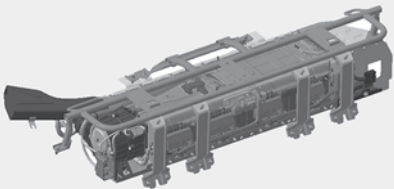

OAEQ046019

\*1: Located in the engine compartment

\*2: Located under the rear seats

#### WARNING

Never touch orange colored or high voltage labeled components, including wires, cables, and connections. When the insulators or covers are damaged or removed, severe injury or death from electrocution may occur.

#### WARNING

While replacing the fuses in the engine compartment, never touch the HPCU. The HPCU carries high voltage. Touching the HPCU may result in electrocution, serious injury, or death.

#### WARNING

In the hybrid system, the hybrid battery uses high voltage to operate the motor and other components. This high voltage hybrid battery system can be very dangerous.

Never touch the hybrid system. When you touch the hybrid battery system, serious injury or death may occur.

#### CAUTION

- Do not pile up any items in an area behind the high voltage battery. In a crash, the battery may become unstable, or its performance may degrade.
- Do not apply strong force nor pile up any items above the luggage compartment. Such an attempt may distort the high voltage battery case, causing a safety problem or degrading the performance.
- Be careful when loading flammable liquid in the luggage compartment. It could cause operational and safety degradation if the liquid leaks and flows in the high voltage battery.

■ Drive motor \*3

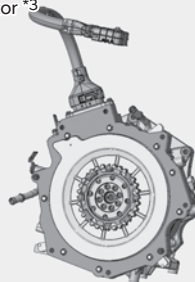

OCN7HQ010005

\*3: Located in the engine compartment

**WARNING**

- Do not disassemble the high voltage motor connector. The high voltage motor connector may contain residual high voltage. Coming in contact with high voltage may result in death or serious injury.
- Your vehicle's hybrid system should only be inspected or repaired by an authorized HYUNDAI dealer.

**WARNING**

- Do not disassemble or assemble the high voltage battery system. Doing so may result in electric shock, causing death or serious injury.
- If you disassemble or assemble hybrid system components improperly, it may damage the performance and reliability of your vehicle.
- If electrolyte comes in contact with your body, clothes or eyes, immediately flush with a large quantity of fresh tap water. Have your eyes examined by a doctor as soon as possible.

**WARNING**

Never assemble or disassemble the high voltage battery system.

- If you assemble or disassemble the high voltage battery system, the durability and performance of the vehicle may be damaged.
- When you want to check the high voltage battery system, have the vehicle inspected by an authorized HYUNDAI dealer.
- Do not touch the high voltage battery and high voltage cable connected to motor (orange color). Severe burns and electric shock may occur. For your safety, do not touch the cover of electronic components and electronic cable. Do not remove the cover of electronic components and electronic cable. In particular, never touch the high voltage battery system when the hybrid system is in operation. It may result in death or serious injury.

**WARNING**

- Never use the package modules (high voltage battery, inverter and converter) for any other purpose.
- Do not use an unauthorized battery charger to charge the high voltage battery. Doing so may result in death or serious injury.
- Never locate the high voltage system near or in a fire.
- Never drill into or strike the package module. Otherwise, it may be damaged. An electric shock may occur, resulting in serious injury or death.

### NOTICE

- When the vehicle is paint baked, do not bake over 30 minutes in 158°F (70°C) or 20 minutes in 176°F (80°C) degree.
- Do not wash the engine compartment, using water. Water may cause an electric shock and damage the electronic components.



### WARNING

This hybrid vehicle uses the hybrid battery system inverter and converter to generate high voltage. High voltage in the hybrid battery system is very dangerous and may cause severe burns and electric shock. This may result in serious injury or death.

- For your safety, never touch, replace, disassemble or remove the hybrid battery system including components, cables and connectors. Severe burns or electric shock may result in serious injury or death when you fail to follow this warning.
- When the hybrid battery system operates, the hybrid battery system can be hot. Always be careful because burns or electric shock may be caused by high voltage.
- Do not spill liquid on the HPCU, HSG, motor and fuses. If the hybrid system components come in contact with liquid, it may result in electric shock.

### High Voltage Cut-off Switch

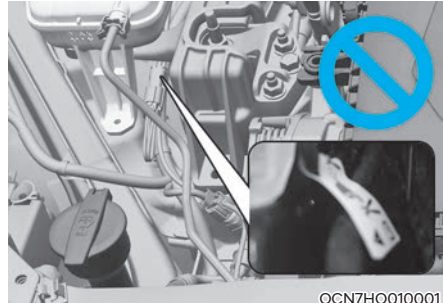

High voltage cut-off switch is a device located inside the engine compartment to block the battery's high voltage when your vehicle is inspected at an authorized HYUNDAI dealer.



### WARNING

- Never touch the high voltage cut-off switch. This could result in serious injury or death in a collision or electric shock.
- If the high voltage cut-off switch requires an inspection or repair, contact an authorized an authorized HYUNDAI dealer.
- Never disconnect or cut the high voltage cut-off switch except in an emergency situation. Serious problems may occur, such as the vehicle may not start.

## Hybrid Battery Cooling Duct

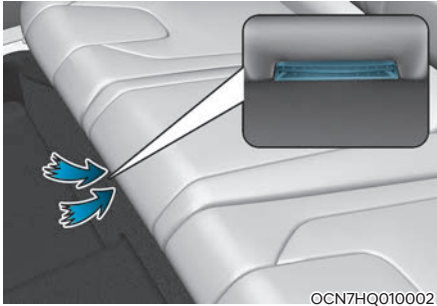

The hybrid battery cooling duct is located on the middle side of the rear seats. The cooling duct cools down the hybrid battery. When the hybrid battery cooling duct is blocked, the hybrid battery may be overheated.

Clean the cooling duct for the hybrid battery with a dry cloth on a regular basis.



### WARNING

- **Never clean the cooling duct of the hybrid battery with a wet cloth. If any water enters the cooling duct of the hybrid battery, the hybrid battery may cause an electric shock, resulting in a serious damage, an injury or death.**
- **The hybrid battery is composed of lithium-ion. If the hybrid battery is improperly handled, it is dangerous to the environment. Also it may cause electrical shock and severe burns, resulting in a serious injury or death.**
- **Do not spill liquid over the cooling duct of the hybrid battery. Doing so is very dangerous. It may cause electric shock or serious injury.**
- **Do not cover the cooling duct with objects.**
- **Do not put any objects into the cooling duct of the hybrid battery. Doing so may cause loss of cooling duct volume to the hybrid battery. When the cooling duct is blocked with any objects, immediately contact your HYUNDAI dealer.**
- **Never place a container of liquid on or near the cooling duct. If the liquid spills, the hybrid battery located in the luggage compartment may be damaged.**
- **Secure all loads in the luggage compartment to prevent them from being tossed about before driving. When a sharp or heavy load strike with a strong impact or pierce the interior luggage compartment wall, the hybrid battery system may be damaged, deteriorating its performance.**
- **Do not obstruct the cooling duct with any other objects.**

## Countermeasures for Accidents or Fire

When an accident occurs while driving the hybrid vehicle, turn on the hazard warning flasher, move the vehicle to a safe place, and do not let other people approach the site.



### WARNING

When an accident occurs, and the high voltage battery is damaged, harmful gas and electrolytes may leak.

- Be careful not to touch the leaked liquid.
- When you suspect leakage of inflammable gas and other harmful gases, open the windows and immediately evacuate to a safe location.
- If any leaked fluid comes in contact with your eyes or skin, immediately clean the affected area thoroughly with tap water or saline solution and have doctors inspect it as soon as possible.

### *If the hybrid vehicle catches fire*

If a fire occurs, evacuate to a safe place and do not let other people approach the site.

- Contact the fire department, report a hybrid vehicle fire, and then follow its instructions.



### CAUTION

- If a fire occurs, evacuate to a safe place and wait until the firefighters arrive.
- If the lower part of the vehicle where the high voltage battery is located catches fire, large amount of water must be supplied continuously for a long time to completely extinguish the fire. It is hard to extinguish the fire without sufficient water and appropriate fire extinguishers. If you approach the vehicle carelessly, it may cause accidents, such as electric shock, and result in serious injury.

### *If the hybrid vehicle is submerged*

If the hybrid vehicle is submerged while driving, follow the instructions below:

- Immediately turn off the vehicle and evacuate to a safe place with your key.
- Contact the emergency rescue service such as a fire department, or an authorized HYUNDAI dealer.



### WARNING

**Never touch the submerged hybrid vehicle. This may lead to an accident such as an electric shock or fire.**

## When the Hybrid Vehicle Shuts Off

When the high voltage battery or 12 volt battery is discharged, or when the fuel tank is empty, the hybrid system may not operate while driving. When the Hybrid system does not operate, do the following:

1. Gradually reduce the vehicle speed. Pull over your vehicle off the road in a safe area.
2. Make sure the shift lever is in P (Park).
3. Turn ON the hazard warning flashers.
4. Turn OFF the vehicle, and try to start the hybrid system again, while depressing the brake pedal and turning on the ignition switch.
5. When the hybrid system still does not operate, refer to “If the 12 V Battery Is Discharged” section in chapter 8.

Before jump-starting the vehicle, check the fuel level and the exact procedure to jump start. For further details, refer to “If the 12 V Battery Is Discharged” section in chapter 8. When the fuel level is low, do not attempt to drive the vehicle only with the battery power. The high voltage battery may be discharged, and the hybrid system will turn OFF.



# 2. Vehicle Information

Exterior Overview (Front View) .....	2-2
Exterior Overview (Rear View) .....	2-3
Interior Overview .....	2-4
Instrument Panel Overview .....	2-5
Steering Wheel Control Overview .....	2-6
Engine Compartment .....	2-7
Dimensions .....	2-8
Engine Specification .....	2-8
Bulb Wattage .....	2-9
Tires and Wheels .....	2-10
Volume and Weight .....	2-11
Air Conditioning System .....	2-11
Recommended Lubricants and Capacities .....	2-12
Recommended SAE Viscosity Number .....	2-13
Vehicle Identification Number (VIN) .....	2-14
Vehicle Certification Label .....	2-14
Tire Specification and Pressure Label .....	2-15
Engine Number .....	2-15
Open Source Software Notice (For Plug-in Hybrid Vehicle) .....	2-15
Consumer Information .....	2-16
Reporting Safety Defects .....	2-17

## EXTERIOR OVERVIEW (FRONT VIEW)



- |                           |           |  |      |
|---------------------------|-----------|--|------|
| 1. Hood .....             | 5-59      | 5. Sunroof .....                       | 5-55 |
| 2. Headlight.....         | 9-55      | 6. Front windshield wiper blades ..... | 9-30 |
| 3. Tires and wheels ..... | 2-10/9-32 | 7. Windows .....                       | 5-50 |
| 4. Side view mirror.....  | 5-48      | 8. Front radar .....                   | 7-15 |

## EXTERIOR OVERVIEW (REAR VIEW)

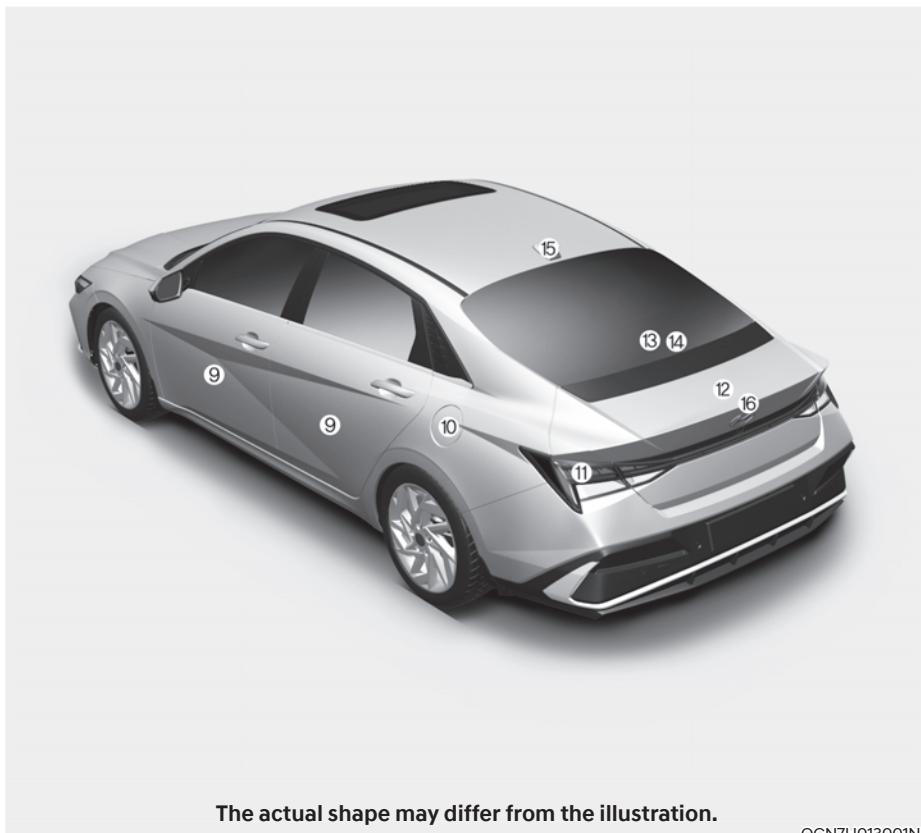

The actual shape may differ from the illustration.

OCN7H013001N

- |                                |      |                                     |            |
|--------------------------------|------|-------------------------------------|------------|
| 9. Door.....                   | 5-27 | 13. Defroster / Glass antenna ..... | 5-97/5-107 |
| 10. Fuel filler door.....      | 5-66 | 14. High mounted stop lamp .....    | 9-60       |
| 11. Rear combination lamp..... | 9-57 | 15. Antenna.....                    | 5-107      |
| 12. Trunk.....                 | 5-61 | 16. Rear view camera.....           | 7-104      |

## INTERIOR OVERVIEW

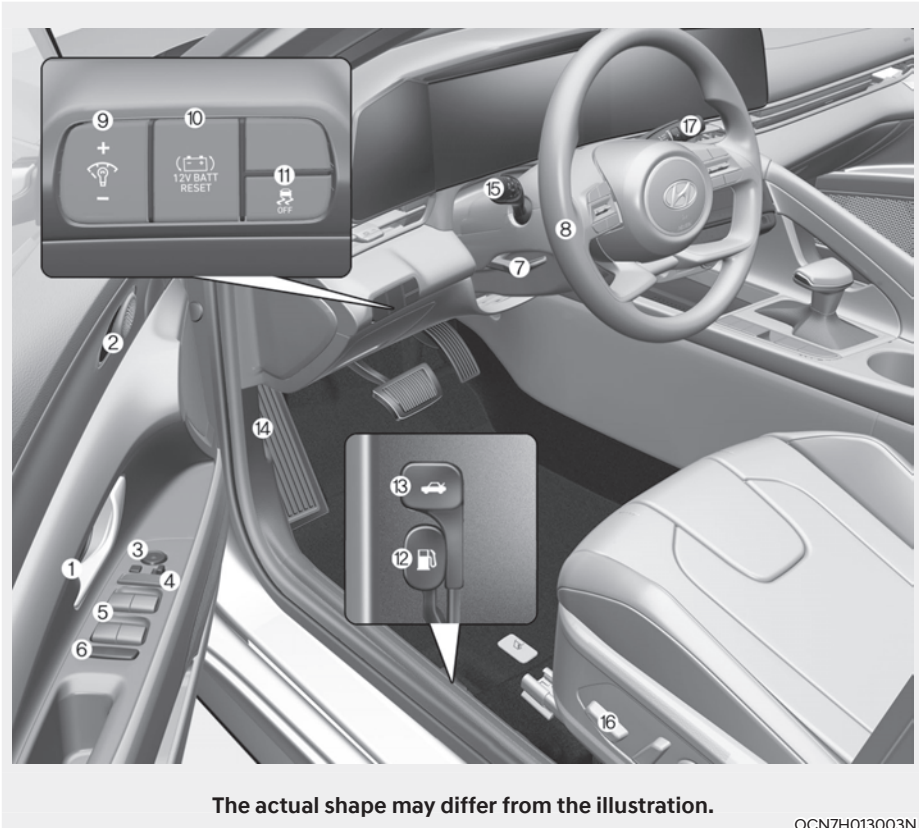

The actual shape may differ from the illustration.

OCN7H013003N

- |  |      |   |      |
|--|------|---|------|
| 1. Inside door handle.....                               | 5-29 | 10. 12 V battery reset button.....      | 8-4  |
| 2. Seat position memory system .....                     | 5-34 | 11. ESC OFF button .....                | 6-32 |
| 3. Side view mirror control switch.....                  | 5-49 | 12. Fuel filler door release lever..... | 5-66 |
| 4. Central door lock switch .....                        | 5-29 | 13. Trunk release lever.....            | 5-61 |
| 5. Power window switches .....                           | 5-50 | 14. Hood release lever.....             | 5-59 |
| 6. Power window lock button.....                         | 5-53 | 15. Light control/ Turn signals .....   | 5-69 |
| 7. Steering wheel tilt/telescopic lever ....             | 5-38 | 16. Seat adjusting switch .....         | 3-3  |
| 8. Steering wheel.....                                   | 5-37 | 17. Wiper/Washer switch.....            | 5-80 |
| 9. Instrument panel illumination control<br>switch ..... | 4-5  |   |      |

## INSTRUMENT PANEL OVERVIEW



- |  |       |   |       |
|--|-------|---|-------|
| 1. Instrument cluster .....            | 4-4   | 8. Passenger's front air bag .....        | 3-38  |
| 2. Driver's front air bag.....         | 3-38  | 9. Glove box .....                        | 5-99  |
| 3. Engine Start/Stop button.....       | 6-8   | 10. Dual clutch transmission .....        | 6-13  |
| 4. Key ignition switch .....           | 6-6   | 11. Drive mode button .....               | 6-37  |
| 5. Infotainment system .....           | 5-109 | 12. Parking/View button .....             | 7-107 |
| 6. Hazard warning flasher switch ..... | 8-2   | 13. Electronic parking brake switch ..... | 6-23  |
| 7. Climate control system .....        | 5-82  | 14. AUTO HOLD button .....                | 6-27  |

## STEERING WHEEL CONTROL OVERVIEW

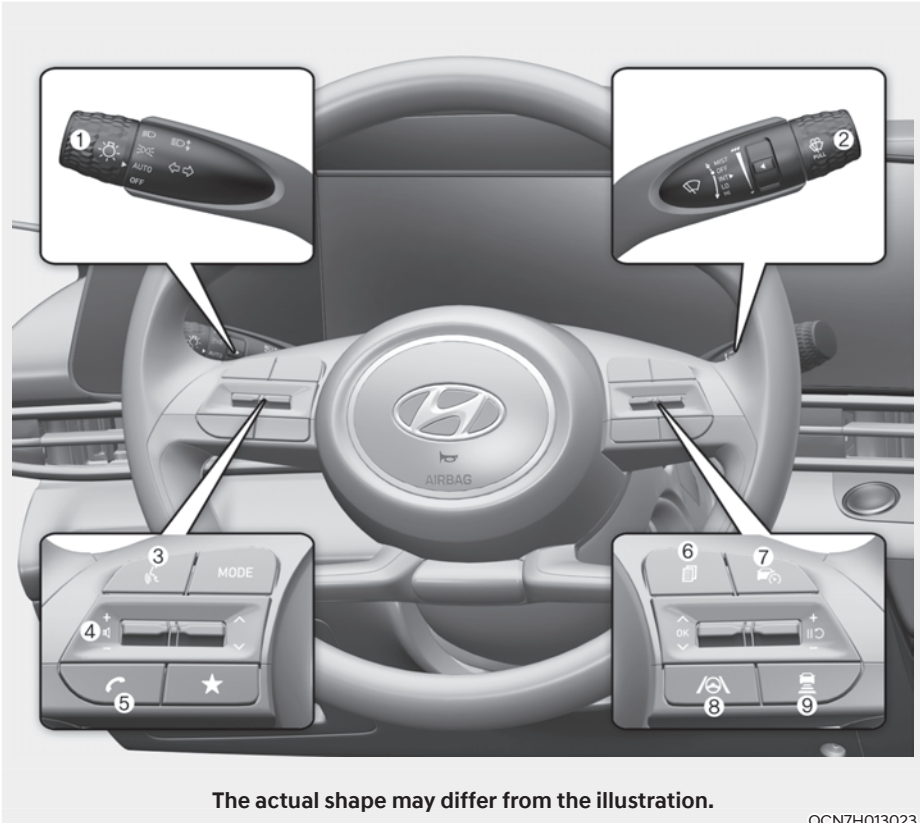

- |  |       |                                    |      |
|--|-------|------------------------------------|------|
| 1. Lighting control lever .....                            | 5-69  | 6. Cluster display control .....   | 4-26 |
| 2. Wiper and washer control lever.....                     | 5-80  | 7. Driving Assist button .....     | 7-53 |
| 3. Voice recognition button .....                          | 5-109 | 8. Lane Driving Assist button..... | 7-94 |
| 4. Steering wheel audio controls.....                      | 5-108 | 9. Vehicle Distance button.....    | 7-74 |
| 5. Bluetooth wireless technology hands-free<br>button..... | 5-109 |                                    |      |

## ENGINE COMPARTMENT

■ Gasoline 1.6 GDi HEV

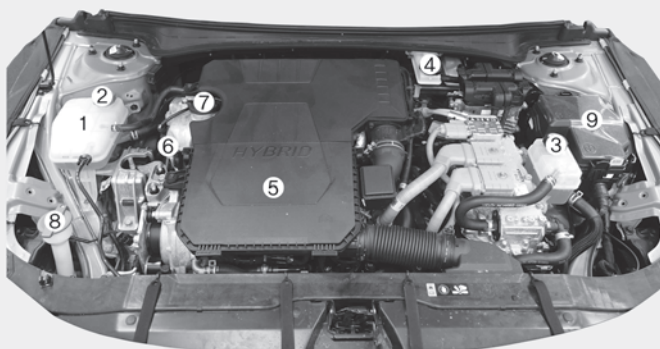

The actual engine room in the vehicle may differ from the illustration.

OCN7H093001

- |                                       |      |  |      |
|---------------------------------------|------|--|------|
| 1. Engine coolant reservoir .....     | 9-19 | 6. Engine oil dipstick .....               | 9-16 |
| 2. Engine coolant reservoir cap ..... | 9-20 | 7. Engine oil filler cap .....             | 9-16 |
| 3. Inverter coolant reservoir .....   | 9-19 | 8. Windshield washer fluid reservoir ..... | 9-26 |
| 4. Brake fluid reservoir .....        | 9-24 | 9. Fuse box .....                          | 9-46 |
| 5. Air cleaner .....                  | 9-26 |  |      |

## DIMENSIONS

Items		in. (mm)
Overall length		183.1 (4,650)
Overall width		72 (1,825)
Overall height		56.0 (1,420)
Front tread	205/55 R16	62.4 (1,585)
	225/45 R17	62.2 (1,579)
Rear tread	205/55 R16	62.9 (1,599)
	225/45 R17	62.7 (1,593)
Wheelbase		107 (2,720)

## ENGINE SPECIFICATION

Item	Gasoline 1.6 GDi HEV
Displacement cu. in. (cc)	96.42 (1,580)
Bore x Stroke in. (mm)	2.83 X 3.82 (72.0 X 97.0)
Firing order	1-3-4-2
No. of cylinders	4, in-line

## BULB WATTAGE

Light bulb		Bulb type	Wattage		
Front	Type A	Headlight (High/Low)	LED	LED	
		Daytime running light (DRL)/Position light	LED	LED	
		Turn signal light	PY21W	21W	
	Type B	Headlight (High/Low)	LED	LED	
		Daytime running light (DRL)/Position light/ Turn signal light	LED	LED	
	Side marker		Bulb type	W5W	5W
			LED type	LED	LED
Turn signal light		PY21W	21W		
Side repeater light (Outside mirror)		LED	LED		
Rear	Type A	Stop light	P21W	21W	
		Tail light	W5W	5W	
	Type B	Stop light	P28	8W	
		Tail light	LED	LED	
	Type C	Stop light/Tail light	LED	LED	
	Side marker		Bulb type	W5W	5W
			LED type	LED	LED
	Turn signal light		PY21W	21W	
	License plate light		W5W	5W	
	Reverse light		W16W	16W	
High mounted stop light		P21W	16W		
Interior	Map lamp		W10W	10W	
	Room lamp		FESTOON	8W	
	Vanity mirror lamp		FESTOON	5W	
	Trunk room lamp		FESTOON	5W	
	Mood lamp		LED	LED	

## TIRES AND WHEELS

Item	Tire Size	Wheel Size	Inflation pressure psi (kPa)		Wheel lug nut torque kgf·m (lbf·ft, N·m)
			Front	Rear	
Full size tire	205/55 R16	6.5Jx16	33 (230)	33 (230)	11-13 (79-94, 107-127)
	225/45 R17	7.0Jx17	33 (230)	32 (220)	

### NOTICE

- It is permissible to add 3 psi to the standard tire pressure specification if colder temperatures are expected soon.  
Tires typically lose 1psi (7kPa) for every 12°F temperature drop. If extreme temperature variations are expected, recheck your tire pressure as necessary to keep them properly inflated.
- Tire inflation pressures will vary with changes in elevation. If driving in areas of higher or lower elevation, be sure to check and adjust for proper tire inflation.

### CAUTION

- When replacing tires, use the same size originally supplied with the vehicle. Using tires of a different size can damage the related parts or not work properly.
- When replacing tires, ALWAYS use the same size, type, construction and tread pattern supplied with the vehicle for all tires.

## VOLUME AND WEIGHT

Items		Gasoline 1.6 GDi HEV
Gross vehicle weight	lbs. (kg)	4,079 (1,850)
Luggage volume	cu ft (ℓ)	16.7 (474)

## AIR CONDITIONING SYSTEM

Item	Weight of Volume	Classification
Refrigerant oz. (g)	17.6 ± 0.9 (600 ± 25)	R-1234yf
Compressor lubricant oz. (g)	3.4 ± 0.3 (130 ± 10)	PAG (FD46XG)

Contact an authorized HYUNDAI dealer for more details.

## RECOMMENDED LUBRICANTS AND CAPACITIES

To help achieve proper engine and powertrain performance and durability, use only lubricants of the proper quality. The correct lubricants also help promote engine efficiency that results in improved fuel economy.

These lubricants and fluids are recommended for use in your vehicle.

Lubricant	Volume	Classification
Engine oil *1 (drain and refill) 	4.02 US qt. (3.8 ℓ)	OW-20 API SN PLUS
Dual clutch transmission fluid	1.7~1.8 US qt. (1.6~1.7 ℓ)	API GL-4, SAE 70W, HK D DCTF TGO-10 PLUS (SK), SPIRAX S6 GHDE 70W DCTF PLUS (H.K.SHELL)
Engine coolant	6.23 US qt. (5.9 ℓ)	Mixture of antifreeze and water (Phosphate-based Ethylene glycol coolant for aluminum radiator)
Inverter coolant	2.22 US qt. (2.1 ℓ)	
Brake/clutch fluid	As required	DOT-4 *2
Engine clutch actuator fluid	As required	SAE J1704 DOT-4LV, FMVSS 116 DOT-4, ISO4926 CLASS-6
Fuel	11.09 US gal (42 ℓ)	Refer to “Fuel requirements” in the Foreword chapter.

\*1: Refer to the recommended SAE viscosity numbers on the next page.

\*2: To maintain the best braking performance and ABS/ESC performance, use genuine brake fluid that conform to specifications. (Standard : SAE J1704 DOT-4 LV, ISO4925 CLASS-6 and FMVSS 116 DOT-4)

## Recommended SAE Viscosity Number

### NOTICE

- **Always be sure to clean the area around any filler plug, drain plug, or dipstick before checking or draining any lubricant. This is especially important in dusty or sandy areas and when the vehicle is used on unpaved roads. Cleaning the plug and dipstick areas will prevent dirt and grit from entering the engine and other mechanisms that could be damaged.**
- **Never add any additives to the engine oil. Engine oil additives can change the properties of engine oil and may cause serious engine failure.**

Engine oil viscosity (thickness) has an effect on fuel economy and cold weather operating (engine start and engine oil flowability). Lower viscosity engine oils can provide better fuel economy and cold weather performance, however, higher viscosity engine oils are required for satisfactory lubrication in hot weather.

Using oils of any viscosity other than those recommended could result in engine damage.

When choosing an oil, consider the range of temperature your vehicle will be operated in before the next oil change. Proceed to select the recommended oil viscosity from the chart.

Temperature Range for SAE Viscosity Numbers										
Temperature	°C	-30	-20	-10	0	10	20	30	40	50
	(°F)	-10	0	20	40	60	80	100	120	
Engine Oil *1	Gasoline 1.6 GDi HEV	0W-20								

\*1: Requires <API Latest(ILSAC Latest) or ACEA C5, Full synthetic> grade engine oil. If a lower grade engine oil(mineral oil including Semi-synthetic) is used, then the engine oil and oil filter must be replaced as indicated severe maintenance condition.



An engine oil displaying this American Petroleum Institute(API) Certification Mark conforms to the International Lubricant Specification Advisory Committee (ILSAC). It is recommended to only use engine oils that uphold this API Certification Mark.

## VEHICLE IDENTIFICATION NUMBER (VIN)

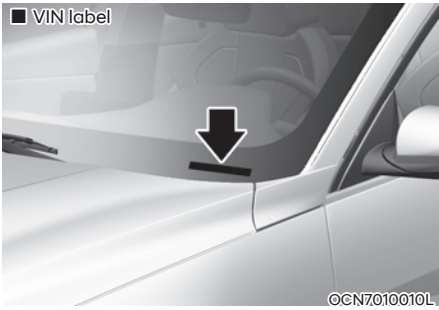

The VIN is also on a plate attached to the top of the dashboard. The number on the plate can easily be seen through the windshield from outside.

## VEHICLE CERTIFICATION LABEL

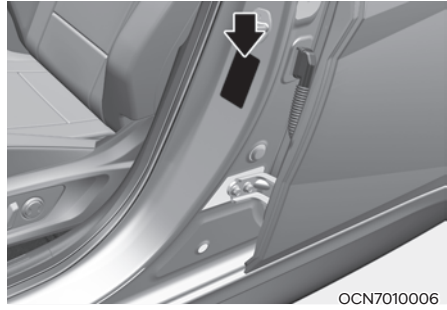

The vehicle certification label attached on the driver's side center pillar gives the Vehicle Identification Number (VIN).

## TIRE SPECIFICATION AND PRESSURE LABEL

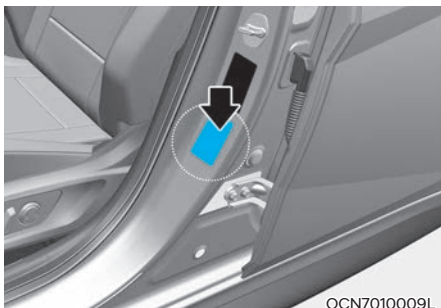

The tires supplied on your new vehicle are chosen to provide the best performance for normal driving.

The tire label located on the driver's side center pillar gives the tire pressures recommended for your vehicle.

## ENGINE NUMBER

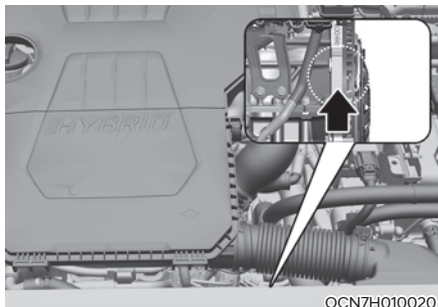

The engine number is stamped on the engine block as shown in the drawing.

## OPEN SOURCE SOFTWARE NOTICE (FOR PLUG-IN HYBRID VEHICLE)

This vehicle contains software with open source licenses.

Open source software information including the source code, copyright notices and referred license terms may be obtained on the website

<https://www.hyundai.com/worldwide/opensource>

Hyundai Motor Company will provide the open source code to you in storage medium such as CD-ROM for minimum charge covering the cost of performing source distribution upon email request to [opensource@hyundai.com](mailto:opensource@hyundai.com) within a period of 3 years from the date of product purchase.

## CONSUMER INFORMATION

This consumer information has been prepared in accordance with regulations issued by the National Highway Traffic Safety Administration of the U.S. Department of Transportation. Your HYUNDAI dealer will help answer any questions you may have as you read this information.

HYUNDAI motor vehicles are designed and manufactured to meet or exceed all applicable safety standards.

For your safety, however, we strongly urge you to read and follow all directions in this Owner's Manual, particularly the information under the headings "**NOTICE**", "**CAUTION**" and "**WARNING**".

If, after reading this manual, you have any questions regarding the operation of your vehicle, please contact the Hyundai Customer Care Center.

Hyundai Customer Care  
P.O. Box 20850  
Fountain Valley, CA 92728  
800-633-5151  
consumeraffairs@hmausa.com

Hyundai's Customer Care Center representatives are available Monday through Friday, between the hours of 6:00 AM and 5:00 PM PST and Saturday between 6:30 AM and 3:00 PM PST (English).

For Customer Care Center assistance in Spanish or Korean, representatives are available Monday through Friday between 6:30 AM and 3:00 PM PST.

## REPORTING SAFETY DEFECTS

If you believe that your vehicle has a defect which could cause a crash or could cause injury or death, you should immediately inform the National Highway Traffic Safety Administration (NHTSA) in addition to notifying HYUNDAI MOTOR AMERICA.

To contact NHTSA, you may call the Vehicle Safety Hotline toll-free at 1-888-327-4236 (TTY: 1-800-424-9153);

go to <http://www.safercar.gov>;

download the SaferCar mobile application;

or write to: Administrator, NHTSA

1200 New Jersey Ave, SE,

West Building Washington, D.C. 20590.

You can also obtain other information about motor vehicle safety from <http://www.safercar.gov>.

If NHTSA receives similar complaints, it may open an investigation, and if it finds that a safety defect exists in a group of vehicles, it may order a recall and remedy campaign. However, NHTSA cannot become involved in individual problems between you, your dealer, or HYUNDAI MOTOR AMERICA.



# 3. Seats & Safety System

This chapter provides you with important information about how to protect yourself and your passengers. It explains how to properly use your seats and seat belts, and how your airbags work. Additionally, this chapter explains how to properly restrain infants and children in your vehicle.

- Important Safety Precautions ..... 3-2
  - Always Wear Your Seat Belt ..... 3-2
  - Restrain All Children ..... 3-2
  - Airbag Hazards ..... 3-2
  - Driver Distraction ..... 3-2
  - Control Your Speed ..... 3-2
  - Keep Your Vehicle in Safe Condition ..... 3-2
- Seats ..... 3-3
  - Safety Precautions ..... 3-4
  - Front Seats ..... 3-5
  - Rear Seats ..... 3-10
  - Head Restraints ..... 3-11
  - Seat Warmers ..... 3-15
  - Air Ventilation Seat ..... 3-17
- Seat Belts ..... 3-18
  - Seat Belt Safety Precautions ..... 3-18
  - Seat Belt Warning Light ..... 3-19
  - Seat Belt Restraint System ..... 3-19
  - Additional Seat Belt Safety Precautions ..... 3-24
  - Care of Seat Belts ..... 3-26
- Child Restraint System (CRS) ..... 3-27
  - Children Always in the Rear ..... 3-27
  - Selecting a Child Restraint System (CRS) ..... 3-28
  - Installing a Child Restraint System (CRS) ..... 3-29
- Airbag - Advanced Supplemental Restraint System ..... 3-36
  - Where are the Airbags? ..... 3-38
  - How Does the Airbag System Operate? ..... 3-41
  - What to Expect After an Airbag Inflates ..... 3-44
  - Occupant Classification System (OCS) ..... 3-45
  - Why Didn't My Airbag Go Off in a Collision? ..... 3-51
  - SRS Care ..... 3-55
  - Additional Safety Precautions ..... 3-56
  - Airbag Warning Labels ..... 3-56

### IMPORTANT SAFETY PRECAUTIONS

You will find many safety precautions and recommendations throughout this section, and throughout this manual. The safety precautions in this section are among the most important.

#### Always Wear Your Seat Belt

A seat belt is your best protection in all types of accidents. Airbags are designed to supplement seat belts, not replace them. So even though your vehicle is equipped with airbags, ALWAYS make sure you and your passengers wear your seat belts, and wear them properly.

#### Restrain All Children

All children under age 13 should ride in your vehicle properly restrained in a rear seat, not the front seat. Infants and small children should be restrained in an appropriate child restraint. Larger children should use a booster seat with the lap/shoulder belt until they can use the seat belt properly without a booster seat.

#### Airbag Hazards

While airbags can save lives, they can also cause serious or fatal injuries to occupants who sit too close to them, or who are not properly restrained. Infants, young children, and shorter adults are at the greatest risk of being injured by an inflating airbag. Follow all instructions and warnings in this manual.

#### Driver Distraction

Driver distraction presents a serious and potentially deadly danger, especially for inexperienced drivers. Safety should be the first concern when behind the wheel, and drivers need to be aware of the wide array of potential distractions, such as drowsiness, reaching for objects, eating, personal grooming, other passengers, and using cellular phones.

Drivers can become distracted when they take their eyes and attention off the road or their hands off the wheel to focus on activities other than driving. To reduce your risk of distraction or getting into an accident:

- ALWAYS set up your mobile devices (for example, MP3 players, phones, navigation units, etc.) when your vehicle is parked or safely stopped.
- ONLY use your mobile device when allowed by laws and when conditions permit safe use. NEVER text or email while driving. Most states have laws prohibiting drivers from texting. Some states and cities also prohibit drivers from using handheld phones.
- NEVER let the use of a mobile device distract you from driving. You have a responsibility to your passengers and others on the road to always drive safely, with your hands on the wheel as well as your eyes and attention on the road.

#### Control Your Speed

Excessive speed is a major factor in crash injuries and deaths. Generally, the higher the speed, the greater the risk, but serious injuries can also occur at lower speeds. Never drive faster than is safe for current conditions, regardless of the maximum speed posted.

#### Keep Your Vehicle in Safe Condition

Having a tire blowout or a mechanical failure can be extremely hazardous. To reduce the possibility of such problems, check your tire pressures and condition frequently, and perform all regularly scheduled maintenance.

## SEATS

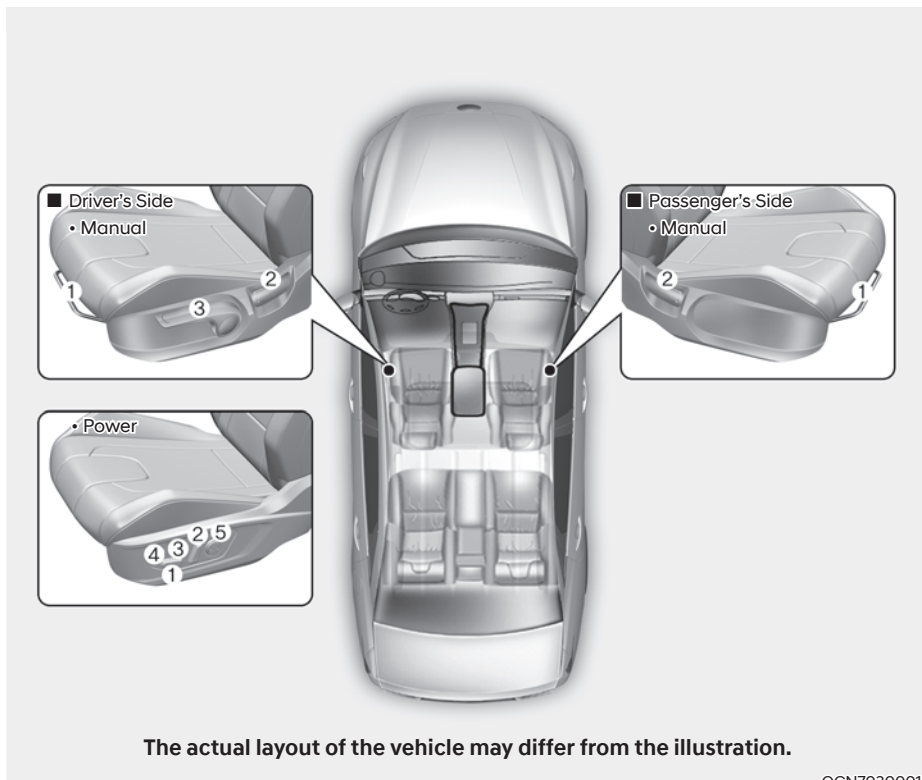

OCN7030001

**Driver's seat**

- (1) Forward and rearward
- (2) Seatback angle
- (3) Seat cushion height
- (4) Seat cushion angle
- (5) Lumbar support

**Front passenger's seat**

- (1) Forward and rearward
- (2) Seatback angle

### Safety Precautions

Adjusting the seats so that you are sitting in a safe, comfortable position plays an important role in driver and passenger safety together with the seat belts and airbags in an accident.



#### WARNING

**Do not use a cushion that reduces friction between the seat and the passenger. The passenger's hips may slide under the lap portion of the seat belt during an accident or a sudden stop. Serious or fatal internal injuries could result because the seat belt cannot operate properly.**

### Airbags

You can take steps to reduce the risk of being injured by an inflating airbag. Sitting too close to an airbag greatly increases the risk of injury in the event the airbag inflates.

The National Highway Traffic Safety Administration (NHTSA) recommends that drivers allow at least 10 inches (25 cm) between the center of the steering wheel and their chest.



#### WARNING

**To reduce the risk of serious injury or death from an inflating airbag, take the following precautions:**

- **Adjust the driver's seat as far to the rear as possible while maintaining the ability to maintain full control of the vehicle.**
- **Adjust the front passenger seat as far to the rear as possible.**
- **Hold the steering wheel by the rim with your hands at the 9 o'clock and 3 o'clock positions to minimize the risk of injuries to your hands and arms.**

- **NEVER place anything or anyone between the steering wheel and the airbag.**
- **Do not allow the front passenger to place feet or legs on the dashboard to minimize the risk of leg injuries.**

### Seat belts

Always fasten your seat belt before starting any trip.

At all times, passengers should sit upright and be properly restrained. Infants and small children must be restrained in appropriate child restraint systems. Adults and children who have outgrown a booster seat must be restrained using the seat belts.



#### WARNING

**Take the following precautions when adjusting your seat belt:**

- **NEVER use one seat belt for more than one occupant.**
- **Always position the seatback upright with the lap portion of the seat belt snug and low across the hips.**
- **NEVER allow children or small infants to ride on a passenger's lap.**
- **Do not route the seat belt across your neck, across sharp edges, or reroute the shoulder strap away from your body.**
- **Do not allow the seat belt to become caught or jammed.**

## Front Seats



### WARNING

Take the following precautions when adjusting your seat:

- **NEVER** attempt to adjust the seat while the vehicle is moving. The seat could respond with unexpected movement and may cause loss of vehicle control resulting in an accident.
- Do not place anything under the front seats. Loose objects in the driver's foot area could interfere with the operation of the foot pedals, causing an accident.
- Do not allow anything to interfere with the normal position and proper locking of the seatback.
- Do not place a cigarette lighter on the floor or seat. When you operate the seat, gas may exit out of the lighter causing a fire.
- Use extreme caution when picking up small objects trapped under the seats or between the seat and the center console. Your hands might be cut or injured by the sharp edges of the seat mechanism.
- If there are occupants in the rear seats, be careful while adjusting the front seat position.
- Make sure that the seat is locked in place after the adjustment. If not, the seat might move unexpectedly resulting in an accident.



### CAUTION

To prevent injury:

- Do not adjust your seat while wearing your seat belt. Moving the seat cushion forward may cause strong pressure on your abdomen.
- Do not allow your hands or fingers to get caught in the seat mechanisms while the seat is moving.

### Manual adjustment (if equipped)

The front seat can be adjusted by using the levers located on the outside of the seat cushion. Before driving, adjust the seat to the proper position so that you can easily control the steering wheel, foot pedals and controls on the instrument panel.

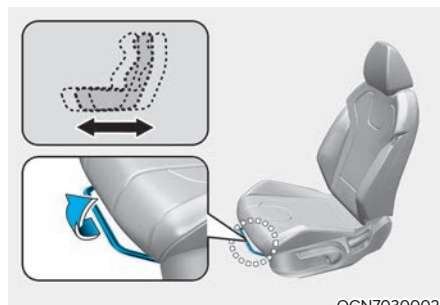

OCN7030002

### Forward and rearward adjustment

To move the seat forward or rearward:

1. Pull up the seat slide adjustment lever and hold it.
2. Slide the seat to the position you desire.
3. Release the lever and make sure the seat is locked in place. Move forward and rearward without using the lever. If the seat moves, it is not locked properly.

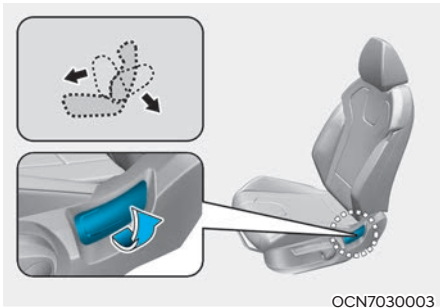

### Seatback angle

To recline the seatback:

1. Lean forward slightly and lift up the seatback lever.
2. Carefully lean back on the seat and adjust the seatback to the position you desire.
3. Release the lever and make sure the seatback is locked in place. (The lever MUST return to its original position for the seatback to lock.)

### Reclining seatback

Sitting in a reclined position when the vehicle is in motion can be dangerous. Even when buckled up, the protection of your restraint system (seat belts and airbags) is greatly reduced by reclining your seatback.

### WARNING

**NEVER** ride with a reclined seatback when the vehicle is moving.

**Riding with a reclined seatback increases your chance of serious or fatal injuries in the event of a collision or sudden stop.**

**Drivers and passengers should ALWAYS sit well back in their seats, properly belted, and with the seatbacks upright.**

Seat belts must be snug against your hips and chest to work properly. When the seatback is reclined, the shoulder belt cannot do its job because it will not be snug against your chest. Instead, it will be in front of you. During an accident, you could be thrown into the seat belt, causing neck or other injuries.

The more the seatback is reclined, the greater chance the passenger's hips will slide under the lap belt or the passenger's neck will strike the shoulder belt.

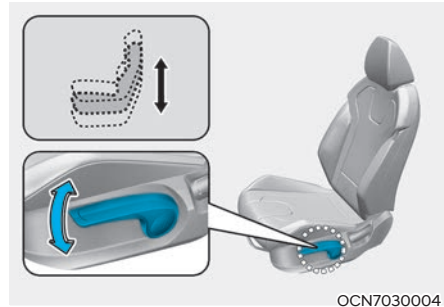

### Seat cushion height (for driver's seat, if equipped)

To change the height of the seat cushion:

- Push down on the lever several times, to lower the seat cushion.
- Pull up on the lever several times, to raise the seat cushion.

### Power adjustment (if equipped)

The front seat can be adjusted by using the control switches located on the outside of the seat cushion. Before driving, adjust the seat to the proper position so that you can easily control the steering wheel, foot pedals and controls on the instrument panel.



### WARNING

**NEVER** allow children in the vehicle unattended. The power seats are operable when the vehicle is turned off.

### NOTICE

To prevent damage to the seats:

- Always stop adjusting the seats when the seat has moved as far forward or rearward as possible.
- Do not adjust the seats for longer than necessary when the vehicle is turned off. This may result in unnecessary battery drain.
- Do not operate two or more seats at the same time. This may result in an electrical malfunction.

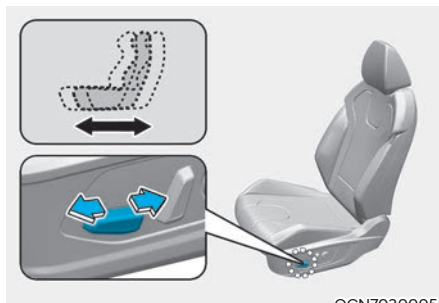

OCN7030005

### Forward and rearward adjustment

To move the seat forward or rearward:

1. Push the control switch forward or rearward.
2. Release the switch once the seat reaches the desired position.

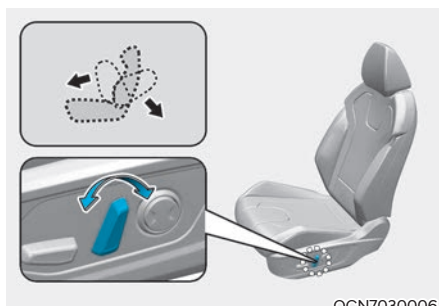

OCN7030006

### Seatback angle

To adjust the seatback:

1. Rotate the top of control switch forward or rearward.
2. Release the switch once the seatback reaches the desired position.

### Reclining seatback

Sitting in a reclined position when the vehicle is in motion can be dangerous. Even when buckled up, the protection of your restraint system (seat belts and airbags) is greatly reduced by reclining your seatback.



### WARNING

**NEVER ride with a reclined seatback when the vehicle is moving. Riding with a reclined seatback increases your chance of serious or fatal injuries in the event of a collision or sudden stop. Driver and passengers should always sit well back in their seats with the seatbacks upright and should be belted properly.**

Seat belts must be snug against your hips and chest to work properly. When the seatback is reclined, the shoulder belt cannot do its job because it will not be snug against your chest. Instead, it will be in front of you. During an accident, you could be thrown into the seat belt, causing neck or other injuries. The more the seatback is reclined, the greater chance the passenger's hips will slide under the lap belt or the passenger's neck will strike the shoulder belt.

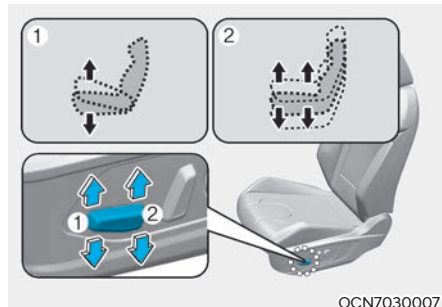

### Seat cushion tilt (1) (if equipped)

To change the angle of the front part of the seat cushion: Push the front portion of the control switch up to raise or down to lower the front part of the seat cushion. Release the switch once the seat reaches the desired position.

### Seat cushion height (2) (if equipped)

To change the height of the seat cushion: Push the rear portion of the control switch up to raise or down to lower the height of the seat cushion. Release the switch once the seat reaches the desired position.

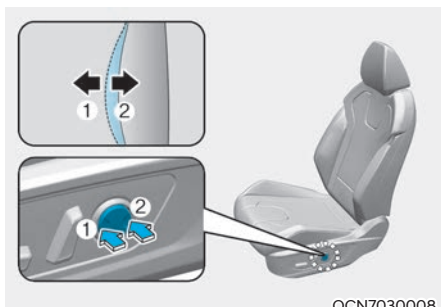

OCN7030008

### Lumbar support (for driver's seat, if equipped)

The lumbar support can be adjusted by pressing the lumbar support switch. Press the front portion of the switch (1) to increase support or the rear portion of the switch (2) to decrease support.

### Seatback pocket (if equipped)

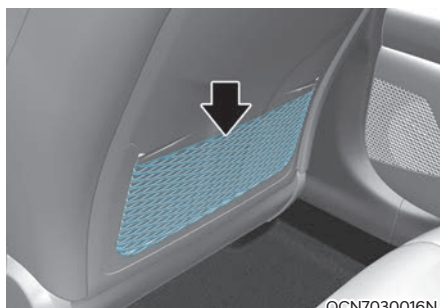

OCN7030016N

The seatback pocket is provided on the back of the front seatbacks.



### WARNING

To prevent the Occupant Classification System from malfunctioning:

**Do not hang onto the front passenger's seatback.**



### CAUTION

**Do not put heavy or sharp objects in the seatback pockets. In an accident they could come loose from the pocket and injure occupants.**

## Rear Seats

### Folding the rear seat (if equipped)

The rear seatbacks can be folded to facilitate carrying long items or to increase the luggage capacity of the vehicle.

#### WARNING

- **Never allow passengers to sit on top of the folded down seatback while the vehicle is moving. This is not a proper seating position and no seat belts are available for use. This could result in serious injury or death in case of an accident or sudden stop.**
- **Objects carried on the folded down seatback should not extend higher than the top of the front seatbacks. This could allow cargo to slide forward and cause injury or damage during sudden stops.**

To fold down the rear seatback:

1. Set the front seatback to the upright position and if necessary, slide the front seat forward.

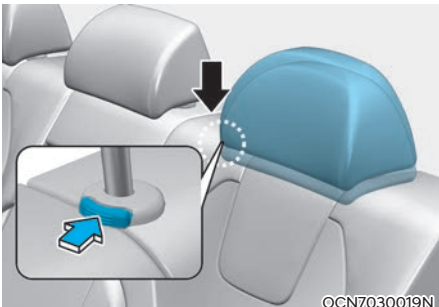

2. Lower the rear head restraints to the lowest position by pushing and holding the release button and pushing down on the head restraint.



3. Pull on the seatback folding lever located in the trunk.

#### ■ Type A

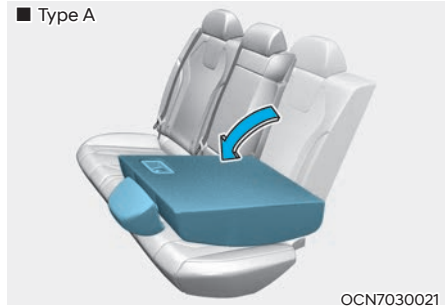

#### ■ Type B

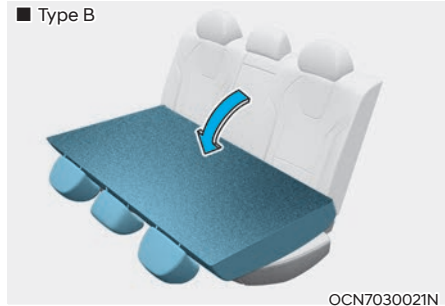

4. Fold the seatback toward the front of the vehicle.
5. To use the rear seat, lift and pull the seatback rearward. Pull the seatback firmly until it clicks into place. Make sure the seatback is locked in place.

### **WARNING**

When returning the rear seatback from a folded to an upright position, hold the seatback and return it slowly. Ensure that the seatback is completely locked into its upright position by pushing on the top of the seatback. In an accident or sudden stop, an unlocked seatback could allow cargo to move forward with great force and enter the passenger compartment, which could result in serious injury or death.

### **WARNING**

Do not place objects in the rear seats, since they cannot be properly secured and may hit vehicle occupants in a collision causing serious injury or death.

### **WARNING**

Make sure the vehicle is off, the shift lever is in P (Park), and the parking brake is securely applied whenever loading or unloading cargo. Failure to take these steps may allow the vehicle to move if the shift lever is inadvertently moved to another position.

### *Armrest (if equipped)*



OCN7030066L

The armrest is located in the center of the rear seat. Pull the armrest down from the seatback to use it.

### **Head Restraints**

The vehicle's front and rear seats have adjustable head restraints. The head restraints provide comfort for passengers, but more importantly they are designed to help protect passengers from whiplash and other neck and spinal injuries during an accident, especially in a rear impact collision.

### **WARNING**

To help reduce the risk of serious injury or death in an accident, take the following precautions when adjusting your head restraints:

- Always properly adjust the head restraints for all passengers **BEFORE** starting the vehicle.
- **NEVER** let anyone ride in a seat with the head restraints removed or reversed.

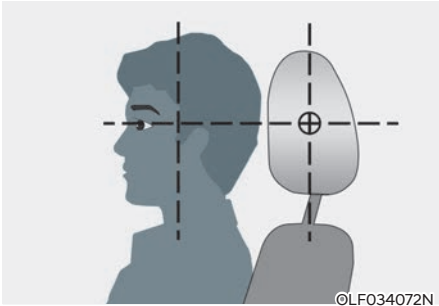

©LF034072N

- Adjust the head restraints so the middle of the head restraint is at the same height as the height of the top of the eyes.
- NEVER adjust the head restraint position of the driver's seat when the vehicle is in motion.
- Adjust the head restraint as close to the passenger's head as possible. Do not use a seat cushion that holds the body away from the seatback.
- Make sure the head restraint locks into position after adjusting it.

**NOTICE**

To prevent damage, NEVER hit or pull on the head restraints.

**CAUTION**

When there are no occupants in the rear seats, adjust the height of the head restraint to the lowest position. The rear seat head restraint can reduce the visibility of the rear area.

**Front seat head restraints**

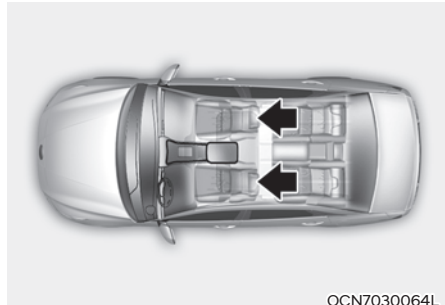

OCN7030064L

Both the driver's and passenger's front seat are equipped with adjustable head restraints for the safety and comfort.

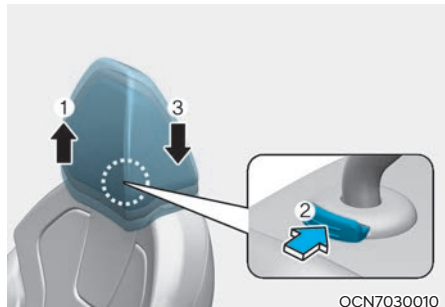

OCN7030010

**Adjusting the height up and down**

To raise the head restraint:

1. Pull it up to the desired position (1).

To lower the head restraint:

1. Push and hold the release button (2) on the head restraint support.
2. Lower the head restraint to the desired position (3).

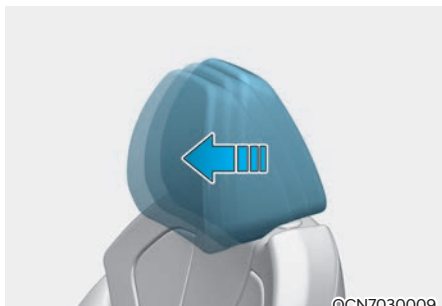

### Forward and rearward adjustment (if equipped)

The head restraint can be adjusted forward to 3 different positions by pulling the head restraint forward to the desired detent. To adjust the head restraint to its furthest rearwards position, pull it fully forward to the farthest position and release it.

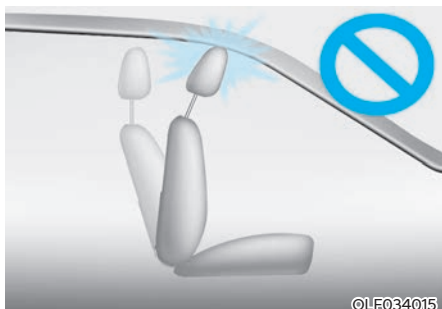

### NOTICE

If you recline the seatback towards the front with the head restraint and seat cushion raised, the head restraint may come in contact with the sunvisor or other parts of the vehicle.

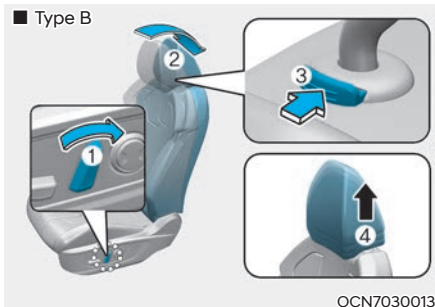
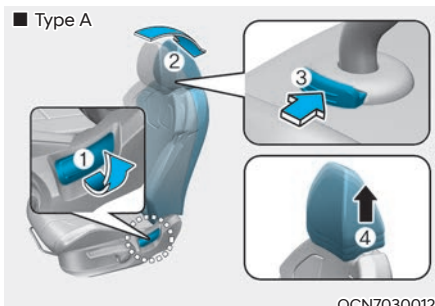

### Removal/Reinstallation

To remove the head restraint:

1. Recline the seatback (2) rearward using the seatback angle lever (1).
2. Raise the head restraint as far as it can go.
3. Press the head restraint release button (3) while pulling the head restraint up (4).



### WARNING

**NEVER** allow anyone to travel in a seat with the head restraint removed.

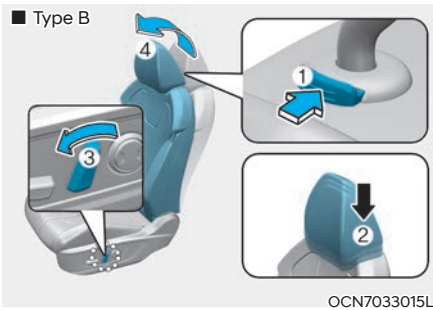
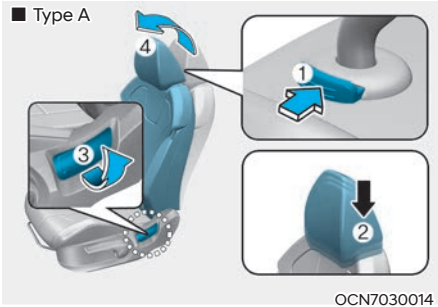

To reinstall the head restraint:

1. Put the head restraint poles (2) into the holes while pressing the release button (1).
2. Adjust the head restraint to the appropriate height.
3. Adjust the seatback (4) forward using the seatback angle lever (3).

**⚠ WARNING**

**Always make sure the head restraint locks into position after reinstalling and adjusting it properly.**

**Rear seat head restraints**

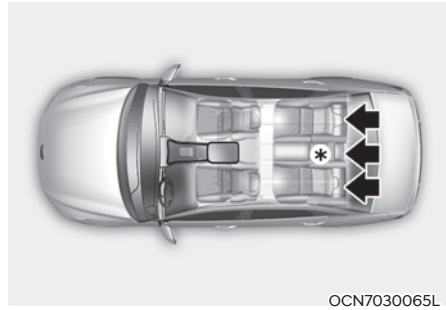

The rear seats are equipped with head restraints in all the seating positions for the passenger's safety and comfort.

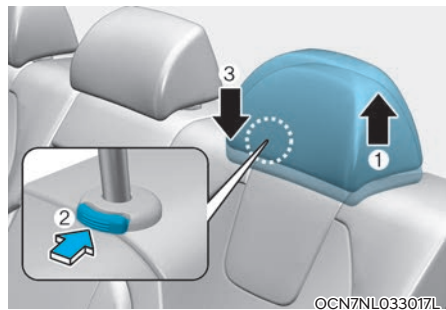

**Adjusting the height up and down (if equipped)**

To raise the head restraint:

1. Pull it up to the desired position (1).

To lower the head restraint:

1. Push and hold the release button (2) on the head restraint support.
2. Lower the head restraint to the desired position (3).

## Seat Warmers (if equipped)

### *Front seat warmers*

Seat warmers are provided to warm the seats during cold weather.



### **WARNING**

The seat warmers can cause a **SERIOUS BURN**, even at low temperatures and especially if used for long periods of time.

Passengers must be able to feel if the seat is becoming too warm so they can turn it off, if needed.

People who cannot detect temperature change or pain to the skin should use extreme caution, especially the following types of passengers:

- Infants, children, elderly or disabled persons, or hospital outpatients.
- People with sensitive skin or who burn easily.
- Fatigued individuals.
- Intoxicated individuals.
- People taking medication that can cause drowsiness or sleepiness.



### **WARNING**

**NEVER** place anything on the seat that insulates against heat when the seat warmer is in operation, such as a blanket or seat cushion. This may cause the seat warmer to overheat, causing a burn or damage to the seat.

### **NOTICE**

To prevent damage to the seat warmers and seats:

- Never use a solvent such as paint thinner, benzene, alcohol or gasoline to clean the seats.
- Do not place heavy or sharp objects on seats equipped with seat warmers.
- Do not change the seat cover. It may damage the seat warmer or air ventilation system.

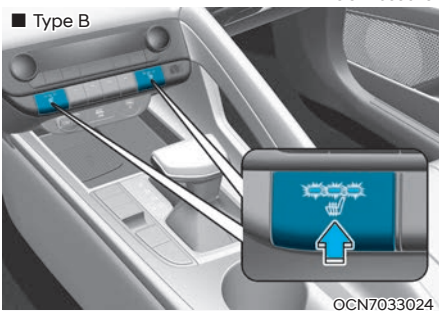
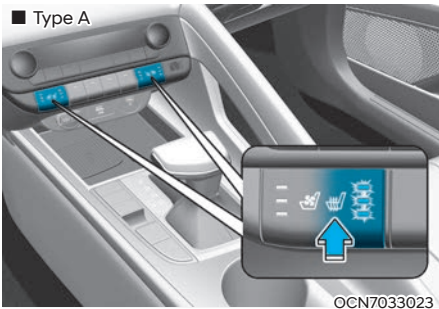

While the engine is running, push either of the switches to warm the driver's seat or front passenger's seat.

During mild weather or under conditions where the operation of the seat warmer is not needed, keep the switches in the OFF position.

- Manual temperature control  
Each time you push the switch, the temperature setting of the seat is changed as follows:
  - Front seat

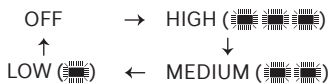

- Automatic temperature control  
The seat warmer starts to automatically control the seat temperature in order to prevent low-temperature burns after being manually turned ON.

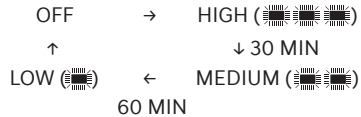

You may manually press the switch to decrease seat temperature. However, it soon returns the automatic mode again.

- When pressing the switch for more than 1.5 seconds with the seat warmer operating, the seat warmer will turn OFF.
- The seat warmer defaults to the OFF position whenever the ignition switch is in the ON position. However, if the Auto Comfort Control function is ON, the driver's seat warmer will turn on and off depending on the ambient temperature.
- Auto Comfort Control (for driver's seat, if equipped)  
The seat warmer automatically controls the seat temperature depending on the ambient temperature when the engine is running. If the seat warmer engine is pushed, the seat warmer will have to be controlled manually. To use this function, it must be activated from the Settings menu in the infotainment system screen.

**i Information**

The infotainment system may change after software updates. For more information, refer to the user's manual provided in the infotainment system and the quick reference guide.

## Air Ventilation Seat (if equipped)

### Front air ventilation seat

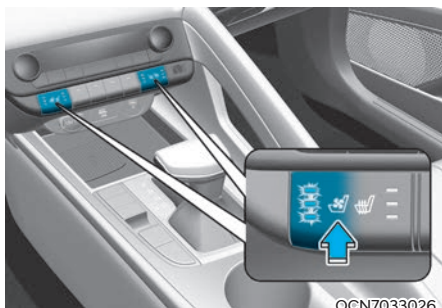

OCN7033026

The air ventilation seats are provided to cool the front seats by blowing air through small vent holes on the surface of the seat cushions and seatbacks.

When the operation of the air ventilation seat is not needed, keep the switches in the OFF position.

While the engine is running, push the switch to cool the driver's seat or the front passenger's seat.

- Each time you push the switch, the airflow changes as follows:

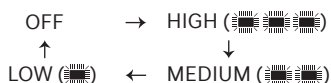

- When pressing the switch for more than 1.5 seconds with the air ventilation seat operating, the operation will turn OFF.
- The air ventilation seat defaults to the OFF position whenever the ignition switch is in the ON position. However, if the Auto Comfort Control function is ON, the driver's air ventilation seat will turn on and off depending on the ambient temperature.

- Auto Comfort Control (for driver's seat, if equipped)

The air ventilation seat automatically controls the seat temperature depending on the ambient temperature when the engine is running. If the air ventilation seat switch is pushed, the seat warmer will have to be controlled manually. To use this function, it must be activated from the Settings menu in the infotainment system screen.

### **i** Information

The infotainment system may change after software updates. For more information, refer to the user's manual provided in the infotainment system and the quick reference guide.

### **NOTICE**

To prevent damage to the air ventilation seat:

- Use the air ventilation seat **ONLY** when the climate control system is on. Using the air ventilation seat for prolonged periods of time with the climate control system off could cause the air ventilation seat to malfunction.
- Never use a solvent such as paint thinner, benzene, alcohol or gasoline to clean the seats.
- Avoid spilling liquids on the surface of the front seats and seatbacks; this may cause the air vent holes to become blocked and not work properly.
- Do not place materials such as plastic bags or newspapers under the seats. They may block the air intake causing the air vents to not work properly.
- Do not change the seat covers. It may damage the air ventilation seat.
- If the air vents do not operate, restart the vehicle. If there is no change, have the vehicle inspected by an authorized HYUNDAI dealer.

## SEAT BELTS

This section describes how to use the seat belts properly. It also describes some of the things to avoid when using seat belts.

### Seat Belt Safety Precautions

Always fasten your seat belt and make sure all passengers have fastened their seat belts before starting any trip. Airbags are designed to supplement the seat belt as an additional safety device, but they are not a substitute. Most states require all occupants of a vehicle to wear seat belts.



#### WARNING

Seat belts must be used by **ALL** passengers whenever the vehicle is moving. Take the following precautions when adjusting and wearing seat belts:

- **ALWAYS** properly restrain children under age 13 in the rear seats.
- **NEVER** allow children to ride in the front passenger seat. If a child age 13 or older must be seated in the front seat, move the seat as far back as possible. And the child must always be restrained in the seat properly.
- **NEVER** allow an infant or child to be carried on an occupant's lap.
- **NEVER** ride with the seatback reclined when the vehicle is moving.
- Do not allow children to share a seat or seat belt.
- Do not wear the shoulder belt under your arm or behind your back.
- Always wear both the shoulder portion and lap portion of the lap/shoulder belt.
- Do not use the seat belt if it is twisted. A twisted seat belt will not protect you properly in an accident.
- Do not use a seat belt if the webbing or hardware is damaged.

- Do not latch the seat belt into the buckles of other seats.
- **NEVER** unfasten the seat belt while driving. This may cause loss of vehicle control resulting in an accident.
- Make sure there is nothing in the buckle interfering with the seat belt latch mechanism, because any materials in the buckle can cause the seat belt not to be fastened securely.
- No modifications or additions should be made by the user which will either prevent the seat belt adjusting devices from operating to remove slack, or prevent the seat belt assembly from being adjusted to remove slack.



#### WARNING

Damaged seat belts and seat belt assemblies will not operate properly. Always replace:

- Frayed, contaminated, or damaged webbing
- Damaged hardware
- The entire seat belt assembly after it has been worn in an accident, even if damage to webbing or assembly is not apparent

## Seat Belt Warning Light

### Seat belt warning

- Instrument cluster  
(Driver and front passenger's seat)



1GQA2083

#### Driver's and Passenger's front seat belt warning

As a reminder, the seat belt warning light will illuminate for approximately 6 seconds each time you turn the ignition switch or ENGINE START/STOP button is in the ON position regardless of belt fastening. If the seatbelt is not fastened, the warning chime will sound for about 6 seconds.

If you start to drive without the seat belt fastened over approximately 5 mph (9 km/h) and less than approximately 12 mph (20 km/h), the corresponding warning light will illuminate. The warning light will turn off when the vehicle speed drops below approximately 5 mph (9 km/h).

If you start to drive without the seat belt fastened or you unfasten the seat belt when you drive approximately 12 mph (20 km/h) and faster, the warning light will blink and warning chime will sound for approximately 100 seconds.

When the seat belt is unfastened during driving, the warning light will illuminate when the speed is over approximately 5 mph (9 km/h) and less than approximately 12 mph (20 km/h). When the speed is approximately 12 mph (20 km/h) and faster, the warning light will blink and warning chime will sound for approximately 100 seconds.

## Seat Belt Restraint System



### WARNING

Improperly positioned seat belts may increase the risk of serious injury in an accident. Take the following precautions when adjusting the seat belt:

- Position the lap portion of the seat belt as low as possible across your hips, not on your waist, so that it fits snugly.
- Position one arm under the shoulder belt and the other over the belt, as shown in the illustration.
- Always position the shoulder belt anchor into the locked position at the appropriate height.
- **NEVER** position the shoulder belt across your neck or face.

### Seat Belt-Driver's 3-point system with emergency locking retractor

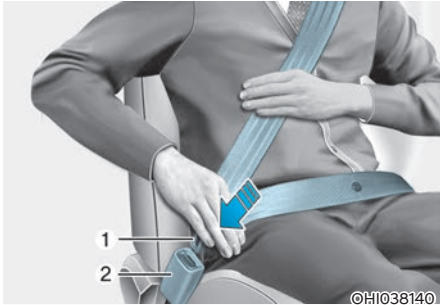

#### To fasten your seat belt:

Pull the seat belt out of the retractor and insert the metal tab (1) into the buckle (2). There will be an audible “click” when the tab locks into the buckle.

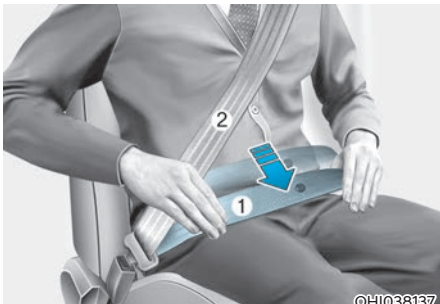

You should place the lap belt (1) portion across your hips and the shoulder belt (2) portion across your chest.

The seat belt automatically adjusts to the proper length after the lap belt portion is adjusted manually so that it fits snugly around your hips. If you lean forward in a slow, easy motion, the belt will extend and move with you.

If there is a sudden stop or impact, the belt will lock into position. It will also lock if you try to lean forward too quickly.

### NOTICE

If you are not able to smoothly pull enough of the seat belt out from the retractor, firmly pull the seat belt out and release it. After release, you will be able to pull the belt out smoothly.

#### Height adjustment

You can adjust the height of the shoulder belt anchor to one of the three different positions for maximum comfort and safety. The shoulder portion should be adjusted so it lies across your chest and midway over your shoulder nearest the door, not over your neck. To adjust the height of the seat belt anchor, lower or raise the height adjuster into an appropriate position.

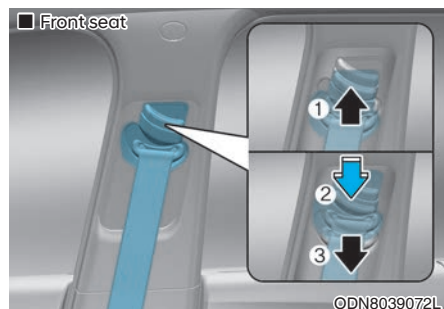

To raise the height adjuster, pull it up (1). To lower it, push it down (3) while pressing the height adjuster button (2). Release the button to lock the anchor into position. Try sliding the height adjuster to make sure that it has locked into position.

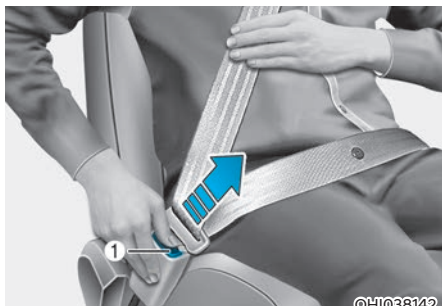

#### To release your seat belt:

Press the release button (1) in the locking buckle.

When it is released, the belt should automatically draw back into the retractor. If this does not happen, check the belt to be sure it is not twisted, then try again.

#### ***Rear Seat Belt – Passenger’s 3-point system with convertible locking retractor***

This type of seat belt combines the features of both an emergency locking retractor seat belt and an automatic locking retractor seat belt. Convertible retractor type seat belts are installed in the rear seat positions to help accommodate the installation of child restraint systems. Although a convertible retractor is also installed in the front passenger seat position, NEVER place any infant/child restraint system in the front seat of the vehicle.

#### To fasten your seat belt:

Pull the seat belt out of the retractor and insert the metal tab into the buckle. There will be an audible “click” when the tab locks into the buckle. When not securing a child restraint, the seat belt operates in the same way as the driver’s seat belt (Emergency Locking Retractor Type). It automatically adjusts to the proper length only after the lap belt portion of the seat belt is adjusted manually so that it fits snugly across your hips.

When the seat belt is fully extended from the retractor to allow the installation of a child restraint system, the seat belt operation changes to allow the belt to retract, but not to extend (Automatic Locking Retractor Type). Refer to the “Using a Child Restraint System” section in this chapter.

#### **NOTICE**

**Although the seat belt retractor provides the same level of protection for seated passengers in either emergency or automatic locking modes, the emergency locking mode allows seated passengers to move freely in their seat while keeping some tension on the belt. During a collision or sudden stop, the retractor automatically locks the belt to help restrain your body.**

**To deactivate the automatic locking mode, unbuckle the seat belt and allow the belt to fully retract.**

### Rear center seat belt



When using the rear center seat belt, the buckle with the “CENTER” mark must be used.

#### **WARNING**

**Make sure that the seatback is locked in place when using the rear center seat belt.**

**If not, the seatback may move when there is a sudden stop or collision, which could result in serious injury.**

### Pre-tensioner seat belt



Your vehicle is equipped with driver's and front passenger's and rear passengers Pre-tensioner Seat Belts (Retractor Pre-tensioner). The purpose of the pre-tensioner is to make sure the seat belts fit tightly against the occupant's body in certain frontal or side collision(s).

When the vehicle stops suddenly, or if the occupant tries to lean forward too quickly, the seat belt retractor will lock into position. In certain frontal or side collision(s), the pre-tensioner will activate and pull the seat belt into tighter contact against the occupant's body.

If the system senses excessive tension on the driver or passenger's seat belt when the pre-tensioner system activates, the load limiter inside the retractor pre-tensioner will release some of the pressure on the affected seat belt.

### WARNING

- Always wear your seat belt and sit properly in your seat.
- Do not use the seat belt if it is loose or twisted. A loose or twisted seat belt will not protect you properly in an accident.
- Do not place anything near the buckle. This may adversely affect the buckle and cause it to function improperly.
- Always replace your pre-tensioners after activation or an accident.
- NEVER inspect, service, repair or replace the pre-tensioners by yourself. This must be done by an authorized HYUNDAI dealer.
- Do not hit the seat belt assemblies.

### WARNING

Do not touch the pre-tensioner seat belt assemblies for several minutes after they have been activated. When the pre-tensioner seat belt mechanism deploys during a collision, the pre-tensioners become hot and can burn you.

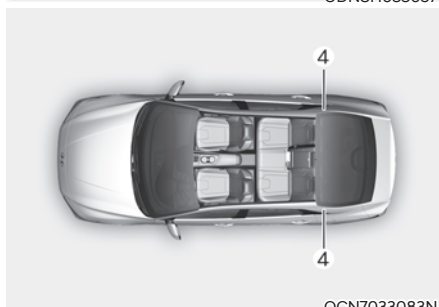
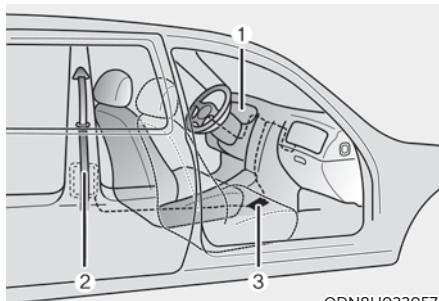

The Pre-Tensioner Seat Belt System consists mainly of the following components. Their locations are shown in the illustration above:

1. SRS airbag warning light
2. Retractor pre-tensioner (front)
3. SRS control module
4. Retractor pre-tensioner (rear)

### NOTICE

The sensor that activates the SRS airbag is connected with the pre-tensioner seat belts. The SRS airbag warning light on the instrument panel will illuminate for approximately 6 seconds after the ignition switch is in the ON position, and then it should turn off.

If the pre-tensioner is not working properly, the warning light will illuminate even if the SRS airbag is not malfunctioning. If the warning light does not illuminate, stays illuminated or illuminates when the vehicle is being driven, have an authorized HYUNDAI dealer inspect the pre-tensioner seat belts and SRS airbags as soon as possible.

### NOTICE

- Both the driver's and front passenger's pre-tensioner seat belts may be activated in certain frontal or side collisions or rollovers.
- When the pre-tensioner seat belts are activated, a loud noise may be heard and fine dust, which may appear to be smoke, may be visible in the passenger compartment. These are normal operating conditions and are not hazardous.
- Although it is non-toxic, the fine dust may cause skin irritation and should not be inhaled for prolonged periods. Wash all exposed skin areas thoroughly after an accident in which the pre-tensioner seat belts were activated.



### WARNING

- Fasten your seat belt while sitting properly in an upright position to maximize the effectiveness of the pre-tensioner seat belt system.
- A pre-tensioner seat belt system is designed to activate only once. Replace the pre-tensioner seat belt system, if it was activated in an accident.

## Additional Seat Belt Safety Precautions

### *Seat belt use during pregnancy*

The seat belt should always be used during pregnancy. The best way to protect your unborn child is to protect yourself by always wearing the seat belt.

Pregnant women should always wear a lap-shoulder seat belt. Place the shoulder belt across your chest, routed between your breasts and away from your neck. Place the lap belt line so that it fits snugly and as low as possible across the hips, not across the abdomen.



### WARNING

- Pregnant women and patients are more vulnerable to any impacts on the abdomen during an abrupt stop or accident. If you are in an accident while pregnant, consult your doctor.
- To reduce the risk of serious injury or death to an unborn child during an accident, pregnant women should NEVER place the lap portion of the seat belt above or over the area of the abdomen where the unborn child is located.

### *Seat belt use and children*

#### Infant and small children

All 50 states have child restraint laws which require children to travel in approved child restraint devices, including booster seats. The age at which seat belts can be used instead of child restraints differs among states, so you should be aware of the specific requirements in your state, and where you are travelling. Infant and child restraints must be properly placed and installed in a rear seat. For more information refer to the "Child Restraint Systems" section in this chapter.



## WARNING

**ALWAYS** properly restrain infants and small children in a child restraint appropriate for the child's height and weight.

**To reduce the risk of serious injury or death to a child and other passengers, NEVER hold a child in your lap or arms when the vehicle is moving. The violent forces created during an accident will tear the child from your arms and throw the child against the interior of the vehicle.**

Small children are best protected from injury in an accident when properly restrained in the rear seat by a child restraint system that meets the requirements of the Federal Motor Vehicle Safety Standards. Before buying any child restraint system, make sure that it has a label certifying that it meets Federal Motor Vehicle Safety Standard FMVSS 213. The restraint must be appropriate for your child's height and weight. Check the label on the child restraint for this information. Refer to the "Child Restraint Systems" section in this chapter.

### Larger children

Children under age 13 and who are too large for a booster seat must always occupy the rear seat and use the available lap/shoulder belts. A seat belt should lie across the upper thighs and be snug across the shoulder and chest to restrain the child safely. Check belt fit periodically. Children are afforded the most safety in the event of an accident when they are restrained by a proper restraint system and/or seat belts in the rear seat. Always have the LATCH system inspected by your authorized HYUNDAI dealer after an accident. An accident can damage the LATCH system and may not properly secure the child restraint.

If a larger child over age 13 must be seated in the front seat, the child must be securely restrained by the available lap/shoulder belt and the seat should be placed in the rearmost position.

If the shoulder belt portion slightly touches the child's neck or face, try placing the child closer to the center of the vehicle. If the shoulder belt still touches their face or neck, they need to be returned to an appropriate booster seat in the rear seat.



## WARNING

- **Always make sure children are wearing their seat belts and that they are properly adjusted before driving.**
- **NEVER allow the shoulder belt to contact the child's neck or face.**
- **Do not allow more than one child to use a single seat belt.**

### ***Transporting an injured person***

A seat belt should be used when an injured person is being transported. Consult a physician for specific recommendations.

### ***One person per belt***

Two people (including children) should never attempt to use a single seat belt. This could increase the severity of injuries in case of an accident.

### ***Do not lie down***

Sitting in a reclined position when the vehicle is in motion can be dangerous. Even when buckled up, the protections of your restraint system (seat belts and airbags) is greatly reduced by reclining your seatback.

To reduce the chance of injuries in the event of an accident and to achieve the maximum effectiveness of the restraint system, all passengers should be sitting up and the front and rear seats should be in an upright position when the car is moving.

A seat belt cannot provide proper protection if the person is lying down in the rear seat or if the front or rear seats are in a reclined position.



### **WARNING**

- **NEVER ride with a reclined seatback when the vehicle is moving.**
- **Riding with a reclined seatback increases your chance of serious or fatal injuries in the event of a collision or sudden stop.**
- **Drivers and passengers should always sit well back in their seats, properly belted, and with the seatbacks upright.**

### **Care of Seat Belts**

Seat belt systems should never be disassembled or modified. In addition, care should be taken to assure that seat belts and belt hardware are not damaged by seat hinges, doors or other abuse.

### ***Periodic inspection***

All seat belts should be inspected periodically for wear or damage of any kind. Any damaged parts should be replaced as soon as possible by an authorized HYUNDAI dealer.

### ***Keep belts clean and dry***

Seat belts should be kept clean and dry. If belts become dirty, they can be cleaned by using a mild soap solution and warm water. Bleach, dye, strong detergents or abrasives should not be used because they may damage and weaken the fabric.

### ***When to replace seat belts***

The entire seat belt assembly or assemblies should be replaced if the vehicle has been involved in an accident. This should be done even if no damage is visible. Additional questions concerning seat belt operation should be directed to an authorized HYUNDAI dealer.

## CHILD RESTRAINT SYSTEM (CRS)

### Children Always in the Rear



#### WARNING

**Always properly restrain children in the rear seats of the vehicle.**

**Children of all ages are safer when restrained in the rear seat. A child riding in the front passenger seat can be forcefully struck by an inflating airbag resulting in SERIOUS INJURY or DEATH.**

Children under age 13 must always ride in the rear seats and must always be properly restrained to minimize the risk of injury in an accident, sudden stop or sudden maneuver. According to accident statistics, children are safer when properly restrained in the rear seats than in the front seat. **Even with airbags, children can be seriously injured or killed.** Children too large for a child restraint must use the seat belts provided.

All 50 states have child restraint laws which require children to travel in approved child restraint devices. The laws governing the age or height/weight restrictions at which seat belts can be used instead of child restraints differs among states, so you should be aware of the specific requirements in your state, and where you are travelling.

Child restraint systems must be properly placed and installed in the rear seat. You must use a commercially available child restraint system that meets the requirements of the Federal Motor Vehicle Safety Standards (FMVSS 213).

Child restraint systems are generally designed to be secured in a vehicle seat by lap belt portion of a lap/shoulder belt, or by a LATCH system in the rear seats of the vehicle.

### Child restraint system (CRS)

Infants and younger children must be restrained in an appropriate rear-facing or forward-facing CRS that has first been properly secured to the rear seat of the vehicle. Read and comply with the instructions for installation and use provided by the manufacturer of the child restraint.



#### WARNING

**An improperly secured child restraint can increase the risk of SERIOUS INJURY or DEATH in an accident. Always take the following precautions when using a child restraint system:**

- **NEVER** install a child or infant restraint in the front passenger's seat.
- Always properly secure the child restraint to a rear seat of the vehicle.
- Always follow the child restraint system manufacturer's instructions for installation and use.
- Always properly restrain your child in the child restraint.
- If the vehicle head restraint prevents proper installation of a child seat (as described in the child restraint system manual), the head restraint of the respective seating position shall be readjusted or entirely removed.
- Do not use an infant carrier or a child safety seat that "hooks" over a seatback, it may not provide adequate protection in an accident.
- After an accident, have a **HYUNDAI** dealer check the child restraint system, seat belts, tether anchors and lower anchors.

## Selecting a Child Restraint System (CRS)

When selecting a CRS for your child, always:

- Make sure the CRS has a label certifying that it meets applicable Federal Motor Vehicle Safety Standards (FMVSS 213).
- Select a child restraint based on your child's height and weight. The required label or the instructions for use typically provide this information.
- Select a child restraint that fits the vehicle seating position where it will be used.
- Read and comply with the warnings and instructions for installation and use provided with the child restraint system.

### Child restraint system types

There are three main types of child restraint systems: rear-facing seats, forward-facing seats, and booster seats. They are classified according to the child's age, height and weight.

#### Rear-facing child seats



### WARNING

**NEVER** install a child or infant restraint in the front passenger's seat.

**Placing a rear-facing child restraint in the front seat can result in SERIOUS INJURY or DEATH if the child restraint is struck by an inflating airbag.**



A rear-facing child seat provides restraint with the seating surface against the back of the child. The harness system holds the child in place, and in an accident, acts to keep the child positioned in the seat and reduce the stress to the neck and spinal cord.

All children under age one must always ride in a rear-facing infant child restraint.

Convertible and 3-in-1 child seats typically have higher height and weight limits for the rear-facing position, allowing you to keep your child rear-facing for a longer period of time.

Continue to use a rear-facing child seat for as long as your child will fit within the height and weight limits allowed by the child seat manufacturer. It's the best way to keep them safe. Once your child has outgrown the rear-facing child restraint, your child is ready for a forward-facing child restraint with a harness.



### Forward-facing child restraints

A forward-facing child seat provides restraint for the child's body with a harness. Keep children in a forward-facing child seat with a harness until they reach the top height or weight limit allowed by your child restraint's manufacturer.

Once your child outgrows the forward-facing child restraint, your child is ready for a booster seat.

### Booster seats

A booster seat is a restraint designed to improve the fit of the vehicle's seat belt system. A booster seat positions the seat belt so that it fits properly over the lap of your child.

Keep your child in a booster seat until they are big enough to sit in the seat without a booster and still have the seat belt fit properly. For a seat belt to fit properly, the lap belt must lie snugly across the upper thighs, not the stomach. The shoulder belt should lie snug across the shoulder and chest and not across the neck or face. Children under age 13 must always ride in the rear seats and must always be properly restrained to minimize the risk of injury.

## Installing a Child Restraint System (CRS)

### WARNING

Before installing your child restraint system always:

- Read and follow the instructions provided by the manufacturer of the child restraint.
- Read and follow the instructions regarding child restraint systems in this manual.

Failure to follow all warnings and instructions could increase the risk of the **SERIOUS INJURY** or **DEATH** if an accident occurs.

### WARNING

If the vehicle head restraint prevents proper installation of a child seat as described in the child seat system manual, the head restraint of the respective seating position shall be readjusted or entirely removed.

After selecting a proper child seat for your child, check to make sure it fits properly in your vehicle. Follow the instructions provided by the manufacturer when installing the child seat. Note these general steps when installing the seat to your vehicle:

- **Properly secure the child restraint to the vehicle.** All child restraints must be secured to the vehicle with the lap part of a lap/shoulder belt or with the LATCH system.
- **Make sure the child restraint is firmly secured.** After installing a child restraint to the vehicle, push and pull the seat forward-and-back and side-to-side to verify that it is securely attached to the seat. A child restraint secured with a seat belt should be installed as firmly as possible. However, some side-to-side movement can be expected.
- **Secure the child in the child restraint.** Make sure the child is properly strapped in the child restraint according to the manufacturer instructions.



### CAUTION

**A child restraint in a closed vehicle can become very hot. To prevent burns, check the seating surface and buckles before placing your child in the child restraint.**

### ***Lower Anchors and Tether for Children (LATCH System)***

The LATCH system holds a child restraint during driving and in an accident. This system is designed to make installation of the child restraint easier and reduce the possibility of improperly installing your child restraint. The LATCH system uses anchors in the vehicle and attachments on the child restraint. The LATCH system eliminates the need to use seat belts to secure the child restraint to the rear seats.

Lower anchors are metal bars built into the vehicle. There are two lower anchors for each LATCH seating position that will accommodate a child restraint with lower attachments.

To use the LATCH system in your vehicle, you must have a child restraint with LATCH attachments.

The child seat manufacturer will provide you with instructions on how to use the child seat with its attachments for the LATCH lower anchors.

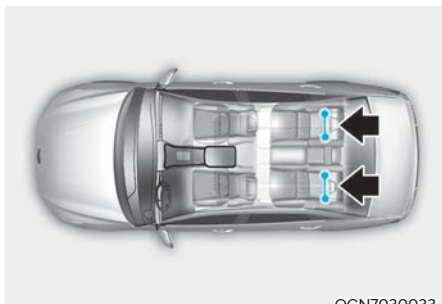

OCN7030033

LATCH anchors have been provided in the left and right outboard rear seating positions. Their locations are shown in the illustration. There are no LATCH anchors provided for the center rear seating position.



### **WARNING**

**Do not attempt to install a child restraint system using LATCH anchors in the rear center seating position. There are no LATCH anchors provided for this seat. Using the outboard seat anchors can damage the anchors which may break or fail in a collision resulting in serious injury or death.**

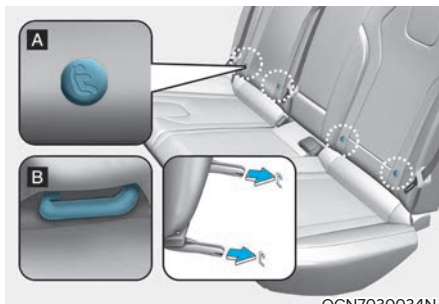

OCN7030034N

[A]: Lower Anchor Position Indicator

[B]: Lower Anchor

The lower anchor position indicator symbols are located on the left and right rear seat backs to identify the position of the lower anchors in your vehicle (see arrows in illustration).

The LATCH anchors are located between the seatback and the seat cushion of the rear seat left and right outboard seating positions.

### ***Securing a child restraint with the LATCH anchors system***

To install a LATCH-compatible child restraint in either of the rear outboard seating positions:

1. Move the seat belt buckle away from the lower anchors.
2. Move any other objects away from the anchors that could prevent a secure connection between the child restraint and the lower anchors.
3. Place the child restraint on the vehicle seat, then attach the seat to the lower anchors according to the instructions provided by the child restraint manufacturer.
4. Follow the child restraint instructions for properly adjusting and tightening the lower attachments on the child restraint to the lower anchors.

**⚠ WARNING**

Take the following precautions when using the LATCH system:

- Read and follow all installation instructions provided with your child restraint system.
- To prevent the child from reaching and taking hold of unretracted seat belts, buckle all unused rear seat belts and retract the seat belt webbing behind the child. Children can be strangled if a shoulder belt becomes wrapped around their neck and the seat belt tightens.
- **NEVER** attach more than one child restraint to a single anchor. This could cause the anchor or attachment to come loose or break.
- Always have the LATCH system inspected by your authorized HYUNDAI dealer after an accident. An accident can damage the LATCH system and may not properly secure the child restraint.

**NOTICE**

The recommended weight for the LATCH system is under 65 lb (30 kg).

How to determine an appropriate child restraint weight:

Child weight + Child restraint weight < 65 lb (30kg)

**Securing a child restraint seat with “Tether Anchor” system**

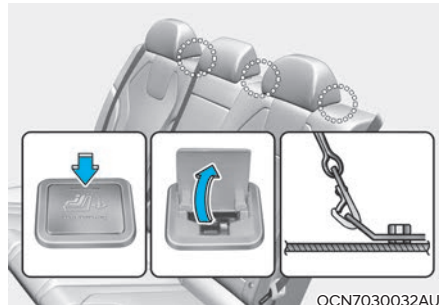

First secure the child restraint with the LATCH lower anchors or the seat belt. If the child restraint manufacturer recommends that the top tether strap be attached, attach and tighten the top tether strap to the top tether strap anchor.

Child restraint hook holders are located on the rear of the seatbacks.

**⚠ WARNING**

Take the following precautions when installing the tether strap:

- Read and follow all installation instructions provided with your child restraint system.
- **NEVER** attach more than one child restraint to a single tether anchor. This could cause the anchor or attachment to come loose or break.
- Do not attach the tether strap to anything other than the correct tether anchor. It may not work properly if attached to something else.
- Do not use the tether anchors for adult seat belts or harnesses, or for attaching other items or equipment to the vehicle.



OCN7030031

To install the tether anchor:

1. Route the child restraint tether strap over the child restraint seatback. Route the tether strap under the head restraint and between the head restraint posts, or route the tether strap over the top of the vehicle seatback. Make sure the strap is not twisted.
2. Connect the tether strap hook to the tether anchor, then tighten the tether strap according to the child seat manufacturer's instructions to firmly secure the child restraint to the seat.
3. Check that the child restraint is securely attached to the seat by pushing and pulling the seat forward-and-back and side-to-side.

### ***Securing a child restraint with lap/shoulder belt***

When not using the LATCH system, all child restraints must be secured to a vehicle rear seat with the lap part of a lap/shoulder belt.



### **WARNING**

**ALWAYS place a rear-facing child restraint in the rear seat of the vehicle.**

**Placing a rear-facing child restraint in the front seat can result in serious injury or death if the child restraint is struck by an inflating airbag.**

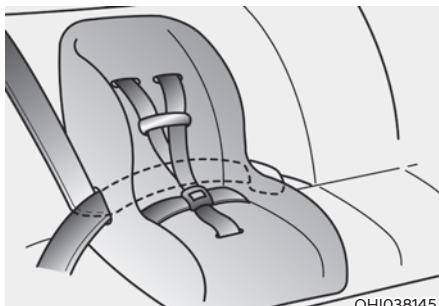

OH1038145

### **Automatic locking mode**

Since all passenger seat belts move freely under normal conditions and only lock under extreme or emergency conditions (emergency locking mode), you must manually pull the seat belt all the way out to shift the retractor to the "Automatic Locking" mode to secure a child restraint.

The "Automatic Locking" mode will help prevent the normal movement of the child in the vehicle from causing the seat belt to loosen and compromise the child restraint system. To secure a child restraint system, use the following procedure.

To install a child restraint system on the rear seats, do the following:

1. Place the child restraint system on a rear seat and route the lap/ shoulder belt around or through the child restraint, following the restraint manufacturer's instructions. Be sure the seat belt webbing is not twisted.

### **i** Information

When using the rear center seat belt, you should also refer to the “Rear Seat Belt – Passenger’s 3-point system” section in this chapter.

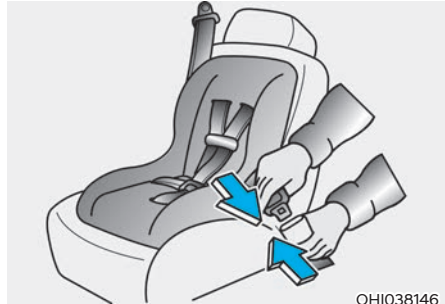

2. Fasten the lap/shoulder belt latch into the buckle. Listen for the distinct “click” sound.

### **i** Information

Position the release button so that it is easy to access in case of an emergency.



3. Pull the shoulder portion of the seat belt all the way out. When the shoulder portion of the seat belt is fully extended, it will shift the retractor to the “Automatic Locking” (child restraint) mode.



OLF034075

4. Slowly allow the shoulder portion of the seat belt to retract and listen for an audible “clicking” or “ratcheting” sound. This indicates that the retractor is in the “Automatic Locking” mode. If no distinct sound is heard, repeat steps 3 and 4.
5. Remove as much slack from the belt as possible by pushing down on the child restraint system while feeding the shoulder belt back into the retractor.
6. Push and pull on the child restraint system to confirm that the seat belt is holding it firmly in place. If it is not, release the seat belt and repeat steps 2 through 6.
7. Double check that the retractor is in the “Automatic Locking” mode by attempting to pull more of the seat belt out of the retractor. If you cannot, the retractor is in the “Automatic Locking” mode.

If your CRS (child restraint system) manufacturer instructs or recommends you to use a tether anchor with the lap/shoulder belt, refer to the previous pages for more information.

### **i** Information

**When the seat belt is allowed to retract to its fully stowed position, the retractor will automatically switch from the “Automatic Locking” mode to the emergency lock mode for normal adult usage.**

### **!** WARNING

**If the retractor is not in the “Automatic Locking” mode, the child restraint can move when your vehicle turns or stops suddenly. A child can be seriously injured or killed if the child restraint is not properly anchored in the car, including manually pulling the seat belt all the way out to shift the retractor to the “Automatic Locking” mode.**

To remove the child restraint, press the release button on the buckle and then pull the lap/shoulder belt out of the restraint and allow the seat belt to retract fully.

## AIRBAG - ADVANCED SUPPLEMENTAL RESTRAINT SYSTEM

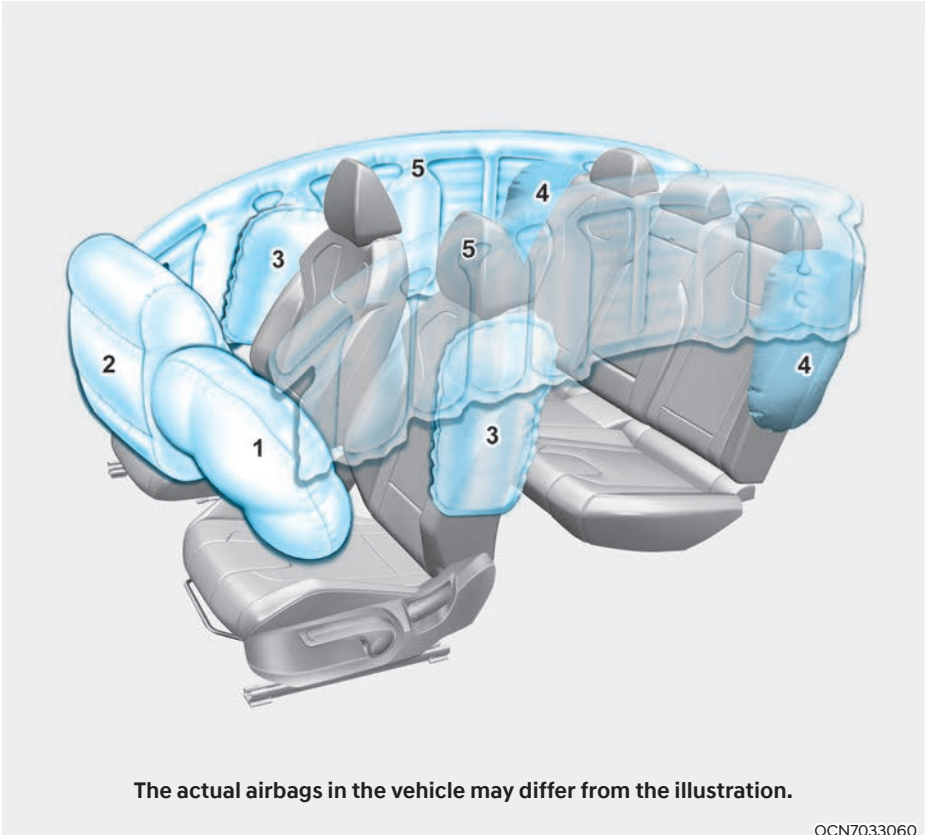

1. Driver's front airbag
2. Passenger's front airbag
3. Front side airbag
4. Rear side airbag (if equipped)
5. Curtain airbag

This vehicle is equipped with an Advanced Supplemental Airbag System for the driver's seat and front passenger's seats.

The front airbags are designed to supplement the three-point seat belts. For these airbags to provide protection, the seat belts must be worn at all times when driving.

You can be severely injured or killed in an accident if you are not wearing a seat belt. Airbags are designed to supplement seat belts, but do not replace them. Also, airbags are not designed to deploy in every collision. In some accidents, the seat belts are the only restraint protecting you.



## **WARNING**

### **AIRBAG SAFETY PRECAUTIONS**

**ALWAYS** use seat belts and child restraints - every trip, every time, everyone! Even with airbags, you can be seriously injured or killed in a collision if you are improperly belted or not wearing your seat belt when the airbag inflates.

**NEVER** place a child in any child restraint or booster seat in the front passenger seat. An inflating airbag could forcefully strike the infant or child causing serious or fatal injuries.

**ABC - Always Buckle Children** under age 13 in the back seat. It is the safest place for children of any age to ride. If a child age 13 or older must be seated in the front seat, he or she must be properly belted and the seat should be moved as far back as possible.

All occupants should sit upright with the seatback in an upright position, centered on the seat cushion with their seat belt on, legs comfortably extended and their feet on the floor until the vehicle is parked and is turned off. If an occupant is out of position during an accident, the rapidly deploying airbag may forcefully contact the occupant causing serious or fatal injuries.

You and your passengers should never sit or lean unnecessarily close to the airbags or lean against the door or center console.

Move your seat as far back as possible from front airbags, while still maintaining control of the vehicle. The U.S. National Highway Traffic Safety Administration (NHTSA) recommends that drivers allow at least 10 inches (25 cm) between the center of the steering wheel and the chest.

## Where are the Airbags?

### **Driver's and passenger's front airbags**

Your vehicle is equipped with an Advanced Supplemental Restraint System (SRS) and lap/shoulder belts at both the driver and passenger seating positions.

The SRS consists of airbags which are located in the center of the steering wheel, in the driver's side lower crash pad below the steering wheel column and the passenger's side front panel pad above the glove box.

The airbags are labeled with the letters "AIR BAG" embossed on the pad covers.

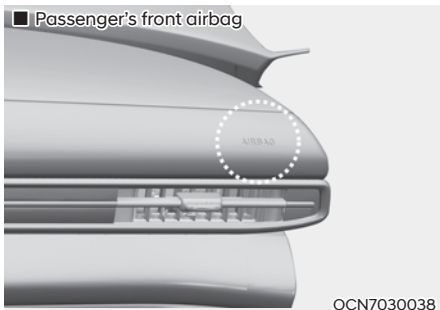

The purpose of the SRS is to provide the vehicle's driver and front passengers with additional protection than that offered by the seat belt system alone. The SRS uses sensors to gather information about the driver's and front passenger's seat belt usage and impact severity.

The seat belt buckle sensors determine if the driver and front passenger's seat belts are fastened. These sensors provide the ability to control the SRS deployment based on whether or not the seat belts are fastened, and how severe the impact is. The advanced SRS offers the ability to control the airbag inflation within two levels. A first stage level is provided for moderate-severity impacts. A second stage level is provided for more severe impacts. According to the impact severity, and seat belt usage, the SRS Control Module (SRSCM) controls the airbag inflation. Failure to properly wear seat belts can increase the risk or severity of injury in an accident.

### **WARNING**

To reduce the risk of serious injury or death from inflating front airbags, take the following precautions:

- **Seat belts must be worn at all times to help keep occupants positioned properly.**
- **Move your seat as far back as possible from front airbags, while still maintaining control of the vehicle.**
- **Never lean against the door or center console.**
- **Do not allow the front passenger to place their feet or legs on the dashboard.**
- **No objects (such as crash pad cover, cellular phone holder, cup holder, air fresheners or stickers) should be placed over or near the airbag modules on the steering wheel, instrument panel, windshield glass, and the front passenger's panel above the glove box. Such objects could cause harm if the vehicle is in a crash severe enough to cause the airbags to deploy.**

### Side airbags (if equipped)

■ Front seat

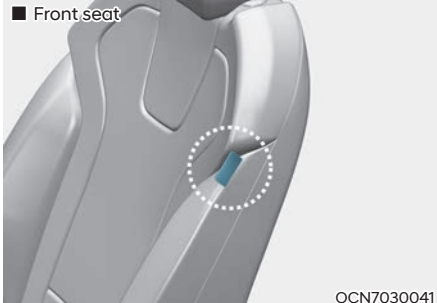

OCN7030041

■ Rear seat



OCN7033088N

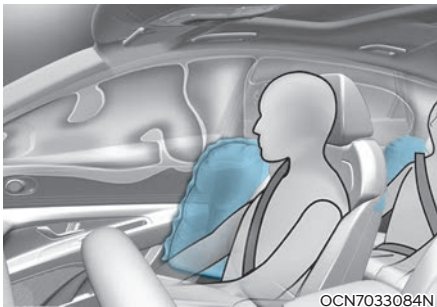

OCN7033084N

Your vehicle is equipped with a side airbag in each front seat and rear seat. The purpose of the airbag is to provide the vehicle's driver and the front passenger with additional protection than that offered by the seat belt alone.

The side airbags are designed to deploy only during certain side impact collisions, depending on the crash severity. The side and curtain airbags on both sides of the vehicle may deploy if a rollover or possible rollover is detected. For vehicles equipped with a rollover sensor the side airbags and pre-tensioners on both sides of the vehicle may deploy if a rollover or possible rollover is detected. However, the side airbags are not designed to deploy in all side impact or rollover situations.



## WARNING

To reduce the risk of serious injury or death from an inflating side airbag, take the following precautions:

- Seat belts must be worn at all times to help keep occupants positioned properly.
- Do not allow passengers to lean their heads or bodies onto doors, put their arms on the doors, stretch their arms out of the window, or place objects between the doors and seats.
- Hold the steering wheel at the 9 o'clock and 3 o'clock positions, to minimize the risk of injuries to your hands and arms.
- Do not use any accessory seat covers. This could reduce or prevent the effectiveness of the system.
- Do not place any objects over the airbag or between the airbag and yourself. Also, do not attach any objects around the area the airbag inflates such as the door, side door glass, front and rear pillar.
- Do not place any objects between the door and the seat. They may become dangerous projectiles if the side airbag inflates.
- Do not install any accessories on the side or near the side airbags.
- Do not put any objects between the side airbag label and seat cushion. It could cause harm if the vehicle is in a crash severe enough to cause the airbags to deploy.
- Do not cause impact to the doors when the ignition switch button is in the ON position as this may cause the side airbags to inflate.
- If the seat or seat cover is damaged, have the vehicle checked and repaired by an authorized HYUNDAI dealer.

## Curtain airbags

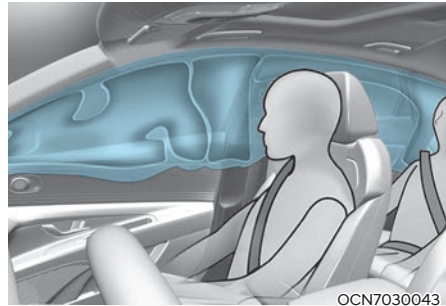
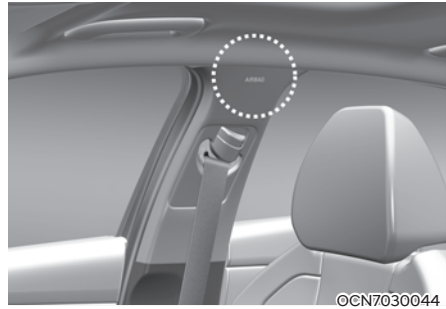

Curtain airbags are located along both sides of the roof rails above the front and rear doors.

They are designed to help protect the heads of the front seat occupants and the rear outboard seat occupants in certain side impact collisions.

The curtain airbags are designed to deploy during certain side impact collisions, depending on the crash severity.

The side and curtain airbags on both sides of the vehicle may deploy if a rollover or possible rollover is detected.

The curtain airbags are not designed to deploy in all side impact or rollover situations.



## WARNING

To reduce the risk of serious injury or death from an inflating curtain airbag, take the following precautions:

- All seat occupants must wear seat belts at all times to help keep occupants positioned properly.
- Properly secure child restraints as far away from the door as possible.
- Do not place any objects over the airbag. Also, do not attach any objects around the area the airbag inflates such as the door, side door glass, front and rear pillar, roof side rail.
- Do not hang other objects except clothes, especially hard or breakable objects. In an accident, it may cause vehicle damage or personal injury.
- Do not allow passengers to lean their heads or bodies onto doors, put their arms on the doors, stretch their arms out of the window, or place objects between the doors and seats.
- Do not attempt to open or repair the side curtain airbags yourself. If necessary, have the airbag inspected by an authorized HYUNDAI dealer.

## How Does the Airbag System Operate?

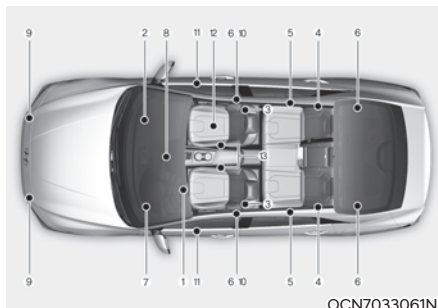

OEN7033061N

The SRS consists of the following components:

- (1) Driver's front airbag module
- (2) Passenger's front airbag module
- (3) Side airbag modules (front)
- (4) Side airbag modules (rear) (if equipped)
- (5) Curtain airbag modules
- (6) Retractor pre-tensioner
- (7) Airbag warning light
- (8) SRS control module (SRSCM)/ Rollover sensor
- (9) Front impact sensors
- (10) Side impact sensors (acceleration)
- (11) Side impact sensors (pressure)
- (12) Occupant classification system
- (13) Driver's and front passenger's seat belt buckle sensors (if equipped)

The SRSCM (Supplemental Restraint System Control Module) continually monitors all SRS components while the ignition switch is in the ON position or approximately within 3 minutes after the ignition is off to determine if a crash impact is severe enough to require airbag deployment or pre-tensioner seat belt deployment.



### SRS warning light

The SRS (Supplement Restraint System) airbag warning light on the instrument panel displays the airbag symbol depicted in the illustration. The system checks the airbag electrical system for malfunctions. The light indicates that there is a potential malfunction with your airbag system, which could include your side and curtain airbags used for rollover protection.



### WARNING

**If your SRS malfunctions, the airbag may not inflate properly during an accident, increasing the risk of serious injury or death.**

**If any of the following conditions occur, your SRS is malfunctioning:**

- **The light does not turn on for approximately three to six seconds when the ignition switch is in the ON position.**
- **The light stays on after illuminating for approximately three to six seconds.**
- **The light comes on while the vehicle is in motion.**
- **The light blinks when the engine is running.**

**Have an authorized HYUNDAI dealer inspect the SRS as soon as possible if any of these conditions occur.**

During a frontal collision, sensors will detect the vehicle's deceleration. If the rate of deceleration is high enough, the control unit will inflate the front airbags. The front airbags help protect the driver and front passenger by responding to frontal impacts in which seat belts alone cannot provide adequate restraint. When needed, the side airbags help provide protection in the event of a side impact or rollover.

- Airbags are activated (able to inflate if necessary) when the ignition switch is in the ON position or approximately within 3 minutes after ignition off.
- Airbags inflate in the event of certain frontal or side collisions to help protect the occupants from serious physical injury.
- Generally, airbags are designed to inflate based upon the severity of a collision, its direction, etc. These two factors determine whether the sensors produce an electronic deployment/inflation signal.
- The front airbags will completely inflate and deflate in an instant. It is virtually impossible for you to see the airbags inflate during an accident. It is much more likely that you will simply see the deflated airbags hanging out of their storage compartments after the collision.
- In addition to inflating in certain side collisions, vehicles equipped with a rollover sensor, side and curtain airbags will inflate if the sensing system detects a rollover.  
When a rollover is detected, side and curtain airbags will remain inflated longer to help provide protection from ejection, especially when used in conjunction with the seat belts.
- To help provide protection, the airbags must inflate rapidly. The speed of airbag inflation is a consequence of extremely short time in which to inflate the airbag between the occupant and the vehicle structures before the occupant impacts those structures. This speed of inflation reduces the risk of serious or life-threatening injuries and is thus a necessary part of airbag design.  
However, the rapid airbag inflation can also cause injuries which can include facial abrasions, bruises and broken bones because the inflation speed also causes the airbags to expand with a great deal of force.

- There are even circumstances under which contact with the airbag can cause fatal injuries, especially if the occupant is positioned excessively close to the airbag.

You can take steps to help reduce the risk of being injured by an inflating airbag. The greatest risk is sitting too close to the airbag. An airbag needs about 10 inches (25 cm) of space to inflate. NHTSA recommends that drivers allow at least 10 inches (25 cm) between the center of the steering wheel and the chest.



## WARNING

To reduce the risk of serious injury or death from an inflating airbag, take the following precautions:

- **NEVER** place a child restraint in the front passenger seat.  
Always properly restrain children under age 13 in the rear seats of the vehicle.
- **Adjust the front passenger's and driver's seats as far to the rear as possible while allowing you to maintain full control of the vehicle.**
- **Hold the steering wheel with hands at the 9 o'clock and 3 o'clock positions.**
- **NEVER** place anything or anyone between the airbag and the seat occupant.
- **Do not allow the front passenger to place their feet or legs on the dashboard.**



ODN8039077L

When the SRSCM detects a sufficiently severe impact to the front of the vehicle, it will automatically deploy the front airbags.

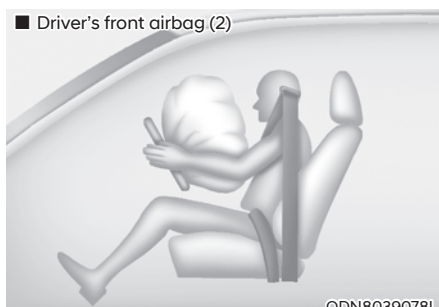

ODN8039078L

Upon deployment, tear seams molded directly into the pad covers will separate under pressure from the expansion of the airbags. Further opening of the covers allows full inflation of the airbags.

A fully inflated airbag, in combination with a properly worn seat belt, slows the driver or the front passenger forward motion, reducing the risk of head and chest injury.

■ Driver's front airbag (3)

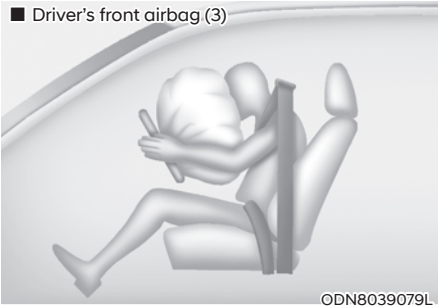

■ Passenger's front airbag



After complete inflation, the airbag immediately starts deflating, enabling the driver to maintain forward visibility and the ability to steer or operate other controls.

 **WARNING**

To prevent objects from becoming dangerous projectiles when the passenger's airbag inflates:

- Do not install or place any objects (drink holder, CD holder, stickers, etc.) on the front passenger's panel above the glove box where the passenger's airbag is located.
- Do not install a container of liquid air freshener near the instrument cluster or on the instrument panel surface.

## What to Expect After an Airbag Inflates

After a frontal or side airbag inflates, it will deflate very quickly. Airbag inflation will not prevent the driver from seeing out of the windshield or being able to steer. Curtain airbags may remain partially inflated for some time after they deploy.

 **WARNING**

After an airbag inflates, take the following precautions:

- Open your windows and doors as soon as possible after impact to reduce prolonged exposure to the smoke and powder released by the inflating airbag.
- Do not touch the airbag storage area's internal components immediately after an airbag has inflated. The parts that come into contact with an inflating airbag may be very hot.
- Always wash exposed skin areas thoroughly with cold water and mild soap.
- Always have an authorized HYUNDAI dealer replace the airbag immediately after deployment. Airbags are designed to be used only once.

### **Noise and smoke from inflating airbag**

When the airbags inflate, they make a loud noise and may produce smoke and powder in the air inside of the vehicle. This is normal and is a result of the ignition of the airbag inflator. After the airbag inflates, you may feel substantial discomfort in breathing because of the contact of your chest with both the seat belt and the airbag, as well as from breathing the smoke and powder. The powder may aggravate asthma for some people. If you experience breathing problems after an airbag deployment, seek medical attention immediately.

Though the smoke and powder are nontoxic, they may cause irritation to the skin, eyes, nose, throat, etc. If this is the case, wash and rinse with cold water immediately and seek medical attention if the symptoms persist.

### **Occupant Classification System (OCS)**



Your vehicle is equipped with an Occupant Classification System (OCS) in the front passenger's seat.

#### **Main components of the Occupant Classification System**

- A detection device located within the front passenger seat cushion.
- Electronic system to help determine whether the passenger airbag systems should be activated or deactivated.
- An indicator light located on the overhead console which illuminates the words "PASSENGER AIR BAG OFF" indicating the front passenger airbag system is deactivated.
- The instrument cluster airbag indicator light is interconnected with the OCS.

The OCS is designed to help detect the presence of a properly-seated front passenger and determine if the passenger's front airbag should be enabled (may inflate) or not.

The purpose is to help reduce the risk of injury or death from an inflating airbag to certain front passenger seat occupants, such as children, by requiring the airbag to be automatically turned OFF.

For example, if a child restraint of the type specified in the regulations is on the seat, the occupant classification sensor can detect it and cause the airbag to turn OFF.

Front passenger seat adult occupants who are properly seated and wearing the seat belt properly, should not cause the passenger airbag to be automatically turned OFF. For small adults it may be turned OFF, however, if the occupant does not sit in the seat properly (for example, by not sitting upright, by sitting on the edge of the seat, or by otherwise being out of position), this could cause the sensor to turn the airbag OFF.

You will find the "PASSENGER AIR BAG OFF" indicator on the overhead console. This system detects the conditions 1-4 in the following table and activates or deactivates the front passenger airbag based on these conditions.

Always be sure that you and all vehicle occupants are seated properly and wearing the seat belt properly for the most effective protection by the airbag and the seat belt.

Never install a Child Restraint System in the front passenger's seat. If you should install a CRS (Child Restraint System) inevitably, use a forward-facing CRS with 3-point ALR safety seat belt and adjust the front passenger's seat as far to the rear as possible. If the PASSENGER AIR BAG "OFF" indicator is OFF after a CRS (Child Restraint System) is equipped, the front passenger's airbag is operating so you should install the CRS in the rear seats of the vehicle immediately.

The OCS may not function properly if the passenger takes actions which can affect the classification system. These include:

- Failing to sit in an upright position.
- Leaning against the door or center console.
- Sitting towards the sides of the front of the seat.
- Putting their legs on the dashboard or resting them on other locations which reduce the passenger weight on the front seat.
- Wearing the seat belt improperly.
- Reclining the seatback.
- Wearing a thick cloth like ski wear or hip protection wear.
- Putting an additional thick cushion on the seat.
- Putting electrical devices (for example, notebook, satellite radio) on the seat with inverter charging.

### Condition and operation in the front passenger Occupant Classification System

Condition detected by the occupant classification system	Indicator/Warning light		Devices
	“PASSENGER AIR BAG OFF” indicator light	SRS warning light	Front passenger airbag
1. Adult *1	Off	Off	Activated
2. Infant *2 or child restraint system with 12 months old *3 *4	On	Off	Deactivated
3. Unoccupied	On	Off	Deactivated
4. Malfunction in the system	Off	On	Activated

\*1: The system judges a person of adult size as an adult. When a smaller adult sits in the front passenger seat, the system may recognize him/her as a child depending on his/her physique and posture.

\*2: Do not allow children to ride in the front passenger seat. When a larger child who has outgrown a child restraint system sits in the front passenger seat, the system may recognize him/her as an adult depending upon his/her physique or sitting position.

\*3: Never install a child restraint system on the front passenger seat.

\*4: The PASSENGER AIR BAG “OFF” indicator may turn on or off when a child above 12 months to 12 years old (with or without child restraint system) sits in the front passenger seat. This is a normal condition.

 **WARNING**

Riding in an improper position or placing weight on the front passenger's seat when it is unoccupied by a passenger adversely affects the OCS. To reduce the risk of serious injury or death:



- **NEVER** put a heavy load in the front seat or seatback pocket, or hang any items on the front passenger seat.



- **NEVER** place your feet on the front passenger seatback.



- **NEVER** sit with your hips shifted towards the front of the seat.



- **NEVER** ride with the seatback reclined when the vehicle is moving.



- **NEVER** place your feet or legs on the dashboard.



- **NEVER** lean on the door or center console or sit on one side of the front passenger seat.



- Do not sit on the passenger seat wearing heavily padded clothes such as ski wear and hip protector.



- Do not use car seat accessories such as thick blankets and cushions which cover up the car seat surface.

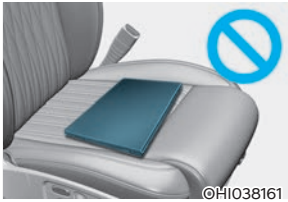

- Do not place electronic devices such as laptops, DVD player, or conductive materials such as water bottles on the passenger seat.
- Do not use electronic devices such as laptops and satellite radios which use inverter chargers.



- If large amount of liquid has been spilled on the passenger seat, the airbag warning light may illuminate or malfunction. Therefore, make sure the seat has been completely dried before driving the vehicle.

- Do not place sharp objects on the front passenger seat. These may damage the occupant detection system, if they puncture the seat cushion.
- Do not place any items under the front passenger seat.
- When changing or replacing the seat or seat cover, use original items only. The OCS has been developed based on using original HYUNDAI car seats only. Altering or changing the authentic parts may result in system malfunction and increase risk of injury when in collision. Any of the above could interfere with the proper operation of the OCS sensor thereby increasing the risk of an injury in an accident.



### Proper seated position for OCS

If the “PASSENGER AIR BAG OFF” indicator is on when an adult is seated in the front passenger seat, place the ignition switch in the LOCK/OFF position and ask the passenger to sit properly (sitting upright with the seat back in an upright position, centered on the seat cushion with their seat belt on, legs comfortably extended and their feet on the floor). Restart the engine and have the person remain in that position. This will allow the system to detect the person and to enable the passenger airbag. If the “PASSENGER AIR BAG OFF” indicator is still on, ask the passenger to move to the rear seat.

### **WARNING**

**NEVER** allow an adult passenger to ride in the front passenger seat when the “PASSENGER AIR BAG OFF” indicator is illuminated. During a collision, the airbag will not inflate if the indicator is illuminated. Have your passenger reposition themselves in the seat. If the “PASSENGER AIR BAG OFF” indicator remains illuminated after the passenger repositions themselves properly and the vehicle is restarted, have the passenger move to the rear seat because the airbag will not inflate.

### **NOTICE**

The “PASSENGER AIR BAG OFF” indicator generally illuminates for approximately 4 seconds after the ignition switch is in the ON position or after the engine is started.

However, if the ignition switch is turned to the ON position within 3 minutes after ignition OFF, the indicator does not illuminate. If the front passenger seat is occupied, the OCS will then classify the front passenger after several more seconds.

### ***Do Not Install a Child Restraint in the Front Passenger's Seat***



OHIO39193N

Even though your vehicle is equipped with the OCS, never install a child restraint in the front passenger's seat. An inflating airbag can forcefully strike a child or child restraint resulting in serious or fatal injury.

#### **WARNING**

- **NEVER** place a rear-facing or front-facing child restraint in the front passenger's seat of the vehicle.
- An inflating frontal airbag could forcefully strike a child resulting in serious injury or death.
- Always properly restrain children in an appropriate child restraint in the rear seat of the vehicle.

### **Why Didn't My Airbag Go Off in a Collision?**

Airbags are not designed to inflate in every collision. There are certain types of accidents in which the airbag would not be expected to provide additional protection. These include rear impacts, second or third collisions in multiple impact accidents, as well as low speed impacts. Damage to the vehicle indicates a collision energy absorption, and is not an indicator of whether or not an airbag should have inflated.

#### **WARNING**

**To reduce the risk of an airbag deploying unexpectedly and causing serious injury or death:**

- Do not hit or allow any objects to impact the locations where airbags or sensors are installed.
- Do not perform maintenance on or around the airbag sensors. If the location or angle of the sensors is altered, the airbags may deploy when they should not or may not deploy when they should.
- Do not install bumper guards or replace the bumper with a non-genuine HYUNDAI parts. This may adversely affect the collision and airbag deployment performance.
- Place the ignition switch in the LOCK/OFF or ACC position when the vehicle is being towed to prevent inadvertent airbag deployment.
- Have all airbag repairs performed by an authorized HYUNDAI dealer.

**Airbag collision sensors**

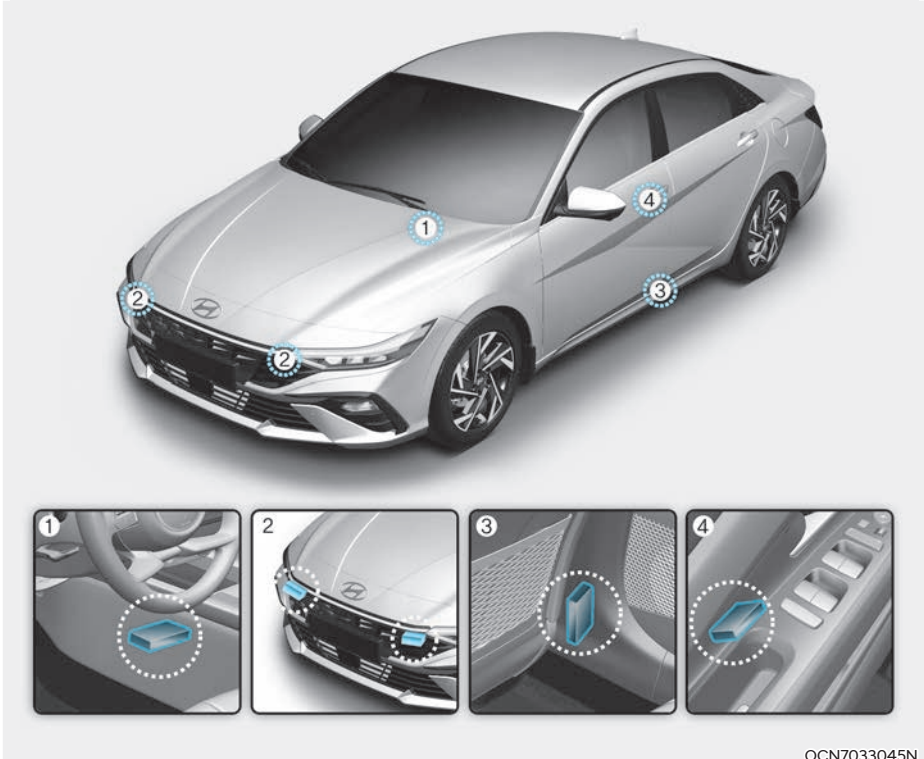

OCN7033045N

1. SRS control module/Rollover sensor
2. Front impact sensors
3. Side impact sensors (acceleration)
4. Side impact sensors (pressure)

## Airbag inflation conditions



### Front airbags

Front airbags are designed to inflate in a frontal collision depending on the severity of impact of the front collision.

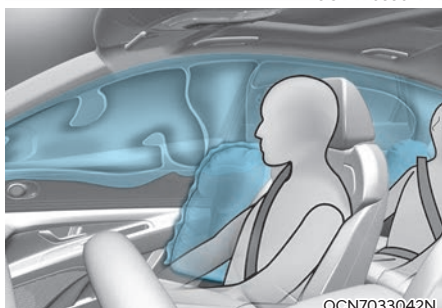
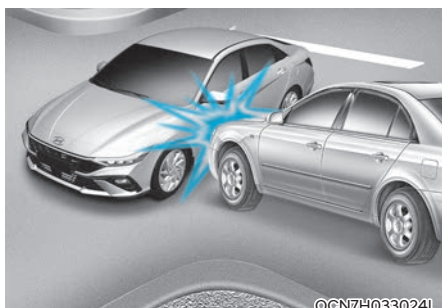

### Side and curtain airbags

Side and curtain airbags are designed to inflate when an impact is detected by side collision sensors depending on the severity of impact resulting from a side impact collision.

Although the driver's and front passenger's airbags are designed to inflate only in frontal collisions, they also may inflate in other types of collisions if the front impact sensors detect a sufficient impact. Side and curtain airbags are designed to inflate only in side impact collisions or rollover situations, but they may inflate in other collisions if the side impact sensors detect a sufficient impact.

If the vehicle chassis is impacted by bumps or objects on unimproved roads, the airbags may deploy. Drive carefully on unimproved roads or on surfaces not designed for vehicle traffic to prevent unintended airbag deployment.

### Airbag non-inflation conditions

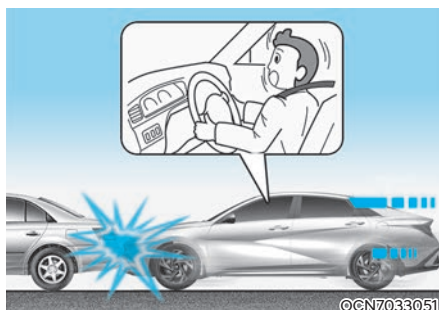

In certain low-speed collisions the airbags may not deploy. The airbags are designed not to deploy in such cases because they may not provide benefits beyond the protection of the seat belts.



Front airbags are not designed to inflate in rear collisions, because occupants are moved backward by the force of the impact. In this case, inflated airbags would not provide any additional benefit.

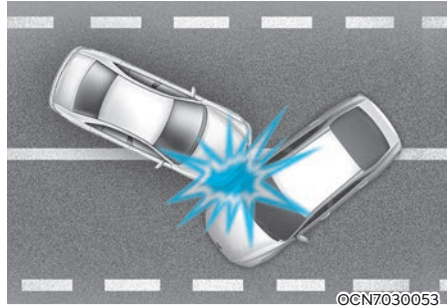

In an angled collision, the force of impact may direct the occupants in a direction where the airbags would not be able to provide any additional benefit, and thus the sensors may not deploy any airbags.

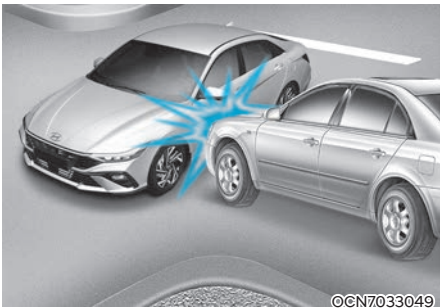

Front airbags may not inflate in side impact collisions, because occupants move in the direction of the collision, and thus in side impacts, front airbag deployment would not provide additional occupant protection.

However, side and curtain airbags may inflate depending on the severity of impact.

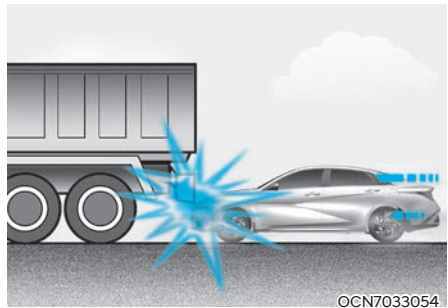

Just before impact, drivers often brake heavily. Such heavy braking lowers the front portion of the vehicle causing it to “ride” under a vehicle with a higher ground clearance. Airbags may not inflate in this “underride” situation because deceleration forces that are detected by sensors may be significantly reduced by such “underride” collisions.

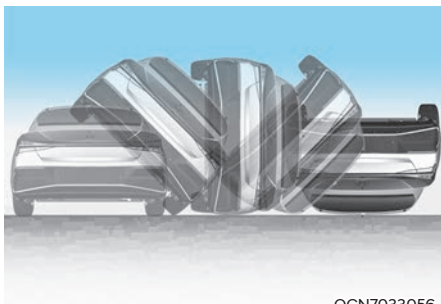

OCN7033056

Front airbags may not inflate in rollover accidents because airbag deployment may not provide protection to the occupants.

However, side and curtain airbags may inflate when the vehicle is rolled over by a side impact collision.

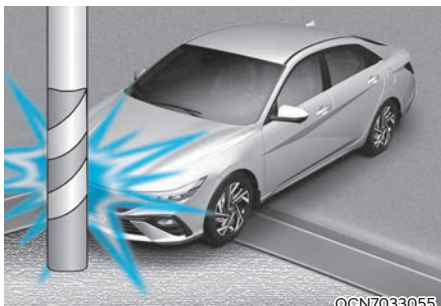

OCN7033055

Airbags may not inflate if the vehicle collides with objects such as utility poles or trees, where the point of impact is concentrated and the collision energy is absorbed by the vehicle structure.

## SRS Care

The SRS is virtually maintenance-free and there are no parts you can safely service by yourself. If the SRS airbag warning light does not illuminate when the ignition switch is in the ON position, or continuously remains on, have your vehicle immediately inspected by an authorized HYUNDAI dealer.

Any work on the SRS system, such as removing, installing, repairing, or any work on the steering wheel, the front passenger's panel, front seats and roof rails must be performed by an authorized HYUNDAI dealer. Improper handling of the SRS system may result in serious personal injury.



## WARNING

To reduce the risk of serious injury or death, take the following precautions:

- Do not attempt to modify or disconnect the SRS components or wiring, including the addition of any kind of badges to the pad covers or modifications to the body structure.
- Do not place objects over or near the airbag modules on the steering wheel, instrument panel, or the front passenger's panel above the glove box.
- Clean the airbag pad covers with a soft cloth moistened with plain water. Solvents or cleaners could adversely affect the airbag covers and proper deployment of the system.
- Always have inflated airbags replaced by an authorized HYUNDAI dealer.
- If components of the airbag system must be discarded, or if the vehicle must be scrapped, certain safety precautions must be observed. Consult an authorized HYUNDAI dealer for the necessary information. Failure to follow these precautions could increase the risk of personal injury.

### Additional Safety Precautions

**Passengers should not move out of or change seats while the vehicle is moving.** A passenger who is not wearing a seat belt during a crash or emergency stop can be thrown against the inside of the vehicle, against other occupants, or be ejected from the vehicle.

**Do not use any accessories on seat belts.** Devices claiming to improve occupant comfort or reposition the seat belt can reduce the protection provided by the seat belt and increase the chance of serious injury in a crash.

**Do not modify the front seats.** Modification of the front seats could interfere with the operation of the supplemental restraint system sensing components or side airbags.

**Do not place items under the front seats.** Placing items under the front seats could interfere with the operation of the supplemental restraint system sensing components and wiring harnesses.

**Do not cause impact to the doors.** Impact to the doors when the ignition switch is in the ON position may cause the airbags to inflate.

**Modifications to accommodate disabilities.** If you require modification to your vehicle to accommodate a disability, contact the HYUNDAI Customer Connect Center at 800-633-5151.

### ***Adding equipment to or modifying your airbag equipped vehicle***

If you modify your vehicle by changing your vehicle's frame, bumper system, front end or side sheet metal or ride height, this may affect the operation of your vehicle's airbag system.

### Airbag Warning Labels

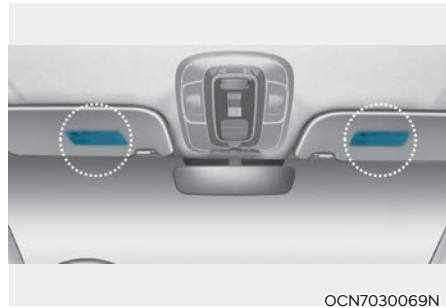

Airbag warning labels, required by the U.S. National Highway Traffic Safety Administration (NHTSA), are attached to alert the driver and passengers of potential risks of the airbag system. Be sure to read all of the information about the airbags that are installed on your vehicle in this Owners Manual.

# 4. Instrument Cluster

Instrument Cluster .....	4-4
Instrument Cluster Control.....	4-5
Adjusting instrument cluster illumination.....	4-5
Gauges and Meters .....	4-5
Speedometer .....	4-5
Power gauge .....	4-6
Hybrid battery SOC (State of Charge) gauge.....	4-6
Fuel gauge.....	4-7
Outside temperature gauge.....	4-8
Odometer .....	4-8
Range.....	4-9
Transmission Shift Indicator .....	4-9
Dual clutch transmission shift indicator.....	4-9
Warning and Indicator Lights .....	4-10
Ready indicator .....	4-10
EV mode indicator .....	4-10
Service warning light.....	4-10
Air Bag Warning Light.....	4-10
Seat Belt Warning Light.....	4-11
Parking Brake & Brake Fluid Warning Light.....	4-11
Regenerative brake warning light.....	4-11
Anti-lock Brake System (ABS) Warning Light.....	4-12
Electronic Brake Force Distribution (EBD) System Warning Light .....	4-12
Electronic Parking Brake (EPB) Warning Light.....	4-12
AUTO HOLD Indicator Light .....	4-13
Motor Driven Power Steering (MDPS) Warning Light .....	4-13
Malfunction Indicator Lamp (MIL).....	4-13
Driver Attention Warning light .....	4-14
Charging System Warning Light .....	4-14
Engine Oil Pressure Warning Light .....	4-14
Low Fuel Level Warning Light .....	4-15
Master Warning Light .....	4-15
Low Tire Pressure Warning Light .....	4-15
Electronic Stability Control (ESC) Indicator Light .....	4-16
Electronic Stability Control (ESC) OFF Indicator Light.....	4-16
Immobilizer Indicator Light.....	4-16
Immobilizer Indicator Light (with smart key).....	4-17
Turn Signal Indicator Light .....	4-17
Exterior Light Warning Light.....	4-17
LED headlight warning light.....	4-18
High Beam Indicator Light .....	4-18
Light ON Indicator Light.....	4-18

High Beam Assist indicator light.....	4-18
Forward Collision-Avoidance Assist Warning Light.....	4-18
Lane Safety indicator light .....	4-19
Cruise Indicator Light .....	4-19
SPORT Mode Indicator Light.....	4-19
SMART Mode Indicator Light .....	4-19
Icy Road Warning Light .....	4-19
Cluster Display Messages .....	4-20
Shift to P to start engine (for smart key system) .....	4-20
Shift to P (for smart key system and dual clutch transmission).....	4-20
Low key battery (for smart key system).....	4-20
Press brake pedal to start engine (for smart key system and dual clutch transmission) .....	4-20
Key not in vehicle (for smart key system).....	4-20
Key not detected (for smart key system).....	4-20
Press START button again (for smart key system) .....	4-20
12 V battery discharging due to additional electrical devices .....	4-21
Press START button with key (for smart key system) .....	4-21
Check BRAKE SWITCH fuse (for smart key system and automatic transmission/ intelligent variable transmission).....	4-21
Door, Hood, Trunk Open Indicator.....	4-21
Sunroof Open .....	4-21
Low Pressure .....	4-22
Lights Mode.....	4-22
Wiper .....	4-22
Heated Steering Wheel turned off.....	4-22
Low washer fluid .....	4-22
Low fuel .....	4-23
Engine Overheated .....	4-23
Check headlight .....	4-23
Check headlight (Low).....	4-23
Check turn signal light.....	4-23
Check brake light .....	4-23
Check daytime running light.....	4-24
Check high mounted stop light .....	4-24
Check headlight LED .....	4-24
Ready to start driving .....	4-24
Check regenerative brakes.....	4-24
Stop vehicle and check brakes .....	4-24
Check Hybrid system.....	4-25
Stop safely and check Hybrid system .....	4-25
Check Hybrid system. Do not start engine .....	4-25

# 4. Instrument Cluster

Stop safely and check power supply .....	4-25
Check virtual engine sound system.....	4-25
Refill inverter coolant .....	4-25
Park with engine On to charge battery .....	4-25
Start engine to avoid battery discharge.....	4-25
Cluster Display (Type A).....	4-26
Cluster Display Control .....	4-26
Cluster Display Modes .....	4-27
Trip computer mode.....	4-28
Turn By Turn (TBT) mode.....	4-28
Driving Assist mode.....	4-28
Master warning mode .....	4-29
User Settings Mode.....	4-30
Cluster Display (Type B).....	4-36
Cluster Display Control .....	4-36
Cluster Display Modes .....	4-37
Driving Assist group.....	4-38
Trip computer group.....	4-38
Turn By Turn (TBT) group.....	4-38
Master warning group .....	4-39
Trip Computer.....	4-40
Trip modes.....	4-40
Since refueling .....	4-41
Since Reset.....	4-41
Current trip.....	4-42
Energy flow .....	4-42
Digital speedometer .....	4-42
Vehicle Settings (Infotainment System).....	4-43
Setting Your Vehicle.....	4-43

## INSTRUMENT CLUSTER

■ Type A

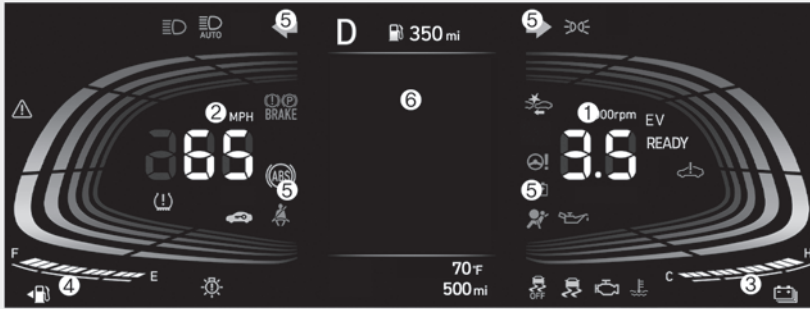

■ Type B

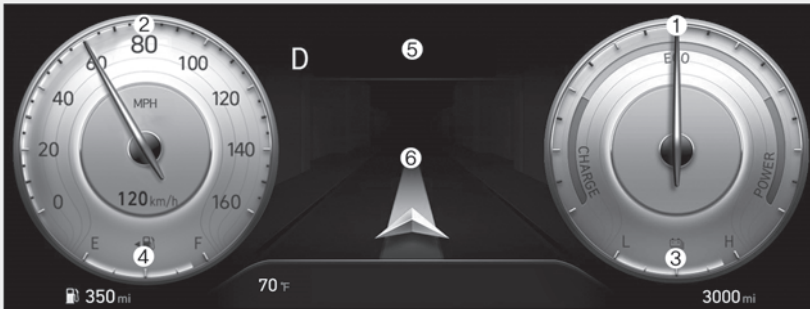

The actual cluster in the vehicle may differ from the illustration.  
For more information, refer to the "Gauges and Meters" in this chapter.

OCN7H043046N/OCN7H043047N

- |   |                                 |
|---|---------------------------------|
| 1. Hybrid system gauge                        | 4. Fuel gauge                   |
| 2. Speedometer                                | 5. Warning and indicator lights |
| 3. Hybrid Battery SOC (State of Charge) gauge | 6. Cluster display              |

## Instrument Cluster Control

### Adjusting instrument cluster illumination

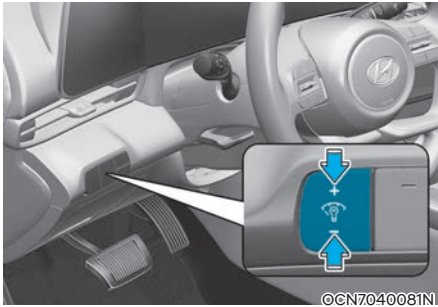

When the vehicle's parking lights or headlights are on, press the illumination control button to adjust the brightness of the instrument panel illumination.

When pressing the illumination control button, the interior switch illumination intensity is also adjustable.

- The brightness of the instrument panel illumination is displayed.
- If the brightness reaches the maximum or minimum level, a chime will sound.

### **WARNING**

**Never adjust the instrument cluster while driving. Doing so could lead to driver distraction which may cause an accident and lead to vehicle damage, serious injury, or death.**

## Gauges and Meters

### Speedometer

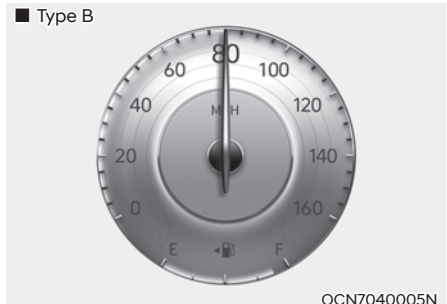
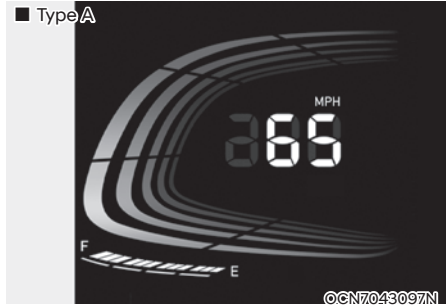

The speedometer indicates the speed of the vehicle and is calibrated in miles per hour (MPH) and/or kilometers per hour (km/h).

**Power gauge**

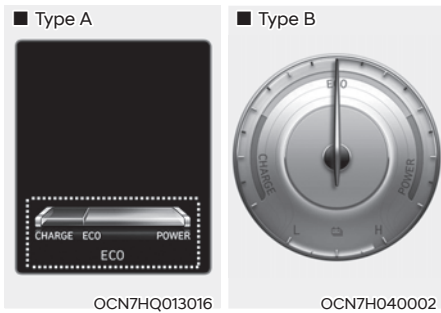

The power gauge indicates whether the current driving condition is fuel efficient or not.

- CHARGE : Shows that the energy made by the vehicle is being converted to electrical energy. (Regenerated energy)
- ECO : Shows that the vehicle is being driven in an Eco-friendly manner.
- POWER : Shows that the vehicle is exceeding the Eco-friendly range.

**i Information**

Accordance to the power gauge area the “EV” indicator comes on or off.

- “EV” indicator ON : Vehicle is driven using the electric motor or the gasoline engine is stopped.
- “EV” indicator OFF : Vehicle is driven using the gasoline engine.

**Hybrid battery SOC (State of Charge) gauge**

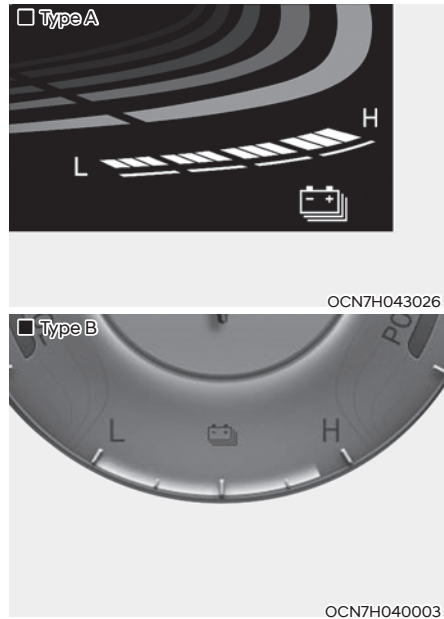

This gauge indicates the remaining hybrid battery power. If the SOC is near the “L (Low)” level, the vehicle automatically operates the engine to charge the battery.

However, if the Service Indicator (⚠️) and Malfunction Indicator Lamp (MIL) (🔧) turn on when the SOC gauge is near the “L (Low)” level, have the vehicle checked by an authorized HYUNDAI dealer.

**NOTICE**

**Never try to start the vehicle if the fuel tank is empty. In this condition, the engine cannot charge the high voltage battery of the hybrid system. If you try to start the vehicle when the fuel is empty, the high voltage battery will become discharged and be damaged.**

## Fuel gauge



The fuel gauge indicates the approximate amount of fuel remaining in the fuel tank.

## **i** Information

- The fuel tank capacity is given in chapter 2.
- The fuel gauge is supplemented by a low fuel warning light, which will illuminate when the fuel tank is nearly empty.
- More than 1.5 US gal (6 liters) of fuel should be added to the vehicle for the fuel gauge to increase.
- On inclines or curves, the fuel gauge pointer may fluctuate or the low fuel warning light may come on earlier than usual due to the movement of fuel in the tank.

## **⚠** CAUTION

If the shift gear is not in P (Park) or N (Neutral) during refueling, the refueling may not be recognized and the fuel amount and distance to empty may be displayed abnormally. (for dual clutch transmission)

## **⚠** WARNING

Running out of fuel can expose vehicle occupants to danger.

You must stop and obtain additional fuel as soon as possible after the warning light comes on or when the gauge indicator comes close to the "E (Empty)" level.

## **NOTICE**

Avoid driving with an extremely low fuel level. Running out of fuel could cause the engine to misfire and damage the catalytic converter.

### Outside temperature gauge

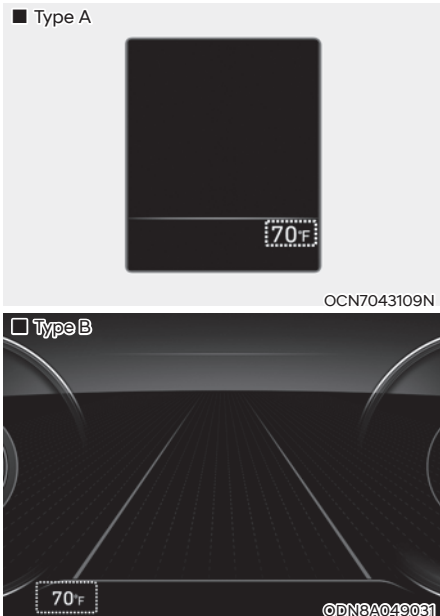

The outside ambient temperature appears in the lower portion of the cluster display. The temperature reads in Fahrenheit or Celsius depending on the units selected from the Settings menu in the instrument cluster or infotainment system.

The temperature indicated on the instrument cluster may not change as quickly as the outside temperature.

Select:

- **User Settings > Units > Temperature Unit > °F/°C** (for cluster type)
- **Setup > General > Units > Temperature Unit > °F/°C** (for infotainment system type)

Both the temperature unit on the instrument cluster and climate control information screen is changed.

### Odometer

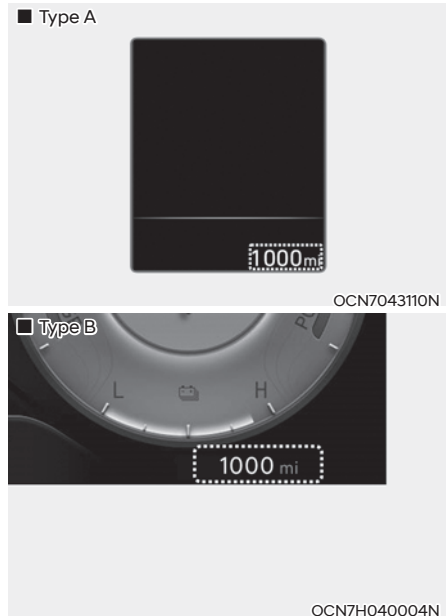

The odometer indicates the total distance that the vehicle has been driven and should be used to determine when periodic maintenance should be performed.

## Range

### ■ Type A



OCN7043111N

### ■ Type B



OCN7040016N

- The range is the estimated distance the vehicle can be driven with the remaining fuel.
- If the estimated distance is below 1 mi. (1 km), the trip computer will display "----" as range.



## CAUTION

If the shift gear is not 'P' (Park) or 'N' (Neutral) during refueling, the refueling may not be recognized and the fuel amount and distance to empty may be displayed abnormally.

## **i** Information

- If the vehicle is not on level ground or the battery power has been interrupted, the fuel amount and range function may not operate correctly.
- The range may differ from the actual driving distance as it is only an estimate of the available driving range for the vehicle and driving conditions.
- The trip computer may not register additional fuel if less than 1.6 US gal. (6 liters) of fuel are added to the vehicle.
- The range may vary significantly based on driving conditions, driving habits, and condition of the vehicle.

## Transmission Shift Indicator

### Dual clutch transmission shift indicator

### ■ Type A

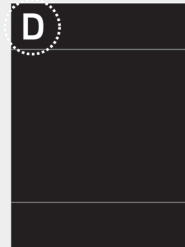

OIG046112

### ■ Type B

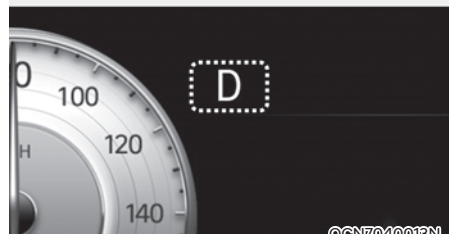

©CN7040013N

This indicator displays which shift lever position is selected.

## Warning and Indicator Lights

### Information

**Make sure that all warning lights are OFF after starting the engine. If any light is still ON, this indicates a situation that needs attention.**

#### **Ready indicator**

**READY**

**This indicator illuminates:**

When the vehicle is ready to be driven.

- ON : Normal driving is possible.
- OFF : Normal driving is not possible, or a problem has occurred.
- Blinking : Emergency driving.

When the ready indicator goes OFF or blinks, there is a problem with the system. If this occurs, have the vehicle inspected by an authorized HYUNDAI dealer.

#### **EV mode indicator**

**EV**

**This indicator illuminates:**

When the vehicle is driven by the electric motor.

Accordance to the power gauge area the “EV” indicator comes on or off.

- “EV” indicator ON : Vehicle is driven using the electric motor or the gasoline engine is stopped.
- “EV” indicator OFF : Vehicle is driven using the gasoline engine.

#### **Service warning light**



**This warning light illuminates:**

- When you set the ignition switch or the Engine Start/Stop button to the ON position.
  - The service warning light illuminates for approximately 3 seconds and then turns off when all checks have been performed.
- When there is a problem with the hybrid vehicle control system or hardware.

When the warning light illuminates while driving, or does not go OFF after starting the vehicle, have the vehicle inspected by an authorized HYUNDAI dealer.

#### **Air Bag Warning Light**



**This warning light illuminates:**

- When you place the ignition switch to the ON position.
  - The air bag warning light illuminates for about 6 seconds and then turns off when all checks have been performed
- The air bag warning light will remain illuminated if there is a malfunction with the Safety Restraint System (SRS) air bag operation.

In this case, have the vehicle inspected by an authorized HYUNDAI dealer.

### Seat Belt Warning Light



This warning light informs the driver that the seat belt is not fastened.

For more information, refer to “Seat Belts” in chapter 3.

### Parking Brake & Brake Fluid Warning Light



This warning light illuminates:

- When you place the ignition switch to the ON position.
  - The parking brake light illuminates for about 3 seconds and will then turn off once the parking brake is released.
- Whenever the parking brake is applied.
- Whenever the brake fluid level in the reservoir is low.
  - If the warning light illuminates with the parking brake released, it indicates that the brake fluid level in the reservoir is low.

**If the brake fluid level in the reservoir is low:**

1. Drive carefully to the nearest safe location and stop your vehicle.
2. With the engine stopped, check the brake fluid level immediately and add fluid as required (For more information, refer to "Brake Fluid" in chapter 9). After adding brake fluid, check all brake components for fluid leaks. If a brake fluid leak is found, or if the warning light remains on, or if the brakes do not operate properly, do not drive the vehicle. Have the vehicle inspected by an authorized HYUNDAI dealer.

### Dual-diagonal braking system

Your vehicle is equipped with dual-diagonal braking systems. This means you still have braking on two wheels even if one of the dual systems should fail.

With only one of the dual systems working, more than normal pedal travel and greater pedal pressure is required to stop the vehicle.

If the brakes fail while you are driving, shift to a lower gear for additional engine braking and stop the vehicle as soon as it is safe to do so.



### WARNING

#### Parking Brake & Brake Fluid Warning Light

**Driving the vehicle with a warning light ON is dangerous. If the Parking Brake & Brake Fluid Warning Light illuminates with the parking brake released, it indicates that the brake fluid level is low.**

**In this case, have the vehicle inspected by an authorized HYUNDAI dealer.**

#### Regenerative brake warning light



**This warning light illuminates:**

When the regenerative brake does not operate and the brake does not perform well. This causes the Brake Warning light (red) and Regenerative Brake Warning Light (yellow) to illuminate simultaneously.

If this occurs, drive safely and have the vehicle inspected by an authorized HYUNDAI dealer.

The operation of the brake pedal may be more difficult than normal and the braking distance may increase.

### Anti-lock Brake System (ABS) Warning Light

This warning light illuminates:

- When you place the ignition switch to the ON position.
  - The ABS warning light illuminates for about 3 seconds and then turns off.
- Whenever there is a malfunction with the ABS.

Note that the hydraulic braking system will still be operational even if there is a malfunction with the ABS.

### Electronic Brake Force Distribution (EBD) System Warning Light



These two warning lights illuminate at the same time while driving:

When the ABS and regular brake system may not work normally.

In this case, have the vehicle inspected by an authorized HYUNDAI dealer.

### WARNING

#### Electronic Brake Force Distribution (EBD) System Warning Light

When both ABS and Parking Brake & Brake Fluid Warning Lights are on, the brake system will not work normally and you may experience an unexpected and dangerous situation during sudden braking.

In this case, avoid high speed driving and abrupt braking.

Have the vehicle inspected by an authorized HYUNDAI dealer as soon as possible.

### Information - Electronic Brake Force Distribution (EBD) System Warning Light

When the ABS Warning Light is on or both ABS and Parking Brake & Brake Fluid Warning Lights are on, the speedometer, odometer, or tripmeter may not work. Also, the MDPS Warning Light may illuminate and the steering effort may increase or decrease.

In this case, have the vehicle inspected by an authorized HYUNDAI dealer as soon as possible.

### Electronic Parking Brake (EPB) Warning Light (if equipped) **EPB**

This warning light illuminates:

- When you place the ignition switch to the ON position.
  - The EPB warning light illuminates for approximately 3 seconds and then turns off.
- Whenever there is a malfunction with the EPB.

If this occurs, have the vehicle inspected by an authorized HYUNDAI dealer.

### Information

The Electronic Parking Brake (EPB) Warning Light may illuminate when the Electronic Stability control (ESC) Indicator Light comes on to indicate that the ESC is not working properly (This does not indicate malfunction of the EPB).

### ***AUTO HOLD Indicator Light (if equipped)***

**AUTO  
HOLD**

**This indicator light illuminates:**

- [White] When you activate the auto hold system by pressing the AUTO HOLD button.
- [Green] When you stop the vehicle completely by depressing the brake pedal with the auto hold system activated.
- [Yellow] When there is a malfunction with the auto hold system.

In this case, have the vehicle inspected by an authorized HYUNDAI dealer.

For more information, refer to “Auto Hold” in chapter 6.

### ***Motor Driven Power Steering (MDPS) Warning Light***



**This warning light illuminates:**

- When you place the ignition switch to the ON position.
  - The Motor Driven Power Steering Warning light illuminates for about 3 seconds and then goes off.
- Whenever there is a malfunction with the MDPS.

If this occurs, have the vehicle inspected by an authorized HYUNDAI dealer.

### ***Malfunction Indicator Lamp (MIL)***



**This warning light illuminates:**

- When you place the ignition switch to the ON position.
  - The malfunction indicator light illuminates for about 3 seconds and then goes off.
- Whenever there is a malfunction with either the emission control system or the engine or the vehicle powertrain. If this occurs, have the vehicle inspected by an authorized HYUNDAI dealer.

#### **NOTICE**

**Driving with the Malfunction Indicator Lamp (MIL) on may cause damage to the emission control system which could affect drivability and/or fuel economy.**

#### **NOTICE**

**If the Malfunction Indicator Lamp (MIL) illuminates, potential catalytic converter damage is possible which could result in loss of engine power.**

**In this case, have the vehicle inspected by an authorized HYUNDAI dealer as soon as possible.**

**If the oil pressure lowers due to insufficient engine oil, etc., the engine oil pressure warning light turns on and an enhanced engine protection system that limits the engine's power is activated. After that, engine warning light turns on if driving repeatedly and continuously.**

### ***Inattentive Driving Warning light (if equipped)***



This indicator light illuminates:

- When you set the ignition switch to the ON position.
- Yellow: When Driver Attention Warning is disabled or a malfunction is detected

If the yellow indicator light remains on after the front view camera has been uncovered or unblocked, have your vehicle inspected by an authorized HYUNDAI dealer.

This indicator light blinks:

- Yellow: Driver Attention Warning recommends to take a break

For more details, refer to "Driver Attention Warning (DAW)" in chapter 7.

### ***Charging System Warning Light***



When this warning light illuminates while the engine is running, the battery is not being charged. Immediately turn OFF all electrical accessories. Try not to use electrically operated controls, such as the power windows. Keep the engine running.

Have the vehicle inspected by an authorized HYUNDAI dealer as soon as possible.

### ***Engine Oil Pressure Warning Light***



This warning light illuminates:

When the engine oil pressure is low.

**If the engine oil pressure is low:**

1. Drive carefully to the nearest safe location and stop your vehicle.
2. Turn the engine off and check the engine oil level (For more information, refer to "Engine Oil" in chapter 2). If the level is low, add oil as required.

If the warning light remains on after adding oil or if oil is not available, have the vehicle inspected by an authorized HYUNDAI dealer as soon as possible.



### **WARNING**

**When oil pressure is restored to an optimal level, the oil pressure warning light and the protection system that limits engine power will turn off. Even if the oil pressure returns to normal, check the engine once again in a safe place.**

**NOTICE**

- If the engine is not turned OFF immediately after the Engine Oil Pressure Warning Light is illuminated, severe damage could occur.
- If the warning light stays on while the engine is running, it indicates that there may be serious engine damage or malfunction. In this case:
  1. Stop the vehicle as soon as it is safe to do so.
  2. Turn off the engine and check the oil level. If the oil level is low, fill the engine oil to the proper level.
  3. Start the engine again. If the warning light stays on after the engine has started, turn the engine off immediately. In this case, have the vehicle inspected by an authorized HYUNDAI dealer.

**Low Fuel Level Warning Light**

This warning light illuminates:

When the fuel tank is nearly empty. Add fuel as soon as possible.

**NOTICE**

Driving with the Low Fuel Level warning light on or with the fuel level below "E" can cause the engine to misfire and damage the catalytic converter.

**Master Warning Light**

This indicator light illuminates:

When there is a malfunction in operation in any of the following functions

- Forward Collision-Avoidance Assist malfunction
- Forward Collision-Avoidance Assist radar blocked (if equipped)
- Blind-Spot Collision-Avoidance Assist malfunction (if equipped)
- Blind-Spot Collision-Avoidance Assist radar blocked (if equipped)
- High Beam Assist malfunction (if equipped)
- Lamp malfunction (if equipped)
- Smart Cruise Control malfunction (if equipped)
- Tire Pressure Monitoring System (TPMS) malfunction (if equipped)

To identify the details of the warning, look at the instrument cluster.

**Low Tire Pressure Warning Light (if equipped)**

This warning light illuminates:

- When you place the ignition in the ON position.
  - It illuminates for approximately 3 seconds and then goes off.
- When one or more of your tires are significantly underinflated. (The location of the underinflated tires is displayed on the cluster display.)

For more information, refer to "Tire Pressure Monitoring System (TPMS)" in chapter 8.

This warning light remains ON after blinking for approximately 60 seconds, or repeatedly blinks ON and OFF in 3 second intervals:

When there is a malfunction with the TPMS.

In this case, have the vehicle inspected by an authorized HYUNDAI dealer as soon as possible.

For more information, refer to "Tire Pressure Monitoring System (TPMS)" in chapter 8.



### WARNING

#### Safe Stopping

- The TPMS cannot alert you to severe and sudden tire damage caused by external factors.
- If you notice any vehicle instability, immediately take your foot off the accelerator pedal, apply the brakes gradually with light force, and slowly move to a safe position off the road.

### Electronic Stability Control (ESC) Indicator Light



#### This indicator light illuminates:

- When you place the ignition switch to the ON position.
  - The Electronic Stability Control indicator light illuminates for about 3 seconds and then goes off.
- Whenever there is a malfunction with the ESC system.

If this occurs, have the vehicle inspected by an authorized HYUNDAI dealer.

#### This indicator light blinks:

- While the ESC is operating.

For more information, refer to "Electronic Stability Control (ESC)" in chapter 6.

### Electronic Stability Control (ESC) OFF Indicator Light



#### This indicator light illuminates:

- When you place the ignition switch to the ON position.
  - It illuminates for approximately 3 seconds and then goes off.
- When you deactivate the ESC system by pressing the ESC OFF button.

For more information, refer to "Electronic Stability Control (ESC)" in chapter 6.

### Immobilizer Indicator Light



#### This indicator light illuminates:

- When the vehicle detects the immobilizer in the key with the ignition switch in the ON position.
  - At this time, you can start the engine.
  - The indicator light goes off after starting the engine.

#### This indicator light blinks:

- When there is a malfunction with the immobilizer system.

If this occurs, have the vehicle inspected by an authorized HYUNDAI dealer.

### **Immobilizer Indicator Light (with smart key) (if equipped)**



**This indicator light illuminates for up to 30 seconds:**

When the vehicle detects the smart key in the vehicle with the Engine Start/Stop button in the ACC or ON position.

- Once the smart key is detected, you can start the engine.
- The indicator light goes off after starting the engine.

**This indicator light blinks for a few seconds:**

When the smart key is not in the vehicle.

- If the smart key is not detected, you cannot start the engine.

**This indicator light illuminates for 2 seconds and goes off:**

If the smart key is in the vehicle and the Engine Start/Stop button is ON, but the vehicle cannot detect the smart key.

In this case, have the vehicle inspected by an authorized HYUNDAI dealer.

**This indicator light blinks:**

When there is a malfunction with the immobilizer system.

In this case, have the vehicle inspected by an authorized HYUNDAI dealer.

### **Turn Signal Indicator Light**



**This indicator light blinks:**

When you operate the turn signal indicator stalk.

If any of the following occur, there may be a malfunction with the turn signal system.

- The turn signal indicator light illuminates but does not blink
- The turn signal indicator light blinks rapidly
- The turn signal indicator light does not illuminate at all

If any of these conditions occur, have your vehicle inspected by an authorized HYUNDAI dealer.

For more details, refer to “High Beam Assist (HBA)” in chapter 5.

### **Exterior Light Warning Light (if equipped)**



**This warning light illuminates:**

- When one of the exterior bulbs (headlight, DRL, turn signal light, stop light, etc) is not operating properly. One of the bulbs may need to be replaced.

### ***i* Information**

**Make sure to replace the burned out bulb with a new one of the same wattage rating.**

**LED headlight warning light (if equipped)**



This warning light illuminates:

- When you set the ignition switch to the ON position.
  - The LED headlight warning light illuminates for approximately 3 seconds and then goes off.
- Whenever there is a malfunction with the LED headlight.  
If this occurs, have your vehicle inspected by an authorized HYUNDAI dealer.

**NOTICE**

Continuous driving with the LED Headlight warning light on or blinking can reduce LED headlight life.

**High Beam Indicator Light**



This indicator light illuminates:

- When the headlights are on and in the high beam position.
- When the turn signal lever is pulled into the Flash-to-Pass position.

**Light ON Indicator Light**



This indicator light illuminates:

When the tail lights or headlights are on.

**High Beam Assist indicator light (if equipped)**



This indicator light illuminates:

When the High Beam is on with the light switch in the AUTO light position.

- White: When High Beam Assist is ready to operate.
- Green: When High Beam Assist is operating.

If your vehicle detects oncoming or preceding vehicles, High Beam Assist system will switch the high beam to low beam automatically.

For more information, refer to "High Beam Assist (HBA)" in chapter 5.

**Forward Collision-Avoidance Assist Warning Light**



This warning light illuminates:

When the ignition switch is in the ON position. It illuminates for about 3 seconds and then goes off.

- Yellow: When Forward Safety of Forward Collision-Avoidance Assist is deselected, disabled, or a malfunction is detected.

If the yellow warning light remains on after the sensor has been uncovered or unblocked when Forward Safety is set, have the vehicle inspected by an authorized HYUNDAI dealer.

This warning light blinks:

- Red: When Forward Safety function is operating.

For more information, refer to "Forward Collision-Avoidance Assist (FCA)" in chapter 6.

**Lane Safety indicator light**

**This indicator light illuminates:**

- Green: When Lane Keeping Assist operating conditions are satisfied.
- Grey: When Lane Keeping Assist operating conditions are not satisfied.
- Yellow: Whenever there is Disabled/ Malfunction with Lane Keeping Assist.

If the yellow indicator light remains on after the front view camera has been uncovered or unblocked, have your vehicle inspected by an authorized HYUNDAI dealer.

**This warning light blinks:**

- Green: When Lane Keeping Assist is operating.

For more information, refer to the "Lane Keeping Assist (LKA)" section in chapter 7.

**Cruise Indicator Light**

**This indicator light illuminates:**

- When the cruise control system is enabled.

For more details, refer to "Cruise Control System" in chapter 6.

**SPORT Mode Indicator Light (if equipped)**

**This indicator light illuminates:**

- When you select "SPORT" mode as drive mode.

For more details, refer to "Drive Mode Integrated Control System" in chapter 6.

**SMART Mode Indicator Light (if equipped)**

**This indicator light illuminates:**

- When you select "SMART" mode as drive mode.

For more details, refer to "Drive Mode Integrated Control System" in chapter 6.

**Icy Road Warning Light (if equipped)**

**This indicator light illuminates:**

This warning light is to warn the driver the road may be icy.

When the temperature on the outside temperature gauge is approximately below 40°F (4°C), the Icy Road Warning Light and Outside Temperature Gauge blinks and then illuminates. Also, the warning chime sounds 1 time.

The Icy Road Warning function can be activated or deactivated from the User Settings mode in the cluster LCD display.

**i Information**

**If the icy road warning light appears while driving, you should drive more attentively and safely, refraining from over-speeding, rapid acceleration, sudden braking or sharp turning, etc.**

## Cluster Display Messages

### ***Shift to P to start engine (for smart key system)***

This message is displayed if you try to start the engine in any other position except P (Park).



### **Information**

For your safety, start the engine with the gear shifted to P (Park).

### ***Shift to P (for smart key system and dual clutch transmission)***

This message is displayed if you try to turn off the engine without the shift lever in P (Park) position.

If this occurs, the Engine Start/Stop button turns to the ACC position (If you press the Engine Start/Stop button once more, it will turn to the ON position).

### ***Low key battery (for smart key system)***

This warning message is displayed if the battery of the smart key is discharged while changing the Engine Start/Stop button to the OFF position.

### ***Press brake pedal to start engine (for smart key system and dual clutch transmission)***

This warning message is displayed if the Engine Start/Stop button changes to the ACC position twice by pressing the button repeatedly without depressing the brake pedal.

You can start the vehicle by depressing the brake pedal and then pressing the Engine Start/Stop button.

### ***Key not in vehicle (for smart key system)***

This warning message is displayed if the smart key is not in the vehicle when you press the Engine Start/Stop button.

When attempting to start the vehicle, always have the smart key with you.

### ***Key not detected (for smart key system)***

This warning message is displayed if the smart key is not detected when you press the Engine Start/Stop button.

### ***Press START button again (for smart key system)***

This message is displayed if you were unable to start the vehicle when the Engine Start/Stop button was pressed.

If this occurs, attempt to start the engine by pressing the Engine Start/Stop button again.

If the warning message appears each time you press the Engine Start/Stop button, have your vehicle inspected by an authorized HYUNDAI dealer.

### **12 V battery discharging due to additional electrical devices**

This message is displayed if the 12 V battery voltage is weak due to any non-factory electrical accessories (ex. dashboard camera) while parking. Be careful that the battery is not discharged.

If the message appears after removing the non-factory electrical accessories, have the vehicle inspected by an authorized HYUNDAI dealer.

### **Press START button with key (for smart key system)**

This warning message is displayed if you press the Engine Start/Stop button while the warning message "Key not detected" is displayed.

At this time, the immobilizer indicator light blinks.

### **Check BRAKE SWITCH fuse (for smart key system and automatic transmission/intelligent variable transmission)**

This warning message is displayed if the brake switch fuse is disconnected.

You need to replace the fuse with a new one before starting the engine.

If that is not possible, you can start the engine by pressing the Engine Start/Stop button for 10 seconds in the ACC position.

### **Door, Hood, Trunk Open Indicator**



This warning is displayed if any door or the hood or the trunk is left open. The warning will indicate which door is open in the display.



### **CAUTION**

**Before driving the vehicle, you should confirm that the door/hood/trunk are fully closed. Also, check there is no door/hood/trunk open warning light or message displayed on the instrument cluster.**

### **Sunroof Open (if equipped)**



This warning is displayed if you turn off the engine when the sunroof is open. Close the sunroof securely before leaving your vehicle.

**Low Pressure**



This warning message is displayed if the tire pressure is low. The corresponding tire on the vehicle will be illuminated. For more information, refer to "Tire Pressure Monitoring System (TPMS)" in chapter 8.

**Lights Mode**

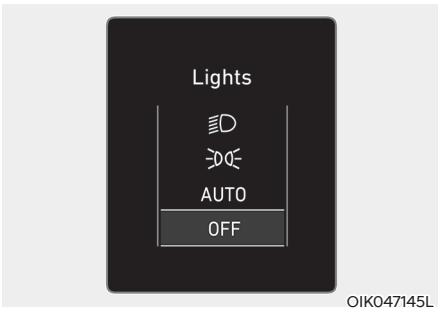

This indicator displays which exterior light is selected using the lighting control.

**Wiper**

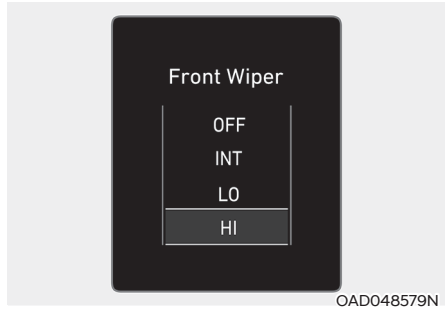

This indicator displays which wiper speed is selected using the wiper control.

**Heated Steering Wheel turned off (if equipped)**

This message is displayed if you turn off the heated steering wheel.

For more details, refer to "Heated Steering Wheel" in chapter 5.

**Low washer fluid (if equipped)**

This warning message is displayed if the washer fluid level in the reservoir is nearly empty.

Have the washer fluid reservoir refilled.

**Low fuel**

This warning message is displayed if the fuel tank is almost out of fuel.

When this message is displayed, the low fuel level warning light in the cluster will come on.

It is recommended to look for the nearest fueling station and refuel as soon as possible.

**NOTICE**

**Do not drive the vehicle with low fuel. Hybrid battery damage may occur when the fuel tank is completely empty.**

**Engine Overheated (if equipped)**

This warning message is displayed when the engine coolant temperature is above 248°F (120°C). This means that the engine is overheated and may be damaged.

If your vehicle is overheated, refer to “Overheating” in chapter 8.

**Check headlight (if equipped)**

This warning message is displayed if the headlights are not operating properly.

In addition, if a specific light (turn signal light etc.) is not operating properly, the warning message according to a specific light (turn signal light etc.) is displayed. A corresponding bulb may need to be replaced.

Make sure to replace the burned out bulb with a new one of the same wattage rating.

**Check headlight (Low) (if equipped)**

This warning message is displayed if the headlight (Low) are not operating properly.

In addition, if a specific light (turn signal light etc.) is not operating properly, the warning message according to a specific light (turn signal light etc.) is displayed. A corresponding bulb may need to be replaced.

Make sure to replace the burned out bulb with a new one of the same wattage rating.

**Check turn signal light (if equipped)**

This warning message is displayed if the turn signal lights are not operating properly. A light may need to be replaced.

Make sure to replace the burned out bulb with a new one of the same wattage rating.

**Check brake light (if equipped)**

This warning message is displayed if the stop lights are not operating properly. A light may need to be replaced.

Make sure to replace the burned out bulb with a new one of the same wattage rating.

***Check daytime running light (if equipped)***

This warning message is displayed if the daytime running lights are not operating properly. A light may need to be replaced.

Make sure to replace the burned out bulb with a new one of the same wattage rating.

***Check high mounted stop light (if equipped)***

This warning message is displayed if the high mounted stop light are not operating properly. A light may need to be replaced.

Make sure to replace the burned out bulb with a new one of the same wattage rating.

***Check headlight LED (if equipped)***

This warning message is displayed if there is a problem with the LED headlight. Have the vehicle inspected by an authorized HYUNDAI dealer.

***Ready to start driving***

This message is displayed when the vehicle is ready to be driven.

***Check regenerative brakes***

This message is displayed when the brake performance is low or the regenerative brake does not work properly due to a problem in the brake system.

If this occurs, it may take longer for the brake pedal to operate and the braking distance may become longer.

***Stop vehicle and check brakes***

This message is displayed when there is a problem in the brake system.

If this occurs, park the vehicle in a safe location and tow your vehicle to the nearest authorized HYUNDAI dealer and have the vehicle inspected.

**Check Hybrid system**

This message is displayed when there is a problem with the hybrid system. Refrain from driving when the warning message is displayed.

If this occurs, have the vehicle inspected by an authorized HYUNDAI dealer.

**Stop safely and check Hybrid system**

This message is displayed when there is a problem with the hybrid system. The "READY" indicator will blink and a warning chime will sound until the problem is solved. Refrain from driving when the warning message is displayed.

If this occurs, have the vehicle inspected by an authorized HYUNDAI dealer.

**Check Hybrid system. Do not start engine**

This message is displayed when the hybrid battery power (SOC) level is low. A warning chime will sound until the problem is solved. Refrain from driving when the warning message is displayed.

If this occurs, have the vehicle inspected by an authorized HYUNDAI dealer.

**Stop safely and check power supply**

This message is displayed when there is a problem in the power supply system.

If this occurs, park the vehicle in a safe location and tow your vehicle to the nearest authorized HYUNDAI dealer and have the vehicle inspected.

**Check virtual engine sound system**

This message is displayed when there is a problem with the Virtual Engine Sound System (VESS).

If this occurs, have the vehicle inspected by an authorized HYUNDAI dealer.

**Refill inverter coolant**

This message is displayed when the inverter coolant is nearly empty.

You should refill the inverter coolant.

**Park with engine On to charge battery**

This message is displayed when the hybrid battery power (SOC) level is low.

If this occurs, park the vehicle in a safe location and wait until the hybrid battery is charged.

**Start engine to avoid battery discharge**

This message is displayed to inform the driver the 12 V battery may be discharged if the ignition switch is in ON position (without the READY indicator ON).

Set the vehicle to the ready (READY) mode to prevent the 12 V battery from being discharged.

## CLUSTER DISPLAY (TYPE A)

### Cluster Display Control

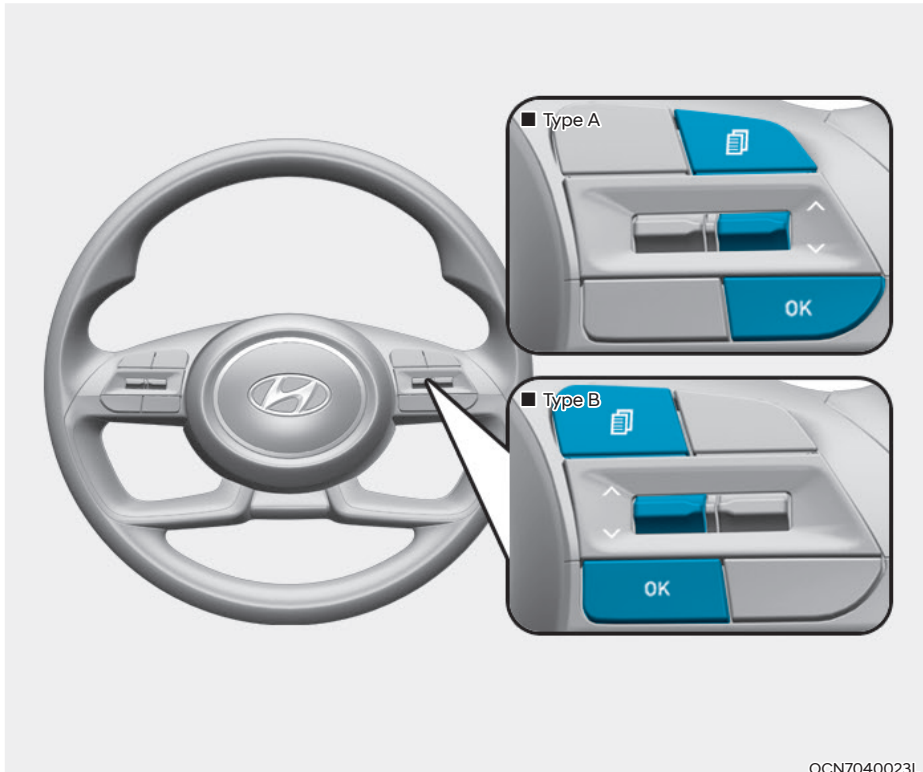

OCN7040023L





The cluster display modes can be changed by using the control buttons.

1. : MODE button for changing modes
2. , : MOVE switch for changing items
3. OK : Push the SELECT/RESET button for setting or resetting the selected item

### Information

**When the infotainment system is applied, only the User's Setting mode on the infotainment system is supported but the User's Setting mode on the instrument cluster is not supported.**

## Cluster Display Modes

Modes	Symbol	Explanation
Driving Assist		<ul style="list-style-type: none"> <li>- Smart Cruise Control</li> <li>- Lane Keeping Assist</li> <li>- Lane Following Assist</li> </ul>
Trip Computer		This mode displays driving information such as the tripmeter, fuel economy, etc. For more details, refer to "Trip Computer" in this chapter.
Turn By Turn (TBT)		This mode displays the state of the navigation.
User Settings		In this mode, you can change settings of the doors, lights, etc.
Warning		<ul style="list-style-type: none"> <li>- This mode displays warning messages related to the lamp malfunction, etc.</li> <li>- Tire pressure information</li> </ul>

**The information provided may differ depending on which functions are applicable to your vehicle.**

**Trip computer mode**

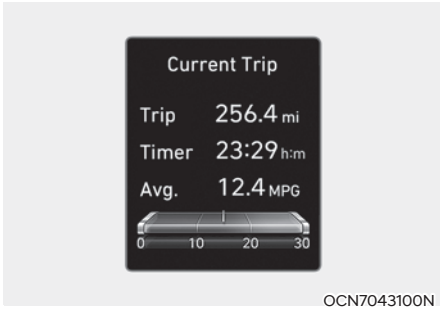

The trip computer mode displays information related to vehicle driving parameters including fuel economy, trip meter information and vehicle speed. For more information, refer to "Trip Computer" in this chapter.

**Turn By Turn (TBT) mode**

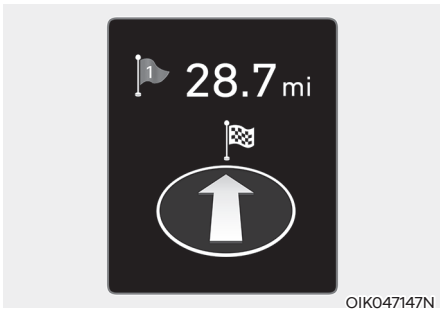

This mode displays the state of the navigation.

**Driving Assist mode**



**LKA/SCC**

This group displays the state of the Smart Cruise Control, Lane Keeping Assist. For more details, refer to each function information in chapter 7.

## Master warning mode

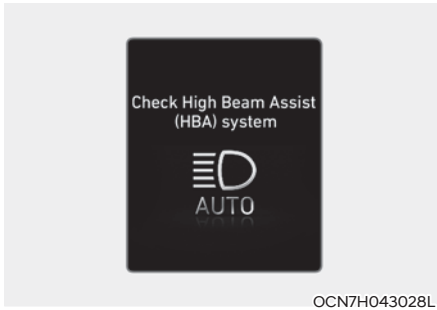

This warning light informs the driver the following situations.

- Forward Collision-Avoidance Assist malfunction (if equipped)
- Forward Collision-Avoidance Assist radar blocked (if equipped)
- Blind-Spot Collision-Avoidance Assist malfunction (if equipped)
- Blind-Spot Collision-Avoidance Assist radar blocked (if equipped)
- High Beam Assist malfunction (if equipped)
- Lamp malfunction (if equipped)
- Smart Cruise Control malfunction (if equipped)
- Tire Pressure Monitoring System (TPMS) malfunction (if equipped)

The Master Warning Light illuminates if one or more of the above warning situations occur. At this time, a Master Warning icon (⚠) will appear beside the User Settings icon (⚙), on the cluster display. (if equipped)

If the warning situation is solved, the master warning light will be turned off and the Master Warning icon will disappear.



## Tire Pressure

This mode displays information related to Tire Pressure.

For more information, refer to "Tire Pressure Monitoring System (TPMS)" in chapter 8.

### User Settings Mode



In this mode, you can change the settings of the instrument cluster, doors, lamps, etc.

1. Driver assistance
2. ECO Vehicle
3. Cluster
4. Lights
5. Door
6. Convenience
7. Units
8. Language
9. Reset

The information provided may differ depending on which functions are applicable to your vehicle.

#### Shift to P to edit settings / Engage parking brake to edit settings

This warning message illuminates if you try to select an item from the User Settings mode while driving.

- Dual clutch transmission  
For your safety, change the User Settings after parking the vehicle, applying the parking brake and moving the shift level to P(Park).

#### Quick guide (Help)

This mode provides quick guides for the systems in the User Settings mode.

Select an item, press and hold the OK button.

For more details about each system, refer to this Owner's Manual.

## 1. Driver Assistance

Items	Explanation
Driving Convenience	<ul style="list-style-type: none"> <li>Smart Cruise Control To set the Distance, Acceleration, Reaction Speed of Smart Cruise Control</li> </ul> For more details, refer to the "Smart Cruise Control (SCC)" in chapter 7.
Warning Methods	To adjust the warning methods of the driver assistance system. <ul style="list-style-type: none"> <li>Warning Volume: High/Medium/Low/Off</li> <li>Haptic Warning</li> </ul>
Driver Attention Warning	<ul style="list-style-type: none"> <li>Leading Vehicle Departure Alert To activate or deactivate the Leading vehicle departure alert.</li> </ul> For more details, refer to the "Driver Attention Warning (DAW)" in chapter 7.
Driving Safety	<ul style="list-style-type: none"> <li>Forward Safety To activate or deactivate the Forward Safety.</li> <li>Forward Safety Warning Timing To adjust the Forward Safety warning timing of the driver assistance system.</li> </ul> For more details, refer to "Forward Collision-Avoidance Assist (FCA) (Sensor fusion)" in chapter 7. <ul style="list-style-type: none"> <li>Lane Safety To activate or deactivate the Lane Safety.</li> </ul> For more details, refer to " Lane Keeping Assist (LKA)" in chapter 7. <ul style="list-style-type: none"> <li>Blind-Spot Safety To activate or deactivate the Blind-Spot Safety.</li> </ul> For more details, refer to " Blind-Spot Collision-Avoidance Assist (BCA)" in chapter 7. <ul style="list-style-type: none"> <li>Exit Safety To activate or deactivate the Exit Safety.</li> </ul> For more details, refer to " Safe Exit Warning (SEW)" in chapter 7
Parking Safety	<ul style="list-style-type: none"> <li>Rear Cross-Traffic Safety To activate or deactivate Rear Cross-Traffic Safety.</li> </ul> For more details, refer to "Rear Cross-Traffic Collision-Avoidance Assist(RCCA)" in chapter 7.

2. Cluster

Items	Explanation
Theme Selection	To activate or deactivate the service interval function. <ul style="list-style-type: none"> <li>CLASSIC A/CLASSIC B/CLASSIC C/CUBE</li> </ul>
Wiper/Lights Display	When the wiper switch or light switch is operated while the wiper/light mode display function is set, the selected position is temporarily displayed on the cluster. When it is off, it doesn't show up.
Traffic Signs	To activate or deactivate the traffic information. When activated, the traffic information will be displayed on the cluster display.
Icy Road Warning	To activate or deactivate the icy road warning function.
Cluster Voice Guidance Volume	To adjust the cluster voice guidance volume.
Welcome Sound	To activate or deactivate the welcome sound.

3. Lights

Items	Explanation
Illumination	To adjust the illumination level. <ul style="list-style-type: none"> <li>Level 1-20</li> </ul>
One Touch Turn Signal	<ul style="list-style-type: none"> <li>Off: The one touch turn signal function will be deactivated.</li> <li>3, 5, 7 Flashes: The turn signal indicator will blink 3, 5, or 7 times when the turn signal lever is moved slightly.</li> </ul> For more details, refer to “Exterior lights” in chapter 5.
Headlight Delay	<ul style="list-style-type: none"> <li>To activate or deactivate the headlight delay function.</li> </ul> For more details, refer to “Exterior lights” in chapter 5.
High Beam Assist	<ul style="list-style-type: none"> <li>To activate or deactivate the High Beam Assist function.</li> </ul> For more details, refer to “High beam assist (HBA)” in chapter 5.

#### 4. Door

Items	Explanation
Auto Lock	<ul style="list-style-type: none"> <li>• Enable on Shift: All doors will be automatically locked if the dual clutch transmission shift lever is moved from the P (Park) position to the R (Reverse), N (Neutral), or D (Drive) position. (Only when the engine is running)</li> <li>• Enable on Speed: All doors will be automatically locked when the vehicle speed exceeds 9.3 mph (15 km/h).</li> <li>• Disable: The auto door lock operation will be deactivated.</li> </ul>
Auto Unlock	<ul style="list-style-type: none"> <li>• On Shift to P: All doors will be automatically unlocked if the dual clutch transmission shift lever is moved to P (Park) position. (Only when the engine is running)</li> <li>• On key out/Vehicle Off: All doors will be automatically unlocked when the ignition key is removed from the ignition switch is set to the LOCK/OFF position.</li> <li>• Disable: The auto door unlock operation will be canceled.</li> </ul>
Two Press Unlock	<ul style="list-style-type: none"> <li>• Off: The two press unlock function will be deactivated. Therefore, all doors will unlock if the door unlock button is pressed.</li> <li>• On: Only the driver's door will unlock if the door unlock button is pressed. When the door unlock button is pressed again within 4 seconds, the remaining doors will unlock.</li> </ul>
Horn Feedback	<p>To activate or deactivate the horn feedback.</p> <p>If the horn feedback is activated, after locking the door by pressing the lock button on the remote key, and pressing it again within 4 seconds, the horn feedback sound will operate once to indicate that all doors are locked (if equipped with remote key).</p>
Smart Trunk	<p>To activate or deactivate the smart trunk.</p> <p>For more details, refer to "Smart trunk" in chapter 5.</p>

5. Convenience

Items	Explanation
Seat Easy Access	<ul style="list-style-type: none"> <li>Off: The seat easy access function is deactivated.</li> <li>Normal/Extended: When you turn off the engine, the driver's seat will automatically move rearward short (Normal) or long (Extended) for you to enter or exit the vehicle more comfortably.</li> </ul> <p>For more details, refer to "Integrated memory system" in chapter 5.</p>
Rear Occupant Alert	<ul style="list-style-type: none"> <li>To activate or deactivate the rear occupant alert system.</li> </ul> <p>For more details, refer to the "Rear Occupant Alert (ROA)" in chapter 5.</p>
Service Interval	<ul style="list-style-type: none"> <li>To activate or deactivate the service interval.</li> </ul> <p>When the 'Enable Service Interval' function is set, you can enter the mileage (km) and duration (months).</p>
Welcome Mirror/Light	<ul style="list-style-type: none"> <li>On door unlock: The side view mirrors are unfolded and the welcome light turns on automatically when the doors are unlocked.</li> <li>On driver approach: The side view mirrors are unfolded and the welcome light turns on automatically when the vehicle is approached with the smart key.</li> </ul> <p>For more details, refer to "Welcome system" in chapter 5.</p>
Wireless Charging System	<p>To activate or deactivate the wireless charging system in the front seat.</p> <p>For more details, refer to "Wireless cellular phone charging system" in chapter 5.</p>

## 6. Units

Items	Explanation
Speed Unit (if equipped)	To select the speed unit. (km/h, MPH)
Temperature Unit	To select the temperature unit. (°C, °F)
Fuel Economy Unit	To select the fuel economy unit. (km/L, L/100km, MPG)
Tire Pressure Unit	To select the tire pressure unit. (psi, kPa, bar)

## 7. Language (if equipped)

Items	Explanation
Language	Choose the language. You can choose the language in infotainment system. (if equipped)

## 8. Reset

Items	Explanation
Reset	You can reset the menus in the User Settings Mode. All menus in the User Settings Mode are reset to factory settings, except language and service interval.

## CLUSTER DISPLAY (TYPE B)

### Cluster Display Control

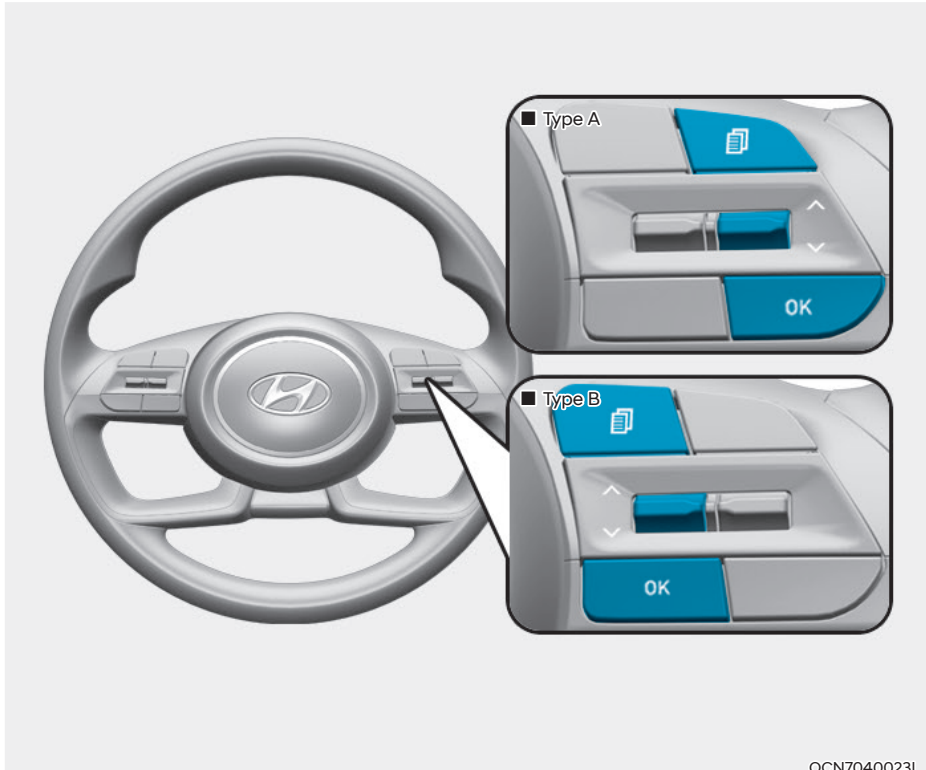

OCN7040023L





The cluster display modes can be changed by using the control buttons.

Switch	Operation	Function
	Tap	MODE button for changing view modes
	Tap	MOVE switch for changing items
OK	Tap	SELECT/RESET button for setting the selected item
	Tap and hold	SELECT/RESET button for retrieving assist information or resetting the selected item

### Information

When the infotainment system is applied, only the User's Setting mode on the infotainment system is supported but the User's Setting mode on the instrument cluster is not supported.

## Cluster Display Modes

Modes	Symbol	Explanation
Driving Assist		<ul style="list-style-type: none"> <li>• Lane Keeping Assist</li> <li>• Smart Cruise Control</li> <li>• Lane Following Assist</li> </ul>
Trip Computer		This mode displays driving information such as the tripmeter, fuel economy, etc. For more details, refer to "Trip Computer" in this chapter.
Turn By Turn (TBT)		This mode displays the state of the navigation.
Warning		This mode displays warning messages related to the lamp malfunction, tire pressure information & coolant temperature, etc.

**The information provided may differ depending on which functions are applicable to your vehicle.**

**Driving Assist group**

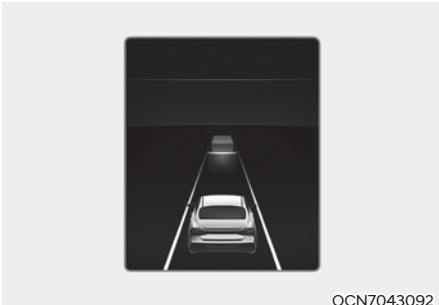

**SCC/HDA/LKA**

This group displays the state of Smart Cruise Control, Lane Following Assist and Highway Driving Assist.

For more details, refer to each function information in chapter 7.

**Trip computer group**

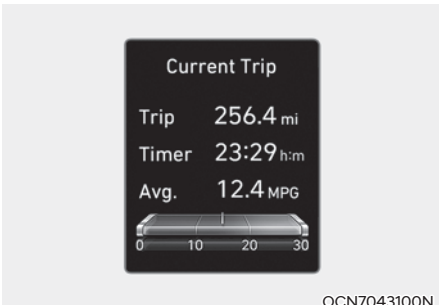

The trip computer group displays information related to vehicle driving parameters including fuel economy, tripmeter information and vehicle speed.

For more details, refer to "Trip computer" in this chapter.

**Turn By Turn (TBT) group**

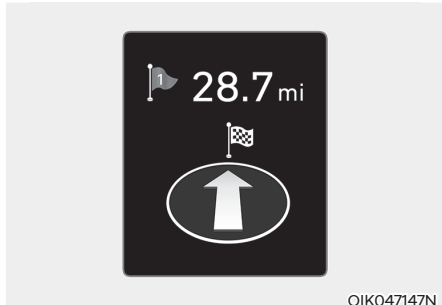

This group displays the state of the navigation.

## Master warning group

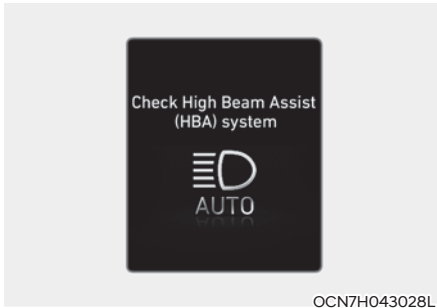

This warning light informs the driver the following situations.

- Forward Collision-Avoidance Assist system malfunction
- Forward Collision-Avoidance Assist radar blocked
- Blind-Spot Collision-Avoidance Assist system malfunction (if equipped)
- Blind-Spot Collision-Avoidance Assist radar blocked (if equipped)
- Lamp malfunction (if equipped)
- High Beam Assist malfunction
- Smart Cruise Control malfunction (if equipped)
- Tire Pressure Monitoring System malfunction (if equipped)

The Master Warning Light illuminates if one or more of the above warning situations occur.

At this time, a Master Warning icon (⚠) will appear beside the User Settings icon (⚙), on the cluster display.

If the warning situation is solved, the master warning light will be turned off and the Master Warning icon will disappear.



### Tire Pressure

This mode displays information related to Tire Pressure.

For more details, refer to "Tire pressure monitoring system (TPMS)" in chapter 8.



### Coolant temperature

This mode displays information of coolant temperature.

### Trip Computer

The trip computer is a microcomputer-controlled driver information system that displays information related to driving.

#### **i** Information

Some driving information stored in the trip computer (for example Average Vehicle Speed) resets if the battery connector is disconnected.

#### Trip modes

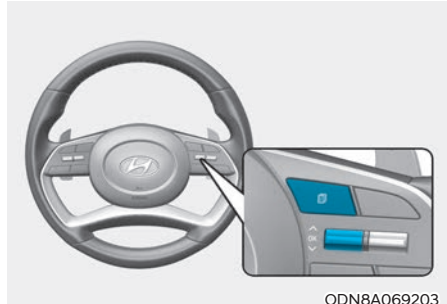
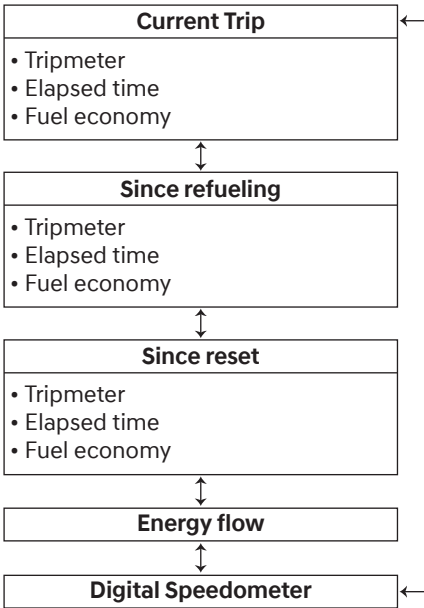

To change the trip mode, toggle the “” switch on the steering wheel.

Pressing the OK button for more than 1 second resets the displayed mode.

**Since refueling**

After the vehicle has been refueled, the trip distance, total driving time and average fuel economy appear.

To reset manually, press the **OK** button on the steering wheel for more than 1 second when "**Since Refueling**" appears.

**Since Reset**

Accumulated trip distance, total driving time, and average fuel economy appear. The information is accumulated starting from the last reset.

To reset manually, press the **OK** button on the steering wheel for more than 1 second when "**Since Reset**" appears.

### Current trip

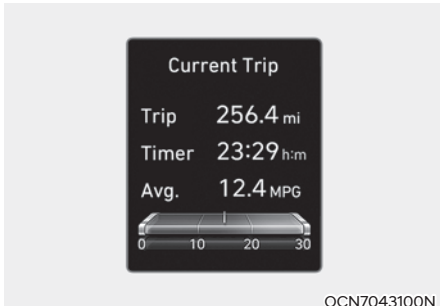

Current trip distance, total driving time, and average fuel economy appear. The information is combined for each ignition cycle. However, when the engine has been OFF for 4 hours or longer the Drive Info screen will reset. To manually reset the information, press and hold the OK button when viewing the Drive Info. The trip distance, the average fuel economy, and total driving time will reset simultaneously. The driving information will continue to be counted while the engine is still running (for example, when the vehicle is in traffic or stopped at a stop light).

### **i** Information

The vehicle must be driven for a minimum of 0.19 miles (300 meters) since the last ignition key cycle before the average fuel economy will be recalculated.

### Energy flow

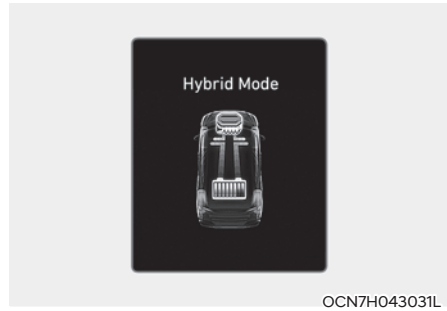

This mode displays the engine status for each area, such as the power transmission status of the hybrid system according to the driving condition, starting and accelerating, constant speed driving, and deceleration. For more details, refer to "Energy flow" in chapter 1.

### Digital speedometer

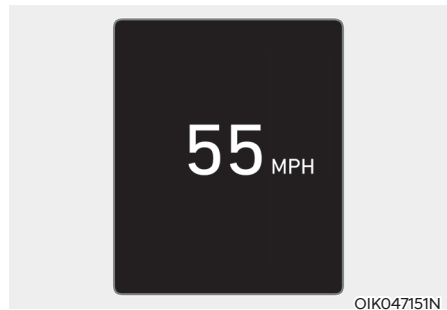

The digital speedometer display shows the speed of the vehicle.

## VEHICLE SETTINGS (INFOTAINMENT SYSTEM)

Vehicle Settings in the infotainment system provides user options for a variety of settings including door lock/unlock features, convenience features, driver assistance settings, etc.

Vehicle Settings menu

- Driver Assistance
- Cluster
- Climate
- Seat
- Lights
- Door
- Convenience

These options may differ depending on which functions are available on your vehicle.



### **WARNING**

**Do not operate the Vehicle Settings while driving. This may cause distraction resulting in an accident.**

## SETTING YOUR VEHICLE

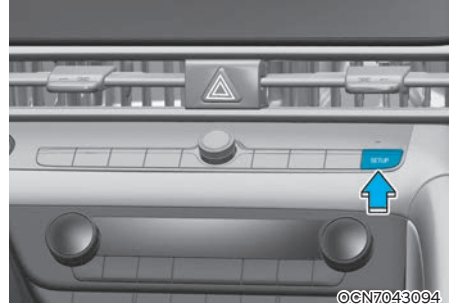

1. Press the SETUP button on the main keyboard.
2. Select **Vehicle** to change the Vehicle Settings.

The infotainment system may change after software updates. For more information, refer to the user's manual provided in the infotainment system and the quick reference guide.



# 5. Convenience Features

Accessing Your Vehicle.....	5-4
Remote Key.....	5-4
Smart Key.....	5-7
Immobilizer System .....	5-14
Hyundai Digital Key .....	5-16
Digital Key (Smartphone).....	5-16
Digital Key (Card Key).....	5-21
Used Vehicle/Digital Key Maintenance .....	5-26
Limitations of the System .....	5-26
Door Locks.....	5-27
Operating Door Locks from Outside the Vehicle .....	5-27
Operating Door Locks from Inside the Vehicle .....	5-29
Automatic Door Lock and Unlock Features.....	5-31
Child-Protector Rear Door Locks .....	5-31
Rear Occupant Alert (ROA) .....	5-32
Rear Occupant Alert Operation.....	5-32
Theft-Alarm System .....	5-33
Driver Position Memory System .....	5-34
Storing Memory Positions .....	5-34
Recalling Memory Positions.....	5-34
Resetting Integrated Memory System.....	5-35
While Resetting the Integrated Memory System.....	5-35
Seat Easy Access Operation .....	5-36
Steering Wheel.....	5-37
Motor Driven Power Steering (MDPS) .....	5-37
Tilt Steering / Telescope Steering .....	5-38
Horn.....	5-39
Mirrors .....	5-40
Inside Rearview Mirror.....	5-40
Side View Mirrors .....	5-48
Windows.....	5-50
Power Windows.....	5-51
Sunroof .....	5-55
Sunshade .....	5-55
Tilt Open/Close.....	5-56
Slide Open/Close .....	5-56
Automatic Reversal .....	5-57
Resetting the Sunroof .....	5-58
Sunroof Open Warning .....	5-58

Hood .....	5-59
Trunk .....	5-61
Opening the Trunk.....	5-61
Emergency Trunk Safety Release.....	5-62
Smart Trunk with Auto Open .....	5-63
Fuel Filler Door.....	5-66
Opening the Fuel Filler Door .....	5-66
Closing the Fuel Filler Door .....	5-67
Exterior Lights .....	5-69
Lighting Control.....	5-69
High Beam Operation .....	5-70
Turn Signals and Lane Change Signals .....	5-71
Battery Saver Function .....	5-71
Headlight Delay Function .....	5-72
Daytime Running Light (DRL).....	5-72
High Beam Assist (HBA) .....	5-73
High Beam Assist Settings.....	5-73
High Beam Assist Operation.....	5-74
High Beam Assist Malfunction and Limitations .....	5-74
Interior Lights.....	5-76
Interior Lights Auto Off .....	5-76
Front Lamps.....	5-76
Room Lamp .....	5-77
Luggage Compartment Lamp.....	5-78
Vanity Mirror Lamp.....	5-78
Welcome System.....	5-79
Wipers and Washers .....	5-80
Windshield Wipers .....	5-80
Windshield Washers.....	5-81
Automatic Climate Control System .....	5-82
Automatic Heating and Air Conditioning .....	5-83
Manual Heating and Air Conditioning .....	5-84
System Operation.....	5-90
System Maintenance .....	5-92
Windshield Defrosting and Defogging .....	5-94
Automatic Climate Control System.....	5-94
Defogging Logic .....	5-95
Auto Defogging System.....	5-96
Defroster .....	5-97

# 5. Convenience Features

Climate Control Additional Features .....	5-98
Sunroof Inside Air Recirculation.....	5-98
Auto Comfort Control (for driver's seat) .....	5-98
Automatic Ventilation .....	5-98
Storage Compartment.....	5-99
Center Console Storage.....	5-99
Glove Box.....	5-99
Interior Features.....	5-100
Cup Holder.....	5-100
Sunvisor .....	5-101
Power Outlet.....	5-101
USB Charger .....	5-102
Wireless Cellular Phone Charging System .....	5-103
Clock .....	5-105
Clothes Hanger.....	5-105
Infotainment System .....	5-106
USB Port.....	5-106
Antenna.....	5-107
Steering Wheel Audio Control.....	5-108
Infotainment System .....	5-109
Voice Recognition .....	5-109
Bluetooth® Wireless Technology hands-free .....	5-109
How Vehicle Radio Works.....	5-110

## ACCESSING YOUR VEHICLE

### Remote Key (if equipped)



Your HYUNDAI uses a remote key, which you can use to lock or unlock the driver and passenger doors or the rear trunk.

- (1) Door Lock
- (2) Door Unlock
- (3) Trunk Unlock
- (4) Panic

#### **Locking (1)**

To lock your vehicle:

1. Make sure all doors, the engine hood and the trunk are closed.
2. Press the Door Lock button (1) on the remote key to lock all doors.
3. The doors will lock and the hazard warning lights will blink.
4. Make sure the doors are locked by checking the position of the door lock button inside the vehicle.

#### **WARNING**

Do not leave the keys in your vehicle with unsupervised children. Unattended children could place the key in the ignition switch and may operate power windows or other controls, or even make the vehicle move, which could result in serious injury or death.

#### **Unlocking (2)**

To unlock your vehicle:

1. Press the Door Unlock button (2) on the remote key.
2. The driver's door will unlock. The hazard warning lights will blink two times.

#### **Two press unlock setting:**

If you press the Door Unlock button on the remote key again within four seconds, then all the doors will unlock.

Two press unlock setting can be changed according to owner's preference in the cluster User Settings mode.

#### **User settings mode method:**

You can activate or deactivate the Two Press Unlock feature from the Settings menu in the instrument cluster.

Select: **User Settings > Door > Two Press Unlock**

#### **Information**

After unlocking the doors, the doors will automatically relock after 30 seconds unless a door is opened.

### Opening the trunk (3)

To unlock the trunk :

1. Press and hold the Trunk Unlock button (3) on the remote key for more than one second.
2. The hazard warning lights will blink two times and the trunk will be unlocked.
3. Once the trunk is opened and then closed, the trunk will automatically lock.



### Information

The word “HOLD” is written on the button to inform you that you must press and hold the button for more than one second.

### Using panic alarm (4)

Press and hold the Panic button (4) for more than one second. The horn sounds and hazard warning lights flash for about 30 seconds.

To cancel the panic mode, press any button on the remote key.

### Starting the vehicle

For information, refer to the “Key Ignition Switch” section in chapter 6.

### NOTICE

To prevent damaging the remote key:

- Keep the remote key away from water or any liquid and fire. Internal circuits may malfunction if the inside of the remote key gets damp (from liquids or moisture) or if it is heated. This can exclude the remote key from being covered under warranty.
- Avoid dropping or throwing the remote key.
- Protect the remote key from extreme temperatures.

### Mechanical key

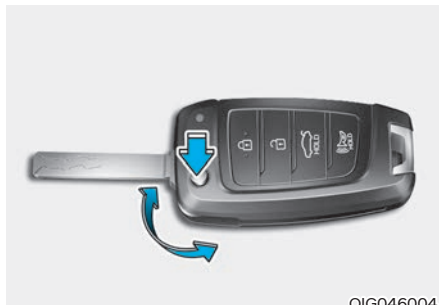

If the remote key does not operate normally, you can lock or unlock the driver's door by using the mechanical key.

To unfold the mechanical key, press the release button on the remote.

To return the key to its stored position, press the release button and fold the key back into the remote.

### Remote key precautions

The remote key will not work if any of the following occur:

- The key is in the ignition switch.
- You exceed the operating distance limit (about 33 feet [10 m]).
- The remote key battery is weak.
- Other vehicles or objects may be blocking the signal.
- The weather is extremely cold.
- The remote key is close to a radio transmitter such as a radio station or an airport which can interfere with normal operation of the remote key.

If the remote key does not work correctly, open and close the door with the mechanical key. If you have a problem with the remote key contact an authorized HYUNDAI dealer.

If the remote key is in close proximity to your mobile phone, the signal could be blocked by your mobile phone's normal operational signals. This is specifically relevant when the phone is active such as making and receiving calls, text messaging, and/or sending/receiving emails.

When possible, avoid placing the remote key and your mobile phone in the same location such as a pants or jacket pocket in order to avoid interference between the two devices.

### **i** Information

This device complies with Part 15 of the FCC rules.

Operation is subject to the following three conditions:

1. This device may not cause harmful interference.
2. This device must accept any interference received, including interference that may cause undesired operation.
3. Changes or modifications not expressly approved by the party responsible for compliance could void the user's authority to operate the device.

### **NOTICE**

Keep the remote key away from electromagnetic materials that block electromagnetic waves to the key surface.

### **Battery replacement**



If the remote key is not working properly, try replacing the battery with a new one.

Battery Type: CR2032

To replace the battery:

1. Insert a slim tool into the slot and gently pry open the cover.
2. Using a screw driver, remove the battery cover.
3. Remove the old battery and insert the new battery. Make sure the battery position is correct. An improperly positioned battery may discharge the battery, causing smart key failure.
4. Reinstall the battery cover and key cover in the reverse order of removal.

If you suspect your remote key might have sustained some damage, or you feel your remote key is not working correctly contact an authorized HYUNDAI dealer.

### **WARNING**

**THIS PRODUCT CONTAINS A BUTTON BATTERY.**

**If swallowed, a lithium button battery can cause severe or fatal injuries within 2 hours. Keep batteries out of reach of children.**

**If you think batteries may have been swallowed or placed inside any part of the body, seek immediate medical attention.**

## **i** Information



An inappropriately disposed battery can be harmful to the environment and human health. Dispose of the battery according to your local law(s) or regulation.

## Smart Key (if equipped)

### ■ Type A



OCN7053005

### ■ Type B



OCN7053004

Your HYUNDAI uses a smart key, which you can use to lock or unlock a door (and trunk) and even start the engine even just carrying the key.

- (1) Door Lock
- (2) Door Unlock
- (3) Trunk Open
- (4) Panic
- (5) Remote Start (if equipped)

## Locking your vehicle (1)

### Button type

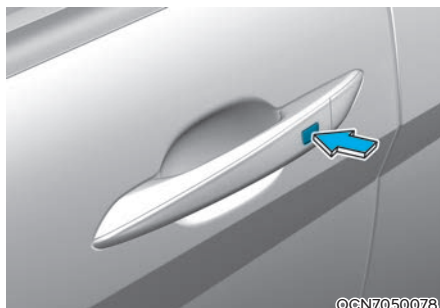

OCN7050078

1. Close all doors, engine hood and trunk.
2. Have the smart key with you.
3. Press the door handle button or press the Door Lock button (1) on the smart key. The chime sounds and hazard warning lights blink. Also, the side view mirrors fold if **On door unlock** or **On driver approach** is selected from the Settings menu in the instrument cluster or infotainment system (if equipped).
4. Make sure the doors are locked by pulling the door outside handle.

## **i** Information

**The door handle button will only operate when the smart key is within 28~40 inches (0.7~1 m) from the outside door handle.**

### Touch sensor type

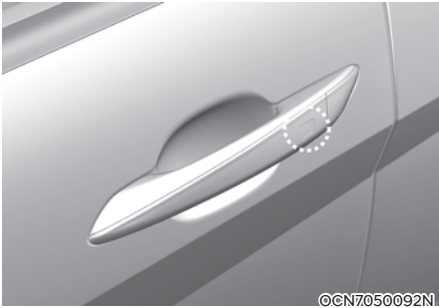

1. Close all doors, engine hood and trunk.
2. Have the smart key with you.
3. Touch the outer part of the door handle on or near the handle detent for about 1 second or until you hear the door locks actuate. The chime sounds and hazard warning lights blink. Also, the side view mirrors fold if **On door unlock** or **On driver approach** is selected from the Settings menu in the instrument cluster or infotainment system (if equipped).
4. Make sure the doors are locked by pulling the door outside handle.

### **i** Information

- The door handle button will only operate when the smart key is within 28~40 inches (0.7~1 m) from the outside door handle.
- If you locked the door with the touch sensor on the door handle, the doors cannot be unlocked with the sensor within 3 seconds.

### **i** Information

Even though you press the outside door handle button or touch the touch sensor, the doors will not be locked and the chime will sound for 3 seconds if any of the following occurs:

- The Smart Key is in the vehicle
- The Engine Start/Stop button is in ACC or ON position.
- Any door except the trunk is opened.

### **!** CAUTION

When you leave your vehicle with the smart key, make sure to press the button on the front door handle or touch the touch sensor on the front door handle to lock the doors after closing all of the doors, the hood and the trunk. If you do not press the button or touch the touch sensor firmly, the doors might not be locked so please use caution.

### **!** WARNING

Do not leave the Smart Key in your vehicle with unsupervised children. Unattended children could press the Engine Start/ Stop button and may operate power windows or other controls, or even make the vehicle move, which could result in serious injury or death.

## Unlocking your vehicle (2)

### Button type

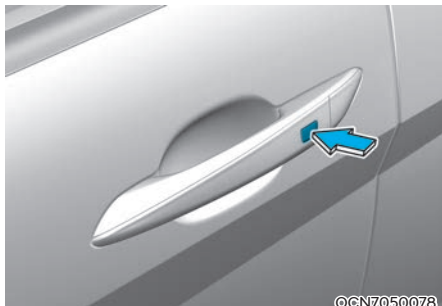

To unlock:

1. Have the smart key with you.
2. Press the door handle button or press the Door Lock button (2) on the smart key. The chime sounds and hazard warning lights blink two times. Also, the side view mirrors unfold if **On door unlock** or **On driver approach** is selected from the Settings menu in the instrument cluster or infotainment system (if equipped).
  - If you unlock the doors using the passenger side door handle, all the doors are unlocked. If you unlock the doors using the driver side door handle, either the driver's side door is unlocked or all the doors are unlocked depending on the setting for the Two Press Unlock feature. Change the Driver Door unlock mode by referring to "Setting the Two Press Unlock feature".

### Touch sensor type

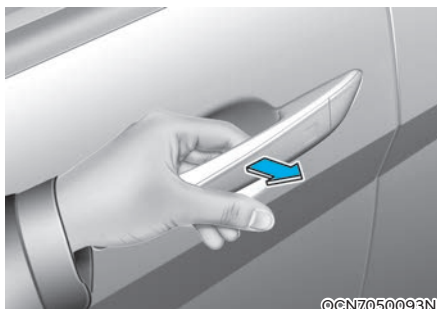

To unlock:

1. Have the smart key with you.
2. Grab the door handle to activate the door unlock touch sensor. The chime sounds and hazard warning lights blink two times. Also, the side view mirrors unfold if **On door unlock** or **On driver approach** is selected from the Settings menu in the instrument cluster or infotainment system (if equipped).
  - If you unlock the doors using the passenger side door handle, all the doors are unlocked. If you unlock the doors using the driver side door handle, either the driver's side door is unlocked or all the doors are unlocked depending on the setting for the Two Press Unlock feature. Change the Driver Door unlock mode by referring to "Setting the Two Press Unlock feature".

### **i** Information

- The door handle button or touch sensor only operates when the smart key is within 28-40 in. (0.7-1 m) from the outside door handle.
- After unlocking the doors, the doors are locked automatically after 30 seconds unless a door is opened.

### Two Press Unlock Feature

You can activate or deactivate the Two Press Unlock feature from the Settings menu in the instrument cluster or infotainment system. Select:

- **User Settings > Door > Two Press Unlock** (for instrument cluster type)
- **Settings > Vehicle > Door > Two Press Unlock** (for infotainment system type)

### **i** Information

- **For more information on the cluster type Settings menu, refer to the “Cluster display (Type A)” section in chapter 4.**
- **The infotainment system may change after software updates. For more information, refer to the user’s manual provided in the infotainment system and the quick reference guide.**

### Setting the door lock/unlock prevention feature

The doors may lock or unlock if the touch sensor of the outside door handle is recognized while washing your vehicle or due to heavy rain.

To prevent unintentional door lock or unlock:

Press the lock button on the smart key and immediately press the unlock button along with the lock button for more than 4 seconds. The hazard warning lights blink four times. At this time, the doors do not lock or unlock even though the touch sensor is touched on the outside door handle. To deactivate the function, press the door lock or unlock button on the smart key.

### **i** Information

- **During a car wash or rain, in order to minimize unintentional operation of the touch sensor, the touch sensor may become insensitive. This is not a malfunction.**
- **The doors may not lock or unlock in the following situations.**
  - **If the touch sensor is touched with gloves on.**
  - **If the door is suddenly approached.**

### **Unlocking the trunk (3)**

To open:

1. Make sure you have the smart key in your possession.
2. Press the trunk open/close button on the vehicle or press and hold the trunk Open button (3) on the smart key for more than 1 second. The hazard warning lights blink twice and the trunk is unlocked.
3. Pull up on the trunk to open.

### **Using panic alarm (4)**

The horn sounds and the hazard warning lights blink for about 30 seconds if this button (4) is pressed for more than 1 second. To stop the horn and lights, press any button on the smart key.

### ***Remotely starting the vehicle (5) (if equipped)***

You can start the engine and turn on the climate system by pressing the remote start button (5) outside the vehicle.

To start and stop engine remotely :

1. Press the door lock button (1), and then the hazard warning lights blink once to alert you.
2. Press the Remote Start button (5) for more than 2 seconds to start the engine within 4 seconds after pressing the door lock button (1).
3. If you want to stop the engine, press the Remote Start button (5) again.

In case of the manual operation, the climate control system will be maintained even when the engine is turned OFF. However, the automatic operation is set to 72°F (22°C).

If someone without a designated smart key attempts to drive your vehicle after you remotely started it, the engine will be stopped.

### ***i* Information**

**After remotely starting the vehicle, the engine will turn off after 10 minutes if the vehicle is not driven.**



### **CAUTION**

- **The remote start will not work if you exceed the operating distance limit (about 33 ft. (10 m)).**
- **Avoid idling the engine for prolonged periods to follow the emission regulations in your locality.**
- **Laws in your locality may restrict the use of remote start. You should check locality regulations before using this remote starting system.**
- **It is only possible to start the engine remotely when shifted to P (Park).**
- **If the hood or the trunk is opened, you cannot start the engine remotely.**



### **Information**

**If the smart key is not moved for some time, the detection function for smart key operation will pause. Lift the smart key to activate the detection again.**

### Starting the vehicle

You can start the engine without inserting the key.

For detailed information refer to the Engine Start/ Stop button in chapter 6.

### **i** Information

If the smart key is not moved for some time, the detection function for smart key operation will pause. Lift the smart key to activate the detection again.

### **NOTICE**

To prevent damaging the smart key:

- Keep the smart key away from water or any liquid and fire. If the inside of the smart key gets damp (due to drinks or moisture), or is heated, internal circuit may malfunction and may void the vehicle warranty.
- Avoid dropping or throwing the smart key.
- Protect the smart key from extreme temperatures.

### **NOTICE**

Always have the smart key with you when leaving the vehicle. If the smart key is left near the vehicle, the vehicle battery may be discharged.

### Mechanical key

If the Smart Key does not operate normally, you can lock or unlock the driver's door by using the mechanical key.

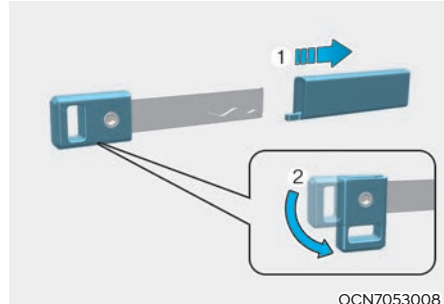

Turn the knob (2) of the mechanical key after removing the key protector (1).

After using the mechanical key, turn the key knob (2) and insert the key protector (1).

### Loss of a smart key

A maximum of two Smart Keys can be registered to a single vehicle. If you happen to lose your smart key, you should immediately take the vehicle and remaining keys to your authorized HYUNDAI dealer or tow the vehicle, if necessary.

### Smart key precautions

The smart key may not work if any of the following occur:

- The smart key is close to a radio transmitter such as a radio station or an airport which can interfere with normal operation of the transmitter.
- The smart key is near a mobile two way radio system or a cellular phone.
- Another vehicle's smart key is being operated close to your vehicle.
- If your windows are tinted, especially with metallic window tint, it may cause frequency interference, reducing the smart key operating range.

- Make sure the smart key battery is inserted in the correct polarity before use. Using an improperly positioned battery may cause smart key failure or premature discharge of the battery.

If the smart key does not work correctly, open and close the door with the mechanical key. If you have a problem with the smart key, contact an authorized HYUNDAI dealer.

If the smart key is in close proximity to your mobile phone, the signal could be blocked by your mobile phone's normal operational signals. This is specifically relevant when the phone is active such as making and receiving calls, text messaging, and/or sending/receiving emails. When possible, avoid keeping the smart key and your mobile phone in the same location such as pants or jacket pocket in order to avoid interference between the two devices.

### **i** Information

This device complies with Part 15 of the FCC rules.

Operation is subject to the following three conditions:

1. This device may not cause harmful interference, and
2. This device must accept any interference received, including interference that may cause undesired operation.
3. Changes or modifications not expressly approved by the party responsible for compliance could void the user's authority to operate the device.

### **NOTICE**

Keep the smart key away from electromagnetic materials that blocks electromagnetic waves to the key surface.

### **Battery replacement**

Battery Type: CR2450

To replace the battery:



2C\_RemoveSmartKeyCover

1. Put the slim tool into the key hole (1) to pry open the rear cover of the smart key.

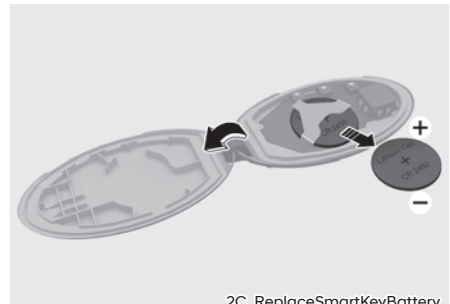

2C\_ReplaceSmartKeyBattery

2. Remove the old battery and insert the new battery. Make sure the battery position is correct. An improperly positioned battery may discharge the battery, causing smart key failure.
  3. Reinstall the rear cover of the smart key.
- If you suspect your smart key might have sustained some damage, or you feel your smart key is not working correctly, contact an authorized HYUNDAI dealer.



**WARNING**

**THIS PRODUCT CONTAINS A BUTTON BATTERY.**

**If swallowed, a lithium button battery can cause severe or fatal injuries within 2 hours. Keep batteries out of reach of children.**

**If you think batteries may have been swallowed or placed inside any part of the body, seek immediate medical attention.**



**Information**



**An inappropriately disposed battery can be harmful to the environment and human health. Dispose of the battery according to your local law(s) or regulation.**

**Immobilizer System**

The immobilizer system protects your vehicle from theft. If an improperly coded key (or other device) is used, the engine's fuel system is disabled.

When the ignition switch is placed in the ON position, the immobilizer system indicator should come on briefly, then go off. If the indicator starts to blink, the system does not recognize the coding of the key.

Turn the ignition switch to the LOCK/OFF position, then turn the ignition switch to the ON position again.

In some circumstances, the vehicle may not recognize your smart key if another smart key device is nearby or a metal object such as a key chain is causing interference with the smart key.

If this occurs, your vehicle may not start. Remove any metal objects or additional keys near the smart key before attempting to start the vehicle again.

If the system repeatedly does not recognize the coding of the key, contact your HYUNDAI dealer.

Do not attempt to alter this system or add other devices to it. Electrical problems could result that may make your vehicle inoperable.



**WARNING**

**In order to prevent theft of your vehicle, do not leave spare keys anywhere in your vehicle. Your immobilizer password is a customer unique password and should be kept confidential.**

**.NOTICE**

The transponder in your key is an important part of the immobilizer system. It is designed to give years of trouble-free service, however you should avoid exposure to moisture, static electricity and rough handling. Immobilizer system malfunction could occur.

**Information**

This device complies with Part 15 of the FCC rules.

Operation is subject to the following three conditions:

1. This device may not cause harmful interference.
2. This device must accept any interference received, including interference that may cause undesired operation.
3. Changes or modifications not expressly approved by the party responsible for compliance could void the user's authority to operate the device

## HYUNDAI DIGITAL KEY

Hyundai digital key provides convenience to the driver, which the driver can use to lock or unlock the driver and passenger doors or the trunk and turn on the vehicle.

### Digital Key (Smartphone)

#### **i** Information

- Hyundai digital keys are only available on smartphone that support digital key functions, and digital key functions of smartphones are provide by smartphone manufacturers.
- Available smartphone brands and models can be found on smartphone manufactures' website or HYUNDAI website.
- Depending on the availability of service on the vehicle, some functions may not operated.

#### Setting your smartphone

To use the digital key (smartphone), download the Bluelink App and sign up Hyundai account and service.

For more information about Bluelink, refer to the infotainment system guide.

#### Registering your digital key (smartphone)

1. Turn on the vehicle with a smart key and have your smart key with you in the vehicle.
2. After selecting **Digital Key > Set Up Digital Key** from the My Hyundai App in the smartphone, register the digital key according to the guidance in the smartphone screen.

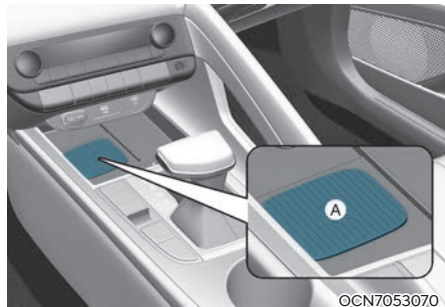

[A]: Wireless charging pad

- Place your smartphone on the vehicle authentication pad (wireless charging pad) with the screen facing up.
- When the digital key (smartphone) is saved, a message appears on the infotainment system screen.

## Information



- The NFC Antenna position on Samsung device can be found in the following path: **Settings > Connections > NFC and contactless payments.**
- The NFC Antenna position on Google Pixel phone can be found in the following path: **Settings > Connected devices > Connection preference > NFC.**
- The NFC Antenna position on Apple iPhone is located at the top of the rear and Apple WATCH is located at the center of the screen.
- Ensure that the NFC Antenna position on the smartphone is in contact with the vehicle authentication pad (wireless charging pad).
- The location of the NFC Antenna on the smartphone may vary by phone model, so please contact the smartphone manufacturer for details.
- NFC communication may not work for some smartphones depending on the internal structure of the smartphone. Move the smartphone to the left or right of the indoor authentication pad (wireless charging pad) to operate.

## To register the digital key (smartphone) from the infotainment system

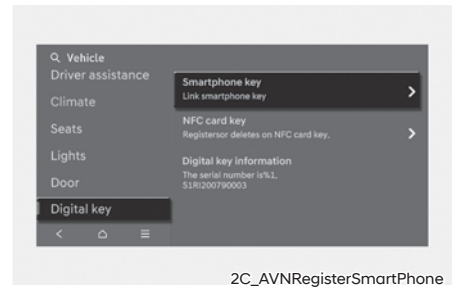

If you cannot register the digital key (smartphone) with the My Hyundai app, try registering from the infotainment system.

1. Turn off the vehicle, and then turn on the vehicle with a smart key and have your smart key with you in the vehicle.
2. Put the gear in P (Park), from the infotainment system Settings menu, select **Settings > Vehicle > Digital key > Smartphone key** and press the **Save** button.
3. Place your smartphone on the vehicle authentication pad (wireless charging pad) with the screen facing up.
  - When the digital key (smartphone) is saved, a message appears on the infotainment system screen.

**i** Information

- If you want to register a different digital key (smartphone), refer to the “Deleting your digital key (smartphone)” and delete the digital key (smartphone) before re-registering. An active Digital Key can be shared through the My Hyundai app with a different smartphone.
- During the digital key saving process, the process may cancel when:
  - The smartphone is removed from the vehicle authentication pad (wireless charging pad)
  - The infotainment system screen is changed
  - The engine is turned off
  - The gear is shifted
- The registering process does not start if a smart key is not in the vehicle.
- Some smartphones may not start the registering process depending on the internal structure. Move the smartphone to the left or right on the vehicle authentication pad (wireless charger pad) and try registering the smartphone.

**Using the digital key (smartphone)**

The driver can lock or unlock the door by placing the smartphone on the outside door handle, and the vehicle can be started by placing the smartphone on the vehicle authentication pad (wireless charging pad).

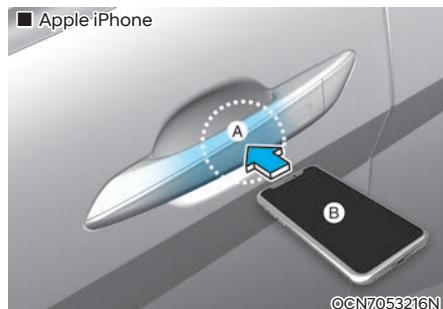
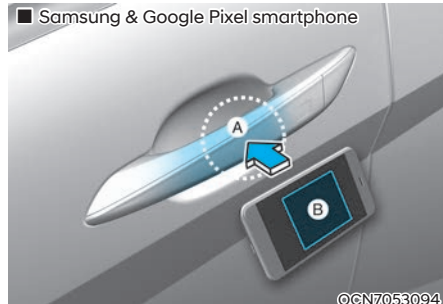

[A]: Door handle authentication pad  
[B]: NFC Antenna

**i** Information

- The location of the NFC Antenna on the smartphone may vary by phone model, so please contact the smartphone manufacturer for details.
- The NFC Antenna position on Samsung device can be found in the following path: Setup > Connections > NFC and contactless payments.
- The NFC Antenna position on Google Pixel phone can be found in the following path: Settings > Connected devices > Connection preference > NFC.



The NFC Antenna position on Apple iPhone is located at the top of the rear [A] and Apple WATCH is located at the center of the screen [B].

- Touch the Door handle NFC Antenna position with the back of your smartphone.

#### Locking/Unlocking the doors

- If the driver places the digital key (smartphone) NFC antenna to the driver's or passenger's door handle authentication pad (A) for more than 2 seconds, the door locks or unlocks.
- After unlocking the doors, the doors are automatically re-lock after 30 seconds unless a door is opened.
- If the smartphone digital key does not operate, try again after moving the smartphone away from the door handle authentication pad (more than 4 in. (0.1 m)).

#### Information

You cannot lock your vehicle using the digital key (smartphone) if any of the following occurs:

- The smart key is in the vehicle.
- The Engine Start/Stop button is in the ACC or ON position.
- Any of the doors are open.

#### Starting the vehicle

After placing your registered digital key (smartphone) on the vehicle authentication pad (wireless charging pad), depress the brake pedal and press the Engine Start/Stop button.

After starting the vehicle, the digital key (smartphone) may be removed from the vehicle authentication pad (wireless charging pad).

For more details on the basic way to start the vehicle, refer to the "Push button start ignition switch" section in chapter 6.

#### Information

If a shared digital key (smartphone) is used for the first time, the activating time may take longer.

- Place the shared digital key (smartphone) on the door handle authentication pad until the vehicle door lock/unlock activates.
- If a shared digital key (smartphone) is first used on the vehicle authentication pad (wireless charger pad), the initial start of the vehicle may fail.
- If the door lock/unlock is activated once with the shared digital key (smartphone) or the vehicle is started with the digital key (smartphone) on the vehicle authentication pad, the digital key (smartphone) is registered in the vehicle.

#### WARNING

The vehicle can be started when the registered smartphone is placed on the vehicle authentication pad (wireless charging pad). Therefore, do not leave unsupervised children or people who are not aware of the system since it can result in serious injury or death. In addition, always have the registered smartphone with you to prevent vehicle theft when leaving the vehicle.

### Deleting your digital key (smartphone)

Turn on the vehicle with a smart key. Have your smart key with you in the vehicle.

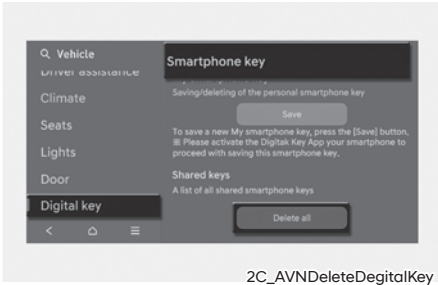

### Deleting all registered digital key (smartphone)

To delete all the registered digital key (smartphone), from the Settings menu select **Setup > Vehicle > Digital Keys > Smartphone key > Delete all** in the infotainment system.

- The “Delete all” button is disabled if there is no registered digital key (smartphone).

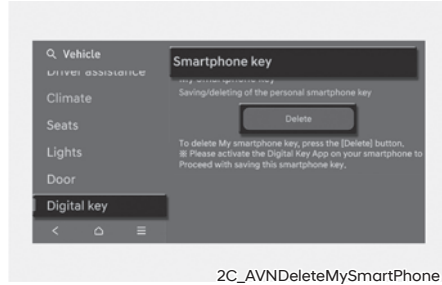

### Deleting my registered digital key (smartphone)

To delete only my registered digital key (smartphone), from the Settings menu select **Setup > Vehicle > Digital Keys > Smartphone key > My Smartphone Key > Delete** in the infotainment system.

- If a shared digital key (smartphone) is registered, it cannot be deleted.
- A new smartphone can be registered after deleting the existing digital key (smartphone) from “My Smartphone Key” menu.

### Information

- If the registered digital key (smartphone) is deleted, the digital key saved in the smartphone is also deleted.
- If the digital key is deleted from the smartphone, the digital key registered in the vehicle is also deleted.
- The shared digital key registered in the vehicle cannot be deleted individually.
- Even though the Blue Link® App is deleted from the smartphone, the digital key saved in the smartphone is not deleted.
- Management of the digital key saved in the smartphone is available from the Digital Key App provided by the smartphone manufacturer.

## How to register digital key (Card Key)

To use the card key as a digital key, follow the following procedure.

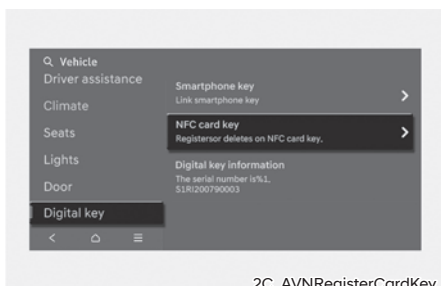

[A]: Vehicle authentication pad  
(Wireless charging pad)

1. Have both of your smart keys with you in the vehicle.
2. Select **Setup > Vehicle > Digital Keys > NFC Card Key** from the Settings menu, and check whether “Use” is selected in the infotainment system.
3. Place your card key on the vehicle authentication pad (wireless charging pad) while the engine is on.
4. Register your card key by selecting **Setup > Vehicle > Digital Keys > NFC Card Key > Save** from the Settings menu in the infotainment system.

## i Information

- Only one digital key (card key) can be registered to the vehicle. If it must be replaced, delete the existing card key before registering the new card key.
- To register a digital key (card key), both of your smart keys must be in the vehicle.
- Once a digital key (card key) is registered, it cannot be registered in another vehicle. It is possible to re-register it to the original vehicle.

## Using the digital key (card key)

The driver can lock or unlock the door by placing the card key on the outside door handle, and the vehicle can be started by placing the card key on the vehicle authentication pad (wireless charging pad).

## Locking/Unlocking the doors

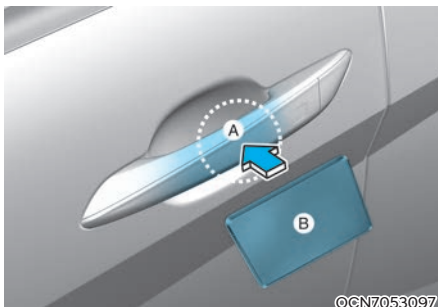

[A]: Door handle authentication pad

[B]: Card key NFC Antenna

If the driver places the digital key (card key) to the driver's or passenger's door handle authentication pad (A) for more than 2 seconds, the door locks or unlocks.

After unlocking the doors, the doors are automatically re-locked after 30 seconds unless a door is opened.

**i** Information

You cannot lock your vehicle using the digital key (card key) if any of the following occurs:

- The smart key is in the vehicle.
- The Engine Start/Stop button is in the ACC or ON position.
- Any of the doors are open.

Starting the vehicle

After placing your registered digital key (card key) on the vehicle authentication pad (wireless charging pad), depress the brake pedal and press the Engine Start/Stop button.

For more information on the basic way to start the vehicle, refer to the “Push button start ignition switch” section in chapter 6.

**!** WARNING

The vehicle can be started when the registered card key is placed on the vehicle authentication pad (wireless charging pad). Therefore, do not leave unsupervised children or people who are not aware of the system since it can result in serious injury or death. In addition, always have the registered card key with you to prevent vehicle theft when leaving the vehicle.

**i** Information

- The digital key (card key) may not work under the following conditions:
  - The digital key (card key) is not placed on the door handle authentication pad or vehicle authentication pad (wireless charging pad) correctly.
  - The digital key (card key) is near NFC-enabled cards such as credit cards or smartphones.
  - If the digital key (card key) does not work, try again after moving the digital key (card key) away from the door handle authentication pad (more than 4 in. (0.1 m)).
- The digital key (card key) can be damaged by impacts. If the digital key (card key) is damaged, replace the digital key (card key) with a new one and register it again.
- Long-time exposure to high temperature may cause the digital key (card key) to malfunction. Be careful not to expose the digital key (card key) to direct sunlight or high temperature.
- Leaving the digital key (card key) on the in-vehicle authentication pad (wireless charging pad) while driving may cause the digital key (card key) to malfunction. Remove the digital key (card key) from the in-vehicle authentication pad (wireless charging pad) after starting the vehicle.
- Keep the digital key (card key) away from the smartphone when charging the smartphone. If the digital key (card key) is placed between the smartphone and the in-vehicle authentication pad (wireless charging pad) while the smartphone is being charged, the digital key (card key) may malfunction. For example, when charging smartphone while the digital key (card key) is attached to the back of the smartphone case.

## Deleting your digital key (card key)

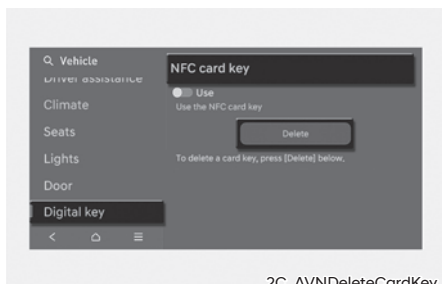

1. Turn on the engine with a smart key. Have your smart key with you in the vehicle.
2. From the infotainment system settings menu, select **Setup > Vehicle > Digital Keys > NFC Card Key > Delete**.
  - The “Delete” button is disabled if there is no digital key (card key) registered.

## Personalized profile and vehicle settings

You can set the registered digital key (smartphone) profiles for Driver 1 and Driver 2. When you use the digital key (smartphone), the vehicle can be set to the user-defined personalized profile (includes items such as vehicle settings and audio preferences).

## Linking/Unlinking profile

### How to link user profile

1. Select **Setup > User Profile > Profile Settings > Link Digital Key (Smartphone)** from the Settings menu in the infotainment system.
2. Select “**Link**” to connect the registered smartphone’s digital key and the user’s profile.
3. Follow the instructions according to the message on the infotainment system screen.

### How to unlink user profile

Select **Setup > User Profile > Profile Settings**, and then deselect “**Link Digital Key (Smartphone)**” from Settings menu in the infotainment system.

- Unlinking is possible only when user profile is linked.

## **i** Information

- **User profile cannot be linked to both Driver 1 and Driver 2 that are connected to single smartphone. Personalization operates with the recently linked user profile, and the previously linked user profile will be automatically canceled.**
- **User profile link works only when the digital key is registered to the vehicle.**
- **Digital key (card key) cannot be linked with a user profile.**
- **If the user profile linked digital key in the smartphone is deleted, the digital key should be re-registered and personalized by linking the user profile again.**

**Vehicle personalization operation**

- The personalization function linked with digital key works when the profile linked smartphone is placed on the outside door handle authentication pad to lock or unlock the doors.
- The profile set by the digital key can be changed manually from the infotainment system.
- The personalization function using the digital key can be operated after linking the digital key in the infotainment system profile menu.
- The personalization function works only when the vehicle is OFF or when the vehicle is started remotely. If the vehicle is not started remotely, the personalization function does not work with the digital key.

** Information**

User profile operation according to door lock/unlock system is as follows:

Item	Personalization Operation
Initial value	Guest
Profile linked smartphone key	Linked profile
Profile unlinked smartphone key	Recently activated profile
NFC card key	
Smart key	

### Vehicle personalization with digital key

The available personalization function in the vehicle is as follows:

System	Personalization Item	
Infotainment system vehicle settings	Lamp	Blink number of one-touch signal lamps
	Cluster	Information display on the cluster, Voice volume, Welcome sound
	Seat	Seat position
	Door	Automatic door lock/unlock, Two Press Unlock
	Climate	Temperature Unit, Automatic ventilation
Infotainment system	Navigation	Preferred volume of the navigation system, Recent destination
	User preset	My menu list settings, Radio preset
	Phone connectivity	Bluetooth preferential connect CarPlay/Android Auto On/Off
Air conditioning	Operating condition	Latest operation setup of the following functions: Temperature, AUTO, air flow direction, air volume, air conditioner, air intake control, SYNC, Front windshield defroster, OFF



#### CAUTION

If you leave the digital key after locking or unlocking the doors or starting up the vehicle with the smart key, the doors can be locked by the central door lock. Please carry around the digital key all the time.



#### Information

The infotainment system may change after software updates. For more information, refer to the user's manual provided in the infotainment system and the quick reference guide.

## Used Vehicle/Digital Key Maintenance

### ***Purchasing used vehicle***

- When purchasing a used vehicle, make sure to delete the smartphone key and card key registered by the previous user and inform the purchase of a used vehicle through Hyundai Customer Care Center.

### ***Digital key maintenance***

If you need to repaired or replaced your Digital Key system, make sure your smartphone key is still active. You may have to pair your phone again using the HYUNDAI Digital Key app.

## Limitations of the System

- HYUNDAI Digital Key app on the smartphone and card key may not work if:
  - Smartphone battery or the vehicle battery is discharged.
  - NFC or Bluetooth is turned off on the smartphone settings.
  - The card key is in a wallet or card holder, or overlapped with other cards.
  - If you use a smartphone cover that uses wireless communication or is made of metal, remove the smartphone cover.
- The vehicle may not be controlled by the smartphone if any of the following occurs:
  - Other smartphone functions (calls, urgent call, audio or NFC payment), apps, or wireless earphones are operating.
  - The digital key app function such as basic setting or app launching is limited by the prior policy according to the manufacturer.

## DOOR LOCKS

### Operating Door Locks from Outside the Vehicle

#### Mechanical key

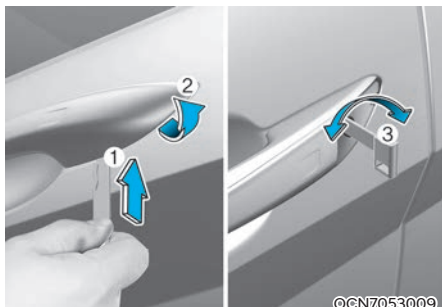

1. Press the lever located under the cover with mechanical key. (1)
2. While pushing the lever so that the mechanical key does not fall out of the cover hole, slowly push it towards the rear of the vehicle and remove the cover. (2)
3. After removing the cover, only driver's door can be locked or unlocked by using mechanical key.
4. Turn the key toward the rear of the vehicle to lock and toward the front of the vehicle to unlock. (3)
  - If you lock/unlock the driver's door with a key, the driver's door will lock/unlock automatically.

Once the door is unlocked, it may be opened by pulling the door handle.

Make sure that doors are closed securely.

#### **i** Information

Be careful when locking the door by mechanical key operation, only the driver's door can be locked/unlocked.

Refer to Chapter 5 "Operating door locks from inside the vehicle" to lock from inside the vehicle.

#### **i** Information

When removing the cover, be careful not to lose cover and any scratches.

When the key cover freezes and does not open, lightly tap or indirectly warm (hand temperature, etc.) it.

**Do not apply excessive force to the door and door handle. It may be damaged.**

### Remote key

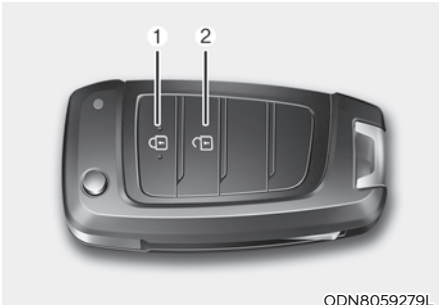

To lock the doors, press the Door Lock button (1) on the remote key.

To unlock the doors, press the Door Unlock button (2) on the remote key.

Once the doors are unlocked, they may be opened by pulling the door handle.

When closing the door, push the door by hand. Make sure that doors are closed securely.

### Smart key

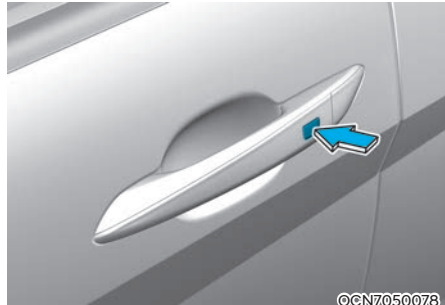

To lock the doors, press the button on the outside door handle while carrying the smart key with you or press the door lock button on the smart key.

To unlock the doors, press the button on the outside door handle while carrying the smart key with you or press the door unlock button on the smart key.

Once the doors are unlocked, they may be opened by pulling the door handle.

When closing the door, push the door by hand. Make sure that doors are closed securely.

### **i** Information

- **In cold and wet climates, door lock and door mechanisms may not work properly due to freezing conditions.**
- **If the door is locked/unlocked multiple times in rapid succession with either the vehicle key or door lock switch, the system may stop operating temporarily in order to protect the circuit and prevent damage to system components.**
- **Two press unlock setting can be changed in the User Settings mode on the cluster.**

## Operating Door Locks from Inside the Vehicle

### With the door handle

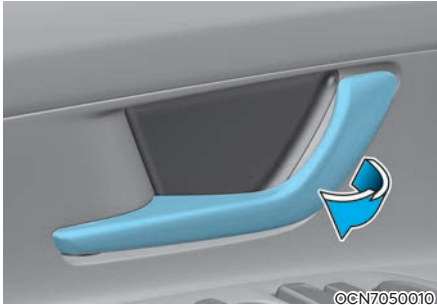

#### Front door

If the inner door handle is pulled when the door is locked, the door will unlock and open.

#### Rear door

If the inner door handle is pulled once when the door is locked, the door will unlock. If the inner door handle is pulled once more, the door will open.

If any door is opened, the doors will not lock even though the central door lock switch is pressed.

## **i** Information

If a power door lock ever fails to function while you are in the vehicle try one or more of the following techniques to exit:

- Operate the door unlock feature repeatedly (both electronic and manual) while simultaneously pulling on the door handle.
- Operate the other door locks and handles, front and rear.
- Lower a front window and use the mechanical key to unlock the door from outside.

## With the central door lock switch

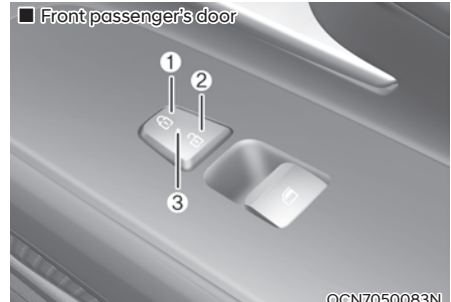

- When pressing the (🔒) portion (1) of the switch, all vehicle doors will lock.
  - If any door is opened, the doors will not lock even though the central door lock switch (1) is pressed.
- When pressing the (🔓) portion (2) of the switch, all vehicle doors will unlock.
- Doors indicating light (3)
  - When all vehicle doors are locked, the indicating lights on the driver's door and passenger's door will turn off. If any door is unlocked, it would go on.



**WARNING**

- The doors should always be fully closed and locked while the vehicle is in motion. If the doors are unlocked, the risk of being thrown from the vehicle in a crash is increased.
- Do not pull the inner door handle of the driver's or passenger's door while the vehicle is moving.



**WARNING**

Do not leave the elderly, children or animals unattended in your vehicle. An enclosed vehicle can become extremely hot, causing death or serious injury to the elderly, unattended children or animals who cannot escape from the vehicle. Children might operate features of the vehicle that could injure them, or they could encounter other harm, possibly from someone gaining entry to the vehicle.



**WARNING**

Always secure your vehicle.

Leaving your vehicle unlocked increases the potential risk to you or others from someone hiding in your vehicle.

To secure your vehicle, while depressing the brake, move the shift lever to the P (Park) position, engage the parking brake, and place the ignition switch in the LOCK/OFF position, close all windows, lock all doors, and always take the key with you.



**WARNING**

If you stay in the vehicle for a long time while the weather is very hot or cold, there are risks of injuries or danger to life. Do not lock the vehicle from the outside when someone is in the vehicle.



**WARNING**

Opening a door when something is approaching may cause damage or injury. Be careful when opening doors and watch for vehicles, motorcycles, bicycles or pedestrians approaching the vehicle in the path of the door.

## Automatic Door Lock and Unlock Features

Your vehicle is equipped with features that automatically locks or unlocks your vehicle based on settings you select in the infotainment system.

### ***Automatically Lock Enable on speed***

When this feature is set in the infotainment system, all the doors are locked automatically when the vehicle exceeds 9 mph (15 km/h).

### ***Automatically Lock Enable on speed or shift***

When this feature is set in the infotainment system, all the doors are locked automatically when the vehicle exceeds 9 mph (15 km/h) or when the vehicle is shifted out of P (Park) while the vehicle is running.

### ***Automatically Unlock Enable on Shift to P***

When this feature is set in the infotainment system, all the doors are unlocked automatically when the vehicle is shifted back to P (Park) while the vehicle is running.

### ***Automatically Unlock On vehicle off***

When this feature is set in the infotainment system, all the doors are unlocked automatically when the vehicle is turned off.

For detailed information, refer to the separately supplied infotainment system manual.

### ***Additional unlock safety feature airbag deployment***

As an additional safety feature, all doors are automatically unlocked when an impact causes the airbags to deploy.

## Child-Protector Rear Door Locks



The child safety lock is provided to help prevent children seated in the rear from accidentally opening the rear doors.

The rear door safety locks should be used whenever children are in the vehicle.

The child safety lock is located on the edge of each rear door. When the child safety lock is in the lock position, the rear door will not open if the inner door handle is pulled.

To lock the child safety lock, insert a small flat blade tool (for example, screwdriver or similar) into the slot and turn it to the lock position as shown.

To allow a rear door to be opened from inside the vehicle, unlock the child safety lock.



### **WARNING**

**If children accidentally open the rear doors while the vehicle is in motion, they could fall out of the vehicle. The rear door safety locks should always be used whenever children are in the vehicle.**

## REAR OCCUPANT ALERT (ROA)

Rear Occupant Alert helps prevent the driver from leaving a passenger in the rear seats.

### Rear Occupant Alert Operation



When the driver turns off the engine and opens the driver's door after opening and closing a rear door, a warning message "Check rear seat for passengers and belongings" appears on the cluster.

#### **WARNING**

**Rear Occupant Alert provides information to the driver to check the rear seats but it does not detect whether there is an object or passenger. Always check the rear seats when leaving the vehicle.**

#### **Information**

**The open and close history of the rear door is initialized if the driver turns off the engine and lock vehicle doors. However, the alarm may sound again whenever the driver's door is opened if the previous history of the rear door is not initialized.**

## THEFT-ALARM SYSTEM

This system helps to protect your vehicle and valuables. The horn will sound and the hazard warning lights will blink continuously if any of the following occur:

- A door is opened without using the remote key or smart key.
- The trunk is opened without using the remote key or smart key.
- The engine hood is opened.

The alarm continues for 30 seconds, then the system resets. To turn off the alarm, unlock the doors with the remote key or smart key.

The Theft Alarm System automatically sets 30 seconds after you lock the doors and the trunk. For the system to activate, you must lock the doors and the trunk from outside the vehicle with the remote key or smart key or by pressing the button on the outside of the door handle with the smart key in your possession.

The hazard warning lights will blink and the chime will sound once to indicate the system is armed.

Once the security system is set, opening any door, the trunk, or the hood without using the remote key or smart key will cause the alarm to activate.

The Theft Alarm System will not set if the hood, the trunk, or any door is not fully closed. If the system will not set, check the hood, the trunk, or the doors are fully closed.

Do not attempt to alter this system or add other devices to it.

### **i** Information

- **Do not lock the doors until all passengers have left the vehicle. If the remaining passenger leaves the vehicle when the system is armed, the alarm will be activated.**
- **If the vehicle is not disarmed with the remote key or smart key, open the doors by using the mechanical key and place the ignition switch in the ON position (for remote key) or start the engine (for smart key) and wait for 30 seconds.**
- **When the system is disarmed but a door or trunk is not opened within 30 seconds, the system will be rearmed.**

## DRIVER POSITION MEMORY SYSTEM (IF EQUIPPED)

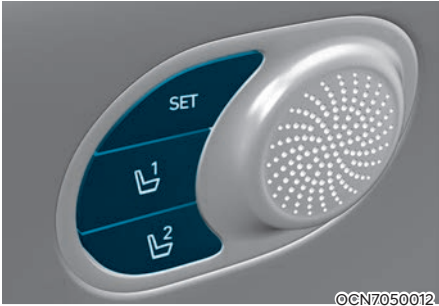

The Driver Position Memory System is provided to store and recall the following memory settings with a simple button operation.

- Driver's seat position



### WARNING

**Never attempt to operate the driver position memory system while the vehicle is moving.**

**This could result in loss of control, and an accident causing death, serious injury, or property damage.**



### Information

- If the battery connector is disconnected, the memory settings will be erased.
- If the Driver Position Memory System does not operate normally, have the system checked by an authorized HYUNDAI dealer.

### Storing Memory Positions

1. Shift to P (Park) while the ignition switch is in the ON position.
2. Adjust the driver's seat position and instrument panel illumination intensity to the desired position.
3. Press the SET button. The system will beep once and notify you 'Press button to save settings' on the cluster display.
4. Press one of the memory buttons (1 or 2) within 4 seconds. The system will beep twice when successfully stored.

### Recalling Memory Positions

1. The ignition switch is in the ON position.
2. Press the desired memory button (1 or 2). The system will beep once, and then the driver's position will automatically adjust to the stored positions.
3. 'Settings 1 (or 2) applied' appears on the cluster display.



### Information

**If your vehicle is equipped with additional navigation, please refer to the infotainment system manual separately supplied.**

### **i** Information

- To recall the settings of memory button 2 while the settings of memory button 1 is being recalled, press the SET button or memory button 1 to stop the adjustment, and then press memory button 2.
- While recalling the stored positions, pressing one of the control buttons for the driver's seat will cause the movement of that component to stop and move in the direction that the control button is pressed.

### Resetting Integrated Memory System

If the Driver position memory system does not work properly, initialize the system as follows.

How to initialize:

1. Stop the vehicle and open the driver's door with the ignition switch in the ON position and the vehicle shifted to P (Park).
2. Pull the driver's seat forward as far as possible and have the seatback upright as much as possible using the driver's seat forward/backward adjustment and seatback angle (recline) switches.
3. Push the SET button and seat forward movement switch for 2 seconds simultaneously.

### While Resetting the Integrated Memory System

A notification sound is heard and the seat is adjusted to the most reward position.

Then the seat and seatback move to the default center position.

The resetting procedure and the notification sound may stop if:

- The memory button is pressed.
- The seat control switch is operated.
- The gear is shifted out of P (Park).
- The driving speed exceeds 2 mph (3 km/h).
- The driver's door is closed.

### **NOTICE**

- **If the seat movement or notification sound stops before the process is complete, restart the resetting procedure.**
- **Before resetting the IMS, make sure there are no objects on or around the driver's seat.**
- **After resetting the IMS, the driver's seat must be adjusted and stored again to recall the memory position.**

## Seat Easy Access Operation (if equipped)

Seat easy access moves the driver's seat automatically as follows:

- Without smart key system
  - It will move the driver's seat rearward when the ignition key is removed and the driver's door is opened.
  - It will move the driver's seat forward when the ignition switch is in the ACC or ON position.
- With smart key system
  - It will move the driver's seat rearward when the ignition switch is in the LOCK/OFF position and the driver's door is opened.
  - It will move the driver's seat rearward when the ignition switch is in the LOCK/OFF position and the driver's door is opened.

**You can activate or deactivate the Easy Access Function from the User Settings Mode on the cluster display.**

**For more details, refer to "Cluster display (Type A)" in chapter 4**

### Information

**If your vehicle is equipped with additional infotainment system, you can set the system in the infotainment system.**

## STEERING WHEEL

### Motor Driven Power Steering (MDPS)

The system assists you with steering the vehicle. If the vehicle is turned off or if the power steering system becomes inoperative, you may still steer the vehicle, but it will require increased steering effort.

Also, the steering effort becomes heavier as the vehicle's speed increases and becomes lighter as the vehicle's speed decreases for better control of the steering wheel.

Should you notice any change in the effort required to steer during normal vehicle operation, have the system checked by an authorized HYUNDAI dealer.



### CAUTION

- If the Motor Driven Power Steering System does not operate normally, the warning light (⚠) will illuminate on the instrument cluster. You may steer the vehicle, but it will require increased steering efforts. Take your vehicle to an authorized HYUNDAI dealer and have the system checked as soon as possible.
- When an abnormality is detected in the Motor Driven Power Steering system, to prevent an accident, the steering assist function may become inoperative. At this time, the warning light turns on or blinks on the cluster. The steering wheel may become difficult to control or operate. Have your vehicle checked immediately, after moving the vehicle to a safe area.

### Information

The following symptoms may occur during normal vehicle operation:

- The steering effort may be high immediately after placing the ignition switch in the ON position.  
This happens as the system performs the MDPS system diagnostics. When the diagnostics are completed, the steering wheel effort will return to its normal condition.
- When the battery voltage is low, you may have to put more steering effort. However, it is a temporary condition so that it will return to normal condition after charging the battery.
- A click noise may be heard from the MDPS relay after the ignition switch is in the ON or LOCK/OFF position.
- Motor noise may be heard when the vehicle is at a stop or at a low driving speed.
- When you operate the steering wheel in low temperatures, abnormal noise may occur. If the temperature rises, the noise will disappear. This is a normal condition.
- When an error is detected from the MDPS, the steering effort assist function may become inoperative in order to prevent fatal accidents. Instrument cluster warning lights may be on or the steering effort may be high. If these symptoms occur, drive the vehicle to a safe area as soon as it is safe to do so. Have the system checked by an authorized HYUNDAI dealer as soon as possible.

## Tilt Steering / Telescope Steering

When adjusting the steering wheel to a comfortable position, adjust the steering wheel so that it points toward your chest, not toward your face. Make sure you can see the instrument cluster warning lights and gauges. After locking the lever, push the steering wheel both up and down to be certain it is locked in position. Always adjust the position of the steering wheel before driving.



### WARNING

**NEVER** adjust the steering wheel while driving. This may cause loss of vehicle control resulting in an accident.



To adjust the steering wheel angle and height:

1. Pull down the lock-release lever (1).
2. Adjust the steering wheel to the desired angle (2) and distance forward/back (3).
3. Pull up the lock-release lever to lock the steering wheel in place.



### Information

Sometimes the lock release lever may not engage completely. This may occur when the gears of the locking mechanism do not completely mesh. If this occurs, pull down on the lock release lever, readjust the steering wheel again, and then pull back up on the release lever to lock the steering wheel in place.



### CAUTION

While adjusting the steering wheel height, please do not push or pull it hard since the fixture can be damaged.

## Horn

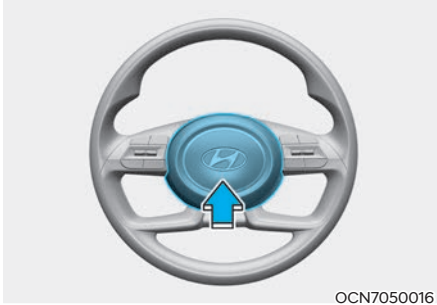

To sound the horn, press the area indicated by the horn symbol on your steering wheel (see illustration). The horn will operate only when this area is pressed.

### **NOTICE**

**Do not strike the horn severely to operate it, or hit it with your fist. Do not press on the horn with a sharp-pointed object.**

### **NOTICE**

**Do not clean the steering wheel surface with the following products:**

- Organic solvents such as thinner, alcohol and gasoline
- Chemical products such as leather cleaner, coating agent, and wax

## MIRRORS

### Inside Rearview Mirror

Before driving your vehicle, check to see that your inside rearview mirror is properly positioned. Adjust the rearview mirror so that the view through the rear window is properly centered.

#### WARNING

**Make sure your line of sight is not obstructed. Do not place objects in the rear seat, cargo area, or behind the rear head restraints which could interfere with your vision through the rear window.**

#### WARNING

**To prevent serious injury during an accident or deployment of the air bag, do not modify the rearview mirror and do not install a wide mirror.**

#### WARNING

**NEVER adjust the mirror while driving. This may cause loss of vehicle control resulting in an accident.**

#### NOTICE

When cleaning the mirror, use a paper towel or similar material dampened with glass cleaner. Do not spray glass cleaner directly on the mirror as this may cause the liquid cleaner to enter the mirror housing.

### Day/night rearview mirror (if equipped)

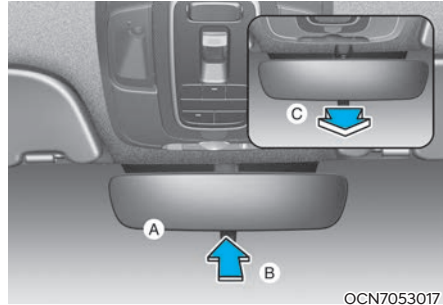

[A] : Lever, [B] : Day, [C] : Night

Make this adjustment before you start driving and while the day/night lever is in the day position.

Pull the day/night lever towards you to reduce glare from the headlights of the vehicles behind you during night driving.

*Remember that you lose some rearview clarity in the night position.*

### Electric Chromic Mirror (ECM)(if equipped)



[1] : Sensor

When the engine is running, the glare from vehicle headlights behind you is automatically controlled by the sensor mounted in the rearview mirror.

When the gear is shifted to R (Reverse), the mirror automatically goes to the brightest setting in order to improve the driver's view behind the vehicle.

### ***Electrochromic mirror (ECM) with HomeLink® system (if equipped)***

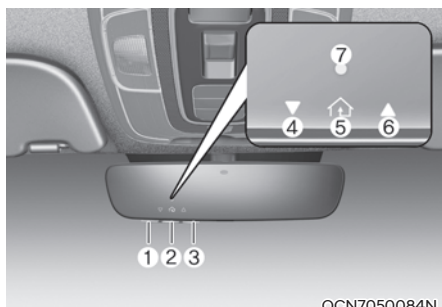

OCN7050084N

Your vehicle may be equipped with a Gentex Automatic-Dimming Mirror with an Integrated HomeLink® Wireless Control System.

During nighttime driving, this feature will automatically detect and help reduce rearview mirror glare. The HomeLink® Universal Transceiver allows you to activate your garage door(s), electric gate, home lighting, etc.

- (1) HomeLink Channel 1
- (2) HomeLink Channel 2
- (3) HomeLink Channel 3
- (4) Garage Door Opener Status Indicator : Closing or Closed
- (5) HomeLink Operation Indicator
- (6) Garage Door Opener Status Indicator : Opening or Opened
- (7) HomeLink User Interface Indicator

### **Automatic-Dimming Night Vision Safety™ (NVS®) Mirror (if equipped)**

The NVS® Mirror automatically helps reduce glare by monitoring light levels in the front and the rear of the vehicle. Any object that obstructs either light sensor will degrade the automatic dimming control feature.

**For more information regarding NVS® mirrors and other applications, please refer to the Gentex website:**

**[www.gentex.com](http://www.gentex.com)**

Your mirror will automatically dim upon detecting glare from the vehicles traveling behind you.

The mirror defaults to the ON position each time the vehicle is started.

### **Integrated HomeLink® Wireless Control System**

The HomeLink® Wireless Control System can replace up to three hand-held radio-frequency (RF) transmitters with a single built-in device. This innovative feature will learn the radio frequency codes of most current transmitters to operate devices such as gate operators, garage door openers, entry door locks, security systems, even home lighting. Both standard and rolling code-equipped transmitters can be programmed by following the outlined procedures.

Additional HomeLink® information can be found at: [www.homelink.com](http://www.homelink.com), [www.youtube.com/HomeLinkGentex](http://www.youtube.com/HomeLinkGentex) or by calling 1-800-355-3515.

Retain the original transmitter of the RF device you are programming for use in other vehicles as well as for future HomeLink® programming. It is also suggested that upon the sale of the vehicle, the programmed HomeLink® buttons be erased for security purposes.



### WARNING

Before programming HomeLink® to a garage door opener or gate operator, make sure people and objects are out of the way of the device to prevent potential harm or damage. Do not use the HomeLink® with any garage door opener that lacks the safety stop and reverse features required by U.S. federal safety standards (this includes any garage door opener model manufactured before April 1, 1982). A garage door that cannot detect an object - signaling the door to stop and reverse - does not meet current U.S. federal safety standards. Using a garage door opener without these features increases the risk of serious injury or death.

### Programming HomeLink®

Please note the following:

- When programming a garage door opener, it is advised to park the vehicle outside of the garage.
- It is recommended that a new battery be placed in the hand-held transmitter of the device being programmed to HomeLink® for quicker training and accurate transmission of the radio-frequency signal.
- Some vehicles may require the ignition switch to be in the ACC (or "Accessories") position for programming and/or operation of HomeLink®.
- In the event that there are still programming difficulties or questions after following the programming steps listed below, contact HomeLink® at: [www.homelink.com](http://www.homelink.com), [www.youtube.com/HomeLinkGentex](http://www.youtube.com/HomeLinkGentex) or by calling 1-800-355-3515.

### Programming

To program most devices, follow these instructions:



OCN7050085N

1. Press and release (1), (2) or (3) button.
  - If the indicator (4) is turned ON in Orange, go to Step 3) since it is a new programming.
  - If the indicator (4) is continuously turned ON or flashes in Green rapidly several times, go to Step 2) since it is a programmed button.
2. Press and hold the button you wish to program for approximately 15-25 seconds until the LED flashes in Orange for several times.
3. Hold the Garage Door Opener Original Transmitter near the HomeLink Mirror.



4. Press the Original Transmitter button until the indicator (4) is turned continuously ON or flashes in Green for approximately 10 seconds and it indicates the programming is completed.
5. However, the indicator (4) flashes in Green continuously, but if the garage door opener does not operate, please continue to follow the step 6 and 7 (“Rolling Code Programming” procedures).
6. Firmly press and release the “Learn,” “Smart,” or “Program” button while the indicator (4) flashes in Green. Once the button is pressed, you have approximately 30 seconds to initiate the next step.

### **i** Information

**At the garage door opener motor, (security gate motor, etc.) locate the “Learn,” “Smart,” or “Program” button. This can usually be found where the hanging antenna wire is attached to the motor-head unit (see the device’s manual to identify this button). The name and color of the button may vary by manufacturer. A ladder and/or second person may simplify the following steps.**

7. Return to the vehicle and firmly press, hold for two seconds and release the HomeLink button up to three times. Do not press the HomeLink button rapidly. At this point programming is complete and your device should operate when the HomeLink button is pressed and released.

### **i** Information

- **Some garage door openers require to press the programmed button on the mirror up to three times right after the programming is just completed to operate the garage door.**
- **The indicator (4) is turned ON in Orange and flashes for about 60 seconds, during the programming mode and if a programming is not succeeded within the 60 seconds, the programming mode will be abort.**

HomeLink® should now activate your rolling code equipped device.

### Gate operator & Canadian programming

During programming, your handheld transmitter may automatically stop transmitting. Continue to press the Integrated HomeLink® Wireless Control System button while you press and re-press (“cycle”) your handheld transmitter every two seconds until the frequency signal has been learned. The indicator light will flash slowly and then rapidly after several seconds upon successful training.



### Operating HomeLink®

1. Press and release one of the HomeLink buttons (1, 2 or 3) that programmed.
2. The HomeLink indicator (4) will operate as below:
  - Indicates Green and is continuously ON (Fixed Code Garage Door Opener)
  - Flashes in Green rapidly (Rolling Code Garage Door Opener)

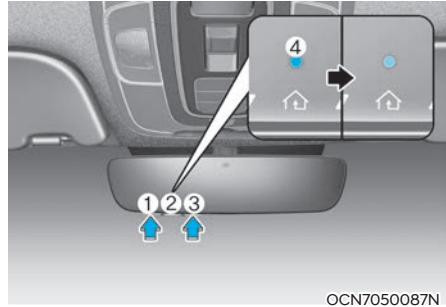

### Erasing HomeLink® buttons

1. Press and hold the button (1) and (3) simultaneously.
2. The indicator (4) is turned continuously ON in orange for about 10 seconds.
3. Then the indicator (4) color changes to Green and flashes rapidly. Release the buttons once the green indicator flashes.
4. Now HomeLink button (1), (2) and (4) memories are all cleared.

NVS® is a registered trademark and Z-Nav™ is a trademark of the Gentex Corporation, Zeeland, Michigan. HomeLink® is a registered trademark owned by Johnson Controls, Incorporated, Milwaukee, Wisconsin.

**FCC ID: NZLUAHL5A**  
**IC: 4112A-UAHL5A**

## **i** Information

This device complies with Part 15 of the FCC Rules.

Operation is subject to the following three conditions:

1. This device may not cause harmful interference, and
2. This device must accept any interference received, including interference that may cause undesired operation.
3. The transceiver has been tested and complies with FCC and Industry Canada rules. Changes or modifications not expressly approved by the party responsible for compliance could void the user's authority to operate the device.

## Two Way Communication Programming

1. Complete the HomeLink "Programming" first.
2. Before the first 10 times HomeLink button is pressed after the programming, the following steps MUST occur to program two way communication. (only for some older garage doors)



3. Press and release the programmed HomeLink button to activate the garage door.
4. Once the garage door is stopped, press and release the "Learn" or "Smart" button on the Garage door opener within 1 minute from the time of pressing the programmed HomeLink button on mirror.



OCN7050089N

5. If the both indicator (4) and (5) are flashing rapidly for about 5 seconds, the two way synchronization is completed.

**i** Information

Some newer garage door openers provide two-way communication synchronizing when programing the original transmitter.



OCN7050088N

**Operating Two Way Communication**

1. Press and release (1), (2) or (3) button.



2. The indicator (4) and (5) operates as below:
- If the indicator (4) flashes in Orange, it indicates that the garage door is "closing".
  - If the indicator (4) is ON continuously in Green, it indicates that the garage door is "closed".
  - If the indicator (5) flashes in Orange, it indicates that the garage door is "Opening".
  - If the indicator (5) is ON continuously in Green, it indicates that the garage door is "Opened".
  - If the indicator (4) or (5) does not turn to Green, it indicates that the last status of garage door was not received properly. The HomeLink mirror tries to receive the last known status of the garage door for a few seconds.

### Recalling Garage Door Status

Homelink mirror with two way communication provides a way to view the last stored message from the garage door opener. In order to recall the last known status of the last activated device, press the buttons "1 and 2" OR "2 and 3" simultaneously.

- If the indicator (4) is ON continuously in Green, it indicates that the last activated device was "closed" properly.
- If the indicator (5) is ON continuously in Green, it indicates that the last activated device was "open" properly.

### **i** Information

**Two way communication range distance between "vehicle" and "garage door opener" is 100m.**

**The range may be reduced or increased a little due to obstacle conditions around the garage door opener, such as houses or trees.**

## Side View Mirrors



Make sure to adjust the side view mirrors to your desired position before you begin driving.

Your vehicle is equipped with both left-hand and right-hand side view mirrors. The mirrors can be adjusted remotely with the remote switch. The side view mirrors can be folded to help prevent damage when going through an automatic car wash or when passing through a narrow street.

### **i** Information

- **The right side view mirror is convex. Objects seen in the mirror are closer than they appear.**
- **Use the inside rear view mirror or look back directly to determine the actual distance of other vehicles prior to changing lanes.**

### **⚠** WARNING

**Do not adjust or fold the side view mirrors while driving. This may cause loss of vehicle control resulting in an accident.**

### **NOTICE**

- **Do not scrape ice off the mirror face; this may damage the surface of the glass.**
- **If the mirror is jammed with ice, do not adjust the mirror by force. Use an approved de-icer (not radiator antifreeze) spray, or a sponge or soft cloth with very warm water, or move the vehicle to a warm place and allow the ice to melt.**
- **Do not clean the mirror with harsh abrasives, fuel, or other petroleum based cleaning products.**

### Side View Mirror Adjustment

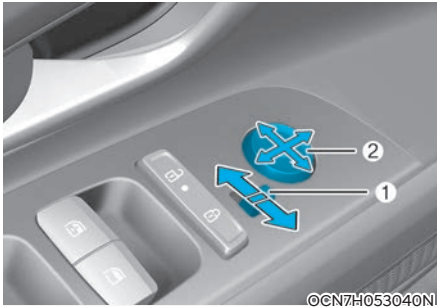

1. Move the lever (1) to the L (left side) or R (right side) to select the side view mirror you want to adjust.
2. Use the mirror adjustment control (2) to position the selected mirror up, down, left or right.
3. After adjustment, put the lever into neutral (center) position to prevent inadvertent adjustment.

### NOTICE

- The mirrors stop moving when they reach the maximum adjusting angles, but the motor continues to operate while the switch is pressed. Do not press the switch longer than necessary, because this can damage the motor.
- Do not attempt to adjust the side view mirrors by hand, because this can damage the motor.

### Folding the side view mirrors

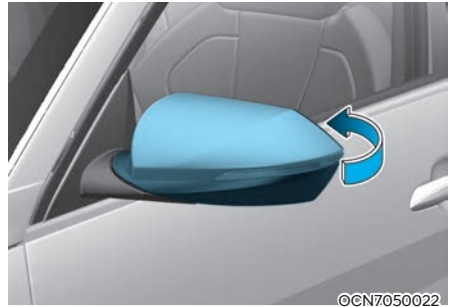

To fold the side view mirrors, grasp the housing of the mirror and then fold it inwards.

## WINDOWS

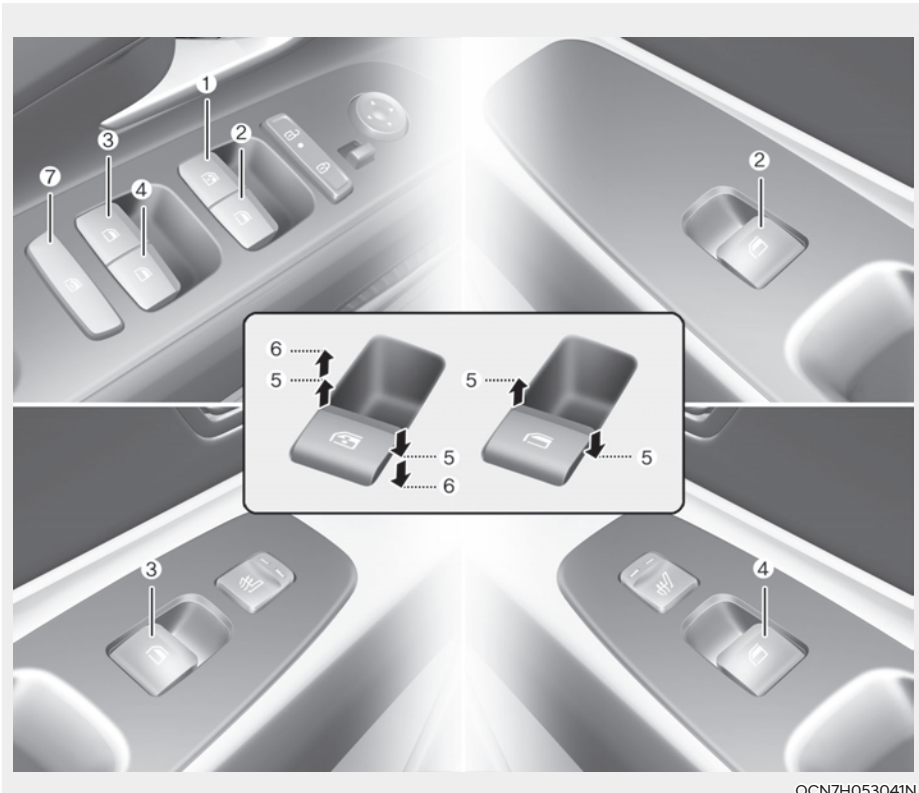

OCN7H053041N

- (1) Driver's door power window switch
- (2) Front passenger's door power window switch
- (3) Rear door (left) power window switch
- (4) Rear door (right) power window switch
- (5) Window opening and closing
- (6) Automatic power window
- (7) Power window lock switch

## Power Windows

The ignition switch must be in the ON position to be able to raise or lower the windows. Each door has a Power Window switch to control that door's window. The driver has a Power Window Lock switch which can block the operation of rear passenger windows. The power windows will operate for approximately 30 seconds after the ignition switch is placed in the ACC or LOCK/OFF position. However, if the front doors are opened, the Power Windows will not operate even within the 30 second period.



### WARNING

**To avoid serious injury or death, do not extend your head, arms or body outside the windows while driving.**



### Information

- In cold and wet climates, power windows may not work properly due to freezing conditions.
- While driving with the rear windows down or with the sunroof (if equipped) opened (or partially opened), your vehicle may demonstrate a wind buffeting or pulsation noise. This noise is normal and can be reduced or eliminated by taking the following actions. If the noise occurs with one or both of the rear windows down, partially lower both front windows approximately one inch. If you experience the noise with the sunroof open, slightly close the sunroof.

## Window opening and closing

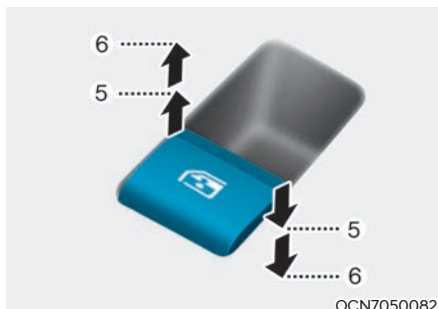

To open:

Press the window switch down to the first detent position (5). Release the switch when you want the window to stop.

To close:

Pull the window switch up to the first detent position (5). Release the window switch when you want the window to stop.

### **Auto down window (if equipped)**

Pressing the power window switch down momentarily to the second detent position (6) completely lowers the window even when the switch is released. To stop the window at the desired position while the window is in operation, pull up or press down and release the switch.

### **Auto up/down window (if equipped)**

Pressing or pulling up the power window switch momentarily to the second detent position (6) completely lowers or lifts the window even when the switch is released. To stop the window at the desired position while the window is in operation, pull up or press down and release the switch.

### To reset the power windows

If the power windows do not operate normally, the automatic power window system must be reset as follows:

1. Place the ignition switch to the ON position.
2. Close the window and continue pulling up on the power window switch for at least one second.

If the power windows do not operate properly after resetting, have the system checked by an authorized HYUNDAI dealer.



### WARNING

**The automatic reverse feature doesn't activate while resetting the power window system. Make sure body parts or other objects are safely out of the way before closing the windows to avoid injuries or vehicle damage.**

### Automatic reverse (if equipped)

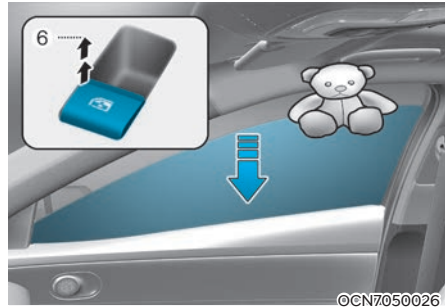

If a window senses any obstacle while it is closing automatically, it will stop and lower approximately 12 inches (30 cm) to allow the object to be cleared.

If the window detects the resistance while the power window switch is pulled up continuously, the window will stop upward movement then lower approximately 1 inch (2.5 cm).

If the power window switch is pulled up continuously again within 5 seconds after the window is lowered by the automatic window reverse feature, the automatic window reverse will not operate.



### Information

**The automatic reverse feature is only active when the “Auto Up” feature is used by fully pulling up the switch to the second detent.**



### WARNING

**Make sure body parts or other objects are safely out of the way before closing the windows to avoid injuries or vehicle damage.**

**Objects less than 0.16 inch (4 mm) in diameter caught between the window glass and the upper window channel may not be detected by the automatic reverse window and the window will not stop and reverse direction.**

**NOTICE**

Do not install any accessories on the windows. The automatic reverse feature may not operate.

**Power window lock switch**

The driver can disable the power window switches on the rear passenger doors by pressing the power window lock switch.

When the power window lock switch is pressed:

- The rear passenger control will not be able to operate the rear passenger power window
- Note that the front passenger control is still able to operate the front passenger window, and that the driver master control can still operate all the power windows.

**NOTICE**

- To prevent possible damage to the power window system, do not open or close two windows or more at the same time. This will also ensure the longevity of the fuse.
- Never try to operate the main switch on the driver's door and the individual door window switch in opposite directions at the same time. If this is done, the window will stop and cannot be opened or closed.

**WARNING**

- NEVER leave the keys in your vehicle with unsupervised children, when the engine is running.
- NEVER leave any child unattended in the vehicle. Even very young children may inadvertently cause the vehicle to move, entangle themselves in the windows, or otherwise injure themselves or others.
- Always double check to make sure arms, hands, head and other obstructions are safely out of the way before closing a window.
- Do not allow children to play with the power windows. Keep the driver's door power window lock switch in the LOCK position (pressed). Serious injury can result from unintentional window operation by the child.
- Do not extend your head, arms or body outside the windows while driving.

**Remote window opening function (if equipped)**

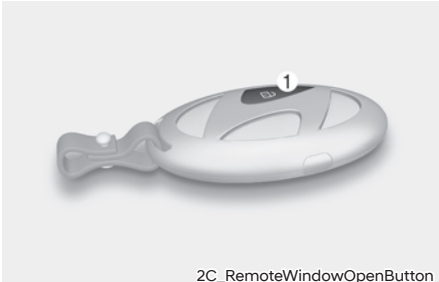

Press and hold the Door Unlock (1) button on the smart key for more than 3 seconds and the front seat windows move down after the doors are unlocked. Window movement stops when you release the door unlock button.

**NOTICE**

**Do not leave the windows down when leaving the vehicle to prevent theft or damage from water entering the vehicle.**

**i Information**

The remote window opening function may abruptly stop, when you move away from your vehicle during operation. Stay in close proximity from your vehicle, while monitoring the window movement.

The doors unlock when the windows are opened using the remote window opening function.

## SUNROOF (IF EQUIPPED)

If your vehicle is equipped with a sunroof, you can slide or tilt your sunroof with the sunroof switch located on the overhead console.



The sunroof can only be operated when the ignition switch is in the ON or START position.

The sunroof can be operated for approximately 3 minutes after the ignition switch is in the ACC or LOCK/OFF position. However, if the front door is open, the sunroof cannot be operated even within the 3 minute period.



### WARNING

- **Adjust the sunroof or sunshade when your vehicle stops. This could result in loss of control and an accident that may cause injury, or property damage.**
- **Do not leave the engine running and the key in your vehicle with unsupervised children. Unattended children could operate the sunroof, which could result in serious injury.**
- **Do not sit on the top of the vehicle. It may cause injury or vehicle damage.**

### NOTICE

**Do not operate the sunroof when roof bars are installed on the vehicle or when there is luggage on the roof.**

## Sunshade



OCN7050029

Use the sunshade to block direct sunlight coming through the sunroof glass. Open or close the sunshade by hand.



### Information

**The sunshade opens automatically when the sunroof glass is opened, but the sunshade does not close automatically when the sunroof glass is closed. Also, only the sunshade cannot be closed when the sunroof glass is opened.**

### NOTICE

**Do not pull the sunshade up or down, or apply excessive force as such action may damage the sunshade or cause it to malfunction.**

### Tilt Open/Close

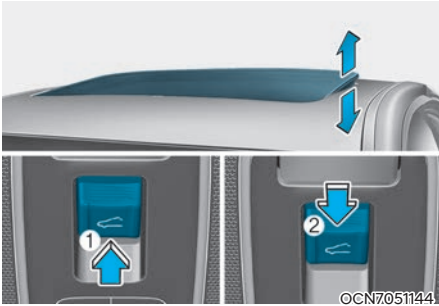

[1] : Tilt open  
[2] : Tilt close

- Push the sunroof switch upward, the sunroof glass tilts open.
- Push the sunroof switch forward, the sunroof glass automatically closes.

To stop the sunroof movement at any point, push the sunroof switch in any direction.

### **i** Information

The sunroof glass cannot slide open and tilt open at the same time. You cannot tilt the sunroof glass open while the sunroof glass is slide open. Also, you cannot slide the sunroof glass open while the sunroof is tilt open. Slide open or tilt open the sunroof glass when the sunroof glass is completely closed.

### Slide Open/Close

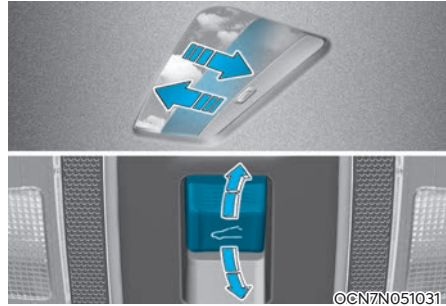

- Push the sunroof switch rearward, the sunshade and sunroof glass slide open.  
Push the sunroof switch forward, only the sunroof glass closes.
- Push the sunroof switch forward or rearward to the first detent position, the sunroof glass moves until the switch is released.
- Push the sunroof switch forward or rearward to the second detent position, the sunroof glass operates automatically (auto slide feature). To stop the sunroof movement at any point, push the sunroof switch in any direction.
- The sunroof glass stops halfway (first detent position) before it is fully opened. To fully open the sunroof glass, push the sunroof switch rearward once more. At this time, the sunroof glass opens only while the switch is pushed.

### **i** Information

To reduce wind noise while driving, we recommend that you drive at the recommended position before the maximum slide open position.

## Automatic Reversal (if equipped)

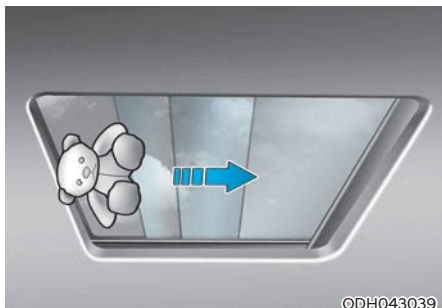

If the sunroof glass senses any obstacle while it is closing automatically, it will reverse direction then stop at a certain position.

The auto reverse function may not work if an object thin or soft is caught between the sliding sunroof glass and sunroof sash.



### WARNING

- **Make sure heads, hands, arms or any other body parts or objects are out of the way before operating the sunroof. Body parts or objects may get caught causing injuries or vehicle damage.**
- **Never deliberately use your body parts to test the automatic reversal function. The sunroof glass may reverse direction, but there is a risk of injury.**

### NOTICE

- **Do not continue to push the sunroof switch after the sunroof is fully opened, closed, or tilted. Damage to the sunroof motor could occur.**
- **Continuous operations such as slide open/close, tilt open/close, etc. may cause the motor or sunroof system to malfunction.**
- **Regularly remove any accumulated dust on the sunroof rail.**
- **Dust accumulated between the sunroof and roof panel can make noise. Open the sunroof and remove dust regularly using a clean cloth.**
- **Do not try to open the sunroof when the temperature is below freezing or when the sunroof is covered with snow or ice. The sunroof may not work properly and may break if opened by force.**
- **Do not open or drive with the sunroof glass open immediately after rain or washing the vehicle. Water may wet the interior of the vehicle.**
- **Do not extend any luggage outside the sunroof while driving. Vehicle damage may occur if the vehicle suddenly stops.**



### WARNING

**Do not extend your head, arms, body parts or objects outside the sunroof while driving. Injuries may occur if the vehicle suddenly stops.**

## Resetting the Sunroof



In some circumstances resetting the sunroof operation may need to be performed. Some instances where resetting the sunroof may be required include:

- When the 12 V battery is either disconnected or discharged
- When the sunroof fuse is replaced
- If the sunroof one-touch AUTO OPEN/CLOSE operation is not functioning properly

Sunroof resetting procedure:

1. It is recommended to perform the reset procedure with the vehicle engine running. Start the vehicle in P (Park).
2. Make sure the sunroof glass is in the fully closed position. If the sunroof glass is open, push the switch forward until the sunroof glass is fully closed.
3. Release the switch when the sunroof glass is fully closed.
4. Push the switch forward until the sunroof glass moves slightly. Then release the switch.
5. Once again push and hold the sunroof switch forward until the sunroof glass slides open and close. Do not release the switch until the operation is completed. If you release the switch during operation, start the procedure again from step 2.

## Information

If the sunroof is not reset when the vehicle battery connector is disconnected or discharged, or the sunroof fuse is blown, the sunroof may not operate normally.

## Sunroof Open Warning (if equipped)

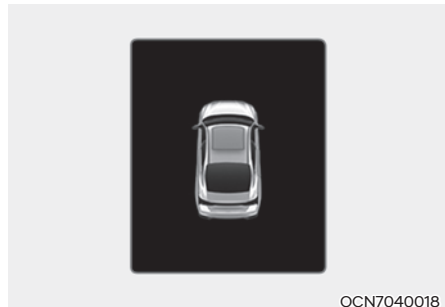

If the driver turns off the engine when the sunroof is not fully closed, the warning chime will sound for several seconds and the sunroof open warning will appear on the cluster LCD display.

Close the sunroof securely when leaving your vehicle.

## CAUTION

**Make sure the sunroof is closed fully when leaving your vehicle.**

**If the sunroof is left open, rain or snow may wet the interior of the vehicle. Also, leaving the sunroof open when the vehicle is unattended may invite theft.**

## HOOD

### Opening the hood

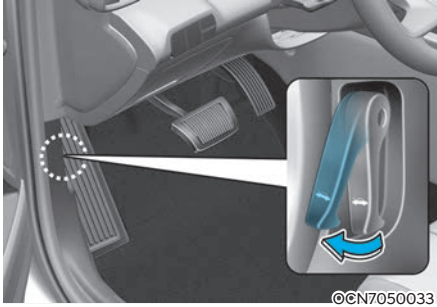

1. Park the vehicle and set the parking brake.
2. Pull the release lever to unlatch the hood. The hood should pop open slightly.

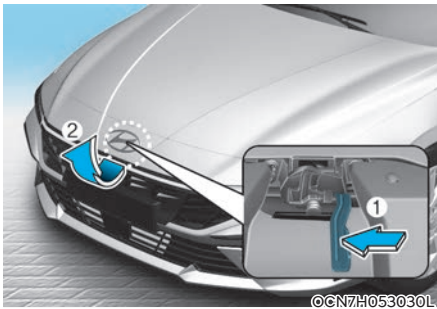

3. Go to the front of the vehicle, raise the hood slightly, push up the secondary hood release lever (1) inside of the hood center and lift the hood (2).
4. Pull out the support rod.



5. Hold the hood open with the support rod (3).

### **WARNING**

#### Support rod

- After driving, the engine compartment and support rod will be hot. Grasp the support rod in the area wrapped in rubber to prevent burns.
- The support rod must be inserted completely into the hole provided whenever you inspect the engine compartment. This will prevent the hood from falling and possibly injuring you.

### ***Closing the hood***

1. Before closing the hood, check the following:
  - All filler caps in engine compartment must be correctly installed.
  - Gloves, rags or any other combustible material must be removed from the engine compartment.
2. Return the support rod to its clip to prevent it from rattling.
3. Lower the hood halfway (lifted approximately 11.8 in. (30 cm) from the closed position) and push down to securely lock in place. Then double check to be sure the hood is secure.

If the hood can be raised slightly, it is not securely locked. Open it again and close it with more force.



### **WARNING**

- **Before closing the hood, ensure all obstructions are removed from around the hood opening.**
- **Always double check to be sure that the hood is firmly latched before driving away. Check there is no hood open warning light or message displayed on the instrument cluster. Driving with the hood opened may cause a total loss of visibility, which might result in an accident.**
- **Do not move the vehicle with the hood in the raised position, as vision is obstructed, which might result in an accident, and the hood could fall or be damaged.**

## TRUNK

### Opening the Trunk

#### Opening from outside



Make sure the shift lever is in P (Park).

Then do one of the following:

- Hold down the trunk unlock button located on your remote key or smart key for more than 1 second.
- Additionally, for vehicles equipped with smart key :
  - While all doors are unlocked, press the switch in the trunk to open the trunk with or without the smart key in your possession.
  - If any door is locked or all doors are locked, the switch can still be used to open the trunk, as long as the smart key is in your possession.

#### Opening from inside



When the trunk is closed, pull the trunk release lever. The trunk will open.

#### Closing the trunk

Lower the trunk lid and press down until it locks. To be sure the trunk lid is securely fastened, always check by trying to pull it up again.



#### WARNING

**Always keep the trunk lid completely closed while the vehicle is in motion. If it is left open or ajar, poisonous exhaust gases containing carbon monoxide (CO) may enter the vehicle and serious illness or death may result.**



#### Information

To prevent damage to the trunk lift cylinders and the attached hardware, always close the trunk before driving.

#### NOTICE

In cold and wet climates, trunk lock and trunk mechanisms may not work properly due to freezing conditions.

## Emergency Trunk Safety Release



Your vehicle is equipped with an Emergency Trunk Safety Release lever located inside the trunk. When someone is inadvertently locked in the trunk, the trunk can be opened by moving the lever in the direction of the arrow and pushing the trunk open.

### **WARNING**

- You and your passengers must be aware of the location of the Emergency Trunk Safety Release lever in this vehicle and how to open the trunk in case you are accidentally locked in the trunk.
- **NEVER** allow anyone to occupy the trunk of the vehicle at any time. If the trunk is partially or totally latched and the person is unable to get out, serious injury or death could occur due to lack of ventilation, exhaust fumes and rapid heat build-up, or because of exposure to cold weather conditions. The trunk is also a highly dangerous location in the event of a crash because it is not a protected occupant space but is a part of the vehicle's crush zone.
- Your vehicle should be kept locked and the Smart Key should be kept out of the reach of children. Parents should teach their children about the dangers of playing in trunks.
- Use the release lever for emergencies only.

## Smart Trunk with Auto Open (if equipped)

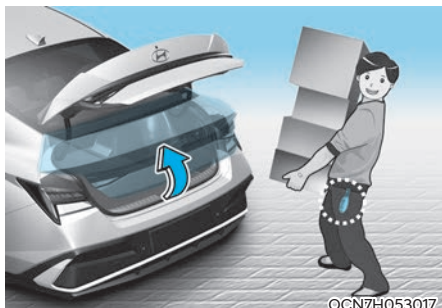

On a vehicle equipped with a smart key, the trunk can be opened using the Smart Trunk release system.

### How to use the Smart Trunk release

The trunk can be opened with no touch activation satisfying all the conditions below.

- After 15 seconds when all doors are closed and locked
- Positioned in the detecting area for more than 3 seconds

### **i** Information

The Smart Trunk release does not operate when:

- The smart key is detected within 15 seconds after the doors are closed and locked, and is continuously detected.
- The smart key is detected within 15 seconds after the doors are closed and locked, and 4.9 ft. (1.5 m) from the front door handles. (for vehicles equipped with Welcome Light)
- A door is not locked or closed.
- The smart key is in the vehicle.

### 1. Setting

To activate the Smart Trunk release, go to User Settings Mode and select Smart Trunk on the cluster display.

**For more details, refer to “Cluster Display” in this chapter. If your vehicle is equipped with additional navigation, please refer to the infotainment system manual separately supplied.**



### 2. Detect and Alert

If you are positioned in the detecting area (20~40 in. (50~100 cm) behind the vehicle) carrying a smart key, the hazard warning lights will blink and chime will sound to alert you the smart key has been detected and the trunk will open.

### **i** Information

**Do not approach the detecting area if you do not want the trunk to open. If you have unintentionally entered the detecting area and the hazard warning lights and chime starts to operate, leave the detecting area with the smart key. The trunk will stay closed.**

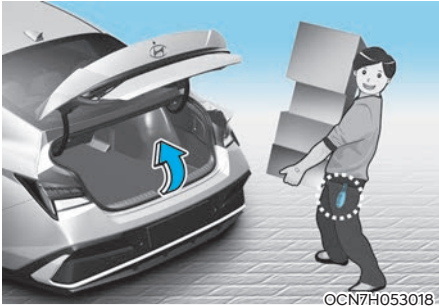

3. Automatic opening

The hazard warning lights will blink and chime will sound 6 times and then the trunk will open.

**WARNING**

- Make sure you close the trunk before driving your vehicle.
- Make sure there are no people or objects around the trunk before opening or closing the trunk.
- Make sure objects in the trunk do not come out when opening the trunk on a slope. It may cause serious injury.
- Make sure to deactivate the Smart Trunk when washing your vehicle. Otherwise, the trunk may open inadvertently.
- The key should be kept out of reach of children. Children may inadvertently open the Smart Trunk release while playing around the rear area of the vehicle.

**How to deactivate the Smart Trunk release function using the smart key**

■ Type A

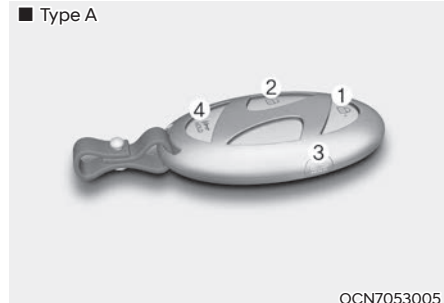

■ Type B

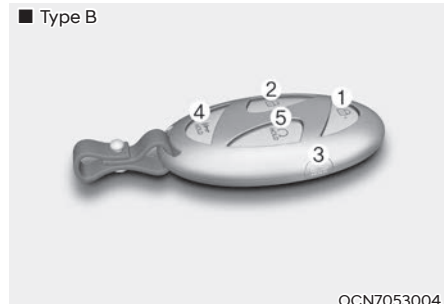

1. Door lock
2. Door unlock
3. Trunk open
4. Panic
5. Remote Start (if equipped)

If you press any button of the smart key during the Detect and Alert stage, the Smart Trunk release function will be deactivated.

Make sure to be aware of how to deactivate the Smart Trunk release function for emergency situations.

### **i** Information

- If you press the door unlock button (2), the Smart Trunk release function will be deactivated temporarily. But, if you do not open any door for 30 seconds, the smart trunk function will be activated again.
- If you press the trunk open button (3) for more than 1 second, the trunk opens.
- If you press the door lock button (1) or trunk open button (3) when the Smart Trunk release function is not in the Detect and Alert stage, the smart trunk function will not be deactivated.
- In case you have deactivated the Smart Trunk function by pressing the smart key button and opened a door, the Smart Trunk release function can be activated again by closing and locking all doors.

### **Detecting area**



- The Smart Trunk release operates with a welcome alert if the smart key is detected within 20~40 in. (50~100 cm) from the trunk.
- The alert stops at once if the smart key is positioned outside the detecting area during the Detect and Alert stage.

### **i** Information

- The Smart Trunk release function will not work if any of the following occurs:
  - The smart key is close to a radio transmitter such as a radio station or an airport which can interfere with normal operation of the transmitter.
  - The smart key is near a mobile two way radio system or a cellular phone.
  - Another vehicle's smart key is being operated close to your vehicle.
- The detecting range may decrease or increase when :
  - One side of the tire is raised to replace a tire or to inspect the vehicle.
  - The vehicle is slantingly parked on a slope or unpaved road, etc.

## FUEL FILLER DOOR

### Opening the Fuel Filler Door



The fuel filler door must be opened from inside the vehicle by pulling up the fuel filler door opener.

1. Turn the engine off.
2. Pull up the fuel filler door opener.

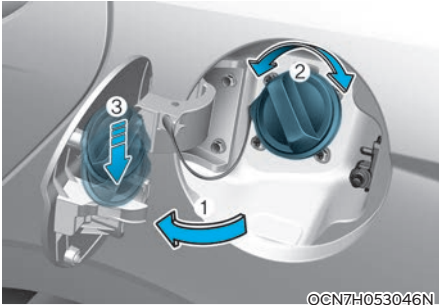

3. Pull the fuel filler door (1) out to fully open.
4. To remove the fuel tank cap (2), turn it counterclockwise. You may hear a hissing noise as the pressure inside the tank equalizes.
5. Place the cap on the fuel filler door.

#### **i** Information

Open and close the reservoir cap by using the handle on the cap cover for safety.

#### **i** Information

If the fuel filler door does not open because ice has formed around it, tap lightly or push on the door to break the ice and release the door. Do not pry on the door. If necessary, spray around the door with an approved de-icer fluid (do not use radiator anti-freeze) or move the vehicle to a warm place and allow the ice to melt.

## Closing the Fuel Filler Door

1. To install the fuel tank cap, turn it clockwise until it “Clicks”.
2. Close the fuel filler door until it is latched securely.

### NOTICE

There may be an intermittent noise near the refueling hole while the engine is idling if the fuel cap is not closed securely. This occurs normally with the OBD system.

### NOTICE

When refueling on unlevel ground, the fuel gauge may not point to the F position.

It is not a malfunction. If you move your vehicle to a level ground, the fuel gauge will move to the full position.



## WARNING

Gasoline is highly flammable and explosive. Failure to follow these guidelines may result in **SERIOUS INJURY** or **DEATH**:

- Read and follow all warnings posted at the gas station.
- Before refueling, note the location of the Emergency Gasoline Shut-Off, if available, at the gas station.
- Before touching the fuel nozzle, you should eliminate the potential build-up of static electricity by touching a metal part of the vehicle, a safe distance away from the fuel filler neck, nozzle, or other gas source, with your bare hand.
- Do not use cellular phones while refueling. Electric current and/or electronic interference from cellular phones can potentially ignite fuel vapors and cause a fire.
- Do not get back into a vehicle once you have begun refueling. You can generate a build-up of static electricity by touching, rubbing or sliding against any item or fabric capable of producing static electricity. Static electricity discharge can ignite fuel vapors causing a fire. If you must re-enter the vehicle, you should once again eliminate potentially dangerous static electricity discharge by touching a metal part of the vehicle, away from the fuel filler neck, nozzle or other gasoline source, with your bare hand.

- When refueling, always move the shift lever to the P (Park) position, set the parking brake, and place the ignition switch to the LOCK/OFF position.

Sparks produced by electrical components related to the engine can ignite fuel vapors causing a fire.

- When using an approved portable fuel container, be sure to place the container on the ground prior to refueling. Static electricity discharge from the container can ignite fuel vapors causing a fire. Once refueling has begun, contact between your bare hand and the vehicle should be maintained until the filling is complete.
- Use only approved portable plastic fuel containers designed to carry and store gasoline.
- Do not use matches or a lighter and do not smoke or leave a lit cigarette in your vehicle while at a gas station, especially during refueling.
- Do not over-fill or top-off your vehicle tank, which can cause gasoline spillage.
- If a fire breaks out during refueling, leave the vicinity of the vehicle, and immediately contact the manager of the gas station and then contact the local fire department. Follow any safety instructions they provide.

- If pressurized fuel sprays out, it can cover your clothes or skin and thus subject you to the risk of fire and burns. Always remove the fuel cap carefully and slowly. If the cap is venting fuel or if you hear a hissing sound, wait until the condition stops before completely removing the cap.
- Always check that the fuel cap is installed securely to prevent fuel spillage in the event of an accident.

### Information

Make sure to refuel your vehicle according to the “Fuel Requirements” suggested in the Introduction chapter.

### **NOTICE**

- Do not spill fuel on the exterior surfaces of the vehicle. Any type of fuel spilled on painted surfaces may damage the paint.
- If the fuel filler cap requires replacement, use only a genuine HYUNDAI cap or the equivalent specified for your vehicle. An incorrect fuel filler cap can result in a serious malfunction of the fuel system or emission control system.

## EXTERIOR LIGHTS

### Lighting Control

To operate the lights, turn the knob at the end of the control lever to one of the following positions:

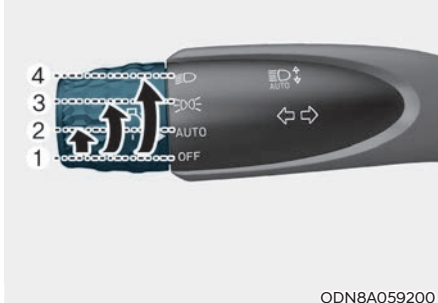

1. OFF
2. AUTO headlight
3. Parking light
4. Headlight

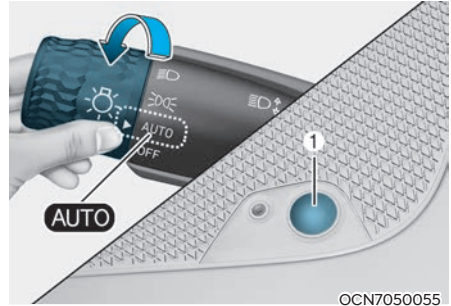

### AUTO headlight

The parking light and headlight will be turned ON or OFF automatically depending on the amount of daylight as measured by the ambient light sensor on the center dash (1).

Even with the AUTO headlight feature in operation, it is recommended to manually turn ON the headlights when driving at night or in a fog, driving in the rain, or when you enter dark areas, such as tunnels and parking facilities.

### NOTICE

- Do not cover or spill anything on the sensor (1) located in front of the instrument panel.
- Do not clean the sensor using a window cleaner, the cleanser may leave a light film which could interfere with sensor operation.
- If your vehicle has window tint or other types of metallic coating on the front windshield, the AUTO headlight system may not work properly.

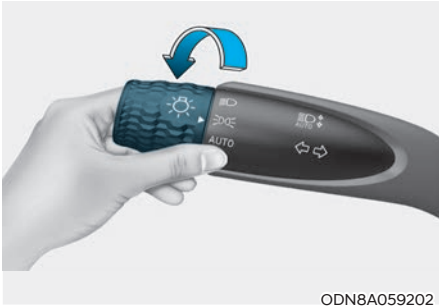

### Parking light (P)

The parking light, license plate light and instrument panel light are turned ON.



### Headlight (H)

The headlight, parking light, license plate light and instrument panel light are turned ON.

### **i** Information

The ignition switch must be in the ON position to turn on the headlight.

## High Beam Operation



To turn on the high beam headlight, push the lever away from you. The lever will return to its original position.

The high beam indicator will light when the headlight high beams are switched on.

To turn off the high beam headlight, pull the lever towards you. The low beams will turn on.

### **!** WARNING

Do not use high beam when there are other vehicles approaching you. Using high beam could obstruct the other driver's vision.

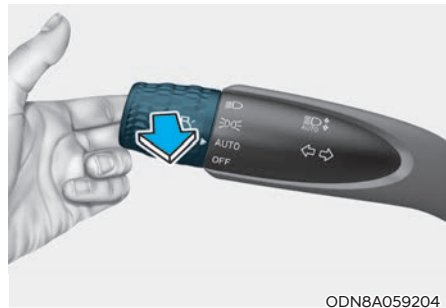

To flash the high beam headlight, pull the lever towards you, then release the lever. The high beams will remain ON as long as you hold the lever towards you.

## Turn Signals and Lane Change Signals

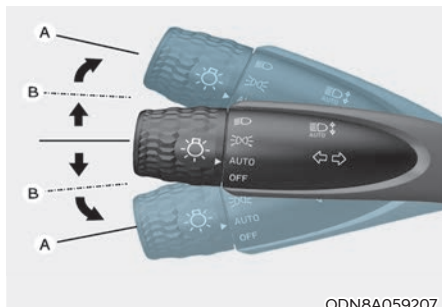

To signal a turn, push down on the lever for a left turn or up for a right turn in position (A). To signal a lane change, move the turn signal lever slightly and hold it in position (B). The lever will return to the OFF position when released or when the turn is completed.

If an indicator stays on and does not flash or if it flashes abnormally, one of the turn signal bulbs may be burned out and will require replacement.

### **One touch turn signal function**

To activate a one-touch turn signal function, move the turn signal lever slightly and then release it. The lane change signals will blink 3, 5 or 7 times.

You can enable the One Touch Turn Signal function or choose the number of blinks from the User Settings Mode on the cluster display.

For more details, refer to “Cluster display modes” in chapter 4. If your vehicle is equipped with additional navigation, please refer to the infotainment system manual separately supplied.

## Battery Saver Function

The purpose of this feature is to help prevent the battery from being discharged. The system automatically turns off the parking light when the driver turns the vehicle off and opens the driver-side door.

With this feature, the parking lights will turn off automatically if the driver parks on the side of road at night.

However, the position lights stay ON even when the driver-side door is opened if the headlight switch is turned to the position light (O) or AUTO (if equipped) position after the engine is turned off.

If necessary, to keep the lights on turn the position lights OFF and ON again using the headlight switch on the steering column after the engine is turned off.

### Headlight Delay Function (if equipped)

If you place the ignition switch in the ACC or LOCK/OFF position with the headlights ON, the headlights (and/or parking lights) remain on for about 5 minutes. However, with the engine off if the driver's door is opened and closed, the headlights (and/or parking lights) are turned off after 15 seconds.

The headlights (and/or parking lights) can be turned off by pressing the lock button on the remote key or smart key twice or turning the light switch to the OFF or AUTO position. However, if you turn the light switch to the AUTO position when it is dark outside, the headlights will not be turned off.

You can enable the headlight delay function from the User Settings Mode in the cluster display.

For more details, refer to "Cluster display modes" in chapter 4. If your vehicle is equipped with additional navigation, please refer to the infotainment system manual separately supplied.

#### **NOTICE**

**If the driver exits the vehicle through another door besides the driver door, the battery saver function does not operate and the headlight delay function does not turn OFF automatically.**

**This may cause the battery to discharge. To avoid battery discharge, turn OFF the headlights manually from the headlight switch before exiting the vehicle.**

### Daytime Running Light (DRL)

The Daytime Running Lights (DRL) can make it easier for others to see the front of your vehicle during the day, especially after dawn and before sunset.

The DRL system will turn the dedicated light OFF when:

- The headlights are ON.
- The parking lights are ON.
- The vehicle is turned off.
- The parking brake is engaged.

## HIGH BEAM ASSIST (HBA) (IF EQUIPPED)

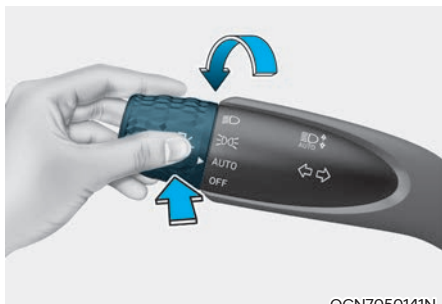

OCN7050141N

High Beam Assist automatically switches between high beam and low beam depending on the detected brightness from the lights of oncoming vehicles or vehicles in front.

### Detecting sensor



©CN7H053033L

[1] : Front view camera

The front view camera is used as a detecting sensor to help detect ambient light and brightness while driving. Refer to the picture above for the detailed location of the detecting sensor.

### NOTICE

- Always keep the front view camera in good condition to maintain optimal performance of High Beam Assist.
- For more details on the precautions of the front view camera, refer to “Forward Collision-Avoidance Assist (FCA)” section in chapter 7.

### High Beam Assist Settings

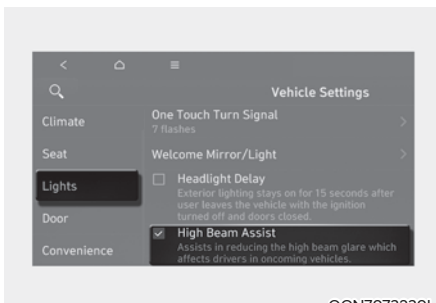

OCN7073239L

With the ignition switch ON, go to the User Settings menu to turn on High Beam Assist and deselect to turn off the function in the instrument cluster.

Select:

**User Settings > Lights > High Beam Assist** (for cluster type)



### WARNING

**Only change the settings after parking your vehicle at a safe location.**

## High Beam Assist Operation

- After selecting **High Beam Assist** from the Settings menu to operate High Beam Assist:
  - Place the headlight switch in the AUTO position and push the headlight lever towards the instrument cluster. The High Beam Assist (HBA) indicator light illuminates.
  - When High Beam Assist is enabled, high beams turn on when the vehicle speed is above 20 mph (30 km/h) and the High Beam (H) indicator illuminates. When the vehicle speed is below 12 mph (20 km), high beams turn off and the indicator light illuminates in white.
- When High Beam Assist is operating:
  - If the turn signal lever is pulled toward you when the high beams are off, the high beams turn on. When you let go of the turn signal lever, High Beam Assist operates again.
  - If the turn signal lever is pulled toward you when the high beams are on by High Beam Assist, the low beams turn on and High Beam Assist turns off.
  - If the turn signal lever is pushed away from you, the high beams turn on and High Beam Assist turns off.
  - If the headlight switch is moved from AUTO to another position (headlight/position/off(O)), the corresponding light turns on and High Beam Assist turns off.

- When High Beam Assist is operating, high beam switches to low beam if:
  - The headlights of an oncoming vehicle are detected.
  - The tail lights of a front vehicle are detected.
  - The headlight or tail light of a motorcycle or a bicycle is detected.
  - The surrounding ambient light is bright enough so high beams are not required.
  - Streetlights or other lights are detected.
  - The vehicle speed drops below the threshold.

### Information

The images and colors in the cluster may differ depending on the cluster type or theme selected from the cluster.

## High Beam Assist Malfunction and Limitations

### *High Beam Assist malfunction*

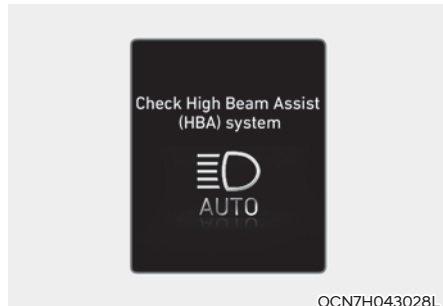

When High Beam Assist is not working properly, the “**Check High Beam Assist (HBA) system**” warning message may appear, and the  warning light may illuminate on the instrument cluster. Contact an authorized HYUNDAI dealer.

### **Limitations of High Beam Assist**

High Beam Assist may not work properly in the following situations if:

- The headlights from an oncoming or front vehicle is damaged or out of the detection range.
- The headlights from an oncoming or front vehicle are covered with dust, snow, or water.
- An oncoming or front vehicle's headlights are off but the fog lights are on.
- There are lights that have a similar shape as a vehicle's light ahead.
- The headlights are not repaired or replaced properly.
- The headlights are not aimed properly.
- You are driving on a narrow curved road, rough road, uphill, or downhill.
- A front vehicle is partially visible at a crossroad or on a curved road.
- There is a temporary reflector or flash ahead (construction area).
- There is a traffic light, reflecting sign, LED sign, or reflectors ahead.
- The road is wet or covered with snow or ice.
- A vehicle suddenly appears from a curve.
- The vehicle is tilted due to a flat tire or being towed.
- The headlights from an oncoming or front vehicle is not detected because of exhaust fumes, smoke, fog, snow, blizzard, water spray on the road, or windshield condensation, etc.



### **Information**

**For more details on the limitations of the front view camera, refer to “Forward Collision-Avoidance Assist (FCA)” section in chapter 7.**



### **WARNING**

- **Always check road conditions, and if necessary, take appropriate actions to drive safely. It is your responsibility to operate your vehicle in a safe manner.**
- **If High Beam Assist does not operate properly, use the turn signal lever to switch between high beam and low beam.**
- **High Beam Assist may not operate for 15 seconds right after your vehicle is started or when the front view camera is initialized.**

## INTERIOR LIGHTS

### WARNING

Do not use the interior lights when driving in the dark. The interior lights may obscure your view and cause an accident.

### NOTICE

Do not use the interior lights for extended periods when the vehicle is turned off or the battery will discharge.

### Interior Lights Auto Off

The interior lamps will automatically go off approximately 20 minutes after the engine is turned off and the doors are closed. If a door is opened, the lamp will go off 40 minutes after the engine is turned off. If the doors are locked by the remote key or smart key and the vehicle enters the armed stage of the theft alarm system, the lamps will go off five seconds later.

## Front Lamps

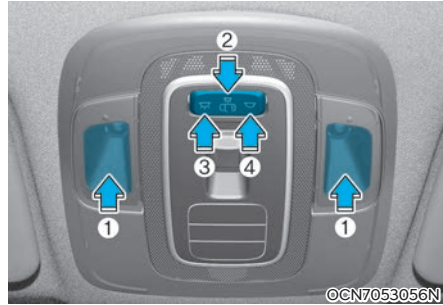

- (1) Front Map Lamp
- (2) Front Door Lamp
- (3) Front Room Lamp ON
- (4) Front Room Lamp OFF



### Front map lamp:

Press either of these lens to turn the map lamp on or off. This light produces a spot beam for convenient use as a map lamp at night or as a personal lamp for the driver and the front passenger.

### Front Door Lamp ( ):

The front or rear room lamps come on when the front or rear doors are opened if the engine is running or not. When doors are unlocked by the remote key or smart key, the front and rear lamps come on for approximately 30 seconds as long as any door is not opened. The front and rear room lamps go out gradually after approximately 30 seconds if the door is closed. However, if the ignition switch is in the ON position or all doors are locked, the front and rear lamps will turn off. If a door is opened with the Ignition switch in the ACC position or the ON/OFF position, the front and rear lamps stay on for about 20 minutes.

### Front room lamp

- : Press the button to turn ON the room lamp for the front/rear seats.
- : Press the button to turn OFF the room lamp for the front/rear seats.

### Mood lamp (if equipped)

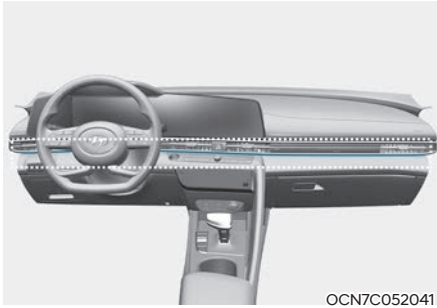

The lamp turns on when 'User settings → Lights → Ambient Light' is selected from the infotainment system.

### Information

- The infotainment system may change after software updates. For more information, refer to the user's manual provided in the infotainment system and the quick reference guide.
- The color of the mood lamp may seem different under some conditions depending on the color of the interior and the set mood color.

### Room Lamp



### Rear Room Lamp ():

Press this switch to turn the rear room lamp on and off.

### **NOTICE**

**Do not leave the lamp switches on for an extended period of time when the engine is turned off.**

### Luggage Compartment Lamp



The luggage compartment lamp comes on when the trunk is opened.

**NOTICE**

The luggage compartment lamp comes on as long as the trunk is open. To prevent unnecessary battery system drain, close the trunk securely after using the luggage compartment.

### Vanity Mirror Lamp (if equipped)

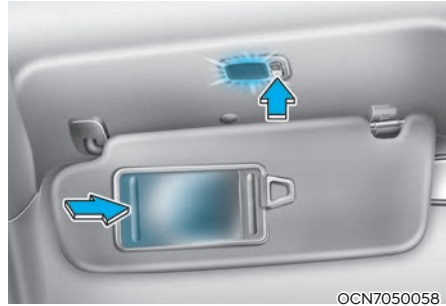

Push the switch to turn the light on or off.

- ☀️ : The lamp will turn on if this button is pressed.
- : The lamp will turn off if this button is pressed.

**NOTICE**

Always have the switch in the off position when the vanity mirror lamp is not in use. If the sunvisor is closed without the lamp off, it may discharge the battery or damage the sunvisor.

## Welcome System (if equipped)

### Welcome light



### Door handle lamp (if equipped)

When all the doors (and trunk) are closed and locked, the door handle lamp will come on for about 15 seconds if any of the below is performed.

- When the door unlock button is pressed on the remote key or smart key.
- When the button of the outside door handle is pressed.
- When the vehicle is approached with the smart key in possession.

### Headlight and parking lamp

When the headlight (lamp switch in the headlight or AUTO position) is on and all doors (and trunk) are locked and closed, the headlight and parking lamp will come on for 15 seconds if/or any of the below is performed.

- When the door unlock button is pressed on the remote key or smart key.

At this time, if you press the door lock or unlock button, the headlight and parking lamp will turn off immediately.

You can activate or deactivate the welcome Light from the User Settings Mode on the cluster display. **For more details, refer to “Cluster Display” in chapter 4. If your vehicle is equipped with additional navigation, please refer to the infotainment system manual separately supplied.**

### Interior lamp

When the interior lamp switch is in the DOOR position and all doors (and trunk) are closed and locked, the room lamp will come on for 30 seconds if any of the below is performed.

- When the door unlock button is pressed on the remote key or smart key.
- When the button of the outside door handle is pressed.

At this time, if you press the door lock or unlock button, the room lamp will turn off immediately.

## WIPERS AND WASHERS

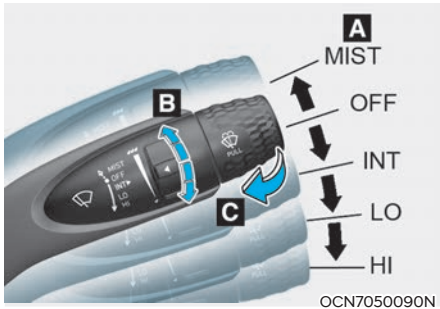

### A. Wiper speed control

- MIST – Single wipe
- OFF – Off
- INT / --- – Intermittent wipe
- LO– Low wiper speed
- HI – High wiper speed

### B. Intermittent control wipe time adjustment

### C. Wash with brief wipes (pull lever towards you)

## Windshield Wipers

Operates as follows when the ignition switch is in the ON position.

**MIST:** For a single wiping cycle, push the lever upward and release. The wipers will operate continuously if the lever is held in this position.

**OFF:** Wiper is not in operation.

**INT:** Wiper operates intermittently at the same wiping intervals. To vary the speed setting, move the speed control lever. The top most setting will run the wipers most frequently (for more rain). The bottom setting will run the wipers the least frequently (for less rain).

**LO:** The wiper runs at a lower speed.

**HI:** The wiper runs at a higher speed.

## **i** Information

**If there is heavy accumulation of snow or ice on the windshield, defrost the windshield for about 10 minutes, or until the snow and/or ice is removed before using the windshield wipers to ensure proper operation.**

**If you do not remove the snow and/or ice before using the wiper and washer, it may damage the wiper and washer system.**

## Windshield Washers



In the OFF position, pull the lever gently toward you to spray washer fluid on the windshield and to run the wipers 1-3 cycles. The spray and wiper operation will continue until you release the lever. If the washer does not work, you may need to add washer fluid to the washer fluid reservoir.

### WARNING

**When the outside temperature is below freezing, ALWAYS warm the windshield using the defroster to help prevent the washer fluid from freezing on the windshield and obscuring your vision which could result in an accident and serious injury or death.**

### NOTICE

- To prevent possible damage to the washer pump, do not operate the washer when the fluid reservoir is empty.
- To prevent possible damage to the wipers or windshield, do not operate the wipers when the windshield is dry.
- To prevent damage to the wiper arms and other components, do not attempt to move the wipers manually.
- To prevent possible damage to the wipers and washer system, use anti-freezing washer fluids in the winter season or cold weather.

## AUTOMATIC CLIMATE CONTROL SYSTEM



OCN7050110L

1. Driver's temperature control knob
2. Passenger's temperature control knob
3. AUTO (automatic control) button
4. SYNC button
5. OFF button
6. Front windshield defroster button
7. Air conditioning button
8. Air intake control button
9. Rear window defroster button
10. Fan speed control button
11. Mode selection button
12. Climate control information screen

## Automatic Heating and Air Conditioning



### 1. Press the AUTO button

The modes, fan speeds, air intake and air-conditioning will be controlled automatically according to the temperature setting you select.

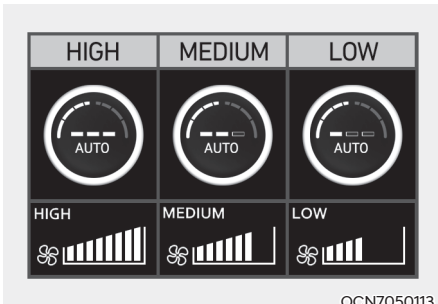

You can control the blower strength in three stages by pushing the AUTO button during automatic operation.

- HIGH : Provide rapid air conditioning and heating with strong blower
- MEDIUM : Provide air conditioning and heating with medium strength blower
- LOW : Is suitable for drivers that prefer lower air speeds

When you select the temperature to HI or LO in AUTO mode, the fan speed is set to 'HIGH'.

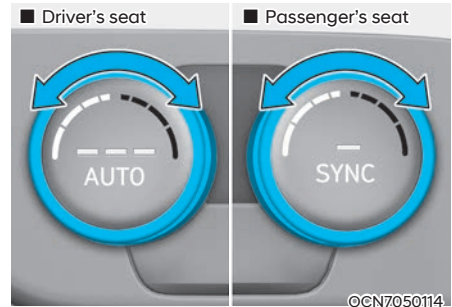

### 2. Turn the temperature control knob

to set the desired temperature. If the temperature is set to the lowest setting (Lo), the air conditioning system will operate continuously.

- To turn the automatic operation off, select any button of the following:
  - Mode selection button
  - Front windshield defroster button (Press the button one more time to deselect the front windshield defroster function. The 'AUTO' sign will illuminate on the information screen once again.)
  - Fan speed control toggle switch  
The selected function will be controlled manually while other functions operate automatically.
- For your convenience and overall system efficiency, use the AUTO button and set the temperature to 72°F (22°C).

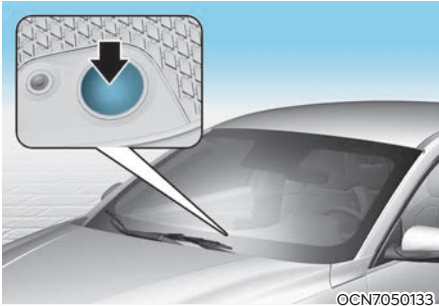

**i Information**

**Never place anything near the sensor to ensure better control of the heating and cooling system.**

### Manual Heating and Air Conditioning

The heating and cooling system can be controlled manually by pushing buttons other than the AUTO button. In this case, the system works sequentially according to the order of buttons selected. When pressing any button except the AUTO button while using automatic operation, the functions not selected will be controlled automatically.

1. Start the engine.
2. Set the mode to the desired position.  
To improve the effectiveness of heating and cooling, select the mode according to the following:
  - Heating:
  - Cooling:
3. Set the temperature control to the desired position.
4. Set the air intake control to fresh mode.
5. Set the fan speed control to the desired speed.
6. If air conditioning is desired, turn the air conditioning system on.
7. Press the AUTO button in order to convert to full automatic control of the system.

### Mode selection

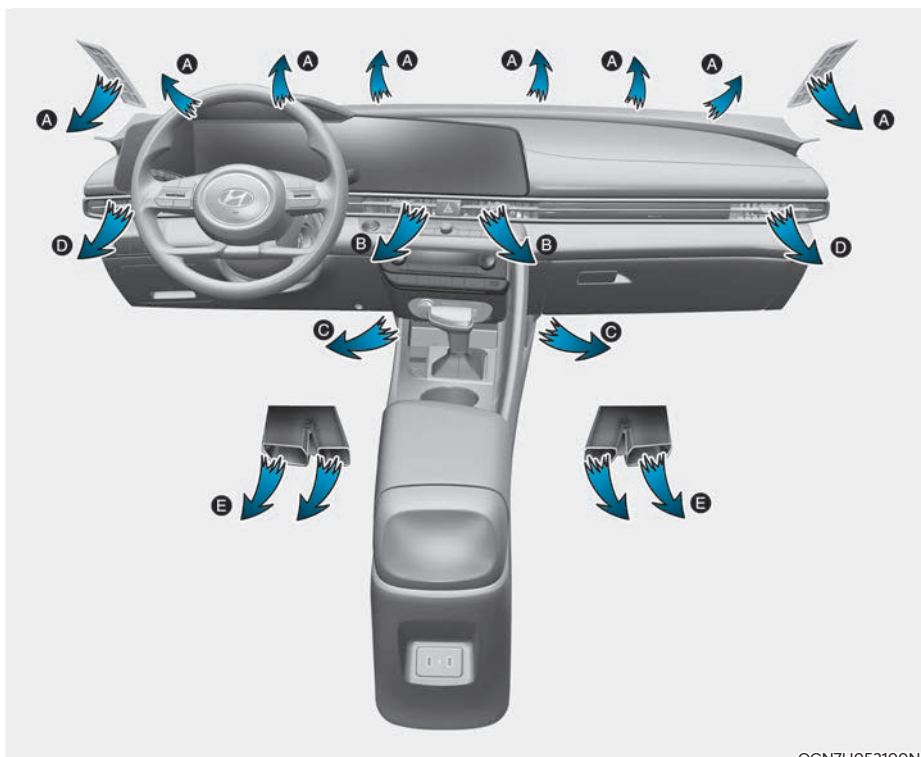

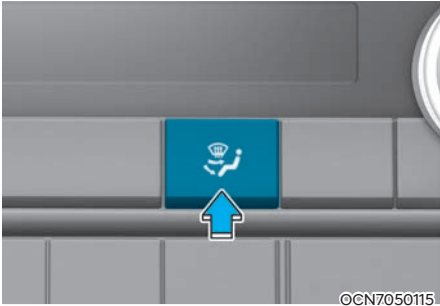

©CN7050115

The mode selection toggle switch controls the direction of the air flow through the ventilation system.

The air flow outlet direction is cycled as follows:



 **Face-level (B, D)**

Air flow is directed toward the upper body and face. Additionally, each outlet can be controlled to direct the air discharged from the outlet.

 **Bi-Level (B, C, D, E)**

Air flow is directed towards the face and the floor.

 **Floor-Level (C, E)**

Most of the air flow is directed to the floor, with a small amount of the air being directed to the windshield and side window defrosters.

 **Floor & Defrost (A, C, D, E)**

Most of the air flow is directed to the floor and the windshield with a small amount directed to the side window defrosters.

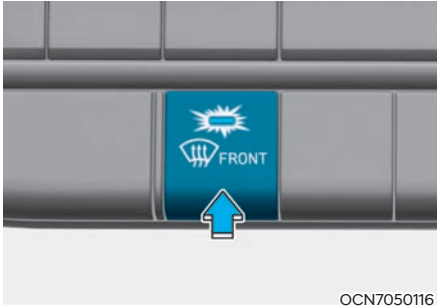

OCN7050116

### Defrost-Level (A, D)

Most of the air flow is directed to the windshield with a small amount of air directed to the side window defrosters.

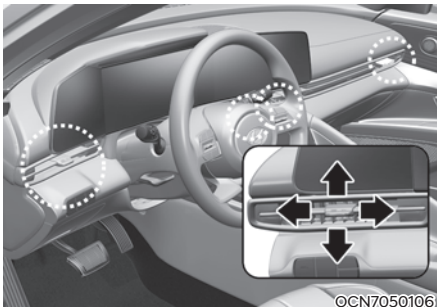

OCN7050106

### Instrument panel vents

The instrument panel vent air flow can be directed up/down or left/right using the vent adjustment lever.

To close the vent, push the air vent lever in the opposite direction of the passenger. To open the vent, push the air vent lever in the same direction of the passenger.

### Temperature control

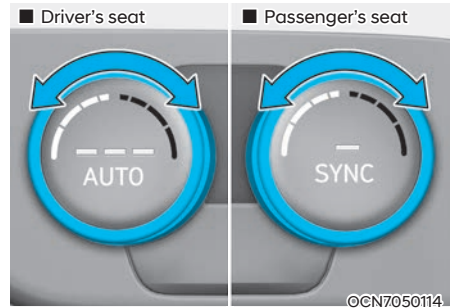

OCN7050114

The temperature will increase by turning the knob to the right.

The temperature will decrease by turning the knob to the left.

The temperature will increase or decrease by 1°F (0.5°C) for each incremental location. When set to the lowest temperature setting, the air conditioning will operate continuously.



### Adjusting the driver and passenger side temperature equally

- Press the “SYNC” button to adjust the driver and passenger side temperature equally.
- The passenger side temperature will be set to the same temperature as the driver side temperature.
- Turn the driver side temperature control knob. The driver and passenger side temperature will be adjusted equally.
- If you rotate the passenger’s temperature control knob, the SYNC button is off and the passenger side temperature can be operated individually.

### Adjusting the driver and passenger side temperature individually

Press the “SYNC” button again to adjust the driver and passenger side temperature individually. The button indicator will turn off.

### Temperature conversion

If the battery connector has been discharged or disconnected, the temperature mode display will reset to Centigrade.

To change the temperature unit from °C to °F or °F to °C :

- Automatic climate control system  
Press the AUTO button for 3 seconds while pressing the OFF button.
- Instrument cluster Automatic climate control system  
Go to User Settings → Other → Temperature Unit.  
The temperature unit on both the cluster LCD display and the climate control screen will change.

### Information

**When starting the vehicle in cold weather using manual temperature control, operate the system in the following method to improve heating.**

- **Turn off or lower the blower, right after starting the engine.**
- **Allow the engine to warm up during this time since the air flow from the heater is still cold.**
- **After a few minutes of engine warm up, turn on or set the fan to a higher level and adjust the temperature setting to hot.**

## Air intake control

### Recirculated air position



With the recirculated air position selected, air from the passenger compartment will be drawn through the heating system and heated or cooled according to the function selected.

### Outside (fresh) air position



With the outside (fresh) air position selected, air enters the vehicle from outside and is heated or cooled according to the function selected.



## Information

Operating the system primarily in Fresh mode is recommended. Use Recirculation mode temporarily only when needed.

Prolonged operation of the heater in Recirculation mode and without the A/C ON can cause fogging of the windshield.

In addition, prolonged use of the A/C ON in Recirculation mode may result in excessively dry, dehumidified air in the cabin and may promote formation of musty vent odor due to stagnant air.



## WARNING

- Continued use of the climate control system operation in Recirculation mode for a prolonged period of time may cause drowsiness to the occupants in the cabin. This may lead to loss of vehicle control which may lead to an accident.
- Continued use of the climate control system operation in Recirculation mode with the A/C OFF may allow humidity to increase inside the cabin. This may cause condensation to accumulate on the windshield and obscure visibility.

- Do not sleep in your vehicle or remain parked in your vehicle with the windows up and either the heater or the air conditioning ON for prolonged periods of time. Doing so may increase the levels of carbon dioxide in the cabin which may lead to serious injury or death.

## Fan speed control

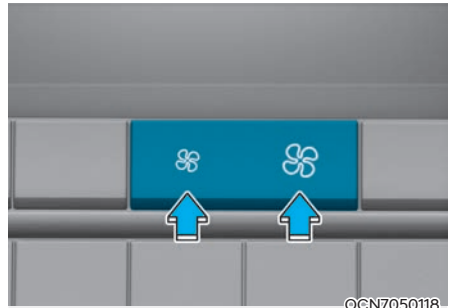

The fan speed can be set to the desired speed by using the fan speed control button.

More air is delivered with higher fan speeds.

Pressing the OFF button turns off the fan.

## NOTICE

Operating the fan speed when the ignition switch is in the ON position could cause the battery to discharge. Operate the fan speed when the engine is running.

### Air conditioning

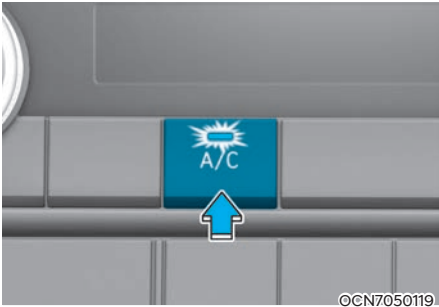

Push the A/C button to manually turn the air conditioning system on (indicator light will illuminate).

Push the button again to turn the air conditioning system off.

### OFF mode

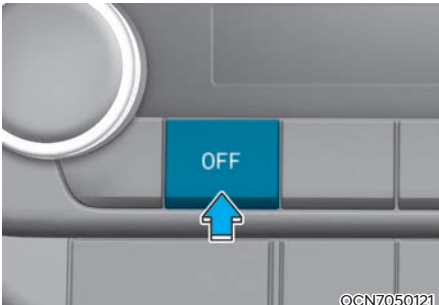

Push the OFF button of the front to turn off the air climate control system. However, you can still operate the mode and air intake buttons as long as the ignition switch is in the ON position.



## System Operation

### Ventilation

1. Select the Face Level  mode.
2. Set the air intake control to fresh mode.
3. Set the temperature control to the desired position.
4. Set the fan speed control to the desired speed.

### Heating

1. Select the Floor Level  mode.
2. Set the air intake control to fresh mode.
3. Set the temperature control to the desired position.
4. Set the fan speed control to the desired speed.
5. If desired, turn the air conditioning ON with the temperature control knob set to heat in order to dehumidify the air before it enters into the cabin.

If the windshield fogs up, select the Front & Defrost  mode or press the Front Defrost  mode.

### Operation Tips

- To help keep dust or unpleasant fumes from entering the vehicle through the ventilation system, temporarily set the air intake control to the recirculation mode. Be sure to return the control to fresh mode position when the irritation has passed to keep fresh air in the vehicle. This will help keep the driver alert and comfortable.
- To help prevent interior fog on the windshield, set the air intake control to fresh mode and fan speed to the desired position, turn on the air conditioning system, and adjust the temperature control to desired temperature.

### Air conditioning

HYUNDAI Air Conditioning Systems are filled with R-1234yf refrigerant.

1. Start the vehicle.
2. Push the air conditioning button.
3. Select the Face Level  mode.
4. Set the air intake control to Recirculation mode temporarily to allow the cabin to cool quickly. When the desired temperature in the cabin is reached, change the air intake control back to Fresh mode.
5. Adjust the fan speed control and temperature control to maintain maximum comfort.

### Information

**Your vehicle is filled with R-1234yf according to the regulation in your country at the time of production. You can find out which air conditioning refrigerant is applied to your vehicle on the label located inside of the hood.**

### NOTICE

**When using the air conditioning system, monitor the temperature gauge closely while driving up hills or in heavy traffic when outside temperatures are high. Air conditioning system operation may cause engine overheating. Continue to use the blower fan but turn the air conditioning system off if the temperature gauge indicates engine overheating.**

### Air conditioning system operation tips

- If the vehicle has been parked in direct sunlight during hot weather, open the windows for a short time to let the hot air inside the vehicle escape.
- After sufficient cooling has been achieved, switch back from recirculation mode to fresh mode.
- To help reduce moisture inside of the windows on rainy or humid days, decrease the humidity inside the vehicle by operating the air conditioning system with the windows and sunroof closed.
- During air conditioning system operation, you may occasionally notice a slight change in engine speed as the air conditioning compressor cycles. This is a normal system operation characteristic.
- Use the air conditioning system every month only for a few minutes to ensure maximum system performance.
- When using the air conditioning system, you may notice clear water dripping (or even puddling) on the ground under the passenger side of the vehicle. This is a normal system operation characteristic.
- If you operate the air conditioner excessively, the difference between the temperature of the outside air and that of the windshield could cause the outer surface of the windshield to fog up, causing loss of visibility. In this case, set the mode selection button to the  position and set the fan speed control knob to the lowest speed setting.

## System Maintenance

### Cabin air filter

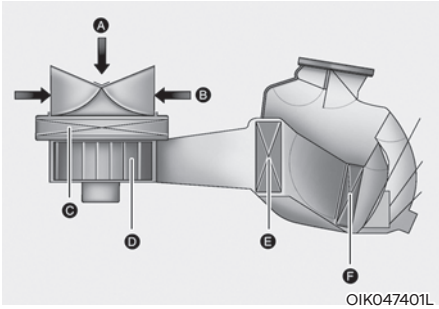

[A] : Outside air, [B] : Recirculated air  
[C] : Cabin air filter, [D] : Blower  
[E] : Evaporator core, [F] : Heater core

The cabin air filter is installed behind the glove box. It filters the dust or other pollutants that enter the vehicle through the heating and air conditioning system.

Have the cabin air filter replaced by an authorized HYUNDAI dealer according to the maintenance schedule. If the vehicle is being driven in severe conditions such as dusty or rough roads, more frequent cabin air filter inspections and changes are required.

If the air flow rate suddenly decreases, the system should be checked at an authorized HYUNDAI dealer.

### **i** Information

- **Replace the filter according to the Maintenance Schedule.**
- **If the car is being driven in severe conditions such as dusty, rough roads, more frequent cabin air filter inspections and changes are required.**
- **When the air flow rate suddenly decreases, have the system checked by an authorized HYUNDAI dealer.**

### **Checking the amount of air conditioner refrigerant and compressor lubricant**

When the amount of refrigerant is low, the performance of the air conditioning is reduced. Overfilling also reduces the performance of the air conditioning system.

Therefore, if abnormal operation is found, have the system inspected by an authorized HYUNDAI dealer.

### **NOTICE**

**It is important that the correct type and amount of oil and refrigerant are used. Otherwise, damage to the compressor and abnormal system operation may occur. To prevent damage, the air conditioning system in your vehicle should only be serviced by trained and certified technicians.**

### **NOTICE**

- **The refrigerant system should only be serviced by trained and certified technicians to insure proper and safe operation.**
- **The refrigerant system should be serviced in a well-ventilated place.**
- **The air conditioning evaporator (cooling coil) shall never be repaired or replaced with one removed from a used or salvaged vehicle and new replacement MAC evaporators shall be certified (and labeled) as meeting SAE Standard J2842.**

**WARNING**

Vehicles equipped with R-1234yf



Since the refrigerant is mildly flammable and operated at high pressure, the air conditioning system should only be serviced by trained and certified technicians. It is important that the correct type and amount of oil and refrigerant are used.



All refrigerants should be reclaimed with proper equipment.

Venting refrigerants directly to the atmosphere is harmful to individuals and environment. Failure to heed these warnings can lead to serious injuries.

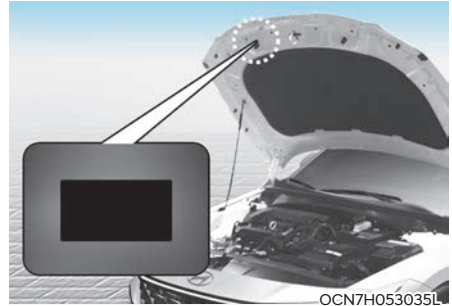

OCN7H053035L

### Air conditioning refrigerant label

You can find out which air conditioning refrigerant is applied to your vehicle on the label located inside of the hood.

#### ■ Example



OHYK059002

Each symbols and specification on the air conditioning refrigerant label is represented as below:

1. Classification of refrigerant
2. Amount of refrigerant
3. Classification of Compressor lubricant
4. Caution
5. Flammable refrigerant
6. To require registered technician to service air conditioning system

## WINDSHIELD DEFROSTING AND DEFOGGING



### WARNING

#### Windshield heating

Do not use the or position during cooling operation in extremely humid weather. The difference between the temperature of the outside air and that of the windshield could cause the outer surface of the windshield to fog up, causing loss of visibility. In this case, set the mode selection knob or button to the position and fan speed control knob or button to lower speed.

- For maximum defrost performance, set the temperature control knob to the highest temperature setting (rotated all the way to the right) and the fan speed control to the highest setting.
- If warm air to the floor is desired while defrosting or defogging, set the mode to the floor-defrost position.
- Before driving, clear all snow and ice from the windshield, rear window, side view mirrors, and all side windows.
- Clear all snow and ice from the hood and air inlet in the cowl grill to improve heater and defroster efficiency and to reduce the probability of fogging up inside of the windshield.

### Automatic Climate Control System

#### To defog inside windshield

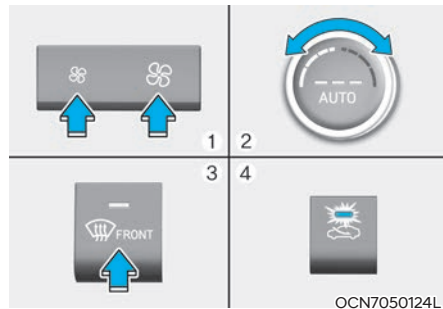

1. Select desired fan speed.
2. Select desired temperature.
3. Press the defroster button ().
4. The air-conditioning will turn on according to the detected ambient temperature, fresh mode and higher fan speed will be selected automatically.

If the air-conditioning, fresh mode and higher fan speed are not selected automatically, adjust the corresponding button or knob manually.

If the position is selected, lower fan speed is controlled to higher fan speed.

### To defrost outside windshield

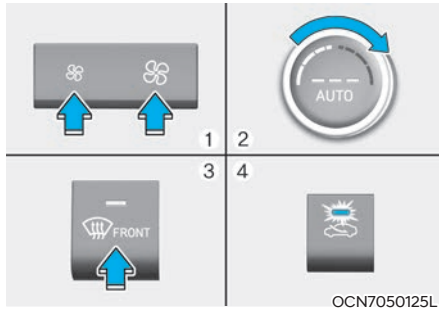

1. Set fan speed to the highest position.
2. Set temperature to the extreme hot (HI) position.
3. Press the defroster button (🌬️).
4. The air-conditioning will turn on according to the detected ambient temperature and fresh mode will be selected automatically.

If the 🌬️ position is selected, lower fan speed is controlled to higher fan speed.

### Defogging Logic

To help reduce the probability of fogging up the inside of the windshield, the air intake or air conditioning are controlled automatically according to certain conditions such as 🌬️ or 🌬️ position. To cancel or return the defogging logic, do the following

#### Manual climate control system

1. Turn the ignition switch to the ON position.
2. Select defroster mode (🌬️).
3. Press the air intake control button at least 5 times within 3 seconds. The process should be completed within 10 seconds after the defroster mode (🌬️) is selected.

The LED indicator on the air intake button will blink 3 times to indicate that the defogging logic has been disabled.

Repeat the steps again to re-enable the defogging logic.

If the battery has been discharged or disconnected, it resets to the defog logic status.

#### Automatic climate control system

1. Turn the ignition switch to the ON position.
2. Press the defroster button (🌬️).
3. While pressing the air conditioning button (A/C), press the air intake control button at least 5 times within 3 seconds.

The automatic climate control information screen will blink 3 times to indicate that the defogging logic has been disabled.

Repeat the steps again to re-enable the defogging logic.

If the battery connector has been discharged or disconnected, it resets to the defog logic status.

## Auto Defogging System

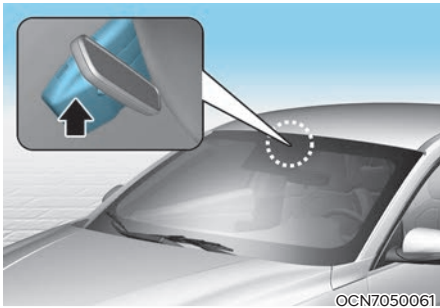

Auto defogging helps reduce the possibility of fogging up the inside of the windshield by automatically sensing the moisture on inside the windshield.

The auto defogging system operates when the heater or air conditioning is on.



When the Auto Defogging System operates, the indicator will illuminate.

If a high amount of humidity is detected in the vehicle, the Auto Defogging System will be enabled.

The following steps will be performed automatically:

- Step 1) The A/C button will turn ON.
- Step 2) The air intake control will change to Fresh mode under low outside temperature.
- Step 3) The mode will be changed to defrost to direct airflow to the windshield.
- Step 4) The fan speed will be increased.

### To cancel or reset the Auto Defogging System

Press the front windshield defroster button for 3 seconds when the ignition switch is in the ON position.

When the Auto Defogging System is canceled, defrost button indicator will blink 3 times.

When the Auto Defogging System is reset, defrost button indicator will blink 6 times without a signal.

### **i** Information

- **When the air conditioning is turned on by Auto defogging system, if you try to turn off the air conditioning, the indicator will blink 3 times and the air conditioning will not be turned off.**
- **To maintain the effectiveness and efficiency of the Auto Defogging System, do not select Recirculation mode while the system is operating.**
- **When the Auto Defogging System is operating, the fan speed adjustment knob, the temperature adjustment knob, and the air intake control button are all disabled.**

### **NOTICE**

**Do not remove the sensor cover located on the upper end of the driver side windshield glass.**

**Damage to system parts could occur and may not be covered by your vehicle warranty.**

## Defroster

### NOTICE

To prevent damage to the conductors bonded to the inside surface of the rear window, never use sharp instruments or window cleaners containing abrasives to clean the window.

### **i** Information

If you want to defrost and defog the front windshield, refer to “Windshield Defrosting and Defogging” in this chapter.

### Rear window defroster

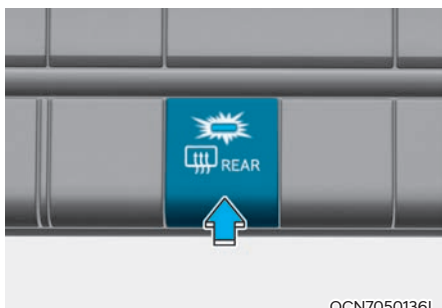

OCN7050136L

The defroster heats the window to remove frost, fog and thin ice from the interior and exterior of the rear window, while engine is running.

- To activate the rear window defroster, press the rear window defroster button located in the center facia switch panel. The indicator on the rear window defroster button illuminates when the defroster is ON.
- To turn off the defroster, press the rear window defroster button again.

### **i** Information

- If there is heavy accumulation of snow on the rear window, brush it off before operating the rear defroster.
- The rear window defroster automatically turns off after approximately 20 minutes or when the ignition switch is in the LOCK/OFF position.

### Outside mirror defroster (if equipped)

If your vehicle is equipped with the outside mirror defrosters, they will operate at the same time you turn on the rear window defroster.

## CLIMATE CONTROL ADDITIONAL FEATURES

### Sunroof Inside Air Recirculation (if equipped)

When the sunroof is opened, outside (fresh) air will be automatically selected. At this time, if you press the air intake control button, recirculated air position will be selected but will change back to outside (fresh) air after 3 minutes. When the sunroof is closed, the air intake position will return to the original position that was selected.

### Auto Comfort Control (for driver's seat) (if equipped)

The temperature of the driver's seat warmer, air ventilation seat and heated steering wheel is automatically controlled depending on the inside and outside temperature of the vehicle when the engine is running.

To use this function, it must be activated from the Settings menu in the Infotainment system screen. Select:

- All menus → Setup → Vehicle → Heated / Ventilated Features

**For more details on Auto Comfort Control, refer to “Seat warmers and air ventilation seat” in chapter 3, and “Heated steering wheel” in chapter 5.**

### Automatic Ventilation (if equipped)

The system automatically selects the fresh mode when the climate control system operates over a certain period of time (approximately 30 minutes) in low temperature with the recirculation mode selected.

#### ***To cancel or reactivate the Automatic Ventilation***

When the air conditioning system is on, select Face Level  mode and press the air recirculation mode button at least 5 times within 3 seconds while pressing the A/C button.

When the automatic ventilation is canceled, the indicator blinks 3 times. When the automatic ventilation is activated, the indicator blinks 6 times.

## STORAGE COMPARTMENT



### WARNING

Never store cigarette lighters, propane cylinders, or other flammable/explosive materials in the vehicle. These items may catch fire and/or explode if the vehicle is exposed to hot temperatures for extended periods.



### WARNING

ALWAYS keep the storage compartment covers closed securely while driving. Items inside your vehicle are moving as fast as the vehicle. If you have to stop or turn quickly, or if there is a crash, the items may fly out of the compartment and may cause an injury if they strike the driver or a passenger.

### NOTICE

To avoid possible theft, do not leave valuables in the storage compartments.

## Center Console Storage

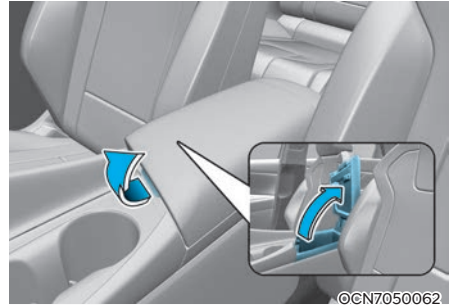

To open:

Grab and hold the latch on the armrest then lift the lid.

## Glove Box

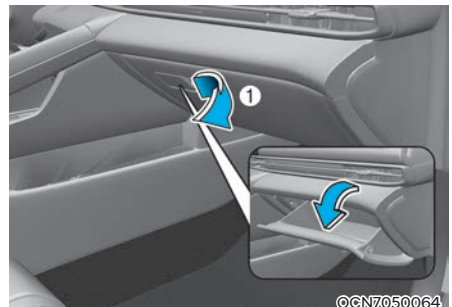

To open:

Pull the lever (1).



### WARNING

ALWAYS close the glove box door after use.

An open glove box door can cause serious injury to the passenger in an accident, even if the passenger is wearing a seat belt.

## INTERIOR FEATURES

### Cup Holder (if equipped)

#### Front

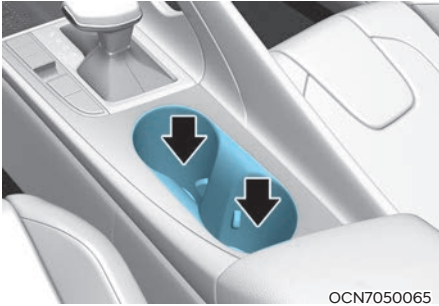

#### Rear

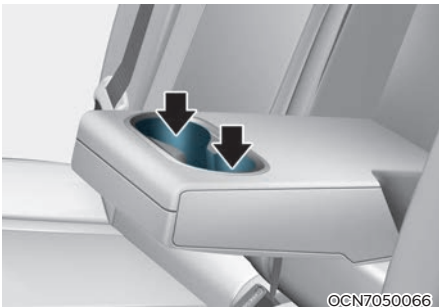

Cups or small beverages cups may be placed in the cup holders.

#### **WARNING**

- Avoid abrupt starting and braking when the cup holder is in use to prevent spilling your drink. If hot liquid spills, you could be burned. Such a burn to the driver could cause loss of vehicle control resulting in an accident.
- Do not place uncovered or unsecured cups, bottles, cans, etc., in the cup holder containing hot liquid while the vehicle is in motion. Injuries may result in the event of a sudden stop or collision.
- Only use soft cups in the cup holders. Hard objects can injure you in an accident.

#### **WARNING**

Keep cans or bottles out of direct sun light and do not put them in a hot vehicle. It may explode.

#### **NOTICE**

- Keep your drinks sealed while driving to prevent spilling your drink. If liquid spills, it may get into the vehicle's electrical/electronic system and damage electrical/electronic parts.
- When cleaning spilled liquids do not use hot air to blow out or dry the cup holder. This may damage the interior.

## Sunvisor

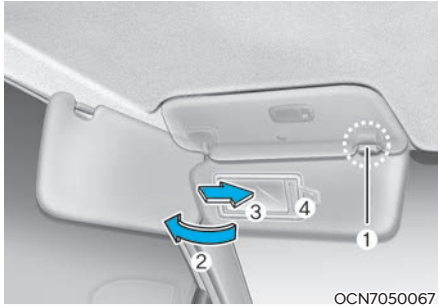

To use a sunvisor, pull it downward.

To use a sunvisor for a side window, pull it downward, unsnap it from the bracket (1) and swing it to the side (2).

To use the vanity mirror, pull down the sunvisor and slide the mirror cover (3).

Adjust the sunvisor forward or backward (4, if equipped) as needed.

Use the ticket holder (5) to hold tickets.

Close the vanity mirror cover securely and return the sunvisor to its original position after use.

### NOTICE

Close the vanity mirror cover securely and return the sunvisor to its original position after use.



### WARNING

For your safety, do not block your view when using the sunvisor.

### NOTICE

Do not put several tickets in the ticket holder at one time. This could cause damage to the ticket holder.

## Power Outlet

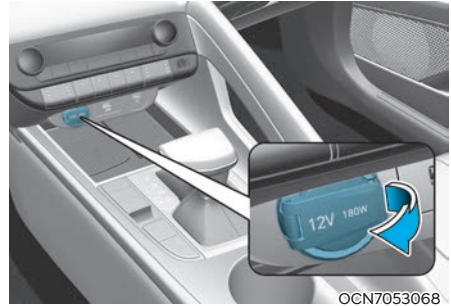

The power outlet is designed to provide power for mobile telephones or other devices designed to operate with vehicle electrical systems. The devices should draw less than 180 W with the engine running.



### WARNING

Avoid electrical shocks. Do not place your fingers or foreign objects (pin, etc.) into a power outlet or touch the power outlet with a wet hand.



### CAUTION

To prevent damage to the Power Outlets:

- Use the power outlet only when the engine is running and remove the accessory plug after use. Using the accessory plug for prolonged periods of time with the engine off could cause the battery to discharge.
- Only use 12 V electric accessories which are less than 15 A in electric capacity.
- Adjust the air-conditioner or heater to the lowest operating level when using the power outlet.
- Close the cover when not in use.
- Some electronic devices can cause electronic interference when plugged into a vehicle's power outlet. These devices may cause excessive audio static and malfunctions in other electronic systems or devices used in your vehicle.
- Push the plug in as far as it will go. If good contact is not made, the plug may overheat and the fuse may open.
- Plug in battery equipped electrical/ electronic devices with reverse current protection. The current from the battery may flow into the vehicle's electrical/electronic system and cause system malfunction.

### USB Charger

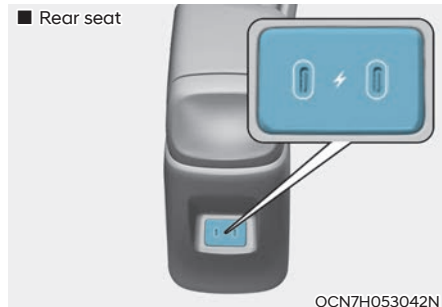
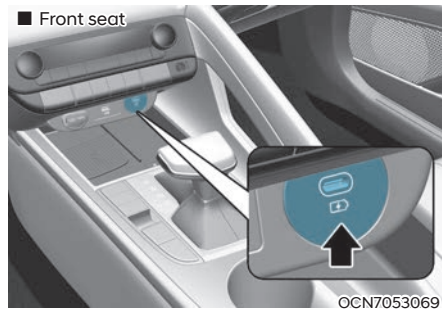

The USB charger is designed to recharge batteries of small size electronic devices using a USB cable.

The electrical devices can be charged when the ignition switch is in the ON or START position.



### Information

- Disconnect the USB cable from the USB port after use.
- The battery charging state may be monitored on the electrical device.
- A smartphone or a tablet PC may get warmer during the charging process. It does not indicate any malfunction with the charging system.
- A smartphone or a tablet PC that does not use a USB cable to charge should be charged using its own charger.

- Charging may not be possible when using a Type-C to A converter sold by a mobile phone manufacturer or commercially available.
- Do not attempt to use the charging terminal to turn ON an audio or to play media with the infotainment system.
- Use the USB charger when the engine is running. Using the USB charger for prolonged periods of time with the ignition switch in the ON position (engine off) may cause the battery to discharge.
- To prevent damage to the USB charger:
  - Do not insert foreign objects or spill liquid into the outlet. The USB charging terminal may be damaged.
  - Do not use devices with working current exceeding 3,000 mA (3.0 A).

### Wireless Cellular Phone Charging System (if equipped)



[A] : Charging pad

There is a wireless cellular phone charger inside the front console.

The system is available when all doors are closed, and when the ignition switch is in the ON position.

### To charge a cellular phone

The wireless cellular phone charging system charges only the Qi-enabled cellular phones. Read the label on the cellular phone accessory cover or visit your cellular phone manufacturer's website to check whether your cellular phone supports the Qi technology.

The wireless charging process starts when you put a Qi-enabled cellular phone on the wireless charging unit.

1. Remove other items, including the smart key, from the wireless charging unit. If not, the wireless charging process may be interrupted. Place the cellular phone on the center of the charging pad (  ). The indicator light is orange when the smart phone is charging. The indicator light will turn blue when phone charging is complete.
2. When charging starts, a charging icon is displayed on the infotainment system screen. However, depending on the infotainment system screen, the wireless charging icon may not be displayed. See the infotainment web manual for details.
3. You can turn ON or OFF the wireless charging function in the user settings mode on the instrument cluster. For further information, refer to the "Cluster Display Modes" in this chapter.

The system warns you with a message on the cluster display if the cellular phone is still on the wireless charging unit after the engine is turned OFF and the front door is opened.

**i** Information

For some manufacturers' cellular phones, the system may not warn you even though the cellular phone is left on the wireless charging unit. This is due to the particular characteristic of the cellular phone and not a malfunction of the wireless charging.

**NOTICE**

- The wireless cellular phone charging system may not support certain cellular phones, which are not verified for the Qi specification (Qi).
- When placing your cellular phone on the charging mat, position the phone in the middle of the mat for optimal charging performance. If your cellular phone is off to the side, the charging rate may be less and in some cases the cellular phone may experience higher heat conduction.
- In some cases, the wireless charging may stop temporarily when the Remote Key or Smart Key is used, either when starting the vehicle or locking/unlocking the doors, etc.
- The wireless charging process may temporarily stop, when temperature abnormally increases inside the wireless cellular phone charging system. Stop the charging cellular phone and wait until temperature falls to a certain level.
- The wireless charging process may temporarily stop when there is any metallic item, such as a coin, between the wireless cellular phone charging system and the cellular phone.
- When using a smartphone application, such as Android Auto, while charging, the charging process may be delayed or interrupted due to the smartphone overheating. This issue is not related to the wireless charging system but rather caused by the smartphone's self-heating. Therefore, disconnect the smartphone from the charging pad.
- If the cellular phone has a thick cover, the wireless charging may not be possible.
- If the cellular phone is not completely contacting the charging pad, wireless charging may not operate properly.
- Some magnetic items like credit cards, phone cards or rail tickets may be damaged if left with the cellular phone during the charging process.
- When any cellular phone without a wireless charging function or a metallic object is placed on the charging pad, a small noise may sound. This small sound is due to the vehicle discerning compatibility of the object placed on the charging pad. It does not affect your vehicle or the cellular phone in any way.
- Wireless charging speed varies depending on the wireless charging policy and product specifications set by each smartphone manufacturer. You can check your smartphone's maximum wireless charging speed in the user manual provided by the smartphone manufacturer.
- It is normal for your smartphone to heat up during the charging process. When using Android Auto or Apple CarPlay, your smartphone may heat up more quickly, and the charging process may be slower.

### **i** Information

If the ignition switch is in the LOCK/ OFF position, the charging also stops.

### **i** Information

This device complies with part 15 of the FCC Rules.

Operation is subject to the following two conditions:

1. This device may not cause harmful interference, and
2. This device must accept any interference received, including interference that may cause undesired operation.

### Clock

#### **!** WARNING

Do not attempt to adjust the clock while driving. Doing so may result in distracted driving which may lead to an accident involving personal injury or death.

For more information, please refer to the manual that was supplied with your vehicle.

### Clothes Hanger



These hangers are not designed to hold large or heavy items.

#### **!** WARNING

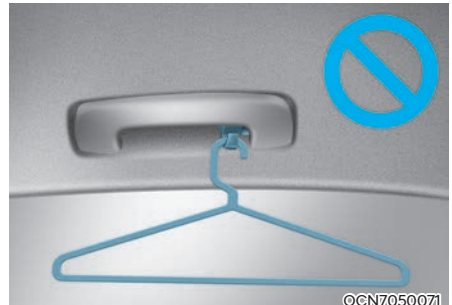

Do not hang other objects such as hangers or hard objects except clothes. Also, do not put heavy, sharp or breakable objects in the clothes pockets. In an accident or when the curtain air bag is inflated, it may cause vehicle damage or personal injury.

## INFOTAINMENT SYSTEM

### NOTICE

- If you install an aftermarket HID head lamp, your vehicle's audio and electronic devices may not function properly.
- Prevent chemicals such as perfume, cosmetic oil, sunscreen, hand cleaner, and air freshener from contacting the interior parts because they may cause damage or discoloration.

### USB Port



The USB port can be used while the engine is running.

- Small electronic devices can be charged.
- After connecting a media storage device such as a MP3 or USB to the USB port, you can listen to music through the vehicle's speakers or play it on the infotainment system.

### **i** Information

- Some devices may not be charged through USB port.
- When using a portable audio device connected to the power outlet, noise may occur during playback. If this happens, disconnect the USB cable and use the portable audio device's power source.

## Antenna

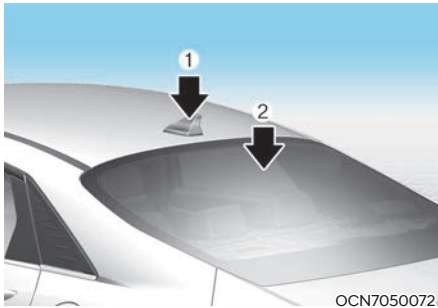

### ***Shark fin antenna (1, if equipped)***

The shark fin antenna receives data transmitted from base stations and satellites (for example: GPS, Sirius XM, LTE) and also transmits to base stations (for example: LTE).

### ***Glass antenna (2)***

Your vehicle uses a glass antenna to receive both AM and FM signals.



## WARNING

- Do not clean the inside of the rear window glass with a cleaner or scraper to remove foreign deposits as this may cause damage to the antenna elements.
- To prevent damage to the rear glass antenna, never use sharp instruments or window cleaner containing abrasives to clean the window. Clean the inside surface of the rear glass window with a piece of soft cloth.
- Avoid adding metallic coatings such as Nickel, Cadmium, etc. These can degrade the receiving AM and FM broadcast signals.
- When putting a sticker on the inside surface of the rear window, be careful not to damage the rear glass antenna.
- Do not put sharp instruments nearby the rear glass antenna.
- Tinted rear window may affect the proper functioning of the antenna.

## Steering Wheel Audio Control

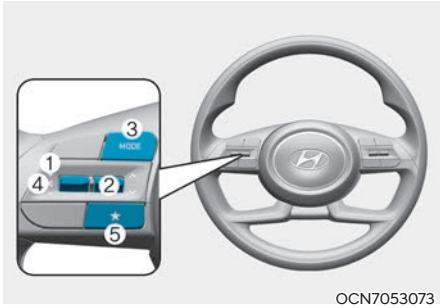

The steering wheel audio control switches are installed for your convenience.

### NOTICE

**Do not operate audio remote control buttons simultaneously.**

#### **VOLUME (VOL + / VOL -) (1)**

- Rotate the VOLUME scroll up to increase volume.
- Rotate the VOLUME scroll down to decrease volume.

#### **SEEK/PRESET (∧ / ∨) (2)**

If the SEEK/PRESET toggle switch is moved up or down and held for 0.8 second or more, it will function in the following modes.

- **RADIO mode**  
It will function as the AUTO SEEK select switch. It will SEEK until you release the switch.
- **MEDIA mode**  
It will function as the FF/REW switch.

If the SEEK/PRESET toggle switch is moved up or down, it will function in the following modes.

- **RADIO mode**  
It will function as the PRESET STATION UP/DOWN switch.
- **MEDIA mode**  
It will function as the TRACK UP/DOWN switch.

#### **MODE (3)**

Press the MODE button to select Audio Source.

#### **MUTE (🔇) (4)**

Press the MUTE button to mute or activate the sound.

#### **Custom button (★) (5)**

- Custom function
- Press and hold to move to the function setting screen.

### **i Information**

**For more information, refer to the separately supplied infotainment system manual.**

### Infotainment System (if equipped)

The infotainment system may change after software updates. For more information, refer to the user's manual provided in the infotainment system and the quick reference guide.

### Voice Recognition (if equipped)

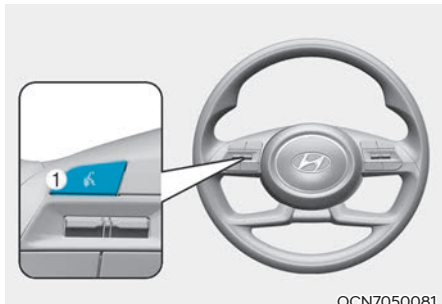

A wide range of infotainment functions can be commanded with voice recognition.

See additional information in supplied Infotainment Manual.

### Bluetooth® Wireless Technology hands-free (if equipped)

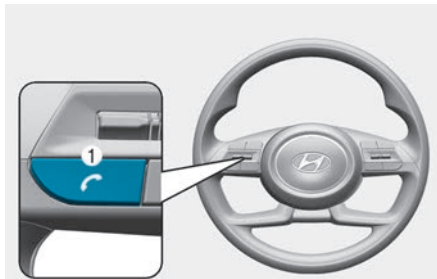

- (1) Call/Answer/Call end button
- (2) Left Microphone
- (3) Right Microphone (if equipped)

For more information, refer to the infotainment system manual.



### WARNING

**To prevent driver distraction, minimize your use of these features while driving. Distraction may cause a collision, resulting in serious injury or death.**

## How Vehicle Radio Works

### FM reception

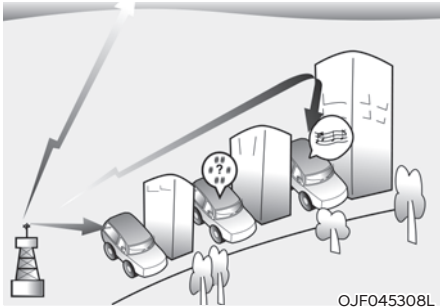

AM and FM radio signals are broadcast from transmitter towers located around your city. They are intercepted by the radio antenna on your vehicle. This signal is then received by the radio and sent to your vehicle speakers.

When a strong radio signal has reached your vehicle, the precise engineering of your audio system ensures the best possible quality reproduction. However, in some cases the signal coming to your vehicle may not be strong and clear.

This can be due to factors, such as the distance from the radio station, closeness of other strong radio stations or the presence of buildings, bridges or other large obstructions in the area.

### AM (MW, LW) reception

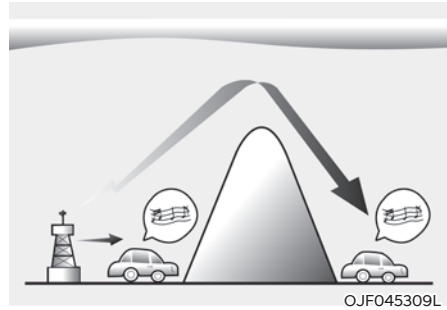

AM broadcasts can be received at greater distances than FM broadcasts. This is because AM radio waves are transmitted at low frequencies. These long, low frequency radio waves can follow the curvature of the earth rather than travelling straight out into the atmosphere. In addition, they curve around obstructions so that they can provide better signal coverage.

### FM radio station

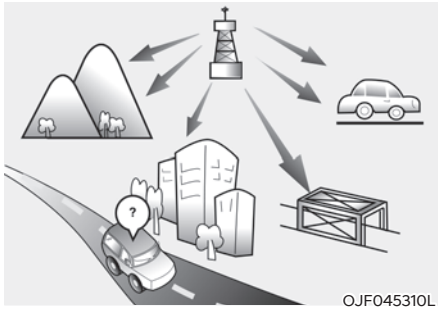

FM broadcasts are transmitted at high frequencies and do not bend to follow the earth's surface. Because of this, FM broadcasts generally begin to fade at short distances from the station. Also, FM signals are easily affected by buildings, mountains, or other obstructions.

These can result in certain listening conditions which might lead you to believe a problem exists with your radio. The following conditions are normal and do not indicate radio trouble :

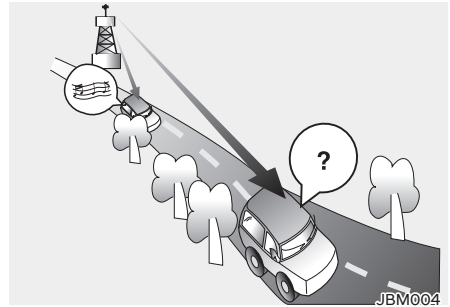

- Fading as your vehicle moves away from the radio station, the signal will weaken and sound will begin to fade. When this occurs, we suggest that you select another stronger station.
- Flutter/Static Weak FM signals or large obstructions between the transmitter and your radio can disturb the signal causing static or fluttering noises to occur. Reducing the treble level may lessen this effect until the disturbance clears.

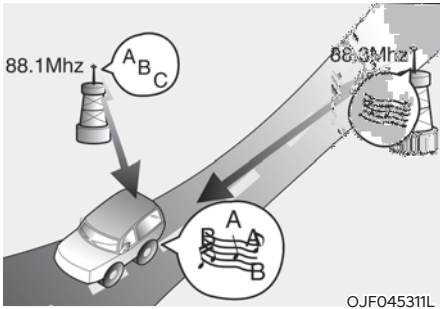

- Station Swapping As a FM signal weakens, another more powerful signal near the same frequency may begin to play. This is because your radio is designed to lock onto the clearest signal. If this occurs, select another station with a stronger signal.
- Multi-Path Cancellation Radio signals being received from several directions can cause distortion or fluttering. This can be caused by a direct and reflected signal from the same station, or by signals from two stations with close frequencies. If this occurs, select another station until the condition has passed.

### **Using a cellular phone or a twoway radio**

When a cellular phone is used inside the vehicle, noise may be produced from the audio system. This does not mean that something is wrong with the audio equipment. In such a case, use the cellular phone at a place as far as possible from the audio equipment.

### **NOTICE**

**When using a communication system such as a cellular phone or a radio set inside the vehicle, a separate external antenna must be fitted. When a cellular phone or a radio set is used with an internal antenna alone, it may interfere with the vehicle's electrical system and adversely affect safe operation of the vehicle.**



### **WARNING**

**Do not use a cellular phone while driving. Stop at a safe location to use a cellular phone.**

# 6. Driving Your Vehicle

Before Driving .....	6-4
Before Entering the Vehicle.....	6-4
Before Starting .....	6-4
Ignition Switch .....	6-5
Key Ignition Switch.....	6-5
Engine Start/Stop Button .....	6-8
Vehicle Auto-Shut Off.....	6-12
Operating Conditions.....	6-12
Deactivating Conditions .....	6-12
System Operation.....	6-12
Dual Clutch Transmission.....	6-13
Dual Clutch Transmission Operation .....	6-13
DCT Warning Messages.....	6-18
Parking .....	6-19
Good Driving Practices .....	6-20
Coasting Guide.....	6-21
Brake System.....	6-22
Power Brakes .....	6-22
Disc Brakes Wear Indicator.....	6-22
Electronic Parking Brake (EPB).....	6-23
Auto Hold .....	6-27
Anti-lock Brake System (ABS).....	6-30
Electronic Stability Control (ESC) .....	6-32
Vehicle Stability Management (VSM) .....	6-34
Hill-Start Assist Control (HAC).....	6-35
Good Braking Practices .....	6-36
Drive Mode Integrated Control System.....	6-37
Drive Mode .....	6-37

---

Special Driving Conditions .....	6-40
Hazardous Driving Conditions .....	6-40
Rocking the Vehicle .....	6-40
Smooth Cornering.....	6-41
Driving at Night .....	6-41
Driving in the Rain.....	6-41
Driving in Flooded Areas.....	6-42
Highway Driving .....	6-42
Winter Driving .....	6-43
Snow or Icy Conditions .....	6-43
Winter Precautions.....	6-44
Vehicle Load Limit .....	6-46
Tire Loading Information Label .....	6-47
Trailer Towing .....	6-51

**WARNING**

**Carbon monoxide (CO) gas is toxic. Breathing CO can cause unconsciousness and death.**

Engine exhaust contains carbon monoxide which cannot be seen or smelled.

**Do not inhale engine exhaust.**

If at any time you smell engine exhaust inside the vehicle, open the windows immediately. Exposure to CO can cause unconsciousness and death by asphyxiation.

**Be sure the exhaust system does not leak.**

The exhaust system should be checked whenever the vehicle is raised to change the oil or for any other purpose. If you hear a change in the sound of the exhaust or if you drive over something that strikes the underneath side of the vehicle, have the exhaust system checked as soon as possible by an authorized HYUNDAI dealer.

**Do not run the engine in an enclosed area.**

Letting the engine idle in your garage, even with the garage door open, is a hazardous practice. Run the engine only long enough to start the engine and to move the vehicle out of the garage.

**Avoid idling the engine for prolonged periods with people inside the vehicle.**

If it is necessary to idle the engine for a prolonged period with people inside the vehicle, be sure to do so only in an open area with the air intake set at "Fresh" and fan control set to high so fresh air is drawn into the interior.

**Keep the air intakes clear.**

To assure proper operation of the ventilation system, keep the ventilation air intakes located in front of the windshield clear of snow, ice, leaves, or other obstructions.

**If you must drive with the trunk open:**

Close all windows.

Open instrument panel air vents.

Set the air intake control at "Fresh", the air flow control at "Floor" or "Face", and the fan control set to high.

**WARNING****CALIFORNIA PROPOSITION 65 WARNING**

**Engine exhaust and a wide variety of automobile components including components found in the interior furnishings in a vehicle, contain or emit harmful chemicals known to the State of California to cause cancer and birth defects and reproductive harm. In addition, certain fluids contained in vehicles and certain products of components contain or emit chemicals known to the State of California to cause cancer and birth defects or other reproductive harm.**

## BEFORE DRIVING

### Before Entering the Vehicle

- Be sure all windows, side view mirror(s), and outside lights are clean and unobstructed.
- Remove frost, snow, or ice.
- Visually check the tires for uneven wear and damage.
- Check under the vehicle for any sign of leaks.
- Be sure there are no obstacles behind you if you intend to back up.

### Before Starting

- Make sure the hood, the trunk, and the doors are securely closed and locked.
- Adjust the position of the seat and steering wheel.
- Adjust the inside and side view mirrors.
- Verify all the lights work.
- Fasten your seatbelt. Check that all passengers have fastened their seatbelts.
- Check the gauges and indicators in the instrument panel and the messages on the instrument display when the ignition switch is in the ON position.
- Check that any items you are carrying are stored properly or fastened down securely.



### WARNING

To reduce the risk of **SERIOUS INJURY** or **DEATH**, take the following precautions:

- **ALWAYS** wear your seat belt. All passengers must be properly belted whenever the vehicle is moving. For more information, refer to "Seat Belts" in chapter 3.
- Always drive defensively. Assume other drivers or pedestrians may be careless and make mistakes.
- Stay focused on the task of driving. Driver distraction can cause accidents.
- Leave plenty of space between you and the vehicle in front of you.



### WARNING

**NEVER** drink alcohol or take drugs and drive.

Drinking alcohol or taking drugs and driving is dangerous and may result in an accident and **SERIOUS INJURY** or **DEATH**.

Drunk driving is the number one contributor to the highway death toll each year. Even a small amount of alcohol will affect your reflexes, perceptions and judgment. Just one drink can reduce your ability to respond to changing conditions and emergencies and your reaction time gets worse with each additional drink. Driving while under the influence of drugs is as dangerous as or more dangerous than driving under the influence of alcohol.

You are much more likely to have a serious accident if you drink or take drugs and drive. If you are drinking or taking drugs, don't drive. Do not ride with a driver who has been drinking or taking drugs. Choose a designated driver or call a taxi.

## IGNITION SWITCH

### Key Ignition Switch (if equipped)



#### WARNING

To reduce the risk of **SERIOUS INJURY** or **DEATH**, take the following precautions:

- **NEVER** allow children or any person who is unfamiliar with the vehicle to touch the ignition switch or related parts. Unexpected and sudden vehicle movement can occur.
- **NEVER** reach through the steering wheel for the ignition switch, or any other control, while the vehicle is in motion. The presence of your hand or arm in this area may cause a loss of vehicle control resulting in an accident.

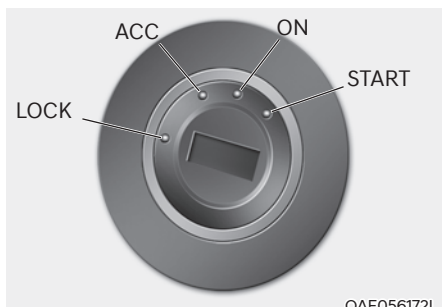

OAE056172L

Whenever the front door is opened, the ignition switch will illuminate, provided the ignition switch is not in the ON position. The light will go off immediately when the ignition switch is turned on or go off after about 30 seconds when the door is closed. (if equipped)



#### WARNING

**NEVER** turn the ignition switch to the **LOCK** or **ACC** position while the vehicle is in motion except in an emergency. This will result in the engine turning off and loss of power assist for the steering and brake systems. This may lead to loss of directional control and braking function, which could cause an accident.

Before leaving the driver's seat, always make sure the shift lever is in **P (Park)** position, apply the parking brake, and turn ignition switch to the **LOCK** position.

Unexpected vehicle movement may occur if these precautions are not followed.

**Key ignition switch positions**

Switch Position	Action	Notice
<b>LOCK</b>	To turn the ignition switch to the LOCK position, put the key in at the ACC position and turn the key towards the LOCK position. The ignition key can be removed in the LOCK position.	Always stop the vehicle before turning the ignition switch to the LOCK position.
<b>ACC</b>	Electrical accessories are usable. The steering wheel unlocks.	
<b>ON</b>	This is the normal key position when the engine has started. All features and accessories are usable. The warning lights can be checked when you turn the ignition switch from ACC to ON.	Do not leave the ignition switch in the ON position when the engine is not running in order to prevent the battery from discharging.
<b>START</b>	To start the engine, turn the ignition switch to the START position. The switch returns to the ON position when you let go of the key.	The engine will crank until you release the key.

## Starting the engine



### WARNING

- Always wear appropriate shoes when operating your vehicle. Unsuitable shoes such as high heels, ski boots, sandals, and flip-flops may interfere with your ability to use the brake, accelerator, and clutch pedals. Do not drive barefoot.
  - Do not start your vehicle with the accelerator pedal depressed. Place your foot firmly on the brake pedal while starting your vehicle.
  - Wait until the engine is at normal idle before shifting gears and releasing the brake. Your vehicle may move suddenly if your vehicle is shifted while the engine RPM is high. It may cause damage to the transmission system.
1. Make sure the parking brake is applied.
  2. Make sure the shift lever is in P (Park).
  3. Depress the brake pedal.
  4. Turn the ignition switch to the START position. Hold the key (maximum of 10 seconds) until the engine starts and release it.

### **i** Information

- Do not wait for the engine to warm up or race the engine while the vehicle remains stationary.
- Start driving at moderate engine speeds. Do not rapidly accelerate and decelerate while driving.

### NOTICE

To prevent damage to the vehicle:

- Do not hold the ignition key in the START position for more than 10 seconds. Wait 5 to 10 seconds before trying again.
- Do not push or tow your vehicle to start the engine.
- If the engine stalls while the vehicle is moving, shift to N (Neutral) and use the ignition switch to attempt to restart the engine.
- Do not push or tow your vehicle to start the engine.

### Turning off the engine

1. Stop the vehicle and depress the brake pedal fully.
2. Shift the gear to P (Park).
3. Turn the ignition switch to the off position and apply the parking brake.

## Engine Start/Stop Button (if equipped)



Whenever the front door is opened, the Engine Start/Stop button will illuminate and will go off 30 seconds after the door is closed. (if equipped)

### WARNING

To reduce risk of serious injury or death, **NEVER** allow children or any person who is unfamiliar with the vehicle to touch the Engine Start/Stop button or related parts. Unexpected and sudden vehicle movement can occur.

### WARNING

To turn the engine off in an emergency: Press and hold the Engine Start/Stop button for more than two seconds **OR** rapidly press and release the Engine Start/Stop button three times (within three seconds).

If the vehicle is still moving, you can restart the engine without depressing the brake pedal by pressing the Engine Start/Stop button with the shift lever in the N (Neutral) position.

### WARNING

- **NEVER** press the Engine Start/Stop button while the vehicle is in motion except in an emergency. This will result in the engine turning off and loss of power assist for the steering and brake systems.  
This may lead to loss of directional control and braking function, which could cause an accident.
- Before leaving the driver's seat, always make sure the shift lever is in the P (Park) position, set the parking brake, press the Engine Start/Stop button to the OFF position, and take the Smart Key with you. Unexpected vehicle movement may occur if these precautions are not followed.
- **NEVER** reach through the steering wheel for the Engine Start/Stop button or any other control while the vehicle is in motion. The presence of your hand or arm in this area may cause a loss of vehicle control resulting in an accident.

### Engine Stop/Start button positions

Button Position	Action	Notice
<b>OFF</b>	To turn off the engine, press the Engine Start/Stop button with shift lever in P (Park). When you press the Engine Start/Stop button without the shift lever in P (Park), the Engine Start/Stop button does not turn to the OFF position, but turns to the ACC position.	Always stop the vehicle before pressing the Push Button Start ignition switch to the OFF position.
<b>ACC</b>	Press the Engine Start/Stop button when the button is in the OFF position without depressing the brake pedal. Electrical accessories are usable.	If you leave the Engine Start/Stop button in the ACC position for more than one hour, the battery power will turn off automatically to prevent the battery from discharging.
<b>ON</b>	Press the Engine Start/Stop button while it is in the ACC position without depressing the brake pedal. The warning lights can be checked before the engine is started.	Do not leave the Engine Start/Stop button in the ON position when the engine is not running to prevent the battery from discharging.
<b>START</b>	To start the engine, depress the brake pedal and press the Engine Start/Stop button with the shift lever in the P (Park) position.	If you press the Engine Start/Stop button without depressing the brake pedal, the engine does not start and the Engine Start/Stop button changes as follows: <b>OFF → ACC → ON → OFF or ACC</b>

## Starting the engine



### WARNING

- Always wear appropriate shoes when operating your vehicle. **Unsuitable shoes, such as high heels, ski boots, sandals, flip-flops, etc., may interfere with your ability to use the brake and accelerator pedals.**
- Do not start the vehicle with the accelerator pedal depressed. The vehicle can move and lead to an accident.
- Wait until the engine rpm is normal. The vehicle may suddenly move if the brake pedal is released when the rpm is high.



### Information

- The engine will start by pressing the Engine Start/Stop button, only when the smart key is in the vehicle.
- Even if the smart key is in the vehicle, if it is far away from the driver, the engine may not start.
- When the Engine Start/Stop button is in the ACC or ON position, if any door is open, the system checks for the smart key. If the smart key is not in the vehicle, the “” indicator will blink and the warning “Key not in vehicle” will come on and if all doors are closed, the chime will also sound for a few seconds. Keep the smart key in the vehicle when using the ACC position or if the vehicle engine is ON.



### Information

Depress the brake pedal until the engine starts.

1. Always carry the smart key with you.
2. Make sure the parking brake is applied.
3. Make sure the shift lever is in P (Park).
4. Depress the brake pedal.
5. Press the Engine Start/Stop button.



### Information

- Do not wait for the engine to warm up while the vehicle remains stationary. Start driving at moderate engine speeds. (Aggressive accelerating and decelerating should be avoided.)
- Always start the vehicle with your foot on the brake pedal. Do not depress the accelerator while starting the vehicle. Do not rev the engine while warming it up.

**NOTICE**

To prevent damage to the vehicle:

- If the engine stalls while you are in motion, do not attempt to move the shift lever to the P (Park) position.

If traffic and road conditions permit, you may put the shift lever in the N (Neutral) position while the vehicle is still moving and press the Engine Start/Stop button in an attempt to restart the engine.

- Do not push or tow your vehicle to start the engine.

**NOTICE**

To prevent damage to the vehicle:

When the stop lamp switch fuse is blown, you can't start the engine normally. Replace the fuse with a new one. If you are not able to replace the fuse, you can start the engine by pressing and holding the Engine Start/Stop button for 10 seconds with the Engine Start/Stop button in the ACC position.

Do not press the Engine Start/Stop button for more than 10 seconds except when the stop lamp switch fuse is blown.

For your safety always depress the brake pedal before starting the engine.

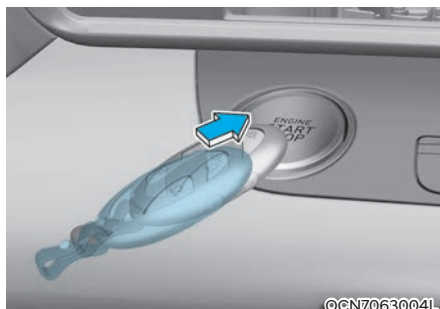
**Emergency starting**

If the smart key battery is weak or the smart key does not work correctly, you can start the engine by pressing the Engine Start/Stop button with the smart key in the direction of the picture above.

## VEHICLE AUTO-SHUT OFF (IF EQUIPPED)

If your vehicle is parked and the engine is left on for a long period of time, the engine will turn off automatically to help reduce fuel consumption and prevent accidents caused by carbon dioxide poisoning.

### Operating Conditions

Vehicle Auto-Shut Off timer operates when all the following conditions are satisfied:

- Vehicle speed is below 1.8 mph (3 km/h), and the gear is shifted to P (Park)
- The brake pedal and accelerator pedal are not depressed
- The driver's seat belt is unfastened
- The passenger seat is empty
- The infotainment system is being updated

### Deactivating Conditions

Vehicle Auto-Shut Off timer turns off when one of the situation occur:

- Vehicle speed is above 1.8 mph (3 km/h)
- The gear is shifted to R (Reverse), D (Drive) or N (Neutral)
- The brake pedal or accelerator pedal is depressed
- The driver's seat belt is fastened
- A passenger is in the passenger's seat

### System Operation



When all the conditions are satisfied, the Vehicle Auto-Shut Off operates and turns the engine off automatically after 60 minutes.

A timer appears on the instrument cluster 30 minutes before vehicle shut off.

### Resetting cluster timer

To reset the cluster timer, do one of following:

- Release the accelerator pedal or brake pedal after Vehicle Auto-Shut Off is complete.
- Press the OK button on the steering wheel while the timer appears on the instrument cluster.



### CAUTION

**Do not leave a passenger or a pet in the vehicle in hot weather since the air conditioning system turns off when the engine is off.**

## DUAL CLUTCH TRANSMISSION

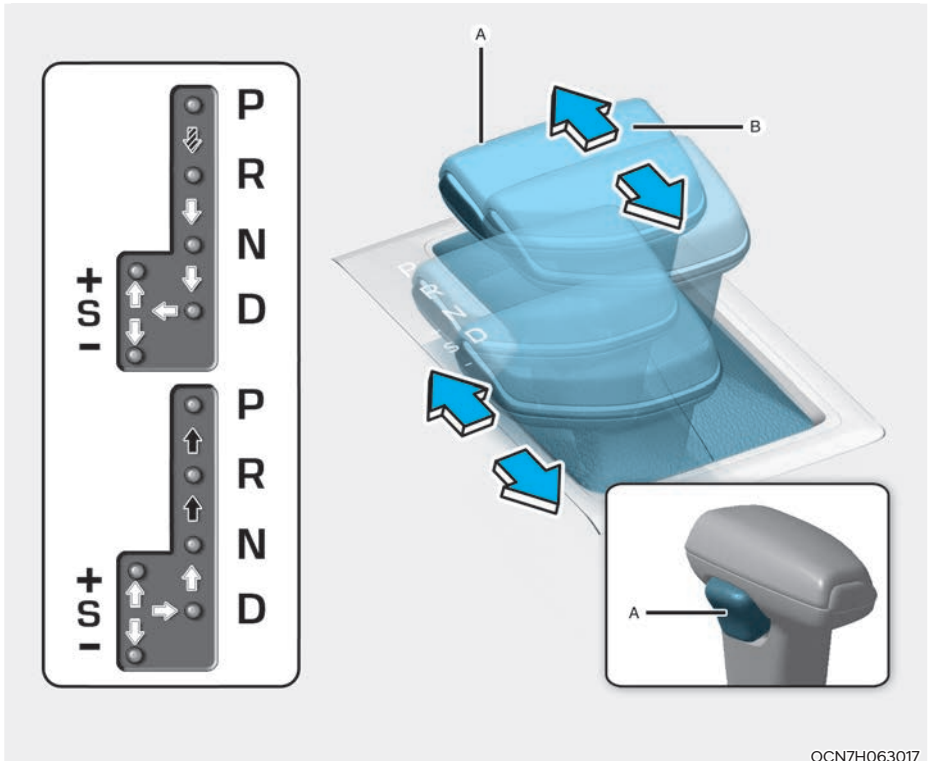

[A] : Shift button, [B] : Shift lever

- ▤ Depress the brake pedal and press the shift button while moving the shift lever.
- ➡ Press the shift button while moving the shift lever.
- ⇨ The shift lever can freely operate.

### Dual Clutch Transmission Operation

The indicator on the cluster displays the shift lever position when the ignition switch is in the ON position.



## WARNING

To reduce the risk of serious injury or death:

- **ALWAYS check the surrounding areas near your vehicle for people, especially children, before shifting a vehicle into D (Drive) or R (Reverse).**
- **Before leaving the driver's seat, always make sure the shift lever is in the P (Park) position, then set the parking brake, and place the ignition switch in the LOCK/OFF position. Unexpected and sudden vehicle movement can occur if these precautions are not followed.**
- **Do not use aggressive engine braking (shifting from a higher gear to a lower gear) on slippery roads. The vehicle may lose traction with the roadway, resulting in a collision.**

The dual clutch transmission has six forward speeds and one reverse speed. The individual speeds are selected automatically when the shift lever is in the D (Drive) position.

- The dual clutch transmission can be thought of as an automatically shifting manual transmission. It gives the driving feel of a manual transmission, yet provides the ease of a fully automatic transmission.
- When D (Drive) is selected, the transmission will automatically shift through the gears similar to a conventional automatic transmission. Unlike a traditional automatic transmission, the gear shifting can sometimes be felt and heard as the actuators engage the clutches and the gears are selected.

- The dual clutch transmission adopts a dry-type dual clutch, which is different from the torque converter of the automatic transmission. It shows better acceleration performance and increased fuel efficiency while driving but initial launch might be little bit slower than the automatic transmission.

As a result, gear shifts are sometimes more noticeable than a conventional automatic transmission and a light vibration during launching can be felt as the transmission speed. This is a normal condition of the dual clutch transmission.

- The dry-type clutch transfers torque more directly and provides a direct drive feeling which may feel different from a conventional automatic transmission. This may be more noticeable when launching the vehicle from a stop or when traveling at low, stop-and-go vehicle speeds.
- When rapidly accelerating at a low vehicle speed, the engine rpm may increase highly depending on the vehicle's driving condition.
- When accelerating from a stop on an incline, press the accelerator smoothly and gradually to avoid any shudder feeling or jerkiness.
- When traveling at a lower vehicle speed, if you release the accelerator pedal quickly, you may feel engine braking before the transmission changes gears. This engine braking feeling is similar to operating a manual transmission at low speed.
- When driving downhill, you may use Sports Mode to downshift to a lower gear in order to control your speed without using the brake pedal excessively.

- When you turn the engine on and off, you may hear clicking sounds as the system goes through a self-test. This is a normal sound for the dual clutch transmission.
- During the first 1,000 mi. (1,500 km), you may feel that the vehicle may not be smooth when accelerating at low speed. During this break-in period, the shift quality and performance of your new vehicle is continuously optimized.

### P (Park)

Always come to a complete stop before shifting into P (Park).

The shift lever must be in P (Park) before turning the engine off.



### WARNING

- **Shifting into P (Park) while the vehicle is in motion may cause you to lose control of the vehicle.**
- **After the vehicle has stopped, always make sure the shift lever is in P (Park), apply the parking brake, and turn the engine off.**
- **Do not use the P (Park) position in place of the parking brake.**

### R (Reverse)

Use this position to drive the vehicle backward.

### NOTICE

**Always come to a complete stop before shifting into or out of R (Reverse); you may damage the transaxle if you shift into R (Reverse) while the vehicle is in motion.**

### N (Neutral)

The wheels and transmission are not engaged.

Use N (Neutral) if you need to restart a stalled engine, or if it is necessary to stop with the engine ON. Shift into P (Park) if you need to leave your vehicle for any reason.

Always depress the brake pedal when you are shifting from N (Neutral) to another gear.

### D (Drive)

This is the normal driving position. The transmission will automatically shift through a 6-gear sequence, providing the best fuel economy and power.

For extra power when passing another vehicle or driving uphill, depress the accelerator fully. The transmission will automatically downshift to the next lower gear (or gears, as appropriate).

The DRIVE MODE switch, located on the shift lever console, allows the driver to switch from NORMAL mode to SPORT mode (if equipped)

For more information, refer to "Drive Mode Integrated Control System" later in this chapter.



### WARNING

- **Do not shift into gear unless your foot is firmly on the brake pedal. Shifting into gear when the engine is running at high speed can cause the vehicle to move very rapidly. You may lose control of the vehicle and cause accidents.**
- **Do not drive with the shift lever in N (Neutral). The engine brake will not work and may lead to an accident.**

### NOTICE

**Always make sure the vehicle is stationary, at a complete stop, before selecting D (Drive).**

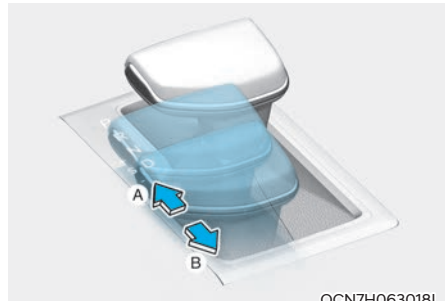

OCN7H063018L

[A] Push the lever forwards once to shift up one gear.

[B] Pull the lever backwards once to shift down one gear.

### Manual shift mode

Whether the vehicle is stationary or in motion, sports mode is selected by pushing the shift lever from the D (Drive) position into the manual gate. To return to D (Drive) range operation, push the shift lever back into the main gate.

In manual shift mode, moving the shift lever backwards and forwards will allow you to select the desired range of gears for the current driving conditions.

### **i** Information

- **Only the six forward gears can be selected. To reverse or park the vehicle, move the shift lever to the R (Reverse) or P (Park) position as required.**
- **Downshifts are made automatically when the vehicle slows down. When the vehicle stops, 1st gear is automatically selected.**
- **When the engine rpm approaches the red zone the transmission will upshift automatically.**
- **If the driver presses the lever to + (Up) or - (Down) position, the transmission may not make the requested gear change if the next gear is outside of the allowable engine RPM range. The driver must execute upshifts in accordance with road conditions, taking care to keep the engine rpms below the red zone.**

### **Shift-lock system**

For your safety, the dual clutch transmission has a shift-lock system which prevents shifting the transmission from P (Park) into R (Reverse) unless the brake pedal is depressed.

To shift the transmission from P (Park) into R (Reverse):

1. Depress and hold the brake pedal.
2. Start the engine or place the ignition switch in the ON position.
3. Depress the brake pedal and put the gear in R (Reverse).

## DCT Warning Messages

### ***Transmission overheated warning***

If the warning messages on the cluster continues to blink, contact an authorized HYUNDAI dealer.

### **Steep grade! Press brake pedal**



This message appears when the vehicle is driving up hills or on steep grades.

If the vehicle is held or creeping forward on an incline by applying the accelerator pedal, the clutch and transmission may result in damage.

Press the brake pedal, if the messages appears on the cluster display.

### **Transmission temperature is high! Stop safely**



Repeated stop-and-go launches on steep grades, sudden take off or acceleration, or other harsh driving conditions may increase the clutch and transmission temperature.

If the clutch and the transmission temperature is high, the self-protection mode warns you with a warning chime and message while the shift indicator on the cluster display blinks.

- Move the vehicle to a safe location and shift the gear to P (Park) with the engine running. Wait until the transmission is sufficiently cooled down.
- If you ignore this warning, you may experience abrupt shifts, frequent shifts, or jerkiness.

### Transmission hot! Park with engine On

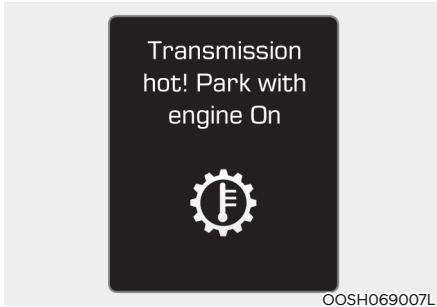

If you continue to drive with an overheated transmission, the above warning message appears, and the self-protection mode disables the clutch.

- Move the vehicle to a safe location and shift the gear to P (Park) with the engine running. Wait until the transmission is sufficiently cooled down.
- If the above warning message is displayed continuously, contact an authorized HYUNDAI dealer.

### Cooling... Remain parked for 00 min.



If you move the vehicle to a safe location and shift the gear to P (Park) with the engine running, the above warning message appears.

- Wait until the clutch is sufficiently cooled down.

### Transmission cooled down. Resume driving



This message appears when your vehicle can be driven. Drive the vehicle smoothly as possible.

### Parking

Always come to a complete stop and continue to depress the brake pedal. Move the shift lever into the P (Park) position, apply the parking brake, and place the ignition switch in the LOCK/OFF position. Take the Key with you when exiting the vehicle.



### WARNING

**When you stay in the vehicle with the engine running, be careful not to depress the accelerator pedal for a long period of time. The engine or exhaust system may overheat and start a fire.**

**The exhaust gas and the exhaust system are very hot. Keep away from the exhaust system components.**

**Do not stop or park over flammable materials, such as dry grass, paper or leaves. They may ignite and cause a fire.**

### Good Driving Practices

- Never move the shift lever from P (Park) or N (Neutral) to any other position with the accelerator pedal depressed.
- Never move the shift lever into P (Park) when the vehicle is in motion. Be sure the vehicle is completely stopped before you attempt to shift into R (Reverse) or D (Drive).
- Do not move the shift lever to N (Neutral) when driving. Doing so may result in an accident because of a loss of engine braking and the transmission could be damaged.
- When driving uphill or downhill, always shift to D (Drive) for driving forward or shift to R (Reverse) for driving rearwards. After selecting D (Drive) or R (Reverse), check the gear position indicated on the cluster before driving. If the vehicle moves in the opposite direction of the selected gear, the engine may turn off and a serious accident might occur due to degraded brake performance.
- Do not drive with your foot resting on the brake pedal. Even light, but consistent pedal pressure can result in the brakes overheating, brake wear and possibly even brake failure.
- When driving in sports mode, slow down before shifting to a lower gear. Otherwise, the lower gear may not be engaged if the engine rpms are outside of the allowable range.
- Always apply the parking brake when leaving the vehicle. Do not depend on placing the transmission in P (Park) to keep the vehicle from moving.
- Exercise extreme caution when driving on a slippery surface. Be especially careful when braking, accelerating or shifting gears. On a slippery surface, an abrupt change in vehicle speed can cause the drive wheels to lose traction and may cause loss of vehicle control resulting in an accident.

- Optimum vehicle performance and economy is obtained by smoothly depressing and releasing the accelerator.



### WARNING

To reduce the risk of **SERIOUS INJURY** or **DEATH**:

- **ALWAYS wear your seatbelt. In a collision, an unbelted occupant is significantly more likely to be seriously injured or killed than a properly belted occupant.**
- **Avoid high speeds when cornering or turning.**
- **Do not make quick steering wheel movements, such as sharp lane changes or fast, sharp turns.**
- **The risk of rollover is greatly increased if you lose control of your vehicle at highway speeds.**
- **Loss of control often occurs if two or more wheels drop off the roadway and the driver over steers to reenter the roadway.**
- **In the event your vehicle leaves the roadway, do not steer sharply. Instead, slow down before pulling back into the travel lanes.**
- **HYUNDAI recommends you follow all posted speed limits.**



### WARNING

If your vehicle is stuck in snow, mud, sand, etc., you may attempt to free the vehicle by rocking it back and forth. Do not attempt this procedure if people or objects are anywhere near. Vehicle may suddenly move forward or backward as it becomes unstuck, causing injury or damage to nearby people or objects.

## COASTING GUIDE (IF EQUIPPED)

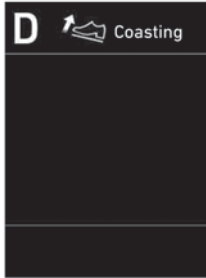

OOSH069019L

The coasting guide function informs the driver when to take the foot off from the accelerator by anticipating a decelerating event\* based on the analysis of driving routes and road conditions of the navigation. It encourages the driver to remove foot from the pedal and allow coasting down the road with EV motor only. This helps prevent unnecessary fuel consumption and increases fuel efficiency.

### **i** Information

**Example of a deceleration event is making a right/left turn, driving through a rotary, entering or exiting a highway (freeway), etc.**

### **Setting Coasting Guide function**

Coasting Guide can be selected from the User Settings mode in the cluster LCD display by following the procedure below.

1. Set the ignition switch in the ON position.
2. Select 'User Setting > Eco Vehicle > Coasting Guide' in the cluster display.

### **Operation conditions**

After selecting the function from the User Settings mode, the system enters the ready status by following the procedure below.

1. Enter your destination information in the navigation system and select the driving route.
2. Check that the vehicle is in NORMAL mode by driving the vehicle in D (Drive).
3. Drive the vehicle between 25 mph (40 km/h) ~ 100 mph (160 km/h).

### **i** Information

**The operating speed may vary due to difference between instrument cluster and navigation effected by tire inflation level.**

### **i** Information

**Coasting guide is only a supplemental function to assist with fuel-efficient driving. Thus, the operating conditions may be different in accordance with traffic/road conditions (i.e. driving in a traffic jam, driving on a slope, driving on a curve). Take the actual driving conditions into consideration, such as distances from the vehicles ahead/behind, while referring to the coasting guide function as guidance.**

## BRAKE SYSTEM

### Power Brakes

Your vehicle has power-assisted brakes that adjust automatically through normal usage.

In the event of a vehicle power failure, the power assist for the brakes will not work. You can still stop your vehicle, but it will require greater force and increased pedal travel than normal. The stopping distance, however, will be longer than with power brakes.

#### Information

- When the brake pedal is depressed under certain driving conditions or weather conditions, you may temporarily hear a noise. This is normal and does not indicate a problem with your brakes.
- If deicing chemicals get stuck on the brakes, abnormal wear and noise may occur on the brake discs and pads. Remove the deicing chemicals from the brake discs and pads while applying the brakes in a safe traffic condition.

#### WARNING

Take the following precautions:

- Do not drive with your foot resting on the brake pedal. This will create abnormal high brake temperatures, excessive brake lining and pad wear, and increased stopping distances.

- When descending down a long or steep hill, move the gear shift lever to Manual Shift Mode and manually downshift to a lower gear in order to control your speed without using the brake pedal excessively. Applying the brakes continuously will cause the brakes to overheat and could result in a temporary loss of braking performance.
- Wet brakes may impair the vehicle's ability to safely slow down; the vehicle may also pull to one side when the brakes are applied. Applying the brakes lightly will indicate whether they have been affected in this way. Always test your brakes in this fashion after driving through deep water. To dry the brakes, lightly tap the brake pedal to heat up the brakes while maintaining a safe forward speed until brake performance returns to normal. Avoid driving at high speeds until the brakes function correctly.

### Disc Brakes Wear Indicator

When your brake pads are worn and new pads are required, you will hear a high pitched warning sound from your front or rear brakes. You may hear this sound come and go or it may occur whenever you depress the brake pedal.

#### **NOTICE**

To avoid costly brake repairs, do not continue to drive with worn brake pads.

#### Information

Always replace brake pads as complete front or rear axle sets.

## Electronic Parking Brake (EPB) Applying the parking brake

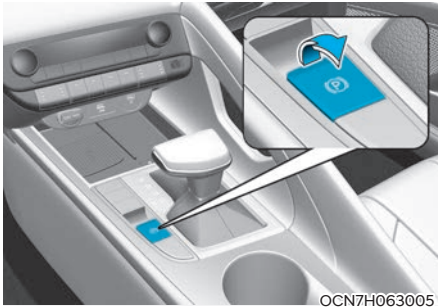

To apply the EPB (Electronic Parking Brake):

1. Depress the brake pedal.
2. Pull up the EPB switch.

Make sure the parking brake warning light comes on.



### WARNING

To reduce the risk of **SERIOUS INJURY** or **DEATH**, do not operate the EPB while the vehicle is moving except in an emergency situation. It could damage the brake system and lead to an accident.

## Releasing the parking brake

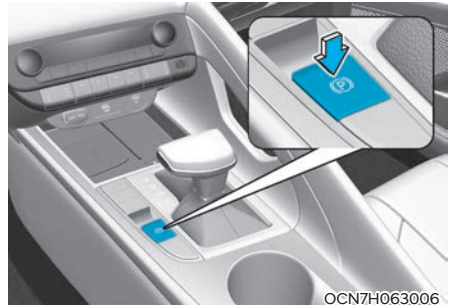

To release the EPB (Electronic Parking Brake):

- Place the ignition switch in the ON position.
- Depress the brake pedal.
- Press the EPB switch.

Make sure the Parking Brake Warning Light goes off.

To release EPB (Electronic Parking Brake) automatically:

- Shift lever in P(Park)  
With the vehicle in the ready (**READY**) mode, depress the brake pedal and shift out of P (Park) to R (Reverse) or D (Drive).
- Shift lever in N (Neutral)  
With the vehicle in the ready (**READY**) mode, depress the brake pedal and shift out of N (Neutral) to R (Reverse) or D (Drive).

- Satisfy the following conditions
  1. Ensure seat belts are fastened and the doors, hood and trunk are closed.
  2. With the vehicle in the ready (READY) mode, depress the brake pedal and shift out of P (Park) or N (Neutral) to R (Reverse) or D (Drive).
  3. Depress the accelerator pedal.

Make sure the Parking Brake Warning Light goes off.

### **i** Information

- For your safety, you can engage the EPB even though the ignition switch is in the LOCK/OFF position, but you cannot release it.
- For your safety, depress the brake pedal and release the parking brake manually with the EPB switch when you drive downhill or when backing up the vehicle.

### **NOTICE**

- If the parking brake warning light is still on even though the EPB has been released, have the system checked by an authorized HYUNDAI dealer.
- Do not drive your vehicle with the EPB applied. It may cause excessive brake pad and brake rotor wear.

EPB (Electronic Parking Brake) may be automatically applied when:

- Requested by other systems
- The driver turns the engine off while Auto Hold is operating.

### Warning messages

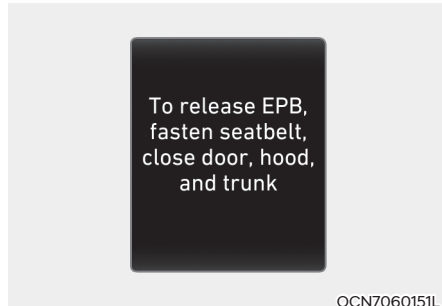

To release EPB, fasten seatbelt, close door, hood and trunk

- When you try to drive with the EPB applied, a warning will sound and a message will appear.
- If the driver's seat belt is unfastened and the hood or trunk is opened, a warning sound and a message will appear.
- When there is a problem with the vehicle, a warning sound and a message may appear.

If the situation occurs, press the brake pedal and released EPB by pressing the EPB switch.



## WARNING

- To prevent unintentional movement when stopped and leaving the vehicle, do not use the P(Park) position in place of the parking brake. Set the parking brake and make sure the vehicle is securely positioned in P(Park).
- Never allow anyone who is unfamiliar with the vehicle to touch the parking brake. If the parking brake is released unintentionally, serious injury may occur.
- All vehicles should always have the parking brake fully engaged when parking to avoid inadvertent movement of the car which can injure occupants or pedestrians.

## NOTICE

- A click sound may be heard while operating or releasing the EPB, but these conditions are normal and indicate that the EPB is functioning properly.
- When leaving your keys with a parking lot attendant or valet, make sure to inform him/her how to operate the EPB.
- The EPB may malfunction if you drive with the EPB applied.
- When you automatically release EPB by depressing the accelerator pedal, depress it slowly.

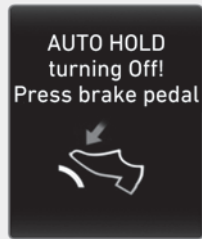

OCN7060152L

### AUTO HOLD turning Off! Press brake pedal

When the conversion from Auto Hold to EPB is not working properly a warning will sound and a message will appear.

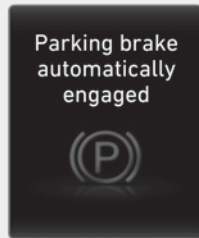

OCN7060153L

### Parking brake automatically engaged

When the EPB is applied from Auto Hold, a warning sound and a message will appear.

### **EPB malfunction indicator**

This warning light illuminates if the ignition switch is set to the ON position and goes off in approximately 3 seconds if the system is operating normally.

If the EPB malfunction indicator remains on, comes on while driving, or does not come on when the ignition switch is changed to the ON position, this indicates that the EPB may have malfunctioned.



If this occurs, have the system checked by an authorized HYUNDAI dealer.

The EPB malfunction indicator may illuminate when the ESC indicator comes on to indicate that the ESC is not working properly, but it does not indicate a malfunction of the EPB.

### **NOTICE**

- **If the EPB warning light is still on, have the system checked by an authorized HYUNDAI dealer.**
- **If the parking brake warning light does not illuminate or blinks even though the EPB switch was pulled up, the EPB may not be applied.**
- **If the parking brake warning light blinks when the EPB warning light is on, press the switch, and then pull it up. Repeat this one more time. If the EPB warning does not go off, have the system checked by an authorized HYUNDAI dealer.**

### **Parking brake warning light**

   
**BRAKE** Check the parking brake warning light by placing the ignition switch to the ON position (do not start the engine).

This light will be illuminated when the parking brake is applied with the ignition switch in the START or ON position.

If the parking brake warning light remains on after the parking brake is released while engine is running, there may be a malfunction in the brake system. Immediate attention is necessary.

If at all possible, cease driving the vehicle immediately. If that is not possible, use extreme caution while operating the vehicle and only continue to drive the vehicle until you can reach a safe location.

### Emergency braking

If there is a problem with the brake pedal while driving, emergency braking is possible by pulling up and holding the EPB switch. Braking is possible only while you are holding the EPB switch. However, braking distance will be longer than normal.



#### WARNING

Do not operate the parking brake while the vehicle is moving except in an emergency situation. It could damage the brake system and lead to a severe accident.



#### Information

During emergency braking, the parking brake warning light will illuminate to indicate that the system is operating.

#### NOTICE

If you continuously notice a noise or burning smell when the EPB is used for emergency braking, have system checked by an authorized HYUNDAI dealer.

#### When the EPB (Electronic Parking Brake) does not release

If the EPB does not release normally, contact an authorized HYUNDAI dealer by loading the vehicle on a flatbed tow truck and have the system checked.

### Auto Hold

The Auto Hold maintains the vehicle in a standstill even though the brake pedal is not depressed after the driver brings the vehicle to a complete stop by depressing the brake pedal.

#### To apply :

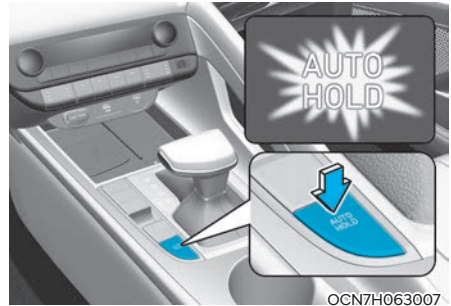

1. With the driver's door and engine hood closed, depress the brake pedal and then press the [AUTO HOLD] switch. The white AUTO HOLD indicator will come on and the system will be in the standby position.

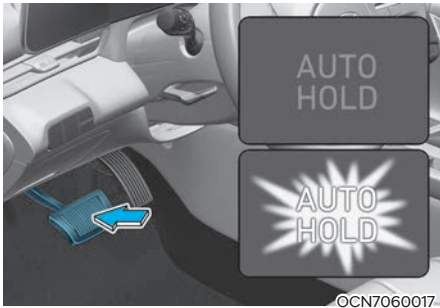

2. When you stop the vehicle completely by depressing the brake pedal, the Auto Hold maintains the brake pressure to hold the vehicle stationary. The indicator changes from white to green.
3. The vehicle will remain stationary even if you release the brake pedal.
4. If EPB is applied, Auto Hold will be released.

**To release :**

If you press the accelerator pedal with the gear in D (Drive), R (Reverse) or Manual shift mode, the Auto Hold will be released automatically and the vehicle will start to move. The AUTO HOLD indicator changes from green to white.

**⚠ WARNING**

When the AUTO HOLD is automatically released by depressing the accelerator pedal, always take a look around your vehicle.

Slowly depress the accelerator pedal for a smooth start.

**To cancel :**

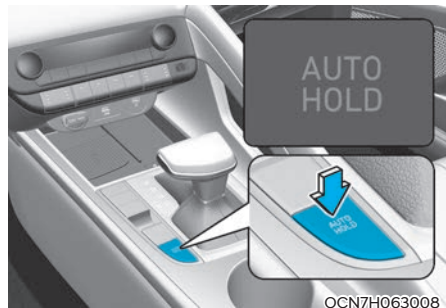

1. Depress the brake pedal.
  2. Press the [AUTO HOLD] switch.
- The AUTO HOLD indicator will turn off.

**⚠ WARNING**

To prevent, unexpected and sudden vehicle movement, ALWAYS press your foot on the brake pedal to cancel the Auto Hold before you:

- Drive downhill.
- Park the vehicle.

**i Information**

- The Auto Hold does not operate when:
  - The shift lever is in P (Park) and R (Reverse)
  - The EPB is applied

- For your safety, the Auto Hold automatically switches to EPB when:
  - The driver's door is opened.
  - The engine hood is opened.
  - The vehicle stops for more than 10 minutes
  - The vehicle stands on a steep slope
  - The vehicle moves several times

In these cases, the parking brake warning light comes on, the AUTO HOLD indicator changes from green to white, and a warning sound and a message will appear to inform you that EPB has been automatically engaged. Before driving off again, press foot brake pedal, check the surrounding area near your vehicle and release parking brake manually with the EPB switch.

- While operating Auto Hold, you may hear mechanical noise. However, it is normal operating noise.

### NOTICE

If the AUTO HOLD indicator changes to yellow, the Auto Hold is not working properly. Contact an authorized HYUNDAI dealer.



### WARNING

- Depress the accelerator pedal slowly when you start the vehicle.
- For your safety, cancel the Auto Hold when you drive downhill, back up the vehicle or park the vehicle.

### NOTICE

If there is a malfunction with the driver's door or engine hood open detection system, the Auto Hold may not work properly.

Contact an authorized HYUNDAI dealer.

### Warning messages

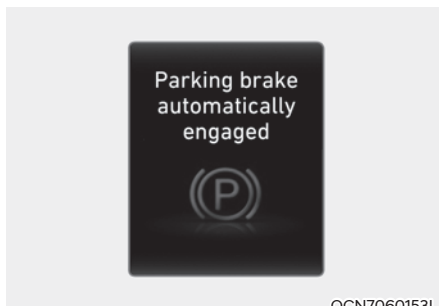

#### Parking brake automatically engaged

When the EPB is applied from Auto Hold, a warning will sound and a message will appear.

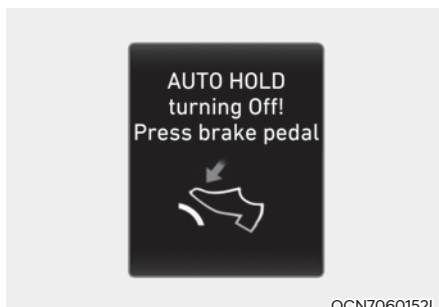

#### AUTO HOLD turning Off! Press brake pedal

When the conversion from Auto Hold to EPB is not working properly a warning will sound and a message will appear.

When this message is displayed, the Auto Hold and EPB may not operate. For your safety, depress the brake pedal.

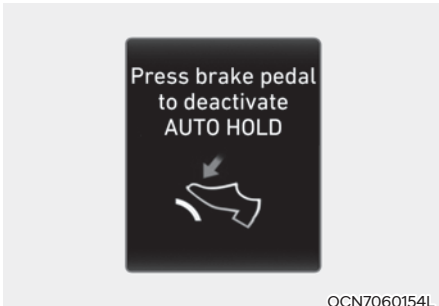

OCN7060154L

### Press brake pedal to deactivate **AUTO HOLD**

If you did not apply the brake pedal when you release the Auto Hold by pressing the [AUTO HOLD] switch, a warning will sound and a message will appear.

## Anti-lock Brake System (ABS)

### **WARNING**

An Anti-Lock Braking System (ABS) or an Electronic Stability Control (ESC) system will not prevent accidents due to improper or dangerous driving maneuvers. Even though vehicle control is improved during emergency braking, always maintain a safe distance between you and objects ahead of you. Vehicle speeds should always be reduced during extreme road conditions. The braking distance for cars equipped with ABS or ESC may be longer than for those without these systems in the following road conditions.

Drive your vehicle at reduced speeds during the following conditions:

- Rough, gravel or snow-covered roads.
- On roads where the road surface is pitted or has different surface height.
- Tire chains are installed on your vehicle.

The safety features of an ABS or ESC equipped vehicle should not be tested by high speed driving or cornering. This could endanger the safety of yourself or others.

ABS is an electronic braking system that helps prevent a braking skid. ABS allows the driver to steer and brake at the same time.

### Using ABS

To obtain the maximum benefit from your ABS in an emergency situation, do not attempt to modulate your brake pressure and do not try to pump your brakes. Depress your brake pedal as hard as possible.

When you apply your brakes under conditions which may lock the wheels, you may hear sounds from the brakes, or feel a corresponding sensation in the brake pedal. This is normal and it means your ABS is active.

ABS does not reduce the time or distance it takes to stop the vehicle.

Always maintain a safe distance from the vehicle in front of you.

ABS will not prevent a skid that results from sudden changes in direction, such as trying to take a corner too fast or making a sudden lane change. Always drive at a safe speed for the road and weather conditions.

ABS cannot prevent a loss of stability. Always steer moderately when braking hard. Severe or sharp steering wheel movement can still cause your vehicle to veer into oncoming traffic or off the road.

On loose or uneven road surfaces, operation of the anti-lock brake system may result in a longer stopping distance than for vehicles equipped with a conventional brake system.

The ABS warning light (ABS) will stay on for several seconds after the ignition switch is in the ON position. During that time, the ABS will go through self-diagnosis and the light will go off if everything is normal. If the light stays on, you may have a problem with your ABS. Contact an authorized HYUNDAI dealer as soon as possible.



### WARNING

If the ABS warning light (ABS) is on and stays on, you may have a problem with the ABS. Your power brakes will work normally. To reduce the risk of serious injury or death, contact your HYUNDAI dealer as soon as possible.



### CAUTION

When you drive on a road having poor traction, such as an icy road, and apply your brakes continuously, the ABS will be active continuously and the ABS warning light (ABS) may illuminate. Pull your car over to a safe place and turn the engine off.

Restart the engine. If the ABS warning light is off, then your ABS system is normal.

Otherwise, you may have a problem with your ABS system. Contact an authorized HYUNDAI dealer as soon as possible.



### Information

When you jump start your vehicle because of a drained battery, the ABS warning light (ABS) may turn on at the same time. This happens because of the low battery voltage. It does not mean your ABS is malfunctioning. Have the battery recharged before driving the vehicle.

## Electronic Stability Control (ESC) (if equipped)

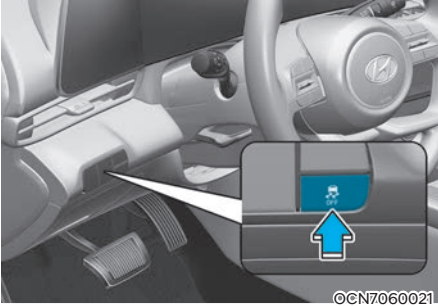

The Electronic Stability Control (ESC) system helps to stabilize the vehicle during cornering maneuvers. ESC checks where you are steering and where the vehicle is actually going. ESC applies braking pressure to any one of the vehicle's brakes and intervenes in the engine management system to assist the driver with keeping the vehicle on the intended path. It is not a substitute for safe driving practices. Always adjust your speed and driving to the road conditions.



### **WARNING**

**Never drive too fast for the road conditions or too quickly when cornering. The ESC system will not prevent accidents.**

**Excessive speed in turns, abrupt maneuvers, and hydroplaning on wet surfaces can result in severe accidents.**

### **ESC operation**

#### **ESC ON condition**

When the ignition switch is in the ON position, the ESC and the ESC OFF indicator lights illuminate for approximately three seconds. After both lights go off, the ESC is enabled.

#### **When operating**



When the ESC is in operation, the ESC indicator light blinks:

- When you apply your brakes under conditions which may lock the wheels, you may hear sounds from the brakes, or feel a corresponding sensation in the brake pedal. This is normal and it means your ESC is active.
- When the ESC activates, the engine may not respond to the accelerator as it does under routine conditions.
- If the Cruise Control was in use when the ESC activates, the Cruise Control automatically disengages. The Cruise Control can be reengaged when the road conditions allow. For more details, refer to "Cruise Control" in chapter 7. (if equipped)
- When moving out of the mud or driving on a slippery road, the engine RPM (revolutions per minute) may not increase even if you press the accelerator pedal deeply. This is to maintain the stability and traction of the vehicle and does not indicate a problem.

### ESC OFF condition

To cancel ESC operation:

- **State 1**

Press the ESC OFF button briefly. The ESC OFF indicator light and message "Traction Control disabled" will illuminate. In this state, the traction control function of ESC (engine management) is disabled, but the brake control function of ESC (braking management) still operates.

- **State 2**

Press and hold the ESC OFF button continuously for more than 3 seconds. The ESC OFF indicator light and message "Traction and Stability Control disabled" illuminates and a warning chime sounds. In this state, both the traction control function of ESC (engine management) and the brake control function of ESC (braking management) are disabled. If the ignition switch is placed to the LOCK/OFF position when ESC is off, ESC remains off. Upon restarting the engine, the ESC will automatically turn on again.

### Indicator lights

- ESC indicator light (blinks)



- ESC OFF indicator light (comes on)



When the ignition switch is placed to the ON position, the ESC indicator light illuminates, then goes off if the ESC system is operating normally.

The ESC indicator light blinks whenever the ESC is operating.

If ESC indicator light stays on, your vehicle may have a malfunction with the ESC system. When this warning light illuminates have your vehicle checked by an authorized HYUNDAI dealer as soon as possible.

The ESC OFF indicator light comes on when the ESC is turned off.



### WARNING

When the ESC is blinking, this indicates the ESC is active:

**Drive slowly and NEVER attempt to accelerate. NEVER turn the ESC off while the ESC indicator light is blinking or you may lose control of the vehicle resulting in an accident.**

### NOTICE

**Driving with wheels and tires with different sizes may cause the ESC system to malfunction. Before replacing tires, make sure all four tires and wheels are the same size. Never drive the vehicle with different sized wheels and tires installed.**

### **ESC OFF usage**

#### **When Driving**

The ESC OFF mode should only be used briefly to help free the vehicle if stuck in snow by temporarily stopping operation of the ESC to maintain wheel torque.

To turn ESC off while driving, press the ESC OFF button while driving on a flat road surface.

#### **NOTICE**

To prevent damage to the transmission:

- Do not allow wheel(s) of one axle to spin excessively while the ESC, ABS, and parking brake warning lights are displayed. The repairs would not be covered by the vehicle warranty. Reduce engine power and do not spin the wheel(s) excessively while these lights are displayed.
- When operating the vehicle on a dynamometer, make sure the ESC is turned off (ESC OFF light illuminated).

#### **i Information**

Turning the ESC off does not affect ABS or standard brake system operation.

### **Vehicle Stability Management (VSM)**

The Vehicle Stability Management (VSM) is a function of the Electronic Stability Control (ESC) system. It helps ensure the vehicle stays stable when accelerating or braking suddenly on wet, slippery and rough roads where traction over the four tires can suddenly become uneven.



#### **WARNING**

Take the following precautions when using the Vehicle Stability Management (VSM):

- ALWAYS check the speed and the distance to the vehicle ahead. The VSM is not a substitute for safe driving practices.
- Never drive too fast for the road conditions. The VSM system will not prevent accidents. Excessive speed in bad weather, slippery and uneven roads can result in severe accidents.

## VSM operation

### VSM ON condition

The VSM operates when:

- The Electronic Stability Control (ESC) is on.
- Vehicle speed is approximately above 9 mph (15 km/h) on curve roads.
- Vehicle speed is approximately above 12 mph (20 km/h) when the vehicle is braking on rough roads.

### When operating

When you apply your brakes under conditions which may activate the ESC, you may hear sounds from the brakes, or feel a corresponding sensation in the brake pedal. This is normal and it means your VSM is active.



### NOTICE

The VSM does not operate when:

- Driving on a banked road such as gradient or incline.
- Driving rearward.
- ESC OFF indicator light is on.
- MDPS (Motor Driven Power Steering) warning light () is on or blinks.



### WARNING

If ESC indicator light () or MDPS warning light () stays on or blinks, your vehicle may have a malfunction with the VSM system. When the warning light illuminates, have your vehicle checked by an authorized HYUNDAI dealer as soon as possible.

Driving with wheels and tires with different sizes may cause the ESC system to malfunction. Before replacing tires, make sure all four tires and wheels are the same size. Never drive the vehicle with different sized tires and wheels installed.

## Hill-Start Assist Control (HAC)

Hill-Start Assist Control helps prevent the vehicle from rolling backwards when starting a vehicle from a stop on a hill. The system operates the brakes automatically for about 2 seconds (maximum of 5 seconds when the accelerator pedal is slightly pressed during HAC operation) and releases the brake after 2 seconds or when the accelerator pedal is pressed.



### WARNING

**Always be ready to press the accelerator pedal when starting off an incline. Hill-Start Assist Control activates only for about 2 seconds (maximum of 5 seconds when the accelerator pedal is slightly pressed during HAC operation).**

### NOTICE

- The HAC does not operate when the shift lever is in P (Park) or N (Neutral)
- The HAC activates even though the ESC (Electronic Stability Control) is off but does not activate when the ESC has malfunctioned.

## Good Braking Practices



### **WARNING**

**Whenever leaving the vehicle or parking, always come to a complete stop and continue to depress the brake pedal. Move the shift lever into P (Park) position, then apply the parking brake, and place the ignition switch in the LOCK/OFF position.**

**Vehicles parked with the parking brake not applied or not fully engaged may roll inadvertently and may cause injury to the driver and others. ALWAYS apply the parking brake before exiting the vehicle.**

Wet brakes can be dangerous! The brakes may get wet if the vehicle is driven through standing water or if it is washed. Your vehicle will not stop as quickly if the brakes are wet. Wet brakes may cause the vehicle to pull to one side.

To dry the brakes, apply the brakes lightly until the braking action returns to normal, taking care to keep the vehicle under control at all times. If the braking action does not return to normal, stop as soon as it is safe to do so and call an authorized HYUNDAI dealer for assistance.

DO NOT drive with your foot resting on the brake pedal. Even light, but constant pedal pressure can result in the brakes overheating, brake wear, and possibly even brake failure.

If a tire goes flat while you are driving, apply the brakes gently and keep the vehicle pointed straight ahead while you slow down. When you are moving slowly enough for it to be safe to do so, pull off the road and stop in a safe location.

Keep your foot firmly on the brake pedal when the vehicle is stopped to prevent the vehicle from rolling forward.

## DRIVE MODE INTEGRATED CONTROL SYSTEM (IF EQUIPPED)

### Drive Mode



The drive mode may be selected according to the driver's preference or road condition.

#### **i** Information

**If there is a problem with the instrument cluster, the drive mode will be in ECO mode and may not change to SPORT mode or SMART mode.**

The mode changes whenever the DRIVE MODE button is pressed. The drive mode resets to ECO mode when the engine is restarted.

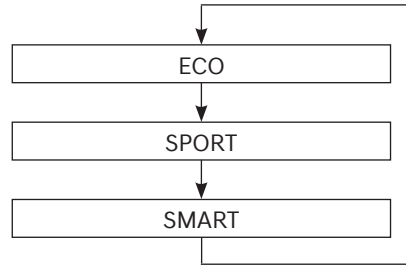

- ECO mode :  
ECO mode provides smooth driving and comfortable riding.
- SPORT mode :  
SPORT mode provides sporty but firm riding

The drive mode will change to ECO mode when the engine is restarted. However, except when it is in SMART mode. SMART mode will be maintained, as selected when the engine is restarted.

### **SPORT mode**



SPORT mode manages the driving dynamics by automatically adjusting the steering effort, the engine and transmission control logic for enhanced driver performance.

- When SPORT mode is selected by using the DRIVE MODE button, the SPORT indicator will illuminate.
- When SPORT mode is activated:
  - The engine rpm will tend to remain raised over a certain length of time even after releasing the accelerator
  - Upshifts are delayed when accelerating

#### ***i* Information**

In SPORT mode, the fuel efficiency may decrease.

### **SMART mode**



SMART mode selects the proper driving mode among ECO, NORMAL and SPORT by judging the driver's driving habits (for example, Economic or Aggressive (Sportive)) from the brake pedal depression or the steering wheel operation.

- Toggle the DRIVE MODE button to select SMART mode. When SMART mode is selected, the indicator illuminates on the instrument cluster.
- SMART mode automatically controls the vehicle driving, such as gear shifting patterns and engine torque, in accordance with the driver's driving habits.

#### ***i* Information**

When you mildly drive the vehicle When you dynamically drive the vehicle in SMART mode by abruptly decelerating or sharply turning the driving mode changes to SMART SPORT mode. However, it may adversely affect fuel economy.

### Various driving situations, which you may encounter in SMART mode

- The driving mode automatically changes to SMART ECO mode after a certain period of time, when you gently depress the accelerator pedal (Your driving is categorized to be economic.).
- The driving mode automatically changes from SMART ECO mode to SMART NORMAL mode after a certain period of time, when you sharply or repetitively depress the accelerator pedal.
- The driving mode automatically changes to SMART NORMAL mode with the same driving patterns, when the vehicle starts to drive on an upward slope of a certain angle. The driving mode automatically returns to SMART ECO mode, when the vehicle enters a leveled road.
- The driving mode automatically changes to SMART SPORT, when you abruptly accelerate the vehicle or repetitively operate the steering wheel (Your driving is categorized to be sporty.). In this mode, your vehicle drives in a lower gear for abrupt accelerating/decelerating and increases the engine brake performance.
- You may still sense the engine braking performance, even when you release the accelerator pedal in SMART SPORT mode. It is because your vehicle remains in lower gear over a certain period of time for next acceleration. Thus, it is a normal driving situation, not indicating any malfunction.
- The driving mode automatically changes to SMART SPORT mode only in harsh driving situations. In most of the normal driving situations, the driving mode sets to be either in SMART ECO mode or in SMART NORMAL mode.

### Limitation of SMART mode

The SMART mode may be limited in following situations. (The OFF indicator illuminates in those situations.)

- The cruise control is activated :  
The cruise control system may deactivate the SMART mode when the vehicle is controlled by the set speed of Smart Cruise Control system. (SMART mode is not deactivated just by activating the cruise control system.)
- The transmission oil temperature is either extremely low or extremely high :  
The SMART mode can be active in most of the normal driving situations. However, an extremely high/ low transmission oil temperature may temporarily deactivate the SMART mode, because the transmission condition is out of normal operation condition.

## SPECIAL DRIVING CONDITIONS

### Hazardous Driving Conditions

When hazardous driving elements are encountered such as water, snow, ice, mud and sand, take the below suggestions:

- Drive cautiously and keep a longer braking distance.
- Avoid abrupt braking or steering.
- When your vehicle is stuck in snow, mud, or sand, use second gear. Accelerate slowly to avoid unnecessary wheel spin.
- Put sand, rock salt, tire chains or other non-slip materials under the wheels to provide additional traction while the vehicle becomes stuck in ice, snow, or mud.



#### WARNING

**Downshifting with dual clutch transmission while driving on slippery surfaces can cause an accident. The sudden change in tire speed could cause the tires to skid. Be careful when downshifting on slippery surfaces.**

### Rocking the Vehicle

If it is necessary to rock the vehicle to free it from snow, sand, or mud, first turn the steering wheel right and left to clear the area around your front wheels. Then, shift back and forth between R (Reverse) and a forward gear.

Try to avoid spinning the wheels, and do not race the engine.

To prevent transmission wear, wait until the wheels stop spinning before shifting gears. Release the accelerator pedal while shifting, and press lightly on the accelerator pedal while the transmission is in gear. Slowly spinning the wheels in forward and reverse directions causes a rocking motion that may free the vehicle.



#### WARNING

**If the vehicle is stuck and excessive wheel spin occurs, the temperature of the tires can increase very quickly. If the tires become damaged, a tire blow out or tire explosion can occur. This condition is dangerous - you and others may be injured. Do not attempt this procedure if people or objects are anywhere near the vehicle.**

**If you attempt to free the vehicle, the vehicle can overheat quickly, possibly causing an engine compartment fire or other damage. Try to avoid spinning the wheels as much as possible to prevent overheating of either the tires or the engine. DO NOT allow the vehicle to spin the wheels above 35 mph (56 km/h).**



#### Information

The ESC system must be turned OFF before rocking the vehicle.

#### NOTICE

**If you are still stuck after rocking the vehicle a few times, have the vehicle pulled out by a tow vehicle to avoid engine overheating, possible damage to the transmission, and tire damage. See "Towing" in chapter 8.**

## Smooth Cornering

Avoid braking or gear changing in corners, especially when roads are wet. Ideally, corners should always be taken under gentle acceleration.

## Driving at Night

Night driving presents more hazards than driving in the daylight. Here are some important tips to remember:

- Slow down and keep more distance between you and other vehicles, as it may be more difficult to see at night, especially in areas where there may not be any street lights.
- Adjust your mirrors to reduce the glare from other driver's headlights.
- Keep your headlights clean and properly aimed. Dirty or improperly aimed headlights will make it much more difficult to see at night.
- Avoid staring directly at the headlights of oncoming vehicles. You could be temporarily blinded, and it will take several seconds for your eyes to readjust to the darkness.

## Driving in the Rain

Rain and wet roads can make driving dangerous. Here are a few things to consider when driving in the rain or on slick pavement:

- Slow down and allow extra following distance. A heavy rainfall makes it harder to see and increases the distance needed to stop your vehicle.
- Turn OFF your Cruise Control.
- Replace your windshield wiper blades when they show signs of streaking or missing areas on the windshield.
- Tires should be properly maintained with at least 2/32nds of an inch of tread depth. If your tires do not have enough tread, making a quick stop on wet pavement can cause a skid and possibly lead to an accident. See "Tire Tread" in chapter 9.
- Turn on your headlights to make it easier for others to see you.
- Driving too fast through large puddles can affect your brakes. If you must go through puddles, try to drive through them slowly.
- If you believe your brakes may be wet, apply them lightly while driving until normal braking operation returns.

## Hydroplaning

If the road is wet enough and you are going fast enough, your vehicle may have little or no contact with the road surface and actually ride on the water. The best advice is SLOW DOWN when the road is wet.

The risk of hydroplaning increases as the depth of tire tread decreases, refer to "Tire Tread" in chapter 9.

### Driving in Flooded Areas

Avoid driving through flooded areas unless you are sure the water is no higher than the bottom of the wheel hub. Drive through any water slowly. Allow adequate stopping distance because brake performance may be reduced.

After driving through water, dry the brakes by gently applying them several times while the vehicle is moving slowly.

### Highway Driving

#### **Tires**

Adjust the tire inflation, as specified. Under-inflation may overheat or damage the tires.

Do not install worn-out or damaged tires, which may reduce traction or adversely affect vehicle handling. This could lead to sudden tire failure that may cause loss of vehicle control resulting in an accident.

### Information

**Never over-inflate your tires above the maximum inflation pressure, as specified on your tires.**

#### ***Fuel, engine coolant and engine oil***

Driving at higher speeds on the highway consumes more fuel and is less efficient than driving at a slower, more moderate speed. Maintain a moderate speed in order to conserve fuel when driving on the highway.

Be sure to check both the engine coolant level and the engine oil before driving.

#### ***Drive belt***

A loose or damaged drive belt may overheat the engine.

## WINTER DRIVING

The severe weather conditions of winter quickly wear out tires and cause other problems. To minimize winter driving problems, you should take the following suggestions:

### Snow or Icy Conditions

You need to keep sufficient distance between your vehicle and the vehicle in front of you.

Apply the brakes gently. Speeding, rapid acceleration, sudden brake applications, and sharp turns are potentially very hazardous practices. During deceleration, use engine braking to the fullest extent. Sudden brake applications on snowy or icy roads may cause the vehicle to skid.

To drive your vehicle in deep snow, it may be necessary to use snow tires or to install tire chains on your tires.

Always carry emergency equipment. Some of the items you may want to carry include tire chains, tow straps or chains, a flashlight, emergency flares, sand, a shovel, jumper cables, a window scraper, gloves, ground cloth, coveralls, a blanket, etc.

### Snow tires



#### WARNING

**Snow tires should be equivalent in size and type to the vehicle's standard tires. Otherwise, the safety and handling of your vehicle may be adversely affected.**

If you mount snow tires on your vehicle, make sure to use radial tires of the same size and load range as the original tires. Mount snow tires on all four wheels to balance your vehicle's handling in all weather conditions. The traction provided by snow tires on dry roads may not be as high as your vehicle's original equipment tires. Check with the tire dealer for maximum speed recommendations.

### Information

**Do not install studded tires without first checking local, state and municipal regulations for possible restrictions against their use.**

### *Tire chains*

Since the sidewalls of radial tires are thinner than other types of tires, they may be damaged by mounting some types of tire chains on them. Therefore the use of snow tires is preferred over the use of tire chains.

If the road and weather conditions require the use of tire chains, be sure to use tire chains that have been properly selected for the size of tire on your HYUNDAI vehicle.

Be sure to follow the guidelines and installation instructions provided from the tire chain manufacturer.

Damage to your vehicle caused by improper tire chain use is not covered by your vehicle manufacturer's warranty.



#### WARNING

**The use of tire chains may adversely affect vehicle handling:**

- Drive less than 20 mph (30 km/h) or the chain manufacturer's recommended speed limit, whichever is lower.
- Drive carefully and avoid bumps, holes, sharp turns, and other road hazards, which may cause the vehicle to bounce.
- Avoid sharp turns or locked wheel braking.

**i** Information

- Install tire chains on both left and right front tires. It should be noted that installing tire chains on the tires will provide a greater driving force, but will not prevent side skids.
- Do not install studded tires without first checking local, state and municipal regulations for possible restrictions against their use.

**Chain installation**

When installing tire chains, follow the manufacturer's instructions and mount them as tightly possible. Drive slowly (less than 20 mph (30 km/h)) with chains installed. If you hear the chains contacting the body or chassis, stop and tighten them. If they still make contact, slow down until the noise stops. Remove the tire chains as soon as you begin driving on cleared roads.

When mounting snow chains, park the vehicle on level ground away from traffic. Turn on the vehicle Hazard Warning Flasher and place a triangular emergency warning device behind the vehicle (if available). Always place the vehicle in P (Park), apply the parking brake and turn off the engine before installing snow chains.

**NOTICE**

When using tire chains:

- Wrong size chains or improperly installed chains can damage your vehicle's brake lines, suspension, body and wheels.
- Use SAE "S" class or wire chains.
- If you hear noise caused by chains contacting the body, retighten the chain to prevent contact with the vehicle body.
- To prevent body damage, retighten the chains after driving 0.3~0.6 miles (0.5~1.0 km).
- Do not use tire chains on vehicles equipped with aluminum wheels. If possible, use a wire type chain.
- Use wire chains less than 0.59 inch (15mm) wide to prevent damage to the chain's connection.

**Winter Precautions**

***Use high quality ethylene glycol coolant***

Your vehicle is delivered with high quality ethylene glycol coolant in the cooling system. It is the only type of coolant that should be used because it helps prevent corrosion in the cooling system, lubricates the water pump and prevents freezing. Be sure to replace or replenish your coolant in accordance with the maintenance schedule in chapter 9. Before winter, have your coolant tested to assure that its freezing point is sufficient for the temperatures anticipated during the winter.

***Change to "winter weight" oil if necessary***

In some climates it is recommended that a lower viscosity "winter weight" oil be used during cold weather. See chapter 8 for recommendations. If you aren't sure what weight oil you should use, consult an authorized HYUNDAI dealer.

***Check battery and cables***

Winter puts additional burdens on the battery system. Visually inspect the battery and cables as described in chapter 8. The level of charge in your battery can be checked by an authorized HYUNDAI dealer or a service station.

If the vehicle is not used for a long time, park the vehicle indoors if possible.

***Check spark plugs and ignition system***

Inspect your spark plugs as described in chapter 8 and replace them if necessary. Also check all ignition wiring and components to be sure they are not cracked, worn or damaged in any way.

***Use approved window washer anti-freeze in system***

To keep the water in the window washer system from freezing, add an approved window washer anti-freeze solution in accordance with instructions on the container.

Window washer anti-freeze is available from an authorized HYUNDAI dealer and most auto parts outlets. Do not use engine coolant or other types of antifreeze as these may damage the paint finish.

***Do not let your parking brake freeze***

Under some conditions your parking brake can freeze in the engaged position. This is most likely to happen when there is an accumulation of snow or ice around or near the rear brakes or if the brakes are wet. If there is a risk the parking brake may freeze, apply it only temporarily while you put the gear selector lever in P and block the rear wheels so the car cannot roll. Then release the parking brake.

***Do not let ice and snow accumulate underneath***

Under some conditions, snow and ice can build up under the fenders and interfere with the steering. When driving in severe winter conditions where this may happen, you should periodically check underneath the car to be sure the movement of the front wheels and the steering components is not obstructed.

***Don't place foreign objects or materials in the engine compartment***

Placement of foreign object or materials which prevent cooling of the engine, in the engine compartment, may cause a failure or combustion. The manufacturer is not responsible for the damage caused by such placement.

***To keep locks from freezing***

To keep the locks from freezing, squirt an approved de-icer fluid or glycerine into the key opening. If a lock is covered with ice, squirt it with an approved de-icing fluid to remove the ice. If the lock is frozen internally, you may be able to thaw it out by using a heated key. Handle the heated key with care to avoid injury.

***Drive your vehicle when water vapor condenses and accumulates inside the exhaust pipes***

When the vehicle is stopped for a long time in winter while the engine is running, water vapor may condense and accumulate inside the exhaust pipes. Water in the exhaust pipes may cause noise, etc., but it is drained driving at medium to high speed.

## VEHICLE LOAD LIMIT

Two labels on your driver's door sill show how much weight your vehicle was designed to carry: the Tire and Loading Information Label and the Certification Label.

Before loading your vehicle, familiarize yourself with the following terms for determining your vehicle's weight ratings, from the vehicle's specifications and the Certification Label:

### Base Curb Weight

This is the weight of the vehicle including a full tank of fuel and all standard equipment. It does not include passengers, cargo, or optional equipment.

### Vehicle Curb Weight

This is the weight of your new vehicle when you picked it up from your dealer plus any aftermarket equipment.

### Cargo Weight

This figure includes all weight added to the Base Curb Weight, including cargo and optional equipment.

### Towing Weight

We do not recommend using this vehicle for trailer towing.

### GAW (Gross Axle Weight)

This is the total weight placed on each axle (front and rear) - including vehicle curb weight and all payload.

### GAWR (Gross Axle Weight Rating)

This is the maximum allowable weight that can be carried by a single axle (front or rear). These numbers are shown on the Certification Label. The total load on each axle must never exceed its GAWR.

### GVW (Gross Vehicle Weight)

This is the Base Curb Weight plus actual Cargo Weight plus passengers.

### GVWR (Gross Vehicle Weight Rating)

This is the maximum allowable weight of the fully loaded vehicle (including all options, equipment, passengers and cargo). The GVWR is shown on the Certification Label located on the driver's door sill.

## Tire Loading Information Label

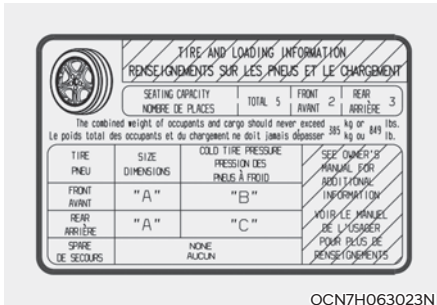

The label located on the driver's door sill gives the original tire size, cold tire pressures recommended for your vehicle, the number of people that can be in your vehicle and vehicle capacity weight.

### **Vehicle capacity weight** **849 lbs. (385 kg)**

Vehicle capacity weight is the maximum combined weight of occupants and cargo. If your vehicle is equipped with a trailer, the combined weight includes the tongue load.

### **Seating capacity**

Total: 5 persons  
(Front seat : 2 persons,  
Rear seat : 3 persons)

Seating capacity is the maximum number of occupants including a driver, your vehicle may carry. However, the seating capacity may be reduced based upon the weight of all of the occupants, and the weight of the cargo being carried or towed. Do not overload the vehicle as there is a limit to the total weight, or load limit including occupants and cargo, the vehicle can carry.

### **Towing capacity**

We do not recommend using this vehicle for trailer towing.

### **Cargo capacity**

The cargo capacity of your vehicle will increase or decrease depending on the weight and the number of occupants and the tongue load, if your vehicle is equipped with a trailer.









**Steps for determining correct load limit**

1. Locate the statement "The combined weight of occupants and cargo should never exceed XXX kg or XXX lbs." on your vehicle's placard.
2. Determine the combined weight of the driver and passengers that will be riding in your vehicle.
3. Subtract the combined weight of the driver and passengers from XXX kg or XXX lbs.
4. The resulting figure equals the available amount of cargo and luggage load capacity. For example, if the "XXX" amount equals 1400 lbs. and there will be five 150 lb. passengers in your vehicle, the amount of available cargo and luggage load capacity is 650 lbs. (1400 - 750 (5 x 150) = 650 lbs.)
5. Determine the combined weight of luggage and cargo being loaded on the vehicle. That weight may not safely exceed the available cargo and luggage load capacity calculated in Step 4.
6. If your vehicle will be towing a trailer, load from your trailer will be transferred to your vehicle. Consult this manual to determine how this reduces the available cargo and luggage load capacity of your vehicle.



**WARNING**

**Do not overload the vehicle as there is a limit to the total weight, or load limit, including occupants and cargo, the vehicle can carry. Overloading can shorten the life of the vehicle. If the GVWR or the GAWR is exceeded, parts on the vehicle can be broken, and it can change the handling of your vehicle. These could cause you to lose control and result in an accident.**

<b>Example 1</b>	 Maximum Load (1400 lbs.) (635 kg)	$\geq$  Passenger Weight (150 lbs. $\times$ 2 = 300 lbs.) (68 kg $\times$ 2 = 136 kg)	$+$  Cargo Weight (1100 lbs.) (499 kg)
<b>Example 2</b>	 Maximum Load (1400 lbs.) (635 kg)	$\geq$  Passenger Weight (150 lbs. $\times$ 5 = 750 lbs.) (68 kg $\times$ 5 = 340 kg)	$+$  Cargo Weight (650 lbs.) (295 kg)
<b>Example 3</b>	 Maximum Load (1400 lbs.) (635 kg)	$\geq$  Passenger Weight (172 lbs. $\times$ 5 = 860 lbs.) (78 kg $\times$ 5 = 390 kg)	$+$  Cargo Weight (540 lbs.) (245 kg)

### Certification label



The certification label is located on the driver's door sill at the center pillar and shows the maximum allowable weight of the fully loaded vehicle. This is called the GVWR (Gross Vehicle Weight Rating). The GVWR includes the weight of the vehicle, all occupants, fuel and cargo.

This label also tells you the maximum weight that can be supported by the front and rear axles, called Gross Axle Weight Rating (GAWR).

The total weight of the vehicle, including all occupants, accessories, cargo, and trailer tongue load must not exceed the Gross Vehicle Weight Rating (GVWR) or the Gross Axle Weight Rating (GAWR). To find out the actual loads on your front and rear axles, you need to go to a weigh station and weigh your vehicle. Be sure to spread out your load equally on both sides of the centerline.

### WARNING

#### Overloading

- Never exceed the GVWR for your vehicle, the GAWR for either the front or rear axle and vehicle capacity weight. Exceeding these ratings can affect your vehicle's handling and braking ability, and cause an accident.
- Do not overload your vehicle. Overloading your vehicle can cause heat buildup in your vehicle's tires and possible tire failure, increased stopping distances and poor vehicle handling-all of which may result in a crash.

### **NOTICE**

Overloading your vehicle may cause damage. Repairs would not be covered by your warranty. Do not overload your vehicle.

### WARNING

If you carry items inside your vehicle (for example, suitcases, tools, packages, or anything else), they are moving as fast as the vehicle. If you have to stop or turn quickly, or if there is a crash, the items will keep going and can cause an injury if they strike the driver or a passenger.

- Put items in the cargo area of your vehicle. Try to spread the weight evenly.
- Do not stack items, like suitcases, inside the vehicle above the tops of the seats.
- Do not leave an unsecured child restraint in your vehicle.
- When you carry something inside the vehicle, secure it.

## **TRAILER TOWING**

We do not recommend using this vehicle for trailer towing.



# 7. Driver Assistance System

Due to the infotainment software version, the description of each function of the driver assistance system may differ from the owner's manual

Driving Safety	
Forward Collision-Avoidance Assist (FCA) (front view camera only).....	7-2
Forward Collision-Avoidance Assist (FCA) (sensor fusion).....	7-14
Lane Keeping Assist (LKA) .....	7-31
Blind-Spot Collision-Avoidance Assist (BCA).....	7-38
SAFE EXIT WARNING (SEW).....	7-48
Manual Speed Limit Assist (MSLA) .....	7-53
Intelligent speed limit assist (isla).....	7-56
Driver Attention Warning (DAW).....	7-61
Driving Convenience	
Cruise Control (CC).....	7-69
Smart Cruise Control (SCC).....	7-73
Navigation-Based Smart Cruise Control (NSCC) .....	7-89
Lane Following Assist (LFA).....	7-95
Highway Driving Assist (HDA).....	7-99
Parking Safety	
Rear View Monitor (RVM).....	7-106
Rear Cross-Traffic Collision-Avoidance Assist (RCCA) .....	7-114
Declaration of Conformity.....	7-124

## FORWARD COLLISION-AVOIDANCE ASSIST (FCA) (FRONT VIEW CAMERA ONLY) (IF EQUIPPED)

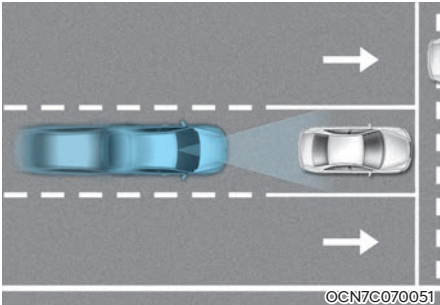

Forward Collision-Avoidance Assist helps detect a vehicle, a powered two-wheeler, a pedestrian, or a cyclist ahead on the road and may warn you of a possible collision with a warning message on the instrument cluster and a warning sound. Also, Forward Collision-Avoidance Assist may assist with braking your vehicle to help reduce collision speed or avoid a collision.

### **Detecting sensor**



[1] : Front view camera

Refer to the picture above for the detailed location of the detecting sensor.



### **CAUTION**

Take the following precautions to maintain optimal performance of the detecting sensor:

- **NEVER** disassemble the detecting sensor or sensor assembly, or cause any damage to it.
- If the detecting sensor has been replaced or repaired, have your vehicle inspected by an authorized HYUNDAI dealer.
- **NEVER** install any accessories or stickers on the front windshield, or tint the front windshield.
- **Exercise extreme caution** to keep the front view camera dry.
- **NEVER** place any reflective objects (for example, white paper, mirror) over the dashboard.

## Forward Collision-Avoidance Assist Settings

### Forward Safety

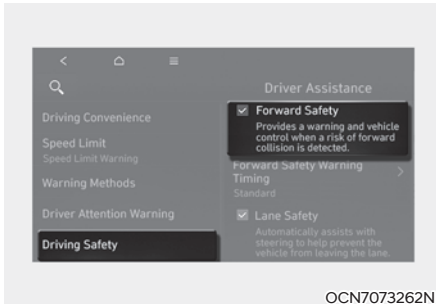

OCN7073262N

With the ignition switch ON, go to **User Settings > Driver Assistance > Driving Safety** from the settings menu in the instrument cluster or **Setup > Vehicle > Driver Assistance > Driving Safety** from the settings menu in the infotainment system to select the following:

- If **Forward Safety** is selected, Forward Collision-Avoidance Assist will warn the driver with a warning message, an audible warning depending on the collision risk levels. Braking assist will be applied depending on the collision risk levels. If Forward Safety is deselected, Forward Safety will turn off. The warning light (🚦) will illuminate on the cluster.



### WARNING

Each time the engine is restarted, Forward Collision-Avoidance Assist turns on.

If Forward Safety is selected after the engine is restarted, the function does NOT brake your vehicle to help avoid a collision.

## Forward Safety Warning Timing

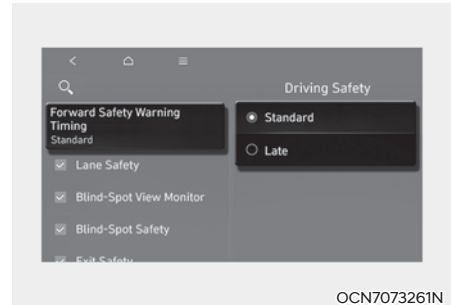

OCN7073261N

With the engine on, select **User Settings > Driver Assistance > Driving Safety > Forward Safety Warning Timing** from the settings menu in the instrument cluster or **Setup > Vehicle > Driver Assistance > Driving Safety > Forward Safety Warning Timing** settings menu in the infotainment system to change the initial warning activation time for Forward Collision-Avoidance Assist. The warning time can be set to either Normal or Late.

- Use **Standard** in normal driving conditions. If the Warning Timing seems sensitive, change it to "Late".
- If **Late** is selected, Forward Collision-Avoidance Assist, warns the driver more slowly.



### CAUTION

- Even though "Standard" is selected for Warning Timing, if the front vehicle suddenly stops, the warning may seem late.
- Select "Late" for Warning Timing when traffic is light and when driving speed is slow.



### Information

If the engine is restarted, Warning Timing will maintain the last setting.

### Warning Methods

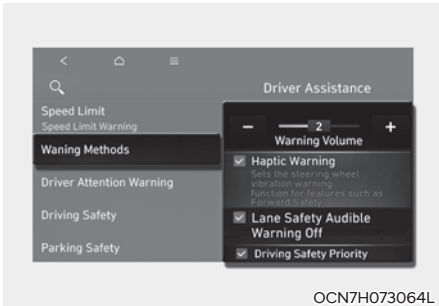

The Warning Methods can be set with the vehicle on. Select **User Settings > Driver Assistance > Warning Methods** from the settings menu in the instrument cluster or **Setup > Vehicle > Driver Assistance > Warning Methods** from the settings menu in the infotainment system to change the following settings:

- **Warning Volume:** Adjusts the volume of the warning sound. If you turn off the **Warning Volume**, for your safety, the function may warn you with a low volume.
- **Haptic Warning:** Activate the steering wheel vibration warning.
- **Driving Safety Priority:** Lowers all other audio volumes when the Driving Safety system sounds a warning.

### **i** Information

- **If you change the Warning Methods, the Warning Methods of other Driver Assistance systems may change.**
- **The Warning Volume and Haptic Warning cannot be turned off at the same time. When one of the warning is turned off the other is activated.**
- **If the engine is restarted, Warning Methods will maintain the last setting.**
- **The setting menu may not exist based on vehicle specification.**

### Forward Collision-Avoidance Assist Operation

#### Basic function

The basic feature of Forward Collision-Avoidance Assist is to warn and help control the vehicle depending on collision risk level: 'Collision Warning', 'Emergency Braking' and 'Stopping vehicle and ending brake control'.

#### Collision Warning



- To warn the driver of a collision, the 'Collision Warning' warning message will appear on the cluster and an audible warning will sound and the steering wheel will vibrate.
- If a vehicle is detected in front, the function will operate when your vehicle speed is approximately 6-112 mph (10-180 km/h).
- If a pedestrian or cyclist is detected in front, the system will operate when your vehicle speed is approximately 6-50 mph (10-80 km/h)

## Emergency Braking

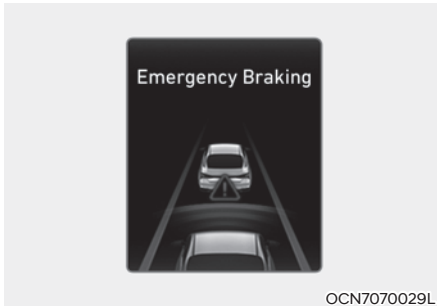

- To warn the driver that emergency braking will occur, the 'Emergency Braking' warning message will appear on the cluster and an audible warning will sound and the steering wheel will vibrate.
- If a vehicle is detected in front, the function will operate when your vehicle speed is approximately 6-37 mph (10-60 km/h).
- If a pedestrian or cyclist is detected in front, the function will operate when your vehicle speed is approximately 6-37 mph (10-60 km/h).
- In emergency braking situation, braking is assisted with strong braking power by the function to help prevent collision with the vehicle or pedestrian ahead.

## Stopping vehicle and ending brake control



- When the vehicle is stopped due to emergency braking, 'Drive carefully' warning message will appear on the cluster.  
For your safety, the driver should depress the brake pedal immediately and check the surroundings.
- Brake control will end after the vehicle is stopped by emergency braking for approximately 2 seconds.

### **WARNING**

**Take the following precautions when using Forward Collision-Avoidance Assist:**

- **For your safety, only change the Settings after parking the vehicle at a safe location.**
- **With 'Active Assist' or 'Warning Only' selected, when ESC is turned off by pressing and holding the ESC OFF button, Forward Collision-Avoidance Assist will turn off automatically. In this case, the function cannot be set from the Settings menu and the  warning light will illuminate on the cluster which is normal. If ESC is turned on by pressing the ESC OFF button, Forward Collision-Avoidance Assist will maintain the last setting.**

- Forward Collision-Avoidance Assist does not operate in all situations and cannot avoid all collisions.
- The driver has the responsibility to control the vehicle. Do not solely depend on Forward Collision-Avoidance Assist. Rather, maintain a safe braking distance, and, if necessary, depress the brake pedal to reduce driving speed or to stop the vehicle.
- Never deliberately operate Forward Collision-Avoidance Assist on people, objects, etc. It may cause serious injury or death.
- Forward Collision-Avoidance Assist may not operate if the driver depresses the brake pedal to avoid a collision.
- Depending on the road and driving conditions, Forward Collision-Avoidance Assist may warn the driver late or may not warn the driver.
- During Forward Collision-Avoidance Assist operation the vehicle may stop suddenly injuring passengers and shifting loose objects. Always have the seat belt on and keep loose objects secured.
- If any other system's warning message is displayed or audible warning is generated, Forward Collision-Avoidance Assist warning message may not be displayed and audible warning may not be generated.
- You may not hear the warning sound of Forward Collision-Avoidance Assist if the surrounding is noisy.
- Forward Collision-Avoidance Assist may turn off or may not operate properly or may operate unnecessarily depending on the road conditions and the surroundings.



### WARNING

- Even if there is a problem with Forward Collision-Avoidance Assist, the vehicle's basic braking will function normally.
- During emergency braking, braking control by the function will automatically cancel when the driver excessively depresses the accelerator pedal or sharply steers the vehicle.



### CAUTION

- Depending on the condition of the vehicle, powered-two wheeler, pedestrian and cyclist in front and the surroundings, the speed range to operate Forward Collision-Avoidance Assist may reduce. Forward Collision-Avoidance Assist may only warn the driver, or it may not operate.
- Forward Collision-Avoidance Assist will operate under certain conditions by judging the risk level based on the condition of the oncoming vehicle or powered-two wheeler, driving direction, speed and surroundings. Forward Collision-Avoidance Assist may be limited or disabled if the vehicle or powered-two wheeler speed is too high or the distance to the vehicle ahead is far.





### Information

- In a situation where collision is imminent, braking may be assisted by Forward Collision-Avoidance Assist when braking is insufficient by the driver.
- The images and colors in the instrument cluster may differ depending on the cluster type or theme selected from the instrument cluster.

## Forward Collision-Avoidance Assist Malfunction and Limitations

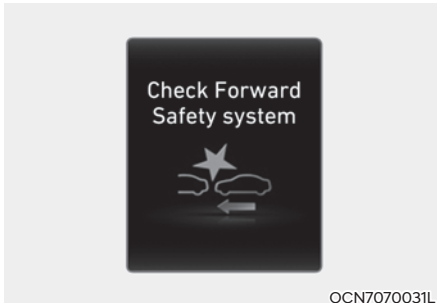
### Forward Collision-Avoidance Assist malfunction





When Forward Collision-Avoidance Assist is not working properly, the 'Check Forward Safety system' warning message will appear, and the  and  warning lights will illuminate on the cluster. Have the vehicle inspected by an authorized HYUNDAI dealer.

### Forward Collision-Avoidance Assist disabled



When the front windshield where the front view camera is located or the sensor is covered with foreign, such as snow or rain, it can reduce the detecting performance and temporarily limit or disable Forward Collision-Avoidance Assist.

If this occurs the 'Forward Safety system disabled. Camera obscured' warning message, and the  and  warning lights will illuminate on the cluster.

The system will operate properly when such snow, rain or foreign material is removed.

If the system does not operate properly after obstruction (snow, rain, or foreign material) is removed, have the vehicle inspected by an authorized HYUNDAI dealer.

### WARNING

- Even though the warning message or warning light does not appear on the cluster, Forward Collision-Avoidance Assist may not properly operate.
- Forward Collision-Avoidance Assist may not properly operate in an area (for example, open terrain), where any objects are not detected after turning ON the engine.

### ***Limitations of Forward Collision-Avoidance Assist***

Forward Collision-Avoidance Assist may not operate properly, OR the function may operate unexpectedly under the following circumstances:

- The detecting sensor or the surroundings are contaminated or damaged
- The temperature around the frontview camera is high or low due to surrounding environment
- The camera lens is contaminated due to tinted, filmed or coated windshield, damaged glass, or sticky foreign material (sticker, bug, etc.) on the glass
- Moisture is not removed or frozen on the windshield
- Washer fluid is continuously sprayed, or the wiper is on
- Driving in heavy rain or snow, or thick fog
- The field of view of the front view camera is obstructed by sun glare
- Street light or light from an oncoming traffic is reflected on the wet road surface, such as a puddle on the road
- An object is placed on the dashboard
- Your vehicle is being towed
- The surrounding is very bright
- The surrounding is very dark, such as in a tunnel, etc.
- The brightness changes suddenly, for example when entering or exiting a tunnel
- The brightness outside is low, and the headlights are not on or are not bright
- Driving through steam, smoke or shadow
- Only part of the vehicle, powered two wheeler, pedestrian or cyclist is detected
- The vehicle in front is a bus, heavy truck, truck with an unusually shaped cargo, trailer, etc.
- The vehicle in front has no tail lights, tail lights are located unusually, etc.
- The brightness outside is low, and the tail lamps are not on or are not bright
- The rear of the front vehicle is small or the vehicle does not look normal, such as when the vehicle is tilted, overturned, or the side of the vehicle is visible, etc.
- The front vehicle's ground clearance is low or high
- A vehicle, powered-two wheeler, pedestrian or cyclist suddenly cuts in front
- The vehicle in front is detected late
- The vehicle in front is suddenly blocked by an obstacle
- The vehicle in front suddenly changes lane or suddenly reduces speed
- The vehicle in front is bent out of shape
- The front vehicle's speed is fast or slow
- The vehicle in front steers in the opposite direction of your vehicle to avoid a collision
- With a vehicle in front, your vehicle changes lane at low speed
- The vehicle in front is covered with snow

- You are departing or returning to the lane
- Unstable driving
- You are on a roundabout and the vehicle in front is not detected
- You are continuously driving in a circle
- The vehicle in front has an unusual shape
- The vehicle in front is driving uphill or downhill
- The pedestrian or cyclist is not fully detected, for example, if the pedestrian is leaning over or is not fully walking upright
- The pedestrian or cyclist is wearing clothing or equipment that makes it difficult to detect as a pedestrian or cyclist



The illustration above shows the image the front view camera is capable of detecting as a vehicle, powered two wheeler, pedestrian and cyclist.

- The pedestrian or cyclist in front is moving very quickly
- The pedestrian or cyclist in front is short or is posing a low posture
- The pedestrian or cyclist in front has impaired mobility
- The pedestrian or cyclist in front is moving intersected with the driving direction
- There is a group of pedestrians, cyclists or a large crowd in front
- The pedestrian or cyclist is wearing clothing that easily blends into the background, making it difficult to detect
- The pedestrian or cyclist is difficult to distinguish from the similarly shaped structure in the surroundings
- You are driving by a pedestrian, cyclist, traffic signs, structures, etc., near the intersection
- Driving in a parking lot
- Driving through a tollgate, construction area, unpaved road, partial paved road, uneven road, speed bumps, etc.
- Driving on an incline road, curved road, etc.
- Driving through a roadside with trees or streetlights
- The adverse road conditions cause excessive vehicle vibrations while driving
- Your vehicle height is low or high due to heavy loads, abnormal tire pressure, etc.
- Driving through a narrow road where trees or grass or overgrown
- There is interference by electromagnetic waves such as driving in an area with strong radio waves or electrical noise
- The vehicle is installed with a snow chain, spare tire or different size wheel.

 **WARNING**

- Driving on a curved road

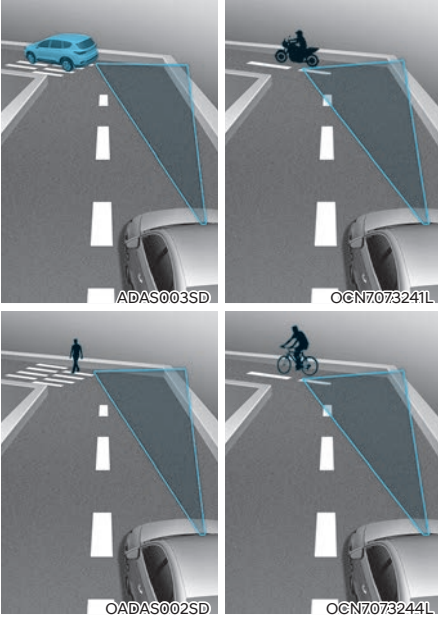

Forward Collision-Avoidance Assist may not detect other vehicles, powered two-wheeler, pedestrians or cyclists in front of you when driving on curved roads adversely affecting the performance of the sensors. This may result in no warning or braking assist when necessary.

When driving on a curved road, you must maintain a safe braking distance, and if necessary, steer the vehicle and depress the brake pedal to reduce your driving speed in order to maintain a safe distance.

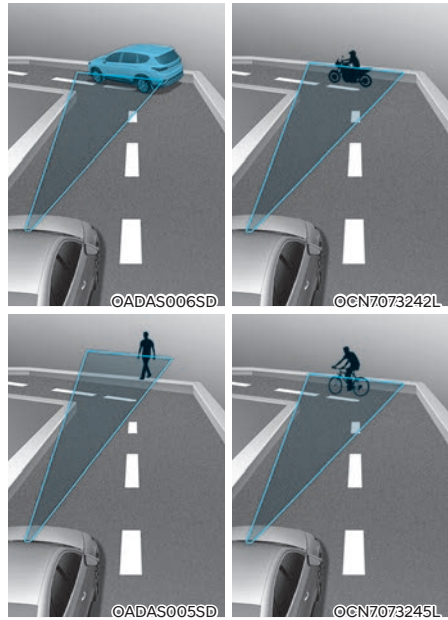

Forward Collision-Avoidance Assist may detect a vehicle, powered two-wheeler, pedestrian or a cyclist in the next lane or outside the lane when driving on a curved road.

If this occurs, the system may unnecessarily warn the driver and control the brake. Always check the traffic conditions around the vehicle.

- Driving on an inclined road

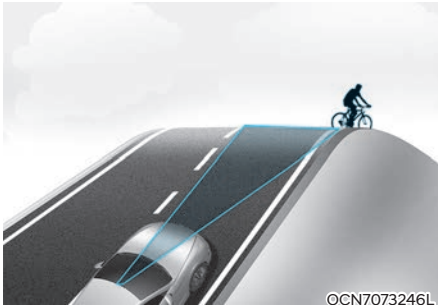
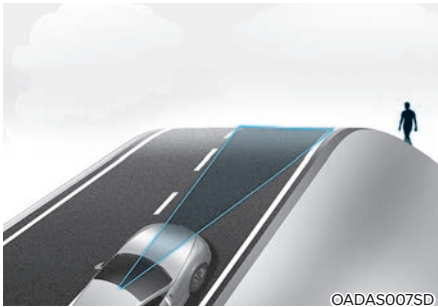
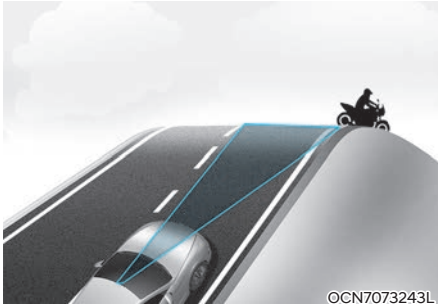
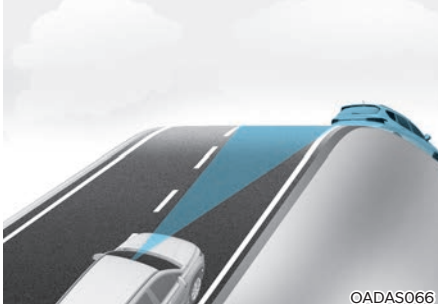

Forward Collision-Avoidance Assist may not detect a vehicle, a powered two-wheeler, a pedestrian or a cyclist in front of you while driving uphill or downhill, adversely affecting the performance of the sensors.

This may result in unnecessary warning or braking assist, or no warning or braking assist when necessary.

Also, vehicle speed may rapidly decrease when a vehicle, powered two-wheeler, and pedestrian or cyclist ahead is suddenly detected.

Always have your eyes on the road while driving uphill or downhill and if necessary, steer the vehicle and depress the brake pedal to reduce your driving speed in order to maintain a safe distance.

- Changing lanes

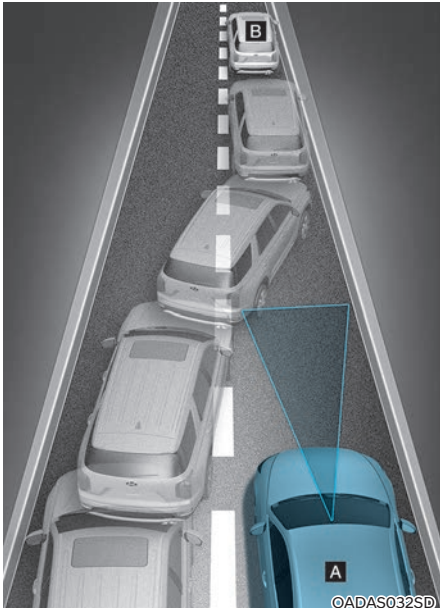

[A] : Your vehicle,  
[B] : Lane changing vehicle

**When a vehicle moves into your lane from an adjacent lane, it cannot be detected by the sensor until it is in the sensor's detection range. Forward Collision-Avoidance Assist may not immediately detect the vehicle when the vehicle changes lanes abruptly. In this case, you must maintain a safe braking distance, and if necessary, steer the vehicle and depress the brake pedal to reduce your driving speed in order to maintain a safe distance.**

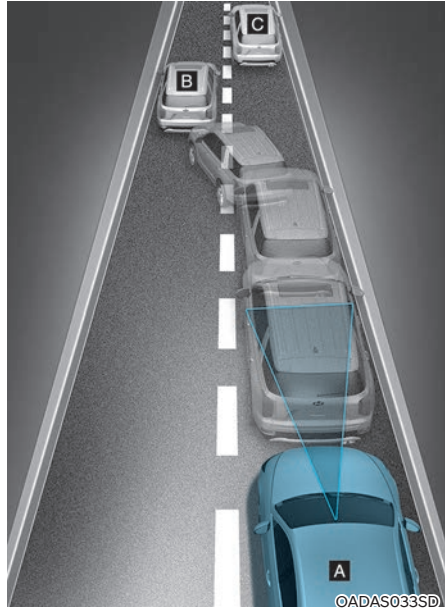

[A] : Your vehicle,  
[B] : Lane changing vehicle,  
[C] : Same lane vehicle

**When a vehicle in front of you merges out of the lane, Forward Collision-Avoidance Assist may not immediately detect the vehicle that is now in front of you.**

**In this case, you must maintain a safe braking distance, and if necessary, steer the vehicle and depress the brake pedal to reduce your driving speed in order to maintain a safe distance.**

- Detecting vehicle

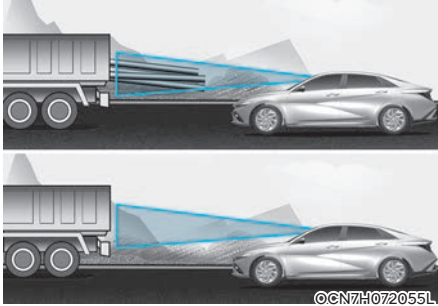

If the vehicle in front of you has cargo that extends rearward from the cab, or when the vehicle in front of you has higher ground clearance, additional special attention is required. Forward Collision-Avoidance Assist may not be able to detect the cargo extending from the vehicle. In these instances, you must maintain a safe braking distance from the rearmost object, and if necessary, steer the vehicle and depress the brake pedal to reduce your driving speed in order to maintain distance.

### WARNING

- When you are towing a trailer or another vehicle, turn off Forward Collision-Avoidance Assist for safety reasons.
- Forward Collision-Avoidance Assist may operate if objects that are similar in shape or characteristics to vehicles and pedestrians are detected.
- Forward Collision-Avoidance Assist does not operate on bicycles, motorcycles, or smaller wheeled objects, such as luggage bags, shopping carts, or strollers.

- Forward Collision-Avoidance Assist may not operate properly if interfered by strong electromagnetic waves.
- Forward Collision-Avoidance Assist may not operate for 15 seconds after the vehicle is started, or the front view camera is initialized.

### Information

This device complies with Part 15 of the FCC rules.

Operation is subject to the following three conditions:

1. This device may not cause harmful interference, and
2. This device must accept any interference received, including interference that may cause undesired operation.
3. Changes or modifications not expressly approved by the party responsible for compliance could void the user's authority to operate the device.

### Information

Radio frequency radiation exposure information:

This equipment complies with FCC radiation exposure limits set forth for an uncontrolled environment.

This equipment should be installed and operated with minimum distance of 8 in. (20 cm) between the radiator (antenna) and your body.

This transmitter must not be co-located or operating in conjunction with any other antenna or transmitter.

## FORWARD COLLISION-AVOIDANCE ASSIST (FCA) (SENSOR FUSION) (IF EQUIPPED)

### Basic function

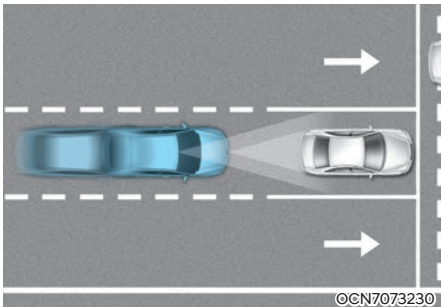

Forward Collision-Avoidance Assist helps detect a vehicle, a powered two wheeler a pedestrian, or a cyclist ahead on the road and may warn you of a possible collision with a warning message on the instrument cluster and a warning sound. Also, Forward Collision-Avoidance Assist may assist with braking your vehicle to help reduce collision speed or avoid a collision.

### Direct Oncoming function

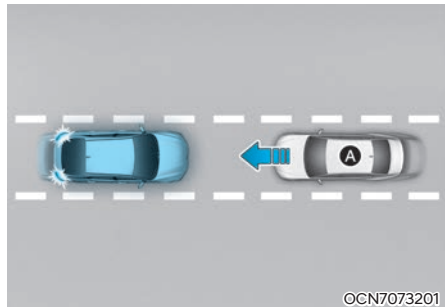

[A]: Oncoming vehicle

Direct Oncoming function helps reduce the speed at the collision when a vehicle approaching from the opposite side is detected.

### Junction Turning function (if equipped)

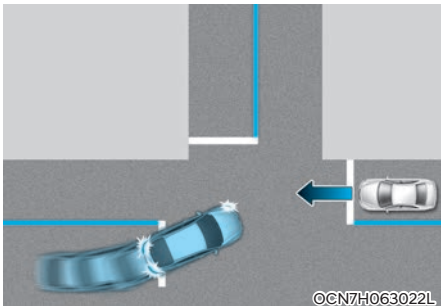

Junction Turning function can help avoid a collision with an oncoming vehicle in an adjacent lane when turning left at a crossroad with the turn signal on by applying emergency braking.

## Detecting sensor



[1] : Front view camera,

[2] : Front radar

Refer to the picture above for the detailed location of the detecting sensors.



### CAUTION

Take the following precautions to maintain optimal performance of the detecting sensor:

- Never disassemble the detecting sensor or sensor assembly, or cause any damage to it.
- If the detecting sensors have been replaced or repaired, have the vehicle by an authorized HYUNDAI dealer.
- Never install any accessories or stickers on the front windshield, or tint the front windshield.

- Exercise extreme caution to keep the front view camera dry.
- Never place any reflective objects (for example, white paper, mirror) over the dashboard.
- Do not place objects near the windshield or install structures, etc. Operation of the air conditioning unit may result in poor moisture and defrosting, which may prevent the driver assistance system from operating.
- Do not apply license plate frame or objects, such as a bumper sticker, film or a bumper guard, near the front radar cover.
- Always keep the front radar and cover clean and free of dirt and debris.

Use only a soft cloth to wash the vehicle. Do not spray pressurized water directly on the sensor or sensor cover.

- If the radar or around the radar has been damaged or impacted in any way, Forward Collision-Avoidance Assist may not properly operate even though a warning message does not appear on the cluster. Have the vehicle inspected by an authorized HYUNDAI dealer.
- Use only genuine parts to repair or replace a damaged front radar cover. Do not apply paint to the front radar cover.

## Forward Collision-Avoidance Assist Settings

### Forward Safety

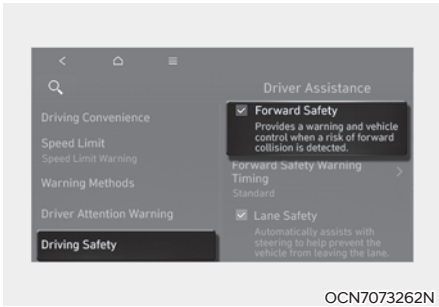

With the ignition switch ON, go to **User Settings > Driver Assistance > Driving Safety** from the settings menu in the instrument cluster or **Setup > Vehicle > Driver Assistance > Driving Safety** from the settings menu in the infotainment system to select the following:

- If **Forward Safety** is selected, Forward Collision-Avoidance Assist will warn the driver with a warning message, an audible warning depending on the collision risk levels. Braking assist will be applied depending on the collision risk levels. If Forward Safety is deselected, Forward Safety will turn off. The warning light (🚨) will illuminate on the cluster.

### WARNING

Each time the engine is restarted, Forward Collision-Avoidance Assist turns on.

If Forward Safety is selected after the engine is restarted, the function does NOT brake your vehicle to help avoid a collision.

## Forward Safety Warning Timing

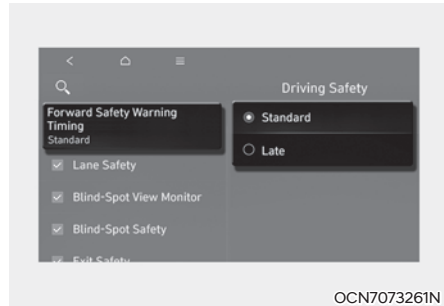

With the engine on, select **User Settings > Driver Assistance > Driving Safety > Forward Safety Warning Timing** from the settings menu in the instrument cluster or **Setup > Vehicle > Driver Assistance > Driving Safety > Forward Safety Warning Timing** settings menu in the infotainment system to change the initial warning activation time for Forward Collision-Avoidance Assist. The warning time can be set to either Normal or Late.

- Use **Standard** in normal driving conditions. If the Warning Timing seems sensitive, change it to "Late".
- If **Late** is selected, Forward Collision-Avoidance Assist, warns the driver more slowly.

### CAUTION

- Even though "Standard" is selected for Warning Timing, if the front vehicle suddenly stops, the warning may seem late.
- Select "Late" for Warning Timing when traffic is light and when driving speed is slow.

### Information

If the engine is restarted, Warning Timing will maintain the last setting.

## Warning Methods

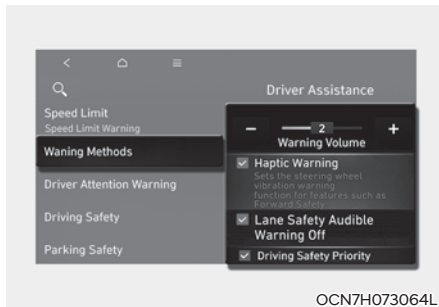

The Warning Methods can be set with the vehicle on. Select **User Settings > Driver Assistance > Warning Methods** from the settings menu in the instrument cluster or **Setup > Vehicle > Driver Assistance > Warning Methods** from the settings menu in the infotainment system to change the following settings:

- **Warning Volume:** Adjusts the volume of the warning sound. If you turn off the **Warning Volume**, for your safety, the function may warn you with a low volume.
- **Haptic Warning:** Activate the steering wheel vibration warning.
- **Driving Safety Priority:** Lowers all other audio volumes when the Driving Safety system sounds a warning.

### **i** Information

- If you change the Warning Methods, the Warning Methods of other Driver Assistance systems may change.
- The Warning Volume and Haptic Warning cannot be turned off at the same time. When one of the warning is turned off the other is activated.
- If the engine is restarted, Warning Methods will maintain the last setting.
- The setting menu may not exist based on vehicle specification.

## Forward Collision-Avoidance Assist Operation

### Basic function

The basic function for Forward Collision-Avoidance Assist is to warn and help control the vehicle depending on the collision risk level: 'Collision Warning', 'Emergency Braking' and 'Stopping vehicle and ending brake control'.

### Collision Warning



- To warn the driver of a collision, the 'Collision Warning' warning message will appear on the cluster and an audible warning will sound and the steering wheel will vibrate.
- If a vehicle is detected in front, the system will operate when your vehicle speed is approximately 6-112 mph (10-180 km/h).
- If a pedestrian or cyclist is detected in front, the system will operate when your vehicle speed is approximately 6-53 mph (10-85 km/h).

**Emergency Braking**

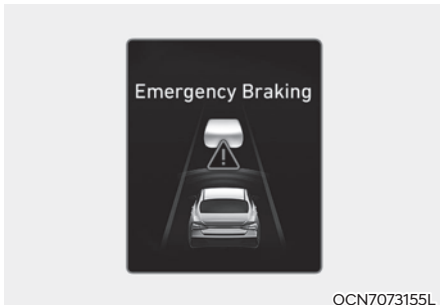

To warn the driver that emergency braking will be assisted, the ‘Emergency Braking’ warning message will appear on the cluster and an audible warning will sound and the steering wheel will vibrate.

Emergency braking will operate under the following conditions.

- Vehicle or powered two-wheeler:

	Driving vehicle	Stopped vehicle
Weak braking power	Approximately 6-125 mph (10-200 km/h)	
Strong braking power	Approximately 6-81 mph (10-130 km/h)	Approximately 6-47 mph (10-75 km/h)

- Pedestrian or cyclist:  
The function will operate when your vehicle speed is approximately 6-40 mph (10~65 km/h)

**Stopping vehicle and ending brake control**



- When the vehicle is stopped due to emergency braking, the ‘Drive carefully’ warning message will appear on the cluster.  
For your safety, the driver should depress the brake pedal immediately and check the surroundings.
- Brake control will end after the vehicle is stopped by emergency braking for approximately 2 seconds.

### ***Junction Turning function (if equipped)***

Junction Turning function will warn and help control the vehicle depending on the collision risk level : 'Collision Warning', 'Emergency Braking' and 'Stopping vehicle and ending brake control'

#### **Collision Warning**



OCN7073157L

- To warn the driver of a collision, the 'Collision Warning' warning message will appear on the cluster and an audible warning will sound and the steering wheel will vibrate.
- The function will operate when your vehicle speed is approximately 6-19 mph (10-30 km/h) and the oncoming vehicle speed is approximately 19-44 mph (30-70 km/h).

#### **Emergency Braking**

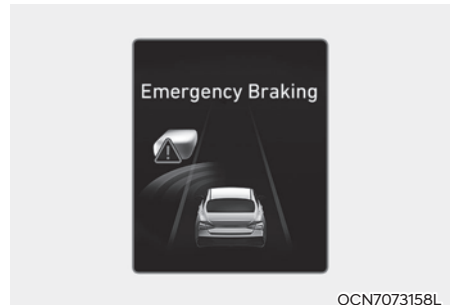

OCN7073158L

- To warn the driver that emergency braking will be assisted, the 'Emergency Braking' warning message will appear on the cluster and an audible warning will sound and the steering wheel will vibrate.
- The system will operate when your vehicle speed is approximately 6-19 mph (10-30 km/h) and the oncoming vehicle speed is approximately 19-44 mph (30-70 km/h).
- In emergency braking situation, braking is assisted with strong braking power by the system to help prevent collision with the oncoming vehicle.

### Stopping vehicle and ending brake control



- When the vehicle is stopped due to emergency braking, the 'Drive carefully' warning message will appear on the cluster.  
For your safety, the driver should depress the brake pedal immediately and check the surroundings.
- Brake control will end after the vehicle is stopped by emergency braking for approximately 2 seconds.

### Direct Oncoming function

Direct Oncoming function will warn and control the vehicle depending on the collision risk level: 'Collision Warning', 'Emergency Braking' and 'Stopping vehicle and ending brake control'.

#### Collision Warning



To warn the driver of a collision, Forward Safety warning light (🚗) blinking, the 'Collision warning!' warning message will appear on the instrument cluster, an audible warning will sound and the steering wheel will vibrate.

The function will operate when your vehicle speed is between about 19-80 mph (30-130 km/h) and the detected oncoming vehicle speed is about above 6 mph (10 km/h) and the oncoming vehicle speed is about above 6 mph (10 km/h).

## Emergency Braking

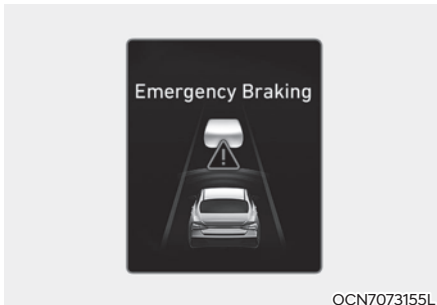

To warn the driver that emergency braking will be assisted, Forward Safety warning light (🚨) blinking, the 'Emergency braking' warning message will appear on the instrument cluster, an audible warning will sound and the steering wheel will vibrate.

In emergency braking situation, braking is assisted with strong braking power by the function to help prevent collision with the oncoming vehicle.

The function will operate when your vehicle speed is between about 19-80 mph (30-130 km/h) and the detected oncoming vehicle speed is about above 6 mph (10 km/h).

## Stopping vehicle and ending brake control

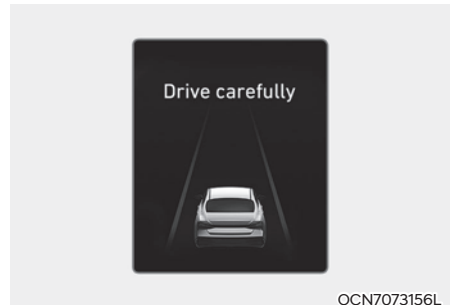

When the vehicle is stopped due to emergency braking, the 'Drive carefully' warning message will appear on the instrument cluster. For your safety, the driver should depress the brake pedal immediately and check the surroundings.

Brake control will end after the vehicle is stopped by emergency braking for about 2 seconds.



### CAUTION

**If your vehicle or the oncoming vehicle is not driving straight, Direct Oncoming function warning and control may be late or may not operate.**



### Information

**Press the hazard warning flasher to turn off the audible warning of the collision warning or emergency braking system.**



## WARNING

Take the following precautions when using Forward Collision-Avoidance Assist:

- For your safety, only change the Settings after parking the vehicle at a safe location.
- With 'Active Assist' or 'Warning Only' selected, when ESC is turned off by pressing and holding the ESC OFF button, Forward Collision-Avoidance Assist will turn off automatically. In this case, the function cannot be set from the Settings menu and the  warning light will illuminate on the cluster which is normal. If ESC is turned on by pressing the ESC OFF button, Forward Collision-Avoidance Assist will maintain the last setting.
- Forward Collision-Avoidance Assist does not operate in all situations and cannot avoid all collisions.
- The driver has the responsibility to control the vehicle. Do not solely depend on Forward Collision-Avoidance Assist. Rather, maintain a safe braking distance, and if necessary, depress the brake pedal to reduce driving speed or to stop the vehicle.
- Never deliberately operate Forward Collision-Avoidance Assist on people, objects, etc. It may cause serious injury or death.
- Forward Collision-Avoidance Assist may not operate if the driver depresses the brake pedal to avoid a collision.

- Depending on the road and driving conditions, Forward Collision-Avoidance Assist may warn the driver late or may not warn the driver.
- During Forward Collision-Avoidance Assist operation, the vehicle may stop suddenly injuring passengers and shifting loose objects. Always have the seat belt on and keep loose objects secured.
- If any other function's warning message is displayed or audible warning is generated, Forward Collision-Avoidance Assist warning message may not be displayed and audible warning may not be generated.
- You may not hear the warning sound of Forward Collision-Avoidance Assist if the surrounding is noisy.
- Forward Collision-Avoidance Assist may turn off or may not operate properly or may operate unnecessarily depending on the road conditions and the surroundings.



## WARNING

- Even if there is a problem with Forward Collision-Avoidance Assist, the vehicle's basic braking will function normally.
- During emergency braking, braking control by the function will automatically cancel when the driver excessively depresses the accelerator pedal or sharply steers the vehicle.



## CAUTION

- Depending on the condition of the vehicle, powered two-wheeler, pedestrian and cyclist in front and the surroundings, the speed range to operate Forward Collision-Avoidance Assist may reduce. Forward Collision-Avoidance Assist may only warn the driver, or it may not operate.
- Forward Collision-Avoidance Assist will operate under certain conditions by judging the risk level based on the condition of the oncoming vehicle, driving direction, speed and surroundings.



## Information



- In a situation where collision is imminent, braking may be assisted by Forward Collision-Avoidance Assist when braking is insufficient by the driver.
- The images and colors in the instrument cluster may differ depending on the cluster type or theme selected from the instrument cluster.

## Forward Collision-Avoidance Assist Malfunction and Limitation

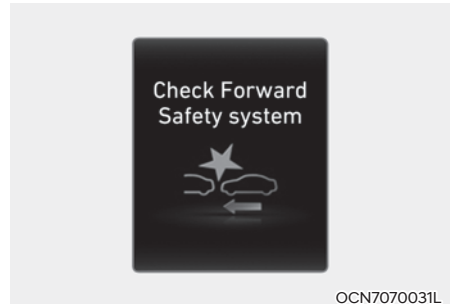
### Forward Collision-Avoidance Assist malfunction





OCN7070031L

When Forward Collision-Avoidance Assist is not working properly, the 'Check Forward Safety system' warning message will appear, and the  and  warning lights will illuminate on the cluster. Have the vehicle inspected by an authorized HYUNDAI dealer.

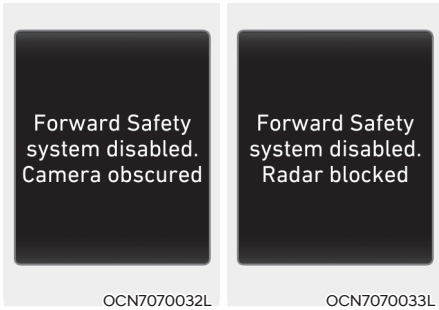
### Forward Collision-Avoidance Assist disabled



When the front windshield where the front view camera is located, front radar cover or sensor is covered with foreign material, such as snow or rain, it can reduce the detecting performance and temporarily limit or disable Forward Collision-Avoidance Assist.

If this occurs the 'Forward Safety system disabled. Camera obscured' or the 'Forward Safety system disabled. Radar blocked' warning message, and the  and  warning lights will illuminate on the cluster.

The function will operate properly when such snow, rain or foreign material is removed.

If the function does not operate properly after obstruction (snow, rain, or foreign material) is removed, have the vehicle inspected by an authorized HYUNDAI dealer.

### WARNING

- Even though the warning message or warning light does not appear on the cluster, Forward Collision-Avoidance Assist may not properly operate.
- Forward Collision-Avoidance Assist may not properly operate in an area (for example, open terrain), where any objects are not detected after turning ON the engine.

### Limitations of Forward Collision-Avoidance Assist

Forward Collision-Avoidance Assist may not operate properly, or the function may operate unexpectedly under the following circumstances:

- The detecting sensor or the surroundings are contaminated or damaged
- The temperature around the frontview camera is high or low due to surrounding environment
- The camera lens is contaminated due to tinted, filmed or coated windshield, damaged glass, or sticky foreign material (sticker, bug, etc.) on the glass
- Moisture is not removed or frozen on the windshield
- Washer fluid is continuously sprayed, or the wiper is on
- Driving in heavy rain or snow, or thick fog
- The field of view of the front view camera is obstructed by sun glare
- Street light or light from an oncoming traffic is reflected on the wet road surface, such as a puddle on the road
- An object is placed on the dashboard

- Your vehicle is being towed
- The surrounding is very bright
- The surrounding is very dark, such as in a tunnel, etc.
- The brightness changes suddenly, for example when entering or exiting a tunnel
- The brightness outside is low, and the headlights are not on or are not bright
- Driving through steam, smoke or shadow
- Only part of the vehicle, powered two wheeler, pedestrian or cyclist is detected
- The vehicle in front is a bus, heavy truck, truck with an unusually shaped cargo, trailer, etc.
- The vehicle in front has no tail lights, tail lights are located unusually, etc.
- The brightness outside is low, and the tail lamps are not on or are not bright
- The rear of the front vehicle is small or the vehicle does not look normal, such as when the vehicle is tilted, overturned, or the side of the vehicle is visible, etc.
- The front vehicle's ground clearance is low or high
- A vehicle, powered-two wheeler, pedestrian or cyclist suddenly cuts in front
- The bumper around the front radar is impacted, damaged or the front radar is out of position
- The temperature around the frontview camera is high or low due to surrounding environment
- Driving through a tunnel or iron bridge
- Driving in large areas where there are few vehicles or structures (for example, desert, meadow, suburb, etc.)
- Driving near areas containing metal substances, such as a construction zone, railroad, etc.
- A material is near that reflects very well on the front radar, such as a guardrail, nearby vehicle, etc.
- The cyclist in front is on a bicycle made of material that does not reflect on the front radar
- The vehicle in front is detected late
- The vehicle in front is suddenly blocked by an obstacle
- The vehicle in front suddenly changes lane or suddenly reduces speed
- The vehicle in front is bent out of shape
- The front vehicle's speed is fast or slow
- The vehicle in front steers in the opposite direction of your vehicle to avoid a collision
- With a vehicle in front, your vehicle changes lane at low speed
- The vehicle in front is covered with snow
- You are departing or returning to the lane
- Unstable driving
- You are on a roundabout and the vehicle in front is not detected
- You are continuously driving in a circle
- The vehicle in front has an unusual shape
- The vehicle in front is driving uphill or downhill

- The pedestrian or cyclist is not fully detected, for example, if the pedestrian is leaning over or is not fully walking upright
- The pedestrian or cyclist is wearing clothing or equipment that makes it difficult to detect



The illustration above shows the image the front view camera is capable of detecting as a vehicle, powered two wheeler, pedestrian and cyclist.

- The pedestrian or cyclist in front is moving very quickly
- The pedestrian or cyclist in front is short or is posing a low posture
- The pedestrian or cyclist in front has impaired mobility
- The pedestrian or cyclist in front is moving intersected with the driving direction
- There is a group of pedestrians, cyclists or a large crowd in front
- The pedestrian or cyclist is wearing clothing that easily blends into the background, making it difficult to detect
- The pedestrian or cyclist is difficult to distinguish from the similarly shaped structure in the surroundings
- You are driving by a pedestrian, cyclist, traffic sign, structure, etc., near the intersection
- Driving in a parking lot
- Driving through a tollgate, construction area, unpaved road, partial paved road, uneven road, speed bumps, etc.
- Driving on an incline road, curved road, etc.
- Driving through a roadside with trees or streetlights
- The adverse road conditions cause excessive vehicle vibrations while driving
- Your vehicle height is low or high due to heavy loads, abnormal tire pressure, etc.
- Driving through a narrow road where trees or grass are overgrown
- There is interference by electromagnetic waves, such as driving in an area with strong radio waves or electrical noise
- The vehicle is installed with a snow chain, spare tire or different size wheel.



## WARNING

- Driving on a curved road

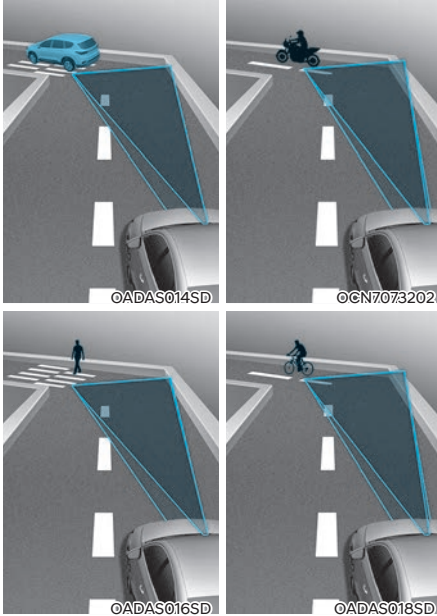

Forward Collision-Avoidance Assist may not detect other vehicles, powered two-wheelers, pedestrians or cyclists in front of you when driving on curved roads that adversely affect the performance of the sensors. This may result in no warning or braking assist when necessary.

When driving on a curved road, you must maintain a safe braking distance, and if necessary, steer the vehicle and depress the brake pedal to reduce your driving speed in order to maintain a safe distance.

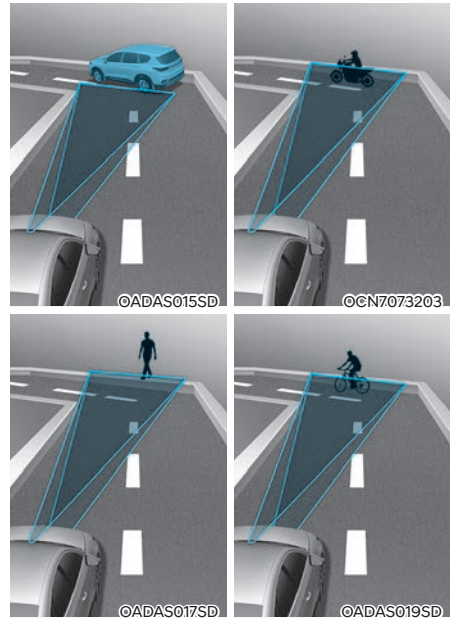

Forward Collision-Avoidance Assist may detect a vehicle, powered two-wheeler, pedestrian or cyclist in the next lane or outside the lane when driving on a curved road.

If this occurs, the system may unnecessarily warn the driver and control the brake. Always check the traffic conditions around the vehicle.

- Driving on an inclined road

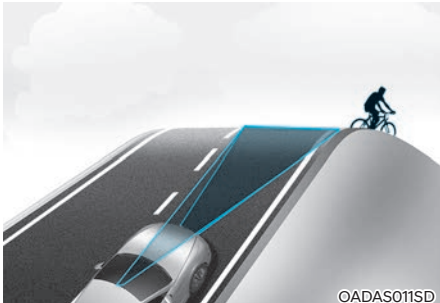
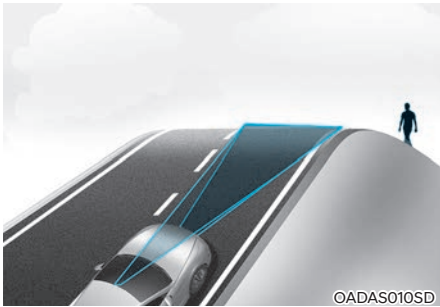
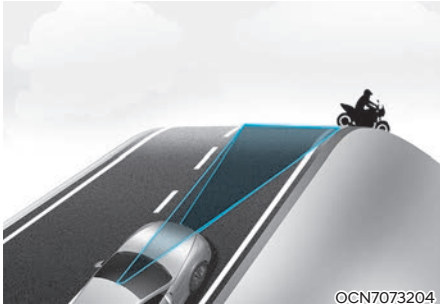
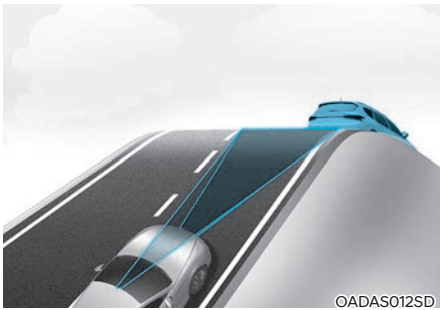

Forward Collision-Avoidance Assist may not detect other vehicles, powered two-wheelers, pedestrians or cyclists in front of you while driving uphill or downhill adversely affecting the performance of the sensors.

This may result in unnecessary warning or braking assist, or no warning or braking assist when necessary.

Also, vehicle speed may rapidly decrease when a vehicle, powered two-wheeler, pedestrian or cyclist ahead is suddenly detected.

Always have your eyes on the road while driving uphill or downhill and if necessary, steer your vehicle and depress the brake pedal to reduce your driving speed in order to maintain a safe distance.

- Changing lanes

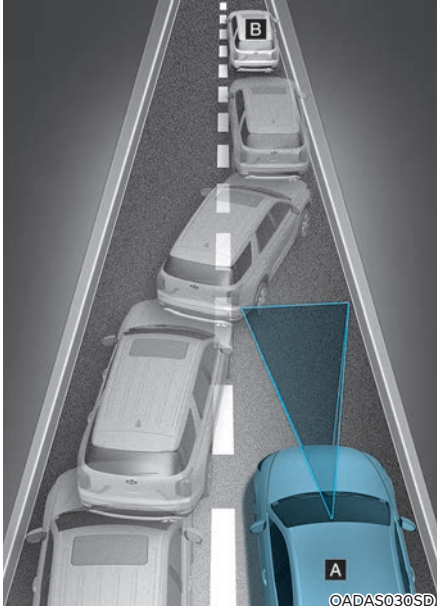

[A] : Your vehicle,  
[B] : Lane changing vehicle

**When a vehicle moves into your lane from an adjacent lane, it cannot be detected by the sensor until it is in the sensor's detection range. Forward Collision-Avoidance Assist may not immediately detect the vehicle when the vehicle changes lanes abruptly. In this case, you must maintain a safe braking distance, and if necessary, steer your vehicle and depress the brake pedal to reduce your driving speed in order to maintain a safe distance.**

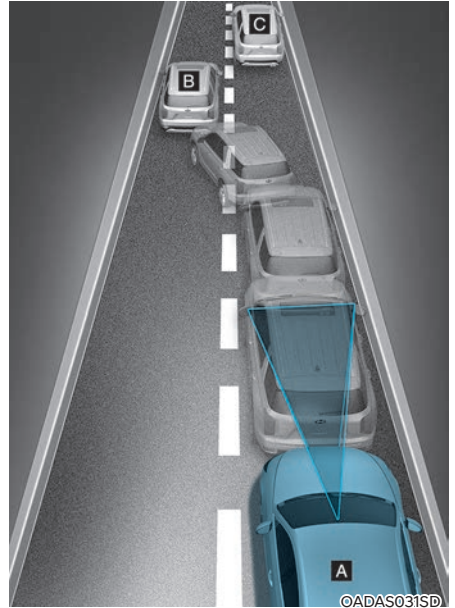

[A] : Your vehicle, [B] : Lane changing vehicle,  
[C] : Same lane vehicle

**When a vehicle in front of you merges out of the lane, Forward Collision-Avoidance Assist may not immediately detect the vehicle that is now in front of you. In this case, you must maintain a safe braking distance, and if necessary, steer your vehicle and depress the brake pedal to reduce your driving speed in order to maintain a safe distance.**

- Detecting vehicle

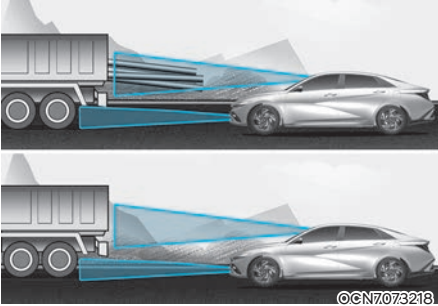

If the vehicle in front of you has cargo that extends rearward from the cab, or when the vehicle in front of you has higher ground clearance, additional special attention is required. Forward Collision-Avoidance Assist may not be able to detect the cargo extending from the vehicle. In these instances, you must maintain a safe braking distance from the rearmost object, and if necessary, steer your vehicle and depress the brake pedal to reduce your driving speed in order to maintain distance.

 **WARNING**

- When you are towing a trailer or another vehicle, have Forward Collision-Avoidance Assist turned off due to safety reasons.
- Forward Collision-Avoidance Assist may operate if objects that are similar in shape or characteristics to vehicles, powered two-wheeler, pedestrians and cyclists are detected.
- Forward Collision-Avoidance Assist does not operate on bicycles, motorcycles, or smaller wheeled objects, such as luggage bags, shopping carts, or strollers.

- Forward Collision-Avoidance Assist may not operate properly if interfered by strong electromagnetic waves.
- Forward Collision-Avoidance Assist may not operate for 15 seconds after the vehicle is started, or the front view camera is initialized.

 **Information**

This device complies with Part 15 of the FCC rules.

Operation is subject to the following three conditions:

1. This device may not cause harmful interference, and
2. This device must accept any interference received, including interference that may cause undesired operation.
3. Changes or modifications not expressly approved by the party responsible for compliance could void the user's authority to operate the device.

 **Information**

Radio frequency radiation exposure information:

This equipment complies with FCC radiation exposure limits set forth for an uncontrolled environment.

This equipment should be installed and operated with minimum distance of 8 in. (20 cm) between the radiator (antenna) and your body.

This transmitter must not be co-located or operating in conjunction with any other antenna or transmitter.

## LANE KEEPING ASSIST (LKA)

Lane Keeping Assist is designed to help detect lane markings (or road edges) while driving over a certain speed. The system will warn the driver if the vehicle leaves the lane without using the turn signal, or will automatically assist the driver's steering to help prevent the vehicle from departing the lane.

### Detecting sensor



[1] : Front view camera

The front view camera is used as a detecting sensor to detect lane markings (or road edges).

Refer to the picture above for the detailed location of the detecting sensor.



### CAUTION

For more details on the precautions of the front view camera, refer to “Forward Collision-Avoidance Assist (FCA)” section in chapter 7.

## Lane Keeping Assist Settings

### Lane Safety

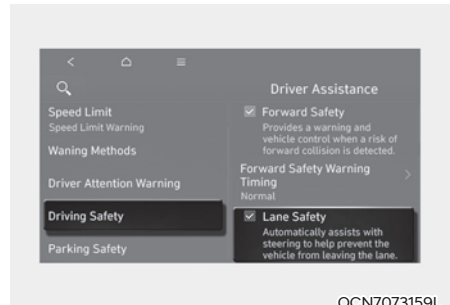

OCN7073159L

With the engine on, select **User Settings > Driver Assistance > Driving Safety > Lane Safety** from the settings menu in the instrument cluster or **Settings > Vehicle > Driver Assistance > Driving Safety > Lane Safety** from the settings menu in the infotainment system to set whether to use each function.

- If ‘Lane Keeping Assist’ is selected, the function will automatically assist the driver's steering when lane departure is detected to help prevent the vehicle from moving out of its lane.
- If ‘Lane Departure Warning’ is selected, the function will warn the driver with an audible warning and steering departure is detected. The driver must steer the vehicle.
- If ‘Off’ is selected, the function will turn off. The  indicator light will turn off on the cluster.



### WARNING

- Lane Keeping Assist does not control the steering wheel when the vehicle is driven in the middle of the lane.
- The driver should always be aware of the surroundings. If Lane Safety is deselected, Lane Keeping assist cannot assist you.

### Warning Methods

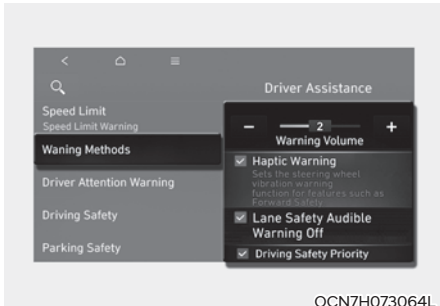

The Warning Methods can be set with the vehicle on. Select **User Settings > Driver Assistance > Warning Methods** from the settings menu in the instrument cluster or **Setup > Vehicle > Driver Assistance > Warning Methods** from the settings menu in the infotainment system to change the following settings:

- **Warning Volume:** Adjusts the volume of the warning sound.
- **Haptic Warning:** Activate the steering wheel vibration warning.
- **Lane Safety Audible Warning Off:** Turns off the Lane Safety Audible Warning, even when both warning volume and haptic warning are on.
- **Driving Safety Priority:** Lowers all other audio volumes when the Driving Safety system sounds a warning.

### **i** Information

- If you change the Warning Methods, the Warning Methods of other Driver Assistance systems may change.
- The Warning Volume and Haptic Warning cannot be turned off at the same time. When one of the warning is turned off the other is activated.
- If the engine is restarted, Warning Methods will maintain the last setting.
- The setting menu may not exist based on vehicle specification.

### Lane Keeping Assist Operation Turning Lane Keeping Assist On/Off

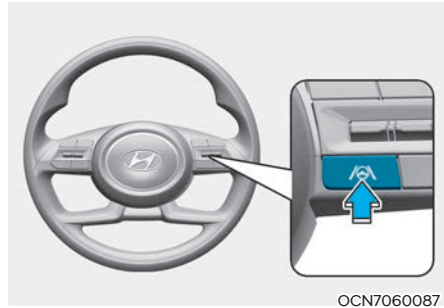

With the engine ON, press and hold the Driving Assist button located on the steering wheel to turn on and off. The grey or green  indicator light illuminates on the instrument cluster when the function is on.

Press and hold the button again to turn off the function.

### **i** Information

- When the engine is restarted, Lane Keeping Assist maintains its last setting.
- When Lane Keeping Assist is turned off by pressing the Lane Driving Assist button, the Lane Safety setting is changed to Off.

### Warning and control

Lane Keeping Assist will warn and help control the vehicle with Lane Departure Warning and Lane Keeping Assist.

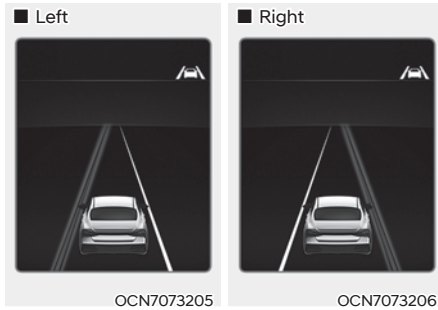

### Lane Departure Warning

- To warn the driver that the vehicle is departing from the projected lane in front, the green  indicator light will blink on the cluster, the lane line will blink on the cluster depending on which direction the vehicle is veering, and an audible warning will sound and the steering wheel will vibrate.
- The system will operate when your vehicle speed is approximately 40-120 mph (60-200 km/h).

### Lane Keeping Assist

- To warn the driver that the vehicle is departing from the projected lane in front, the green  indicator light will blink on the cluster, and the steering wheel will make adjustments to help keep the vehicle inside the lane.
- The function will operate when your vehicle speed is approximately 40-120 mph (60-200 km/h).

### Hands-off warning



If the driver takes their hands off the steering wheel for several seconds, the 'Place hands on the steering wheel' warning message will appear on the cluster, and an audible warning will sound in stages.



### WARNING

- The steering wheel may not be assisted if the steering wheel is held very tight or the steering wheel is steered over a certain degree.
- Lane Keeping Assist does not operate at all times. It is the responsibility of the driver to safely steer the vehicle and to maintain the vehicle in its lane.
- The hands-off warning message may appear late depending on road conditions. Always have your hands on the steering wheel while driving.
- If the steering wheel is held very lightly, the hands-off warning message may appear because the system may not recognize that the driver has their hands on the steering wheel.
- If you attach objects to the steering wheel, the hands-off warning may not work properly.



### Information

- For more details on setting the functions in the infotainment system, refer to “Vehicle Settings” section in chapter 4.
- When lane markings (or road edges) are detected, the lane lines on the cluster will change from grey to white and the green  indicator light will illuminate.

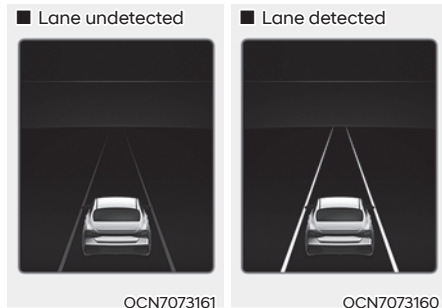

- Even though the steering is assisted by Lane Keeping Assist, the driver may control the steering wheel.
- The steering wheel may feel heavier or lighter when the steering wheel is assisted by Lane Keeping Assist than when it is not.
- The images and colors in the instrument cluster may differ depending on the cluster type or theme selected from the instrument cluster.

## Lane Keeping Assist Malfunction and Limitations

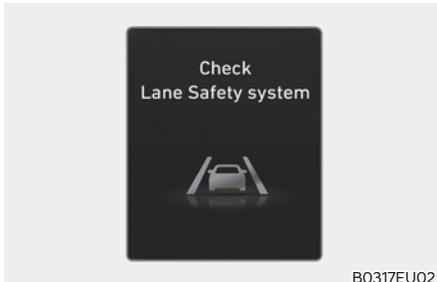

### Lane Keeping Assist malfunction



When Lane Keeping Assist is not working properly, the 'Check Lane Keeping Assist (LKA) system' warning message will appear and the yellow  indicator light will illuminate on the cluster. If this occurs, have the vehicle inspected by an authorized HYUNDAI dealer.

### Lane Keeping Assist disabled



When the front windshield where the front view camera is located, sensor is covered with foreign material, such as snow or rain, it can reduce the detecting performance and temporarily limit or disable Lane Keeping Assist. If this occurs, the 'Lane Safety system disabled. Camera obscured' warning message and the  and  warning light appears on the instrument cluster. Lane Keeping Assist operates properly when snow, rain or foreign matter is removed. If Lane Keeping Assist does not operate properly after it is removed, have the vehicle inspected by an authorized HYUNDAI dealer.

### WARNING

- **Even though the warning message or warning light does not appear on the instrument cluster, Lane Keeping Assist may not properly operate.**
- **If the vehicle is turned off and restarted while the camera is blocked or malfunctioned, the condition is maintained. Therefore, Lane Keeping Assist may not operate properly.**

### **Limitations of Lane Keeping Assist**

Lane Keeping Assist may not operate properly or may operate unexpectedly under the following circumstances:

- The lane is contaminated or difficult to detect because:
  - The lane markings (or road edges) are covered with rain, snow, dirt, oil, etc.
  - The color of the lane marking (or road edges) is not distinguishable from the road
  - There are markings (or road edges) on the road near the lane or the markings (or road edges) on the road look similar to the lane markings (or road edges)
  - The lane marking (or road edges) is indistinct or damaged
  - The shadow is on the lane marking (or road edges) by a median strip, trees, guardrail, noise barriers, etc.
- There are more than two lane markings (or road edges) on the road
- The lane number increases or decreases, or the lane markings (or road edges) are crossing
- The lane markings (or road edges) are complicated or a structure substitutes for the lines, such as a construction area
- There are road markings, such as zigzag lanes, crosswalk markings and road signs
- The lane suddenly disappears, such as at the intersection
- The lane (or road width) is very wide or narrow
- The number of lanes change or the lanes merge
- The distance to the front vehicle is extremely short or the vehicle in front is covering the lane marking

### **Information**

For more details on the limitations of the front view camera, refer to “Forward Collision-Avoidance Assist (FCA)” section in chapter 7.

### **WARNING**

Take the following precautions when using Lane Keeping Assist:

- The driver has the responsibility to safely drive and control the vehicle. Do not solely rely on the system and drive dangerously.
- The operation of Lane Keeping Assist can be canceled or not work properly depending on road conditions and surroundings. Always be cautious while driving.
- Refer to “Limitations of the System” if the lane is not detected properly.
- When you are towing a trailer or another vehicle, have Lane Keeping Assist turned off due to safety reasons.
- If the vehicle is driven at high speed, the steering wheel will not be controlled. The driver must always follow the speed limit when using the system.
- If any other system’s warning message is displayed or audible warning is generated, Lane Keeping Assist warning message may not be displayed and audible warning may not be generated.
- You may not hear the warning sound of Lane Keeping Assist if the surrounding is noisy.
- If you attach objects to the steering wheel, steering may not be assisted properly.
- Lane Keeping Assist may not operate for 15 seconds after the vehicle is started, or the front view camera is initialized.

- **Lane Keeping Assist will not operate when:**
  - **The turn signal or hazard warning flasher is turned on**
  - **The vehicle is not driven in the center of the lane when the system is turned on or right after changing a lane**
  - **ESC (Electronic Stability Control) or VSM (Vehicle Stability Management) is activated**
  - **The vehicle is driven on a sharp curve**
  - **Vehicle speed is below 35 mph (55 km/h) or above 130 mph (210 km/h)**
  - **The vehicle makes sudden lane changes**
  - **The vehicle brakes suddenly**
- **Loading in excess of the maximum load allowance or concentrated loading at one point in the cargo compartment can reduce the vehicle's driving stability, which can in turn reduce the effectiveness of Lane Keeping Assist.**

## BLIND-SPOT COLLISION-AVOIDANCE ASSIST (BCA) (IF EQUIPPED)

Blind-Spot Collision-Avoidance Assist helps detect approaching vehicles in the driver's blind spot areas and warn you of a possible collision with a warning light and a warning sound.

If there is a collision risk when exiting a parallel space, Blind-Spot Collision-Avoidance Assist may assist with braking your vehicle to help avoid a collision.

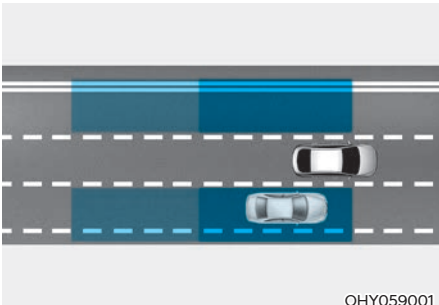

Blind-Spot Collision-Avoidance Assist helps detect and inform the driver that a vehicle is in the blind spot.

### CAUTION

The detecting range may vary depending on the speed of your vehicle. However, even if there is a vehicle in the blind spot area, the function may not warn you when you pass by at high speeds.

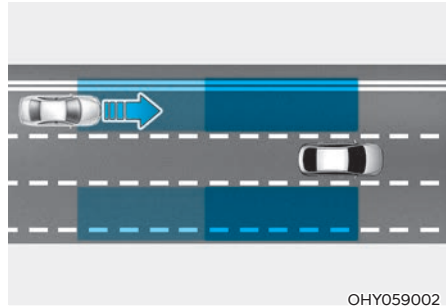

Blind-Spot Collision-Avoidance Assist helps detect and informs the driver that a vehicle is approaching at high speed from the blind spot area.

### CAUTION

Warning timing may vary depending on the speed of the vehicle approaching at high speed.

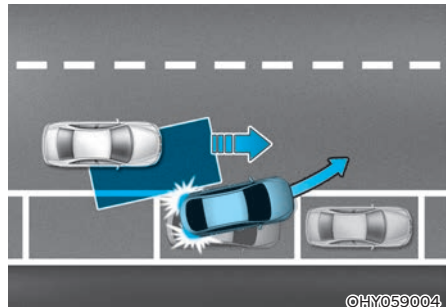

When you are driving forward out of a parking space, if Blind-Spot Collision-Avoidance Assist judges that there is a collision risk with an approaching vehicle in the blind spot, Blind-Spot Collision-Avoidance Assist will help avoid collision by applying the brake.

### Detecting sensor



[1] : Rear corner radar

Refer to the picture above for the detailed location of the detecting sensors.



### CAUTION

Take the following precautions to maintain optimal performance of the detecting sensor:

- Never disassemble the rear corner radar or radar assembly, or cause any damage to it.
- If there is impact on the rear corner radar or near the radar, even though the warning message does not appear on the cluster, Blind-Spot Collision-Avoidance Assist may not operate properly. Have the vehicle inspected by an authorized HYUNDAI dealer.
- If the rear corner radars have been replaced or repaired, have the vehicle inspected by an authorized HYUNDAI dealer.
- Use only genuine parts to repair the rear bumper where the rear corner radar is located.
- Do not apply license plate frame or objects, such as a bumper sticker, film or a bumper guard near the rear corner radar.

- The function may not work properly if the bumper has been replaced, or the surroundings of the rear corner radar have been damaged or paint has been applied.
- If a trailer, carrier, etc., is installed, it may adversely affect the performance of the rear corner radar or the system may not operate.

## Blind-Spot Collision-Avoidance Assist Settings

### Blind-Spot Safety

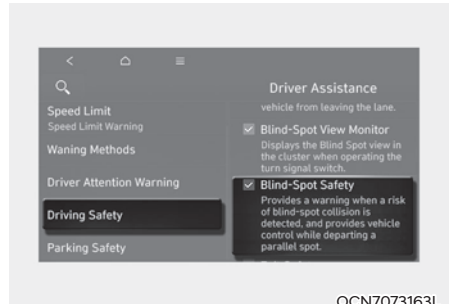

With the engine on, select **User settings** > **Driver Assistance** > **Driving Safety** > **Blind-Spot Safety** from the settings menu in the instrument cluster or **Settings** > **Vehicle** > **Driver Assistance** > **Driving Safety** > **Blind-Spot Safety** from the settings menu in the infotainment system to set whether to use each function.

- If **Blind-Spot Safety** is selected, Blind-Spot Collision-Avoidance Assist will warn the driver with a warning message, an audible warning depending on the collision risk levels. Braking assist will be applied for parking exit depending on the collision risk levels.



When the engine is restarted with Blind-Spot Collision-Avoidance Assist off, the 'Blind-Spot Safety System is Off' message will appear on the instrument cluster.

If you select Blind-spot safety, warning light on the side view mirror will blink for three seconds. In addition, if the vehicle is turned on, when Blind-Spot Safety is selected, the warning light on the side view mirror will blink for three seconds.



### WARNING

The driver should always be aware of the surroundings and drive safely. If Blind-spot safety is deselected, Blind Spot Collision-Avoidance Assist cannot assist you.



### Information

When the engine is restarted, Blind-Spot Collision-Avoidance Assist maintains its last setting.

## Warning Methods

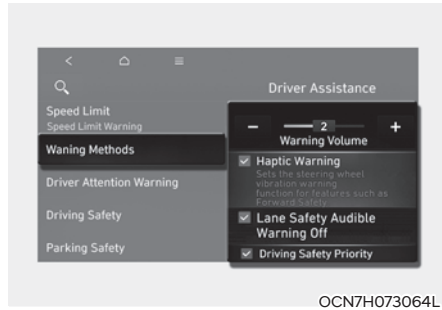

The Warning Methods can be set with the vehicle on. Select **User Settings > Driver Assistance > Warning Methods** from the settings menu in the instrument cluster or **Setup > Vehicle > Driver Assistance > Warning Methods** from the settings menu in the infotainment system to change the following settings:

- **Warning Volume:** Adjusts the volume of the warning sound.
- **Haptic Warning:** Activate the steering wheel vibration warning.
- **Driving Safety Priority:** Lowers all other audio volumes when the Driving Safety system sounds a warning.



### Information

- If you change the Warning Methods, the Warning Methods of other Driver Assistance systems may change.
- The Warning Volume and Haptic Warning cannot be turned off at the same time. When one of the warning is turned off the other is activated.
- If the engine is restarted, Warning Methods will maintain the last setting.
- The setting menu may not exist based on vehicle specification.

## Blind-Spot Collision-Avoidance Assist Operation

### Driving-Warning

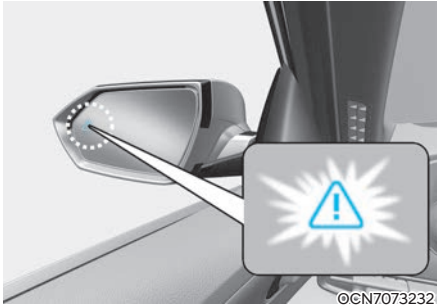

#### Vehicle detection

When a vehicle is detected in a blind spot, the warning light on the side view mirror illuminates.

- Vehicle detection operates when your vehicle speed is above 12 mph (20 km/h) and the speed of the vehicle in the blind spot area is above 6 mph (10 km/h).

#### Collision Warning

Collision warning will operate when the turn signal is turned on in the direction of the detected vehicle.

- To warn you of a potential collision, the warning light on the side view mirror may blink and an audible warning may sound and the steering wheel will vibrate.
- When the turn signal is turned off or you move away from the vehicle in the blind spot, the function returns to vehicle detection state.
- Collision warning may warn when your vehicle speed is above 25 mph (40 km/h) and the speed of the vehicle in the blind spot area is above 6 mph (10 km/h).



#### WARNING

- **The detecting range of the rear corner radar is determined by a standard road width, therefore, on a narrow road, the system may detect other vehicles two lanes over and warn you. In contrast, on a wide road, the system may not be able to detect a vehicle driving in the next lane and may not warn you.**
- **When the hazard warning flasher is on, the collision warning by the turn signal will not operate.**

**Collision-avoidance assist (while parallel parking exit)**



To warn you of a potential collision, the warning light on the side view mirror may blink, a warning message may appear on the instrument cluster, and an audible warning may sound and the steering wheel will vibrate.

- Blind-Spot Collision-Avoidance Assist operates when your vehicle speed is below 2 mph (3 km/h) and the speed of the vehicle in the blind spot area is above 3 mph (5 km/h).
- Blind-Spot Collision-Avoidance Assist may assist with braking your vehicle to help avoid a collision.



After your vehicle is stopped following an Emergency Braking event, the "Drive carefully" warning message may appear on the instrument cluster.

Depress the brake pedal immediately and check the surroundings.

- Braking control ends about 2 seconds after your vehicle is stopped following an Emergency Braking event.

 **WARNING**

**Blind-Spot Collision-Avoidance Assist may not operate in all situations and cannot avoid all collisions.**

**To prevent serious injury or death:**

- **Only change the settings after parking your vehicle at a safe Location.**
- **Blind-Spot Collision-Avoidance Assist may not operate if the function determines you have depressed the brake pedal sufficiently in response to the potential hazard detected by the function.**
- **If Blind-Spot Collision-Avoidance Assist is assisting to brake your vehicle and you excessively depress the accelerator pedal or sharply steer your vehicle, it stops assisted braking.**

- During Blind-Spot Collision-Avoidance Assist operation, your vehicle may stop suddenly. Always wear your seat belt, check your passengers have their seat belts fastened and secure loose objects that may become projectiles.
- Even if there is a problem with Blind-Spot Collision-Avoidance Assist, your vehicle's braking system operates normally.
- Control your vehicle at all times. Always maintain a safe distance from the vehicles ahead and adjust your vehicle speed depending on the road conditions.
- Never attempt to activate Blind-Spot Collision-Avoidance Assist by intentionally driving toward people, animals, objects, or other vehicles.
- When other system's warning message appears or audible warning is heard, Blind-Spot Collision-Avoidance Assist may not warn you.
- You may not hear the audible warning of Blind-Spot Collision-Avoidance Assist if the surrounding environment is too noisy.



## WARNING

The brake control may not operate properly depending on the status of ESC (Electronic Stability Control).

There will only be a warning when:

- The ESC (Electronic Stability Control) warning light is on
- ESC (Electronic Stability Control) is engaged in a different function

## Blind-Spot Collision-Avoidance Assist Malfunction and Limitations

### *Blind-Spot Collision-Avoidance Assist malfunction*

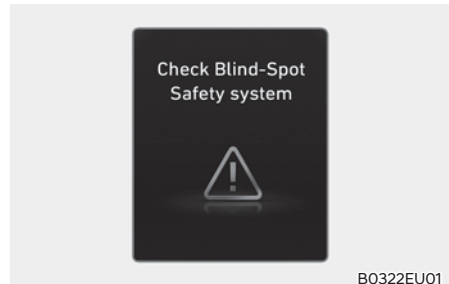

When Blind-Spot Collision-Avoidance Assist is not working properly, the 'Check Blind-Spot Safety system' warning message will appear on the instrument cluster for several seconds, and the master (⚠) warning light will appear on the instrument cluster. If this occurs, have your vehicle inspected by an authorized HYUNDAI dealer.

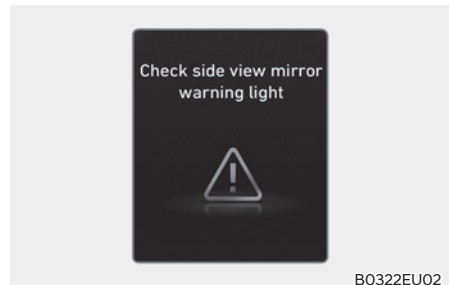

When the side view mirror warning light is not working properly, the 'Check side view mirror warning light' warning message will appear on the cluster for several seconds, and the master (⚠) warning light will illuminate on the cluster. If this occurs, have the vehicle inspected by an authorized HYUNDAI dealer.

### **Blind-Spot Collision-Avoidance Assist disabled**

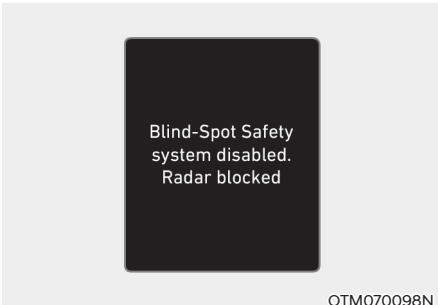

When the rear bumper around the rear corner radar or sensor is covered with foreign material, such as snow or rain, or installing a trailer or carrier, it can reduce the detecting performance and temporarily limit or disable Blind-Spot Collision-Avoidance Assist.

If this occurs, the 'Blind-Spot Safety function disabled. Radar blocked' warning message will appear on the cluster.

Blind-Spot Collision-Avoidance Assist will operate properly when such foreign material or trailer, etc., is removed, and then the engine is restarted.

If Blind-Spot Collision-Avoidance Assist does not operate properly after it is removed, have the vehicle inspected by an authorized HYUNDAI dealer.

### **WARNING**

- **Even though the warning message does not appear on the cluster, Blind-Spot Collision-Avoidance Assist may not properly operate.**
- **Blind-Spot Collision-Avoidance Assist may not properly operate in an area (for example, open terrain) where any objects are not detected right after the engine is turned on, or when the detecting sensor is blocked with foreign material right after the engine is turned on.**

### **CAUTION**

**Turn off Blind-Spot Collision-Avoidance Assist to install or remove a trailer, carrier, or another attachment. Turn on Blind-Spot Collision-Avoidance Assist when finished.**

### **Limitations of Blind-Spot Collision-Avoidance Assist**

Blind-Spot Collision-Avoidance Assist may not operate properly, or it may operate unexpectedly under the following circumstances:

- There is inclement weather, such as heavy snow, heavy rain, etc.
- The rear corner radar is covered with snow, rain, dirt, etc.
- The temperature around the rear corner radar is high or low
- Driving on a highway ramp
- The road pavement (or the peripheral ground) abnormally contains metallic components (for example, possibly due to subway construction)
- There is a fixed object near the vehicle, such as sound barriers, guardrails, central dividers, entry barriers, street lamps, signs, tunnels, walls, etc. (including double structures)
- Driving in vast areas where there are few vehicles or structures (for example, desert, meadow, suburb, etc.)
- Driving through a narrow road where trees or grass are overgrown
- Driving on a wet road surface, such as a puddle on the road
- The other vehicle drives very close behind your vehicle, or the other vehicle passes by your vehicle in close proximity

- The speed of the other vehicle is very fast that it passes by your vehicle in a short time
- Your vehicle passes by the other vehicle
- Your vehicle changes lane
- Your vehicle has started at the same time as the vehicle next to you and has accelerated
- The vehicle in the next lane moves two lanes away from you, or when the vehicle two lanes away moves to the next lane from you
- A trailer, carrier or other attachment is installed around the rear corner radar
- The bumper around the rear corner radar is covered with objects, such as a bumper sticker, bumper guard, bike rack, etc.
- The bumper around the rear corner radar is impacted, damaged or the radar is out of position
- Your vehicle height is low or high due to heavy loads, abnormal tire pressure, etc.

Blind-Spot Collision-Avoidance Assist may not operate properly, or it may operate unexpectedly when the following objects are detected:

- A motorcycle or bicycle is detected
- A vehicle such as a flat trailer is detected
- A big vehicle such as a bus or truck is detected
- A moving obstacle such as a pedestrian, animal, shopping cart or a baby stroller is detected
- A vehicle with low height such as a sports car is detected

Braking control may not work, driver's attention is required in the following circumstances:

- The vehicle severely vibrates while driving over a bumpy road, uneven road or concrete patch
- Driving on a slippery surface due to snow, water puddle, ice, etc.
- The tire pressure is low or a tire is damaged
- The braking system has been modified
- The vehicle makes abrupt lane changes

 **WARNING**

- Driving on a curved road

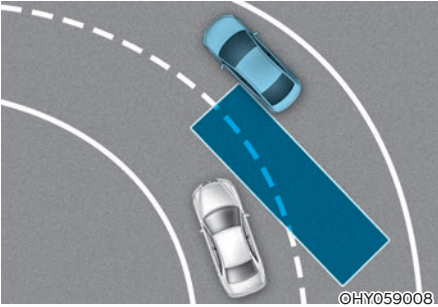

**Blind-Spot Collision-Avoidance Assist may not operate properly when driving on a curved road. Blind-Spot Collision-Avoidance Assist may not detect the vehicle in the next lane. Always pay attention to road and driving conditions while driving.**

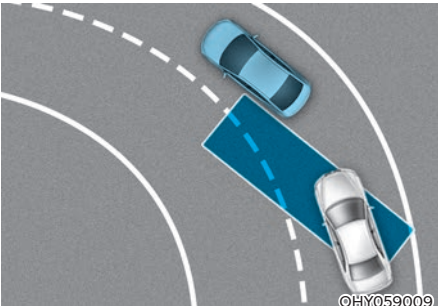

**Blind-Spot Collision-Avoidance Assist may not operate properly when driving on a curved road. Blind-Spot Collision-Avoidance Assist may recognize a vehicle in the same lane. Always pay attention to road and driving conditions while driving.**

- Driving where the road is merging/dividing

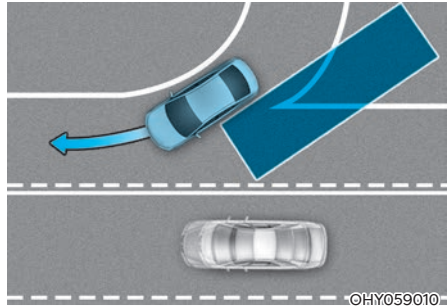

**Blind-Spot Collision-Avoidance Assist may not operate properly when driving where the road merges or divides. Blind-Spot Collision-Avoidance Assist may not detect the vehicle in the next lane.**

**Always pay attention to road and driving conditions while driving.**

- Driving on an inclined road

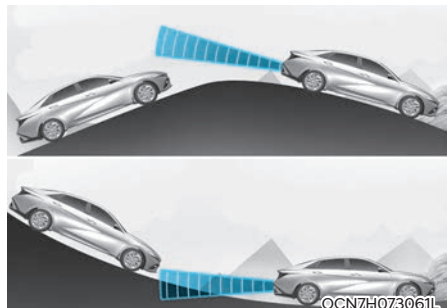

**Blind-Spot Collision-Avoidance Assist may not operate properly when driving on a slope. Blind-Spot Collision-Avoidance Assist may not detect the vehicle in the next lane or may incorrectly detect the ground or structure.**

**Always pay attention to road and driving conditions while driving.**

- Driving where the heights of the lanes are different

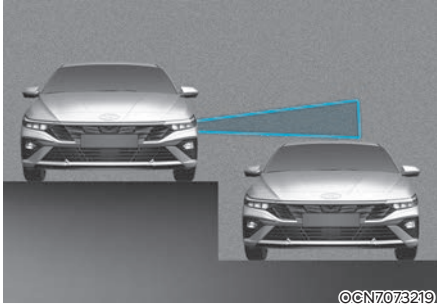

Blind-Spot Collision-Avoidance Assist may not operate properly when driving where the heights of the lanes are different. Blind-Spot Collision-Avoidance Assist may not detect the vehicle on a road with different lane heights (underpass joining section, grade separated intersections, etc.).

Always pay attention to road and driving conditions while driving.

### WARNING

- When you are towing a trailer or another vehicle, make sure that you turn off Blind-Spot Collision-Avoidance Assist.
- Blind-Spot Collision-Avoidance Assist may not operate properly if interfered by strong electromagnetic waves.
- Blind-Spot Collision-Avoidance Assist may not operate for 3 seconds after the vehicle is started, or the rear corner radars are initialized.

### Information

This device complies with Part 15 of the FCC rules.

Operation is subject to the following three conditions:

1. This device may not cause harmful interference, and
2. This device must accept any interference received, including interference that may cause undesired operation.
3. Changes or modifications not expressly approved by the party responsible for compliance could void the user's authority to operate the device.

### Information

Radio frequency radiation exposure information:

This equipment complies with FCC radiation exposure limits set forth for an uncontrolled environment.

This equipment should be installed and operated with minimum distance of 8 in. (20 cm) between the radiator (antenna) and your body.

This transmitter must not be co-located or operating in conjunction with any other antenna or transmitter.

## SAFE EXIT WARNING (SEW) (IF EQUIPPED)

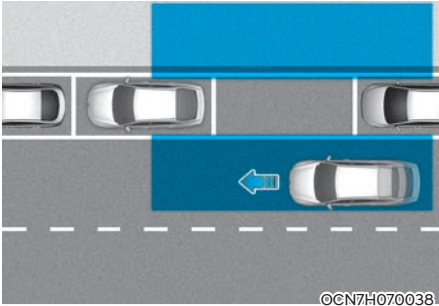

While your vehicle is stopped, and if Safe Exit Warning detects a vehicle approaching the rear corner of your vehicle and a passenger opens a door, Safe Exit Warning may warn you with a warning message and a warning sound to help avoid a collision.



### CAUTION

Warning timing may vary depending on the speed of the approaching vehicle.

### Detecting sensor



[1]: Rear corner radar

Refer to the picture above for the detailed location of the detecting sensors.

### NOTICE

For more details on the precautions of the rear corner radars, refer to “Blind-Spot Collision-Avoidance Assist (BCA)” section in chapter 7.

## Safe Exit Warning Settings

### Exit Safety

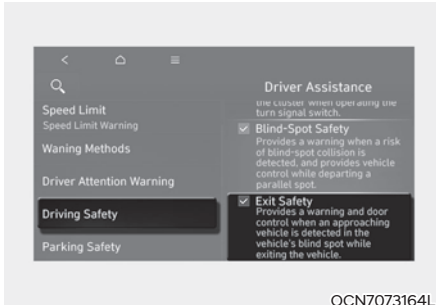

With the engine on, select **User settings > Driver Assistance > Driving Safety > Exit Safety** from the settings menu in the instrument cluster or **Settings > Vehicle > Driver Assistance > Driving Safety > Exit Safety** from the Settings menu in the infotainment system to turn on Safe Exit Warning and deselect to turn off the function.

### WARNING

The driver should always be aware that unexpected and sudden situations may occur. If **Exit Safety** is deselected, **Safe Exit Warning** cannot assist you.

### Information

If the engine is restarted, **Safe Exit Warning** will maintain the last setting.

## Warning Methods



The **Warning Methods** can be set with the vehicle on. Select **User Settings > Driver Assistance > Warning Methods** from the settings menu in the instrument cluster or **Setup > Vehicle > Driver Assistance > Warning Methods** from the settings menu in the infotainment system to change the following settings:

- **Warning Volume:** Adjusts the volume of the warning sound. If you turn off the **Warning Volume**, for your safety, the function may warn you with a low volume.
- **Driving Safety Priority:** Lowers all other audio volumes when the **Driving Safety** system sounds a warning.

### Information

- If you change the **Warning Methods**, the **Warning Methods** of other **Driver Assistance** systems may change.
- If the engine is restarted, **Warning Methods** will maintain the last setting.
- The setting menu may not exist based on vehicle specification.

## Safe Exit Warning Operation

**Collision warning when exiting your vehicle**

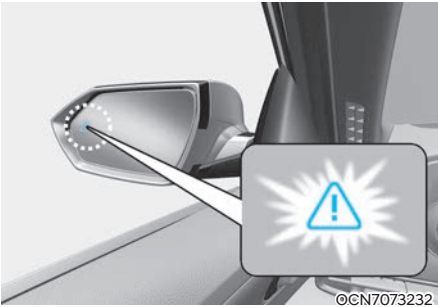

When an approaching vehicle from the rear is detected at the moment a door is opened, the 'Watch for traffic' warning message will appear on the cluster, and an audible warning will sound.

- Safe Exit Warning may warn you when your vehicle speed is below 2 mph (3 km/h), and the speed of the vehicle approaching the rear of your vehicle is above 4 mph (6 km/h).

## WARNING

Safe Exit Warning may not operate in all situations and cannot avoid all collisions.

To prevent serious injury or death:

- Always check the surroundings before you or your passengers exit your vehicle.
- Only change the settings after parking your vehicle at a safe location.
- When other system's warning message appears or audible warning is heard, Safe Exit Warning may not warn you.
- You may not hear the audible warning of Safe Exit Warning if the surrounding environment is too noisy.
- Safe Exit Warning may stop operating, or may not operate, or operate unnecessarily depending on the road conditions and surroundings.

## Information

- After the engine is turned off, Safe Exit Warning may detect approaching vehicles for up to 10 minutes, but does not function after the doors are locked.
- The images and colors in the instrument cluster may differ depending on the cluster type or theme selected from the settings menu.

## Safe Exit Warning Malfunction and Limitations

### Safe Exit Warning malfunction

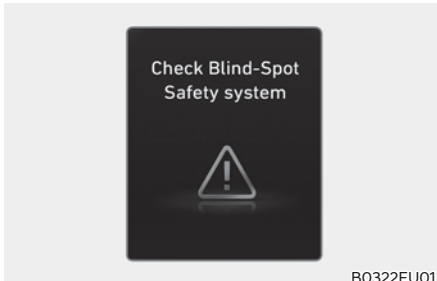

B0322EU01

When Safe Exit Warning is not working properly, the "Check Blind-Spot Safety system" warning message will appear on the instrument cluster for several seconds, and the master (⚠) warning light will appear on the instrument cluster. Have the vehicle inspected by an authorized HYUNDAI dealer.

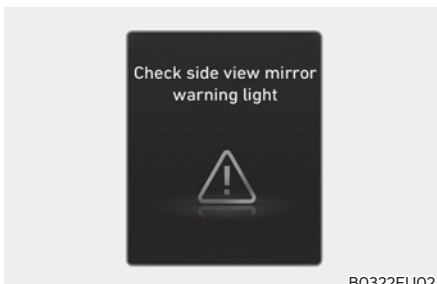

B0322EU02

When the side view mirror warning light is not working properly, the "Check side view mirror warning light" warning message will appear on the instrument cluster for several seconds, and the master (⚠) warning light will illuminate on the instrument cluster. Have the vehicle inspected by an authorized HYUNDAI dealer.

### Safe Exit Warning disabled

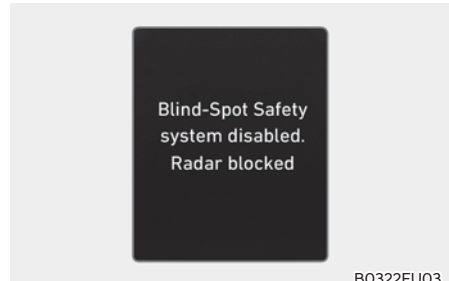

B0322EU03

When the rear bumper around the rear corner radar or sensor is covered with foreign material, such as snow or rain, or installing a trailer or carrier, it can reduce the detecting performance and temporarily limit or disable Blind-Spot Collision-Avoidance Assist.

If this occurs, the 'Blind-Spot Safety function disabled. Radar blocked' warning message will appear on the cluster.

Safe Exit Warning will operate properly when such foreign material or trailer, etc., is removed, and then the engine is restarted.

If Safe Exit Warning does not operate properly after it is removed, have the vehicle inspected by an authorized HYUNDAI dealer.



### WARNING

- **Even though the warning message does not appear on the cluster, Safe Exit Warning may not properly operate.**
- **Safe Exit Warning may not properly operate in an area (for example, open terrain) where any objects are not detected right after the engine is turned on, or when the detecting sensor is blocked with foreign material right after the engine is turned on.**



## CAUTION

Turn off Safe Exit Warning to install or remove a trailer, carrier, or another attachment. Turn on Safe Exit Warning when finished.

### *Limitations of Safe Exit Warning*

Safe Exit Warning may not operate normally, or may operate unexpectedly if:

- Trees or grass near your vehicle are overgrown.
- The road is wet.
- The approaching vehicle is very fast or slow.



## Information

For more information on the limitations on the rear corner radar, refer to the "Blind-spot collision-avoidance assist (BCA)" section in this chapter.



## WARNING

- Safe Exit Warning may not operate if there is interference from strong electromagnetic waves.
- Safe Exit Warning may not operate for 3 seconds right after your vehicle is started or when the rear corner radars are initialized.
- Safe Exit Warning may not operate properly even after the engine has been restarted when the detecting sensors are blocked or there is a problem with the function.

## MANUAL SPEED LIMIT ASSIST (MSLA)

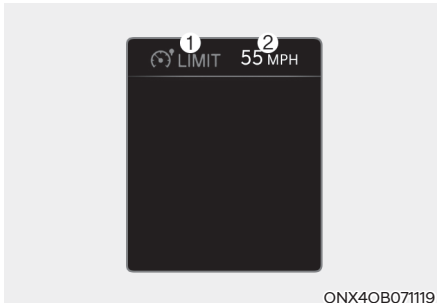

(1) Manual Speed Limit Assist indicator light

(2) Set speed

Manual Speed Limit Assist allows you to set a self-imposed maximum speed limit. If you drive over the set speed, Manual Speed Limit Assist blinks and chimes until your vehicle speed decreases below the set speed.

### Manual Speed Limit Assist Operation

#### To set speed limit

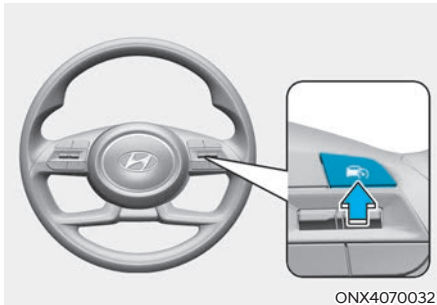

1. Press and hold the Driving Assist (DA) button at the desired speed. The Manual Speed Limit Assist (MSLA) indicator light illuminates on the instrument cluster.

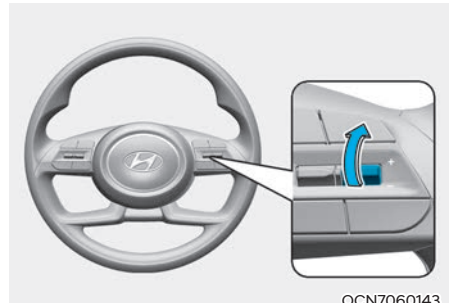

2. Push the + switch up or - switch down to change the set speed.

Push and hold to increase or decrease to the nearest multiple of five (multiple of ten in km/h), and then increase or decrease by 5 mph (10 km/h).

OCN7060144



ONX4OB071120

3. Check the set speed limit on the instrument cluster.

If you want to drive over the set speed, depress the accelerator pedal far enough to activate the kickdown function.

The set speed limit blinks and chime sounds until your vehicle speed decreases below the set speed limit.

### **i** Information

- When the accelerator pedal is not depressed beyond the pressure point, your vehicle speed maintains within the speed limit.
- The maximum setting speed varies depending on the vehicle specifications. The set speed cannot be increased beyond the maximum set speed.

### **To temporarily cancel Manual Speed Limit Assist**

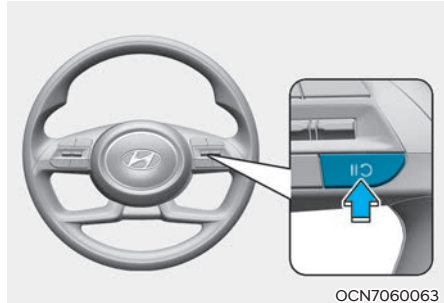

OCN7060063

Press the **||** button to temporarily cancel the set speed limit. The set speed turns off, but the Manual Speed Limit Assist (LIMIT) indicator light stays on.

### To resume Manual Speed Limit Assist

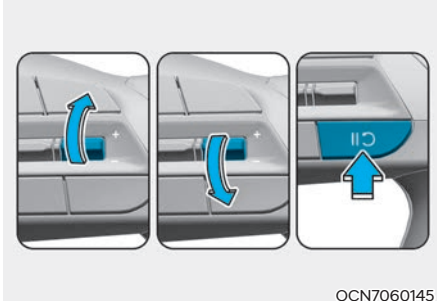

OCN7060145

Push the +/- switch or **RESUME** button.

If you push the + switch up or – switch down, the set speed is set to the current speed.

If you press the **RESUME** button, the set speed resumes to the previously set speed limit.

### To turn off Manual Speed Limit Assist

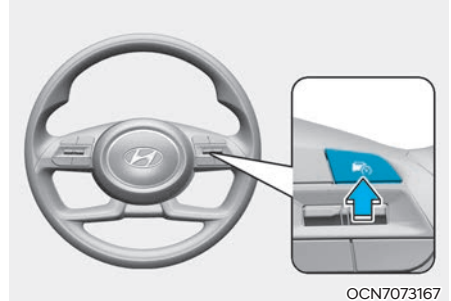

OCN7073167

Press the Driving Assist (**DA**) button to turn off Manual Speed Limit Assist off. The Manual Speed Limit Assist (**LIMIT**) indicator light turns off.

Always press the Driving Assist (**DA**) button to turn off Manual Speed Limit Assist when not in use.

### **WARNING**

To prevent serious injury or death:

- Set your vehicle speed to the speed limit for the road and use the appropriate unit (mph or km/h) for your state.
- Keep Manual Speed Limit Assist off when not in use, to avoid inadvertently setting a speed. Check that the Manual Speed Limit Assist (**LIMIT**) indicator light is off.
- Always drive defensively and pay attention to the driving task.

## INTELLIGENT SPEED LIMIT ASSIST (ISLA) (IF EQUIPPED)

Intelligent Speed Limit Assist uses information from the detected road signs and uses the navigation system data to inform you of the speed limit and to help maintain within the speed limit on the road.

### CAUTION

- Intelligent Speed Limit Assist may not operate properly if the function is used in other countries.
- If a navigation is applied to your vehicle, the navigation needs to be regularly updated for Intelligent Speed Limit Assist to operate properly. For more information, refer to the manual provided in the infotainment system and the quick reference guide.

### Detecting sensor



[1]: Front view camera

Refer to the picture above for the detailed location of the detecting sensor.

### CAUTION

For more details on the precautions of the front view camera, refer to “Forward Collision-Avoidance Assist (FCA)” section in this chapter.

## Intelligent Speed Limit Assist Settings

### Speed Limit

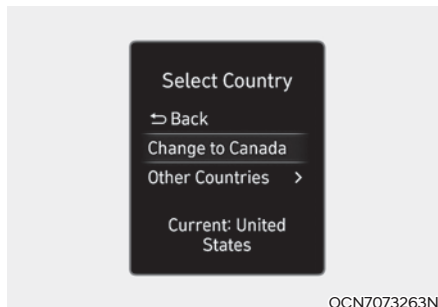

OCN7073263N

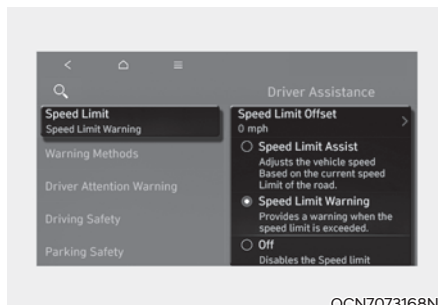

OCN7073168N

With the ignition switch ON, select or deselect **User Settings > Driver Assistance > Speed Limit** from the User Settings menu in the instrument cluster or **Settings > Vehicle > Driver Assistance > Speed Limit** from the Settings menu in the infotainment system to set whether to use each function.

- **Select Country:** When the navigation system is not available, you can manually select the country to set the speed limit from the User Settings menu in the instrument cluster.
- **Speed Limit Assist:** Intelligent Speed Limit Assist will inform the driver of speed limit and additional road signs. In addition, Intelligent Speed Limit Assist will inform the driver to change set speed of Manual Speed Limit Assist and/or Smart Cruise Control to help the driver stay within the speed limit.

- **Speed Limit Warning:** Intelligent Speed Limit Assist will inform the driver of speed limit. In addition, Intelligent Speed Limit Assist will warn the driver when the vehicle is driven faster than the speed limit.
- **Off:** Intelligent Speed Limit Assist will turn off.

## Intelligent Speed Limit Assist Operation

Intelligent Speed Limit Assist may warn and control your vehicle by "Displaying speed limit", "Warning overspeed", and "Changing set speed".

### **i** Information

Intelligent Speed Limit operation is described based on the offset adjusted to "0". For more information on setting the offset, refer to "Intelligent Speed Limit Assist settings" in this section.

#### *Displaying speed limit*



Speed limit information appears on the instrument cluster.

### **i** Information

- If the speed limit information of the road cannot be recognized, "----" appears.
- Intelligent Speed Limit Assist provides additional road sign information in addition to speed limit information. Additional road sign information provided may differ depending on your state.
- The images and colors in the instrument cluster may differ depending on the cluster type or theme selected from the settings menu.

#### *Warning overspeed*



When driving at a speed higher than the displayed speed limit, the speed limit appears in red.

### Changing set speed

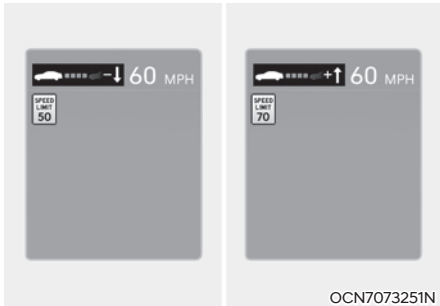

If the speed limit changes when using Manual Speed Limit Assist or Smart Cruise Control, an arrow in the direction of up or down appears to inform you to change the set speed by pushing the + or – switch.

### Set Speed Auto Change (Navigation equipped)

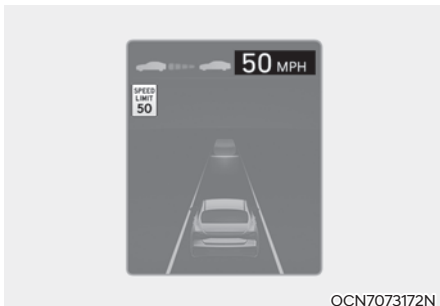

Manual Speed Limit Assist or Smart Cruise Control assists the vehicle to adjust its speed according to the speed limit. When the cruising speed is set as same as the speed limit, the vehicle automatically adjusts its speed if the speed limit changes. The function operates on the road which has a speed limit of 45 mph (70 km/h) or higher. When the function is active, the cruising speed on the instrument cluster appears in green.

### WARNING

- If you want to drive below the speed limit, set the Speed Limit Offset under "0" or use the – switch on the steering wheel to lower the set speed. If the Speed Limit Offset is set over "0", the set speed changes to a speed higher than the limit for the road.
- If necessary, reduce your driving speed as needed. Even after changing the set speed according to the speed limit for the road, your vehicle can still be driven over the speed limit.
- If the speed limit for the road is under 20 mph (30 km/h), the set speed changing function does not work.
- Intelligent Speed Limit Assist operates using the speed unit set by you from the settings menu. If the speed unit is set to a unit other than the speed unit used in your state, Intelligent Speed Limit Assist may not operate properly.

### Information

- For more information on Manual Speed Limit Assist operation, refer to the "Manual Speed Limit Assist (MSLA)" section in this chapter.
- For more details on Smart Cruise Control operation, refer to the "Smart Cruise Control (SCC)" section in this chapter.

## Intelligent Speed Limit Assist Malfunction and Limitations

### Intelligent Speed Limit Assist malfunction

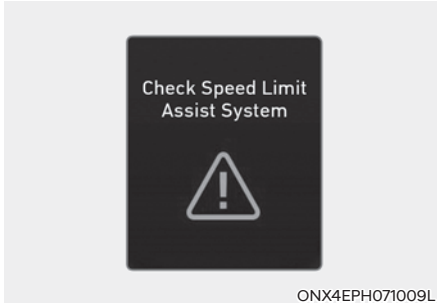

When Intelligent Speed Limit Assist is not working properly, the "Check Speed Limit Assist System" warning message may appear, and the (⚠) warning light may illuminate on the instrument cluster. Have the vehicle inspected by an authorized HYUNDAI dealer.

### Intelligent Speed Limit Assist disabled

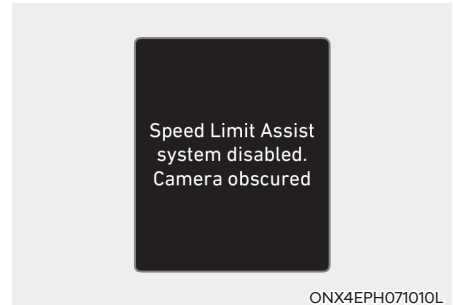

If the front view camera is covered or blocked, its detecting performance is reduced, and Intelligent Speed Limit Assist is temporarily limited or disabled. The "Speed Limit Assist system disabled. Camera obscured" warning message may appear on the instrument cluster. If Intelligent Speed Limit Assist does not operate normally after the sensor has been uncovered or unblocked, have the vehicle inspected by an authorized HYUNDAI dealer.

### **WARNING**

**Intelligent Speed Limit Assist may not operate properly even if there is no warning message or warning light on the instrument cluster.**

### **Limitations of Intelligent Speed Limit Assist**

Intelligent Speed Limit Assist may not operate or may be limited if:

- The road sign is damaged, difficult to see due to rain, snow, fog, dirt, sand, oil, etc., or obscured by surrounding objects or shadows.
- The road signs do not conform to the standard designs in your state.
  - The text or picture on the road sign is different from the standard designs in your state.
  - The road sign is installed between the main road and exit road or between diverging roads.
  - A sign is attached to another vehicle.
- The distance between the driving lane and road sign is far.
- There are LED road signs.
- The numbers or pictures in the road sign is incorrectly recognized as the speed limit.
- Road signs on adjacent roads are incorrectly recognized as road signs you are driving on.
- Multiple signs are installed close together.
- Supplementary road signs or signboards are installed near the road sign.
- A minimum speed limit sign is incorrectly recognized as the maximum speed limit sign.
- The brightness changes suddenly, for example when entering or exiting a tunnel or passing under a bridge.
- Headlights are not used, or the brightness of the headlights are weak at night or in the tunnel.
- Road signs are difficult to recognize due to the reflection of sunlight, streetlights, or oncoming vehicles.
- The front view camera's field of view is obstructed by glare from the sun.

- You are driving on a road that is sharply curved or continuously curved.
- You are driving through speed bumps, or driving up and down, or left to right on steep inclines.
- Your vehicle is shaking heavily.
- There is an error in the navigation map data or GPS data.
- You are not driving your vehicle based on the route guidance.
- You are driving your vehicle on a newly opened road.
- The navigation system is updated while driving or restarts.

### **Information**

**For more information on the limitations of the front view camera, refer to "Forward Collision-Avoidance Assist (FCA)" section in this chapter.**

## DRIVER ATTENTION WARNING (DAW) (IF EQUIPPED)

### Inattentive Driving Warning function

Driver Attention Warning can help determine the driver's attention level by analyzing driving pattern and driving time while the vehicle is driven. The system can recommend a break when the driver's attention level falls below a certain level.

### Leading Vehicle Departure Alert function

Leading Vehicle Departure Alert function can inform the driver when a detected vehicle in front departs from a stop.

### Detecting sensor



[1] : Front view camera

The front view camera is used to help detect driving patterns and front vehicle departure while vehicle is being driven. Refer to the picture above for the detailed location of the detecting sensor.



### CAUTION

**Always keep the front view camera in good condition to maintain optimal performance of Driver Attention Warning.**

**For more details on the precautions of the front view camera, refer to “Forward Collision-Avoidance Assist (FCA)” section in chapter 7.**

### Driver Attention Warning Setting Leading Vehicle Departure Alert

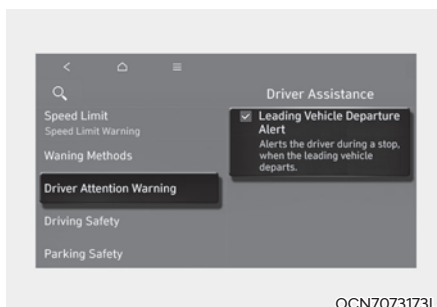

OCN7073173L

With the engine on, select or deselect **User Settings > Driver Assistance > Driver Attention Warning** from the settings menu in the instrument cluster or **Settings > Vehicle > Driver Assistance > Driver Attention Warning** from the settings menu in the infotainment system to set whether to use the function.

If Leading vehicle departure alert is enabled, the function informs the driver when a detected vehicle in front departs from a stop.

## Driver Attention Warning Operation

### Inattentive Driving Warning function

The basic function of Driver Attention Warning is to warn the driver "Consider taking a break".

#### Taking a break

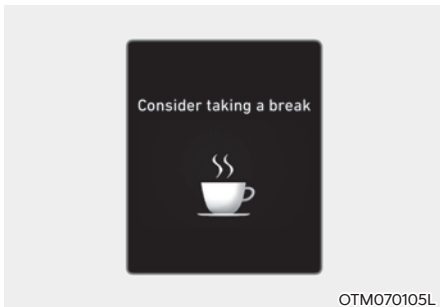

- The "Consider taking a break" message and Driver Attention Warning light (☹️) will appear on the cluster and an audible warning will sound to suggest that the driver take a break, when the driver's attention level is below 1.
- Driver Attention Warning will not suggest a break when the total driving time is shorter than 4 minutes or 4 minutes has not passed after the last break was suggested.



### CAUTION

- Driver Attention Warning may suggest a break depending on the driver's driving pattern or habits, even if the driver doesn't feel fatigued.
- Driver Attention Warning is a supplemental system and may not be able to determine whether the driver is inattentive.
- A driver who feels fatigued should take a break at a safe location, even though there is no break suggestion by Driver Attention Warning.



### WARNING

**For your safety, only change the Settings after parking the vehicle at a safe location.**

### Leading Vehicle Departure Alert function



OCN7073174L

When a detected vehicle in front departs from a stop, Leading Vehicle Departure Alert will inform the driver by displaying the 'Leading vehicle is driving away' message on the cluster and an audible warning will sound.



#### WARNING

- If any other system's warning message is displayed or audible warning is generated, Leading Vehicle Departure Alert's warning message may not be displayed and audible warning may not be generated.
- The driver has the responsibility to safely drive and control the vehicle.



#### CAUTION

- Leading Vehicle Departure Alert is a supplemental function and may not alert the driver whenever the front vehicle departs from a stop.
- Always check the front of the vehicle and road conditions before departure.

### Driver Attention Warning Malfunction and Limitations

#### Driver Attention Warning malfunction

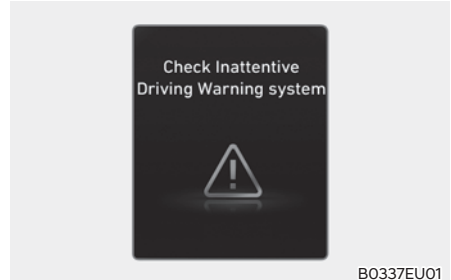

B0337EU01

When Driver Attention Warning is not working properly, the 'Check Driver Attention Warning (DAW) system' warning message will appear on the cluster for several seconds, and the master (⚠) warning light will illuminate on the cluster. If this occurs, have the vehicle inspected by an authorized HYUNDAI dealer.

### Driver Attention Warning disabled

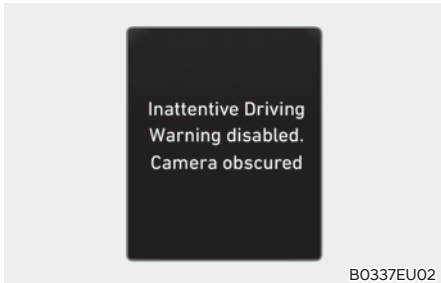

When the front windshield where the front view camera is located is covered with foreign material, such as snow or rain, it can reduce the detecting performance and temporarily limit or disable Driver Attention Warning. If this occurs, the "Inattentive Driving Warning disabled. Camera obscured" warning message will appear on the instrument cluster. Driver Attention Warning will operate properly when snow, rain or foreign material is removed.

If Driver Attention Warning does not operate properly after it is removed, have the vehicle inspected by an authorized HYUNDAI dealer.

### WARNING

- Driver Attention Warning may not properly operate in an area (for example, open terrain) where any objects are not detected right after turning ON the engine.
- If the engine is turned off and restarted while the camera is blocked or malfunctioned, the condition is maintained. Therefore, Driver Attention Warning may not operate properly.

### Limitations of Driver Attention Warning

Driver Attention Warning may not work properly in the following situations:

- The vehicle is driven violently
- The vehicle intentionally crosses over lanes frequently
- The vehicle is controlled by Driver Assistance system, such as Lane Keeping Assist

### Leading Vehicle Departure Alert feature

- When the vehicle cuts in

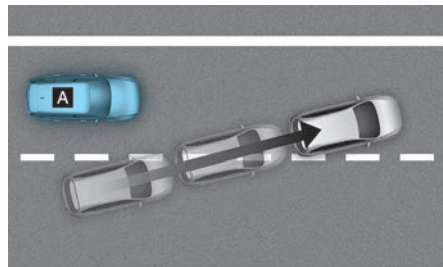

©ADAS021

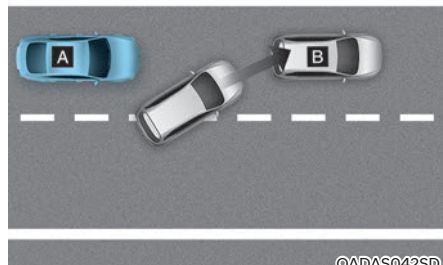

©ADAS042SD

[A] : Your vehicle, [B] : Front vehicle

If a vehicle cuts in front of your vehicle, Leading Departure Alert may not operate properly.

- When the vehicle ahead sharply steers

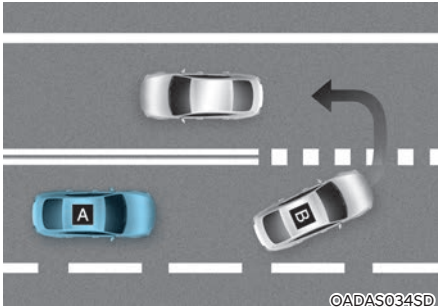

[A] : Your vehicle, [B] : Front vehicle

If the vehicle in front makes a sharp turn, such as to turn left or right or make a U-turn, etc., Leading Vehicle Departure Alert may not operate properly.

- When the vehicle ahead abruptly departs

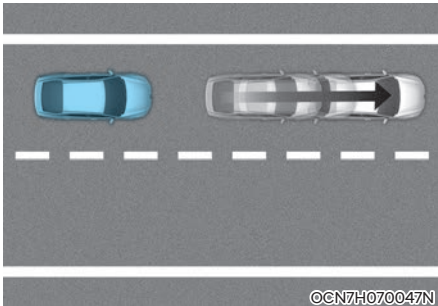

If the vehicle in front abruptly departs, Leading Vehicle Departure Alert may not operate properly.

- When a pedestrian or bicycle is between you and the vehicle ahead

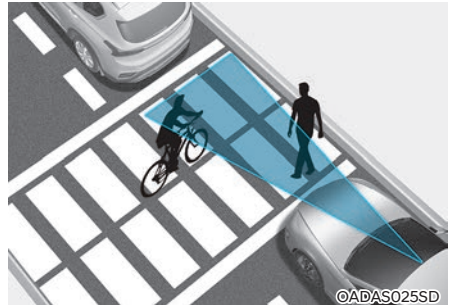

If there is a pedestrian(s) or bicycle(s) in between you and the vehicle in front, Leading Vehicle Departure Alert may not operate properly.

- When in a parking lot

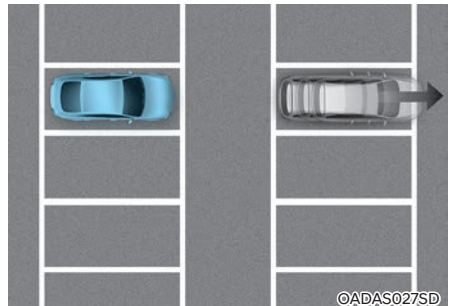

If a vehicle parked in front drives away from you, Leading Vehicle Departure Alert may alert you that the parked vehicle is driving away.

- When driving at a tollgate or intersection, etc.

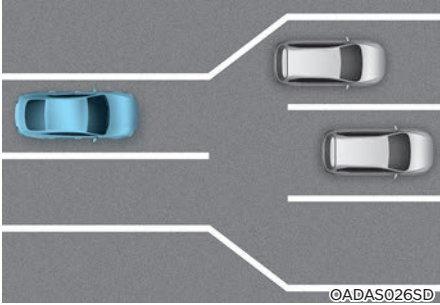

If you pass a tollgate or intersection with lots of vehicles or you drive where lanes are merged or divided frequently, Leading Vehicle Departure Alert may not operate properly.



### **WARNING**

**Driver Attention Warning may not operate for 15 seconds right after your vehicle is started or when the front view camera is initialized.**



### **CAUTION**

**For more details on the precautions of the front view camera, refer to “Forward Collision-Avoidance Assist (FCA)” section in chapter 7.**

## CRUISE CONTROL (CC) (IF EQUIPPED)

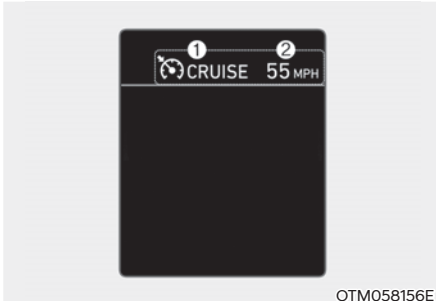

OTM058156E

- (1) Cruise indicator
- (2) Set speed

Cruise Control will allow you to drive at speeds above 20 mph (30 km/h) without depressing the accelerator pedal.



### Cruise Control Operation

#### Setting set speed

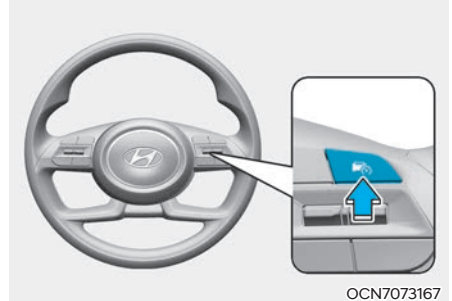
1. Accelerate to the desired speed, which must be more than 20 mph (30 km/h).



OCN7073167

2. Press the Driving Assist () button at the desired speed. The set speed and Cruise () indicator light illuminates on the instrument cluster.
3. Release the accelerator pedal.  
Vehicle speed will maintain the set speed even when the accelerator pedal is not depressed.

### Information

**On a steep slope, the vehicle may slightly slow down or speed up while driving uphill or downhill.**

### Increasing set speed

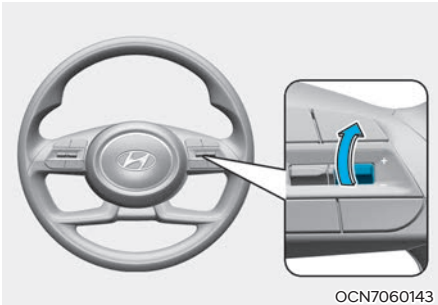

- Push the + switch up and release it immediately. The set speed will increase by 1 mph (1 km/h) each time the switch is operated in this manner.
- Push the + switch up and hold it while monitoring the set speed on the cluster. The set speed will increase to the nearest multiple of ten (multiple of five in mph) at first, and then increase by 5 mph (10 km/h) each time the switch is operated in this manner. Release the switch when the desired speed is shown and the vehicle will accelerate to that speed.

### Decreasing set speed

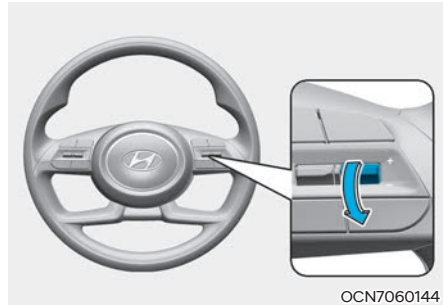

- Push the - switch down and release it immediately. The set speed will decrease by 1 mph (1 km/h) each time the switch is operated in this manner.
- Push the - switch down and hold it while monitoring the set speed on the cluster. The set speed will decrease to the nearest multiple of ten (multiple of five in mph) at first, and then decrease by 5 mph (10 km/h) each time the switch is operated in this manner. Release the switch at the speed you want to maintain.

### **i** Information

The set speed may differ depending on the vehicle specifications. You may not increase the set speed above the maximum set speed.

### **Accelerating temporarily**

If you want to accelerate temporarily when Cruise Control is on, depress the accelerator pedal.

To return to the set speed, take your foot off the accelerator pedal.

If you push the + switch up or - switch down at a higher speed, the cruising speed is set to the higher speed.

### Temporarily pausing Cruise Control

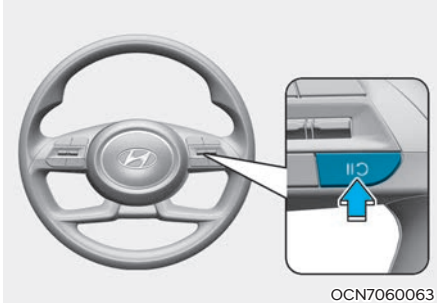

Cruise Control will be paused when:

- Depressing the brake pedal.
- Pushing the **||** **↻** button.
- Shifting the gear to N (Neutral).
- Decreasing vehicle speed to less than approximately 20 mph (30 km/h).
- ESC (Electronic Stability Control) is operating.

The set speed will turn off but the Cruise (**CRUISE**) indicator will stay on.

### **i** Information

**If Cruise Control cancels during a situation not listed above, have the vehicle inspected by an authorized HYUNDAI dealer.**

### Resuming Cruise Control

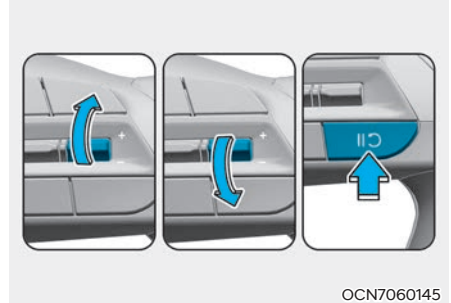

Push the +, - switch or **||** **↻** button.

If you push the + switch up or - switch down, vehicle speed will be set to the current speed on the cluster.

If you push the **||** **↻** button, vehicle speed will resume to the preset speed.

Vehicle speed must be above 20 mph (30 km/h) for the function to resume.

### Turning off Cruise Control

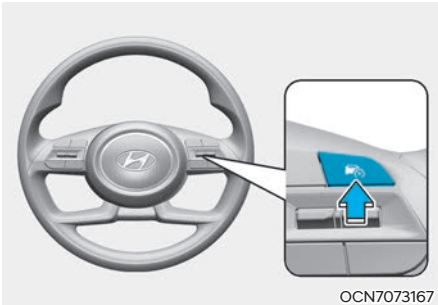

Press the Driving Assist (Ⓜ) button to turn off Cruise Control. The Cruise (CRUISE) indicator light goes off.

Always press the Driving Assist (Ⓜ) button to turn off Cruise Control when not in use.

If your vehicle is equipped with Manual Speed Limit Assist, press and hold the Driving Assist button to turn off Cruise Control. However, Manual Speed Limit Assist will turn on.

### WARNING

Take the following precautions when using Cruise Control:

- Always set the vehicle speed to the speed limit in your area.
- Keep Cruise Control off when the system is not in use, to avoid inadvertently setting a speed. Check that the Cruise (CRUISE) indicator is off.
- Cruise Control does not substitute for proper and safe driving. It is the responsibility of the driver to always drive safely and should always be aware of unexpected and sudden situations from occurring.
- Always drive cautiously to prevent unexpected and sudden situations from occurring. Pay attention to the road conditions at all times.
- Do not use Cruise Control when it may be unsafe to keep the vehicle at a constant speed:
  - When driving in heavy traffic, or when traffic conditions make it difficult to drive at a constant speed
  - When driving on rainy, icy, or snow-covered roads
  - When driving on hilly or windy roads
  - When driving in windy areas
  - When driving with limited view (possibly due to bad weather, such as fog, snow, rain and sandstorm)

## SMART CRUISE CONTROL (SCC) (IF EQUIPPED)

Smart Cruise Control is designed to help detect the vehicle ahead and help maintain the desired speed and minimum distance between the vehicle ahead.

### Overtaking Acceleration Assist

While Smart Cruise Control is operating, if the system judges that the driver is determined to overtake the vehicle in front, acceleration will be assisted.

### Detecting sensor



©CN7H073054L



©CN7H073056L

[1] : Front view camera,

[2] : Front radar

The front view camera and front radar are used as a detecting sensor to help detect the vehicles in front.

Refer to the picture above for the detailed location of the detecting sensor.



### CAUTION

Always keep the front view camera and front radar in good and clean condition to maintain optimal performance of Smart Cruise Control.

For more details on the precautions of the front view camera and front radar, refer to “Forward Collision-Avoidance Assist (FCA)” section in chapter 7.

### Smart Cruise Control Settings

#### Smart Cruise Control

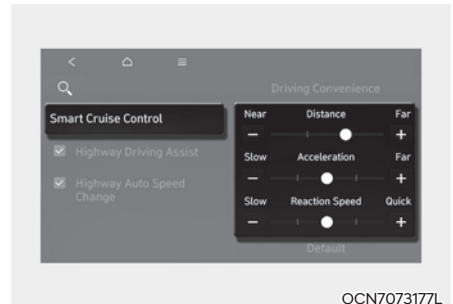

©CN7073177L

With the engine on, select **User settings** > **Driver Assistance** > **Smart Cruise Control** from the settings menu on the instrument cluster or **Settings** > **Vehicle** > **Driver Assistance** > **Driving Convenience** > **Smart Cruise Control** in the infotainment system to change Distance, Acceleration, Reaction Speed manually.

## Warning Methods

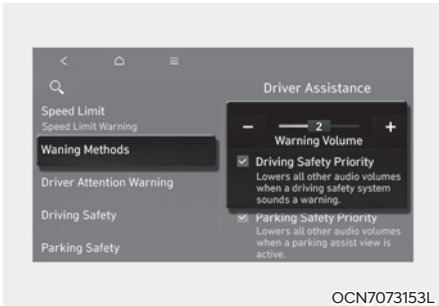

The Warning Methods can be set with the vehicle on. Select **User Settings > Driver Assistance > Warning Methods** from the settings menu in the instrument cluster or **Setup > Vehicle > Driver Assistance > Warning Methods** from the settings menu in the infotainment system to change the following settings:

- **Warning Volume:** Adjusts the volume of the warning sound. If you turn off the **Warning Volume**, for your safety, the function may warn you with a low volume.
- **Haptic Warning:** Activate the steering wheel vibration warning.
- **Driving Safety Priority:** Lowers all other audio volumes when the Driving Safety system sounds a warning.

### Information

- If you change the Warning Methods, it can be applied to each function of the driver assistance system. Please check and change it in each function.
- If the vehicle is restarted, Warning Methods will maintain the last setting.
- The setting menu may not exist based on vehicle specification.

## Smart Cruise Control Operation

### Operating conditions

Smart Cruise Control will operate when the following conditions are satisfied.

### Basic function

- The gear is in D (Drive)
- The driver's door is closed
- EPB (Electronic Parking Brake) is not applied
- Your vehicle speed is within the operating speed range
  - 5~100 mph (10~160 km/h): when there is no vehicle in front
  - 0~100 mph (0~160 km/h): when there is a vehicle in front
- ESC (Electronic Stability Control), TCS (Traction Control System) or ABS (Anti-Lock Braking System) is on
- ESC (Electronic Stability Control), TCS (Traction Control System) or ABS (Anti-Lock Braking System) is not controlling the vehicle
- Engine rpm is not in the red zone
- Forward Collision-Avoidance Assist brake control is not operating

### Information

When stopped behind another vehicle, the driver can turn on Smart Cruise Control while the brake pedal is depressed.

### Overtaking Acceleration Assist

Overtaking Acceleration Assist will operate when the turn signal indicator is turned on to the left while Smart Cruise Control is operating, and the following conditions are satisfied:

- Your vehicle speed is above 40 mph (60 km/h)
- The hazard warning flasher is off
- A vehicle is detected in front of your vehicle
- Deceleration is not needed to maintain distance with the vehicle in front

Overtaking Acceleration Assist does not operate in the following conditions.

- The hazard warning flasher is on
- Vehicle speed is reduced to maintain distance with the vehicle in front



### WARNING

**When the turn signal indicator is turned on to the left while there is a vehicle ahead, the vehicle may accelerate temporarily. Pay attention to the road conditions at all times.**

### Turning on Smart Cruise Control

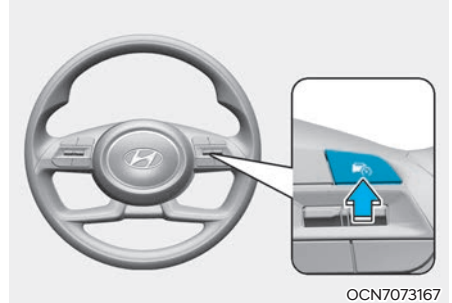

OCN7073167

- Press the Driving Assist button to turn on the system. The speed will be set to the current speed on the cluster.
- If there is no vehicle in front of you, the set speed will be maintained, but if there is a vehicle in front of you, the speed may decrease to maintain the distance to the vehicle ahead. If the vehicle ahead accelerates, your vehicle will travel at a steady cruising speed after accelerating to the set speed.



### Information

- If your vehicle speed is between 0-20 mph (0-30 km/h) when you press the Driving Assist button, the Smart Cruise Control speed will be set to 20 mph (30 km/h).
- If the driver shifts into a lower gear, the driving speed may not reach the set speed.

### Setting vehicle distance

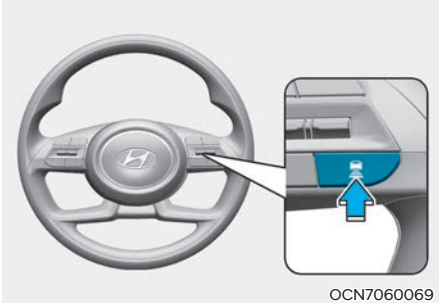

Each time the button is pressed, the vehicle distance changes as follows:

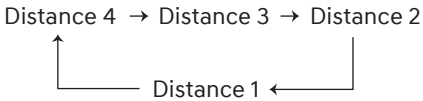

#### **i** Information

- If you drive at 56 mph (90 km/h), the distance is maintained as follows:
  - Distance 4 - approximately 172 ft. (52.5 m)
  - Distance 3 - approximately 130 ft. (40 m)
  - Distance 2 - approximately 106 ft. (32.5 m)
  - Distance 1 - approximately 82 ft. (25 m)
- The distance is set to the last set distance when the engine is restarted, or when the system was temporarily canceled.

### Increasing set speed

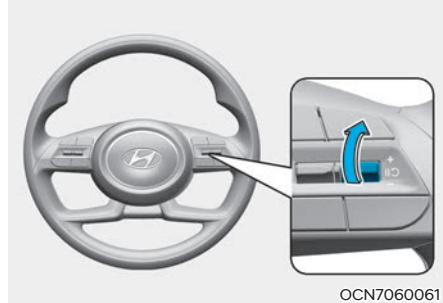

- Push the + switch up and release it immediately. The set speed will increase by 1 mph (1 km/h) each time the switch is operated in this manner.
- Push the + switch up and hold it while monitoring the set speed on the cluster. The set speed will increase by 5 mph or 10 km/h each time the switch is operated in this manner. Release the switch when the desired speed is shown, and the vehicle will accelerate to that speed. You can set the speed to 100 mph (160 km/h).

#### **⚠** WARNING

Check the driving condition before using the + switch. Driving speed may sharply increase when you push up and hold the + switch.

### Decreasing set speed

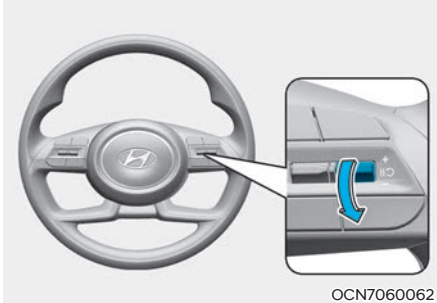

- Push the - switch down and release it immediately. The set speed will decrease by 1 mph (1 km/h) each time the switch is operated in this manner.
- Push the - switch down and hold it while monitoring the set speed on the cluster. The set speed will decrease by 5 mph or 10 km/h each time the switch is operated in this manner. Release the switch at the speed you want to maintain. You can set the speed to 20 mph (30 km/h).

### To temporarily cancel Smart Cruise Control

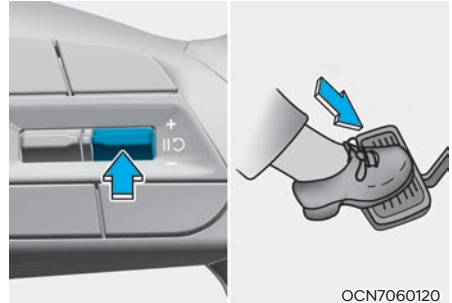

Press the **||** switch or depress the brake pedal to temporarily cancel Smart Cruise Control.

### To resume Smart Cruise Control

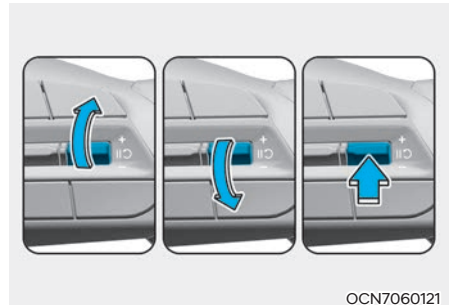



To resume Smart Cruise Control after the system was canceled, push the +, - or **||** switch.

If you push the + switch up or - switch down, vehicle speed will be set to the current speed on the cluster.

If you push the **||** switch, vehicle speed will resume to the preset speed.

**⚠ WARNING**

Check the driving condition before using the  switch. Driving speed may sharply increase or decrease when you press the  switch.

**To turn off Smart Cruise Control**

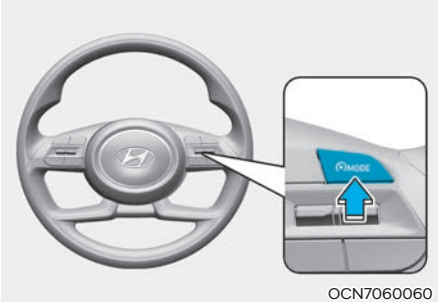

To turn Smart Cruise Control off, press the Driving Assist () button

**i Information**

If your vehicle is equipped with Manual Speed Limit Assist, press and hold the Driving Assist () button to turn off Smart Cruise Control. However Manual Speed Limit Assist will turn on.

**⚠ CAUTION**

Do not use the switches and buttons at the same time. Smart Cruise Control may not operate properly.

**Smart Cruise Control display and control**

You can see the status of the Smart Cruise Control operation in the Driving Assist view on the cluster. Refer to "Cluster Display" section in chapter 4.

Smart Cruise Control will be displayed as below depending on the status of the function.



- When operating
  - (1) Whether there is a vehicle ahead and the selected distance level
  - (2) Set speed
  - (3) Whether there is a vehicle ahead and the target vehicle distance

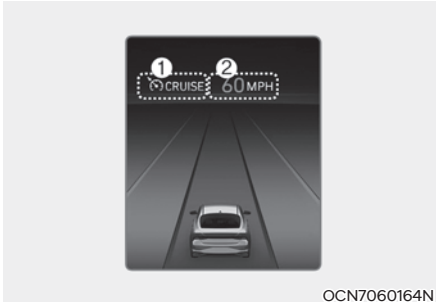

- When temporarily canceled
- (1) Your vehicle (grey)
  - (2) Previous set speed (grey)

### **i** Information

- The distance of the front vehicle on the cluster is displayed according to the actual distance between your vehicle and the vehicle ahead.
- The target distance may vary according to the vehicle speed and the set distance level. If vehicle speed is low, even though the vehicle distance have changed, the change of the target vehicle distance may be small.
- The images and colors in the instrument cluster may differ depending on the cluster type or theme selected from the instrument cluster.

### To temporarily accelerate

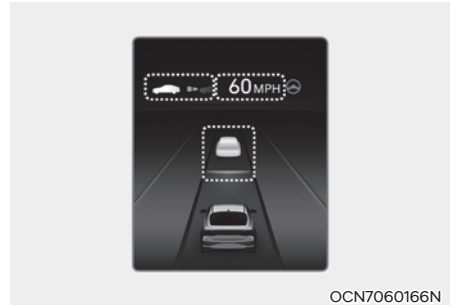

If you want to speed up temporarily when Smart Cruise Control is on, depress the accelerator pedal. While the speed is increasing, the set speed, distance level and target distance will blink on the cluster.

### **!** WARNING

- Be careful when accelerating temporarily, because the speed and distance is not controlled automatically even if there is a vehicle in front of you.
- Always maintain a safe distance from the vehicles ahead and adjust your vehicle speed depending on the road conditions.

### Temporarily cancelling Smart Cruise Control

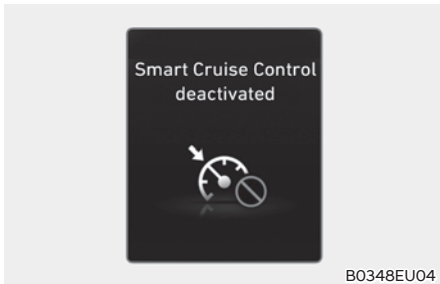

Smart Cruise Control will be temporarily canceled automatically when:

- The vehicle speed is above 106 mph (170 km/h)
- The vehicle is stopped for a certain period of time
- The accelerator pedal is continuously depressed for a certain period of time
- The conditions for the Smart Cruise Control to operate is not satisfied

If the function is temporarily canceled automatically, the 'Smart Cruise Control deactivated' warning message will appear on the cluster, and an audible warning will sound to warn the driver.

#### Information

If the Smart Cruise Control is temporarily canceled while the vehicle is at a standstill with the system operating, EPB (Electronic Parking Brake) maybe applied.

#### WARNING

When the function is temporarily canceled, distance with the front vehicle will not be maintained. Always have your eyes on the road while driving, and if necessary, depress the brake pedal to reduce your driving speed in order to maintain a safe distance.

### Smart Cruise Control conditions not satisfied

If the Driving Assist () button, the +/--switch, or the button is pushed when Smart Cruise Control's operating conditions are not met, the 'Smart Cruise Control conditions not met' message appears on the instrument cluster, and an audible warning sounds.

### In traffic situation



In traffic, your vehicle will stop if the vehicle ahead of you stops. Also, if the vehicle ahead of you starts moving, your vehicle will start as well. In addition, after the vehicle has stopped and a certain time have passed, the 'Use switch or pedal to accelerate' message will appear on the cluster. Depress the accelerator pedal or push the + switch, - switch or  switch to start driving.

#### WARNING

While the message is displayed on the cluster, if there is no vehicle in front or the vehicle is far away from you, and the + switch, - switch or  switch is pushed, Smart Cruise Control will automatically cancel and EPB will be applied. However, if the accelerator pedal is depressed, EPB will not be applied even though the system is canceled. Always pay attention to the road condition ahead.

### Warning road conditions ahead



In the following situation, the 'Watch for surrounding vehicles' warning message will appear on the cluster, and an audible warning will sound to warn the driver of road conditions ahead.

- The vehicle in front disappears when Smart Cruise Control is maintaining the distance with the vehicle ahead while driving below a certain speed.

#### **WARNING**

Always pay attention to vehicles or objects that may suddenly appear in front of you, and if necessary, depress the brake pedal to reduce your driving speed in order to maintain a safe distance.

### Collision Warning



While Smart Cruise Control is operating, when the collision risk with the vehicle ahead is high, the 'Collision Warning' warning message will appear on the cluster, and an audible warning will sound and the steering wheel will vibrate to warn the driver. Always have your eyes on the road while driving, and if necessary, depress the brake pedal to reduce your driving speed in order to maintain a safe distance.

#### **WARNING**

In the following situations, Smart Cruise Control may not warn the driver of a collision.

- The distance from the front vehicle is near, or the vehicle speed of the front vehicle is faster or similar to your vehicle
- The speed of the front vehicle is very slow or is at a standstill
- The accelerator pedal is depressed right after Smart Cruise Control is turned on



## **WARNING**

Take the following precautions when using Smart Cruise Control:

- Smart Cruise Control does not substitute for proper and safe driving. It is the responsibility of the driver to always check the speed and distance to the vehicle ahead.
- Smart Cruise Control may not recognize unexpected and sudden situations or complex driving situations, so always pay attention to driving conditions and control your vehicle speed.
- Keep Smart Cruise Control off when the system is not in use to avoid inadvertently setting a speed.
- Do not open the door or leave the vehicle when Smart Cruise Control is operating, even if the vehicle is stopped.
- Always be aware of the selected speed and vehicle distance.
- Keep a safe distance according to road conditions and vehicle speed. If the vehicle distance is too close during high-speed driving, a serious collision may result.
- When maintaining distance with the vehicle ahead, if the front vehicle disappears, the system may suddenly accelerate to the set speed. Always be aware of unexpected and sudden situations from occurring.
- Vehicle speed may decrease on an upward slope and increase on a downward slope.
- Always be aware of situations such as when a vehicle cuts in suddenly.
- When you are towing a trailer or another vehicle, have Smart Cruise Control turned off due to safety reasons.
- Turn off Smart Cruise Control when your vehicle is being towed.
- Smart Cruise Control may not operate properly if interfered by strong electromagnetic waves.
- Smart Cruise Control may not detect an obstacle in front and lead to a collision. Always look ahead cautiously to prevent unexpected and sudden situations from occurring.
- Vehicles moving in front of you with a frequent lane change may cause a delay in the system's reaction or may cause the system to react to a vehicle actually in an adjacent lane. Always drive cautiously to prevent unexpected and sudden situations from occurring.
- Always be aware of the surroundings and drive safely, even though a warning message does not appear or an audible warning does not sound.
- If any other system's warning message is displayed or warning sound is generated, Smart Cruise Control warning message may not be displayed and warning sound may not be generated.
- You may not hear the warning sound of Forward Collision-Avoidance Assist if the surrounding is noisy.
- The vehicle manufacturer is not responsible for any traffic violation or accidents caused by the driver.
- Always set the vehicle speed under the speed limit in your area.

## **i** Information

- Smart Cruise Control may not operate for 15 seconds after the vehicle is started or the front view camera or front radar is area.
- You may hear a sound when the brake is controlled by Smart Cruise Control.

## Smart Cruise Control Malfunction and Limitations

### Smart Cruise Control malfunction



When Smart Cruise Control is not working properly, the 'Check Smart Cruise Control system' warning message will appear, and the  warning light will illuminate on the cluster. Have the vehicle inspected by an authorized HYUNDAI dealer.

### Smart Cruise Control disabled

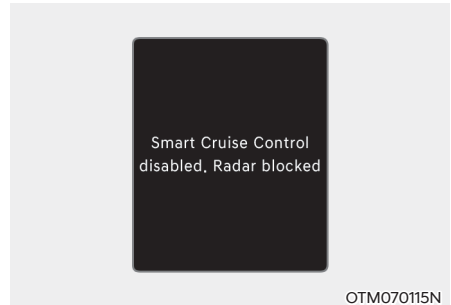

When the front radar cover or sensor is covered with snow, rain, or foreign material, it can reduce the detecting performance and temporarily limit or disable Smart Cruise Control.

If this occurs the 'Smart Cruise Control disabled. Radar blocked' warning message will appear for a certain period of time on the cluster.

The system will operate properly when snow, rain or foreign material is removed.

## WARNING

- **Even though the warning message does not appear on the cluster, Smart Cruise Control may not properly operate.**
- **Smart Cruise Control may not properly operate in an area (for example, open terrain), where any objects are not detected after turning ON the engine.**

### ***Limitations of Smart Cruise Control***

Smart Cruise Control may not operate properly, or the system may operate unexpectedly under the following circumstances:

- The detecting sensor or the surroundings are contaminated or damaged
- Washer fluid is continuously sprayed, or the wiper is on
- The camera lens is contaminated due to tinted, filmed or coated windshield, damaged glass, or sticky foreign material (sticker, bug, etc.) on the glass
- Moisture is not removed or frozen on the windshield
- The field of view of the front view camera is obstructed by sun glare
- Street light or light from an oncoming vehicle is reflected on the wet road surface, such as a puddle on the road
- The temperature around the frontview camera is high or low due to surrounding environment
- An object is placed on the dashboard
- The surrounding is very bright
- The surrounding is very dark, such as in a tunnel, etc.
- The brightness changes suddenly, for example when entering or exiting a tunnel
- The brightness outside is low, and the headlights are not on or are not bright
- Driving in heavy rain or snow, or thick fog
- Driving through steam, smoke or shadow
- Only part of the vehicle is detected
- The vehicle in front has no tail lights, tail lights are located unusually, etc.
- The brightness outside is low, and the tail lamps are not on or are not bright
- The rear of the front vehicle is small or does not look normal (for example, tilted, overturned, etc.)
- The front vehicle's ground clearance is low or high
- A vehicle suddenly cuts in front
- Your vehicle is being towed
- Driving through a tunnel or iron bridge
- Driving near areas containing metal substances, such as a construction zone, railroad, etc.
- An object reflecting off the front radar such as a guardrail, nearby vehicle, etc.
- The bumper around the front radar is impacted, damaged or the front radar is out of position
- The temperature around the frontview camera is high or low due to surrounding environment
- Driving in vast areas where there are few vehicles or structures (for example, desert, meadow, suburb, etc.)
- The vehicle in front is made of material that does not reflect on the front radar
- Driving near a highway interchange or tollgate
- Driving on a slippery surface due to snow, water puddle, ice, etc.
- Driving on a curved road
- The vehicle in front is detected late
- The vehicle in front is suddenly blocked by an obstacle
- The vehicle in front suddenly changes lane or suddenly reduces speed

- The vehicle in front is bent out of shape
- The front vehicle's speed is fast or slow
- With a vehicle in front, your vehicle changes lane at low speed
- The vehicle in front is covered with snow
- Unstable driving
- You are on a roundabout and the vehicle in front is not detected
- You are continuously driving in a circle
- Driving in a parking lot
- Driving through a construction area, unpaved road, partial paved road, uneven road, speed bumps, etc.
- Driving on an incline road, curved road, etc.
- Driving through a roadside with trees or streetlights
- The adverse road conditions cause excessive vehicle vibrations while driving
- Your vehicle height is low or high due to heavy loads, abnormal tire pressure, etc.
- Driving through a narrow road where trees or grass are overgrown
- There is interference by electromagnetic waves, such as driving in an area with strong radio waves or electrical noise

- Driving on a curved road

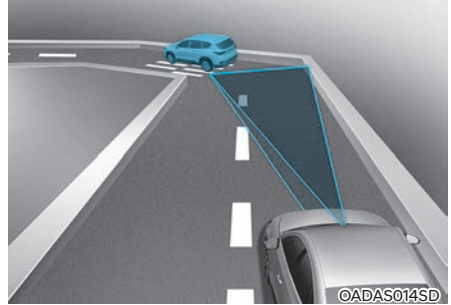

On curves, Smart Cruise Control may not detect a vehicle in the same lane, and may accelerate to the set speed. Also, vehicle speed may rapidly decrease when the vehicle ahead is detected suddenly.

Select the appropriate set speed on curves and apply the brake pedal or accelerator pedal according to the road and driving conditions ahead.

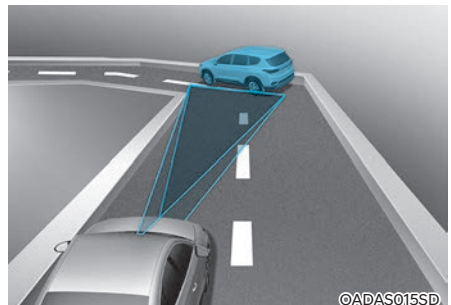

Your vehicle speed can be reduced due to a vehicle in the adjacent lane.

Apply the accelerator pedal and select the appropriate set speed. Check to be sure that the road conditions permit safe operation of Smart Cruise Control.

- Driving on an inclined road

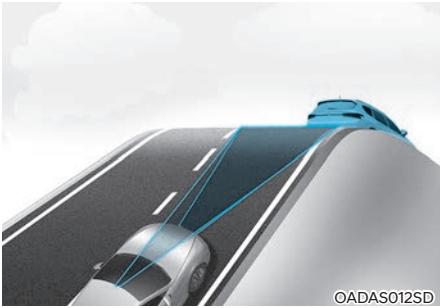

During uphill or downhill driving, Smart Cruise Control may not detect a moving vehicle in your lane, and cause your vehicle to accelerate to the set speed. Also, vehicle speed will rapidly decrease when the vehicle ahead is detected suddenly.

Select the appropriate set speed on inclines and apply the brake pedal or accelerator pedal according to the road and driving conditions ahead.

- Changing lanes



[A] : Your vehicle, [B] : Lane changing vehicle

When a vehicle moves into your lane from an adjacent lane, it cannot be detected by the sensor until it is in the sensor's detection range. Smart Cruise Control may not immediately detect the vehicle when the vehicle changes lanes abruptly. In this case, you must maintain a safe braking distance, and if necessary, depress the brake pedal to reduce your driving speed in order to maintain a safe distance.

- Situations when detecting are limited

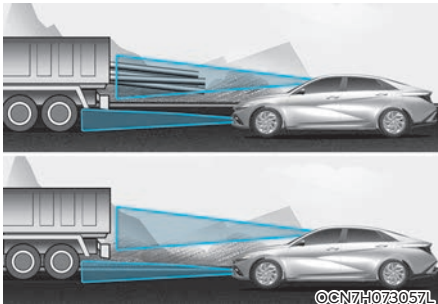
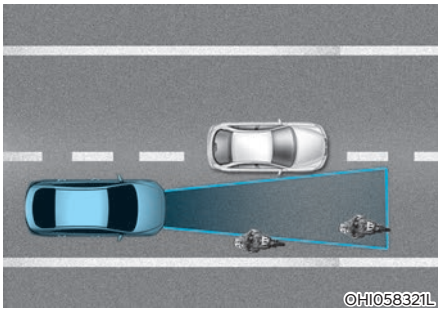

In the following cases, the vehicle in front cannot be detected by the sensor:

- Vehicles with higher ground clearance or vehicles carrying loads that stick out of the back of the vehicle
- Vehicles that has the front lifted due to heavy loads
- You are steering your vehicle
- Driving on narrow or sharply curved roads

Adjust your vehicle speed by depressing the brake pedal according to the road and driving conditions ahead.

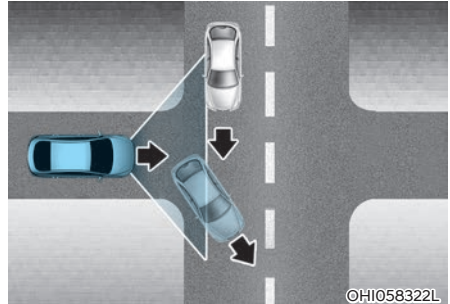

- When a vehicle ahead disappears at an intersection, your vehicle may accelerate.

Always pay attention to road and driving conditions while driving.

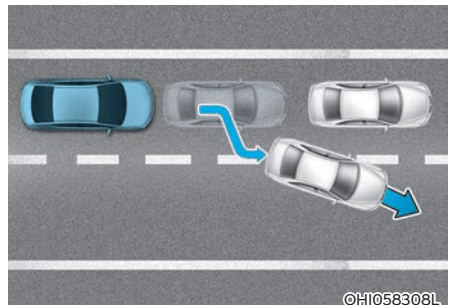

- When a vehicle in front of you merges out of the lane, Smart Cruise Control may not immediately detect the new vehicle that is now in front of you.

Always pay attention to road and driving conditions while driving.

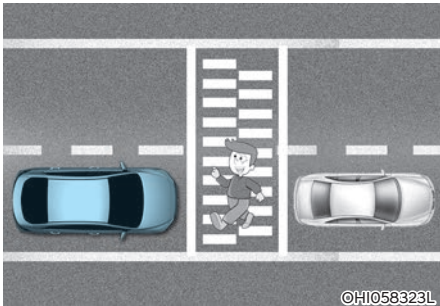

- Always look out for pedestrians when your vehicle is maintaining a distance with the vehicle ahead.

### **i** Information

This device complies with Part 15 of the FCC rules.

Operation is subject to the following three conditions:

1. This device may not cause harmful interference, and
2. This device must accept any interference received, including interference that may cause undesired operation.
3. Changes or modifications not expressly approved by the party responsible for compliance could void the user's authority to operate the device.

### **i** Information

Radio frequency radiation exposure information:

This equipment complies with FCC radiation exposure limits set forth for an uncontrolled environment.

This equipment should be installed and operated with minimum distance of 8 in. (20 cm) between the radiator (antenna) and your body.

This transmitter must not be co-located or operating in conjunction with any other antenna or transmitter.

## NAVIGATION-BASED SMART CRUISE CONTROL (NSCC) (IF EQUIPPED)

Navigation-based Smart Cruise Control can help drive at a certain speed according to the road conditions when driving on highways by using road information from the navigation system while Smart Cruise Control is operating.

### **i** Information

- **Navigation-based Smart Cruise Control is available only on controlled access road of certain highways.**
  - \* **Controlled access road indicates roads with limited entrances and exits that allow uninterrupted high speed traffic flow. Only passenger cars and motorcycles are allowed on controlled access roads.**

Available highway (Controlled access road)	
USA	Select Interstate Highway and U.S. (Federal) and State Highways
Canada	Select Provincial and Territorial Highways

- **Additional highways may be expanded by future navigation updates.**

### **i** Information

Navigation-based Smart Cruise Control operates on main roads of highways, and does not operate on interchanges or junctions.

### Highway Curve Zone Auto Slowdown

If vehicle speed is high, Highway Curve Zone Auto Slowdown function can temporarily decelerate your vehicle or limit acceleration to help you drive on a curve based on the curve information from the navigation.

## Navigation-based Smart Cruise Control Settings

### Highway Auto Speed Change

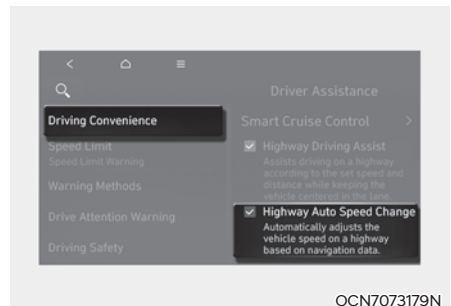

With the ignition switch ON, go to **Settings > Vehicle > Driver Assistance > Driving Convenience > Highway Auto Speed Change** from the Settings menu to turn on Navigation-based Smart Cruise Control and deselect to turn off the function.

### **i** Information

When there is a problem with Navigation-based Smart Cruise Control, the function cannot be set from the Settings menu.

### Navigation-based Smart Cruise Control Operation

Navigation-based Smart Cruise Control may be available when:

- Highway Auto Speed Change is selected from the settings menu.
- Smart Cruise Control is operating.
- Driving on main roads of highways (or motorways).

#### **i** Information

For more details on how to operate Smart Cruise Control, refer to “Smart Cruise Control (SCC)” section in chapter 7.

#### **Navigation-based Smart Cruise Control display and control**

The following may appear on the instrument cluster:

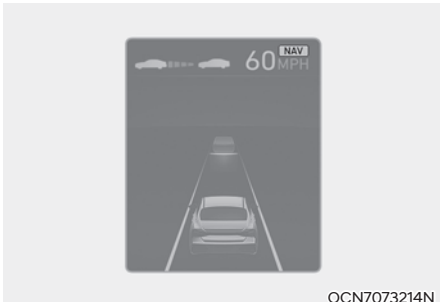

- **Navigation-based Smart Cruise Control standby**  
If the operating conditions are satisfied, the green **NAV** indicator light illuminates.
- **Navigation-based Smart Cruise Control operating**  
While the speed is being controlled, the green **NAV** indicator light blinks.

#### **Temporarily canceled or interrupted by the driver**

If Navigation-based Smart Cruise Control cannot control the vehicle, such as when Smart Cruise Control is temporarily canceled or the navigation system is searching for a route, the grey **NAV** indicator light illuminates.

When the driver depresses the accelerator pedal, the white **NAV** indicator light blinks.

#### **! WARNING**



The "Drive carefully" warning message appears if Navigation-based Smart Cruise Control is not able to slow down your vehicle.



## Information

The images and colors in the instrument cluster may differ depending on the cluster type or theme selected from the settings menu.

### **Highway Curve Zone Auto Slowdown**

- Depending on the curve ahead on the highway, the vehicle will decelerate, and after passing the curve, the vehicle will accelerate to Smart Cruise Control set speed.
- Vehicle deceleration time may differ depending on the vehicle speed and the degree of the curve on the road. The higher the driving speed, deceleration will start faster.

### **Limitations of Navigation-Based Smart Cruise Control**

Navigation-based Smart Cruise Control may not operate properly under the following circumstances:

- The navigation is not working properly
- Speed limit and road information in the navigation is not updated
- The map information and the actual road is different because of real-time GPS data or map information error
- The navigation searches for a route while driving
- GPS signals are blocked in areas such as a tunnel
- The navigation is updated while driving
- Map information is not transmitted due to infotainment system's abnormal operation
- A road that divides into two or more roads and joins again
- The driver goes off course the route set in the navigation
- The route to the destination is changed or canceled by resetting the navigation
- The vehicle enters a service station or rest area
- The speed limit of some sections changes according to the road situations
- Android Auto or Car Play is operating
- The navigation cannot detect the current vehicle position (for example, elevated roads including overpass adjacent to general roads or nearby roads exist in a parallel way)
- The navigation is being updated while driving
- The navigation is being restarted while driving
- There is bad weather, such as heavy rain, heavy snow, etc.
- Driving on a road under construction
- Driving on a road that is controlled
- Driving on a road that is sharply curved
- Driving on roads with intersections, roundabouts, straight entrances and exits, etc.

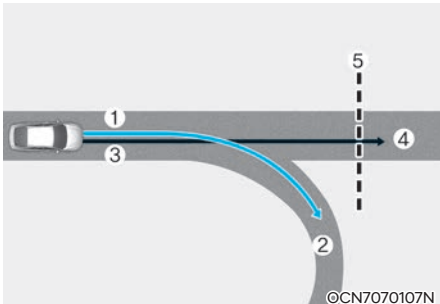

[1] : Set route, [2] : Branch line, [3] : Driving route, [4] : Main road, [5] : Curved road section

- When there is a difference between the navigation set route (branch line) and the driving route (main road), Highway Curve Zone Auto Slowdown function may not operate until the driving route is recognized as the main road.
- When the vehicle's driving route is recognized as the main road by maintaining the main road instead of the navigation set route, Highway Curve Zone Auto Slowdown function will operate. Depending on the distance to the curve and the current vehicle speed, vehicle deceleration may not be sufficient or may decelerate rapidly.

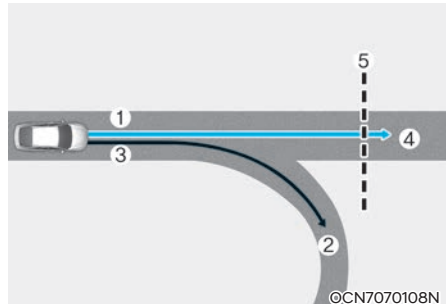

[1] : Set route, [2] : Branch line, [3] : Driving route, [4] : Main road, [5] : Curved road section

- When there is a difference between the navigation route (main road) and the driving route (branch line), Highway Curve Zone Auto Slowdown function will operate based on the curve information on the main road.
- When it is judged that you are driving out of the route by entering the highway interchange or junction, Highway Curve Zone Auto Slowdown function will not operate.

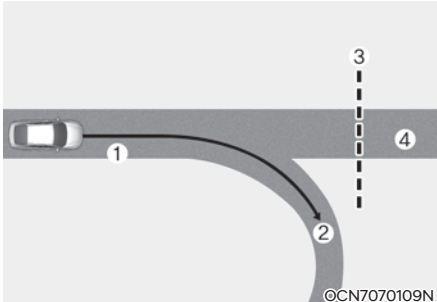

[1] : Driving route, [2] : Branch line,  
[3] : Curved road section, [4] : Main road

- If there is no destination set on the navigation, Highway Curve Zone Auto Slowdown function will operate based on the curve information on the main road.
- Even if you depart from the main road, Highway Curve Zone Auto Slowdown function may temporarily operate due to navigation information of the highway curve section.



## WARNING

- **Navigation-based Smart Cruise Control is not a substitute for safe driving practices, but a convenience function. Always have your eyes on the road, and it is the responsibility of the driver to avoid violating traffic laws.**
- **The navigation's speed limit information may differ from the actual speed limit information on the road. It is the driver's responsibility to check the speed limit on the actual driving road or lane.**
- **Navigation-based Smart Cruise Control will automatically be canceled when you leave the highway main road. Always pay attention to road and driving conditions while driving.**
- **Navigation-based Smart Cruise Control may not operate due to the existence of leading vehicles and the driving conditions of the vehicle. Always pay attention to road and driving conditions while driving.**
- **When you are towing a trailer or another vehicle, have Navigation-based Smart Cruise Control turned off due to safety reasons.**

- After you pass through a tollgate on a highway, Navigation-based Smart Cruise Control will operate based on the first lane. If you enter one of the other lanes, the system may not operate properly.
- The vehicle will accelerate if the driver depresses the accelerator pedal while Navigation-based Smart Cruise Control is operating, and the function will not decelerate the vehicle. However, if the accelerator pedal is depressed insufficiently, the vehicle may decelerate.
- If the driver accelerates and releases the accelerator pedal while Navigation-based Smart Cruise Control is operating, the vehicle may not decelerate sufficiently or may rapidly decelerate to a safe speed.
- If the curve is too large or too small, Navigation-based Smart Cruise Control may not operate.

### **i** Information

- A time gap could occur between the navigation's guidance and when Navigation-based Smart Cruise Control operation starts and ends.
- The speed information on the cluster and navigation may differ.
- Even if you are driving at a speed lower than Smart Cruise Control set speed, acceleration may be limited by the curve sections ahead.
- If Navigation-based Smart Cruise Control is operating while leaving the main road to enter an interchange, junction, rest area, etc., the system may operate for a certain period of time.
- Deceleration by Navigation-based Smart Cruise Control may feel it is not sufficient due to road conditions such as uneven road surfaces, narrow lanes, etc.

### **i** Information

This device complies with Part 15 of the FCC rules.

Operation is subject to the following three conditions:

1. This device may not cause harmful interference, and
2. This device must accept any interference received, including interference that may cause undesired operation.
3. Changes or modifications not expressly approved by the party responsible for compliance could void the user's authority to operate the device.

### **i** Information

Radio frequency radiation exposure information:

This equipment complies with FCC radiation exposure limits set forth for an uncontrolled environment.

This equipment should be installed and operated with minimum distance of 8 in. (20 cm) between the radiator (antenna) and your body.

This transmitter must not be co-located or operating in conjunction with any other antenna or transmitter.

## LANE FOLLOWING ASSIST (LFA)

Lane Following Assist is designed to help detect lane markings and/or vehicles on the road, and assists the driver's steering to help center the vehicle in the lane.

### Detecting sensor



[1] : Front view camera

The front view camera is used as a detecting sensor to help detect lane markings and vehicles in front.

Refer to the picture above for the detailed location of the detecting sensor.



### CAUTION

For more details on the precautions of the front view camera, refer to “Forward Collision-Avoidance Assist (FCA)” section in chapter 7.

## Lane Following Assist Settings

### Warning Methods

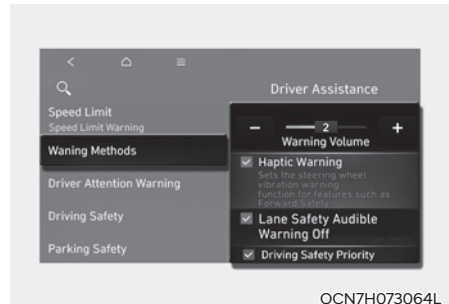

The Warning Methods can be set with the vehicle on. Select **User Settings > Driver Assistance > Warning Methods** from the settings menu in the instrument cluster or **Setup > Vehicle > Driver Assistance > Warning Methods** from the settings menu in the infotainment system to change the following settings:

- **Warning Volume:** Adjusts the volume of the warning sound. If you turn off the **Warning Volume**, for your safety, the function may warn you with a low volume.
- **Driving Safety Priority:** Lowers all other audio volumes when the Driving Safety system sounds a warning.

### Information

- If you change the **Warning Methods**, the **Warning Methods** of other **Driver Assistance** systems may change.
- If the engine is restarted, **Warning Methods** will maintain the last setting.
- The setting menu may not exist based on vehicle specification.

### Lane Following Assist Operation Turning Lane Following Assist On/ Off

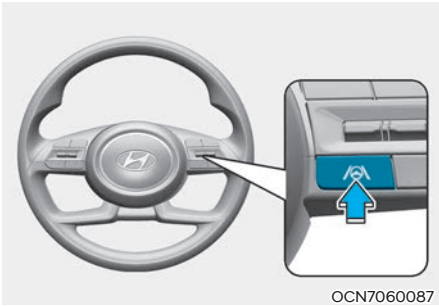

With the ignition switch ON, press the Lane Driving Assist button on the steering wheel to turn on Lane Following Assist. The white or green  indicator light illuminates on the instrument cluster.

Press the button again to turn off the function.

### Lane Following Assist



If the vehicle ahead and/or both lane markings are detected and your vehicle speed is below 120 mph (200 km/h), the green  indicator light will illuminate on the cluster, and the function will help center the vehicle in the lane by assisting the steering wheel.



### CAUTION

**When the steering wheel is not assisted, the green  indicator light will blink and change to white.**

### Hands-off warning



If the driver takes their hands off the steering wheel for several seconds, the 'Place hands on the steering wheel' warning message will appear and an audible warning will sound in stages.

First stage : Warning message

Second stage : Warning message (red steering wheel) and audible warning

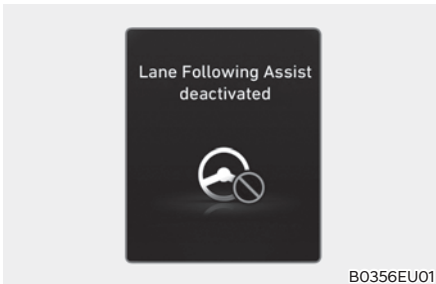

If you do not have your hands on the steering wheel after the hands-off warning, the "Lane Following Assist deactivated" warning message may appear and Lane Following Assist is automatically canceled.



### WARNING

- Lane Following Assist does not operate at all times. It is the responsibility of the driver to safely steer the vehicle and to maintain the vehicle in its lane.
- The hands-off warning message may appear late depending on road conditions. Always have your hands on the steering wheel while driving.
- If the steering wheel is held very lightly the hands-off warning message may appear because the system may not recognize that the driver has their hands on the steering wheel.
- If you attach objects to the steering wheel, the hands-off warning may not work properly.



### Information

- You may change settings from the instrument cluster (User Settings) or infotainment system (Vehicle Settings), whichever option that is provided with your vehicle. For more details, see "User Settings" section in chapter 4, or "Vehicle Settings" section in supplied Infotainment Manual.
- When both lane markings are detected, the lane lines on the cluster will change from grey to white.

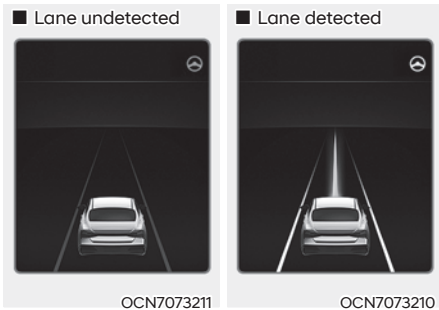

- If lane markings are not detected, steering wheel control by Lane Following Assist can be limited depending on whether a vehicle is in front or the driving conditions of the vehicle.
- Even though the steering is assisted by Lane Following Assist, the driver may control the steering wheel.
- The steering wheel may feel heavier or lighter when the steering wheel is assisted by Lane Following Assist than when it is not.

### Lane Following Assist Malfunction and Limitations

#### Lane Following Assist malfunction

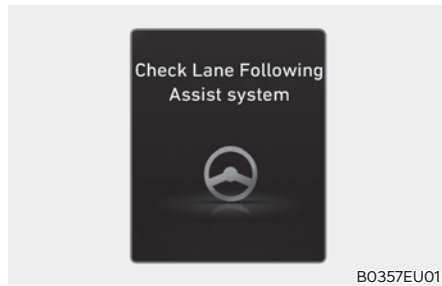

When Lane Following Assist is not working properly, the "Check Lane Following Assist system" message may appear, and the  warning light may illuminate on the instrument cluster. Have the vehicle inspected by an authorized HYUNDAI dealer.

#### Limitations of Lane Following Assist

For more details on function limitations, refer to "Lane Keeping Assist (LKA)" section in chapter 7.

#### WARNING

**Loading in excess of the maximum load allowance or concentrated loading at one point in the cargo compartment can reduce the vehicle's driving stability, which can in turn reduce the effectiveness of Lane Following Assist.**

## HIGHWAY DRIVING ASSIST (HDA) (IF EQUIPPED)

Highway Driving Assist is designed to help detect vehicles and lanes ahead, and help maintain distance from the vehicle ahead, maintain the set speed, and help center the vehicle in the lane while driving on the highway.

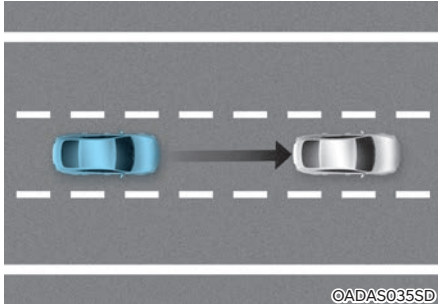

### **i** Information

- Highway Driving Assist is available only on controlled access road of certain highways.
  - \* Controlled access road indicates roads with limited entrances and exits that allow uninterrupted high speed traffic flow. Only passenger cars and are allowed on controlled access roads.

Available highway (Controlled access road)	
USA	Select Interstate Highway and U.S. (Federal) and State Highways
Canada	Select Provincial and Territorial Highways

- Additional highways may be expanded by future navigation updates.

### **i** Information

Highway Driving Assist operates on main roads of highways (or motorways), and does not operate on interchanges or junctions.

### Detecting sensor



[1] : Front view camera,  
[2] : Front radar

Refer to the picture above for the detailed location of the detecting sensors.

### **!** CAUTION

For more details on the precautions of the detecting sensors, refer to “Forward Collision-Avoidance Assist (FCA)” section in chapter 7.

## Highway Driving Assist Settings

### Highway Driving Assist

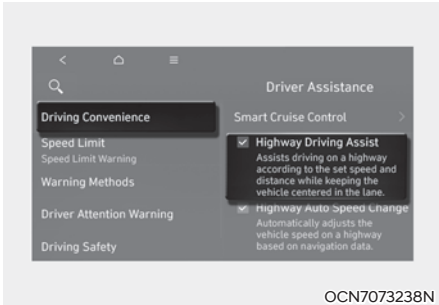

OCN7073238N

With the ignition switch ON, go to **User Settings > Driver Assistance > Driving Convenience** from the settings menu in the instrument cluster or **Settings > Vehicle > Driver Assistance > Driving Convenience** from the settings menu in the infotainment system to set whether to use each function.

- If Highway Driving Assist is selected, the function helps maintain distance from the vehicle ahead, maintain the set speed, and help center your vehicle in the lane while driving on the highway.

### **i** Information

- When there is a problem with Highway Driving Assist, the function cannot be set from the Settings menu. Have the vehicle inspected by an authorized HYUNDAI dealer.
- If the engine is restarted, the function(s) will maintain the last setting.

### **!** WARNING

For your safety, only change the Settings after parking the vehicle at a safe location.

## Warning Methods



OCN7H073064L

The Warning Methods can be set with the vehicle on. Select **User Settings > Driver Assistance > Warning Methods** from the settings menu in the instrument cluster or **Setup > Vehicle > Driver Assistance > Warning Methods** from the settings menu in the infotainment system to change the following settings:

- **Warning Volume:** Adjusts the volume of the warning sound. If you turn off the **Warning Volume**, for your safety, the function may warn you with a low volume.
- **Driving Safety Priority:** Lowers all other audio volumes when the Driving Safety system sounds a warning.

### **i** Information

- If you change the Warning Methods, the Warning Methods of other Driver Assistance systems may change.
- If the engine is restarted, Warning Methods will maintain the last setting.
- The setting menu may not exist based on vehicle specification.

## Highway Driving Assist Operation

### Highway Driving Assist display

You can see the status of the Highway Driving Assist operation in the Driving Assist mode on the cluster. Refer to "Cluster Display Modes" section in chapter 4.

Highway Driving Assist will be displayed as below depending on the status of the system.

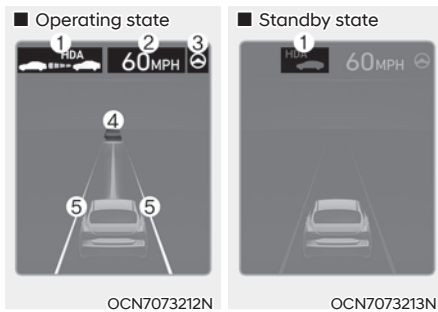

- (1) Indicates if there is a vehicle ahead and the selected distance level appears.

Highway Driving Assist indicator (HDA)

- Green HDA : Operating state
  - Grey HDA : Standby state
  - White HDA : Accelerator depressed state
- (2) Set speed
- (3) Lane Following Assist indicator
- (4) Whether there is a vehicle ahead and the selected vehicle distance
- (5) Whether the lane is detected or not

### **i** Information

- For more information on Smart Cruise Control and Lane Following Assist, refer to the "Smart Cruise Control (SCC)" and "Lane Following Assist (LFA)" sections in this chapter.
- The images and colors in the instrument cluster may differ depending on the cluster type or theme selected from the settings menu.

### Highway Driving Assist operating

Highway Driving Assist operates when:

- You have pressed the Driving Assist button after entering or driving on controlled access roads.
- Entering or driving on controlled access roads with both Lane Following Assist and Smart Cruise Control operating.

### Restarting after stopping



When Highway Driving Assist is operating, your vehicle will stop if the vehicle ahead of you stops. Also, if the vehicle ahead of you starts moving within 30 seconds after the stop, your vehicle will start as well. In addition, after the vehicle has stopped and 30 seconds have passed, the 'Use switch or pedal to accelerate' message will appear on the cluster. Depress the accelerator pedal or push the + switch, - switch or  switch to start driving.

### Hands-off warning



If the driver takes their hands off the steering wheel for several seconds, the 'Place hands on the steering wheel' warning message will appear and an audible warning will sound in stages. First stage : Warning message  
Second stage : Warning message (red steering wheel) and audible warning

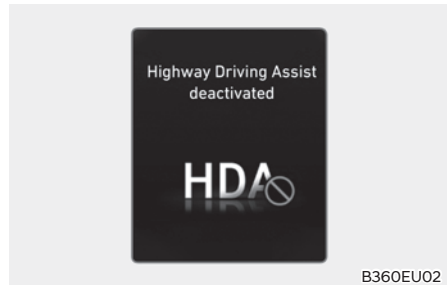

If the driver still does not have their hands on the steering wheel after the hands-off warning, the "Highway Driving Assist deactivated" warning message may appear and Highway Driving Assist is automatically canceled.

## Highway Driving Assist Malfunction and Limitations

### Highway Driving Assist malfunction

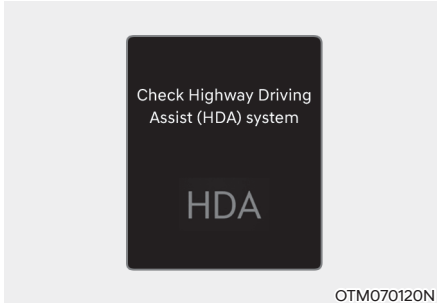

When Highway Driving Assist is not working properly, the 'Check Highway Driving Assist (HDA) system' warning message will appear, and the  warning light will illuminate on the cluster. Have the vehicle inspected by an authorized HYUNDAI dealer.



### WARNING

- The driver is responsible for controlling the vehicle for safe driving.
- Always have your hands on the steering wheel while driving.
- Highway Driving Assist is a supplemental function that assists the driver in driving the vehicle and is not a complete autonomous driving system. Always check road conditions, and if necessary, take appropriate actions to drive safely.
- Always have your eyes on the road, and it is the responsibility of the driver to avoid violating traffic laws. The vehicle manufacturer is not responsible for any traffic violation or accidents caused by the driver.
- Highway Driving Assist may not be able to recognize all traffic situations. Highway Driving Assist may not detect possible collisions due to limitations of the function. Always be aware of the limitations of the function. Obstacles (vehicles, motorcycles, bicycles, pedestrians, unspecified objects, structures, etc.) that may collide with a vehicle may not be detected.
- Highway Driving Assist will turn off automatically under the following situations:
  - Driving on roads that the system does not operate, such as a rest area, intersection, junction, etc.
  - The navigation does not operate properly such as when the navigation is being updated or restarted

- Highway Driving Assist may inadvertently operate or turn off depending on road conditions (navigation information) and surroundings.
- Lane Following Assist function may be temporarily disabled when the front view camera cannot detect lanes properly or the hands-off warning is on.
- You may not hear the warning sound of Highway Driving Assist if the surrounding is noisy.
- If the vehicle is driven at high speed above a certain speed at a curve, your vehicle may drive to one side or may depart from the driving lane.
- When you are towing a trailer or another vehicle, have Highway Driving Assist turned off due to safety reasons.
- The hands-off warning message may appear early or late depending on how the steering wheel is held or road conditions. Always have your hands on the steering wheel while driving.
- For your safety, please read the owner's manual before using the Highway Driving Assist.
- Highway Driving Assist will not operate when the engine is started, or when the detecting sensors or navigation is being initialized.

### **Limitations of Highway Driving Assist**

Highway Driving Assist may not operate properly, or may not operate under the following circumstances:

- The map information and the actual road is different because the navigation is not updated
- The map information and the actual road is different because of real-time GPS data or map information error
- The infotainment system is overloaded by simultaneously performing functions such as route search, video playback, voice recognition, etc.
- GPS signals are blocked in areas such as a tunnel
- The driver goes off course or the route to the destination is changed or canceled by resetting the navigation
- The vehicle enters a service station or rest area
- Android Auto or Car Play is operating
- The navigation cannot detect the current vehicle position (for example, elevated roads including overpass adjacent to general roads or nearby roads exist in a parallel way)

### **Information**

For more details on the limitations of the front view camera, front radar, front corner radar and rear corner radar, refer to “Forward Collision-Avoidance Assist (FCA)” section in chapter 7.

***i* Information**

This device complies with Part 15 of the FCC rules.

Operation is subject to the following three conditions:

1. This device may not cause harmful interference, and
2. This device must accept any interference received, including interference that may cause undesired operation.
3. Changes or modifications not expressly approved by the party responsible for compliance could void the user's authority to operate the device.

***i* Information**

Radio frequency radiation exposure information:

This equipment complies with FCC radiation exposure limits set forth for an uncontrolled environment.

This equipment should be installed and operated with minimum distance of 8 in. (20 cm) between the radiator (antenna) and your body.

This transmitter must not be co-located or operating in conjunction with any other antenna or transmitter.

## REAR VIEW MONITOR (RVM) (IF EQUIPPED)

Rear View Monitor displays the area behind your vehicle to help with safe parking.

### **i** Information

If the display audio is applied, the description of the rear view monitor may differ from the owner's manual.

In this case, check the setup and operation method of the rear view monitor by accessing the web manual with the QR code in the separately supplied simple manual.

### Detecting sensor



[1]: Wide-rear view camera

Refer to the picture above for the detailed location of the detecting sensor.

## Rear View Monitor Settings

### Warning Methods

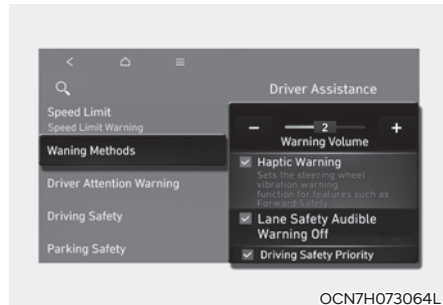

The Warning Methods can be set with the vehicle on. Select **User Settings > Driver Assistance > Warning Methods** from the settings menu in the instrument cluster or **Setup > Vehicle > Driver Assistance > Warning Methods** from the settings menu in the infotainment system to change the following settings:

- **Parking Safety Priority:** Lowers all other audio volumes when Rear View Monitor is active

### **i** Information

- If you change the Warning Methods, the Warning Methods of other Driver Assistance systems may change.
- If the engine is restarted, Warning Methods will maintain the last setting.
- The setting menu may not exist based on vehicle specification.

## Camera settings

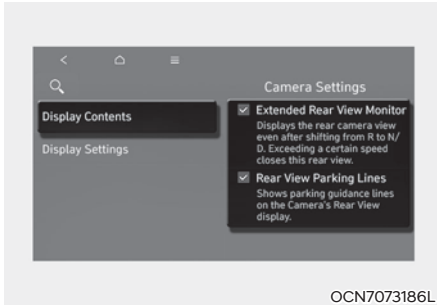

To change the settings of Rear View Monitor's Display Contents or Display Settings, press the setup icon (⚙️) on the screen while Rear View Monitor is operating, or go to **Settings > Vehicle > Driver Assistance > Parking Safety > Camera Settings** from the Settings menu in the infotainment system when the engine is on.

### Extended Rear View Monitor

Keeps displaying the rear view when shifting from R (Reverse) to N (Neutral) or D (Drive). When exceeding a certain speed, the rear view stops displaying.

### Rear View Parking Guide Lines

If Rear View Parking Lines (Rear view reference lines) is selected, the rear view parking guide lines and rear top view guide lines will be displayed at the left side of the infotainment system.

## Information

- **The horizontal guideline of the Rear View Parking Guidance shows the distance of 20 in (0.5 m), 40 in (1 m) and 91 in (2.3 m) from the vehicle.**
- **The horizontal guideline of the Rear Top View Parking Guidance shows the distance of 20 in (0.5 m) and 60 in (1.5 m) from the vehicle.**

## Rear View Monitor Operation

### Parking/View button



Press the Parking/View button (1) while the gear is in P (Park) to turn on Rear View Monitor.

### Rear view



Shift the gear to R (Reverse), the rear view will appear on the screen.

Press the Parking/View button (1) while the gear is in P (Park), the rear view will appear on the screen.

Touch the (🔒), the rear view will appear on the screen the infotainment system button (2) is pressed.

### Rear top view



When you touch the icon (📷), the top view is displayed on the screen and shows the distance from the vehicle in the back of your vehicle while parking.

### Extended Rear View Monitor

Extended Rear View Monitor function maintains showing the rear view when the gear is R (Reverse), N (Neutral) or D (Drive).

### Operating conditions

The gear is in P (Park), N (Neutral) or D (Drive), and vehicle speed is 6 mph (10 km/h) or less.

### Off conditions

- When vehicle speed is above 6 mph (10 km/h), the rear view will turn off.
- Shift the gear to P (Park), the rear view will turn off.
- Press the Parking/View button (1), the rear view will turn off.

## Rear View Monitor Malfunction and Limitations

### Rear View Monitor malfunction

When Rear View Monitor is not working properly, or the screen flickers, or the camera image does not display properly, have the vehicle inspected by an authorized HYUNDAI dealer.

### Limitations of the Rear View Monitor

When the vehicle is stopped for a long time in winter or when the vehicle is parked in an indoor parking lot, the exhaust fumes may temporarily blur the image.



### WARNING

- The rear view camera does not cover the complete area behind the vehicle. The driver should always check the rear area directly through the inside and side view mirror before parking or backing up.
- The image shown on the screen may differ from the actual distance of the object. Make sure to directly check the vehicle's surroundings for safety.
- Always keep the rear view camera lens clean. If the lens is covered with foreign material, it may adversely affect camera performance and Rear View Monitor may not operate properly. However, do not use chemical solvents such as strong detergents containing high alkaline or volatile organic solvents (gasoline, acetone etc.). This may damage the camera lens.

## REAR CROSS-TRAFFIC COLLISION-AVOIDANCE ASSIST (RCCA) (IF EQUIPPED)

Rear Cross-Traffic Collision-Avoidance Assist is designed to help detect vehicles approaching from the rear left and right side while your vehicle is reversing, and warn the driver that a collision is imminent with a warning message and an audible warning. Also, braking is assisted to help prevent a collision.

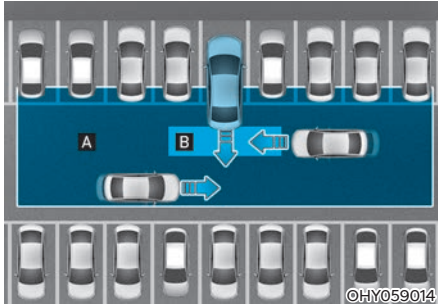

[A] : Rear Cross-Traffic Collision Warning operating range,

[B] : Rear Cross-Traffic Collision-Avoidance Assist operating range



### CAUTION

The time of warning may vary depending on the speed of the approaching vehicle.

### Detecting sensor



[1] : Rear corner radar

Refer to the picture above for the detailed location of the detecting sensors.



### CAUTION

For more details on the precautions of the rear corner radar, refer to “Blind-Spot Collision-Avoidance Assist (BCA)” section in chapter 7.

## Rear Cross-Traffic Collision-Avoidance Assist Settings

### Rear Cross-Traffic Safety

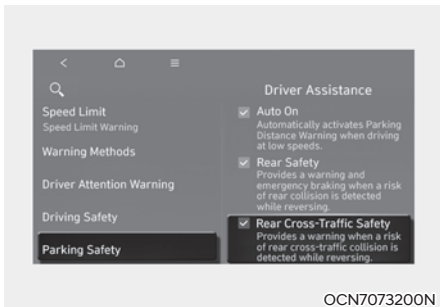

With the engine on, select **User settings > Driver Assistance > Parking Safety > Rear Cross-Traffic Safety** from the settings menu in the instrument cluster or **Settings > Vehicle > Parking Safety > Rear Cross-Traffic Safety** from the settings menu in the infotainment system to turn on Rear Cross-Traffic Collision-Avoidance Assist and deselect to turn off the function.

### WARNING

When the engine is restarted, Rear Cross-Traffic Safety system will always turn on. However, if 'Off' is selected after the engine is restarted, the driver should always be aware of the surroundings and drive safely.

## Warning Methods

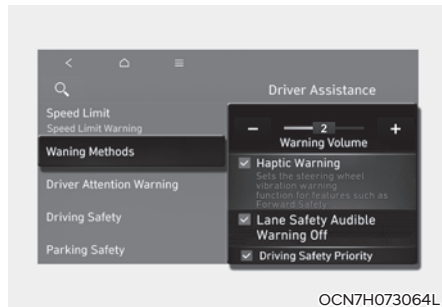

The Warning Methods can be set with the vehicle on. Select **User Settings > Driver Assistance > Warning Methods** from the settings menu in the instrument cluster or **Setup > Vehicle > Driver Assistance > Warning Methods** from the settings menu in the infotainment system to change the following settings:

- **Warning Volume:** Adjusts the volume of the warning sound.
- **Haptic Warning:** Activate the steering wheel vibration warning.

### Information

- If you change the Warning Methods, the Warning Methods of other Driver Assistance systems may change.
- The Warning Volume and Haptic Warning cannot be turned off at the same time. When one of the warning is turned off the other is activated.
- If the engine is restarted, Warning Methods will maintain the last setting.
- The setting menu may not exist based on vehicle specification.

## Rear Cross-Traffic Collision Avoidance Assesst Operation

Rear Cross-Traffic Safety system will warn and help control the vehicle depending on collision level: 'Collision Warning', 'Emergency Braking' and 'Stopping vehicle and ending brake control'.

### Collision Warning



©CN7073232



©CN7073194



©CN7073223

- To warn the driver of an approaching detected vehicle from the rear left/right side of your vehicle, the warning light on the side view mirror will blink and a warning will appear on the cluster. At the same time, an audible warning will sound and the steering wheel will vibrate. If the Rear View Monitor is operating, a warning will also appear on the infotainment system screen.
- The function will operate when all the following conditions are satisfied:
  - The gear is shifted to R (Reverse)
  - Vehicle speed is below 5 mph (8 km/h)
  - The approaching detected vehicle is within approximately 82 ft. (25 m) from the left and right side of your vehicle
  - The speed of the vehicle approaching detected from the left and right is above 3 mph (5 km/h)

### **i** Information

**If the operating conditions are satisfied, there will be a warning whenever the vehicle approaches from the left or right side even though your vehicle speed is 0 mph (0 km/h).**

### Emergency Braking

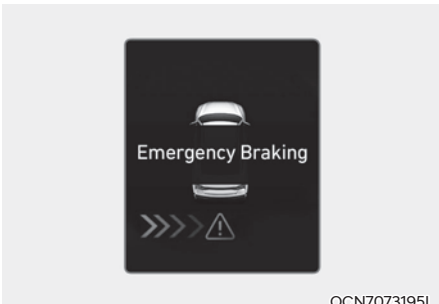

- The function will operate when all the following conditions are satisfied:
  - The gear is shifted to R (Reverse)
  - Vehicle speed is below 5 mph (8 km/h)
  - The approaching detected vehicle is within approximately 5 ft. (1.5 m) from the left and right side of your vehicle
  - The speed of the vehicle approaching detected from the left and right is above 3 mph (5 km/h)
- Emergency braking will be assisted to help prevent collision with approaching detected vehicles from the left and right.

### WARNING

**Brake control will end when:**

- **The approaching vehicle is out of the detecting range**
- **The approaching vehicle passes behind your vehicle**
- **The approaching vehicle does not drive toward your vehicle**
- **The approaching vehicle speed slows down**
- **The driver depresses the brake pedal with sufficient power**

- To warn the driver of an approaching detected vehicle from the rear left/right side of your vehicle, the warning light on the side view mirror will blink and, the 'Emergency Braking' warning message will appear on the cluster.

At the same time, an audible warning will sound and the steering wheel will vibrate. If the Rear View Monitor is operating, a warning will also appear on the infotainment system.

## Stopping Vehicle and Ending Brake Control



- When the vehicle is stopped due to emergency braking, the 'Drive carefully' warning message will appear on the cluster.
  - For your safety, the driver should depress the brake pedal immediately and check the surroundings.
  - Brake control will end after the vehicle is stopped by emergency braking for approximately 2 seconds.
  - During emergency braking, braking control by the system will automatically cancel when the driver excessively depresses the brake pedal.
- WARNING**
- Take the following precautions when using Rear Cross-Traffic Collision-Avoidance Assist:
- For your safety, only change the Settings after parking the vehicle at a safe location.
  - If any other system's warning message is displayed or audible warning is generated, Rear Cross-Traffic Collision-Avoidance Assist's warning message may not be displayed and audible warning may not be generated.
  - You may not hear the warning sound of Rear Cross-Traffic Collision-Avoidance Assist if the surrounding is noisy.
  - Rear Cross-Traffic Collision-Avoidance Assist may not operate if the driver applies the brake pedal to avoid collision.
  - During Rear Cross-Traffic Collision-Avoidance Assist operation, the vehicle may stop suddenly injuring passengers and shifting loose objects. Always have the seat belt on and keep loose objects secured.
  - Even if there is a problem with Rear Cross-Traffic Collision-Avoidance Assist, the vehicle's basic braking will function normally.
  - When Rear Cross-Traffic Collision-Avoidance Assist is operating, braking control by the system will automatically cancel when the driver excessively depresses the accelerator pedal.
  - Rear Cross-Traffic Collision-Avoidance Assist does not operate in all situations and cannot avoid all collisions.
  - During emergency braking, braking control by Rear Cross-Traffic Collision-Avoidance Assist will automatically cancel when the driver excessively depresses the accelerator pedal.

- The driver has the responsibility to control the vehicle. Do not solely depend on Rear Cross-Traffic Collision-Avoidance Assist. Rather, maintain a safe braking distance, and if necessary, depress the brake pedal to reduce driving speed or to stop the vehicle.
- Never deliberately operate Rear Cross-Traffic Collision-Avoidance Assist on people, animal, objects, etc. It may cause serious injury or death.

 **CAUTION**

The brake control may not operate properly depending on the status of ESC (Electronic Stability Control).

There will only be a warning when:

- The ESC (Electronic Stability Control) warning light is on
- ESC (Electronic Stability Control) is engaged in a different function

 **Information**

If the system assists you with braking, the driver needs to pay attention as the brake assist will end within 2 seconds. The driver must immediately depress the brake pedal and check vehicle surroundings.

- Brake control will end when the driver depresses the brake pedal with sufficient power.
- After shifting the gear to R (Reverse), braking control will operate once for left and right vehicle approach.

### Rear Cross-Traffic Collision-Avoidance Assist Malfunction and Limitations

#### Rear Cross-Traffic Collision-Avoidance Assist malfunction

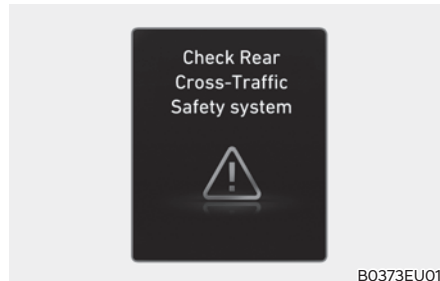

When Rear Cross-Traffic Collision-Avoidance Assist is not working properly, the 'Check Rear Cross-Traffic Safety system' warning message will appear on the instrument cluster for several seconds, and the  warning light will illuminate on the instrument cluster. If this occurs, have the vehicle inspected by an authorized HYUNDAI dealer.

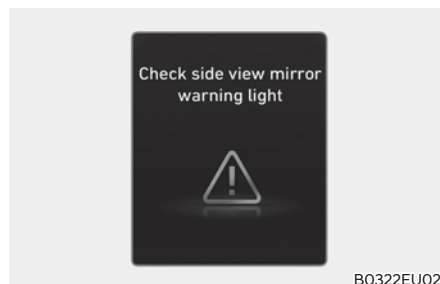

When the side view mirror warning light is not working properly, the 'Check side view mirror warning light' warning message will appear on the instrument cluster for several seconds, and the  warning light will illuminate on the instrument cluster.

### **Rear Cross-Traffic Collision-Avoidance Assist disabled**



When the rear bumper around the rear side radar or sensor is covered with foreign material, such as snow or rain, or installing a trailer or carrier, it can reduce the detecting performance and temporarily limit or disable Rear Cross-Traffic Collision-Avoidance Assist.

If this occurs, the 'Rear Cross-Traffic Safety function disabled. Radar blocked' warning message will appear on the cluster.

Rear Cross-Traffic Collision-Avoidance Assist will operate properly when such foreign material or trailer, etc., is removed.

If Rear Cross-Traffic Collision-Avoidance Assist does not operate properly after it is removed, have the vehicle inspected by an authorized HYUNDAI dealer.

### **WARNING**

- Even though the warning message does not appear on the cluster, Rear Cross-Traffic Collision-Avoidance Assist may not operate properly.
- Rear Cross-Traffic Collision-Avoidance Assist may not operate properly in an area (for example, open terrain), where any objects are not detected after turning ON the engine.

### **CAUTION**

**Turn off Rear Cross-Traffic Collision-Avoidance Assist to install or remove a trailer, carrier, or another attachment.**

**Turn on Rear Cross-Traffic Collision-Avoidance Assist when finished.**

### **Limitations of Rear Cross-Traffic Collision-Avoidance Assist**

Limitations of Rear Cross-Traffic Collision-Avoidance Assist may not operate properly, or the system may operate unexpectedly under the following circumstances:

- Departing from where trees or grass are overgrown
- Departing from where roads are wet
- Speed of the approaching vehicle is fast or slow

Braking control may not work, driver's attention is required in the following circumstances:

- The vehicle severely vibrates while driving over a bumpy road, uneven road or concrete patch
- Driving on a slippery surface due to snow, water puddle, ice, etc.
- The tire pressure is low or a tire is damaged
- The braking system has been modified

**i** Information

For more details on the limitations of the rear corner radar, refer to “Blind-Spot Collision-Avoidance Assist (BCA)” section in chapter 7.

**!** WARNING

- Driving near a vehicle or structure

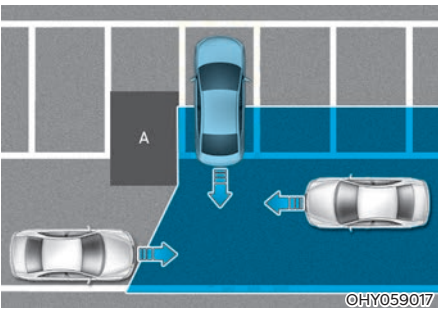

[A] : Structure

Rear Cross-Traffic Collision-Avoidance Assist may be limited when driving near a vehicle or structure, and may not detect the vehicle approaching from the left or right. If this occurs, the system may not warn the driver or control the brakes when necessary.

Always check your surroundings while backing up.

- When the vehicle is in a complex parking environment

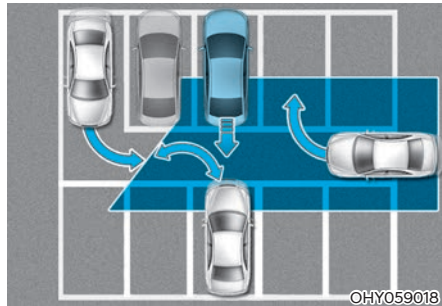

Rear Cross-Traffic Collision-Avoidance Assist may detect vehicles which are parking or pulling out near your vehicle (for example, a vehicle leaving beside your vehicle, a vehicle parking or pulling out in the rear area, a vehicle approaching your vehicle making a turn, etc.). If this occurs, the system may unnecessarily warn the driver and control the brake.

Always check your surroundings while backing up.

- When the vehicle is parked diagonally

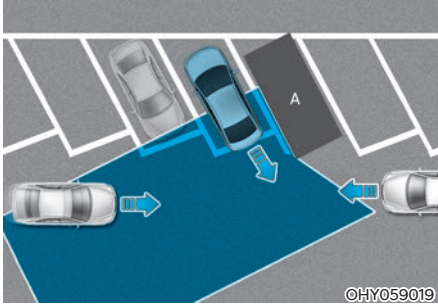

[A] : Vehicle

**Rear Cross-Traffic Collision-Avoidance Assist may be limited when backing up diagonally, and may not detect the vehicle approaching from the left or right. If this occurs, the system may not warn the driver or control the brakes when necessary.**

**Always check your surroundings while backing up.**

- When the vehicle is on or near a slope

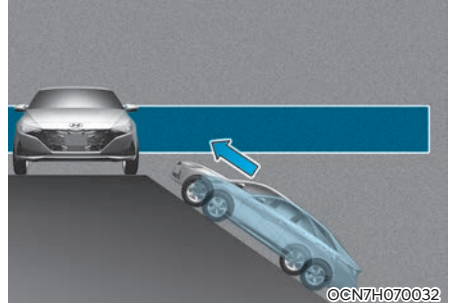

**Rear Cross-Traffic Collision-Avoidance Assist may be limited when the vehicle is on a uphill or downhill slope, or near it, and may not detect the vehicle approaching from the left or right. If this occurs, the system may not warn the driver or control the brakes when necessary.**

**Always check your surroundings while backing up.**

- Pulling into the parking space where there is a structure

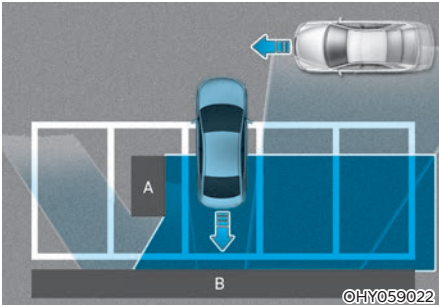

[A] : Structure, [B] :Wall

Rear Cross-Traffic Collision-Avoidance Assist may detect vehicles passing by in front of you when parking backwards into a parking space with a wall or structure in the rear or side area. If this occurs, the system may unnecessarily warn the driver and control the brake.

Always check your surroundings while backing up.

- When the vehicle is parked rearward

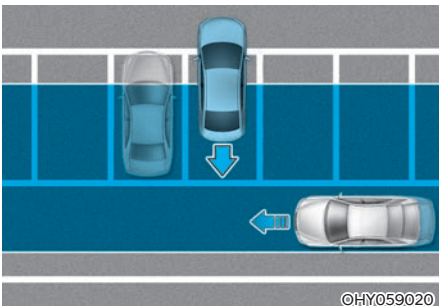

Rear Cross-Traffic Collision-Avoidance Assist may detect vehicles passing by behind you when parking backwards into a parking space. If this occurs, the system may unnecessarily warn the driver and control the brake.

Always check your surroundings while backing up.

### WARNING

- When you are towing a trailer or another vehicle, we recommend that Rear Cross-Traffic Collision-Avoidance Assist is turned off due to safety reasons.
- Rear Cross-Traffic Collision-Avoidance Assist may not operate properly if interfered by strong electromagnetic waves.
- Rear Cross-Traffic Collision-Avoidance Assist may not operate for 15 seconds after the vehicle is started, or the rear corner radars are initialized.

### Information

This device complies with Part 15 of the FCC rules.

Operation is subject to the following three conditions:

1. This device may not cause harmful interference, and
2. This device must accept any interference received, including interference that may cause undesired operation.
3. Changes or modifications not expressly approved by the party responsible for compliance could void the user's authority to operate the device.

### Information

Radio frequency radiation exposure information:

This equipment complies with FCC radiation exposure limits set forth for an uncontrolled environment.

This equipment should be installed and operated with minimum distance of 8 in. (20 cm) between the radiator (antenna) and your body.

This transmitter must not be co-located or operating in conjunction with any other antenna or transmitter.

## DECLARATION OF CONFORMITY

The radio frequency components complies:

### Front Radar (if equipped)



FCC ID

: 2ACDX-MRR-30

This device complies with Part 15 of the FCC Rules. Operation is subject to the following two conditions:

- (1) this device may not cause harmful interference, and
- (2) this device must accept any interference received, including interference that may cause undesired operation.

#### CAUTION TO USERS

Changes or modifications not expressly approved by the party responsible for compliance could void the user's authority to operate the equipment.

OANATEL231

### Rear Corner Radar (if equipped)



The antenna(s) must be installed such that a minimum separation distance of at least 20 cm is maintained between the radiator (antenna) and all persons at all times. This device must not be co-located or operating in conjunction with any other antenna or transmitter.

OANATEL124



# 8. Emergency Situations

Hazard Warning Flasher .....	8-2
In Case of an Emergency While Driving .....	8-2
If the Engine Stalls While Driving .....	8-2
If the Engine Stalls at a Crossroad or Crossing .....	8-2
If you Have a Flat Tire While Driving .....	8-3
If the Engine Will Not Start .....	8-3
If the 12 V Battery Is Discharged .....	8-4
Before Jump Starting .....	8-4
Jump Starting .....	8-5
If the Engine Overheats .....	8-7
Tire Pressure Monitoring System (TPMS) .....	8-9
Check Tire Pressure .....	8-9
Tire Pressure Monitoring System .....	8-10
Low Tire Pressure Telltale .....	8-11
Low Tire Pressure Position and Tire Pressure Telltale .....	8-11
TPMS (Tire Pressure Monitoring System) Malfunction Indicator .....	8-13
Changing a Tire with TPMS .....	8-13
If You Have a Flat Tire (with Tire Mobility Kit) .....	8-15
Introduction .....	8-15
Notes on the safe use of the Tire Mobility Kit .....	8-16
Components of the Tire Mobility Kit .....	8-17
Using the Tire Mobility Kit .....	8-18
How to Adjust Tire Pressure .....	8-22
Towing .....	8-23
Towing Service .....	8-23
Emergency Towing .....	8-24
Removable Towing Hook .....	8-24
Emergency Towing .....	8-25

## HAZARD WARNING FLASHER

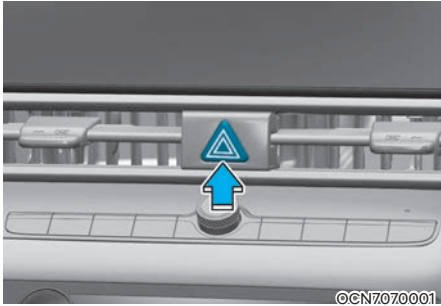

The hazard warning flasher serves as a warning to other drivers to exercise extreme caution when approaching, overtaking, or passing your vehicle.

It should be used whenever emergency repairs are being made or when the vehicle is stopped near the edge of a roadway.

To turn the hazard warning flasher on or off, press the hazard warning flasher button. The button is located in the center fascia panel. Both the left and right turn signal lights will flash simultaneously.

- The hazard warning flasher operates whether your vehicle is running or not.
- The turn signals do not work when the hazard flasher is on.

## IN CASE OF AN EMERGENCY WHILE DRIVING

### If the Engine Stalls While Driving

- Reduce your speed gradually, keeping a straight line. Move cautiously off the road to a safe place.
- Turn on your hazard warning flasher.
- Try to start the engine again. If your vehicle will not start, contact an authorized HYUNDAI dealer or seek other qualified assistance.

### If the Engine Stalls at a Crossroad or Crossing

If the engine stalls at a crossroads or crossing, if safe to do so, move the shift lever to the N (Neutral) position and then push the vehicle to a safe location.

## If you Have a Flat Tire While Driving

If a tire goes flat while you are driving:

- Take your foot off the accelerator pedal and let the vehicle slow down while driving straight ahead. Do not apply the brakes immediately or attempt to pull off the road as this may cause loss of vehicle control resulting in an accident. When the vehicle has slowed to such a speed that it is safe to do so, brake carefully and pull off the road. Drive off the road as far as possible and park on firm, level ground. If you are on a divided highway, do not park in the median area between the two traffic lanes.
- When the vehicle is stopped, press the hazard warning flasher button, move the shift lever into P (Park), and apply the parking brake, and place the ignition switch in the LOCK/OFF position.
- Have all passengers get out of the vehicle. Be sure they all get out on the side of the vehicle that is away from traffic.
- When changing a flat tire, follow the instructions provided later in this chapter.

## IF THE ENGINE WILL NOT START

- Be sure to shift the gear to P (Park). The vehicle starts only when the gear is in P (Park).
- This vehicle does not have a regular 12 V battery that needs periodic replacement. It is lithium ion type integrated into the HEV high voltage battery. The vehicle has a 12 V battery protection system that cuts 12 V battery from vehicle draw to prevent full discharge. If vehicle will not start, first try pressing the 12 V Battery Reset switch (left side of the steering wheel near the fuel door open switch) to reconnect the 12 V battery, but you must start vehicle within 15 seconds of pressing the 12 V Battery Reset switch. After starting the vehicle (READY indicator ON ), operate the vehicle safely outdoors in ready mode stopped and/or drive it for 30 minutes total to charge the 12 V battery fully.
- Check the fuel level and add fuel if necessary.

If the vehicle still does not start, call an authorized HYUNDAI dealer for assistance.

### NOTICE

**Push or pull starting the vehicle may cause the catalytic converter to overload which can lead to damage to the emission control system.**

## IF THE 12 V BATTERY IS DISCHARGED

### Before Jump Starting

This vehicle does not have a regular 12 V battery that needs periodic replacement. It is lithium ion type integrated into the HEV high voltage battery. The vehicle has a 12 V battery protection system that cuts 12 V battery from vehicle draw to prevent full discharge.

### Using the 12 V battery reset switch

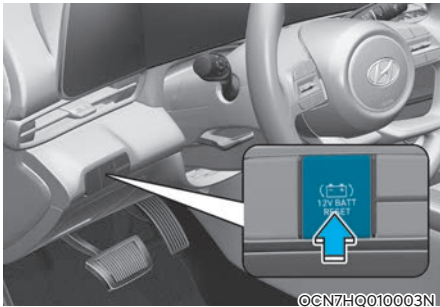

1. Press the 12 V Battery Reset switch to reconnect the 12 V battery.
2. Start the vehicle within 15 seconds of pressing the 12 V Battery Reset switch.
3. After starting the vehicle (**READY** indicator on), operate the vehicle safely outdoors in ready mode stopped and/or drive it for 30 minutes total to charge the 12 V battery fully.

If you do not start the vehicle immediately after pressing the 12 V Battery Reset switch, the power of 12 V battery is automatically disconnected after few seconds to save the 12 V battery from additional discharge. If the 12 V battery is disconnected prior to starting the vehicle, press the 12 V Battery Reset switch again and then immediately start the vehicle as explained.

Repeated use of the 12 V Battery Reset switch without a sufficient engine ON cycle (30 Min+) may cause over discharge of the 12 V battery, which will prevent the vehicle from starting. If the 12 V battery is over discharged to a point that the reset does not work, try to jump-start the vehicle.

### **i** Information

**After starting the vehicle (READY indicator on), the 12 V battery is being charged whether the engine is running or not. Although there is no engine sound, it is unnecessary to depress the accelerator pedal.**

The following items may need to be reset after the battery has been discharged or the battery has been disconnected.

See chapter 4 and 5 for:

- Power Windows
- Trip Computer
- Climate Control System
- Clock
- Audio System
- Sunroof

**NOTICE**

**External power source using 12 V battery**

The use of external power accessories may reduce performance and function of the vehicle. Especially, the use of dash cameras may shut off the power of the vehicle prior to the dash camera's automatic shut-down.

If the power of the vehicle is shut off, start the vehicle as explained. (refer to "Using the 12 V Battery Reset Switch")

**Jump Starting**

In the event vehicle still does not have a functional 12 V battery (check if interior lights will not turn on) then you can try a jump start to the engine compartment jumper terminals using a 12 V booster pack or jumper cables from another vehicle's 12 V battery according to the following instructions.

**CAUTION**

**Jump starting can be dangerous if done incorrectly. Follow the jump starting procedure in this section to avoid serious injury or damage to your vehicle. If in doubt about how to properly jump start your vehicle, we strongly recommend that you have a service technician or towing service do it for you.**

1. Position the vehicles close enough that the jumper cables will reach, but do not allow the vehicles to touch.  
Avoid fans or any moving parts in the engine compartment at all times, even when the vehicles are turned off.
2. Turn off all electrical devices such as radios, lights, air conditioning, etc. Put the vehicles in P (Park) and set the parking brake. Turn both vehicles OFF.

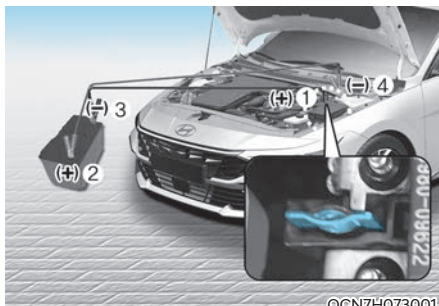

©CN7H073001

3. Connect the jumper cables in the exact sequence shown in the illustration. First connect one jumper cable to the red, charging terminal inside the engine compartment fuse panel (1).
4. Connect the other end of the jumper cable to the red, positive (+) battery/jumper terminal of the assisting vehicle (2).
5. Connect the second jumper cable to the black, negative (-) battery/chassis ground of the assisting vehicle (3).
6. Connect the other end of the second jumper cable to the black, negative (-) chassis ground of your vehicle (4).

Do not allow the jumper cables to contact anything except the correct battery or jumper terminals or the correct ground. Do not lean over the battery when making connections.

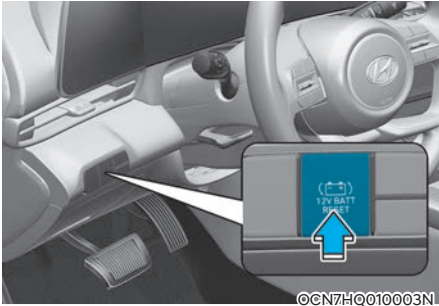

©CN7HQ010003N

7. Press the 12 V Battery Reset switch.
8. Start the engine of the assisting vehicle and let it run for a few minutes.
9. Start your vehicle as soon as possible. After starting the vehicle (READY indicator on), operate the vehicle safely outdoors in ready mode stopped and/or drive it for 30 minutes total to charge the 12 V battery fully.

If your vehicle will not start after a few attempts, it probably requires service. In this event please seek qualified assistance. If the cause of your battery discharging is not apparent, have your vehicle checked by an authorized HYUNDAI dealer.

Disconnect the jumper cables in the exact reverse order you connected them:

1. Disconnect the jumper cable from the black, negative (-) chassis ground of your vehicle (4).
2. Disconnect the other end of the jumper cable from the black, negative (-) battery/chassis ground of the assisting vehicle (3).
3. Disconnect the second jumper cable from the red, positive (+) battery/jumper terminal of the assisting vehicle (2).
4. Disconnect the other end of the jumper cable from the red, charging terminal inside the engine compartment fuse panel (1).

### Information

The voltage range of the charger should be 13.3~14 V and its current range should be less than 60 A. (13.8 V is recommended).

### CAUTION

- The use of an improper charger with a voltage and current range higher than specified may cause overheating and damage to the 12 V battery.
- The use of an incorrect charger will lead to a power shut-off to save the 12 V battery. Stop using the incorrect charger once the power of the vehicle is shut off.

### Information



An inappropriately disposed battery can be harmful to the environment and human health. Dispose of the battery according to your local law(s) or regulations.

### **NOTICE**

To prevent damage to your vehicle:

- Only use a 12 V power supply (battery or jumper system) to jump start your vehicle.
- Do not attempt to jump start your vehicle by push-starting.

### CAUTION

Do not jump start another vehicle with your hybrid vehicle. Jump starting another vehicle will damage the hybrid vehicle's 12 V battery (lithium ion type).

## IF THE ENGINE OVERHEATS

If your temperature gauge indicates overheating, you experience a loss of power, or hear loud pinging or knocking, the engine may be overheating. If this happens, you should:

1. Pull off the road and stop as soon as it is safe to do so.
2. Shift the gear to P (Park) and set the parking brake
3. Turn off the air conditioner.
4. When the coolant or hot steams gush out of the reservoir, stop the engine and call an authorized HYUNDAI dealer for assistance. If the coolant does not flow out, leave the engine compartment opened, while running the engine. Check the coolant temperature gauge on the instrument cluster and turn off the engine to make sure the coolant temperature is sufficiently cooled down.

5. Cool down the engine sufficiently and check the coolant level. When it is insufficient, check its connection with the radiator, the heater hose, and the water pump for any leakage. When there is no leakage, add the coolant. However, if the problems persists, such as the coolant leakages, the cooling-fan malfunction or the water pump drive belt damages, immediately stop the engine, and have your vehicle checked by an authorized HYUNDAI dealer.
- You should mix antifreeze and water in a proper ratio to make coolant. If the antifreeze ratio is too high or low, it may cause overheating due to the lack of cooling function.  
(Refer to the Mix Ratio in “Checking the coolant level” in chapter 9.)
  - If overheating happens repeatedly, have your vehicle to be checked by an authorized HYUNDAI dealer.



### WARNING



**While the engine is running, keep hands, clothing and tools away from the moving parts such as the cooling fan and drive belt to prevent serious injury.**



**WARNING**



Never remove the engine coolant cap and/or inverter coolant cap or the drain plug while the engine and radiator are hot.

Hot coolant and steam may blow out under pressure, causing serious injury. Turn the hybrid system off and wait until the engine cools down. Use extreme care when removing the engine coolant cap and/or inverter coolant cap. Wrap a thick towel around it, and turn it counterclockwise slowly to the first stop. Step back while the pressure is released from the cooling system. When you are sure all the pressure has been released, press down on the cap, using a thick towel, and continue turning counterclockwise to remove it.



**CAUTION**

- Serious loss of coolant indicates a leak in the cooling system and should be checked as soon as possible by an authorized HYUNDAI dealer.
- When the engine overheats from low engine coolant, suddenly adding engine coolant may cause cracks in the engine. To prevent damage, add engine coolant slowly in small quantities.

## TIRE PRESSURE MONITORING SYSTEM (TPMS)

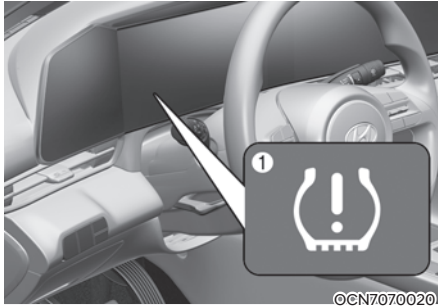

- (1) Low Tire Pressure Telltale/TPMS Malfunction Indicator
- (2) Low Tire Pressure Position Telltale and Tire Pressure Telltale (Shown on the cluster display)

### Check Tire Pressure



- You can check the tire pressure in the Assist mode on the cluster.
- Refer to the 'Cluster display (Type A)' in chapter 4.
- Tire pressure is displayed after a few minutes of driving after initial engine start up.
- If tire pressure is not displayed when the vehicle is stopped, "Drive to display" message will appear. After driving, check the tire pressure.
- The displayed tire pressure values may differ from those measured with a tire pressure gauge.
- You can change the tire pressure unit in the User Settings Mode on the cluster.
  - psi, kpa, bar (Refer to the "User Settings Mode" section in chapter 4).

## Tire Pressure Monitoring System



### WARNING

**Over-inflation or under-inflation can reduce tire life, adversely affect vehicle handling, and lead to sudden tire failure that may cause loss of vehicle control resulting in an accident.**

Each tire, including the spare (if provided), should be checked monthly when cold and inflated to the inflation pressure recommended by the vehicle manufacturer on the vehicle placard or tire inflation pressure label. (If your vehicle has tires of a different size than the size indicated on the vehicle placard or tire inflation pressure label, you should determine the proper tire inflation pressure for those tires.)

As an added safety feature, your vehicle has been equipped with a tire pressure monitoring system (TPMS) that illuminates a low tire pressure telltale when one or more of your tires is significantly under-inflated. Accordingly, when the low tire pressure telltale illuminates, you should stop and check your tires as soon as possible, and inflate them to the proper pressure. Driving on a significantly underinflated tire causes the tire to overheat and can lead to tire failure.

Under-inflation also reduces fuel efficiency and tire tread life, and may affect the vehicle's handling and stopping ability.

Please note that the TPMS is not a substitute for proper tire maintenance, and it is the driver's responsibility to maintain correct tire pressure, even if under-inflation has not reached the level to trigger illumination of the TPMS low tire pressure telltale.

Your vehicle has also been equipped with a TPMS malfunction indicator to indicate when the system is not operating properly. The TPMS malfunction indicator is combined with the low tire pressure telltale. When the system detects a malfunction, the telltale will flash for approximately one minute and then remain continuously illuminated. This sequence will continue upon subsequent vehicle start-ups as long as the malfunction exists.

When the malfunction indicator is illuminated, the system may not be able to detect or signal low tire pressure as intended. TPMS malfunctions may occur for a variety of reasons, including the installation of replacement or alternate tires or wheels on the vehicle that prevent the TPMS from functioning properly.

Always check the TPMS malfunction telltale after replacing one or more tires or wheels on your vehicle to ensure that the replacement or alternate tires and wheels allow the TPMS to continue to function properly.

**NOTICE**

If any of the below happens, have the system checked by an authorized HYUNDAI dealer.

1. The Low Tire Pressure Telltale/ TPMS Malfunction Indicator does not illuminate for 3 seconds when the ignition switch is placed to the ON position or engine is running.
2. The TPMS Malfunction Indicator remains illuminated after blinking for approximately 1 minute.
3. The Low Tire Pressure Position Telltale remains illuminated.

**Low Tire Pressure Telltale****Low Tire Pressure Position and Tire Pressure Telltale**

When the tire pressure monitoring system warning indicators are illuminated and a warning message displayed on the cluster display, one or more of your tires is significantly under-inflated. The Low Tire Pressure Position Telltale will indicate which tire is significantly underinflated by illuminating the corresponding position light.

If either telltale illuminates, immediately reduce your speed, avoid hard cornering and anticipate increased stopping distances. You should stop and check your tires as soon as possible. Inflate the tires to the proper pressure as indicated on the vehicle's placard or tire inflation pressure label located on the driver's side center pillar outer panel.

If you cannot reach a service station or if the tire cannot hold the newly added air, replace the low pressure tire with the spare tire.

The Low Tire Pressure Telltale will remain on and the TPMS Malfunction Indicator may blink for one minute and then remain illuminated (when the vehicle is driven approximately 10 minutes at speed above 15.5 mph (25km/h)) until you have the low pressure tire repaired and replaced on the vehicle.



### Information

**The spare tire is not equipped with a tire pressure sensor.**



### CAUTION

**In winter or cold weather, the Low Tire Pressure Telltale may be illuminated if the tire pressure was adjusted to the recommended tire inflation pressure in warm weather. It does not mean your TPMS is malfunctioning because the decreased temperature leads to a proportional lowering of tire pressure.**

**When you drive your vehicle from a warm area to a cold area or from a cold area to a warm area, or the outside temperature is greatly higher or lower, you should check the tire inflation pressure and adjust the tires to the recommended tire inflation pressure.**



### WARNING

**Low pressure damage**

**Significantly low tire pressure makes the vehicle unstable and can contribute to loss of vehicle control and increased braking distances.**

**Continued driving on low pressure tires can cause the tires to overheat and fail.**



## TPMS (Tire Pressure Monitoring System) Malfunction Indicator

The TPMS Malfunction Indicator will illuminate after it blinks for approximately one minute when there is a problem with the Tire Pressure Monitoring System.

Have the system checked by an authorized HYUNDAI dealer.

### NOTICE

**If there is a malfunction with the TPMS, the Low Tire Pressure Position Telltale will not be displayed even though the vehicle has an under-inflated tire.**

### NOTICE

**The TPMS Malfunction Indicator may illuminate after blinking for one minute if the vehicle is near electric power supply cables or radio transmitters such as police stations, government and public offices, broadcasting stations, military installations, airports, transmitting towers, etc.**

**Additionally, the TPMS Malfunction Indicator may illuminate if snow chains are used or electronic devices such as computers, chargers, remote starters, navigation, etc. This may interfere with normal operation of the TPMS.**

## Changing a Tire with TPMS

If you have a flat tire, the Low Tire Pressure and Position telltales will come on. Have the flat tire repaired by an authorized HYUNDAI dealer as soon as possible or replace the flat tire with the spare tire.

### NOTICE

**It is recommended that you do not use a puncture-repairing agent not approved by a HYUNDAI dealer to repair and/or inflate a low pressure tire. Tire sealant not approved by a HYUNDAI dealer may damage the tire pressure sensor.**

The spare tire (if equipped) does not come with a tire pressure monitoring sensor. When the low pressure tire or the flat tire is replaced with the spare tire, the Low Tire Pressure Telltale will remain on. Also, the TPMS Malfunction Indicator will illuminate after blinking for one minute if the vehicle is driven at speed above 15.5 mph (25km/h) for approximately 10 minutes.

Once the original tire equipped with a tire pressure monitoring sensor is reinflated to the recommended pressure and reinstalled on the vehicle, the Low Tire Pressure Telltale and TPMS Malfunction Indicator will go off within a few minutes of driving.

If the indicators do not extinguish after a few minutes, please visit an authorized HYUNDAI dealer.

Each wheel is equipped with a tire pressure sensor mounted inside the tire behind the valve stem (except for the spare tire). You must use TPMS specific wheels. Always have your tires serviced by an authorized HYUNDAI dealer.

You may not be able to identify a tire with low pressure by simply looking at it. Always use a good quality tire pressure gauge to measure the tire's inflation pressure. Please note that a tire that is hot (from being driven) will have a higher pressure measurement than a tire that is cold.

A cold tire means the vehicle has been sitting for 3 hours and driven for less than 1 mile (1.6 km) in that 3 hour period.

Allow the tire to cool before measuring the inflation pressure. Always be sure the tire is cold before inflating to the recommended pressure.



### WARNING

- **The TPMS cannot alert you to severe and sudden tire damage caused by external factors such as nails or road debris.**
- **If you feel any vehicle instability, immediately take your foot off the accelerator, apply the brakes gradually with light force, and slowly move to a safe position off the road.**



### WARNING

**Tampering with, modifying, or disabling the Tire Pressure Monitoring System (TPMS) components may interfere with the system's ability to warn the driver of low tire pressure conditions and/or TPMS malfunctions. Tampering with, modifying, or disabling the Tire Pressure Monitoring System (TPMS) components may void the warranty for that portion of the vehicle.**



### Information

**This device complies with Part 15 of the FCC rules.**

**Operation is subject to the following three conditions:**

- 1. This device may not cause harmful interference.**
- 2. This device must accept any interference received, including interference that may cause undesired operation.**
- 3. Changes or modifications not expressly approved by the party responsible for compliance could void the user's authority to operate the equipment.**

## IF YOU HAVE A FLAT TIRE (WITH TIRE MOBILITY KIT, IF EQUIPPED)

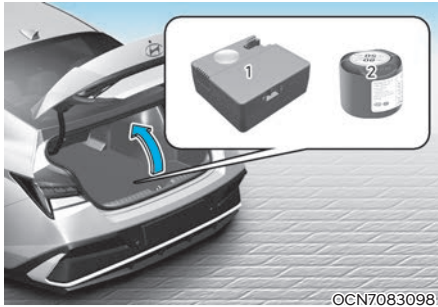

For safe operation, carefully read and follow the instructions in this manual before use.

- (1) Compressor
- (2) Sealant bottle

The Tire Mobility Kit is a temporary fix to the tire and have the tire inspected by an authorized HYUNDAI dealer as soon as possible.



### CAUTION

**When two or more tires are flat, do not use the tire mobility kit because the sealant provided with the Tire Mobility Kit must be used for only one flat tire.**



### WARNING

**Do not use the Tire Mobility Kit to repair punctures in the tire walls. This can result in an accident due to tire failure.**



### WARNING

**Have your tire repaired as soon as possible. The tire may lose air pressure at any time after inflating with the Tire Mobility Kit.**

## Introduction

With the Tire Mobility Kit you stay mobile even after experiencing a tire puncture.

The compressor and sealing compound system effectively and comfortably seals most punctures in a passenger car tire caused by nails or similar objects and reinflates the tire.

After you ensure that the tire is properly sealed you can drive cautiously on the tire (distance up to 120 miles (200 km)) at a max. speed of 50 mph (80 km/h) in order to reach a service station or tire dealer for the tire replacement.

It is possible that some tires, especially with larger punctures or damage to the sidewall, cannot be sealed completely.

Air pressure loss in the tire may adversely affect tire performance.

For this reason, you should avoid abrupt steering or other driving maneuvers, especially if the vehicle is heavily loaded or if a trailer is in use.

The Tire Mobility Kit is not designed or intended as a permanent tire repair method and is to be used for one tire only.

This instruction shows you step by step how to temporarily seal the puncture simply and reliably.

Read the section “Notes on the safe use of the Tire Mobility Kit”.



### WARNING

**Do not use the TMK if a tire is severely damaged by driving run flat or with insufficient air pressure.**

**Only punctured areas located within the tread region of the tire can be sealed using the TMK.**

### Notes on the safe use of the Tire Mobility Kit

- Park your car at the side of the road so that you can work with the Tire Mobility Kit away from moving traffic.
- To be sure your vehicle will not move, even when you're on fairly level ground, always set your parking brake.
- Only use the Tire Mobility Kit for sealing/inflation passenger car tires. Only punctured areas located within the tread region of the tire can be sealed using the tire mobility kit.
- Do not use on motorcycles, bicycles or any other type of tires.
- When the tire and wheel are damaged, do not use Tire Mobility Kit for your safety.
- Use of the Tire Mobility Kit may not be effective for tire damage larger than approximately 16 inch (4 mm).  
Please contact the nearest HYUNDAI dealer if the tire cannot be made roadworthy with the Tire Mobility Kit.
- Do not use the Tire Mobility Kit if a tire is severely damaged by driving run flat or with insufficient air pressure.
- Do not remove any foreign objects such as nails or screws that have penetrated the tire.
- Provided the car is outdoors, leave the engine running. Otherwise operating the compressor may eventually drain the car battery.
- Never leave the Tire Mobility Kit unattended while it is being used.
- Do not leave the compressor running for more than 10 minutes at a time or it may overheat.
- Do not use the Tire Mobility Kit if the ambient temperature is below -22°F (-30°C).
- In case of skin contact with the sealant, wash the area thoroughly with plenty of water. If the irritation persists, seek medical attention.
- In case of eye contact with the sealant, flush your eyes for at least 15 minutes. If the irritation persists, seek medical attention.
- In case of swallowing the sealant, rinse the mouth and drink plenty of water. However, never give anything to an unconscious person and seek medical attention immediately.
- Long time exposure to the sealant may cause damage to bodily tissue such as kidney, etc.

## Components of the Tire Mobility Kit

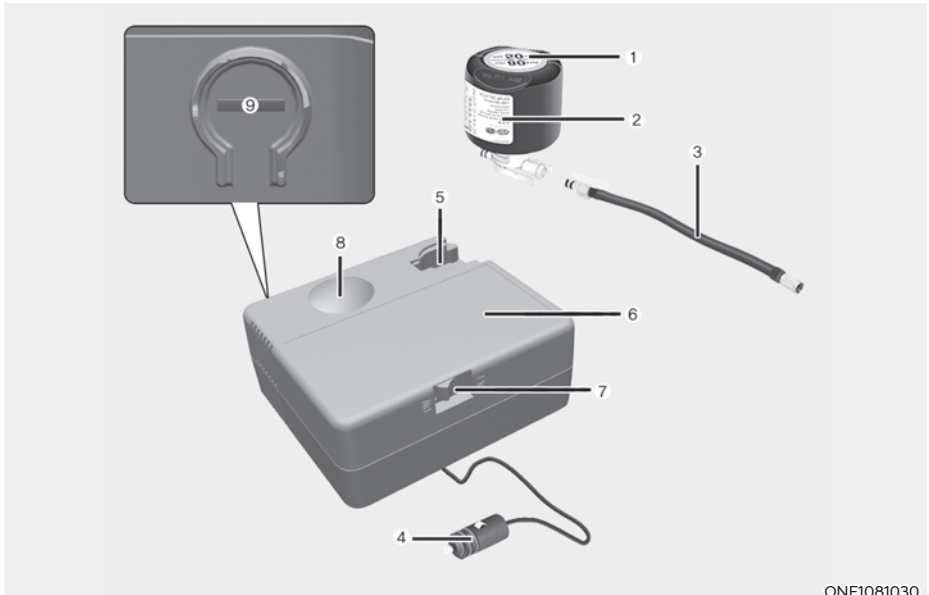

ONE1081030

1. Speed restriction label
2. Sealant bottle and label with speed restriction
3. Filling hose
4. Connectors and cable for power outlet direct connection
5. Holder for the sealant bottle
6. Compressor
7. ON/OFF switch
8. Pressure gauge for displaying the tire inflation pressure
9. Button for reducing the tire inflation pressure

Connectors, cable and connection hose are stored in the compressor housing. Strictly follow the specified sequence, otherwise the sealant may escape under high pressure.

**⚠️ WARNING**

**Expired sealant**

Do not use the Tire sealant after the sealant has expired (for example, past the expiration date on the sealant container). This can increase the risk of tire failure.

**⚠️ WARNING**

**Sealant**

- Keep out of reach of children.
- Avoid contact with eyes.
- Do not swallow.

**Using the Tire Mobility Kit**

**⚠️ WARNING**



Detach the speed restriction label (1) from the sealant bottle (2), and place it in a highly visible place inside the vehicle such as on the steering wheel to remind the driver not to drive too fast.

**⚠️ CAUTION**

If only the tire pressure needs to be adjusted, refer to “How to Adjust Tire Pressure” in this chapter. Before using the Tire Mobility Kit, be fully aware of the explanation on the sealant.



OIGH079021

1. Shake the sealant bottle (2).

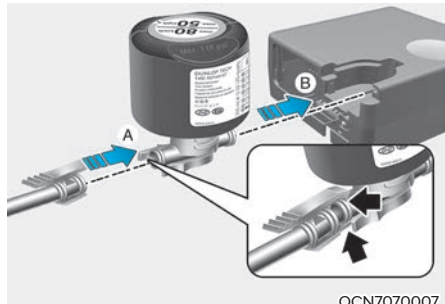

OCN7070007

2. Connect the filling hose (3) to the sealant bottle (2) in the direction of (A) and connect the sealant bottle to the sealant bottle holder (5) in the direction of (B).
3. Ensure that the compressor is switched OFF.

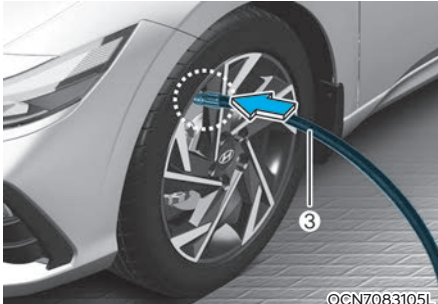

4. Unscrew the valve cap from the valve of the defective wheel and screw the filling hose (3) of the sealant bottle onto the valve.

### CAUTION

Securely install the sealant filling hose to the valve. If not, sealant may flow backward, possibly clogging the filling hose.

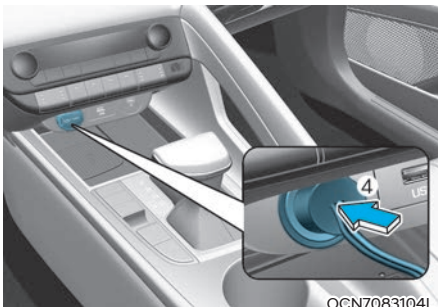

5. Plug the compressor power cord (4) into the vehicle power outlet.

### **NOTICE**

Only use the front passenger side power outlet when connecting the power cord.

6. With the ignition switch in the ON position, switch on the compressor and let it run for approximately 5~7 minutes to fill the sealant up to proper pressure. (refer to the Tire and Wheels, chapter 2.) The inflation pressure of the tire after filling is unimportant and will be checked/corrected later. Be careful not to overinflate the tire and stay away from the tire when filling it.

### CAUTION

#### Tire pressure

Do not attempt to drive your vehicle if the tire pressure is below 200 kPa (29 psi). This could result in an accident due to sudden tire failure.

### WARNING

#### Carbon monoxide

Do not leave your vehicle running in a poorly ventilated area for extended periods of time. Carbon monoxide poisoning and suffocation can occur.

7. Switch off the compressor.  
8. Detach the hoses from the sealant bottle connector and from the tire valve.

Return the Tire Mobility Kit to its storage location in the vehicle.

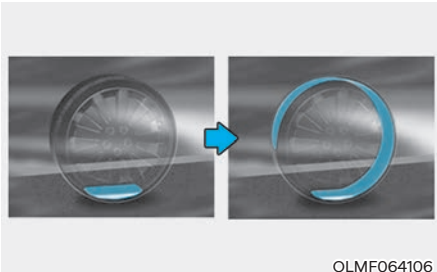

9. Immediately drive approximately 4–6 mi. (7–10 km or, about 10min) to evenly distribute the sealant in the tire.

Do not exceed a speed of 50 mph (80 km/h). If possible, do not fall below a speed of 12 mph (20 km/h).

While driving, if you experience any unusual vibration, ride disturbance or noise, reduce your speed and drive with caution until you can safely pull off of the side of the road.

Call for road side service or towing.

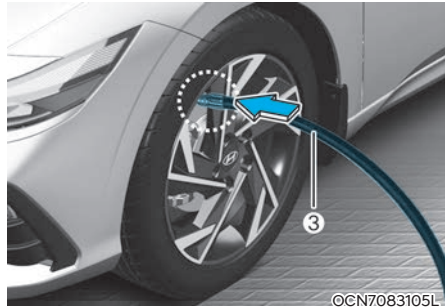

10. After driving approximately 4–6 mi. (7–10 km or about 10 min), stop at a safety location.
11. Connect the filling hose (3) of the compressor directly to the tire valve.
12. Connect between compressor and the vehicle power outlet using the cable and connectors.
13. Adjust the tire inflation pressure to the recommended tire inflation. With the ignition switched on, proceed as follows.
  - To increase the inflation pressure: Switch on the compressor. To check the current inflation pressure setting, briefly switch off the compressor.
  - To reduce the inflation pressure: Press the button (9) on the compressor.

**NOTICE**

Do not let the compressor run for more than 10 minutes, otherwise the device will overheat and may be damaged.

***i* Information**

The pressure gauge may show higher than actual reading when the compressor is running. To get an accurate tire pressure, the compressor needs to be turned off.

** CAUTION**

If the inflation pressure is not maintained, drive the vehicle a second time, refer to step 9.

Then repeat steps 10 to 13.

Use of the TMK may be ineffectual for tire damage larger than approximately 0.16 in. (4 mm).

Contact an authorized HYUNDAI dealer if the tire cannot be made roadworthy with the Tire Mobility Kit.

** WARNING**

The tire inflation pressure must be at least 32 psi (220 kPa). If it is not, do not continue driving.

Call for road side service or towing.

** CAUTION**

Tire pressure sensor (if equipped with TPMS)

The sealant on the tire pressure sensor and wheel should be removed when you replace the tire with a new one and inspect the tire pressure sensors. Get this done at an authorized HYUNDAI dealer.

***i* Information**

When reinstalling the repaired or replaced tire and wheel on the vehicle, tighten the wheel lug nut to 79~94 lbf·ft (11~13 kgf·m).

## How to Adjust Tire Pressure

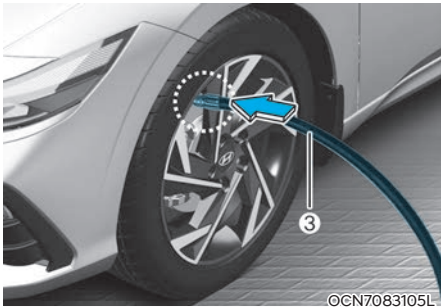

1. Park your vehicle in a safe location.
2. Connect the filling hose (3) of the compressor directly to the tire valve.
3. Plug the compressor power cord into the vehicle power outlet.
4. Adjust the tire inflation pressure to the recommended tire inflation. With the ignition switched on, proceed as follows.
  - To increase the inflation pressure: Switch on the compressor. To check the current inflation pressure setting, briefly switch off the compressor.
  - To reduce the inflation pressure: Press the button (9) on the compressor.

### NOTICE

Do not let the compressor run for more than 10 minutes, otherwise the device will overheat and may be damaged.

### Information

- The pressure gauge may show higher than actual reading when the compressor is running. To get an accurate tire reading, the compressor needs to be turned off.
- When reinstalling the repaired or replaced tire and wheel on the vehicle, tighten the wheel lug nut to 79~94 lbf·ft (11~13 kgf·m).

### CAUTION

Do not use the sealant when the tire pressure only needs to be adjusted.

### WARNING

The tire inflation pressure must be at least 32 psi (220 kPa). If it is not, do not continue driving.

Call for road side service or towing.

## TOWING

### Towing Service

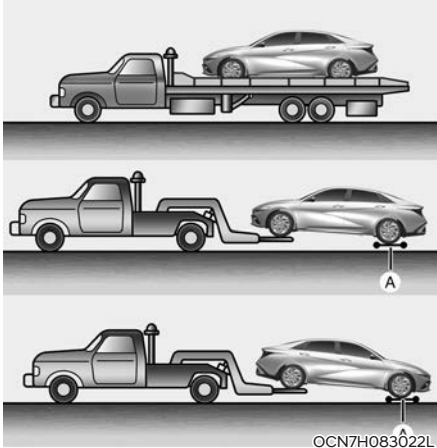

If emergency towing is necessary, have it done by an authorized HYUNDAI dealer or a commercial tow-truck service.

Proper lifting and towing procedures are necessary to prevent damage to the vehicle. The use of wheel dollies or flatbed is recommended.

It is acceptable to tow the vehicle with the rear wheels on the ground (without dollies) and the front wheels off the ground.

If any of the loaded wheels or suspension components are damaged or the vehicle is being towed with the front wheels on the ground, use a towing dolly under the front wheels.

When being towed by a commercial tow truck and wheel dollies are not used, the front of the vehicle should always be lifted, not the rear.

### ⚠ CAUTION

- Do not tow the vehicle with the front wheels on the ground as this may cause damage to the vehicle.

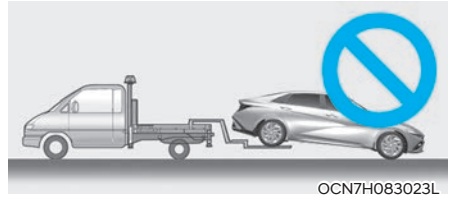

- Do not tow with sling-type equipment. Use a wheel lift or flatbed equipment.



- Do not tow the vehicle with four wheels in contact with the ground if it is the vehicle equipped with dual clutch transmission.



Otherwise, the transmission will be seriously damaged. Also, make sure not to tow the vehicle connecting it with other vehicles including camper vans.

**⚠️ WARNING**

If your vehicle is equipped with a rollover sensor, place the ignition switch in the LOCK/OFF or ACC position when the vehicle is being towed. The side impact and curtain air bag may deploy if the sensor detects the situation as a rollover.

When towing your vehicle in an emergency without wheel dollies:

1. Place the ignition switch in the ACC position.
2. Place the shift lever in N (Neutral).
3. Release the parking brake.

**⚠️ CAUTION**

Failure to place the shift lever in N (Neutral) when being towed with the front wheels on the ground can cause internal damage to the transmission.

**Emergency Towing**

If towing is necessary, have it done by an authorized HYUNDAI dealer or a commercial tow truck service.

**Removable Towing Hook**

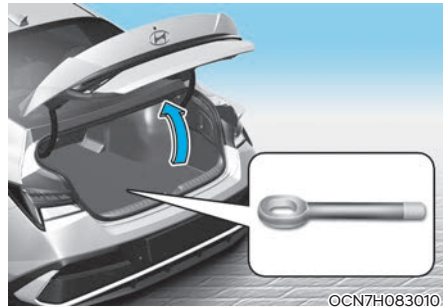

1. Open the trunk, and remove the towing hook from the tool case.

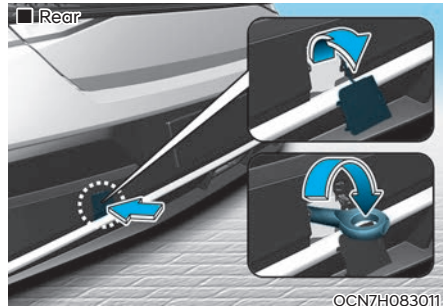
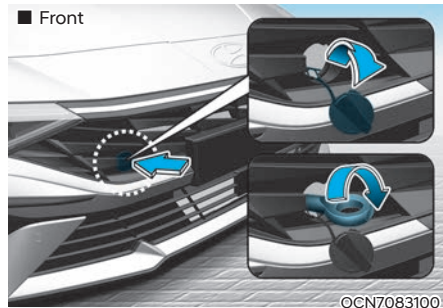

2. Remove the hole cover by pressing the lower part of the cover on the bumper.
3. Install the towing hook by turning it clockwise into the hole until it is fully secured.
4. Remove the towing hook and install the cover after use.

## Emergency Towing

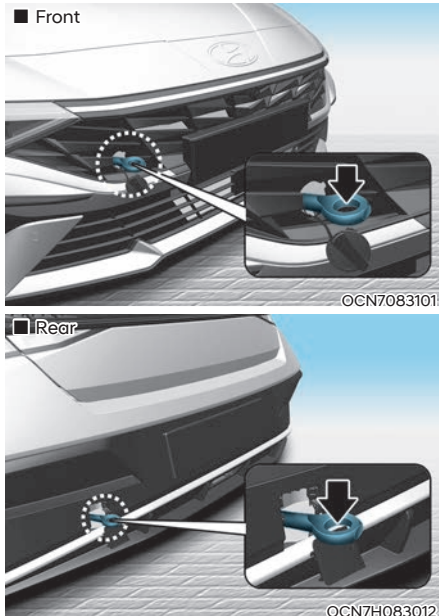

If towing is necessary, have it done by an authorized HYUNDAI dealer or a commercial tow truck service.

If towing service is not available in an emergency, your vehicle may be temporarily towed using a cable or chain secured to the emergency towing hook at the front (or rear) of the vehicle.

Use extreme caution when towing the vehicle with a cable or chain. A driver must be in the vehicle to steer it and operate the brakes.

Towing in this manner may be done only on hard-surfaced roads for a short distance and at low speeds. Also, the wheels, axles, power train, steering and brakes must all be in good condition.



### CAUTION

**The driver must be in the vehicle for steering and braking operations when the vehicle is being towed. Passengers other than the driver must not be in the vehicle.**

Always follow these emergency towing precautions:

- Place the ignition switch in the ACC position so the steering wheel is not locked.
- Place the shift lever in N (Neutral).
- Release the parking brake.
- Depress the brake pedal with more force than normal since you will have reduced braking performance.
- More steering effort will be required because the power steering system will be disabled.
- Use a vehicle heavier than your own to tow your vehicle.
- The drivers of both vehicles should communicate with each other frequently.
- Before emergency towing, check that the hook is not broken or damaged.
- Fasten the towing cable or chain securely to the hook.
- Do not jerk the hook. Apply steady and even force.

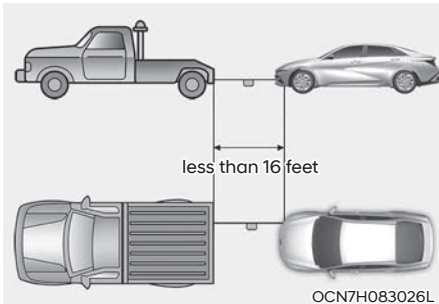

- Use a towing cable or chain less than 16 ft. (5 m) long. Attach a white or red cloth (about 12 in. (30 cm) wide) in the middle of the cable or chain for easy visibility.
- Drive carefully so the towing cable or chain remains tight during towing.
- Before towing, check the Dual clutch transmission for fluid leaks under your vehicle. If the Dual clutch transmission fluid is leaking, flatbed equipment or a towing dolly must be used.

### **NOTICE**

**Accelerate or decelerate the vehicle in a slow and gradual manner while maintaining tension on the tow rope or chain to start or drive the vehicle, otherwise tow hooks and the vehicle may be damaged.**

### **NOTICE**

**To avoid damage to your vehicle and vehicle components when towing:**

- **Always pull straight ahead when using the towing hooks. Do not pull from the side or at a vertical angle.**
- **Do not use the towing hooks to pull a vehicle out of mud, sand or other conditions from which the vehicle cannot be driven out under its own power.**
- **Limit the vehicle speed to 10mph (15km/h) and drive less than 1 mile (1.5 km) when towing to avoid serious damage to Dual clutch transmission.**
- **The Dual clutch transmission vehicle can be towed to a normal vehicle only without oil leakage. Check for oil leaks. Towing the vehicle with oil leakage may damage the transmission.**

# 9. Maintenance

Engine Compartment .....	9-3
Maintenance Services .....	9-4
Owner's Responsibility .....	9-4
Owner Maintenance Precautions.....	9-4
Owner Maintenance .....	9-5
Owner Maintenance Schedule.....	9-5
Scheduled Maintenance Services .....	9-7
Normal Maintenance Schedule .....	9-8
Maintenance Under Severe Usage Conditions .....	9-12
Explanation of Scheduled Maintenance Items.....	9-14
Engine Oil .....	9-16
Checking the Engine Oil Level.....	9-16
Checking the Engine Oil and Filter .....	9-17
Engine Coolant/Inverter Coolant.....	9-19
Checking the Coolant Level.....	9-19
Changing Engine Coolant.....	9-22
Hybrid Starter & Generator (HSG) Belt .....	9-23
Checking the Hybrid Starter & Generator (HSG) Belt .....	9-23
Brake Fluid.....	9-24
Checking the Brake Fluid Level .....	9-24
Engine Clutch Actuator Fluid .....	9-25
Checking the Engine Clutch Actuator Fluid Level .....	9-25
Washer Fluid.....	9-26
Checking the Washer Fluid Level.....	9-26
Air Cleaner .....	9-26
Filter Replacement.....	9-26
Cabin Air Filter.....	9-28
Filter Inspection.....	9-28
Filter Replacement.....	9-28
Wiper Blades .....	9-29
Blade Inspection .....	9-29
Blade Replacement.....	9-29
Battery .....	9-31
12 V auxiliary battery .....	9-31

Tires and Wheels.....	9-32
Tire Care.....	9-32
Recommended Cold Tire Inflation Pressures.....	9-32
Check Tire Inflation Pressure.....	9-33
Tire Rotation .....	9-34
Wheel Alignment and Tire Balance.....	9-35
Tire Replacement .....	9-35
Wheel Replacement.....	9-37
Tire Traction .....	9-37
Tire Maintenance.....	9-37
Tire Sidewall Labeling .....	9-37
Tire Terminology and Definitions .....	9-40
All Season Tires.....	9-43
Summer Tires .....	9-43
Snow Tires.....	9-43
Radial-Ply Tires.....	9-43
Low Aspect Ratio Tires.....	9-44
Fuses.....	9-45
Instrument Panel Fuse Replacement.....	9-46
Engine Compartment Panel Fuse Replacement.....	9-47
Fuse/Relay Panel Description.....	9-48
Light Bulbs.....	9-55
Headlight, Parking Lamp, Daytime Running Light, Turn Signal Lamp and Side Marker.....	9-55
Side Repeater Lamp Replacement (if equipped).....	9-57
Rear Combination Lamp Bulb Replacement.....	9-57
High Mounted Stop Lamp Replacement .....	9-60
License Plate Light Bulb Replacement .....	9-60
Interior Light Bulb Replacement.....	9-61
Appearance Care .....	9-63
Exterior Care .....	9-63
Interior Care.....	9-69
Emission Control System.....	9-72
Crankcase Emission Control System .....	9-72
Evaporative Emission Control System Including Onboard Refueling Vapor Recovery (ORVR).....	9-72
Exhaust Emission Control System.....	9-73
California Perchlorate Notice.....	9-75

## ENGINE COMPARTMENT

■ Gasoline 1.6 GDi HEV

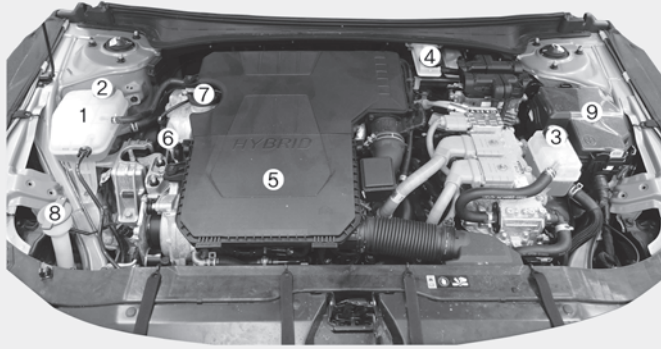

**The actual engine compartment in the vehicle may differ from the illustration.**

OCN7H093001

- |                                 |                                      |
|---------------------------------|--------------------------------------|
| 1. Engine coolant reservoir     | 6. Engine oil dipstick               |
| 2. Engine coolant reservoir cap | 7. Engine oil filler cap             |
| 3. Inverter coolant reservoir   | 8. Windshield washer fluid reservoir |
| 4. Brake fluid reservoir        | 9. Fuse box                          |
| 5. Air cleaner                  |                                      |

## MAINTENANCE SERVICES

You should exercise the utmost care to prevent damage to your vehicle and injury to yourself whenever performing any maintenance or inspection procedures.

Have your vehicle maintained and repaired by an authorized HYUNDAI dealer. An authorized HYUNDAI dealer meets HYUNDAI's high service quality standards and receives technical support from HYUNDAI in order to provide you with a high level of service satisfaction.

### Owner's Responsibility

Maintenance service and record retention are the owner's responsibility.

You should retain documents that show proper maintenance has been performed on your vehicle in accordance with the scheduled maintenance service charts shown on the following pages. You need this information to establish your compliance with the servicing and maintenance requirements of your vehicle warranties.

Detailed warranty information is provided in your Owner's Handbook & Warranty Information booklet.

Repairs and adjustments required as a result of improper maintenance or a lack of required maintenance are not covered.

### Owner Maintenance Precautions

Inadequate, incomplete or insufficient servicing may result in operational problems with your vehicle that could lead to vehicle damage, an accident, or personal injury. This chapter provides instructions only for the maintenance items that are easy to perform. Several procedures can be done only by an authorized HYUNDAI dealer with special tools.

Your vehicle should not be modified in any way. Such modifications may adversely affect the performance, safety or durability of your vehicle and may, in addition, violate conditions of the limited warranties covering the vehicle.

Certain modifications may also be in violation of regulations established by the U.S. Department of Transportation and other federal or state agencies.

#### **NOTICE**

**Improper owner maintenance during the warranty period may affect warranty coverage. For details, read the separate Owner's Handbook & Warranty Information booklet provided with the vehicle. If you're unsure about any service or maintenance procedure, have it done by an authorized HYUNDAI dealer.**

## OWNER MAINTENANCE



### WARNING

Performing maintenance work on a vehicle can be dangerous. If you lack sufficient knowledge and experience or the proper tools and equipment to do the work, have it done by an authorized HYUNDAI dealer.

**ALWAYS** follow these precautions for performing maintenance work:

- Park your vehicle on level ground, move the shift lever into the P (Park) position, place the ignition switch in the LOCK/OFF position.
- Block the tires (front and back) to prevent the vehicle from moving. Remove loose clothing or jewelry that can become entangled in moving parts.
- If you must run the engine during maintenance, do so in an outdoor area or in an area with plenty of ventilation.
- Keep flames, sparks, or smoking materials away from the battery and fuel-related parts.

The following lists are vehicle checks and inspections that should be performed by the owner or an authorized HYUNDAI dealer at the frequencies indicated to help ensure safe, dependable operation of your vehicle.

Any adverse conditions should be brought to the attention of your dealer as soon as possible.

These Owner Maintenance vehicle checks are generally not covered by warranties and you may be charged for labor, parts and lubricants used.

### Owner Maintenance Schedule

#### ***When you stop for fuel:***

- Check the coolant level in the engine coolant reservoir.
- Check the windshield washer fluid level.
- Check the for low or under-inflated tires.
- Check the radiator and condenser.
- Check if the front of the radiator and condenser are clean and not blocked with leaves, dirt or insects etc. If any of the above parts are extremely dirty or you are not sure of their condition, have you contact an authorized HYUNDAI dealer.



### WARNING

**Be careful when checking your engine coolant level when the engine is hot. This may result in coolant being blown out of the opening and cause serious burns and other injuries.**

### ***While operating your vehicle:***

- Note any changes in the sound of the exhaust or any smell of exhaust fumes in the vehicle.
- Check for vibrations in the steering wheel. Notice if there is any increased steering effort or looseness in the steering wheel, or change in its straight-ahead position.
- Notice if your vehicle constantly turns slightly or “pulls” to one side when traveling on smooth, level road.
- When stopping, listen and check for unusual sounds, pulling to one side, increased brake pedal travel or “hard-to-push” brake pedal.
- If any slipping or changes in the operation of your transmission occurs, check the transmission fluid level.
- Check the dual clutch transmission P (Park) function.
- Check the parking brake.
- Check for fluid leaks under your vehicle (water dripping from the air conditioning system during or after use is normal).

### ***At least monthly:***

- Check coolant level in the engine coolant reservoir.
- Check the operation of all exterior lights, including the brake lights, turn signals and hazard warning flashers.
- Check the inflation pressures of all tires including the spare for tires that are worn, show uneven wear, or are damaged.
- Check for loose wheel lug nuts.

### ***At least twice a year: (for example, every Spring and Autumn)***

- Check radiator, heater and air conditioning hoses for leaks or damage.
- Check windshield washer spray and wiper operation. Clean wiper blades with a clean cloth dampened with washer fluid.
- Check headlight alignment.
- Check muffler, exhaust pipes, shields and clamps.
- Check the seat belts for wear and function.

### ***At least once a year:***

- Clean body and door drain holes.
- Lubricate door hinges and hood hinges.
- Lubricate door and hood locks and latches.
- Lubricate door rubber weather strips.
- Lubricate door checker.
- Check the air conditioning system.
- Inspect and lubricate dual clutch transmission linkage and controls.
- Clean the battery and terminals.
- Check the brake fluid level.

## SCHEDULED MAINTENANCE SERVICES

Follow Normal Maintenance Schedule if the vehicle is usually operated where none of the following conditions apply. If any of the following conditions apply, you must follow the Maintenance Under Severe Usage Conditions.

- Repeatedly driving short distance of less than 5 miles (8 km) in normal temperature of less than 5 miles (16 km) in freezing temperature.
- Extensive engine idling or low speed driving for long distances.
- Driving on rough, dusty, muddy, unpaved, graveled or salt- spread roads.
- Driving in areas using salt or other corrosive materials or in very cold weather.
- Driving in heavy dust condition.
- Driving in heavy traffic area.
- Driving on uphill, downhill, or mountain roads repeatedly.
- Using for towing or camping, and driving with loading on the roof.
- Driving as a patrol car, taxi, other commercial use of vehicle towing.
- Frequently driving under high speed or rapid acceleration.
- Frequently driving in stop-and-go conditions.
- Engine oil usage which is not recommended (Mineral type, Semi-synthetic, Lower grade spec, etc.)

### **NOTICE**

**After driving more than 10 years or 100,000 miles, use severe maintenance schedule.**

### Normal Maintenance Schedule

The following maintenance services must be performed to ensure good emission control and performance. Keep receipts for all vehicle emission services to protect your warranty. Where both mileage and time are shown, the frequency of service is determined by whichever occurs first.

MAINTENANCE ITEM	MAINTENANCE INTERVALS															
	Months	12	24	36	48	60	72	84	96	108	120	132	144	156	168	180
Miles x 1,000	8	16	24	32	40	48	56	64	72	80	88	96	104	112	120	
Km x 1,000	13	26	39	52	65	78	91	104	117	130	143	156	169	182	195	
Engine oil and engine oil filter *1*2	Replace every 8,000 miles (13,000 km) or 12 month															
Fuel additives *3	R	R	R	R	R	R	R	R	R	R	R	R	R	R	R	R
Air cleaner filter	I	I	R	I	R	I	R	I	R	I	R	I	R	I	R	I

I : Inspect and if necessary, adjust, correct, clean or replace.

R : Replace or change.

\*1: Check the engine oil level and leak every 500 km (350 miles) or before starting a long trip.

\*2: Never add any additives to the engine oil. Engine oil additives can change the properties of engine oil and may cause serious engine failure.

\*3: If good quality gasolines or equivalents including fuel additives is not available, one bottle of additive is recommended.

Additives are available from your authorized HYUNDAI dealer along with information on how to use them. Do not mix other additives.

\* As it is normal for engine oil to be consumed during driving, the amount of engine oil should be checked regularly.

\* The replacement cycle of engine oil is set by the period which the performance of our recommended engine oil is maintained. So if recommended engine oil is not used, a replacement is required as indicated severe usage condition.

## Normal Maintenance Schedule

MAINTENANCE INTERVALS	Number of months or driving distance, whichever comes first															
	Months	12	24	36	48	60	72	84	96	108	120	132	144	156	168	180
MAINTENANCE ITEM	Miles x 1,000	8	16	24	32	40	48	56	64	72	80	88	96	104	112	120
	Km x 1,000	13	26	39	52	65	78	91	104	117	130	143	156	169	182	195
Spark plugs *4		Replace every 96,000 miles (156,000 km)														
Vapor hose and fuel filler cap		I	I	I	I	I	I	I	I	I	I	I	I	I	I	I
Fuel tank air filter		I	R	I	I	I	I	I	R	I	I	I	R	I	I	I
Fuel lines, hoses and connection		I	I	I	I	I	I	I	I	I	I	I	I	I	I	I
HSG (Hybrid Starter & Generator) belt *5		Inspect every 8,000 miles (12,000 km) or 12 months, and replace every 64,000 miles (104,000 km) or 48 months.														

I : Inspect and if necessary, adjust, correct, clean or replace.

R : Replace or change.

\*4 : For your convenience, it can be replaced prior to it's interval when you do maintenance of other items.

\*5 : Inspect HSG belt for evidence of cuts, cracks, excessive wear or oil saturation and replace if necessary. If drive belt noise occurred, readjust drive belt tension before replace.

Fuel filter : The fuel filter is considered to be maintenance free but periodic inspection is recommended for this maintenance schedule depends on fuel quality. If there are some important matters like fuel flow restriction, surging, loss of power, hard starting problem etc., place the fuel filter immediately regardless of maintenance schedule and consult with an authorized HYUNDAI dealer for details.

### Normal Maintenance Schedule

MAINTENANCE INTERVALS		Number of months or driving distance, whichever comes first														
		12	24	36	48	60	72	84	96	108	120	132	144	156	168	180
MAINTENANCE ITEM	Months	8	16	24	32	40	48	56	64	72	80	88	96	104	112	120
	Miles x 1,000	13	26	39	52	65	78	91	104	117	130	143	156	169	182	195
Km x 1,000																
Cooling system		I	I	I	I	I	I	I	I	I	I	I	I	I	I	I
Engine coolant / Inverter coolant *6		At first, replace at 120,000 miles (200,000 km) or 120 months After that, replace every 24,000 miles (39,000 km) or 24 months *7														
All electrical systems		I	I	I	I	I	I	I	I	I	I	I	I	I	I	I
Dual clutch transmission fluid *8		No check, no service required														
Engine clutch actuator fluid		Replace every 24,000 miles (39,000 km) or 24 months Inspect every 8,000 miles (13,000 km) or 12 months														
Engine clutch actuator hose and line		I	I	I	I	I	I	I	I	I	I	I	I	I	I	I
Brake lines, hoses and connections		I	I	I	I	I	I	I	I	I	I	I	I	I	I	I
Brake pedal		I	I	I	I	I	I	I	I	I	I	I	I	I	I	I
Brake fluid		Inspect every 8,000 miles (13,000 km) or 12 months, and replace every 48,000 miles (78,000 km) or 48 months														
Brake discs and pads		I	I	I	I	I	I	I	I	I	I	I	I	I	I	I

I : Inspect and if necessary, adjust, correct, clean or replace.

R : Replace or change.

\*6: When adding coolant, use only deionized water or soft water for your vehicle and never mix hard water in the coolant filled at the factory.

\*7: For your convenience, it can be replaced prior to it's interval when you do maintenance of other items.

\*8: Dual Clutch Transmission (DCT) fluid should be changed anytime it has been submerged in water.

## Normal Maintenance Schedule

MAINTENANCE INTERVALS	Number of months or driving distance, whichever comes first															
	Months	12	24	36	48	60	72	84	96	108	120	132	144	156	168	180
MAINTENANCE ITEM	Miles x 1,000	8	16	24	32	40	48	56	64	72	80	88	96	104	112	120
	Km x 1,000	13	26	39	52	65	78	91	104	117	130	143	156	169	182	195
Steering gear rack, linkage and boots		I	I	I	I	I	I	I	I	I	I	I	I	I	I	I
Driveshaft and boots		I														
Rotate Tires (Includes Tire Pressure and Tread Wear Inspection)		Rotate every 8,000 miles (13,000 km) or 12 months														
Front suspension ball joints		I	I	I	I	I	I	I	I	I	I	I	I	I	I	I
Bolt and nuts on chassis and body		I	I	I	I	I	I	I	I	I	I	I	I	I	I	I
Air conditioner refrigerant		I	I	I	I	I	I	I	I	I	I	I	I	I	I	I
Air conditioner compressor		I	I	I	I	I	I	I	I	I	I	I	I	I	I	I
Cabin air filter		I	R	I	R	I	R	I	R	I	R	I	R	I	R	I
Exhaust system		I														

I : Inspect and if necessary, adjust, correct, clean or replace.

R : Replace or change.

### Maintenance Under Severe Usage Conditions

The following items must be serviced more frequently on cars mainly used under severe driving conditions. Refer to the chart below for the appropriate maintenance intervals.

R : Replace

I : Inspect and if necessary, adjust, correct, clean or replace

Maintenance item	Maintenance operation	Maintenance Intervals	Driving condition
Engine oil and engine oil filter	R	Replace every 3,750 miles (6,000 km) or 6 months	A, B, C, D, E, F, G, H, I, J, K, L
Air cleaner filter	R	Replace more frequently depending on the condition	C, E
Spark plugs	R	Replace more frequently depending on the condition	A, B, F, G, H, I, K
HSG (Hybrid Starter & Generator) belt	R	Every 30,000 miles (48,000 km) or 24 months	B, C, D, E, I, K
	I	Every 5,000 miles (8,000 km) or 6 months	
Dual clutch transmission fluid	R	Every 80,000 miles (120,000 km)	C, D, E, F, G, H, I, J

## Maintenance Under Severe Usage Conditions

Maintenance item	Maintenance operation	Maintenance Intervals	Driving condition
Steering gear rack, linkage and boots	I	Inspect more frequently depending on the condition	C, D, E, F, G
Front suspension ball joints	I	Inspect more frequently depending on the condition	C, D, E, F, G
Disc brakes and pads, calipers and rotors	I	Inspect more frequently depending on the condition	C, D, E, G, H
Parking brake	I	Inspect more frequently depending on the condition	C, D, G, H
Driveshaft and boots	I	Inspect more frequently depending on the condition	C, D, E, F, G, H, I, J
Cabin air filter	R	Replace more frequently depending on the condition	C, E, G

### **Severe driving conditions**

- A. Repeatedly driving short distance of less than 5 miles (8 km) in normal temperature or less than 10 miles (16 km) in freezing temperature
- B. Extensive engine idling or low speed driving for long distances
- C. Driving on rough, dusty, muddy, unpaved, graveled or salt-spread roads
- D. Driving in areas using salt or other corrosive materials or in very cold weather
- E. Driving in heavy dust conditions
- F. Driving in heavy traffic area
- G. Driving on uphill, downhill, or mountain roads repeatedly
- H. Using for towing or camping, and driving with loading on the roof.
- I. Driving for patrol car, taxi, other commercial use of vehicle towing
- J. Frequently driving under high speed or rapid acceleration.
- K. Frequently driving in stop-and-go conditions
- L. Engine oil usage which is not recommended (Mineral type, Semi-synthetic, Lower grade spec, etc.)

## EXPLANATION OF SCHEDULED MAINTENANCE ITEMS

### Engine Oil and Filter

The engine oil and filter should be changed at the intervals specified in the maintenance schedule. If the vehicle is being driven in severe conditions, more frequent oil and filter changes are required.

### Drive Belts

Inspect all drive belts for evidence of cuts, cracks, excessive wear or oil saturation and replace if necessary. Drive belts should be checked periodically for proper tension and adjusted as necessary.

### Fuel Filter

A clogged-up fuel filter may limit the vehicle driving speed, damage the emission system, and cause the hard starting. When a considerable amount of foreign substances are accumulated in the fuel tank, the fuel filter should be replaced.

Upon installing a new fuel filter, operate the engine for several minutes, and check the connections for any leakages. Fuel filters should be installed by an authorized HYUNDAI dealer.

### HSG (Hybrid Starter & Generator) Belt

The HSG belt should be changed at the intervals specified in the maintenance schedule.

### Fuel Lines, Fuel Hoses and Connections

Check the fuel lines, fuel hoses and connections for leakage and damage. Have an authorized HYUNDAI dealer replace any damaged or leaking parts immediately.

### Vapor Hose and Fuel Filler Cap

The vapor hose and fuel filler cap should be inspected at those intervals specified in the maintenance schedule. Make sure a new vapor hose or fuel filler cap is correctly replaced.

### Air Cleaner Filter

A genuine HYUNDAI air cleaner filter is recommended when the filter is replaced.

### Spark Plugs

Make sure to install new spark plugs of the correct heat range.

When assembling parts, be sure to wipe out foreign substances inside and outside of the boot bottom of the ignition coil and the insulator of the spark plug with a soft cloth to prevent contamination of the spark plug insulator.

### Cooling System

Check cooling system components, such as radiator, coolant reservoir, hoses and connections for leakage and damage. Replace any damaged parts.

### **Engine Coolant/Inverter Coolant**

The coolant should be changed at the intervals specified in the maintenance schedule.

### **Dual Clutch Transmission Fluid**

Dual clutch transmission fluid should not be checked under normal usage conditions.

Have Intelligent variable transmission fluid changed by an authorized HYUNDAI dealer according to the maintenance schedule.

### **Brake Hoses and Lines**

Visually check for proper installation, chafing, cracks, deterioration and any leakage. Replace any deteriorated or damaged parts immediately.

### **Brake Fluid**

Check the brake fluid level in the brake fluid reservoir. The level should be between the MIN and the MAX marks on the side of the reservoir. Use only hydraulic brake fluid conforming to DOT 4 specification..

### **Brake Discs, Pads, Calipers and Rotors**

Check the pads for excessive wear, discs for run out and wear, and calipers for fluid leakage.

### **Suspension Mounting Bolts**

Check the suspension connections for looseness or damage. Retighten to the specified torque.

### **Steering Gear Box, Linkage & Boots/Lower Arm Ball Joint**

With the vehicle stopped and the engine off, check for excessive freeplay in the steering wheel. Check the linkage for bends or damage. Check the dust boots and ball joints for deterioration, cracks, or damage.

Replace any damaged parts.

### **Drive Shafts and Boots**

Check the drive shafts, boots and clamps for cracks, deterioration, or damage. Replace any damaged parts and, if necessary, repack the grease.

### **Air Conditioning Refrigerant**

Check the air conditioning lines and connections for leakage and damage.

## ENGINE OIL

### Checking the Engine Oil Level

Engine oil is used for lubrication and cooling, so it is gradually consumed during driving the vehicle.

Regularly check and manage the oil level using the following procedure.

1. Follow all of the oil manufacturer's precautions.
2. Be sure the vehicle is on the level ground in P (Park) with the parking brake set. If possible, block the wheels.
3. Turn the engine on and allow the engine to reach normal operating temperature.
4. Turn the engine off and wait about 15 minutes (with oil filler cap and dipstick detached) for the oil to return to the oil pan.
5. Pull the dipstick out, wipe it clean, and re-insert it fully.

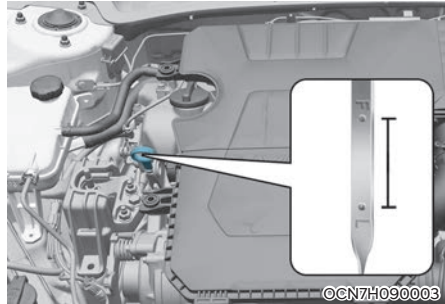

6. Pull the dipstick out again and check the level.

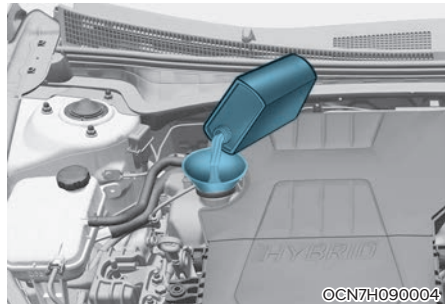

7. If the oil level is below L, add enough oil to bring the level to F. Use only the specified engine oil. (refer to “Recommended Lubricants and Capacities” in chapter 2).

**NOTICE**

To prevent damage to your engine:

- Do not spill engine oil when adding or changing engine oil. Wipe off spilled oil immediately.
- The engine oil consumption may increase while you break in a new vehicle and it will be stabilized after driving 4,000 miles (6,000 km).
- The engine oil consumption can be affected by driving habits, climate conditions, traffic conditions, oil quality, etc. Therefore, inspect the engine oil level regularly and refill it if necessary.
- The engine oil change interval is set for the purpose of preventing oil deterioration, and is not related the amount of oil consumption; so, check and refill the amount of the oil regularly.

## Checking the Engine Oil and Filter



- Have engine oil and filter changed by an authorized HYUNDAI dealer according to the Maintenance Schedule at the beginning of this chapter.
- If exceeding the maintenance schedule for replacement of engine oil, the engine oil performance may deteriorate and the engine condition may be affected. Therefore, the replacement cycle should be observed.
- If the maintenance schedule to replace engine oil is exceeded, the engine oil performance may deteriorate, and the engine condition may be affected. Therefore, replace the engine oil according to the maintenance schedule.
- To keep the engine in optimal condition, use the recommended engine oil and filter. If the recommended engine oil and filter are not used, replace it according to the maintenance schedule under severe usage conditions.
- The purpose of the maintenance schedule for engine oil replacement is to prevent oil deterioration and it is irrelevant to oil consumption. Check and refill engine oil regularly.



### **CAUTION**

The engine oil is very hot immediately after the vehicle has been driven and can cause burns during replacement. Replace the engine oil after the engine oil has cooled down.



### **WARNING**

#### **CALIFORNIA PROPOSITION 65 WARNING**

Engine oil contains chemicals known to the State of California to cause cancer, birth defects and reproductive harm. Used engine oil may cause irritation or cancer of the skin if left in contact with the skin for prolonged periods of time. Always protect your skin by washing your hands thoroughly with soap and warm water as soon as possible after handling used oil.

### **NOTICE**

Never add any additives to the engine oil. Engine oil additives can change the properties of engine oil and may cause serious engine failure.

## ENGINE COOLANT/INVERTER COOLANT

The high-pressure cooling system has a reservoir filled with year-round antifreeze coolant. The reservoir is filled at the factory.

Check the antifreeze protection and coolant level at least once a year, at the beginning of the winter season and before traveling to a colder climate.

### NOTICE

- **When the engine overheats by low level of the engine coolant, suddenly adding engine coolant may cause cracks in the engine. To prevent damage, add engine coolant slowly in small quantities.**
- **Do not drive with no engine coolant. It may cause water pump failure and engine seizure, etc.**

### Checking the Coolant Level

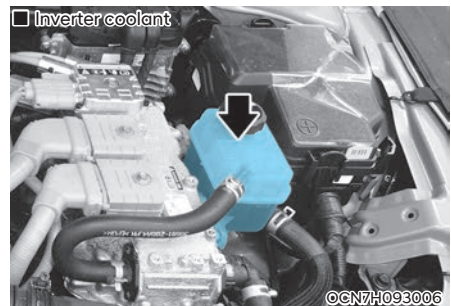
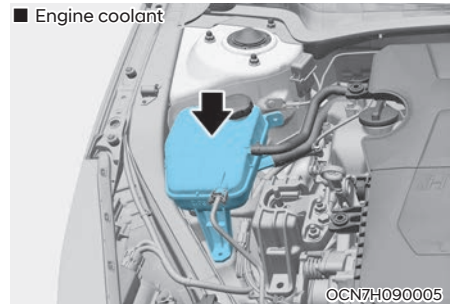

Check the condition and connections of all cooling system hoses and heater hoses. Replace any swollen or deteriorated hoses.

The coolant level should be filled between the MAX and the MIN marks on the side of the coolant reservoir when the engine is cool.

If the coolant level is low, add the selected anti-freeze according to the proper coolant mix ratio to bring the level to the MAX mark, but do not overfill. If frequent additions are required, see an authorized HYUNDAI dealer for a cooling system inspection.

 **WARNING**

■ Engine coolant cap

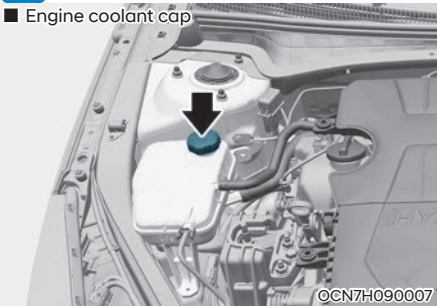

■ Inverter coolant cap

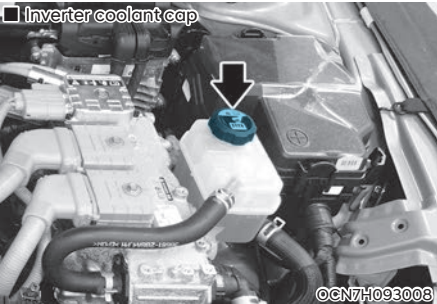

1. Check if the radiator cap label is straight in front.
2. Make sure that the tiny protrusions inside the radiator cap should be securely interlocked.

 **WARNING**



Never remove the engine coolant cap and/or inverter coolant cap or the drain plug while the engine and radiator are hot. Hot coolant and steam may blow out under pressure, causing serious injury.

Turn the vehicle off and wait until the engine cools down. Use extreme care when removing the engine coolant cap and/or inverter coolant cap. Wrap a thick towel around it, and turn it counterclockwise slowly while the pressure is released from the cooling system. When you are sure all the pressure has been released, using a thick towel, continue turning counterclockwise to remove it.

 **Information**

The engine coolant and/or inverter coolant level is influenced by the hybrid system temperature. Before checking or refilling the engine coolant and/or inverter coolant, turn the hybrid vehicle off.

 **WARNING**



The electric motor for the cooling fan may continue to operate or start up when the engine is not running and can cause serious injury. Keep hands, clothing and tools away from the rotating fan blades of the cooling fan.

Keep hands, clothing and tools away from the rotating fan blades of the cooling fan.

Always turn off the vehicle unless the vehicle has to be inspected with the engine on. Be cautious as the cooling fan may operate until you disconnect the battery connector.

## WARNING

Make sure the coolant cap is properly closed after refilling coolant. Otherwise the engine could be overheated while driving.

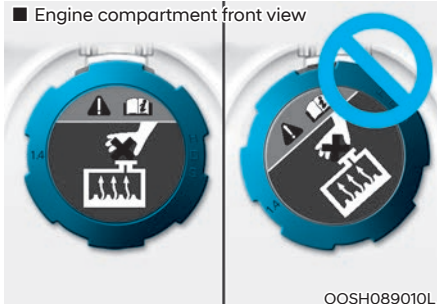

1. Check if the coolant cap label is straight in front.

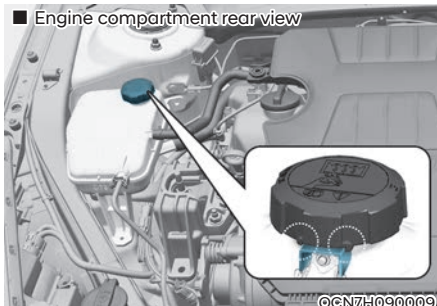

2. Make sure that the tiny protrusions inside the coolant cap are securely interlocked.

## Recommended engine coolant

- When adding coolant, use only distilled (deionized) water for your vehicle and never mix hard water in the coolant filled at the factory.
- An improper coolant mixture can result in severe malfunction or engine damage.
- The engine in your vehicle has aluminum engine parts and must be protected by an ethylene-glycol with phosphate based coolant to prevent corrosion and freezing.
- Do not use alcohol or methanol coolant or mix them with the specified coolant.
- Do not use a solution that contains more than 60% antifreeze or less than 35% antifreeze, which would reduce the effectiveness of the solution.

For mixing percentage, refer to the following table:

Ambient Temperature	Mixture Percentage (volume)	
	Antifreeze	Water
5°F (-15°C)	35	65
-13°F (-25°C)	40	60
-31°F (-35°C)	50	50
-49°F (-45°C)	60	40

## Information

If in doubt about the mix ratio, a 50% water and 50% antifreeze mix is the easiest to mix together as it will be the same quantity of each. It is suitable to use for most temperature ranges of -31°F and higher.



**WARNING**



The electric motor for the cooling fan may continue to operate or start up when the engine is not running and can cause serious injury. Keep hands, clothing and tools away from the rotating fan blades of the cooling fan.



The electric motor for the cooling fan is controlled by engine coolant temperature, refrigerant pressure and vehicle speed. As the engine coolant temperature decreases, the electric motor will automatically shut off. This is a normal condition.

### Changing Engine Coolant

Have coolant changed by an authorized HYUNDAI dealer according to the Maintenance Schedule at the beginning of this chapter.



**WARNING**

**Do not use engine coolant or antifreeze in the washer fluid reservoir.**

**Engine coolant can severely obscure visibility when sprayed on the windshield and may cause loss of vehicle control resulting in an accident.**

**Engine coolant may also cause damage to paint and body trim.**

**NOTICE**

**To prevent damage to engine parts, put a thick towel around the radiator cap before refilling the coolant to prevent the coolant from overflowing into engine parts, such as the alternator.**

## HYBRID STARTER & GENERATOR (HSG) BELT

### Checking the Hybrid Starter & Generator (HSG) Belt

Have the Hybrid Starter & Generator (HSG) belt inspected or replaced according to the Maintenance Schedule in this chapter by an authorized HYUNDAI dealer.



#### **CAUTION**

**When the HSG belt is worn out or damaged, replace the belt.**

**Otherwise, it may cause engine overheating or battery discharge.**



#### **WARNING**

- **Turn the vehicle off while you inspect the engine or Hybrid Starter & Generator (HSG) belt. Otherwise it may result in serious injury.**
- **Keep hands, clothing etc. away from the Hybrid Starter & Generator (HSG) belt.**

## BRAKE FLUID

### Checking the Brake Fluid Level

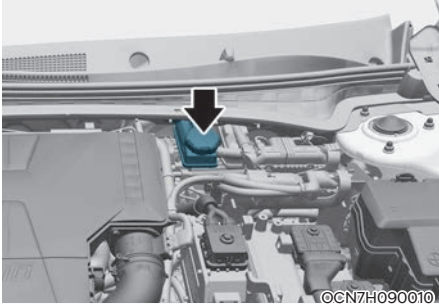

Check the fluid level in the reservoir periodically. The fluid level should be between MAX and MIN marks on the side of the reservoir.

Before removing the reservoir cap and adding brake fluid, clean the area around the reservoir cap thoroughly to prevent brake fluid contamination.

If the level is low, add fluid to the MAX level. The level will fall with accumulated mileage. This is a normal condition associated with the wear of the brake linings.

If the fluid level is excessively low, have the system checked by an authorized HYUNDAI dealer.

#### **i** Information

Use only the specified brake fluid. Refer to “Recommended lubricants and capacities” in chapter 2.

#### **i** Information

Before removing the brake filler cap, read the warning on the cap.

#### **i** Information

Clean the filler cap before removing. Use only DOT4 brake fluid from a sealed container.

#### **!** WARNING

Do not let brake fluid enter into your eyes. If brake fluid gets in your eyes, flush your eyes with clean water for at least 15 minutes and get immediate medical attention.

#### **NOTICE**

- Do not allow brake fluid to contact the vehicle's body paint, as it will result in paint damage.
- NEVER use brake fluid which has been exposed to open air for an extended time, as its quality cannot be guaranteed.
- Don't put in the wrong type of fluid. A few drops of mineralbased oil such as engine oil in your brake system can damage system parts.
- To maintain the best braking performance and ABS/ESC performance, use genuine brake fluid that conform to specifications.  
(Standard : SAE J1704 DOT-4 LV, ISO4925 CLASS-6 and FMVSS 116 DOT-4)

## ENGINE CLUTCH ACTUATOR FLUID

### Checking the Engine Clutch Actuator Fluid Level

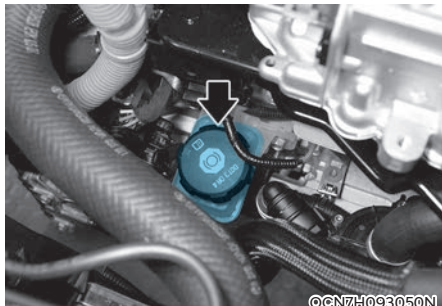

In normal driving conditions, the actuator fluid level does not go down rapidly. However, oil consumption rate may rise as vehicle mileage increases, and leak-age in actuator related parts may result in increased consumption of the engine clutch actuator oil. Regularly check and make sure the engine clutch actuator oil fluid level is between MIN and MAX marks.

If the oil level is below MIN mark, have the vehicle checked by an authorized Hyundai dealer.

If the fluid level is excessively low, have the system checked by an authorized Hyundai dealer.

Use only the specified engine clutch actuator fluid. (Refer to “Recommended lubricants and capacities” on page 2-12.)

Never mix different types of fluid.

- Check the fluid level in the engine clutch actuator fluid reservoir and add fluid if necessary.

The reservoir is translucent so that you can check the level with a quick visual inspection.



### CAUTION

Do not allow the engine clutch actuator fluid to contact the vehicle's body paint, as paint damage will result. The engine clutch actuator fluid, which has been exposed to open air for an extended time should never be used as its quality cannot be guaranteed. It should be properly disposed. Don't put in the wrong kind of fluid. A few drops of mineral-based oil, such as engine oil, in your engine clutch system can damage engine clutch system parts.



### WARNING

- In the event the engine clutch system requires frequent additions of fluid, have the system inspected by an authorized Hyundai dealer.
- When changing and adding the engine clutch actuator fluid, handle it carefully. Do not let it come in contact with your eyes. If engine clutch actuator fluid should come in contact with your eyes, immediately flush them with a large quantity of fresh tap water. Have your eyes examined by a doctor as soon as possible.

## WASHER FLUID

### Checking the Washer Fluid Level

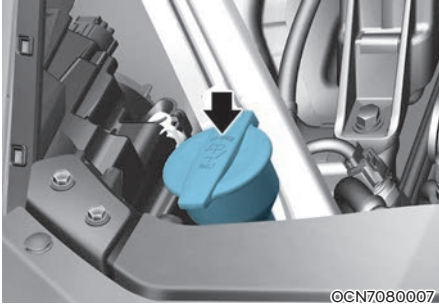

Check the fluid level in the washer fluid reservoir and add fluid if necessary. Plain water may be used if washer fluid is not available. However, use washer solvent with antifreeze characteristics in cold climates to prevent freezing.



### WARNING

To prevent serious injury or death, take the following safety precautions when using washer fluid:

- Do not use engine coolant or antifreeze in the washer fluid reservoir.  
Engine coolant can severely obscure visibility when sprayed on the windshield and may cause loss of vehicle control resulting in an accident or damage to paint and body trim.
- Do not allow sparks or flames to contact the washer fluid or the washer fluid reservoir. Washer fluid may contain alcohol and can be flammable.
- Do not drink washer fluid and avoid contact with skin. Washer fluid is harmful to humans and animals.
- Keep washer fluid away from children and animals.

## AIR CLEANER

### Filter Replacement

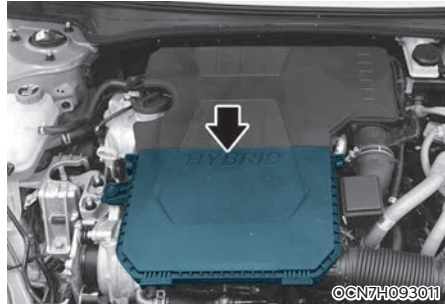

The air cleaner filter can be cleaned for inspection using compressed air. Do not attempt to wash or to rinse it, as water will damage the filter. If soiled, the air cleaner filter must be replaced.

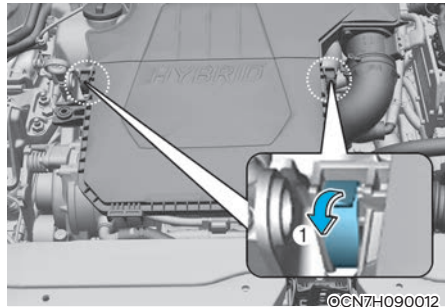

1. Loosen the air cleaner cover attaching clip (1) and open the cover.

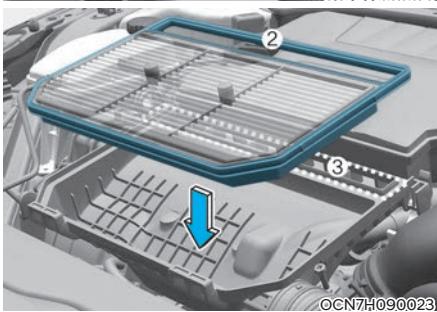
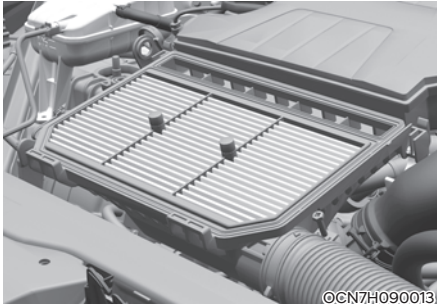

2. Replace the air cleaner filter. Insert (2) completely into (3).

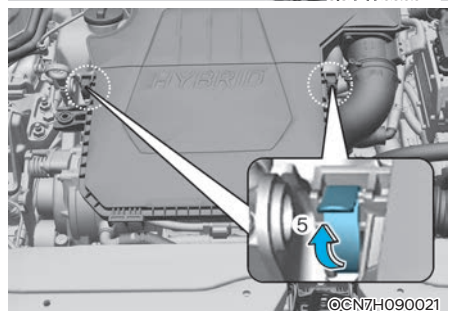
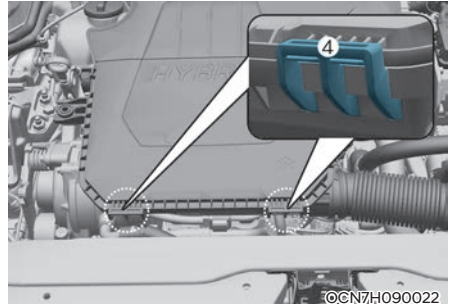

3. Insert the air cleaner cover in the hinge (4) and engage the clip (5) after closing the cover.
4. Check that the cover is firmly installed.

### **i** Information

If the vehicle is operated in extremely dusty or sandy areas, replace the element more often than the usual recommended intervals (refer to “Maintenance Under Severe Usage Conditions” in this chapter).

### **NOTICE**

- Do not drive with the air cleaner filter removed. This will result in excessive engine wear.
- When removing the air cleaner filter, be careful that dust or dirt does not enter the air intake, or damage may result.
- Use HYUNDAI genuine parts. Use of non-genuine parts could damage the engine.

## CABIN AIR FILTER

### Filter Inspection

The cabin air filter should be replaced according to the Maintenance Schedule. If the vehicle is operated in severely air-polluted cities or on dusty rough roads for a long period, it should be inspected more frequently and replaced earlier. When you replace the cabin air filter, replace it performing the following procedure, and be careful to avoid damaging other components.

### Filter Replacement

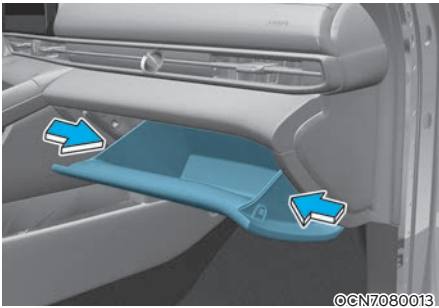

1. Push in both sides of the glove box as shown. This will ensure that the glove box stopper pins will get released from its holding location allowing the glove box to hang.

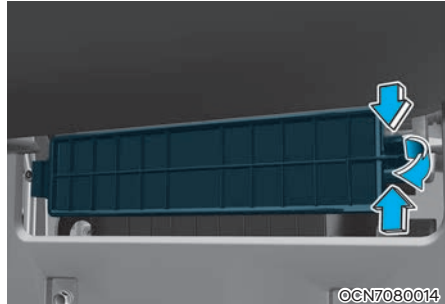

2. Remove the cabin air filter case while pressing the lock on the right side of the cover.

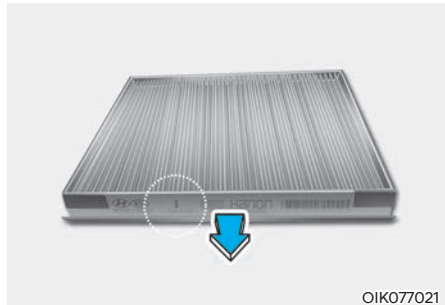

3. Replace the cabin air filter.
4. Reassemble in the reverse order of disassembly.

### NOTICE

Install a new cabin air filter in the correct direction with the arrow symbol (⇓) facing downwards, otherwise, it may be noisy and the effectiveness of the filter may be reduced.

## WIPER BLADES

### Blade Inspection

Contamination of either the windshield or the wiper blades with foreign matter can reduce the effectiveness of the windshield wiper functionality. Common sources of contamination are insects, tree sap, and hot wax treatments used by some commercial car washes. If the blades are not wiping properly, clean both the window and the blades with a clean cloth dampened with washer fluid.

#### **NOTICE**

To prevent damage to the wiper blades, arms or other components, do not:

- Use gasoline, kerosene, paint thinner, or other solvents on or near them.
- Attempt to move the wipers manually.
- Use non-specified wiper blades.

### **i** Information

Commercial hot waxes applied by automatic car washes have been known to make the windshield difficult to clean.

### Blade Replacement

When the wipers no longer clean adequately, the blades may be worn or cracked, and require replacement.

#### **NOTICE**

- In order to prevent damage to the hood and the wiper arms, the wiper arms should only be lifted when in the top wiping position.
- Always return the wiper arms to the windshield before driving.

#### **NOTICE**

The use of a non-specified wiper blade could result in wiper malfunction and failure.

### Front windshield wiper service positions

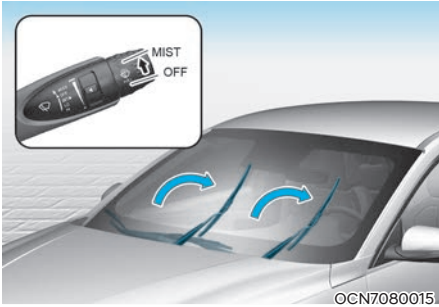

This vehicle has a “hidden” wiper design which means that the wipers cannot be lifted when they are in their bottom resting position.

1. Within 20 seconds of turning off the engine, lift and hold the wiper lever up to the MIST position for about 2 seconds until the wipers move to the top wiper position.
2. At this time you can lift the wipers off the windshield.
3. Gently put the wipers back down onto the windshield.
4. Turn the wipers to any ON position to return the wipers to the bottom resting position.

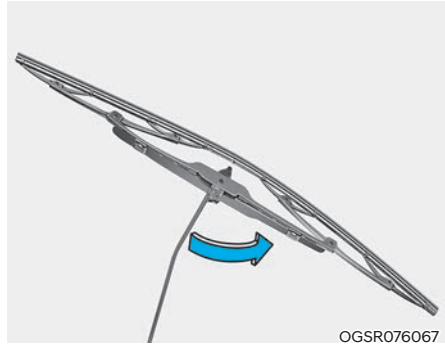

1. Raise the wiper arm.

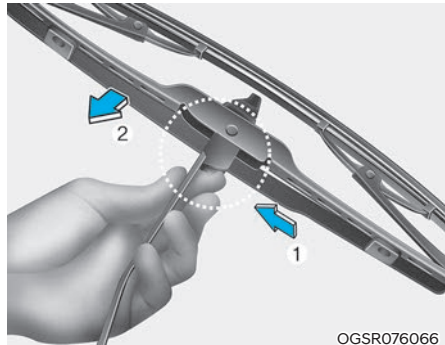

2. Lift up the wiper blade clip. Then pull down the blade assembly and remove it.



3. Install the new blade assembly.
4. Return the wiper arm on the windshield.

## BATTERY

### 12 V auxiliary battery

The 12 V auxiliary battery of the vehicle is integrated within the high-voltage battery. The high-voltage battery is located under the seat cushion.

For battery related servicing, contact an authorized HYUNDAI dealer.

### 12 V auxiliary battery connector

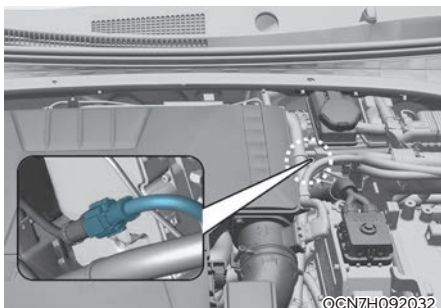

Disconnect the 12 V auxiliary battery connector located inside the engine room compartment to shut down the power of the 12 V auxiliary battery.

Connect the 12 V auxiliary battery connector again after the battery related maintenance is finished.



### CAUTION

- **The efficiency of the battery decreases during low temperature. If the vehicle is not used for the extended period of time, park the vehicle indoors if possible.**
- **Always keep the battery charged to the full capacity. The battery case may damage due to freezing if the battery capacity is low.**
- **Do not install unauthorized electrical devices (for example, lamps, dashcam, etc.) to a vehicle. It may discharge the battery.**

## TIRES AND WHEELS



### WARNING

Tire failure may cause loss of vehicle control resulting in an accident. To reduce risk of **SERIOUS INJURY or DEATH**, take the following precautions:

- Inspect your tires monthly for proper inflation as well as wear and damage.
- The recommended cold tire pressure for your vehicle can be found in this manual and on the tire label located on the driver's side center pillar. Always use a tire pressure gauge to measure tire pressure. Tires with too much or too little pressure wear unevenly causing poor handling.
- Check the pressure of the spare every time you check the pressure of the other tires on your vehicle.
- Replace tires that are worn, show uneven wear, or are damaged. Worn tires can cause loss of braking effectiveness, steering control, or traction.
- **ALWAYS** replace tires with the same type, size, brand, construction and tread pattern as each tire that was originally supplied with this vehicle. Using tires and wheels other than the recommended sizes could cause unusual handling characteristics, poor vehicle control, or negatively affect your vehicle's Anti-Lock Brake System (ABS) resulting in a serious accident.

### Tire Care

For proper maintenance, safety, and maximum fuel economy, you must always maintain recommended tire inflation pressures and stay within the load limits and weight distribution recommended for your vehicle.

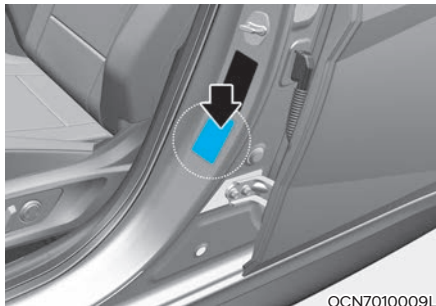

All specifications (sizes and pressures) can be found on a label attached to the driver's side center pillar.

### Recommended Cold Tire Inflation Pressures

All tire pressures (including the spare) should be checked when the tires are cold. "Cold tires" means the vehicle has not been driven for at least three hours or has been driven for less than one mile (1.6 km).

Warm tires normally exceed recommended cold tire pressures by 4 to 6 psi (28 to 41 kPa). Do not release air from warm tires to adjust the pressure or the tires will be under-inflated. For recommended inflation pressure, refer to "Tire and Wheels" in chapter 2.

**WARNING**

Recommended pressures must be maintained for the best ride, vehicle handling, and minimum tire wear.

Over-inflation or under-inflation can reduce tire life, adversely affect vehicle handling, and lead to sudden tire failure that could result in loss of vehicle control resulting in an accident.

Severe under-inflation can lead to severe heat build-up, causing blowouts, tread separation and other tire failures that can result in the loss of vehicle control resulting in an accident. This risk is much higher on hot days and when driving for long periods at high speeds.

**CAUTION**

- Under-inflation results in excessive wear, poor handling and reduced fuel economy. Wheel deformation is also possible. Keep your tire pressures at the proper levels. If a tire frequently needs refilling, have it checked by an authorized HYUNDAI dealer.
- Over-inflation produces a harsh ride, excessive wear at the center of the tire tread, and a greater possibility of damage from road hazards.

**Check Tire Inflation Pressure**

Check your tires, including the spare tire, once a month or more.

**How to check**

Use a good quality tire pressure gauge to check tire pressure. You can not tell if your tires are properly inflated simply by looking at them. Radial tires may look properly inflated when they are under-inflated.

Remove the valve cap from the tire valve stem. Press the tire gauge firmly onto the valve to get a pressure measurement. If the cold tire inflation pressure matches the recommended pressure on the tire label located on the driver's side center pillar or in this manual. No further adjustment is necessary. If the pressure is low, add air until you reach the recommended pressure. Make sure to put the valve caps back on the valve stems. Without the valve cap, dirt or moisture could get into the valve core and cause air leakage. If a valve cap is missing, install a new one as soon as possible.

If you overfill the tire, release air by pushing on the metal stem in the center of the tire valve. Recheck the tire pressure with the tire gauge. Be sure to put the valve caps back on the valve stems. Without the valve cap, dirt or moisture could get into the valve core and cause air leakage. If a valve cap is missing, install a new one as soon as possible.

A cold tire means the vehicle has been sitting for 3 hours and driven for less than 1 mile (1.6 km) in that 3 hour period.

Allow the tire to cool before measuring the inflation pressure. Always be sure the tire is cold before inflating to the recommended pressure.

## Tire Rotation

To equalize tread wear, HYUNDAI recommends that the tires be rotated according to the maintenance schedule or sooner if irregular wear develops.

During rotation, check the tires for correct balance.

When rotating tires, check for uneven wear and damage. Abnormal wear is usually caused by incorrect tire pressure, improper wheel alignment, out-of-balance wheels, severe braking or severe cornering. Look for bumps or bulges in the tread or side of the tire. Replace the tire if you find any of these conditions. Replace the tire if fabric or cord is visible. After rotation, be sure to bring the front and rear tire pressures to specification and check lug nut tightness (proper torque is 79–94 lbf·ft [11–13 kgf·m]).

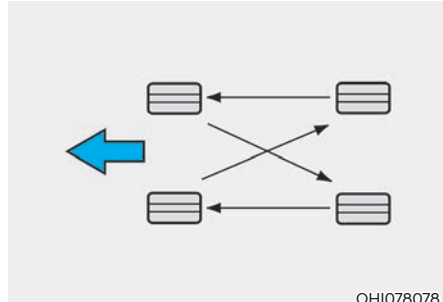

Disc brake pads should be inspected for wear whenever tires are rotated.

### **i** Information

**Tires that are asymmetrical or directional can only be installed on the wheel in one direction. The outside and inside of an asymmetrical tire is not easily distinguishable. Pay careful attention to the markings on the sidewalls of the tires, noting the “outside” marking and also the rotating direction before installing them on the vehicle.**

### **⚠** WARNING

- Do not use the compact spare tire for tire rotation.
- Do not mix bias ply and radial ply tires under any circumstances. This may cause unusual handling characteristics that may cause loss of vehicle control resulting in an accident.

## Wheel Alignment and Tire Balance

The wheels on your vehicle were aligned and balanced carefully at the factory to give you the longest tire life and best overall performance.

In most cases, you will not need to have your wheels aligned again. However, if you notice unusual tire wear or your vehicle pulling one way or the other, the alignment may need to be reset.

If you notice your vehicle vibrating when driving on a smooth road, your wheels may need to be rebalanced.

### **NOTICE**

**Improper wheel weights can damage your vehicle's aluminum wheels. Use only approved wheel weights.**

## Tire Replacement



If the tire is worn evenly, a tread wear indicator will appear as a solid band across the tread. This shows there is less than 1/16 inch (1.6 mm) of tread left on the tire. Replace the tire when this happens.

Do not wait for the tread surface to become level with the tread wear indicators before replacing the tire.



**WARNING**

To reduce the risk of **DEATH** or **SERIOUS INJURY**:

- **Replace tires that are worn, show uneven wear, or are damaged. Worn tires can cause loss of braking effectiveness, steering control, and traction.**
- **Always replace tires with the same size as each tire that was originally supplied with this vehicle. Using tires and wheels other than the recommended sizes could cause unusual handling characteristics, poor vehicle control, or negatively affect your vehicle's Anti-Lock Brake System (ABS) resulting in a serious accident.**
- **Tires degrade over time, even when they are not being used. Regardless of the remaining tread, HYUNDAI recommends that tires be replaced after six (6) years of normal service.**
- **When replacing tires, it is recommended to replace the two front or two rear tires as a pair. Replacing just one tire can seriously affect your vehicle's handling. If only replacing one pair of tires, it is recommended to install the pair of new tires on the rear axle.**
- **Heat caused by hot climates or frequent high loading conditions can accelerate the aging process. Failure to follow this warning may cause sudden tire failure, which could lead to a loss of vehicle control resulting in an accident.**

***Compact spare tire replacement***

A compact spare tire has a shorter tread life than a regular size tire. Replace it when you can see the tread wear indicator bars on the tire. The replacement compact spare tire should be the same size and design tire as the one provided with your new vehicle and should be mounted on the same compact spare tire wheel. The compact spare tire is not designed to be mounted on a regular size wheel, and the compact spare tire wheel is not designed for mounting a regular size tire.



**WARNING**

**The original tire should be repaired or replaced as soon as possible to avoid failure of the spare and loss of vehicle control resulting in an accident. The compact spare tire is for emergency use only. Do not operate your vehicle over 50 mph (80 km/h) when using the compact spare tire.**

## Wheel Replacement

When replacing the metal wheels for any reason, make sure the new wheels are equivalent to the original factory units in diameter, rim width and offset.

## Tire Traction

Tire traction can be reduced if you drive on worn tires, tires that are improperly inflated or on slippery road surfaces. Tires should be replaced when the tread depth is at least 2/32 inch (1.6 mm). To reduce the possibility of losing control, slow down whenever there is rain, snow or ice on the road.

## Tire Maintenance

In addition to proper inflation, correct wheel alignment helps to decrease tire wear. If you find a tire is worn unevenly, have your dealer check the wheel alignment.

When you have new tires installed, make sure they are balanced. This will increase vehicle ride comfort and tire life. Additionally, a tire should always be rebalanced if it is removed from the wheel.

## Tire Sidewall Labeling

This information identifies and describes the fundamental characteristics of the tire and also provides the tire identification number (TIN) for safety standard certification. The TIN can be used to identify the tire in case of a recall.

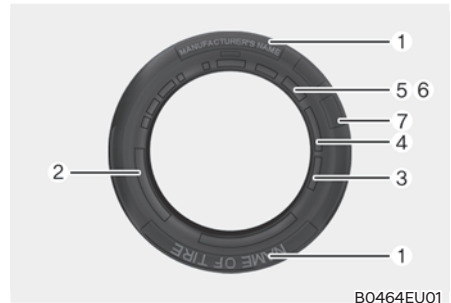

B0464EU01

### 1. **Manufacturer or brand name**

Manufacturer or brand name is shown.

### 2. **Tire size designation**

A tire's sidewall is marked with a tire size designation. You will need this information when selecting replacement tires for your car. The following explains what the letters and numbers in the tire size designation mean.

Example tire size designation:

(These numbers are provided as an example only; your tire size designator could vary depending on your vehicle.)

#### **205/55R16 91H**

205 - Tire width in millimeters.

55 - Aspect ratio. The tire's section height as a percentage of its width.

R - Tire construction code (Radial).

16 - Rim diameter in inches.

91 - Load Index, a numerical code associated with the maximum load the tire can carry.

H - Speed Rating Symbol. See the speed rating chart in this section for additional information.

### Wheel size designation

Wheels are also marked with important information that you need if you ever have to replace one. The following explains what the letters and numbers in the wheel size designation mean.

Example wheel size designation:

#### 6.5J X 16

6.5 - Rim width in inches.

J - Rim contour designation.

16 - Rim diameter in inches.

### Tire speed ratings

The chart below lists many of the different speed ratings currently being used for passenger vehicle tires. The speed rating is part of the tire size designation on the sidewall of the tire. This symbol corresponds to that tire's designed maximum safe operating speed.

Speed Rating Symbol	Maximum Speed
S	112 mph (180 km/h)
T	118 mph (190 km/h)
H	130 mph (210 km/h)
V	149 mph (240 km/h)
W	168 mph (270 km/h)
Y	186 mph (300 km/h)

### 3. Checking tire life (TIN : Tire Identification Number)

Any tires that are over six years old, based on the manufacturing date, (including the spare tire) should be replaced by new tires. You can find the manufacturing date on the tire sidewall (possibly on the inside of the wheel), displaying the DOT Code. The DOT Code is a series of numbers on a tire consisting of numbers and English letters. The manufacturing date is designated by the last four digits (characters) of the DOT code.

#### DOT : XXXX XXXX 0000

The front part of the DOT shows a plant code number, tire size and tread pattern and the last four numbers indicate week and year manufactured.

For example:

DOT XXXX XXXX 1425 represents that the tire was produced in the 14th week of 2025.

### 4. Tire ply composition and material

The number of layers or plies of rubber-coated fabric in the tire. Tire manufacturers also must indicate the materials in the tire, which include steel, nylon, polyester, and others. The letter "R" means radial ply construction; the letter "D" means diagonal or bias ply construction; and the letter "B" means belted-bias ply construction.

### **5. Maximum permissible inflation pressure**

This number is the greatest amount of air pressure that should be put in the tire. Do not exceed the maximum permissible inflation pressure. Refer to the Tire and Loading Information label for recommended inflation pressure.

### **6. Maximum load rating**

This number indicates the maximum load in kilograms and pounds that can be carried by the tire. When replacing the tires on the vehicle, always use a tire that has the same load rating as the factory installed tire.

### **7. Uniform tire quality grading**

Quality grades can be found where applicable on the tire sidewall between tread shoulder and maximum section width.

For example:

TREAD WEAR 200

TRACTION AA

TEMPERATURE A

### **Tread wear**

The tread wear grade is a comparative rating based on the wear rate of the tire when tested under controlled conditions on a specified government test course. For example, a tire graded 150 would wear one-and-a-half times (1½) as well on the government course as a tire graded 100.

The relative performance of tires depends upon the actual conditions of their use, however, and may depart significantly from the norm due to variations in driving habits, service practices and differences in road characteristics and climate.

These grades are molded on the sidewalls of passenger vehicle tires. The tires available as standard or optional equipment on your vehicle may vary with respect to grade.

### **Traction AA, A, B & C**

The traction grades, from highest to lowest, are AA, A, B and C. Those grades represent the tire's ability to stop on wet pavement as measured under controlled conditions on specified government test surfaces of asphalt and concrete. A tire marked C may have poor traction performance.



### **WARNING**

**The traction grade assigned to this tire is based on straight-ahead braking traction tests, and does not include acceleration, cornering, hydroplaning, or peak traction characteristics.**

### Temperature A, B & C

The temperature grades are A (the highest), B and C representing the tire's resistance to the generation of heat and its ability to dissipate heat when tested under controlled conditions on a specified indoor laboratory test wheel.

Sustained high temperature can cause the material of the tire to degenerate and reduce tire life, and excessive temperature can lead to sudden tire failure. Grade C responds to a level of performance which all passenger car tires must meet under the Federal Motor Vehicle Safety Standard No. 109. Grades B and A represent higher levels of performance on the laboratory test wheel than the minimum required by law.



### **WARNING**

**The temperature grade for this tire is established for a tire that is properly inflated and not overloaded. Excessive speed, under-inflation, over-inflation, or excessive loading, either separately or in combination, can cause heat build-up and possible sudden tire failure. This may cause loss of vehicle control resulting in an accident.**

## Tire Terminology and Definitions

### **Air Pressure**

The amount of air inside the tire pressing outward on the tire. Air pressure is expressed in pounds per square inch (psi) or kilopascal (kPa).

### **Accessory Weight**

This means the combined weight of optional accessories. Some examples of optional accessories are automatic transmission, power seats, and air conditioning.

### **Aspect Ratio**

The relationship of a tire's height to its width.

### **Belt**

A rubber coated layer of cords that is located between the plies and the tread. Cords may be made from steel or other reinforcing materials.

### **Bead**

The tire bead contains steel wires wrapped by steel cords that hold the tire onto the rim.

### **Bias Ply Tire**

A pneumatic tire in which the plies are laid at alternate angles less than 90 degrees to the centerline of the tread.

### **Cold Tire Pressure**

The amount of air pressure in a tire, measured in pounds per square inch (psi) or kilopascals (kPa) before a tire has built up heat from driving.

***Curb Weight***

This means the weight of a motor vehicle with standard and optional equipment including the maximum capacity of fuel, oil and coolant, but without passengers and cargo.

***DOT Markings***

A code molded into the sidewall of a tire signifying that the tire is in compliance with the U.S. Department of Transportation motor vehicle safety standards. The DOT code includes the Tire Identification Number (TIN), an alphanumeric designator which can also identify the tire manufacturer, production plant, brand and date of production.

***GVWR***

Gross Vehicle Weight Rating

***GAWR FRT***

Gross Axle Weight Rating for the Front Axle.

***GAWR RR***

Gross Axle Weight Rating for the Rear axle.

***Intended Outboard Sidewall***

The side of an asymmetrical tire, that must always face outward when mounted on a vehicle.

***Kilopascal (kPa)***

The metric unit for air pressure.

***Light truck (LT) tire***

A tire designated by its manufacturer as primarily intended for use on lightweight trucks or multipurpose passenger vehicles.

***Load ratings***

The maximum load that a tire is rated to carry for a given inflation pressure.

***Load Index***

An assigned number ranging from 1 to 279 that corresponds to the load carrying capacity of a tire.

***Maximum Inflation Pressure***

The maximum air pressure to which a cold tire may be inflated. The maximum air pressure is molded onto the sidewall.

***Maximum Load Rating***

The load rating for a tire at the maximum permissible inflation pressure for that tire.

***Maximum Loaded Vehicle Weight***

The sum of curb weight; accessory weight; vehicle capacity weight; and production options weight.

***Normal Occupant Weight***

The number of occupants a vehicle is designed to seat multiplied by 150 pounds (68 kg).

***Occupant Distribution***

Designated seating positions.

***Outward Facing Sidewall***

An asymmetrical tire has a particular side that faces outward when mounted on a vehicle. The outward facing sidewall bears white lettering or bears manufacturer, brand, and/or model name molding that is higher or deeper than the same moldings on the inner facing sidewall.

***Passenger (P-Metric) tire***

A tire used on passenger cars and some light duty trucks and multipurpose vehicles.

**Ply**

A layer of rubber-coated parallel cords.

**Pneumatic tire**

A mechanical device made of rubber, chemicals, fabric and steel or other materials, that, when mounted on an automotive wheel provides the traction and contains the gas or fluid that sustains the load.

**Pneumatic options weight**

The combined weight of installed regular production options weighing over 5 lb. (2.3 kg) in excess of the standard items which they replace, not previously considered in curb weight or accessory weight, including heavy duty breaks, ride levelers, roof rack, heavy duty battery, and special trim.

**Recommended Inflation Pressure**

Vehicle manufacturer's recommended tire inflation pressure as shown on the tire placard.

**Radial Ply Tire**

A pneumatic tire in which the ply cords that extend to the beads are laid at 90 degrees to the centerline of the tread.

**Rim**

A metal support for a tire and upon which the tire beads are seated.

**Sidewall**

The portion of a tire between the tread and the bead.

**Speed Rating**

An alphanumeric code assigned to a tire indicating the maximum speed at which a tire can operate.

**Traction**

The friction between the tire and the road surface. The amount of grip provided.

**Tread**

The portion of a tire that comes into contact with the road.

**Treadwear Indicators**

Narrow bands, sometimes called "wear bars", that show across the tread of a tire when only 1/16 inch of tread remains.

**UTQGS**

Uniform Tire Quality Grading Standards is a tire information system that provides consumers with ratings for a tire's traction, temperature and treadwear. Ratings are determined by tire manufacturers using government testing procedures. The ratings are molded into the sidewall of the tire.

**Vehicle Capacity Weight**

The number of designated seating positions multiplied by 150 lbs. (68 kg) plus the rated cargo and luggage load.

**Vehicle Maximum Load on the Tire**

Load on an individual tire due to curb and accessory weight plus maximum occupant and cargo weight.

**Vehicle Normal Load on the Tire**

Load on an individual tire that is determined by distributing to each axle its share of the curb weight, accessory weight, and normal occupant weight and dividing by 2.

**Vehicle Placard**

A label permanently attached to a vehicle showing the original equipment tire size and recommended inflation pressure.

## All Season Tires

HYUNDAI specifies all season tires on some models to provide good performance for use all year round, including snowy and icy road conditions. All season tires are identified by ALL SEASON and/or M+S (Mud and Snow) on the tire sidewall. Snow tires have better snow traction than all season tires and may be more appropriate in some areas.

## Summer Tires

HYUNDAI specifies summer tires on some models to provide superior performance on dry roads. Summer tire performance is substantially reduced in snow and ice. Summer tires do not have the tire traction rating M+S (Mud and Snow) on the tire side wall. If you plan to operate your vehicle in snowy or icy conditions, HYUNDAI recommends the use of snow tires or all season tires on all four wheels.

## Snow Tires

If you equip your car with snow tires, they should be the same size and have the same load capacity as the original tires. Snow tires should be installed on all four wheels; otherwise, poor handling may result. Snow tires should carry 4 psi (28 kPa) more air pressure than the pressure recommended for the standard tires on the tire label on the driver's side of the center pillar, or up to the maximum pressure shown on the tire sidewall, whichever is less. Do not drive faster than 75 mph (120 km/h) when your vehicle is equipped with snow tires.

## Radial-Ply Tires

Radial-ply tires provide improved tread life, road hazard resistance and smoother high speed ride. The radial-ply tires used on this vehicle are of belted construction, and are selected to complement the ride and handling characteristics of your vehicle.

Radial-ply tires have the same load carrying capacity, as bias-ply or bias belted tires of the same size, and use the same recommended inflation pressure. Mixing of radial-ply tires with bias-ply or bias belted tires is not recommended. Any combinations of radial-ply and bias-ply or bias belted tires when used on the same vehicle will seriously deteriorate vehicle handling. The best rule to follow is: Identical pairs of radial-ply tires should always be used as a set for the front tires and a set for the rear tires.

Longer wearing tires can be more susceptible to irregular tread wear. It is very important to follow the tire rotation interval in this chapter to achieve the tread life potential of these tires. Cuts and punctures in radial-ply tires are repairable only in the tread area, because of sidewall flexing. Consult your tire dealer for radial-ply tire repairs.



### WARNING

**Do not mix bias ply and radial ply tires under any circumstances. This may cause unusual handling characteristics that may cause loss of vehicle control resulting in an accident.**

## Low Aspect Ratio Tires

The aspect ratio is lower than 50 on low aspect ratio tires.

Because low aspect ratio tires are optimized for handling and braking, their sidewall is a little stiffer than a standard tire. Also low aspect ratio tires tend to be wider and consequently have a greater contact patch with the road surface. In some instances they may generate more road noise compared with standard tires.



### CAUTION

**Because the sidewall of a low aspect ratio tire is shorter than a standard tire, the rim of the wheel and the tire itself is more easily susceptible to damage. Use caution when driving and follow the guidelines below to help minimize damage to the wheel and tire:**

- **When driving on a rough road or off road, drive cautiously because tires and wheels may be damaged. And after driving, inspect tires and wheels.**
- **When passing over a pothole, speed bump, manhole, or curb stone, drive slowly so that the tires and wheels are not damaged.**
- **If the tire is subjected to a severe impact, have the tire and wheel inspected by an authorized HYUNDAI dealer.**
- **Inspect the tire condition and pressure every 1,800 miles (3,000km).**



### CAUTION

- **It is not easy to recognize tire damage with your own eyes. But if there is the slightest hint of tire damage, have the tire checked or replaced because the tire damage may cause air leakage from the tire.**
- **If the tire is damaged by driving on a rough road, off road, pothole, manhole, or curb stone, it will not be covered by the warranty.**

## FUSES

### ■ Blade type



Normal



Blown

### ■ Cartridge type



Normal



Blown

### ■ Multi fuse

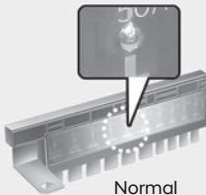

Normal

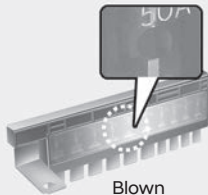

Blown

OTM078035

A vehicle's electrical system is protected from electrical overload damage by fuses.

This vehicle has 2 (or 3) fuse panels, one located in the driver's side panel bolster, the other in the engine compartment near the battery.

If any of your vehicle's lights, accessories, or controls do not work, check the appropriate circuit fuse. If a fuse has blown, the element inside the fuse will be melted or broken.

If the electrical system does not work, first check the driver's side fuse panel. Before replacing a blown fuse, turn the engine and all switches off, and then disconnect the battery connector. Always replace a blown fuse with one of the same rating.

If the replacement fuse blows, this indicates an electrical problem. Avoid using the system involved and immediately consult an authorized HYUNDAI dealer.

### **WARNING**

**NEVER** replace a fuse with anything but another fuse of the same rating.

- A higher capacity fuse could cause damage and possibly cause a fire.
- Do not install a wire or aluminum foil instead of the proper fuse - even as a temporary repair. It may cause extensive wiring damage and possibly a fire.

### **NOTICE**

Do not use a screwdriver or any other metal object to remove fuses because it may cause a short circuit and damage the system.

## Instrument Panel Fuse Replacement



1. Turn the vehicle off.
2. Turn all other switches OFF.
3. Open the fuse panel cover.
4. Refer to the label on the inside of the fuse panel cover to locate the suspected fuse location.

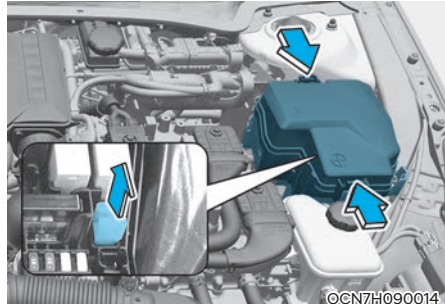

5. Pull the suspected fuse straight out. Use the removal tool provided in the engine compartment fuse panel.
6. Check the removed fuse; replace it if it is blown. Spare fuses are provided in the engine compartment fuse panel.
7. Push in a new fuse of the same rating, and make sure it fits tightly in the clips. If it fits loosely, consult an authorized HYUNDAI dealer.

In an emergency, if you do not have a spare fuse, use a fuse of the same rating from a circuit you may not need for operating the vehicle.

If the other electrical components do not work and the fuses are undamaged, check the fuse panel in the engine compartment. If a fuse is blown, it must be replaced with the same rating.

If the headlight, turn signal lamp, tail lamp, interior lamp doesn't work and the fuses are undamaged, consult an authorized HYUNDAI dealer.

## Engine Compartment Panel Fuse Replacement

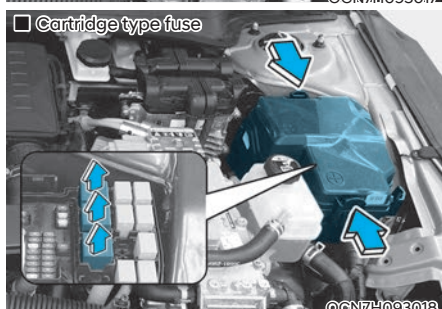
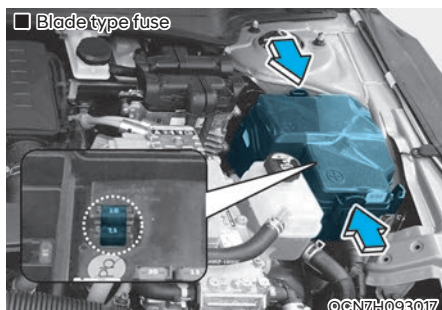

1. Turn the engine off.
2. Turn all other switches OFF.
3. Remove the fuse panel cover by pressing the tap and pulling up.
4. Check the removed fuse; replace it if it is blown. To remove or insert the fuse, use the removal tool in the engine compartment fuse panel.
5. Push in a new fuse of the same rating, and make sure it fits tightly in the clips. If it fits loosely, consult an authorized HYUNDAI dealer.

### CAUTION

After checking the fuse box in the engine compartment securely close the fuse box cover inside the engine compartment, until it clicks.

If the fuse box is not closed properly, water may leak in side, possibly causing a malfunction with the electrical system.

### Multi fuse (Main fuse)

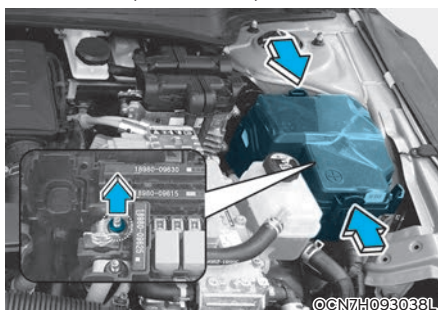

If the multi fuse is blown, it must be removed as follows:

1. Turn off the engine.
2. Disconnect the battery connector.
3. Remove the fuse panel cover by pressing the tab and pulling it up.
4. Remove the nuts shown in the picture above.
5. Replace the fuse with a new one of the same rating.
6. Reinstall in the reverse order of removal.

### Information

If the multi fuse is blown, consult an authorized HYUNDAI dealer.

## Fuse/Relay Panel Description

### Instrument panel fuse panel



©CN7080024

Inside the fuse/relay box cover, you can find the fuse/relay label describing fuse/relay names and ratings.

## **i** Information

Not all fuse panel descriptions in this manual may be applicable to your vehicle; the information is accurate at the time of printing. When you inspect the fuse box on your vehicle, refer to the fuse label.

\* HYBRID MODEL ONLY

				1 MEMORY 10A	2 AIR BAG 10A	2 A/C 10A	4 MODULE 10A	7 MODULE 10A	START 7.5A
				E-CALL 10A	* BATTERY MANAGEMENT 10A		CLUSTER 7.5A	2 IBU 7.5A	1 A/C 7.5A
TRUNK OPEN 10A	S/HEATER FRT 20A	P/WINDOW LH 20A	MULTI MEDIA 25A	1 SPARE 15A	LDC 10A	FCA 10A	MDPS 10A	6 MODULE 7.5A	2 SPARE 10A
S/HEATER RR 10A	SAFETY P/WINDOW DRV 25A	P/WINDOW RH 25A	BRAKE SWITCH 25A	1 IBU 15A	2 MODULE 10A	1 AIR BAG 10A	5 MODULE 7.5A	2 SPARE 10A	
SAFETY P/WINDOW PASS 30A	AMP 25A	HEATED MIRROR 30A	DOOR LOCK 10A	IAU 20A		3 MODULE 15A	A/BAG IND 7.5A	WASHER 10A	
P/SEAT PASS 30A	P/SEAT DRV 30A	WIPER 10A	1 MODULE 10A	SUN ROOF 20A	USB CHARGER 15A	IG1 25A		3 A/C 10A	

USE THE DESIGNATED FUSE ONLY  
USE SOLO LOS FUSIBLES ESPECIFICADOS. P/N/O: 91990-AA520  
UTILISEZ SEULEMENT LE FUSIBLE DÉSIGNÉS **i**

OCN7H093027N

### Driver's side fuse panel

Fuse Name	Fuse Rating	Circuit Protected
MEMORY1	10A	A/C Controller, Instrument Cluster, A/C Control Module, ADAS_PRK_SVM
AIR BAG2	10A	SRS Control Module
MODULE4	10A	IBU, Front Console Switch, ADAS Unit, Crash Pad Switch, LKA Unit, VESS Unit
MODULE7	7.5A	Rear Seat Wamer Control Module
START	7.5A	Burglar Alarm Relay, Transaxle Range Switch, IBU, HPCU
BATTERY MANAGEMENT	10A	BMS Control Module
CLUSTER	7.5A	Instrument Cluster (IG1)
IBU2	7.5A	IBU
A/C1	7.5A	A/C Controller, A/C Control Module, E/R Junction Block (Blower Relay, PTC Heater1/2 Relay), Electronic A/C Compressor
TRUNK	10A	Trunk Lid Latch
S/HEATER FRT	20A	Front Ventilation Seat Control Module, Front Seat Warmer Control Module
P/WINDOW LH	25A	Power Window Main Switch
MULTIMEDIA	15A	Audio, A/V & Navigation Head Unit
SPARE 1 (B+)	10A	Not Used (Black Box)
FCA	10A	Front Radar
MDPS	7.5A	MDPS Unit
MODULE6	7.5A	IBU, IAU
SAFETY P/WINDOW DRV	25A	Driver Safety Power Window Module
P/WINDOW RH	25A	Passenger Power Window Switch, Power Window Main Switch
BRAKE SWITCH	10A	IBU, Stop Lamp Switch
IBU1	15A	IBU, Sport Mode Switch
SAFETY P/WINDOW PASS	25A	SAFETY ECU PASS

Driver’s side fuse panel

Fuse Name	Fuse Rating	Circuit Protected
MODULE2	10A	A/V & Navigation Head Unit, AMP, ADAS Unit, BMS Control Module, Power Outside Mirror Switch, IBU, IAU, Audio, E/R Junction Block (Power Outlet Relay)
AIR BAG1	15A	Passenger Occupant Detection Sensor, SRS Control Module
MODULE5	10A	Data Link Connector, Audio, ATM Shift Lever Indicator, A/V & Navigation Head Unit, Wireless Charger, AMP, A/C Control Module, Electro Chromic Mirror, A/C Controller, Front Ventilation Seat Control Module, Front Seat Wamer Control Module, Driver IMS Control Module
SPARE 2 (IG2)	10A	Not Used (Black Box)
AMP	25A	AMP
HEATED MIRROR	10A	A/C Controller, Driver/Passenger Outside Mirror heated
DOOR LOCK	20A	Lock/Unlock Actuator, Two Turn Unlock Relay
IAU	10A	IAU, Driver/Passenger Door NFC Module
MODULE3	7.5A	IAU, Stop Lamp Switch, Sport Mode Switch
A/BAG IND	7.5A	Instrument Cluster, Overhead Console Lamp
WASHER	15A	Multifunction Switch
P/SEAT DRV	30A	Driver Power Seat Switch
WIPER	10A	IBU, ECM, Front Wiper Motor, PCB Block (Front Wiper (LOW) Relay)
MODULE1	10A	Data Link Connector, Hazard Switch, Key Interlock, Driver/Passenger Smart Key Outside Handle, VESS, Driver IMS Control Module
SUNROOF	20A	Sunroof Motor
USB CHARGER	15A	Front USB Charger, Console USB Charger
IG1	25A	PCB Block (Fuse - IEB 4/ECU 3/TCU 2/EWP 3)

### Engine compartment fuse panel

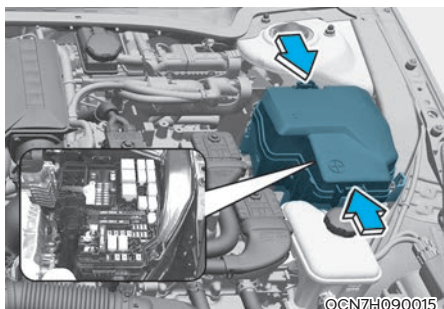

### **i** Information

Not all fuse panel descriptions in this manual may be applicable to your vehicle; the information is accurate at the time of printing. When you inspect the fuse panel in your vehicle, refer to the fuse panel label.

Inside the fuse/relay box cover, you can find the fuse/relay label describing fuse/relay names and ratings.

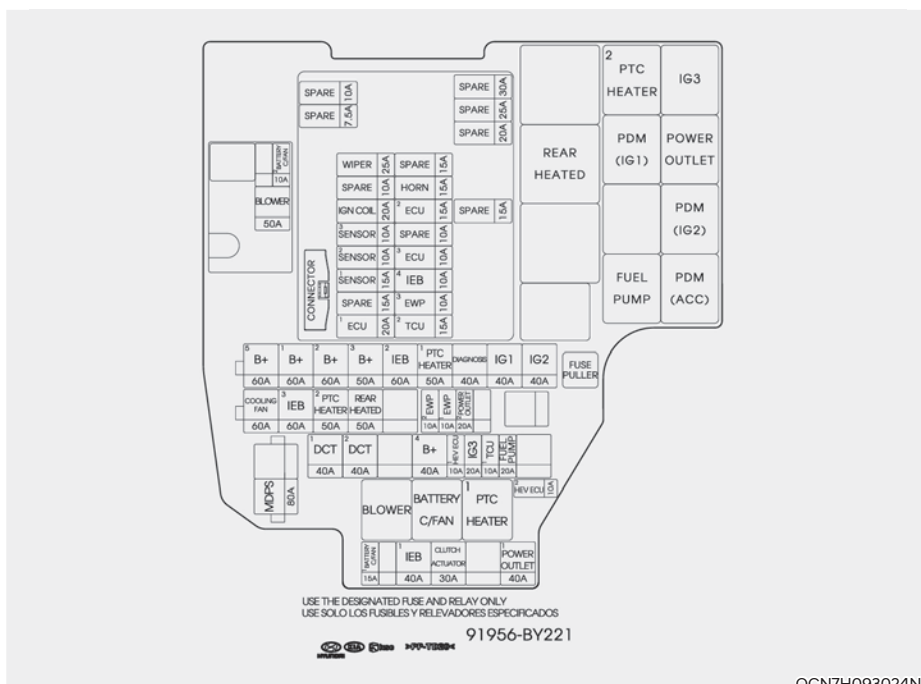

OCN7H093024N

**Engine compartment fuse panel**

Type	Fuse Name	Fuse Rating	Circuit Protected
MULTI FUSE-3	MDPS	80A	MDPS Unit
MULTI FUSE-2	COOLING FAN	60A	Cooling Fan Motor
	IEB 3	60A	IDB Unit
	PTC HEATER 2	50A	PTC Heater 2 Relay
	REAR HEATED	50A	Rear Glass Heated
MULTI FUSE-1	B+5	60A	PCB Block (Engine Control Relay, Fuse - ECU 2/HORN/WIPER)
	B+1	60A	ICU Junction Block (IPS2/IPS3/IPS5/IPS6/IPS7)
	B+2	60A	ICU Junction Block (IPS1/IPS4/IPS8/IPS9/IPS10)
	B+3	50A	Fuse - EWP 2, ICU Junction Block (Fuse - SAFETY P/WINDOW DRV, SAFETY P/WINDOW PASS, TRUNK, AMP, P/SEAT DRV, P/SEAT PASS, S/HEATER FRT, Long Term Load Latch Relay (Fuse - MEMORY 1/ MULTIMEDIA))
	IEB 2	60A	IDB Unit
	PTC HEATER 1	50A	PTC Heater
	BLOWER	50A	Blower Motor, Multipurpose Check Connector
	IG1	40A	Ignition Switch, PDM (IG1/ACC) Relay
	IG2	40A	Ignition Switch, PDM (IG2) Relay

### Engine compartment fuse panel

Type	Fuse Name	Fuse Rating	Circuit Protected
FUSE	BATTERY C/ FAN 1	15A	Battery C/Fan
	IEB1	40A	IDB Unit, Multipurpose Check Connector
	CLUTCH ACTUATOR	30A	Clutch Actuator
	POWER OUTLET 1	40A	Power Outlet
	EWP 2	10A	Auxiliary Electric Water Pump
	EWP 1	10A	Electric Water Pump
	POWER OUTLET 2	20A	Front Power Outlet
	DCT 1	40A	TCM
	DCT 2	40A	TCM
	B+4	40A	ICU Junction Block (Power Window Relay, Fuse - AIR BAG 2, IBU 1, BRAKE SWITCH, DOOR LOCK, MODULE 1, SUNROOF, IAU, BMS)
	HEV ECU 1	10A	HPCU
	IG3	20A	IG3 Relay
	TCU 1	10A	TCM
	FUEL PUMP	20A	Fuel Pump Motor
HEV ECU 2	10A	HPCU, BMS Control Module	
DIAGNOSIS	40A	Multipurpose Check Connector	
Sub Block FUSE	BATTERY C/ FAN 2	10A	Battery C/Fan Relay

**Engine compartment fuse panel**

Fuse Name	Fuse Rating	Circuit Protected
WIPER	25A	Wiper Motor
HORN	15A	Horn
IGN COIL	20A	Ignition Coil #1 ~ #4
ECU2	15A	ECM
SENSOR3	10A	E/R Junction Block (Fuel Pump Relay)
SENSOR2	10A	Camshaft Position Sensor #1/#2 (Intake/Exhaust), Mass Air Flow Sensor, ELCM, Oil Control Valve #1/#2 (Intake/Exhaust), Cooling Fan, Purge Control Solenoid Valve
ECU3	10A	ECM, HPCU, Clutch Actuator
SENSOR1	15A	Oxygen Sensor (Up/Down)
IEB 4	10A	IDB Unit, Multipurpose Check Connector
EWP 3	10A	Auxiliary Electric Water Pump
ECU1	20A	ECM
TCU2	15A	Transaxle Range Switch, TCM

## LIGHT BULBS

Consult an authorized HYUNDAI dealer to replace most vehicle light bulbs. It is difficult to replace vehicle light bulbs because other parts of the vehicle must be removed before you can get to the bulb. This is especially true for removing the headlight assembly to get to the bulb(s).

Removing/installing the headlight assembly can result in damage to the vehicle.

### **i** Information

The headlight and tail lamp lenses could appear frosty if the vehicle is washed after driving or the vehicle is driven at night in wet weather. This condition is caused by temperature difference between the lamp inside and outside and does not indicate a problem with your vehicle. When moisture condenses in the lamp, it will be removed after driving with the headlight on. The removable level may differ depending on lamp size, lamp position and environmental condition. However, if moisture is not removed, have the vehicle inspected by an authorized HYUNDAI dealer.

### **!** WARNING

- Prior to replacing a lamp, depress the foot brake, move the shift lever into P (Park) apply the parking brake, place the ignition switch to the LOCK/OFF position, and take the key with you when leaving the vehicle to avoid sudden movement of the vehicle and to prevent possible electric shock.
- Be aware the bulbs may be hot and may burn your fingers.
- When the bulb is disconnected or the lamp connector is removed while the lamp is operating normally, the fuse box electronics may recognize the lamp as a malfunction. Therefore, a fault record for the lamp may remain in the Diagnostic Trouble Code (DTC) recorded in the fuse box.

## Headlight, Parking Lamp, Daytime Running Light, Turn Signal Lamp and Side Marker

### Type A

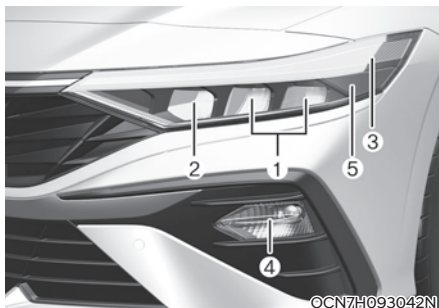

- (1) Headlight (Low)
- (2) Headlight (High)
- (3) Daytime running lamp (DRL)/  
Parking lamp
- (4) Turn signal lamp
- (5) Side marker

### Type B

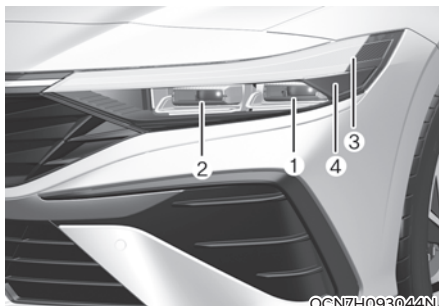

- (1) Headlight (Low)
- (2) Headlight (High)
- (3) Daytime running lamp (DRL)/Parking  
lamp/Turn signal lamp
- (4) Side marker

**i** Information

The headlight aiming should be adjusted after an accident or after the headlight assembly is reinstalled at an authorized HYUNDAI dealer.

**Headlight/Daytime running light (DRL) / Parking lamp (LED type)**

If the lamp (LED) does not operate, have the system checked by an authorized HYUNDAI dealer.

The LED lamps cannot be replaced as a single unit because it is an integrated unit. The LED lamps have to be replaced with the unit.

A skilled technician should check or repair the LED lamp, for it may damage related parts of the vehicle.

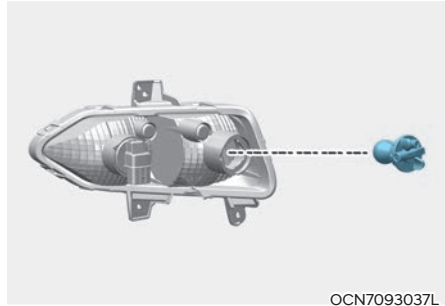

**Turn signal lamp (Bulb type)**

1. Open the hood.
2. Remove the front bumper.
3. Disconnect the battery connector.
4. Remove the socket from the assembly by turning the socket counterclockwise until the tabs on the socket align with the slots on the assembly.
5. Remove the bulb from the socket by pressing it in and rotating it counterclockwise until the tabs on the bulb align with the slots in the socket. Pull the bulb out of the socket.
6. Insert a new bulb by inserting it into the socket and rotating it until it locks into place.
7. Install the socket in the assembly by aligning the tabs on the socket with the slots in the assembly.
8. Push the socket into the assembly and turn the socket clockwise.

### Turn signal lamp (LED type)

If the lamp (LED) does not operate have the system be checked by an authorized HYUNDAI dealer.

The LED lamps cannot be replaced as a single unit because it is an integrated unit. The LED lamps has to be replaced with the unit.

A skilled technician should check or repair the LED lamp, for it may damage related parts of the vehicle.

### Side marker (LED type)

If the LED lamp does not operate, have the vehicle checked by an authorized HYUNDAI dealer.

### Side Repeater Lamp Replacement (if equipped)



If the LED lamp (1) does not operate, have the vehicle checked by an authorized HYUNDAI dealer.

### Rear Combination Lamp Bulb Replacement

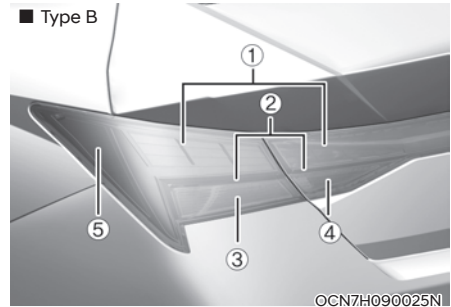
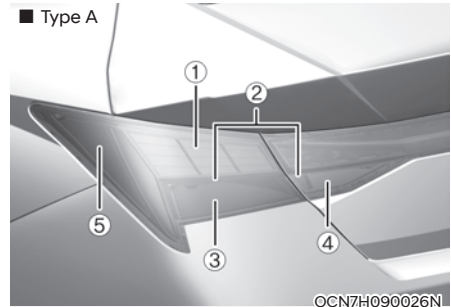

- (1) Stop lamp (LED or bulb)
- (2) Tail lamp (LED)
- (3) Turn signal lamp
- (4) Reverse lamp
- (5) Rear side marker (LED or bulb)

**Tail/Stop lamp/Turn signal lamp/  
Side marker (Outer lamp) (Bulb type)**

1. Open the trunk lid.



2. Remove the service cover by pulling out the service cover.

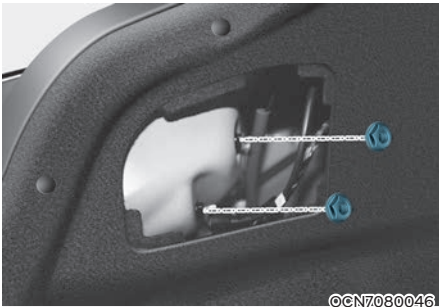

3. Loosen the assembly retaining nuts.



4. Remove the rear combination light assembly from the body of the vehicle.

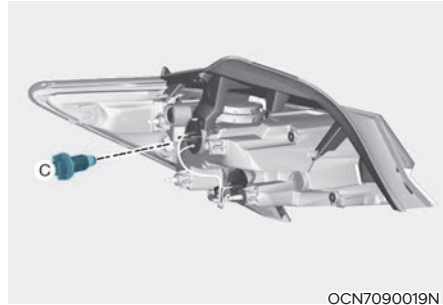
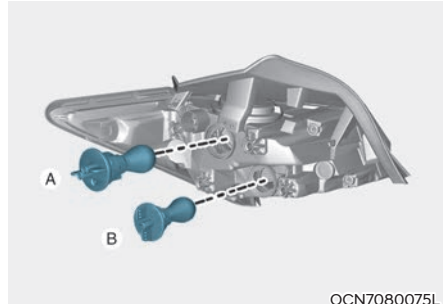

[A] : Tail/Stop lamp, [B] : Turn signal lamp,  
[C] : Rear side marker

5. Remove the socket from the assembly by turning the socket counterclockwise until the tabs on the socket align with the slots on the assembly.
6. Remove the bulb from the socket by pressing it in and rotating it counterclockwise until the tabs on the bulb align with the slots in the socket. Pull the bulb out of the socket.
7. Insert a new bulb by inserting it into the socket and rotating it until it locks into place.
8. Install the socket in the assembly by aligning the tabs on the socket with the slots in the assembly. Push the socket into the assembly and turn the socket clockwise.

### **Reverse lamp (Inner lamp) (Bulb type)**

1. Open the trunk.

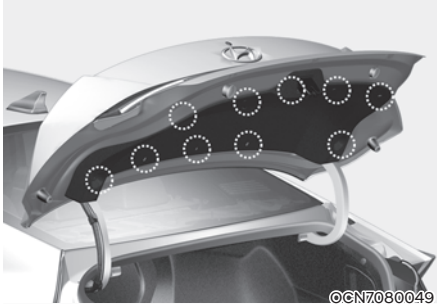

2. Loosen the retaining screw of the trunk lid cover and then remove the cover.
3. Disconnect the connector and then remove the nuts by turning the nuts counter clockwise.
4. Take the light assembly out.

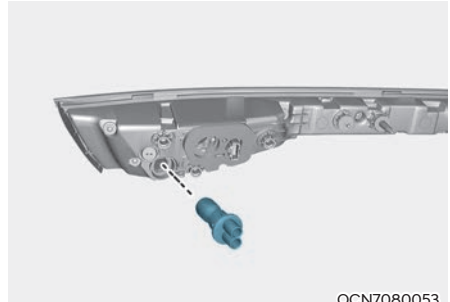

5. Remove the socket from the assembly by turning the socket counterclockwise until the tabs on the socket align with the slots on the assembly.
6. Remove the bulb by pulling it out.
7. Insert a new bulb by inserting it into the socket.
8. Install the light assembly to the trunk.
9. Reinstall the trunk lid cover by pushing in the screw.

### **Stop/Tail lamp and rear side marker (LED type)**

If the LED lamp does not operate, have the vehicle checked by an authorized HYUNDAI dealer.

## High Mounted Stop Lamp Replacement

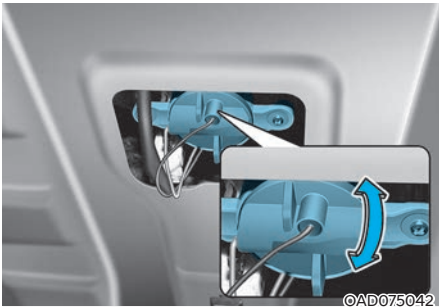
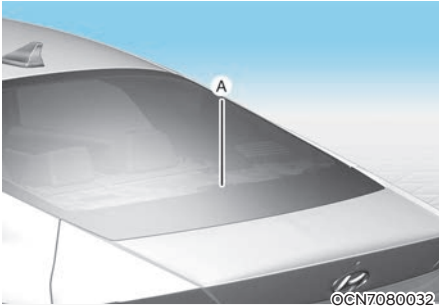

[A] : High mounted stop lamp

1. Open the trunk.
2. Remove the socket by turning it counterclockwise until the tabs on the socket align with the slots.
3. Remove the bulb from the socket by pressing it in and rotating it counterclockwise until the tabs on the bulb align with the slots in the socket. Pull the bulb out of the socket.
4. Insert a new bulb by inserting it into the socket and rotating it until it locks into place.
5. Install the socket in the assembly by aligning the tabs on the socket with the slots in the assembly. Push the socket into the assembly and turn the socket clockwise.

## License Plate Light Bulb Replacement

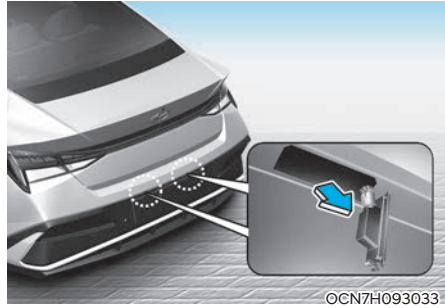

1. Using a flat-blade screwdriver gently pry the lens cover from the lamp housing.
2. Remove the bulb by pulling it straight out.
3. Install a new bulb.
4. Reinstall in the reverse order.

## Interior Light Bulb Replacement

### Map lamp/Room lamp/Sunvisor lamp (bulb type)

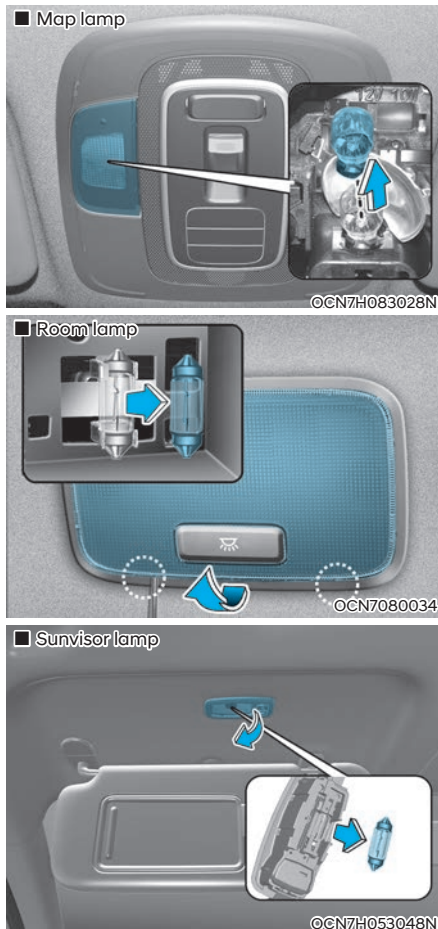

1. Using a flat-blade screwdriver, gently pry the lens or assembly from the interior lamp housing.
2. Remove the bulb by pulling it straight out.

### WARNING

Prior to working on the Interior Lights, ensure that the “OFF” button is depressed to avoid burning your fingers or receiving an electric shock.

3. Install a new bulb in the socket.
4. Align the lens tabs with the interior lamp housing notches and snap the lens into place.

### Trunk room lamp (bulb type)



1. Using a flat-blade screwdriver gently pry the assembly from the lamp housing.
2. Remove the lamp cover, then pull the bulb straight out it.
3. Install a new bulb.
4. Reinstall in the reverse order.

### **NOTICE**

Use care not to dirty or damage lens, lens tab, and plastic housings.

**Mood lamp/Map lamp/Room lamp  
(LED type)**

- Mood lamp (if equipped)

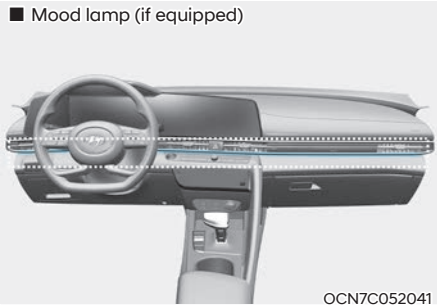

- Map lamp



- Room lamp



If the LED lamp does not operate, have the system checked by an authorized HYUNDAI dealer.

The LED lamps cannot be replaced as a single unit because it is an integrated unit. The LED lamps has to be replaced with the unit. A skilled technician should check or repair the LED lamp, for it may damage related parts of the vehicle.

## APPEARANCE CARE

### Exterior Care

#### **NOTICE**

**If you park your vehicle near a stainless steel sign or glass facade building, the vehicle's exterior plastic parts such as a bumper, spoiler, garnish, lamp or side view mirror might be damaged due to sunlight reflected from the sign or building. To prevent damage of the exterior plastic parts, you should avoid parking in areas where light may be reflected or use a car cover. (The exterior plastic parts applied to your vehicle may vary.)**

#### **Exterior general caution**

It is very important to follow the label directions when using any chemical cleaner or polish. Read all warning and caution statements that appear on the label.

#### **High-pressure washing**

- When using high-pressure washers, make sure to maintain sufficient distance from the vehicle. Insufficient clearance or excessive pressure can lead to component damage or water penetration.
- Do not spray the camera, sensors or its surrounding area directly with a high pressure washer. Shock applied from high pressure water may cause the device to not operate normally.
- Do not bring the nozzle tip close to boots (rubber or plastic covers) or connectors as they may be damaged if they come into contact with high pressure water.
- Do not use any high-pressure nozzles, which induce either one-direct water stream or water swirling.

#### **Protecting your vehicle's finish**

##### **Washing**

To help protect your vehicle's finish from rust and deterioration, wash it thoroughly and frequently at least once a month with lukewarm or cold water.

If you use your vehicle for off-road driving, you should wash it after each off-road trip. Pay special attention to the removal of any accumulation of salt, dirt, mud, and other foreign materials. Make sure the drain holes in the lower edges of the doors and rocker panels are kept clear and clean.

Insects, tar, tree sap, bird droppings, industrial pollution and similar deposits can damage your vehicle's finish if not removed immediately.

Even prompt washing with plain water may not completely remove all these deposits. A mild soap, safe for use on painted surfaces, should be used.

After washing, rinse the vehicle thoroughly with lukewarm or cold water. Do not allow soap to dry on the finish.

##### **High-pressure washing**

- When using high-pressure washers, make sure to maintain sufficient distance from the vehicle. Insufficient clearance or excessive pressure can lead to component damage or water penetration.
- Do not spray the camera, sensors or its surrounding area directly with a high pressure washer. Shock applied from high pressure water may cause the device to not operate normally.
- Do not bring the nozzle tip close to boots (rubber or plastic covers) or connectors as they may be damaged if they come into contact with high pressure water.



**WARNING**

After washing the vehicle, test the brakes while driving slowly to see if they have been affected by water before getting on the road. If braking performance is impaired, dry the brakes by applying them lightly while maintaining a slow forward speed.

**NOTICE**

- Do not use strong soap, chemical detergents or hot water, and do not wash the vehicle in direct sunlight or when the body of the vehicle is warm.
- Be careful when washing the side windows of your vehicle.

Especially, with high-pressure water, water may leak through the windows and wet the interior.

- To prevent damage to the plastic parts, do not clean with chemical solvents or strong detergents.

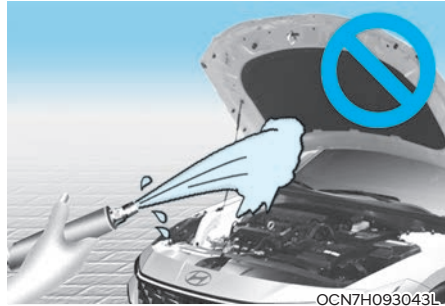

**NOTICE**

- Water washing in the engine compartment including high pressure water washing may cause the failure of electrical circuits located in the engine compartment.
- Never allow water or other liquids to come in contact with electrical/ electronic components inside the vehicle as this may damage them.

**NOTICE**

Matte paint finish vehicle (if equipped)  
Automatic car wash which uses rotating brushes should not be used as this can damage the surface of your vehicle. A steam cleaner which washes the vehicle surface at high temperature may cause oil to adhere and leave stains that is difficult to remove.

Use a soft cloth (e.g. microfiber towel or sponge) when washing your vehicle and dry with a microfiber towel. When you hand wash your vehicle, you should not use a cleaner that finishes with wax. If the vehicle surface is too dirty (sand, dirt, dust, contaminant, etc.), clean the surface with water before washing the car.

### Waxing

A good coat of wax provides a barrier between your paint and environmental contamination.

Keeping a good coat of wax on your vehicle will help protect it.

Wax the vehicle when water will no longer bead on the paint.

Always wash and dry the vehicle before waxing. Use a good quality liquid or paste wax, and follow the manufacturer's instructions. Wax all metal trim to protect it and to maintain its luster.

Removing oil, tar, and similar materials with a spot remover will usually strip the wax from the finish. Be sure to re-wax these areas even if the rest of the vehicle does not yet need waxing.

#### NOTICE

- Wiping dust or dirt off the body with a dry cloth will scratch the finish.
- Do not use steel wool, abrasive cleaners, or strong detergents containing highly alkaline or caustic agents on chrome-plated or anodized aluminum parts. This may result in damage to the protective coating and cause discoloration or paint deterioration.

#### NOTICE

**Matte paint finish vehicle (if equipped)**

Do not use any polish protector such as a detergent, an abrasive and a polish. In case wax is applied, remove the wax immediately using a silicon remover and if any tar or tar contaminant is on the surface use a tar remover to clean. However, be careful not to apply too much pressure on the painted area.

### Repairing your vehicle's finish

Deep scratches or stone chips in the painted surface must be repaired promptly. Exposed metal will quickly rust and may develop into a major repair expense.

#### NOTICE

**If your vehicle is damaged and requires any metal repair or replacement, be sure the body shop applies anti-corrosion materials to the parts repaired or replaced.**

#### NOTICE

**Matte paint finish vehicle (if equipped)**

In case of matte paint finish vehicles, it is impossible to modify only the damaged area and repair of the whole part is necessary. If the vehicle is damaged and painting is required, we recommend that you have your vehicle maintained and repaired by an authorized HYUNDAI dealer. Take extreme care, as it is difficult to restore the quality after the repair.

### Bright-metal maintenance

- To remove road tar and insects, use a tar remover, not a scraper or other sharp object.
- To protect the surfaces of bright metal parts from corrosion, apply a coating of wax or chrome preservative and rub to a high luster.
- During winter weather or in coastal areas, cover the bright metal parts with a heavier coating of wax or preservative. If necessary, coat the parts with non-corrosive petroleum jelly or other protective compound.

### **Underbody maintenance**

Corrosive materials used for ice and snow removal and dust control may collect on the underbody. If these materials are not removed, accelerated rusting can occur on underbody parts such as the fuel lines, frame, floor pan and exhaust system, even though they have been treated with rust protection.

Thoroughly flush the vehicle underbody and wheel openings with lukewarm or cold water once a month, after off-road driving and at the end of each winter. Pay special attention to these areas because it is difficult to see all the mud and dirt. It will do more harm than good to wet down the road grime without removing it. The lower edges of doors, rocker panels, and frame members have drain holes that should not be allowed to clog with dirt; trapped water in these areas can cause rusting.



### **WARNING**

**After washing the vehicle, test the brakes while driving slowly to see if they have been affected by water. If braking performance is impaired, dry the brakes by applying them lightly while maintaining a slow forward speed.**

### **Aluminum wheel maintenance**

The aluminum wheels are coated with a clear protective finish.

#### **NOTICE**

- **Do not use abrasive cleaner, polishing compound, solvent, or wire brushes on aluminum wheels.**
- **Clean the wheel when it has cooled.**
- **Use only a mild soap or neutral detergent, and rinse thoroughly with water. Also, clean the wheels after driving on salted roads.**
- **Do not wash the wheels with high-speed car wash brushes.**
- **Do not use any cleaners containing acid or alkaline detergents.**

## **Corrosion protection**

### **Protecting your vehicle from corrosion**

By using the most advanced design and construction practices to combat corrosion, HYUNDAI produces vehicles of the highest quality. However, this is only part of the job. To achieve the long-term corrosion resistance your vehicle can deliver, the owner's cooperation and assistance is also required.

### **Common causes of corrosion**

The most common causes of corrosion on your vehicle are:

- Road salt, dirt and moisture that is allowed to accumulate underneath the vehicle.
- Removal of paint or protective coatings by stones, gravel, abrasion or minor scrapes and dents which leave unprotected metal exposed to corrosion.

### **High-corrosion areas**

If you live in an area where your vehicle is regularly exposed to corrosive materials, corrosion protection is particularly important. Some of the common causes of accelerated corrosion are road salts, dust control chemicals, ocean air and industrial pollution.

### **Moisture breeds corrosion**

Moisture creates the conditions in which corrosion is most likely to occur. For example, corrosion is accelerated by high humidity, particularly when temperatures are just above freezing. In such conditions, the corrosive material is kept in contact with the car surfaces by moisture that is slow to evaporate.

Mud is particularly corrosive because it is slow to dry and holds moisture in contact with the vehicle. Although the mud appears to be dry, it can still retain the moisture and promote corrosion.

High temperatures can also accelerate corrosion of parts that are not properly ventilated so the moisture can be dispersed. For all these reasons, it is particularly important to keep your vehicle clean and free of mud or accumulations of other materials. This applies not only to the visible surfaces but particularly to the underside of the vehicle.

### To help prevent corrosion

#### *Keep your vehicle clean*

The best way to prevent corrosion is to keep your vehicle clean and free of corrosive materials. Attention to the underside of the vehicle is particularly important.

- If you live in a high-corrosion area — where road salts are used, near the ocean, areas with industrial pollution, acid rain, etc.—, you should take extra care to prevent corrosion. In winter, hose off the underside of your vehicle at least once a month and be sure to clean the underside thoroughly when winter is over.
- When cleaning underneath the vehicle, pay particular attention to the components under the fenders and other areas that are hidden from view. Do a thorough job; just dampening the accumulated mud rather than washing it away will accelerate corrosion rather than prevent it. Water under high pressure and steam are particularly effective in removing accumulated mud and corrosive materials.
- When cleaning lower door panels, rocker panels and frame members, be sure that drain holes are kept open so that moisture can escape and not be trapped inside to accelerate corrosion.

#### *Keep your garage dry*

Don't park your vehicle in a damp, poorly ventilated garage. This creates a favorable environment for corrosion. This is particularly true if you wash your vehicle in the garage or drive it into the garage when it is still wet or covered with snow, ice or mud. Even a heated garage can contribute to corrosion unless it is well ventilated so moisture is dispersed.

#### *Keep paint and trim in good condition*

Scratches or chips in the finish should be covered with "touch-up" paint as soon as possible to reduce the possibility of corrosion. If bare metal is showing through, the attention of a qualified body and paint shop is recommended.

Bird droppings are highly corrosive and may damage painted surfaces in just a few hours. Always remove bird droppings as soon as possible.

## Interior Care

### *Interior general precautions*

Prevent caustic solutions such as perfume and cosmetic oil, from contacting the interior parts because they may cause damage or discoloration. If they do contact the interior parts, wipe them off immediately. See the instructions for the proper way to clean vehicle interior surfaces.

#### **NOTICE**

- **Never allow water or other liquids to come in contact with electrical/electronic components inside the vehicle as this may damage them.**
- **When cleaning leather products (steering wheel, seats etc.), use neutral detergents or low alcohol content solutions. If you use high alcohol content solutions or acid/alkaline detergents, the color of the leather may fade or the surface may get stripped off.**
- **During window tinting, make sure window tinting solution does not flow into electronic devices inside the vehicle. It may cause breakdown and malfunction of devices.**

### *Cleaning the upholstery and interior trim*

#### **Vehicle interior surfaces (if equipped)**

Remove dust and loose dirt from interior surfaces with a whisk broom or a vacuum cleaner.

If necessary, clean interior surfaces with a mixture of warm water and mild non-detergent cleaner (test all cleaners on a concealed area before use).

#### **Fabric (if equipped)**

Remove dust and loose dirt from fabric with a whisk broom or vacuum cleaner. Clean with a mild soap solution recommended for upholstery or carpets. Remove fresh spots immediately with a fabric spot cleaner. If fresh spots do not receive immediate attention, the fabric can be stained and its color can be affected. Also, its fire-resistant properties can be reduced if the material is not properly maintained.

#### **NOTICE**

**Using anything but recommended cleaners and procedures may affect the fabric's appearance and fire-resistant properties.**

### Leather (if equipped)

- Features of seat leather
  - Leather is made from the outer skin of an animal, which goes through a special process to be available for use. Since it is a natural product, each part differs in thickness or density.  
Wrinkles may appear as a natural result of stretching and shrinking depending on the temperature and humidity.
  - The seat is made of stretchable fabric to improve comfort.
  - The parts contacting the body are curved and the side supporting area is high which provides driving comfort and stability.
  - Wrinkles may appear naturally from usage. It is not a fault of the products.



### CAUTION

- **Wrinkles or abrasions which appear naturally from usage are not covered by warranty.**
  - **Belts with metallic accessories, zippers or keys inside the back pocket may damage the seat fabric.**
  - **Make sure not to wet the seat. It may change the nature of natural leather.**
  - **Jeans or clothes which could bleach may contaminate the surface of the seat covering fabric.**
- Caring for the leather seats
    - Vacuum the seat periodically to remove dust and sand on the seat. It will prevent abrasion or damage of the leather and maintain its quality.
    - Wipe the natural leather seat cover often with dry or soft cloth.
    - Use of proper leather protector may prevent abrasion of the cover and helps maintain the color. Be sure to read the instructions and consult a specialist when using leather coating or protective agent.
    - Light colored (beige, cream beige) leather is easily contaminated and the stain is noticeable. Clean the seats frequently.
    - Avoid wiping with wet cloth. It may cause the surface to crack.
  - Cleaning the leather seats
    - Remove all contaminations instantly. Refer to instructions below for removal of each contaminant.
    - Cosmetic products (sunscreen, foundation, etc.)  
Apply cleansing cream on a cloth and wipe the contaminated spot. Wipe off the cream with a wet cloth and remove water with a dry cloth.
    - Beverages (coffee, soft drink, etc.)  
Apply a small amount of neutral detergent and wipe until contaminations do not smear.
    - Oil  
Remove oil instantly with absorbable cloth and wipe with stain remover used only for natural leather.
    - Chewing gum  
Harden the gum with ice and remove gradually.

***Cleaning the seat belt webbing***

Clean the belt webbing with any mild soap solution recommended for cleaning upholstery or carpet. Follow the instructions provided with the soap. Do not bleach or re-dye the webbing because this may weaken the seat belt.

***Cleaning the interior window glass***

If the interior glass surfaces of the vehicle become hazy (that is, covered with an oily, greasy or waxy film), they should be cleaned with glass cleaner. Follow the directions on the glass cleaner container.

**NOTICE**

**Do not scrape or scratch the inside of the rear window. This may result in damage to the rear window defroster grid.**

## EMISSION CONTROL SYSTEM

The emission control system of your vehicle is covered by a written limited warranty. Please see the warranty information contained in the Owner's Handbook & Warranty Information booklet in your vehicle.

Your vehicle is equipped with an emission control system to meet all applicable emission regulations. There are three emission control systems, as follows.

- (1) Crankcase emission control system
- (2) Evaporative emission control system
- (3) Exhaust emission control system

In order to ensure the proper function of the emission control systems, it is recommended that you have your vehicle inspected and maintained by an authorized HYUNDAI dealer in accordance with the maintenance schedule in this manual.

### NOTICE

#### For the Inspection and Maintenance Test (with Electronic Stability Control (ESC) system)

- **To prevent the vehicle from misfiring during dynamometer testing, turn the Electronic Stability Control (ESC) system off by pressing the ESC switch (ESC OFF light illuminated).**
- **After dynamometer testing is completed, turn the ESC system back on by pressing the ESC switch again.**

### 1. Crankcase Emission Control System

The positive crankcase ventilation system is employed to prevent air pollution caused by blow-by gases being emitted from the crankcase. This system supplies fresh filtered air to the crankcase through the air intake hose. Inside the crankcase, the fresh air mixes with blow-by gases, which then pass through the PCV valve into the induction system.

### 2. Evaporative Emission Control System Including Onboard Refueling Vapor Recovery (ORVR)

The Evaporative Emission Control System is designed to prevent fuel vapors from escaping into the atmosphere. The ORVR system is designed to allow the vapors from the fuel tank to be loaded into a canister while refueling at the gas station, preventing the escape of fuel vapors into the atmosphere.

#### Canister

Fuel vapors generated inside the fuel tank are absorbed and stored in the onboard canister. When the engine is running, the fuel vapors absorbed in the canister are drawn into the surge tank through the purge control solenoid valve.

#### Purge Control Solenoid Valve (PCSV)

The purge control solenoid valve is controlled by the Engine Control Module (ECM); when the engine coolant temperature is low during idling, the PCSV closes so that evaporated fuel is not taken into the engine. After the engine warms-up during ordinary driving, the PCSV opens to introduce evaporated fuel to the engine.

### 3. Exhaust Emission Control System

The Exhaust Emission Control System is a highly effective system which controls exhaust emissions while maintaining good vehicle performance.

When the engine starts or fails to start, excessive attempts to restart the engine may cause damage to the emission system.

#### ***Engine exhaust (carbon monoxide) precautions***

- Carbon monoxide can be present with other exhaust fumes. If you smell exhaust fumes of any kind in your vehicle, drive with all the windows fully open. Have your vehicle checked and repaired immediately.



#### **WARNING**

Engine exhaust gases contain carbon monoxide (CO). Though colorless and odorless, it is dangerous and could be lethal if inhaled. Follow the instructions on this page to avoid CO poisoning.



#### **WARNING**

##### **CALIFORNIA PROPOSITION 65 WARNING**

Engine exhaust and a wide variety of automobile components and parts, including components found in the interior furnishings in a vehicle, contain or emit chemicals known to the State of California to cause cancer and birth defects and reproductive harm. In addition, certain fluids contained in vehicles and certain products of component wear contain or emit chemicals known to the State of California to cause cancer and birth defects or other reproductive harm.

- Do not operate the engine in confined or closed areas (such as garages) any more than what is necessary to move the vehicle in or out of the area.
- When the vehicle is stopped in an open area for more than a short time with the engine running, adjust the ventilation system (as needed) to draw outside air into the vehicle.
- Never sit in a parked or stopped vehicle for any extended time with the engine running.
- When the engine stalls or fails to start, excessive attempts to restart the engine may cause damage to the emission control system.

***Operating precautions for catalytic converters (if equipped)***



**WARNING**

The exhaust system and catalytic system are very hot while the engine is running or immediately after the engine is turned off. To avoid **SERIOUS INJURY** or **DEATH**:

- Do not park, idle, or drive the vehicle over or near flammable objects, such as grass, vegetation, paper, leaves, etc. A hot exhaust system can ignite flammable items under your vehicle.
- Keep away from the exhaust system and catalytic converter or you may get burned.

**Also, do not remove the heat sink around the exhaust system, do not seal the bottom of the vehicle, and do not coat the vehicle for corrosion control. It may present a fire risk under certain conditions.**

Your vehicle is equipped with a catalytic converter emission control device.

To prevent damage to the catalytic converter and to your vehicle, take the following precautions:

- Use only UNLEADED FUEL for gasoline engines.
- Do not operate the vehicle when there are signs of engine malfunction, such as misfire or a noticeable loss of performance.
- Do not misuse or abuse the engine. Examples of misuse are coasting with the engine off and descending steep grades in gear with the engine off.
- Do not operate the engine at high idle speed for extended periods (5 minutes or more).
- Do not modify or tamper with any part of the engine or emission control system. All inspections and adjustments must be made by an authorized HYUNDAI dealer.
- Avoid driving with extremely low fuel level. If you run out of gasoline, it could cause the engine to misfire and result in excessive loading of the catalytic converter.

## **CALIFORNIA PERCHLORATE NOTICE**

Perchlorate Material-special handling may apply, See:  
“<https://dtsc.ca.gov/perchlorate>”

Notice to California Vehicle Dismantlers:

Perchlorate containing materials, such as air bag inflators, seatbelt pretensioners and keyless remote entry batteries, must be disposed of according to Title 22 California Code of Regulations Section 67384.10 (a).



# Index

---

**A**

Accessing Your Vehicle ..... 5-4  
    Immobilizer System ..... 5-14  
    Remote Key ..... 5-4  
    Smart Key ..... 5-7  
Air Cleaner ..... 9-26  
    Filter Replacement ..... 9-26  
Air Conditioning System ..... 2-11  
Airbag - Advanced Supplemental Restraint System ..... 3-36  
    Additional Safety Precautions ..... 3-56  
    Airbag Warning Labels ..... 3-56  
    How Does the Airbag System Operate? ..... 3-41  
    Occupant Classification System (OCS) ..... 3-45  
    SRS Care ..... 3-55  
    What to Expect After an Airbag Inflates ..... 3-44  
    Where are the Airbags? ..... 3-38  
    Why Didn't My Airbag Go Off in a Collision? ..... 3-51  
Appearance Care ..... 9-63  
    Exterior Care ..... 9-63  
    Interior Care ..... 9-69  
Automatic Climate Control System ..... 5-82  
    Automatic Heating and Air Conditioning ..... 5-83  
    Manual Heating and Air Conditioning ..... 5-84  
    System Maintenance ..... 5-92  
    System Operation ..... 5-90

**B**

Battery ..... 9-31  
    12 V auxiliary battery ..... 9-31  
Before Driving ..... 6-4  
    Before Entering the Vehicle ..... 6-4  
    Before Starting ..... 6-4  
Blind-Spot Collision-Avoidance Assist (BCA) ..... 7-38  
    Blind-Spot Collision-Avoidance Assist Malfunction and Limitations ..... 7-43  
    Blind-Spot Collision-Avoidance Assist Operation ..... 7-41  
    Blind-Spot Collision-Avoidance Assist Settings ..... 7-39

Brake Fluid .....	9-24
Checking the Brake Fluid Level.....	9-24
Brake System.....	6-22
Anti-lock Brake System (ABS).....	6-30
Auto Hold.....	6-27
Disc Brakes Wear Indicator.....	6-22
Electronic Parking Brake (EPB) .....	6-23
Electronic Stability Control (ESC).....	6-32
Good Braking Practices.....	6-36
Hill-Start Assist Control (HAC).....	6-35
Power Brakes.....	6-22
Vehicle Stability Management (VSM).....	6-34
Bulb Wattage.....	2-9

## C

Cabin Air Filter.....	9-28
Filter Inspection.....	9-28
Filter Replacement .....	9-28
California Perchlorate Notice .....	9-75
Child Restraint System (CRS).....	3-27
Children Always in the Rear .....	3-27
Installing a Child Restraint System (CRS).....	3-29
Selecting a Child Restraint System (CRS).....	3-28
Climate Control Additional Features .....	5-98
Auto Comfort Control (for driver's seat) .....	5-98
Automatic Ventilation.....	5-98
Sunroof Inside Air Recirculation.....	5-98
Cluster Display (Type A).....	4-26
Cluster Display Control.....	4-26
Cluster Display Modes .....	4-27
User Settings Mode .....	4-30
Cluster Display (Type B).....	4-36
Cluster Display Control.....	4-36
Cluster Display Modes .....	4-37
Trip Computer .....	4-40

Coasting Guide ..... 6-21  
 Consumer Information..... 2-16  
 Cruise Control (CC)..... 7-69  
     Cruise Control Operation ..... 7-69

**D**

Declaration of Conformity..... 7-124  
     Front Radar..... 7-124  
     Rear Corner Radar..... 7-124  
 Dimensions ..... 2-8  
 Door Locks ..... 5-27  
     Automatic Door Lock and Unlock Features ..... 5-31  
     Child-Protector Rear Door Locks ..... 5-31  
     Operating Door Locks from Inside the Vehicle..... 5-29  
     Operating Door Locks from Outside the Vehicle ..... 5-27  
 Drive Mode Integrated Control System..... 6-37  
     Drive Mode ..... 6-37  
 Driver Attention Warning (DAW) ..... 7-61  
     Driver Attention Warning Malfunction and Limitations ..... 7-63  
     Driver Attention Warning Operation ..... 7-62  
     Driver Attention Warning Setting..... 7-61  
 Driver Position Memory System ..... 5-34  
     Recalling Memory Positions ..... 5-34  
     Resetting Integrated Memory System..... 5-35  
     Seat Easy Access Operation ..... 5-36  
     Storing Memory Positions..... 5-34  
     While Resetting the Integrated Memory System ..... 5-35  
 Driving the Hybrid Vehicle..... 1-10  
     Cluster Display Messages ..... 1-14  
     Energy Flow ..... 1-17  
     Hybrid System Gauge ..... 1-12  
     Special Features..... 1-10  
     Starting the Vehicle ..... 1-10  
     Warning and Indicator Lights..... 1-13  
 Dual Clutch Transmission ..... 6-13  
     DCT Warning Messages..... 6-18  
     Dual Clutch Transmission Operation ..... 6-13  
     Good Driving Practices ..... 6-20

Parking .....	6-19
---------------	------

## E

Emission Control System .....	9-72
Crankcase Emission Control System .....	9-72
Evaporative Emission Control System Including Onboard Refueling Vapor Recovery (ORVR) .....	9-72
Exhaust Emission Control System .....	9-73
Engine Clutch Actuator Fluid .....	9-25
Checking the Engine Clutch Actuator Fluid Level .....	9-25
Engine Compartment .....	2-7/9-3
Engine Coolant/Inverter Coolant .....	9-19
Changing Engine Coolant .....	9-22
Checking the Coolant Level .....	9-19
Engine Number .....	2-15
Engine Oil .....	9-16
Checking the Engine Oil and Filter .....	9-17
Checking the Engine Oil Level .....	9-16
Engine Specification .....	2-8
Explanation of Scheduled Maintenance Items .....	9-14
Exterior Lights .....	5-69
Battery Saver Function .....	5-71
Daytime Running Light (DRL) .....	5-72
Headlight Delay Function .....	5-72
High Beam Operation .....	5-70
Lighting Control .....	5-69
Turn Signals and Lane Change Signals .....	5-71
Exterior Overview (Front View) .....	2-2
Exterior Overview (Rear View) .....	2-3

## F

Forward Collision–Avoidance Assist (FCA) (front view camera only) .....	7-2
Forward Collision-Avoidance Assist Malfunction and Limitations .....	7-7
Forward Collision-Avoidance Assist Operation .....	7-4
Forward Collision-Avoidance Assist Settings .....	7-3
Forward Collision–Avoidance Assist (FCA) (sensor fusion) .....	7-14
Forward Collision-Avoidance Assist Malfunction and Limitation .....	7-23
Forward Collision-Avoidance Assist Operation .....	7-17
Forward Collision-Avoidance Assist Settings .....	7-16

Fuel Filler Door ..... 5-66  
    Closing the Fuel Filler Door..... 5-67  
    Opening the Fuel Filler Door ..... 5-66  
Fuel Requirements ..... 1-5  
Fuses ..... 9-45  
    Engine Compartment Panel Fuse Replacement ..... 9-47  
    Fuse/Relay Panel Description ..... 9-48  
    Instrument Panel Fuse Replacement ..... 9-46

**G**

Guide to Hyundai Genuine Parts ..... 1-3

**H**

Hazard Warning Flasher ..... 8-2  
HEV (Hybrid Electric Vehicle) System ..... 1-9  
High Beam Assist (HBA) ..... 5-73  
    High Beam Assist Malfunction and Limitations ..... 5-74  
    High Beam Assist Operation ..... 5-74  
    High Beam Assist Settings ..... 5-73  
Highway Driving Assist (HDA) ..... 7-99  
    Highway Driving Assist Malfunction and Limitations ..... 7-103  
    Highway Driving Assist Operation ..... 7-101  
    Highway Driving Assist Settings ..... 7-100  
Hood ..... 5-59  
How to Use This Manual ..... 1-4  
Hybrid Starter & Generator (HSG) Belt..... 9-23  
    Checking the Hybrid Starter & Generator (HSG) Belt ..... 9-23  
Hyundai Digital Key ..... 5-16  
    Digital Key (Card Key) ..... 5-21  
    Digital Key (Smartphone) ..... 5-16  
    Limitations of the System ..... 5-26  
    Used Vehicle/Digital Key Maintenance ..... 5-26  
HYUNDAI Motor America ..... 1-2

I

- If the 12 V Battery Is Discharged ..... 8-4
  - Before Jump Starting..... 8-4
  - Jump Starting..... 8-5
- If the Engine Overheats ..... 8-7
- If the Engine Will Not Start ..... 8-3
- If You Have a Flat Tire (with Tire Mobility Kit) ..... 8-15
  - Components of the Tire Mobility Kit..... 8-17
  - How to Adjust Tire Pressure..... 8-22
  - Introduction ..... 8-15
  - Notes on the safe use of the Tire Mobility Kit ..... 8-16
  - Using the Tire Mobility Kit..... 8-18
- Ignition Switch ..... 6-5
  - Engine Start/Stop Button..... 6-8
  - Key Ignition Switch ..... 6-5
- Important Safety Precautions..... 3-2
  - Airbag Hazards..... 3-2
  - Always Wear Your Seat Belt ..... 3-2
  - Control Your Speed ..... 3-2
  - Driver Distraction..... 3-2
  - Keep Your Vehicle in Safe Condition..... 3-2
  - Restrain All Children..... 3-2
- In Case of an Emergency While Driving..... 8-2
  - If the Engine Stalls at a Crossroad or Crossing..... 8-2
  - If the Engine Stalls While Driving..... 8-2
  - If you Have a Flat Tire While Driving ..... 8-3
- Infotainment System..... 5-106
  - Antenna ..... 5-107
  - Bluetooth® Wireless Technology hands-free ..... 5-109
  - How Vehicle Radio Works ..... 5-110
  - Infotainment System ..... 5-109
  - Steering Wheel Audio Control ..... 5-108
  - USB Port ..... 5-106
  - Voice Recognition ..... 5-109

- Instrument Cluster ..... 4-4
  - Cluster Display Messages ..... 4-20
  - Gauges and Meters ..... 4-5
  - Instrument Cluster Control ..... 4-5
  - Transmission Shift Indicator ..... 4-9
  - Warning and Indicator Lights ..... 4-10
- Instrument Panel Overview ..... 2-5
- Intelligent Speed Limit Assist (ISLA) ..... 7-56
  - Intelligent Speed Limit Assist Malfunction and Limitations ..... 7-59
  - Intelligent Speed Limit Assist Operation ..... 7-57
  - Intelligent Speed Limit Assist Settings ..... 7-56
- Interior Features ..... 5-100
  - Clock ..... 5-105
  - Clothes Hanger ..... 5-105
  - Cup Holder ..... 5-100
  - Power Outlet ..... 5-101
  - Sunvisor ..... 5-101
  - USB Charger ..... 5-102
  - Wireless Cellular Phone Charging System ..... 5-103
- Interior Lights ..... 5-76
  - Front Lamps ..... 5-76
  - Interior Lights Auto Off ..... 5-76
  - Luggage Compartment Lamp ..... 5-78
  - Room Lamp ..... 5-77
  - Vanity Mirror Lamp ..... 5-78
  - Welcome System ..... 5-79
- Interior Overview ..... 2-4
- Introduction ..... 1-2

**L**

- Lane Following Assist (LFA) ..... 7-95
  - Lane Following Assist Malfunction and Limitations ..... 7-98
  - Lane Following Assist Operation ..... 7-96
  - Lane Following Assist Settings ..... 7-95
- Lane Keeping Assist (LKA) ..... 7-31
  - Lane Keeping Assist Malfunction and Limitations ..... 7-35
  - Lane Keeping Assist Operation ..... 7-32
  - Lane Keeping Assist Settings ..... 7-31

Light Bulbs .....	9-55
Headlight, Parking Lamp, Daytime Running Light, Turn Signal Lamp and Side Marker .....	9-55
High Mounted Stop Lamp Replacement .....	9-60
Interior Light Bulb Replacement.....	9-61
License Plate Light Bulb Replacement .....	9-60
Rear Combination Lamp Bulb Replacement .....	9-57
Side Repeater Lamp Replacement (if equipped).....	9-57

## M

Maintenance Services .....	9-4
Owner Maintenance Precautions.....	9-4
Owner's Responsibility .....	9-4
Manual Speed Limit Assist (MSLA) .....	7-53
Manual Speed Limit Assist Operation .....	7-53
Mirrors .....	5-40
Inside Rearview Mirror .....	5-40
Side View Mirrors .....	5-48

## N

Navigation-based Smart Cruise Control (NSCC).....	7-89
Navigation-based Smart Cruise Control Operation .....	7-90
Navigation-based Smart Cruise Control Settings.....	7-89

## O

Open Source Software Notice (For Plug-in Hybrid Vehicle) .....	2-15
Owner Maintenance.....	9-5
Owner Maintenance Schedule.....	9-5

## R

Rear Cross-Traffic Collision-Avoidance Assist (RCCA).....	7-114
Rear Cross-Traffic Collision Avoidance Asseset Operation.....	7-116
Rear Cross-Traffic Collision-Avoidance Assist Malfunction and Limitations .	7-119
Rear Cross-Traffic Collision-Avoidance Assist Settings.....	7-115
Rear Occupant Alert (ROA) .....	5-32
Rear Occupant Alert Operation .....	5-32
Rear View Monitor (RVM).....	7-106
Rear View Monitor Malfunctionand Limitations .....	7-108

Rear View Monitor Operation..... 7-107  
 Rear View Monitor Settings..... 7-106  
 Recommended Lubricants and Capacities..... 2-12  
     Recommended SAE Viscosity Number ..... 2-13  
 Reporting Safety Defects..... 2-17

**S**

Safe Exit Warning (SEW)..... 7-48  
     Safe Exit Warning Malfunction and Limitations..... 7-51  
     Safe Exit Warning Operation..... 7-50  
     Safe Exit Warning Settings..... 7-49  
 Safety Messages..... 1-4  
 Safety Precautions for Hybrid System..... 1-20  
     Countermeasures for Accidents or Fire..... 1-24  
     High Voltage Cut-off Switch..... 1-22  
     Hybrid Battery Cooling Duct..... 1-23  
     Hybrid Vehicle Components ..... 1-20  
     When the Hybrid Vehicle Shuts Off..... 1-25  
 Scheduled Maintenance Services ..... 9-7  
     Maintenance Under Severe Usage Conditions ..... 9-12  
     Normal Maintenance Schedule ..... 9-8  
 Seat Belts ..... 3-18  
     Additional Seat Belt Safety Precautions ..... 3-24  
     Care of Seat Belts..... 3-26  
     Seat Belt Restraint System ..... 3-19  
     Seat Belt Safety Precautions ..... 3-18  
     Seat Belt Warning Light..... 3-19  
 Seats..... 3-3  
     Air Ventilation Seat..... 3-17  
     Front Seats..... 3-5  
     Head Restraints ..... 3-11  
     Rear Seats..... 3-10  
     Safety Precautions..... 3-4  
     Seat Warmers..... 3-15  
 Setting Your Vehicle ..... 4-43  
 Smart Cruise Control (SCC)..... 7-73  
     Smart Cruise Control Malfunction and Limitations..... 7-83  
     Smart Cruise Control Operation..... 7-74  
     Smart Cruise Control Settings..... 7-73

Special Driving Conditions .....	6-40
Driving at Night .....	6-41
Driving in Flooded Areas .....	6-42
Driving in the Rain .....	6-41
Hazardous Driving Conditions .....	6-40
Highway Driving .....	6-42
Rocking the Vehicle .....	6-40
Smooth Cornering .....	6-41
Steering Wheel .....	5-37
Horn .....	5-39
Motor Driven Power Steering (MDPS) .....	5-37
Tilt Steering / Telescope Steering .....	5-38
Steering Wheel Control Overview .....	2-6
Storage Compartment .....	5-99
Center Console Storage .....	5-99
Glove Box .....	5-99
Sunroof .....	5-55
Automatic Reversal .....	5-57
Resetting the Sunroof .....	5-58
Slide Open/Close .....	5-56
Sunroof Open Warning .....	5-58
Sunshade .....	5-55
Tilt Open/Close .....	5-56

## T

Theft-Alarm System .....	5-33
Tire Pressure Monitoring System (TPMS) .....	8-9
Changing a Tire with TPMS .....	8-13
Check Tire Pressure .....	8-9
Low Tire Pressure Position and Tire Pressure Telltale .....	8-11
Low Tire Pressure Telltale .....	8-11
Tire Pressure Monitoring System .....	8-10
TPMS (Tire Pressure Monitoring System) Malfunction Indicator .....	8-13
Tire Specification and Pressure Label .....	2-15
Tires and Wheels .....	2-10/9-32
All Season Tires .....	9-43
Check Tire Inflation Pressure .....	9-33
Low Aspect Ratio Tires .....	9-44
Radial-Ply Tires .....	9-43

Recommended Cold Tire Inflation Pressures.....	9-32
Snow Tires.....	9-43
Summer Tires.....	9-43
Tire Care.....	9-32
Tire Maintenance.....	9-37
Tire Replacement.....	9-35
Tire Rotation.....	9-34
Tire Sidewall Labeling.....	9-37
Tire Terminology and Definitions.....	9-40
Tire Traction.....	9-37
Wheel Alignment and Tire Balance.....	9-35
Wheel Replacement.....	9-37
Towing.....	8-23
Emergency Towing.....	8-25
Emergency Towing.....	8-24
Removable Towing Hook.....	8-24
Towing Service.....	8-23
Trailer Towing.....	6-51
Trunk.....	5-61
Emergency Trunk Safety Release.....	5-62
Opening the Trunk.....	5-61
Smart Trunk with Auto Open.....	5-63

**V**

Vehicle Auto-Shut Off.....	6-12
Deactivating Conditions.....	6-12
Operating Conditions.....	6-12
System Operation.....	6-12
Vehicle Break-in Process.....	1-7
Vehicle Certification Label.....	2-14
Vehicle Data Collection and Event Data Recorders.....	1-8
Vehicle Identification Number (VIN).....	2-14
Vehicle Load Limit.....	6-46
Tire Loading Information Label.....	6-47
Vehicle Modifications.....	1-7
Vehicle Settings (Infotainment System).....	4-43
Volume and Weight.....	2-11

**W**

Washer Fluid.....	9-26
Checking the Washer Fluid Level .....	9-26
Windows .....	5-50
Power Windows.....	5-51
Windshield Defrosting and Defogging .....	5-94
Auto Defogging System.....	5-96
Automatic Climate Control System .....	5-94
Defogging Logic .....	5-95
Defroster.....	5-97
Winter Driving.....	6-43
Snow or Icy Conditions.....	6-43
Winter Precautions .....	6-44
Wiper Blades.....	9-29
Blade Inspection.....	9-29
Blade Replacement.....	9-29
Wipers and Washers.....	5-80
Windshield Washers .....	5-81
Windshield Wipers .....	5-80