

2026

Sportage HEV/PHEV

Owner's Manual

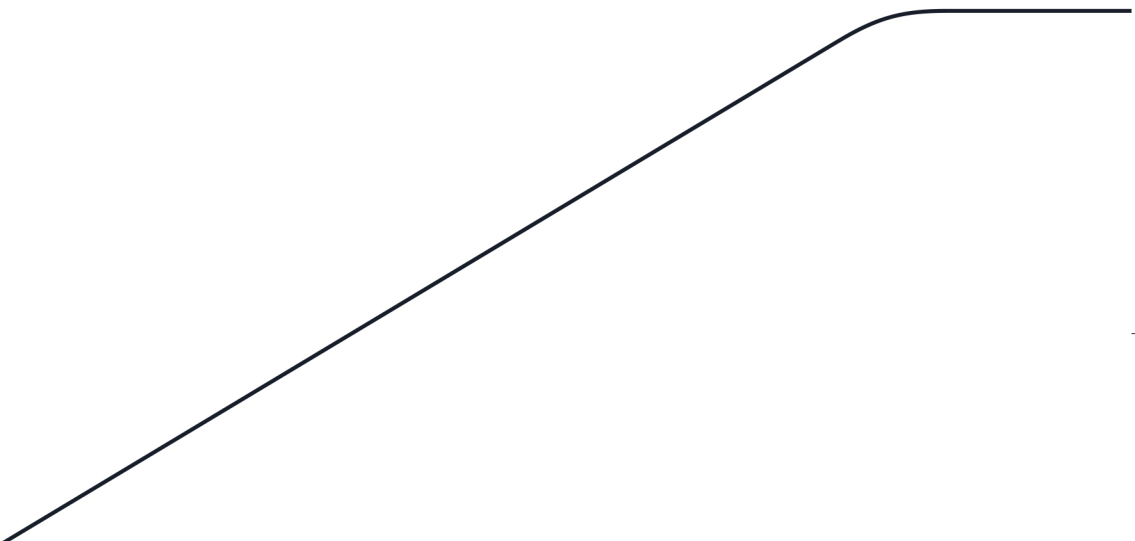

Movement that inspires



**WARNING - California
Proposition 65**

“Operating, servicing and maintaining a passenger vehicle or off-road vehicle can expose you to chemicals including engine exhaust, carbon monoxide, phthalates, and lead, which are known to the State of California to cause cancer and birth defects or other reproductive harm. To minimize exposure, avoid breathing exhaust, do not idle the engine except as necessary, service your vehicle in a well-ventilated area and wear gloves or wash your hands frequently when servicing your vehicle. For more information go to www.P65Warnings.ca.gov/passenger-vehicle.”

FOREWORD

Dear Customer,

Thank you for selecting your new Kia vehicle.

As a global car manufacturer focused on building high-quality vehicles with exceptional value, Kia is dedicated to providing you with a customer service experience that exceeds your expectations.

This Owner's Manual is valid for all variants of your model, and describes all options, features, and equipment available, along with the maintenance needs. This manual may also describe optional equipment not purchased on your vehicle, country specifications, and functions and features not available in your region. Please always keep this manual in the vehicle for your and any subsequent owner's reference.

Authorized Kia Dealerships provide factory-trained technicians, utilize recommended special service tools and supply genuine Kia replacement parts to help you maintain and service your Kia during your ownership.

All information contained in this Owner's Manual was accurate at the time of publication. As Kia continues to make improvements to its products, the company reserves the right to make changes to this manual or any of its vehicles at any time without notice and without incurring any obligations.

Please drive safely and enjoy your Kia vehicle!

© 2025 Kia America, Inc.

All rights reserved. May not be reproduced or translated in whole or in part without the written consent of Kia America, Inc.

Printed in Korea

How to use this manual

We want to help you get the greatest possible driving pleasure from your Kia. Your Owner's Manual can assist you in many ways.

We strongly recommend that you read the entire manual. To minimize the chance of death or injury, you must read the DANGER, WARNING and CAUTION sections in the manual.

Illustrations complement the words in this manual to best explain how to enjoy your Kia. By reading your manual, you learn about features, important safety information and driving tips under various road conditions.

The general layout of the manual is provided in the Table of Contents. Use the index when looking for a specific area or subject, it has an alphabetical listing of all information in your manual.

You will find various DANGERS, WARNINGS, CAUTIONS, NOTICES, INFORMATIONS in this manual. These WARNINGS were prepared to enhance your personal safety. You should carefully read and follow ALL procedures and recommendations provided in these DANGERS, WARNINGS, CAUTIONS, NOTICES and INFORMATIONS.

DANGER

A DANGER indicates a hazardous situation which, if not avoided, will result in death or serious injury.

WARNING

A WARNING indicates a hazardous situation which, if not avoided, may result in death or serious injury.

CAUTION

A CAUTION indicates a hazardous situation which, if not avoided, could result in minor or moderate injury.

NOTICE

A NOTICE indicates interesting or helpful information is being provided.

INFORMATION

This is a vehicle term or information display that requires additional explanation.

Table of Contents

Hybrid system overview	①
Introduction	②
Your vehicle at a glance	③
Safety features of your Kia	④
Features of your vehicle	⑤
Driving your vehicle	⑥
Driver assistance system	⑦
What to do in an emergency	⑧
Maintenance	⑨
Specifications, Consumer information and Reporting safety defects	⑩
Abbreviation	Ⓐ
Index	Ⓘ

Hybrid system overview

1

PHEV (Plug-in Hybrid Electric Vehicle) system	1-2
HEV (Hybrid Electric Vehicle) system.....	1-3
Charging the plug-in hybrid vehicle	1-4
• Charging information.....	1-4
• Charging time.....	1-4
• Charging types.....	1-5
• Charging status.....	1-6
• AC charging connector lock.....	1-7
• Scheduled charging.....	1-7
• Charging precautions.....	1-8
• AC charger.....	1-10
• Trickle charger (portable charging cable) (Type A).....	1-12
• Trickle charger (portable charging cable) (Type B).....	1-17
• Actions to be taken for electric vehicle charging issues.....	1-23
• How to disconnect charging connector in emergency.....	1-24
Driving the hybrid/plug-in hybrid vehicle	1-24
• Starting the vehicle.....	1-24
• Changing plug-in hybrid mode (Plug-in hybrid vehicle).....	1-25
• Special features	1-25
• Hybrid system gauge.....	1-27
• Warning and indicator lights.....	1-28
• LCD display messages.....	1-28
• Energy flow.....	1-35
Hybrid Driving System.....	1-38
• e-Handling (Electrically Assisted Handling Performance)/e-EHA (Electrically Evasive Handling Assist) (for hybrid vehicle).....	1-38
Components of the hybrid/plug-in hybrid vehicle	1-39
• Hybrid vehicle components.....	1-41
• Service interlock connector	1-43
• If an accident occurs.....	1-44
• When the hybrid vehicle shuts off.....	1-44

Hybrid system overview

PHEV (Plug-in Hybrid Electric Vehicle) system

The Kia Plug-in Hybrid Electric Vehicle (PHEV) shares the characteristics of both a conventional hybrid electric vehicle and an all-electric vehicle.

When used as a conventional hybrid electric vehicle, the HEV computer selectively operates between the engine and the electric motor or even both at the same time.

When it is operating in the electric vehicle mode, the vehicle is driven only using the electric motor over a certain distance until the hybrid battery becomes low. The driving distance in EV mode depends on customer driving style and road conditions.

Aggressive driving maneuvers may at times temporarily enable the engine to operate.

The engine power could be limited during emission reduction control period at cold engine condition.

The hybrid battery can be fully charged by connecting a plug to an external electric power source.

An engine can be turned on due to factors such as heater and a frequent operation of the accelerator pedal by a driver in Charge Depleting (CD) mode.

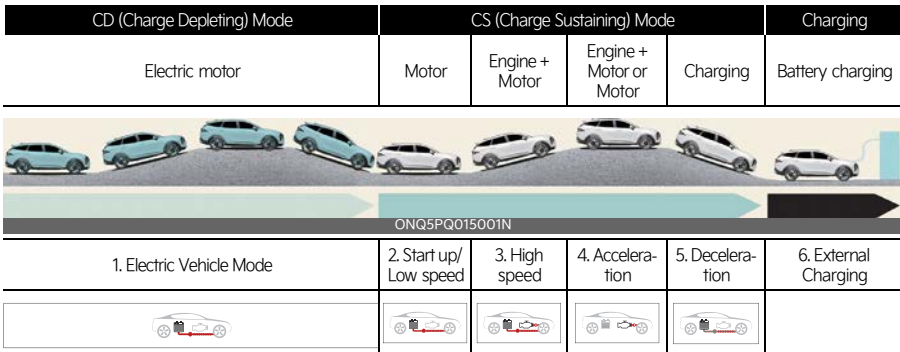

HEV (Hybrid Electric Vehicle) system

The Kia Hybrid Electric Vehicle (HEV) uses both the gasoline engine and the electric motor for power. The electric motor is run by a high-voltage HEV battery.

Depending on the driving conditions, the HEV computer selectively operates between the engine and the electric motor or even both at the same time.

Fuel efficiency increases when the vehicle is driven by the electric motor with the HEV battery.

The HEV battery charge must be maintained, so at times the engine will come on even at idle to act as a generator. Charging also occurs when decelerating or by regenerative braking.

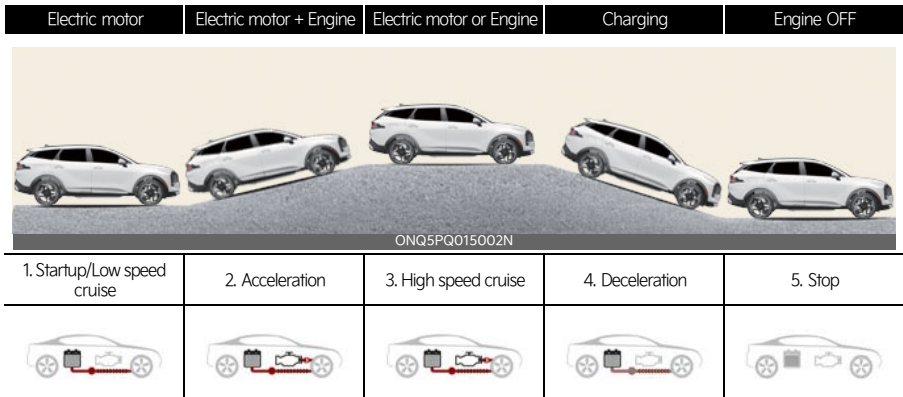

Charging the plug-in hybrid vehicle

Charging information





- AC Charger: The plug-in hybrid vehicle is charged by plugging into an AC charger installed in your home or a public charging station. (For further details, refer to "AC charger" on page 1-10.)
- Trickle Charger: The plug-in hybrid vehicle can be charged by using household electricity.

The electrical outlet in your home must comply with regulations and can safely accommodate the Voltage/Current (Amps)/Power (Watts) ratings specified on the trickle charge. Use only as a backup charger.

Charging time

- AC Charger: Takes about 2 hours at room temperature for SOC 15~100%.
Depending on the temperature and durability of the high-voltage battery, charger specifications, the time required for charging the high-voltage battery may vary.
- Trickle Charger: For charging at home. Please note that the Trickle Charger is slower than the AC Charger.

Charging types

Category	Charging Inlet (Vehicle)	Charging Connector	Charging Method	Charging Time
AC Charger	 ONQ5PQ015007N	 OCVQ011060	AC charger installed in homes or public charging stations	Approximately 2 hours (SOC 15~100%)
Trickle Charger	 ONQ5PQ015007N	 OCVQ011060	Household current	For charging at home. Please note that the Trickle Charger is slower than the AC Charger

- Depending on the condition and durability of the high voltage battery, charger specifications, and ambient temperature, the time required for charging the high voltage battery may vary.
- Actual charging method may vary in accordance with the charger manufacturer.

* INFORMATION

Type 3R enclosure satisfies the requirements of UL 50E standard when the charging connector is connected to the vehicle side charging inlet. An additional Type 3R enclosure should be provided in the end installation of the vehicle side charging inlet. The "Type 3R" marking can be found on the charging inlet.

* What is type 3R?: Performance requirement for enclosures intended for outdoor use that provides a degree of protection against falling dirt, rain, sleet, and/or snow.

⚠ CAUTION

- Risk of Electric Shock, Do Not Disconnect Under Load.
- Suitable For Use On A Circuit Capable Of Delivering Not More Than 5000 rms Symmetrical Amperes, 250 Volts Maximum.

Charging status



You can check the charging status at the outside of vehicle when charging or using (it is not driving status) the high-voltage battery.

It takes about 2-3 hours or more to complete charging.

Classification		Details	Operation of charging indicator lamp		
Mode	Status		Charging inlet	Charging button	
A	READY	Non-charging state	0-65%	On (Yellow)	Off
			65-100%	On (Green)	Off
B	Aux. Battery Saver/High voltage warning	Charging the 12 V auxiliary battery / High voltage warning state	On (Red)	Off	
C	Charging	Charging	0-65%	Blinking (Yellow)	Off
			65-100%	Blinking (Green)	Off
D	Charging complete	Charging completed (turns off in 5 seconds)	100%	On (Green) > OFF	Off
E	Charging failed	Error while charging	Blinking (Red)	Off	
F	Scheduled charging standby	Reserved charging is operating (turns OFF after 3 minutes)	Off	On	
G	Error	CAN communication error status	On (Green) > On (Orange) > On (Red)	Off	

Checking charging status



You can check the charging status at the outside of vehicle when charging or using (it is not driving status) the high-voltage battery.

It takes about 2-3 hours or more to complete charging.

For more information about charging status indicator, refer to "Charging status" on page 1-6.

AC charging connector lock

This AC charging connector lock function prevents an outsider from removing the charging connector from the charging inlet.

Connector lock

	Always lock	Lock while charging	Do not lock Mode
Before charging	○	×	×
While charging	○	○	×
After charging	○	×	×

Always lock

The connector locks when the charging connector is plugged into the charging inlet. The connector is locked until all doors are unlocked by the driver. This mode can be used to prevent charging cable theft.

- If the charging connector is unlocked when all doors are unlocked, but the

charging cable is not disconnected within 15 seconds, the connector will be automatically locked again.

- If the charging connector is unlocked when all doors are unlocked, but all doors are locked again, immediately, the connector will be automatically locked again.

Lock while charging

The connector locks when charging starts. The connector unlocks when charging is complete.



Do not lock

The locking device for charging inlet is kept unlocked regardless of charging status. The locking device is kept unlocked during charging and you can separate the connector by pressing the button of the charging connector. Please be careful about potential theft of the charging cable when selecting this mode.

Scheduled charging

- You can set reserved charging using the infotainment system. Refer to the infotainment system for detailed information about setting reserved charging.
- Scheduled charging can only be done when using an AC charger or the portable charging cable (ICCB: In-Cable Control Box).
- When scheduled charging is set and the AC charger or the portable charging cable (ICCB: In-Cable Control Box) is connected for charging, the scheduled charge release button is illuminated (for 3 minutes) to indicate that scheduled charging is set.



- When scheduled charging is set, charging is not initiated immediately when the AC charger or portable charging cable (ICCB: In-Cable Control Box) is connected.
- If charging is required immediately, turn off the scheduled charge using the infotainment system or press the vehicle's scheduled charge release button () more than 2 seconds.
- When the scheduled charge is set, the charge start time is calculated by itself. In some cases, charging may start immediately after connecting the charger.
- If you press the scheduled charging deactivation () button to immediately charge the battery, charging must be initiated 3 minutes after the charging cable has been connected.



When you press the scheduled charging deactivation () button for immediate charging, the scheduled charge setting is not completely deactivated. If you need to completely deactivate the scheduled charge set-

ting, use the infotainment system to finalize the deactivation. Refer to "AC charger" on page 1-10 or "Trickle charger (portable charging cable) (Type A)" on page 1-12 for details about connecting the AC charger and the portable charger (ICCB: In-Cable Control Box).

Charging precautions

WARNING

Fires caused by dust or water

Do not connect the charging cable connector plug to the vehicle if there is water or dust on the charging inlet. Connecting while there is water or dust on the charging cable connector and plug may cause a fire or electric shock. There may be a risk of fire and injury when using old worn out public electrical outlets.

WARNING

Old or Worn out Electric Outlets

Do not use old or worn out electric outlets to charge your vehicle. There may be a risk of fire and injury when using old worn out public electrical outlets.

WARNING

Interference with electronic medical devices

When using medical electric devices such as an implantable cardiac pacemaker, make sure to ask the medical team and manufacturer whether charging your electric vehicle will impact the operation of the medical devices. In some instances, electromagnetic waves that are generated from the charger can seriously impact medical electric devices

such as an implantable cardiac pace-maker.

⚠ WARNING

Touching the charging connector

Do not touch the charging connector, charging plug, and the charging inlet when connecting the cable to the charger and the charging inlet on the vehicle. Doing so may result in electrocution.

- Comply with the following to prevent electrical shock when charging:
 - Use a waterproof charger
 - Make sure to not touch the charging connector and charging plug when your hand is wet
 - Do not charge when there is lightning
 - Do not charge when the charging connector and plug is wet

⚠ WARNING

Charging cable

- Immediately stop charging when you find abnormal symptoms. (smell, smoke, etc.)
- Replace the charging cable if the cable coating is damaged to prevent electrical shock.
- When connecting or removing the charging cable, make sure to hold the charging connector handle and charging plug.

If you pull the cable itself (without using the handle), the internal wires may disconnect or get damaged. This may lead to electric shock or fire.

⚠ WARNING

Cooling fan

Do not touch the cooling fan while vehicle is charging. When the vehicle is switched OFF while charging, the cooling fan inside the motor compartment may automatically operate.

⚠ WARNING

Make sure to use the designated charger for charging the vehicle. Using any other charger may cause failure or lead to electric shock or fire.

- Always keep the charging connector and charging plug in clean and dry condition. Be sure to keep the charging cable in a condition where there is no water or moisture.
- Make sure to use the designated charger for charging the vehicle. Using any other charger may cause failure.
- Before change battery to vehicle, turn the vehicle OFF.
- Be careful not to drop the charging connector. The charging connector can be damaged.
- Always inspect the charging connector terminals for damage or overheating. Do not use if damaged, as this may damage the vehicle side charge connector and is not a warrantable repair.

AC charger

AC charger cable



You can charge your vehicle by plugging into a public charger at a charging station.

How to connect AC charger



1. Depress the brake pedal and apply the parking brake.
2. Turn OFF all switches, move the shift dial to P (Park), and turn OFF the vehicle.
3. Open the charging door by pressing rear center edge of the charging door.
4. Remove any dust on the charging connector and charging inlet.
5. Hold the charging connector handle.



Then, insert the charger into the charging inlet, until you hear a click sound. If it is not fully connected, a bad connection between the charging connector and the charging terminals may cause a fire.

6. Check if the charging cable connection indicator (S⁺) of the high voltage battery in the instrument cluster is turned ON.

Charging does not occur when the indicator is OFF. When the charging connector is not connected properly, reconnect the charging cable to charge.

* NOTICE

- If the charging connector and charging inlet are not connected properly, the connector may droop or vibrate. In this case, hold the charging connector handle and push it all the way in.
- Only charge the vehicle when the vehicle's shift dial is in P (Park) and the ENGINE START/STOP button is in the OFF position. While the vehicle could be charged with the ENGINE START/STOP button in the ACC position is possible, it may discharge the 12 V battery.
- Moving the shift dial from P (Park) to R (Reverse)/N (Neutral)/D (Drive) stops the charging process. To restart the charging process, move the shift dial to P (Park), press the ENGINE START/STOP button to the OFF position, and disconnect the charging cable. Then, connect the charging cable.

Charging connector lock mode

When the charging connector is plugged into the charging inlet, the connector lock timing varies with the modes selected by the user settings menu or the infotainment screen menu.

- Always lock: The connector locks when the charging connector is plugged into the charging inlet.
- Lock while charging: The connector locks when charging starts. The connector unlocks when charging is completed.
- Do not lock: The locking device for charging inlet is kept unlocked regardless of charging status.

For more details, refer to "AC charging connector lock" on page 1-7.

How to disconnect AC charger

1. The vehicle doors must be unlocked in order to be able to disconnect the charging connector. A lock system prevents charger cable disconnection when the vehicle's doors are locked.

* NOTICE

In order to disconnect the charging connector, unlock the doors to unlatch the charging connector lock system. If not, the charging connector and the vehicle's charging inlet may be damaged.

2. Hold the charging connector handle and pull it out.



To prevent charging cable theft, the charging connector cannot be discon-

nected from the inlet when the doors are locked.

However, if the vehicle is in the charging connector AUTO mode, the charging connector automatically unlocks from the inlet when charging is completed.

If the connector is not automatically unlocked after charging is completed in AUTO mode, the connector is unlocked when all the doors are unlocked.

For more details, refer to "AC charging connector lock" on page 1-7.

* NOTICE

When disconnecting the charging connector, do not try to disconnect it by force while not pressing the release button. This may damage the charging connector and vehicle charging inlet.

3. Close the charging door by pressing the rear center edge of the charging door.



- * The charging door does not have a locking system.

⚠ WARNING

Do not modify or disassemble the charging cable components. It may cause a fire or an electric shock with personal injury.

*** NOTICE**

- If you cannot open the charging door due to freezing weather, tap lightly or remove any ice near the charging door. Do not try to forcibly open the charging door. If you open it by force, the charging door may be damaged.
- Keep the charging connector and the charging plug clean and dry. The charging cable should be also kept dry.
- Use an air gun to blow any foreign substances from the charging connector and the charging plug.

Trickle charger (portable charging cable) (Type A)



Trickle charger can be used if AC Charger is unavailable.

- 1 Control box (ICCB)
- 2 Plug and cable
- 3 Charging connector/cable

How to connect portable charger (ICCB: In-Cable Control Box)

1. Turn OFF all switches, move the shift dial to P (Park), and turn OFF the vehicle.
2. Connect the plug to a household electric outlet.



3. Check if the power lamp (green) illuminates on the control box.



4. Depress the brake pedal and apply the parking brake.
5. Turn OFF all switches, shift to P (Park), and turn OFF the vehicle. If charging is initiated without the gear in P (Park), the charging will start after the gear is automatically shifted to P (Park).
6. Open the charging door.
For more details, refer to "Fuel filler door" on page 5-50.
7. Open the protection caps of the charging connector and the charging plug. Check if there are any foreign substances or dust.
8. Hold the charging connector handle and connect it to the vehicle charging inlet. Push the connector all the way in. If the charging connector and

charging terminal are not connected properly, this may cause a fire.

*** NOTICE**

If the charging connector and charging inlet are not connected properly, the connector may droop or vibrate. In this case, hold the charging connector handle and push it all the way in.

9. Charging starts automatically (charging lamp illuminates).



10. Check if the charging indicator light (⚡) of the high voltage battery in the instrument cluster is turned ON. Charging is not active when the charging indicator light (⚡) is OFF. When the charging connector is not connected properly, reconnect the charging cable to charge it again.

11. After charging has started, the estimated charging time is displayed on the instrument cluster for about 1 minute.

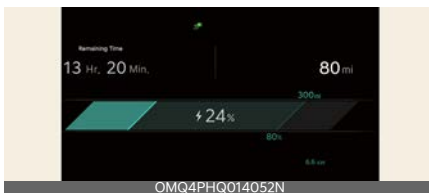

If you open the driver seat door while charging, the estimated charging time is also displayed on the instrument cluster for about 1 minute. When scheduled charging or scheduled air conditioner/heater is set, the esti-

ated charging time is displayed as "-".

Charging cable storage



We recommend that the trickle charger cable should be put in the storage box after use.

Charging status indicator lamp for portable charger



Indicator		Details
POWER		On: Power on
CHARGE		On: Charging Blink: Current limit due to high plug temperature or high internal temperature
FAULT		Blink: Charging interrupted
CHARGE LEVEL	12	12 A
	10	10 A
	08	8 A
	06	6 A
	<p>The charging current changes each time the button (1) is pressed, in the following sequence: 6 A → 8 A → 10 A → 12 A.</p> <p>If the button (1) is not pressed for 10 seconds, the indicator will stop blinking and the selected charging current will be confirmed.</p>	
<p>Control box</p>		

Status/Diagnosis/Countermeasure



- Charging connector plugged into vehicle (**POWER** Green ON)
- Plug connected to an electric outlet (**POWER** Green ON)

While charging



- Charge indicator (**POWER** Green ON/**CHARGE** Blue ON)
- Charging current

Before plugging charging connector into vehicle (**POWER** Green ON, **FAULT** Red blink)



- Abnormal temperature
- ICCB (In-Cable Control Box) failure

Plugged into vehicle (**POWER** Green ON, **FAULT** Red Blink)



- Diagnostic device failure
- Current leakage
- Abnormal temperature

Leakage current failure (**POWER** Green ON, **FAULT** Red Blink)



- After disconnecting and reconnecting the power plug, press and release the button for 2 seconds or longer to clear the error.

Power saving mode



- Charge level indicator is turned off if there is no status change for more than 1 minute.

How to disconnect portable charging cable (ICCB: In-Cable Control Box)

1. Before disconnecting the charging connector, make sure the doors are unlocked. When the door is locked, the charging connector lock system will not allow disconnection. To prevent charging cable theft, the charging connector cannot be disconnected from the inlet when the doors are locked. However, if the vehicle is in the charging connector AUTO mode, the charging connector automatically unlocks from the inlet when charging is completed.

* NOTICE

In order to disconnect the charging connector, unlock the doors to unlatch the charging connector lock system. If not, the charging connector and the vehicle's charging inlet may be damaged.

2. Hold the charging connector handle and pull it out.



3. Make sure to securely close the charging door.

4. Disconnect the plug from the household electric outlet. Do not pull the cable when disconnecting the plug.



5. Close the protective cover for the charging connector so that foreign material cannot get into the terminal.
6. Put the charging cable inside the cable compartment to protect it.

Precautions for portable charging cable (ICCB: In-Cable Control Box)

- Use the portable charging cable that is certified by Kia.
- Do not try to repair, disassemble, or adjust the portable charging cable.
- Do not use an extension cord or adapter.
- Stop using immediately if failure warning light occurs.
- Do not touch the plug and charging connector with wet hands.
- Do not touch the terminal part of the AC charging connector and the AC charging inlet on the vehicle.
- Do not connect the charging connector to voltage that does not comply with regulations.
- Do not use the portable charging cable if it is worn out, exposed, or there exists any type of damage on the portable charging cable.
- If the ICCB case and AC charging connector is damaged, cracked, or the wires are exposed in any way, do not use the portable charging cable.

- Do not let children operate or touch the portable charging cable.
- Keep the control box free of water.
- Keep the AC charging connector or plug terminal free of foreign substances.
- Do not step on the cable or cord. Do not pull the cable or cord and do not twist or bend it.
- Do not charge when there is lightning.
- Do not drop the control box or place a heavy object on the control box.
- Do not place an object that can generate high temperatures near the charger when charging.
- Charging with the worn out or damaged household electric outlet can result in a risk of electric shock. If you are in doubt to the household electric outlet condition, have it checked by a licensed electrician.
- Stop using the portable charging cable immediately if the household electric outlet or any components is overheated or you notice burnt odors.

Trickle charger (portable charging cable) (Type B)



Trickle charger can be used if AC Charger is unavailable.

- 1 Charging Connector
- 2 Cable
- 3 Control Box (ICCB)
- 4 Display
- 5 Detachable Connector (5-15P)





6 Detachable Connector (14-50P)

Description	Specifications
Voltage	120 V / 240 V AC single-phase
Maximum Current	12A MAX / 30A MAX with different input cord set.
Frequency	60 Hz
Cable Length	20 ft(6.1 m)
Weight	9.0 lbs(4.1 kg)
Operating Temperature	-40 °F to +122 °F(-40 °C to +50 °C).
Enclosure Type	Type 6 (IP67)
Ventilation	Not Required

Charging status indicator lamp for portable charger

Control Box



Indicator	Details
POWER	 <p>On: Power on</p>
CHARGE	 <p>On: Charge Blink: Current limit due to high plug temperature or high Internal temperature</p>
FAULT	 <p>Blink: Charging interrupt</p>
CURRENT	 <p>Display setting current or trouble shoot code</p>

Indicator	Details	
	30	30 A
	24	24 A
	20	20 A
	16	16 A
	12	12 A
	10	10 A
	08	8 A
	06	6 A

CHARGE LEVEL

The charging current changes each time the button (1) is pressed, in the following sequence:

- Detachable Connector (14-50P)
 - 16 A → 20 A → 24 A → 30 A
- Detachable Connector (5-15P)
 - 6 A → 8 A → 10 A → 12 A

Control box



How to connect detachable connector

Connect the detachable connector to control box controller socket.

Check the arrow on the top of the connector is no longer visible.



The power lamp (green) illuminates when the ICCB is powered on.

* NOTICE

If "NC" is displayed on the ICCB display panel or if the arrow is still visible reconnect the detachable connector properly.



Trouble shooting status indicator lamp

Indicator	Details		
	Error code	item	cause
	On : Error while charging / Error during self-diagnosis		
	E1	Control pilot communication	Vehicle communication error
	E2	leakage	Current leakage
	E3		Charger error
	E4	Plug temperature	Plug overtemperature warning
	E5		Plug temperature failure
	E6		Charger error
	E7	Overcurrent	Charging overcurrent warning
	E8	Internal temperature	Charger overheating
	E9		Charger error
	F1	Relay fusion	Charger error
	F2	Ground Monitoring / interrupt	Poor grounding of outlet
	A5		Charger error
	F3	Switched mode power supply power failure	Switched mode power supply error (voltage failure)
	F4		Switched mode power supply error (abnormal voltage)
	F5	Control Pilot voltage error	Control Pilot(-) voltage error
	F6		Control Pilot(+) voltage error
	F7	Temperature sensor error	Plug temperature sensor error
	F8		PCB Internal temperature sensor error
	F9		Detachable plug temperature sensor error
	A1	Detachable plug temperature	Detachable plug overtemperature warning
	A2		Charger error
	A3	Detachable plug state	Charger error
	A4		Detachable plug search error
FF	Control box state	Charger error	

How to connect portable charger (ICCB: In-Cable Control Box)

1. Turn OFF all switches, move the shift dial to P (Park), and turn OFF the vehicle.
2. Connect the plug to a household electric outlet.



3. Check if the power lamp (green) illuminates on the control box.



4. Depress the brake pedal and apply the parking brake.
5. Turn OFF all switches, shift to P (Park), and turn OFF the vehicle. If charging is initiated without the gear in P (Park), the charging will start after the gear is automatically shifted to P (Park).
6. Open the charging door.
For more details, refer to "Fuel filler door" on page 5-50.
7. Open the protection caps of the charging connector and the charging plug. Check if there are any foreign substances or dust.
8. Hold the charging connector handle and connect it to the vehicle charging inlet. Push the connector all the way in. If the charging connector and

charging terminal are not connected properly, this may cause a fire.

* NOTICE

If the charging connector and charging inlet are not connected properly, the connector may droop or vibrate. In this case, hold the charging connector handle and push it all the way in.

9. Charging starts automatically (charging lamp illuminates).



10. Check if the charging indicator light (S) of the high voltage battery in the instrument cluster is turned ON. Charging is not active when the charging indicator light (S) is OFF. When the charging connector is not connected properly, reconnect the charging cable to charge it again.
11. After charging has started, the estimated charging time is displayed on the instrument cluster for about 1 minute.

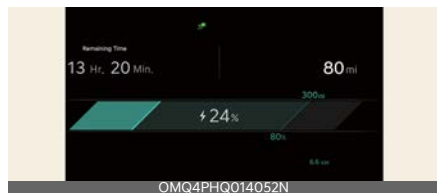

If you open the driver seat door while charging, the estimated charging time is also displayed on the instrument cluster for about 1 minute. When scheduled charging or scheduled air conditioner/heater is set, the esti-

mated charging time is displayed as "-".

Charging cable storage



We recommend that the trickle charger cable should be put in the storage box after use.

How to disconnect portable charging cable (ICCB: In-Cable Control Box)

1. Before disconnecting the charging connector, make sure the doors are unlocked. When the door is locked, the charging connector lock system will not allow disconnection. To prevent charging cable theft, the charging connector cannot be disconnected from the inlet when the doors are locked. However, if the vehicle is in the charging connector AUTO mode, the charging connector automatically unlocks from the inlet when charging is completed.

* NOTICE

In order to disconnect the charging connector, unlock the doors to unlatch the charging connector lock system. If not, the charging connector and the vehicle's charging inlet may be damaged.

2. Hold the charging connector handle and pull it out.



3. Make sure to securely close the charging door.
4. Disconnect the plug from the household electric outlet. Do not pull the cable when disconnecting the plug.



5. Close the protective cover for the charging connector so that foreign material cannot get into the terminal.
6. Put the charging cable inside the cable compartment to protect it.

Precautions for portable charging cable (ICCB: In-Cable Control Box)

* NOTICE

- If the charger is worn out, exposed, or there exists any type of damage, charging may stop for your safety. Use another charger that works normally.
- The charger operates from a 240V 30A MAX / 120V 12A MAX with different input cord set.
- If you use an unauthorized portable charger (ICCB), this may disable charging due to compatibility issues.
- This product must be grounded

- For use with Electric Vehicles.
- Ventilation not Required.
- This device is intended only for charging vehicles not requiring ventilation during charging.
- Be sure to use the dedicated plug, and ensure it is fully secured when using a detachable plug.
- Do not use this with an extension cord.
- Do not use extension cords, Multi-Outlets, Splitters, Ground Adapters, Surge Protectors, or similar components.
- When connecting the detachable connector ICCB, connect it in the forward direction.
- Do not disconnect the detachable connector ICCB while charging.
- When storing the plug and cable separately, keep it safe from water, liquids, moisture, or snow.
- Charging with the worn out or damaged household electric outlet can result in a risk of electric shock. If you are in doubt to the household electric outlet condition, have it checked by a licensed electrician.
- Do not plug in with several electronic products in multiple outlets together.
- Do not modify or disassemble the provided plug.
- Do not use the product, if the charging plug is damaged, cracked, broken or otherwise damaged.
- Using a charging current exceeding the electrical outlet capacity may cause fire or damage to the components. If the outlet capacity is unknown, use the lowest charge level.
- Disconnect the charging connector from the vehicle first before unplugging it from the wall outlet.
- Do not connect to another outlet than the rated voltage.
- Do not disconnect the portable charger from the wall outlet when the vehicle is charging.
- Do not connect the portable charger into a power outlet that is not properly grounded.
- Do not touch the terminal part of the AC charging connector and the AC charging inlet on the vehicle.
- Do not charge when there is lightning.
- Do not place an object that can generate high temperatures near the charger when charging.

CAUTION

- Be careful not to throw or inadvertently impact the internal parts as they may be damaged.
- Be careful not to drop this device on the ground while charging.
- Varied with different input cord set.
- Untie the charging cable before use.
- If the ICCB case and AC charging connector is damaged, cracked, or the wires are exposed in any way, do not use the portable charging cable.
- Stop using the portable charging cable immediately if the household electric outlet or any components is overheated.
- Stop using immediately if failure warning light occurs.
- Do not drop the control box or place a heavy object on the control box.

To prevent property damage or injury due to fire or explosion, follow the instructions below.

- Risk of electric shock. Do not disconnect under load.
- The electrical outlet at home must comply with regulations and safely accommodate the voltage, current (amps), and power (watts) ratings specified on the portable charger. If not, the vehicle may not be charged or safety hazards, such as fire, may occur.
- If the power distributor exceeds its capacity while charging the vehicle with a portable charger at home, the power to home may be cut off or a fire may occur.
- If you charge the vehicle with household electricity, you are charged electricity bill according to the home rate system, not the electric vehicle rate system.
- Only use a genuine Kia portable charger. If not, the vehicle may not be charged.
- Do not let children operate or touch the portable charger. Doing so may lead to unexpected accidents.
- Immediately stop charging if you discover abnormal conditions, such as odor or smoke.
- Do not operate the portable charger in temperatures outside its operating range of -40 °F to +122 °F (-40 °C to +50 °C).
- Store the mobile connector in a clean dry place in temperatures between -40 °F and +185 °F (-40 °C and +85 °C).
- Do not wrap the charging cable around this device when storing.
- Risk of electric shock.
- Do not try to repair, disassemble, or adjust the portable charging cable.
- A qualified technician should service parts.
- Do not use this product if there is any damage to the unit.
- Connect only to properly grounded outlets.

WARNING

- Do not touch, connect or pull the plug with wet hands, and keep it free of water, liquid, moisture or snow. It may cause electric shock, serious injury or death.
- Do not let children operate or touch the plug.

Actions to be taken for electric vehicle charging issues

When you cannot charge the high voltage battery after connecting the charger, check the following:

1. Check the charging settings for the vehicle.
(e.g. when scheduled charging is set, charging is not initiated immediately when the AC charger or portable charger is connected.)
2. Check the operation status of the AC charger, portable charger.
(Status of portable charger)
* Actual method for indicating the charging status may vary in accordance with the charger manufacturer.
3. When the vehicle does not charge and a warning message appears on the instrument cluster, check the corresponding message.
4. If the vehicle is properly charged when charged with another normally

working charger, contact the charger manufacturer.

5. If the vehicle does not charge when charged with another normally working charger, have your vehicle inspected by an authorized Kia dealer.

How to disconnect charging connector in emergency

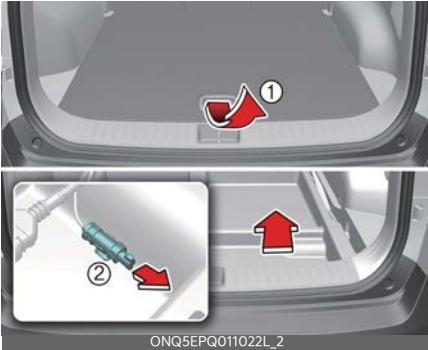

If the charging connector does not disconnect due to battery discharge and/or failure of the electric system, open the luggage board (1), remove the storage box and slightly pull the emergency cable (2). The charging connector will then disconnect.

Driving the hybrid/plug-in hybrid vehicle

Starting the vehicle

Vehicles with smart key system

1. Carry the smart key or leave it inside the vehicle.
2. Make sure the parking brake is firmly applied.
3. Place the shift dial in P (Park). With the shift dial in N (Neutral), you cannot start the vehicle.
4. Depress the brake pedal.
5. Press the ENGINE START/STOP button. If the hybrid system starts, the **READY** indicator will come on.

Whether the engine is cold or warm, it should be started without depressing the accelerator.

After following the start procedures, READY indicator on the instrument cluster will turn on. For more details, please refer to "Starting the vehicle" on page 1-24.

Economical and safe operation of Hybrid system

- Drive smoothly. Accelerate at a moderate rate and maintain a steady cruising speed. Do not make "jackrabbit" starts. Do not race between stoplights.
Avoid heavy traffic whenever possible. Always maintain a safe distance from other vehicles so you can avoid unnecessary braking. This also reduces brake wear out.
- The regenerative brake generates energy when the vehicle decelerates.
- When the hybrid battery power is low, the hybrid system automatically recharges the hybrid battery.

- When the engine is running with the shift dial in N (Neutral), the hybrid system cannot generate electricity. The hybrid battery cannot recharge with the shift dial in N (Neutral).

* NOTICE

In the hybrid system, the engine automatically runs and stops. When the hybrid system operates, the **READY** indicator is illuminated.

In the following situation, the engine may operate automatically.

- When the engine is ready to run.
- When the hybrid battery is being charged.
- Depending on the temperature condition of the hybrid battery.

Changing plug-in hybrid mode (Plug-in hybrid vehicle)

EV/HEV button



Whenever you press the [EV/HEV] button, Plug-in hybrid system drive mode will be changed in sequential as:

Automatic (AUTO) mode - Hybrid (CS) mode - Electric (CD) mode.

Each time the mode is changed a corresponding LED is displayed on the instrument cluster as follows.

Automatic (AUTO) mode

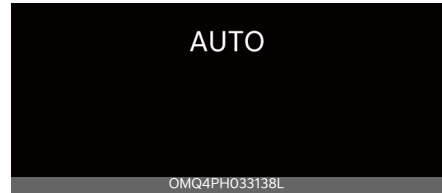

Hybrid (CS) mode

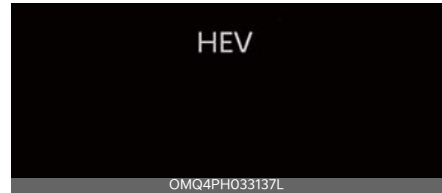

Electric (CD) mode

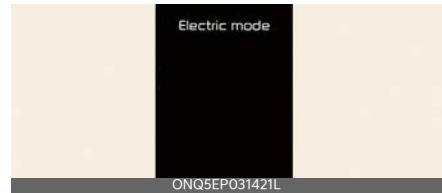

Plug-in hybrid mode indicator

- CD (Charge Depleting, Electric) mode:** The high-voltage (hybrid) battery is used to drive the vehicle.
- AUTO mode:** CD mode and CS mode are selected automatically depending on road conditions.
- CS (Charge Sustaining, Hybrid) mode:** The high-voltage (hybrid) battery and gasoline engine is used to drive the vehicle.

Special features

Hybrid vehicles sound different from gasoline engine vehicles. When the hybrid system operates, you may hear a sound from the hybrid battery system behind the rear seat. If you apply the

accelerator pedal rapidly, you may hear an unconventional sound. When you apply the brake pedal, you may hear a sound from the regenerative brake system. When the hybrid system is turned off or on, you may hear a sound in the engine compartment. If you depress the brake pedal repeatedly when the hybrid system is turned on, you may hear a sound in the engine compartment. None of these sounds indicate a problem. These are normal characteristics of hybrid vehicles.

It is a normal condition if you hear a motor sound in the engine compartment in any of the following situations:

- The brake pedal is released after turning off the hybrid system.
- The brake pedal is applied when the hybrid system is turned off.
- When the driver door is opened.

When the hybrid system is turned ON, the gasoline engine may run or may not. In this situation, you may feel a vibration. This does not indicate a malfunction.

When the **READY** indicator illuminates, the hybrid system is ready to begin driving. Even if the engine is off, you can operate the vehicle as long as the **READY** indicator is illuminated.

* NOTICE

The hybrid system contains many electronic components. High voltage components, such as cables and other parts, may emit electromagnetic waves. Even when the electromagnetic cover blocks electromagnetic emissions, electromagnetic waves may have an effect on electronic devices. When your vehicle is not used for a long period of time, the hybrid system will discharge. You need to drive the vehicle several times a month. We recommend driving at least for 1 hour or

10 miles (16 km). When the hybrid battery is discharged, or when it is impossible to jump start the vehicle, contact your authorized Kia dealer.

When you start the hybrid system with the shift dial in P (Parking), the **READY** indicator illuminates on the instrument cluster. The driver can drive the vehicle, even when the gasoline engine is off.

⚠ WARNING

When you leave the vehicle, you should turn OFF the hybrid system or locate the shift dial in P (Park). When you depress the accelerator pedal by mistake, or when the shift dial is not in P (Park), the vehicle will abruptly move, possibly resulting in serious injury or death.

Virtual Engine Sound System (V ESS)

Virtual Engine Sound System generates engine sound for pedestrians to hear vehicle sound because there is limited sound while motor power is used.

- If the vehicle is moving at low speed, the VESS will operate.
- When the gear is shifted to R (Reverse), an additional warning sound will be heard.

What does regenerative braking do?

It uses an electric motor when decelerating and when braking and transforms kinetic energy to electrical energy in order to charge the high voltage battery.

Battery

- The vehicle is composed of a high voltage battery that drives the motor and air conditioner, and an integrated 12 V lead battery with the HEV battery

that drives the lamps, wipers, and audio system.

- The integrated 12 V battery is automatically charged when the vehicle is in the ready (**READY**) mode.

Hybrid system gauge

Power gauge

Type A

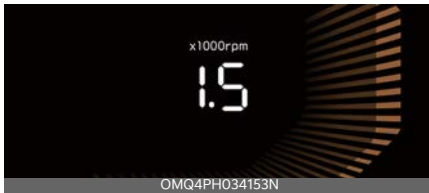

Type B

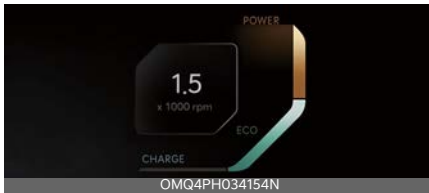

The hybrid system gauge indicates whether the current driving condition is fuel efficient or not.

- **CHARGE:**
Shows that the energy made by the vehicle is being converted to electrical energy. (Regenerated energy)
- **ECO:**
Shows that the vehicle is being driven in an Eco-friendly manner.
- **POWER:**
Shows that the vehicle is exceeding the Eco-friendly range.

Hybrid battery SOC (State of Charge) gauge

Type A

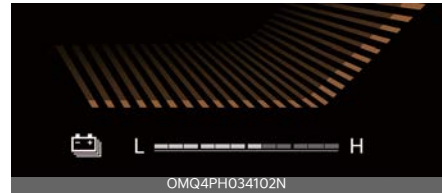

Type B



This gauge indicates the remaining hybrid battery power. If the SOC is near the "L (Low)" level, the vehicle automatically operates the engine to charge the battery.

However, if the Service Indicator (🔧) and Malfunction Indicator Lamp (MIL) (🚗) turn on when the SOC gauge is near the "L (Low)" level, have your vehicle inspected by an authorized Kia dealer.

Warning and indicator lights

Ready indicator READY

This indicator illuminates:

When the vehicle is ready to be driven.

- ON: Normal driving is possible.
- OFF: Normal driving is not possible, or a problem has occurred.
- Blinking: Emergency driving.

When the ready indicator goes OFF or blinks, there is a problem with the system. If this occurs, have your vehicle inspected by an authorized Kia dealer.

Service warning light

This warning light illuminates:

- When you set the ENGINE START/STOP button to the ON position.
 - The service warning light illuminates for approximately 3 seconds and then turns off when all checks have been performed.
- When there is a problem with the hybrid vehicle control system or hardware.

When the warning light illuminates while driving, or does not go OFF after starting the vehicle, have your vehicle inspected by an authorized Kia dealer.

EV mode indicator

This indicator illuminates:

When the vehicle is driven by the electric motor.

- "EV" indicator ON: Vehicle is driven using the electric motor or the gasoline engine is stopped.

- "EV" indicator OFF: Vehicle is driven using the gasoline engine.

Regenerative brake warning light

 (red color)  (yellow color)

This warning light illuminates:

When the regenerative brake does not operate and the brake does not perform well. This causes the brake warning light (red) and regenerative brake warning light (yellow) to illuminate simultaneously.

If this occurs, drive safely and have your vehicle inspected by an authorized Kia dealer. The operation of the brake pedal may be more difficult than normal and the braking distance may increase.

Charging cable connection indicator (Plug-in hybrid vehicle)

This indicator illuminates in red when the charging cable is connected.

LCD display messages

Ready to drive

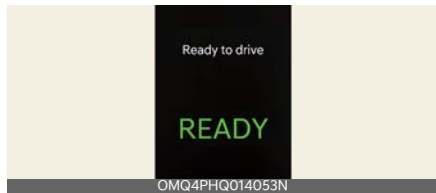

A: Ready to drive

This message is displayed when the vehicle is ready to be driven.

Check regenerative brakes

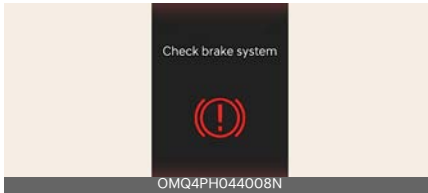

A: Check regenerative brakes

This message is displayed when the brake performance is low or the regenerative brake does not work properly due to a failure in the brake system.

If this occurs, it may take longer for the brake pedal to operate and the braking distance may become longer.

Stop vehicle and check regenerative brakes

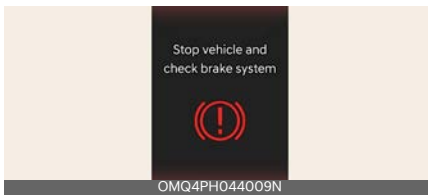

A: Stop vehicle and check regenerative brakes

This message is displayed when a failure occurs in the brake system.

If this occurs, park the vehicle in a safe location tow your vehicle to the nearest authorized Kia dealer and have the vehicle inspected.

Check Hybrid system

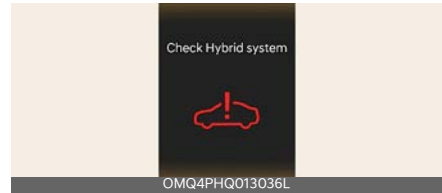

A: Check Hybrid system

This message is displayed when there is a problem with the hybrid control system. Refrain from driving when the warning message is displayed.

If this occurs, have your vehicle inspected by an authorized Kia dealer.

Check Hybrid system. Stop safely

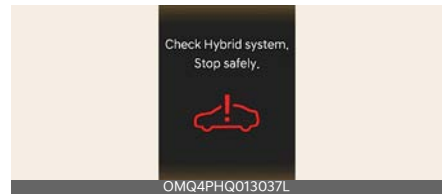

A: Check Hybrid system. Stop safely

This message is displayed when there is a problem with the hybrid control system. The **READY** indicator will blink and a warning chime will sound until the problem is solved. Refrain from driving when the warning message is displayed.

If this occurs, have your vehicle inspected by an authorized Kia dealer.

Check Hybrid system. Do not start engine



A: Check Hybrid system. Stop safely
 This message is displayed when the hybrid battery power (SOC) level is low. A warning chime will sound until the problem is solved. Refrain from driving when the warning message is displayed. If this occurs, park the vehicle in a safe location and tow your vehicle to the nearest authorized Kia dealer and have the vehicle inspected.

Stop vehicle and check power supply

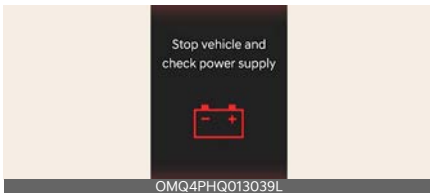

A: Stop vehicle and check power supply
 This message is displayed when a failure occurs in the power supply system. If this occurs, park the vehicle in a safe location and tow your vehicle to the nearest authorized Kia dealer and have the vehicle inspected.

Check Virtual Engine Sound System

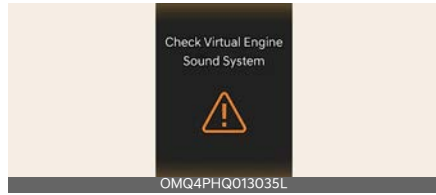

A: Check Virtual Engine Sound System
 This message is displayed when there is a problem with the Virtual Engine Sound System (VESS). If this occurs, have your vehicle inspected by an authorized Kia dealer.

Refill inverter coolant

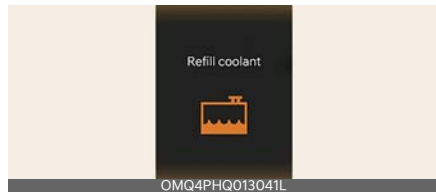

A: Refill inverter coolant
 This message is displayed when the inverter coolant is nearly empty. You should refill the inverter coolant.

Park with engine On to charge battery

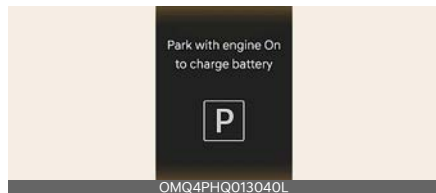

A: Park with engine On to charge battery
 This message is displayed when the hybrid battery power (SOC) level is low.

If this occurs, park the vehicle in a safe location and wait until the hybrid battery is charged.

Start engine to avoid battery discharge

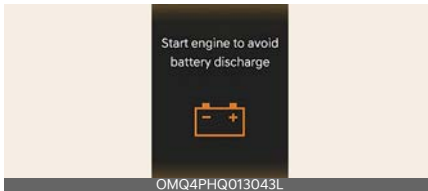

A: Start engine to avoid battery discharge

This message is displayed to inform the driver the 12 V battery may be discharged if the ENGINE START/STOP button is in ON position (without the **READY** indicator ON).

Set the vehicle to the ready (**READY**) mode to prevent the 12 V battery from being discharged.

Coasting guide

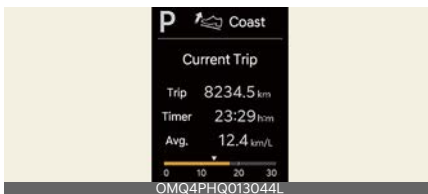

A chime will sound and the coasting guide indicator will be displayed to inform the driver when to take the foot off the accelerator by anticipating a decelerating event* based on the analysis of driving routes and road conditions stored in the navigation system. It encourages the driver to remove the foot from the pedal and allow coasting down the road with EV motor only. This

helps to prevent unnecessary fuel consumption and increases fuel efficiency.

- * Example of a deceleration event is going down an extended hill, slowing down approaching a toll booth, and approaching reduced speed zones.
- User settings
 - Press the ENGINE START/STOP button and put the shift dial in P (Park). In the User Settings Mode, select Driver assistance, Coasting Guide, and then On to turn on the system. Cancel the selection of coasting guide to turn off the system. For the explanation of the system, press and hold the [OK] button.
- Operation conditions
 - To activate the system, take the following procedures. Enter your destination information on the navigation and select the driving route. Select the ECO mode in the Integrated Driving Control System. Then, satisfy the following:
 - The driving speed should be between 19 mph (30 km/h) and 99 mph (160 km/h).
- * The operating speed may vary due to difference between instrument cluster and navigation effected by tire inflation level.

CD (Charge Depleting, Electric) mode (Plug-in hybrid vehicle)

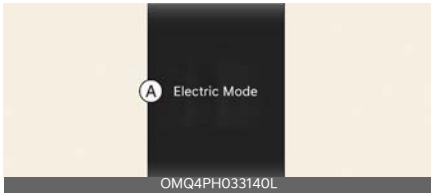

A: Electric mode

The high-voltage (hybrid) battery is used to drive the vehicle.

AUTO (Automatic) mode (Plug-in hybrid vehicle)

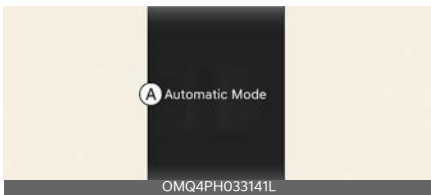

A: Automatic mode

The drive mode will be automatically selected from either Electric (CD) mode or Hybrid (CS) mode by the system according to the driving condition.

CS (Charge Sustaining, Hybrid) mode (Plug-in hybrid vehicle)

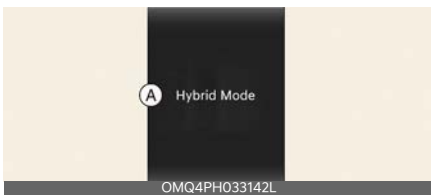

A: Hybrid mode

The high-voltage (hybrid) battery and gasoline engine is used to drive the vehicle.

Remaining charge time (Plug-in hybrid vehicle)

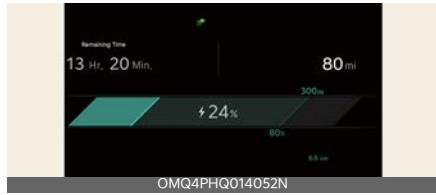

A: Remaining Time

The message is displayed to notify the remaining time to fully charge the battery.

Charging stopped. Check the AC charger (Plug-in hybrid vehicle)

This message is displayed when the charging failed by external charger error.

The purpose of this message is to let you know the error has occurred in the charger itself, not in the vehicle.

Charging stopped. Check the cable connection (Plug-in hybrid vehicle)

This message is displayed when charging is stopped because the charging connector is not correctly connected to the charging inlet. If this occurs, separate the charging connector and re-connect it and check whether there is any problem (external damage, foreign substances, etc.) with the charging connector and charging inlet. If the same problem occurs when charging the vehicle with a replaced charging cable or genuine Kia portable charger, have the vehicle inspected by a professional workshop. Have your vehicle inspected by an authorized Kia dealer.

Low/High System Temp. Maintaining Hybrid mode (Plug-in hybrid vehicle)

This message is displayed when the temperature of the high-voltage (hybrid) battery is too low or too high.

This warning message is to protect the battery and the hybrid system.

Low/High System Temp. Switching to Hybrid mode (Plug-in hybrid vehicle)

This message is displayed when the temperature of the high-voltage (hybrid) battery is too low or high. This warning message is to protect the battery and the hybrid system.

Switching to Hybrid mode to allow heating (Plug-in hybrid vehicle)

- When the outdoor temperature is lower than 5 °F (-15 °C) and the coolant temperature is lower than 158 °F (70 °C), you turn the climate control On for heating, the above message will be displayed in the cluster. Then, the vehicle will automatically switch to HEV mode and EV mode will not be activated (although EV/HEV button is pressed)
- When the outdoor temperature is higher than 14 °F (-10 °C), or the coolant temperature is higher than 176 °F (80 °C) or you turn the climate control Off, the vehicle will automatically return to EV mode.

Wait until fuel door unlocks (Plug-in hybrid vehicle)

The message is displayed when you attempt to unlock the fuel filler door with the fuel tank pressurized. Wait until the fuel tank is depressurized.

* NOTICE

- It may take up to 20 seconds to unlock fuel filler door.
- If the fuel filler door does not open because ice has formed around it, tap lightly or push on the door to break the ice and release the door.
- Do not pry on the door. If necessary, spray around the door with an approved deicer fluid (do not use radiator anti-freeze) or move the vehicle to a warm place and allow the ice to melt.

Fuel door unlocked (Plug-in hybrid vehicle)

This message is displayed when the fuel filler door is unlocked.

Also means "Ready to refuel".

Please press the rear center edge of fuel filler door to open.

Check fuel door (Plug-in hybrid vehicle)

This message is displayed when the fuel filler door is open while driving or an abnormality has occurred.

Charging door open (Plug-in hybrid vehicle)

This message indicates that the charging door is open while in driving ready state to encourage you to inspect and close the door.

(Driving with the charging door open may result in moisture inflow or damage. This message is used to prevent such occurrences.)

Unplug vehicle to start (Plug-in hybrid vehicle)

The message is displayed when you start the engine without unplugging the charging cable. Unplug the charging cable, and then start the vehicle.

Maintaining Hybrid mode to continue heating (Plug-in hybrid vehicle)

A message is displayed when heating is in operation and the HEV mode is maintained to meet the heating operating conditions when attempting to switch to EV mode by pressing the EV/HEV button.

EV/HEV modes (Plug-in hybrid vehicle)

A corresponding message is displayed when a mode is selected by pressing the EV/HEV button.

PHEV infotainment system (Plug-in hybrid vehicle)

Press [PHEV] on the [Home screen].

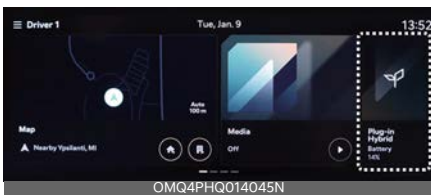

1 PHEV

The Plug-in Hybrid menu consists of five sections: [EV range], [Energy informa-

tion], [Charge management], [ECO driving], [Energy flow].

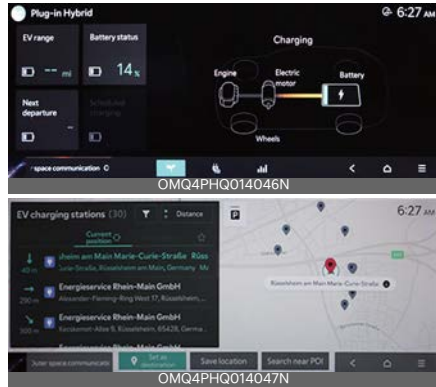

For more information, please refer to the infotainment manual that was separately supplied with your vehicle.

State Of Health

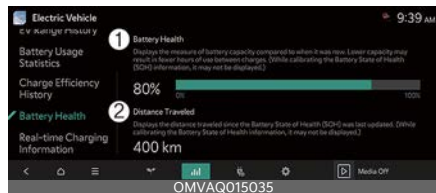

1 Battery Health

2 Distance Traveled

It is an indicator of the energy that the battery can store. The battery's storage energy is set to 100% at the time of shipment, and as the battery continues to be used, it reflects the reduced energy ratio. It indicates the distance driven since the state of health was last calculated.

Real-time charging information

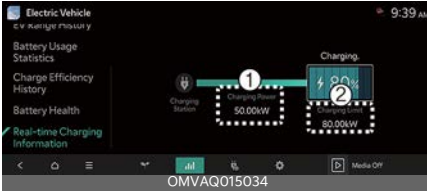

1 Charging Power

2 Charging Limit

When charging, you can monitor the charging power and limit, allowing you to manage the process efficiently and optimize energy usage.

You can check only while charging.

Energy flow

The hybrid system informs the drivers its energy flow in various operating modes. While driving, the current energy flow is specified in 11 modes.

Vehicle stop

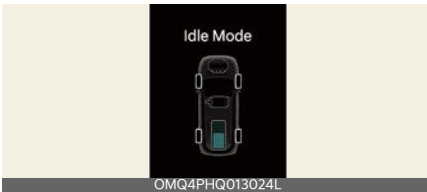

The vehicle is stopped.
(No energy flow)

EV propulsion

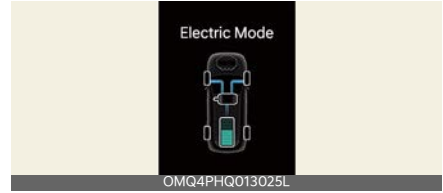

Only the motor power is used to drive the vehicle.
(Battery → Wheel)

Power assist

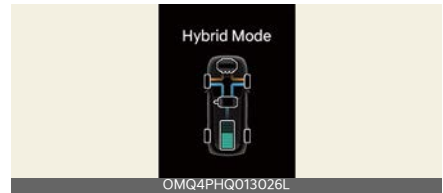

Both the motor and the engine power are used to drive the vehicle.
(Battery & Engine → Wheel)

Engine only propulsion

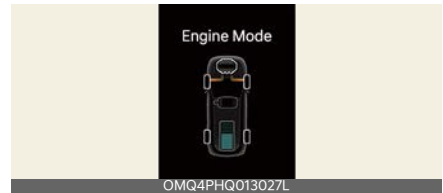

Only the engine power is used to drive the vehicle.
(Engine → Wheel)

Engine generation

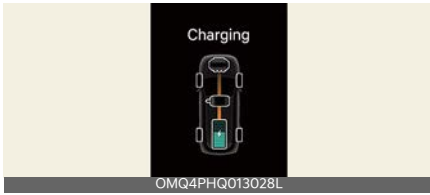

When the vehicle is stopped, the high-voltage battery is charged up by the engine.
(Engine → Battery)

Power reserve

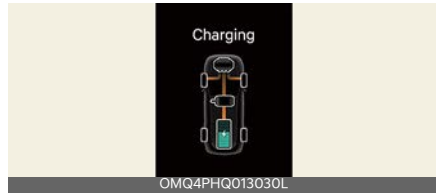

The engine is simultaneously used to drive the vehicle and to charge up the high-voltage battery.
(Engine → Wheel & Battery)

Regeneration

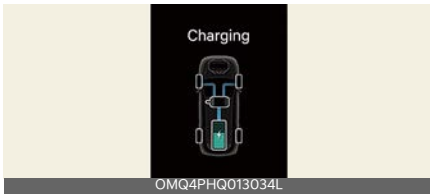

The high-voltage battery is charged up by the regenerative brake system.
(Wheel → Battery)

Engine generation/motor drive



The engine charges up the high-voltage battery. The motor power is used to drive the vehicle.
(Engine → Battery → Wheel)

Engine brake

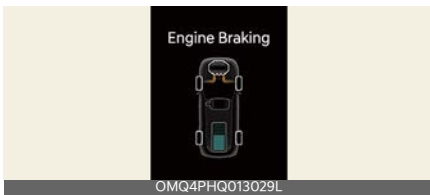

The engine braking is used to decelerate the vehicle.
(Wheel → Engine)

Engine generation/regeneration

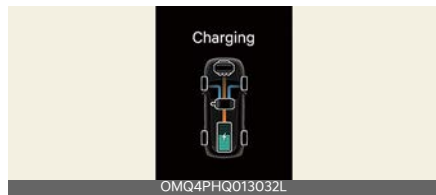

The engine and regenerative brake system charges up the high-voltage battery.
(Engine & Wheel → Battery)

Engine brake/regeneration

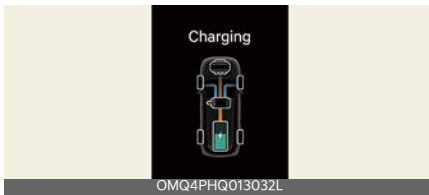

The engine braking is simultaneously used to decelerate the vehicle and to charge up the high-voltage battery. (Wheel → Engine & Battery)

Start engine to avoid battery discharge

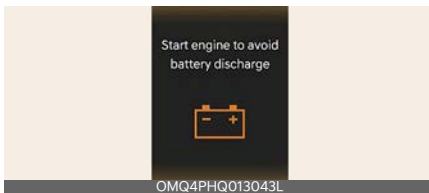

If the engine is not turned on with the ENGINE START/STOP button in ACC or ON for a while, the battery can be discharged. Please turn on the engine to prevent 12 V battery from discharge.

Aux. Battery Saver+

The Aux. Battery Saver+ is a function that monitors the charging status of the 12 V auxiliary battery. If the auxiliary battery level is low, the main high voltage battery charges the auxiliary battery.

* NOTICE

The Aux. Battery Saver+ function will be ON when the vehicle is delivered.

Mode

- Cycle Mode: When the vehicle is OFF with all doors, hood and liftgate closed, the Aux. Battery Saver+ periodically activates according to the auxiliary battery status.
- Automatic Mode: When the ENGINE START/STOP button is in the ON position with the charging connector plugged in, the function activates according to the auxiliary battery status to prevent over-discharge of the auxiliary battery.

⚠ CAUTION

- The Aux. Battery Saver+ activates for a maximum of 20 minutes. If the Aux. Battery Saver+ function activates more than 10 times consecutively, in the Automatic Mode the function will stop activating, judging that there is a problem with the auxiliary battery. In this case, drive the vehicle for some period of time. The function will start activating if the auxiliary battery returns to normal.
- The Aux. Battery Saver+ function cannot prevent battery discharge if the auxiliary battery is damaged, worn out, used as a power supply or unauthorized electronic devices are used.

System setting

The driver can activate the Aux. Battery Saver+ function by placing the ENGINE START/STOP button to the ON position.

⚠ WARNING

When the function is activated the charging indicator lamp will quickly blink and high voltage electricity will be flowing in the vehicle. Do not touch the high voltage electric wire (orange), connector, and all electric components and devices. This may cause electric shock and lead to injuries. Also, do not modify your vehicle in any way. This may affect your vehicle performance and lead to an accident.



Hybrid Driving System

e-Handling (Electrically Assisted Handling Performance)/e-EHA (Electrically Evasive Handling Assist) (for hybrid vehicle)

e-Handling controls the electric motor while turning around to improve the handling performance, driving safety, convenience and ride comfort.

e-EHA connects FCA (Forward Collision Avoidance Assist) and the electric motor to provide assists to avoid collision so that prompt collision avoidance is available while FCA warning appears.

* e-Handling stands for Electrically Assisted Handling Performance.

* e-EHA means Electrically Evasive Handling Assist.

Operating condition(s)

- e-Handling starts to work by identifying enter or exit condition if the driver operates the steering wheel over a certain level when the vehicle speed is between 25 mph (40 km/h) and 74.5 mph (120 km/h).
- e-EHA operates if there is urgent steering wheel operation while FCA (Forward Collision Avoidance Assist) warning appears.

Non-operating condition(s)

- When ESC operates
- When ABS works

⚠ CAUTION

The system does not work under the following conditions.

- When the ESC operation stop light is on
- When it does not work due to a malfunction of electronic device
- When the manual shift mode is set
- The gear shift is not in D (Drive)

*** NOTICE**

Refer to "Paddle shifter" on page 6-15.

**Components of the hybrid/
plug-in hybrid vehicle**

The Hybrid battery uses high voltage to operate the electric motor and other components. High voltage is dangerous if touched.

Your vehicle is equipped with orange colored insulation and covers over the high voltage components to protect people from electric shock. High voltage warning labels are attached to some system components as additional warnings. Have your vehicle serviced by a professional workshop. Have your vehicle inspected by an authorized Kia dealer.

⚠ WARNING**High voltage components**

Never touch orange colored or high voltage labeled components, including wires, cables, and connections. When the insulators or covers are damaged or removed, severe injury or death from electrocution may occur.

⚠ WARNING**Avoid Touching Hybrid Power Control Unit**

While replacing the fuses in the engine compartment, never touch the HPCU. The HPCU carries high voltage. Touching the HPCU may result in electrocution, serious injury, or death.

⚠ CAUTION**High Voltage Battery Damage**

When loading your vehicle, be careful of transporting items in a manner that could damage the high voltage battery. Do not store items on top of the high voltage battery or overload the trunk

area. Such actions may ultimately damage the high voltage battery unit.

⚠ WARNING

In the hybrid system, the hybrid battery uses high voltage to operate the motor and other components. This high voltage hybrid battery system can be very dangerous.

Never touch the hybrid system. When you touch the hybrid battery system, serious injury or death may occur.

⚠ CAUTION

Be careful when loading flammable liquid in the passenger compartment. It could cause operational and safety degradation if the liquid leaks and flows in the high voltage battery.

⚠ WARNING

Battery electrolyte

As with all batteries, avoid fluid contact with the hybrid battery. If the battery is damaged and if electrolyte comes in contact with your body, clothes or eyes, immediately flush with a large quantity of fresh water.

⚠ WARNING

After market battery charger

Do not use an after-market battery charger to charge the hybrid battery. Doing so may result in death or serious injury.

⚠ WARNING

High waters

- Avoid high waters as this may result in your vehicle becoming saturated with

water and could compromise the high voltage components.

- Do not touch any of the high voltage components within your vehicle if your vehicle has been submerged in water equal to half of the vehicle height. Touching high voltage components once submerged in water could result in severe burns or electric shock that could result in death or serious injury.

⚠ CAUTION

Carrying liquids in liftgate

Do not load open containers into the vehicle. If the water spills onto the HEV battery, it may cause a short and damage the battery.

⚠ CAUTION

Cleaning engine

When you clean the engine compartment, do not wash using water. Water may cause electric arcing to occur and damage electronic parts and components.

⚠ WARNING

Exposure to high voltage

- High voltage in the hybrid battery system is very dangerous and can cause severe burns and electric shock. This may result in serious injury or death.
- For your safety, never touch, replace, dismantle or remove any portion of the hybrid battery system including components, cables and connectors.

⚠ WARNING**Use of water or liquids**

If water or liquids come into contact with the hybrid system components, and you are also in contact with the water, severe injury or death due to electrocution may occur.

⚠ WARNING**Hot components**

When the hybrid battery system operates, the HEV battery system can be hot. Heat burns may result from touching even insulated components of the HEV system.

⚠ CAUTION**Prolonged parking**

Prolonged parking might cause battery discharge and operation failure due to natural discharge. Driving the vehicle approximately once every 2 months, more than 9 miles (15 km) is recommended. The battery will be charged automatically when driving the vehicle.

Hybrid vehicle components**High voltage battery system****⚠ WARNING**

Never touch orange colored or high voltage labeled components, including wires, cables, and connections. When the insulators or covers are damaged or removed, severe injury or death from electrocution may occur.

⚠ WARNING

While replacing the fuses in the engine compartment, never touch the HPCU. The HPCU carries high voltage. Touching the HPCU may result in electrocution, serious injury, or death.

⚠ WARNING

In the hybrid system, the hybrid battery uses high voltage to operate the motor and other components. This high voltage hybrid battery system can be very dangerous.

Never touch the hybrid system. When you touch the hybrid battery system, serious injury or death may occur.

⚠ CAUTION

Be careful when loading flammable liquid in the luggage compartment. It could cause operational and safety degradation if the liquid leaks and flows in the high voltage battery.

⚠ WARNING

- Do not disassemble the high voltage motor connector. The high voltage motor connector may contain residual high voltage. Coming in contact with high voltage may result in death or serious injury.
- Your vehicle's hybrid system should only be inspected or repaired by an authorized Kia dealer.

⚠ WARNING

- Do not disassemble or assemble the high voltage battery system. Doing so may result in electric shock, causing death or serious injury.

- If you disassemble or assemble hybrid system components improperly, it may damage the performance and reliability of your vehicle.
- If electrolyte comes in contact with your body, clothes or eyes, immediately flush with a large quantity of fresh tap water. Have your eyes examined by a doctor as soon as possible.

⚠ WARNING

Never assemble or disassemble the high voltage battery system.

- If you assemble or disassemble the high voltage battery system, the durability and performance of the vehicle may be damaged.
- When you want to check the high voltage battery system, have the vehicle inspected by an authorized Kia dealer.
- Do not touch the high voltage battery and high voltage cable connected to motor (orange color). Severe burns and electric shock may occur. For your safety, do not touch the cover of electronic components and electronic cable. Do not remove the cover of electronic components and electronic cable. In particular, never touch the high voltage battery system when the hybrid system in operation. It may result in death or serious injury.

⚠ WARNING

- Never use the package modules (high voltage battery, inverter and converter) for any other purpose.
- Do not use an unauthorized battery charger to charge the high voltage battery. Doing so may result in death or serious injury.

- Never locate the high voltage system near or in a fire.
- Never drill into or strike the package module. Otherwise, it may be damaged. An electric shock may occur, resulting in serious injury or death.

*** NOTICE**

- When the vehicle is paint baked, do not bake over 30 minutes in 158 °F (70 °C) or 20 minutes in 176 °F (80 °C) degree.
- Do not wash the engine compartment, using water. Water may cause an electric shock and damage the electronic components.

⚠ WARNING

This hybrid vehicle uses the hybrid battery system inverter and converter to generate high voltage. High voltage in the hybrid battery system is very dangerous and may cause severe burns and electric shock. This may result in serious injury or death.

- For your safety, never touch, replace, disassemble or remove the hybrid battery system including components, cables and connectors. Severe burns or electric shock may result in serious injury or death when you fail to follow this warning.
- When the hybrid battery system operates, the hybrid battery system can be hot. Always be careful because burns or electric shock may be caused by high voltage.
- Do not spill liquid on the HPCU, HSG, motor and fuses. If the hybrid system components come in contact with liquid, it may result in electric shock.

Hybrid battery cooling duct (Hybrid vehicle)

Under the rear seats



The hybrid battery cooling duct is located under the rear seats. The cooling duct cools down the hybrid battery. When the hybrid battery cooling duct is blocked, the hybrid battery may be overheated.

Clean the cooling duct for the hybrid battery with a dry cloth on a regular basis.

⚠ WARNING

Air Intake

- Blocking the air intake behind the rear seats may damage the HEV battery.
- Do not allow any water into the air intake even when cleaning. If any water enters the air intake, the Hybrid battery may cause an electric shock which can cause serious injury or death due to electrocution.

⚠ WARNING

Interference with electronic medical devices

- Electromagnetic waves that are generated from the charger can impact medical electric devices such as an implantable cardiac pacemaker. When using such medical electric devices, ask your medical professional and the device manufacturer whether charging your electric vehicle

will impact the operation of the medical electric devices.

Service interlock connector



The service interlock connector, located within the motor compartment, is a safety device that disables the high voltage of the battery. It's for vehicle inspections by your authorized Kia dealer. Have the vehicle checked by an authorized Kia dealer.

To access the service interlock connector, open the hood, and find it (🔍) near the fuse box.

⚠ WARNING

- Avoid contacting the service interlock connector to prevent severe injury or death from electric shock.
- If you need to inspect or maintain the service interlock connector, have the vehicle inspected by an authorized Kia dealer.
- Only disconnect or tamper with the service interlock connector in an emergency, as it may cause significant vehicle issues such as failure to start.

If an accident occurs

WARNING

- For your safety, do not touch the high voltage cables, connectors and package modules. High voltage components are orange in color.
- Exposed cables or wires may be visible inside or outside the vehicle. Never touch the wires or cables, because an electrical shock, an injury, or a death may occur.
- Any gas or electrolyte leakage from your vehicle is not only poisonous but also flammable. Upon witnessing one of those, open the windows, and remain a safe distance from the vehicle out of the road.
Immediately call an emergency services or contact an authorized Kia dealer and advise them that a hybrid vehicle is involved.
- When the vehicle is severely damaged, remain a safe distance of 49 ft. (15 m) or more between your vehicle and other vehicles/flammables.

CAUTION

If a fire occurs:

- If a small scale fire occurs, use a fire extinguisher (ABC, BC) that is meant for electrical fires.
If it is impossible to extinguish the fire in the early stage, remain a safe distance from the vehicle and immediately call your local fire emergency responders. Also, advise them that a hybrid vehicle is involved.
If the fire spreads to the high voltage battery, large amount of water is needed to put out the fire.

Using small amount of water or fire extinguishers not meant for electrical fires could cause serious injury or death from electrical shocks.

- Upon witnessing any sparks, gases, flames, or fuel leakage of your vehicle, immediately call emergency services or contact an authorized Kia dealer. Also, advise them that a hybrid vehicle is involved.

WARNING

When a submersion in water occurs:

When your vehicle is flooded in water, a high-voltage battery may cause shock or fires. Thus, turn the hybrid system OFF, take the key in your possession and escape to a safe place. Never attempt physical contact with your flooded vehicle.

Immediately contact an authorized Kia dealer and advise them that a hybrid vehicle is involved.

When the hybrid vehicle shuts off

When the high voltage battery or 12 volt battery is discharged, or when the fuel tank is empty, the hybrid system may not operate while driving. When the Hybrid system does not operate, do the followings:

1. Gradually reduce the vehicle speed.
Pull over your vehicle off the road in a safe area.
2. Locate the shift dial in P (Park).
3. Turn ON the hazard warning flashers.
4. Turn OFF the vehicle, and try to start the hybrid system again, while depressing the brake pedal and turning on the ENGINE START/STOP button.

5. When the hybrid system still does not operate, refer to "Emergency starting" on page 8-5.

Before jump starting the vehicle, check the fuel level and the exact procedure to jump start. When the fuel level is low, do not attempt to drive the vehicle only with the battery power. The high voltage battery may be discharged, and the hybrid system will turn OFF.

WARNING

Vehicle accident

Never touch electric wires or cable. If exposed electric wires or cables are visible inside or outside your vehicle, an electric shock may occur.

WARNING

Putting out fire

Never use a small quantity of water to put out a fire in your vehicle. If a fire occurs, evacuate the car immediately and contact the fire department.

Fuel requirements	2-2
Vehicle modifications.....	2-4
Vehicle break-in process	2-5
Risk of burns when parking or stopping vehicle	2-5
• Vehicle handling instructions.....	2-5
• Open-Source Software Notice.....	2-6
Vehicle data collection and Event Data Recorders.....	2-6
HEV/PHEV powertrain	2-7

Introduction

Fuel requirements

Your new vehicle is designed to use only unleaded fuel having a pump octane number (R+M)/2 of 87 (Research Octane Number 91) or higher. (Do not use methanol blended fuels.)

Your new vehicle is designed to obtain maximum performance with UNLEADED FUEL, as well as minimize exhaust emissions and spark plug fouling.

Never add any fuel system cleaning agents to the fuel tank other than what has been specified. (Consult an authorized Kia dealer for details.)

- Tighten the cap until it clicks one time, otherwise the Check Engine light will appear.

WARNING

Refueling

- Do not "top off" after the nozzle automatically shuts off. Attempts to force more fuel to overflow onto you and the ground, causing a risk of fire.
- Always check that the fuel cap is installed securely to prevent fuel spillage, especially in the event of an accident.

Gasoline containing alcohol and methanol.

Gasohol, a mixture of gasoline and ethanol (also known as grain alcohol), and gasoline or gasohol containing methanol (also known as wood alcohol) are being marketed along with or instead of leaded or unleaded gasoline.

Pursuant to Environmental Protection Agency (EPA) regulations, ethanol may be used in your vehicle.

Do not use gasohol containing more than 15% ethanol, and do not use gasoline or gasohol containing any methanol. Ethanol provides less energy than gasoline and attracts water. Thus, it is likely to reduce your fuel efficiency and could lower your MPG results.

Methanol may cause drivability problems and damage to the fuel system, engine control system and emission control system.

Discontinue using gasohol of any kind if drivability problems occur.

Vehicle damage or drivability problems may not be covered by the manufacturer's warranty if they result from the use of:

1. Gasoline or gasohol containing methanol.
2. Leaded fuel or leaded gasohol.
3. Gasohol containing more than 15% ethanol.

"E85" fuel is an alternative fuel comprised of 85% ethanol and 15% gasoline and is manufactured exclusively for use in Flexible Fuel Vehicles. "E85" is not compatible with your vehicle. Use of "E85" may result in poor engine performance and damage to your vehicle's engine and fuel system. Kia recommends that customers do not use fuel with an ethanol content exceeding 15%.

*** NOTICE**

Your New Vehicle Limited Warranty does not cover damage to the fuel system, or any performance problems caused using "E85" fuel.

*** NOTICE**

Never use any fuel containing methanol. Discontinue use of any methanol containing products which may inhibit proper drivability.

Other fuels

Using fuels that contain Silicone (Si), MMT (Methylcyclopentadienyl Manganese Tricarbonyl), Manganese (Mn) contained fuel, and other metallic additives, may cause vehicle and engine damage or cause misfiring, poor acceleration, engine stalling, catalyst melting, clogging, abnormal corrosion, life cycle reduction, etc.

Also, the Malfunction Indicator Lamp (MIL) may appear.

*** NOTICE**

Damage to the fuel system or performance problems caused using these other fuels may not be covered by your New Vehicle Limited Warranty.

Gasoline containing MMT.

Some gasoline contains harmful manganese-based fuel additives Such as MMT (Methylcyclopentadienyl Manganese Tricarbonyl). Kia does not recommend the use of gasoline containing MMT. This type of fuel can reduce vehicle performance and affect your emission control

system. The Malfunction Indicator Lamp (MIL) on the cluster may come on.

Do not use methanol.

Fuels containing methanol (wood alcohol) should not be used in your vehicle. This type of fuel can reduce vehicle performance and damage components of the fuel system, engine control system and emission control system.

Fuel Additives

Kia recommends that you use good quality gasoline treated with detergent additives such as TOP TIER Detergent Gasoline, which help prevent deposit formation in the engine. These gasoline will help the engine run cleaner and enhance performance of the emission control system.

For more information on TOP TIER Detergent Gasoline, please go to the website (www.toptiergas.com) For customers who do not use TOP TIER Detergent Gasoline regularly and have problems starting or the engine does not run smoothly, additives that you can buy separately may be added to the gasoline.

If TOP TIER Detergent Gasoline is not available, one bottle of additive should be added to the fuel tank every 8,000 miles (13,000 km) or every engine oil change is recommended. Additives are available from your authorized Kia dealer along with information on how to use them. Do not mix with other additives.

Operation in foreign countries

If you are going to drive your vehicle in another country, be sure to:

- Observe all regulations regarding registration and insurance.
- Determine that acceptable fuel is available.

Vehicle modifications

This vehicle should not be modified. Modification of your vehicle could affect its performance, safety or durability and may even violate governmental safety and emissions regulations.

*** NOTICE**

Damage or performance problems resulting from any modification may not be covered under the warranty.

⚠ CAUTION

If you use unauthorized electronic devices, it may cause the vehicle to operate abnormally, wire damage, battery discharge and fire. For your safety, do not use unauthorized electronic devices.

Vehicle break-in process

By following a few simple precautions for the first 600 miles (1,000 km) you may add to the performance, economy and life of your vehicle.

- Do not race the engine.
- While driving, avoid sudden acceleration
- Do not maintain a single engine speed for long periods of time, either fast or slow. Varying engine speeds is needed to properly break in the engine.
- Avoid hard stops, except in emergencies, to allow the brakes to seat properly.
- Don't tow a trailer during the first 1,200 miles (2,000 km) of operation.
- Fuel economy, engine performance, and engine oil consumption may differ depending on the vehicle break-in process and be stabilized after 4,000 miles (6,000 km). New engines may consume more oil during the vehicle break-in period.

Risk of burns when parking or stopping vehicle

- Do not park or stop the vehicle near flammable items such as leaves, paper, oil, and tires. Such items placed near the exhaust system can become a fire hazard.
- When an engine idles at a high speed with the rear side of the vehicle touching a wall, the heat of the exhaust gas can cause discoloration or fire. Keep enough space between the rear part of the vehicle and a wall.
- Be sure not to touch the exhaust/catalytic systems while the engine is running or right after the engine is turned off. There is a risk of burns since the systems are extremely hot.

Vehicle handling instructions

As with all vehicles of this type, failure to operate this vehicle correctly may result in loss of control, an accident or rollover.

Specific design characteristics (higher ground clearance, track, etc.) give this vehicle a higher center of gravity than other types of vehicles. It is not designed for cornering at the same speeds as a conventional 2-wheel drive vehicle.

Avoid sharp turns or abrupt maneuvers. Failure to operate this vehicle correctly may result in loss of control, an accident or rollover.

Be sure to read the "Reducing the risk of a rollover" on page 6-53.

Open-Source Software Notice

This vehicle contains software with open source licenses.

Open source software information including the source code, copyright notices and referred license terms may be obtained on the website

<https://worldwide.kia.com/int/open-source>.

Kia Corporation will provide the open source code to you in storage medium such as CD-ROM for minimum charge covering the cost of performing source distribution upon email request to

opensource@kia.com

within a period of 3 years from the date of product purchase.

Vehicle data collection and Event Data Recorders

This vehicle is equipped with an Event Data Recorder (EDR). The main purpose of an EDR is to record, in certain crash or near crash-like situations, such as an air bag deployment or hitting a road obstacle, data that will assist in understanding how a vehicle's systems performed. The EDR is designed to record data related to vehicle dynamics and safety systems for a short period of time, typically 30 seconds or less. The EDR in this vehicle is designed to record such data as:

- How various systems in your vehicle were operating;
- Whether or not the driver and passenger safety belts were buckled/fastened;
- How far (if at all) the driver was depressing the accelerator and/or brake pedal; and,
- How fast the vehicle was traveling.

These data can help provide a better understanding of the circumstances in which crashes and injuries occur.

NOTE: EDR data are recorded by your vehicle only if a non-trivial crash situation occurs; no data are recorded by the EDR under normal driving conditions and no personal data (e.g., name, gender, age, and crash location) are recorded. However, other parties, such as law enforcement, could combine the EDR data with the type of personally identifying data routinely acquired during a crash investigation.

To read data recorded by an EDR, special equipment is required, and access to the vehicle or the EDR is needed. In addition to the vehicle

manufacturer, other parties, such as law enforcement, that have the special equipment, can read the information if they have access to the vehicle or the EDR.

HEV/PHEV powertrain

By following a few simple precautions for the first 600 miles (1,000 km) you may increase the performance economy and life of your vehicle.

- Do not race the engine.
- Avoid hard stops, except in emergencies, to allow the brakes to seat properly.

Your vehicle at a glance **3**

Exterior overview	3-2
Interior overview	3-5
Instrument panel overview	3-7
Engine compartment.....	3-9

Your vehicle at a glance

Exterior overview

Front view

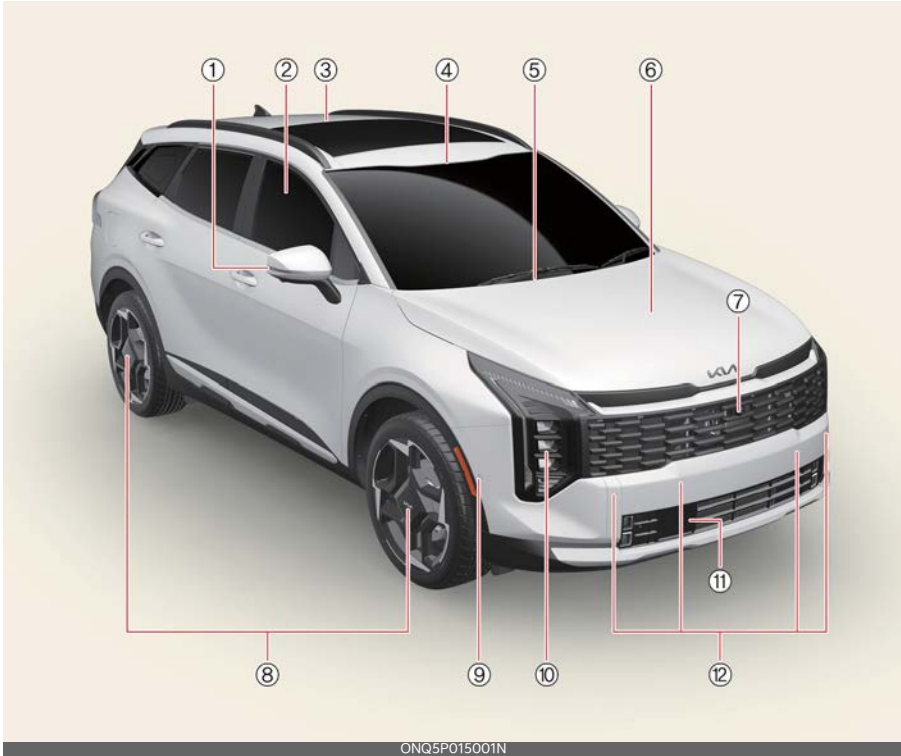

ONQ5P015001N

* The actual shape of your Kia may differ from the illustration.

- | | |
|----------------------------------|-------------|
| 1. Hood | 5-48 |
| 2. Front windshield wiper blades | 5-106, 9-25 |
| 3. Front view camera | 7-5 |
| 4. Panoramic sunroof | 5-55 |
| 5. Windows | 5-44 |
| 6. Outside rear view mirror | 5-71 |
| 7. Wide-front view camera | 7-101 |
| 8. Front radar | 7-5, 7-62 |
| 9. Front ultrasonic sensors | 7-115 |
| 10. Head lamp | 5-100, 9-57 |

11.Front side ultrasonic sensors

7-126

12.Wheel and tires

9-32, 10-5

Rear view

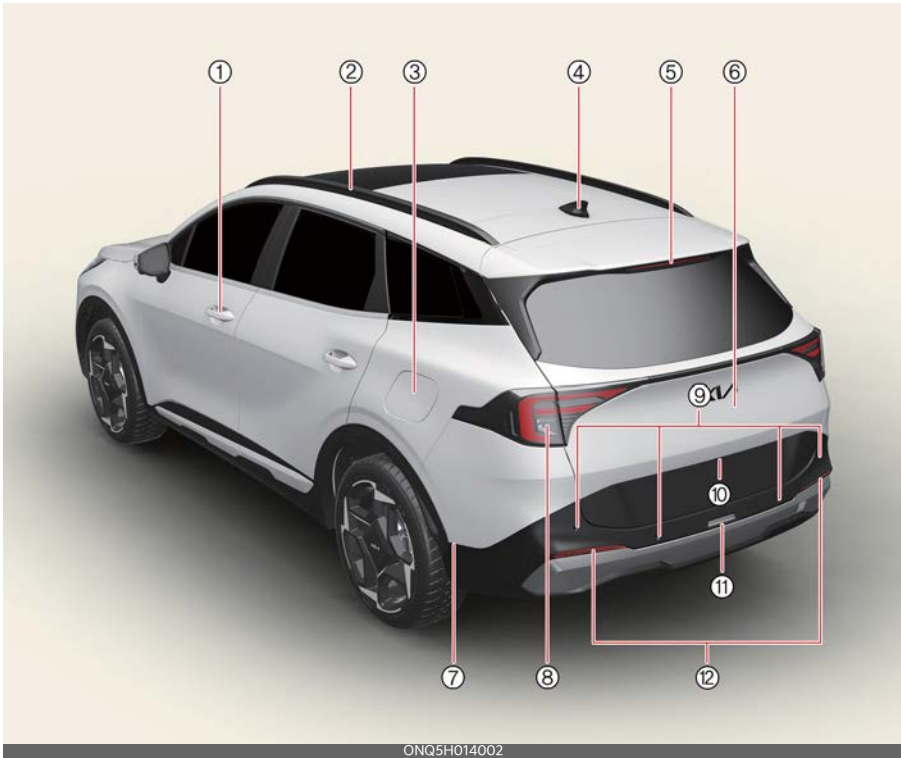

ONQ5H014002

* The actual shape of your Kia may differ from the illustration.

- | | |
|---------------------------------|-------------|
| 1. Doors | 5-26 |
| 2. Roof rack | 5-139 |
| 3. Fuel filler door | 5-50 |
| 4. Antenna | 5-145 |
| 5. High mounted stop lamp | 5-101, 9-57 |
| 6. Liftgate | 5-34 |
| 7. Rear side ultrasonic sensors | 7-126 |
| 8. Rear combination lamp | 5-101, 9-57 |
| 9. Rear ultrasonic sensors | 7-126 |
| 10. Wide-rear view camera | 7-97 |
| 11. Backup lamp | 5-101, 9-57 |
| 12. Rear reflector | |

Interior overview

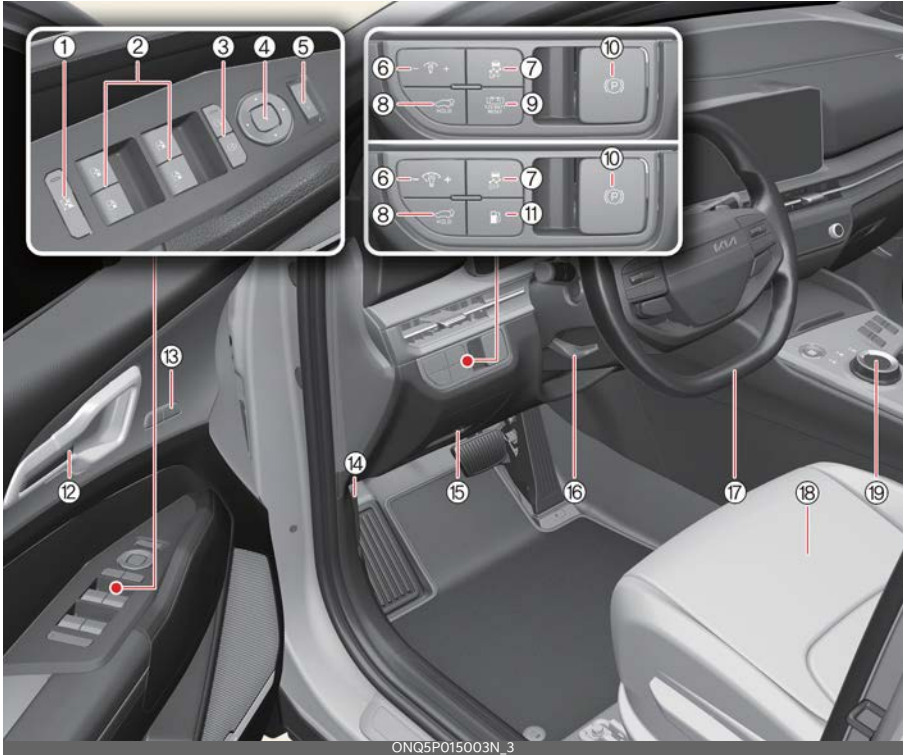

* The actual shape of your Kia may differ from the illustration.

1. Power window lock button	5-47
2. Power window switches	5-45
3. Central door lock/unlock button	5-28
4. Outside rearview mirror control/folding button	5-71
5. Outside rearview mirror select switch	5-71
6. Headlight leveling adjustment switch	5-100
7. ESC OFF button	6-39
8. Power liftgate open/close button	5-36
9. 12 V battery reset button	8-5
10. EPB switch	6-32
11. Fuel door open button	5-50
12. Inside door handle	5-28
13. Integrated memory system	5-32

14.Hood release lever	5-48
15.Instrument panel fuse	9-47
16.Steering wheel tilt/telescopic lever	5-60
17.Steering wheel	5-59
18.Seat	4-5
19.Shift dial	6-9

Instrument panel overview

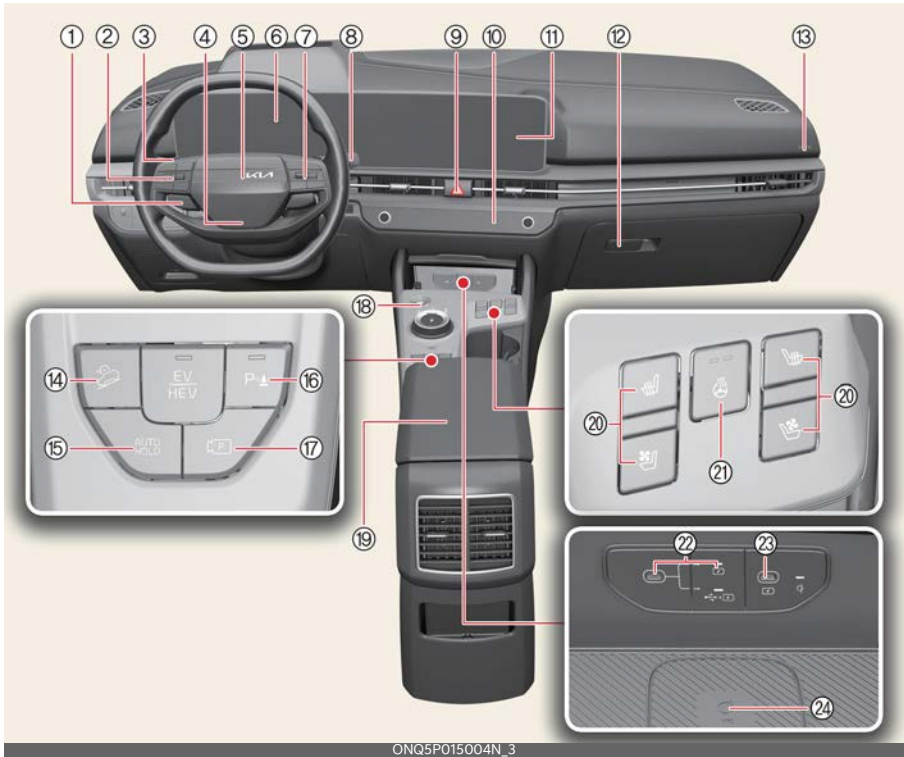

ONQ5P015004N_3

* The actual shape of your Kia may differ from the illustration.

- | | |
|--|--------------|
| 1. Drive mode button | 6-48 |
| 2. Driving Assist button | 7-62 |
| 3. Light control/turn signals lever | 5-100 |
| 4. Driver's front air bag | 4-46 |
| 5. Horn | 5-61 |
| 6. Instrument cluster | 5-74 |
| 7. Audio remote control button | |
| 8. Wiper and washer control lever | 5-106 |
| 9. Hazard warning flasher switch | 8-3 |
| 10. Climate control system | 5-117 |
| Infotainment/climate switchable controller | 5-118, 5-144 |
| 11. Infotainment system | 5-142 |
| 12. Glove box | 5-128 |

13.Passenger's front air bag	4-46
14.DBC button	6-41
15.AUTO HOLD button	6-36
16.Parking Safety button	7-116, 7-121
17.Parking/View button	7-98, 7-103
18.ENGINE START/STOP button	6-6
19.Center console storage box	5-128
20.Front seat warmer and air ventilation seat button	5-130
21.Steering wheel heater button	5-60
22.USB charger / USB port	5-132, 5-145
23.USB charger	5-132
24.Wireless smartphone charging system	5-134

Engine compartment

Smartstream G1.6 T-GDi HEV

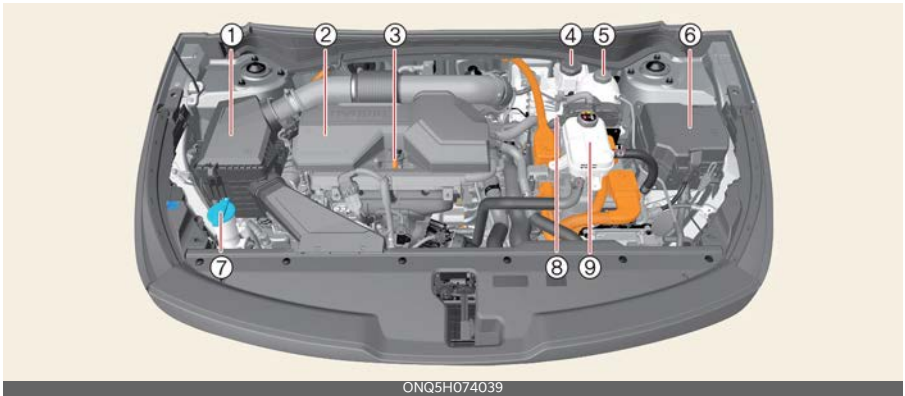

Smartstream G1.6 T-GDi PHEV

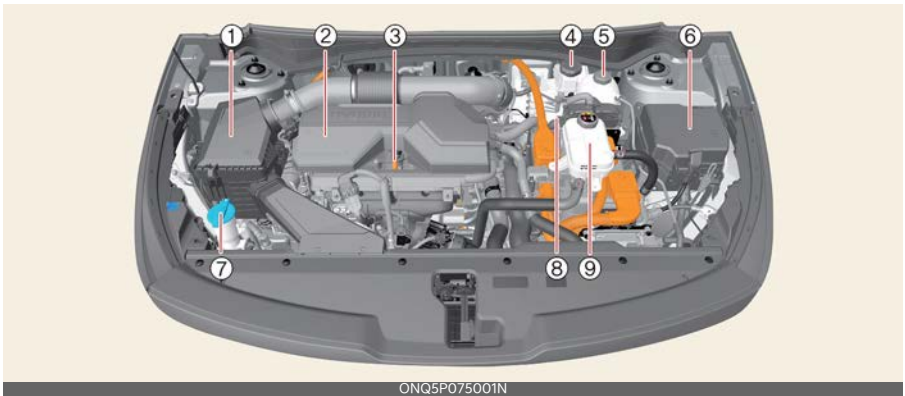

* The actual engine compartment in your Kia may differ from the illustration.

- | | |
|--------------------------------------|------|
| 1. Air cleaner | 9-13 |
| 2. Engine oil filler cap | 9-15 |
| 3. Engine oil dipstick | 9-15 |
| 4. Brake fluid reservoir | 9-21 |
| 5. Engine coolant reservoir | 9-17 |
| 6. Fuse box | 9-45 |
| 7. Windshield washer fluid reservoir | 9-22 |
| 8. Electric Control Unit (ECU) | 8-5 |
| 9. Inverter coolant reservoir | 9-19 |

Safety features of your Kia **4**

Important safety precautions	4-3
Seat	4-5
• Feature of Seat Leather.....	4-7
• Infotainment system.....	4-8
• Front seat adjustment for manual seat.....	4-8
• Front seat adjustment for power seat	4-9
• Headrest for front seat	4-11
• Seatback pocket.....	4-13
• Headrest for rear seat.....	4-13
• Armrest.....	4-14
• Folding the rear seat.....	4-14
Seat belts	4-17
• Seat belt restraint system.....	4-17
• Seat belt warning	4-18
• Seat belt - Driver's 3-point system with emergency locking retractor	4-20
• Seat belts - Front passenger and rear seat 3-point system with combination locking retractor.....	4-21
• Pre-tensioner seat belt	4-23
• Seat belt precautions.....	4-25
• Care of seat belts	4-26
Child Restraint System (CRS).....	4-27
• Children always in the rear.....	4-27
• Selecting a CRS.....	4-28
• Installing a CRS	4-30
Air bag - advanced Supplemental Restraint System	4-35
• How does the air bag system operate?.....	4-36
• Do not install a child restraint on the front passenger's seat.....	4-37
• Air bag warning light	4-38
• Supplemental Restraint System (SRS) components and functions.....	4-38

4 Safety features of your Kia

- Occupant Detection System (ODS).....4-40
- Driver's and passenger's front air bag 4-46
- Side air bag.....4-47
- Curtain air bag 4-49
- Air bag collision sensors4-50
- Why didn't my air bag go off in a collision? (Inflation and non-inflation conditions of the air bag)..... 4-51
- Supplemental Restraint System (SRS) care4-53
- Additional safety precautions..... 4-54
- Adding equipment to or modifying your air bag-equipped vehicle.....4-55
- Air bag warning labels.....4-55

Safety features of your Kia

For the safety of the driver and vehicle passengers, you should become familiar with the vehicle's safety features.

Important safety precautions

You will find many safety precautions and recommendations throughout this section, and throughout this manual.

The safety precautions in this section are among the most important.

Always wear your seat belt

A seat belt is your best protection in all types of accidents. Air bags are designed to supplement seat belts, not replace them. So even though your vehicle is equipped with air bags, ALWAYS fasten your seat belt and make sure all of your passengers have properly fastened their seat belts or restraints before placing vehicle in motion.

Restrain all children

All children under age 13 should ride in your vehicle properly restrained in a rear seat, not the front seat. Infants and small children should be restrained in an appropriate child restraint. Larger children should use a booster seat with the lap/shoulder belt until they can use the seat belt properly without a booster seat.

Air bag hazards

While air bags can save lives, they can also cause serious or fatal injuries to occupants who sit too close to them, or who are not properly restrained. Infants, young children, and shorter adults are at a greater risk of being injured by an inflating air bag. Follow all instructions and warnings in this manual.

Driver distraction

Driver distraction presents a serious and potentially deadly danger, especially for inexperienced drivers. Safety should be the first concern when behind the wheel and drivers need to be aware of the wide array of potential distractions, such as drowsiness, reaching for objects, eating, personal grooming, other passengers, and using cellular phones.

Drivers can become distracted when they take their eyes and attention off the road or their hands off the wheel to focus on activities other than driving. To reduce your risk of distraction or getting into an accident:

- ALWAYS set up your mobile devices (i.e., MP3 players, phones, navigation units, etc.) when your vehicle is parked or safely stopped.
- ONLY use your mobile device when allowed by laws and when conditions permit safe use. NEVER text or email while driving. Most states have laws prohibiting drivers from texting. Some states and cities also prohibit drivers from using handheld phones.
- NEVER let the use of a mobile device distract you from driving. You have a responsibility to your passengers and others on the road to always drive safely, with your hands on the wheel as well as your eyes and attention on the road.

Control your speed

Excessive speed is a major factor in crash injuries and deaths. Generally, the higher the speed, the greater the risk, but serious injuries can also occur at lower speeds. Never drive faster than is safe for current driving conditions, regardless of the maximum speed posted.

Keep your vehicle in safe condition

Having a tire blowout or a mechanical failure can be extremely hazardous. To reduce the possibility of such problems, check your tire pressures and conditions frequently, and perform all regularly scheduled maintenance.

Seat

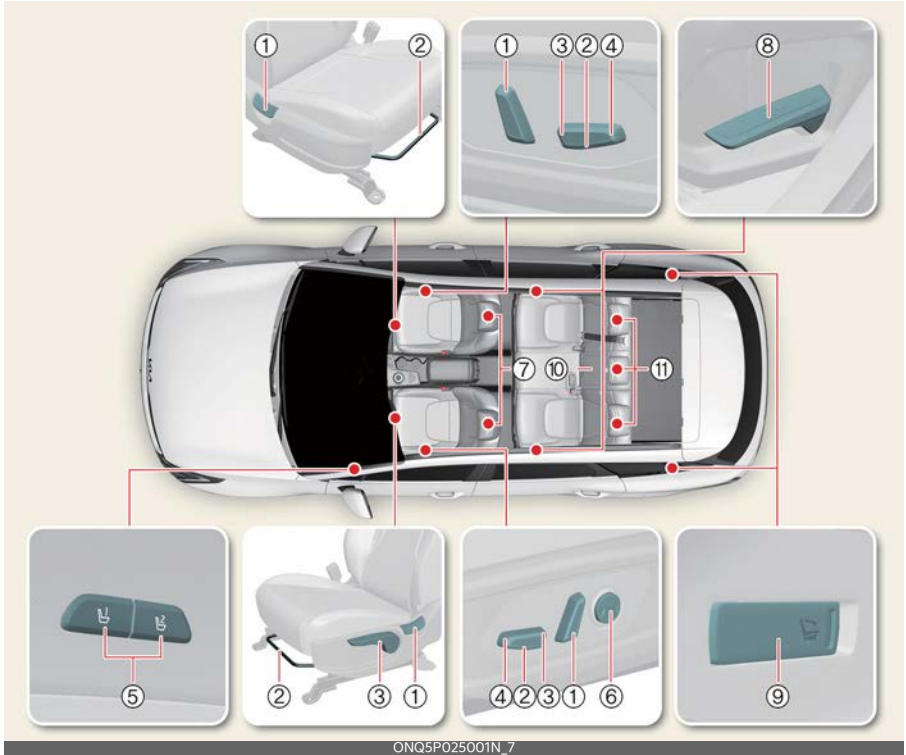

Front seat

- 1 Reclining: Back angle
- 2 Sliding: Forward and Backward
- 3 Seat cushion height
- 4 Seat cushion tilt
- 5 Integrated memory system*
- 6 Lumbar support*
- 7 Headrest

Rear seat

- 8 Seatback angle/folding
 - 9 Seatback folding*
 - 10 Armrest
 - 11 Headrest
- * : if equipped

⚠ WARNING**Loose objects**

Loose objects in the driver's foot area could interfere with the operation of the foot pedals, possibly causing an accident. Do not place anything under the front seats.

⚠ WARNING**Uprighting seat**

Do not press the release lever on a manual seatback without holding and controlling the seatback. The seatback will spring upright, possibly striking you or other passengers.

⚠ WARNING**Driver responsibility for passengers**

The driver must advise the passengers to keep the seatback in an upright position whenever the vehicle is in motion. If a seat is reclined during an accident, the restraint system's ability to restrain the passenger will be greatly reduced.

⚠ WARNING**Seat cushion**

Occupants should never sit on aftermarket seat cushions or sitting cushions. The passenger Occupant Detection System may not operate properly, or the passenger's hips may slide under the lap

portion of the seat belt during an accident or a sudden stop.

⚠ WARNING**Driver's seat**

- Never attempt to adjust the seat while the vehicle is moving. This could result in loss of control of your vehicle.
- Do not allow anything to interfere with the normal position of the seatback. For example, storing items against the seatback could overload the seatback in a sudden stop or collision resulting in serious or fatal injury.
- Sit as far back as possible from the steering wheel while still maintaining comfortable control of your vehicle. A distance of at least 10 in (25 cm) from your chest to the steering wheel is recommended. Failure to do so can result in air bag inflation injuries to the driver.

⚠ WARNING**Rear seatbacks**

Always lock the rear seatback before driving. Failure to do so could result in passengers or objects being thrown forward, injuring vehicle occupants.

⚠ WARNING**Unexpected Seat Movement**

After adjusting a manual seat, always check that it is locked by shifting your weight to the front and to the back. Sudden or unexpected movement of the driver's seat could cause you to lose control of the vehicle.

⚠ WARNING**Seat adjustment**

- Do not adjust the seat while wearing seat belts. Moving the seat forward will cause strong pressure on the abdomen.
- Do not place your hand near the seat bottom or seat track while adjusting the seat. Your hand could get caught in the seat mechanism.

⚠ WARNING**Luggage and Cargo**

Do not stack or pile luggage or cargo higher than the seatback in the cargo area. In an accident the cargo could strike and injure a passenger. If objects are large, heavy or must be piled, they must be secured in the cargo area.

⚠ WARNING**Cargo Area**

Do not allow passengers to ride in the cargo area under any circumstance. The cargo area is solely for the purpose of transporting luggage or cargo.

⚠ WARNING**Small Objects**

Use extreme caution when picking up small objects trapped under the seats or between the seat and the center console. Your hands might be cut or injured by the sharp edges of the seat mechanism.

Feature of Seat Leather

- Our car seats are upholstered with a combination of artificial and genuine leather. The genuine leather is made from the outer skin of an animal, which goes through a special process to be available for use. Since it is a natural substance, each part differs in thickness or density. Also, wrinkles could appear depending on the temperature and humidity.
- The seat cover is made of stretchable material to improve comfort of passengers.
- The parts contacting the body are curved and the side supporting area is high which provides driving comfort and stability.

⚠ CAUTION

- Belts with metallic accessories, zippers or keys inside the back pocket may damage the seat fabric.
- Make sure not to wet the seat. It may change the nature of leather.
- Jeans or clothes which could bleach may contaminate the surface of the seat covering fabric.

*** NOTICE**

Wrinkles or abrasions may appear naturally from usage. It is not a fault of the product. Wrinkles or abrasions are not covered by warranty.

Infotainment system

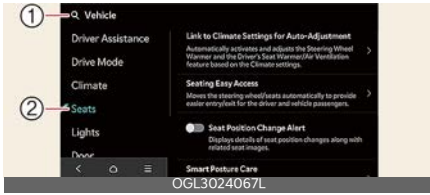

1 Vehicle

2 Seats

Select **Setup** → **Vehicle** → **Seat** from the Settings menu in the infotainment system screen, you may use various convenience functions.

- **Seat position change alert:** When the seat position changes, details of the change are shown with a seat image.
- **Seat Easy Access**
 - **Steering easy access:** Moves the steering wheel when the driver enters or leaves the vehicle.
 - **Seat Slide Easy Access (FWD/AWD) access (Normal/Extended/Off)** the seat automatically moves when the driver enters or leaves the vehicle may be selected.

The information provided may differ according to which functions are applicable to your vehicle.

* INFORMATION

The infotainment system may change after software updates. For more information, refer to the user's manual provided in the infotainment system and the quick reference guide.

Front seat adjustment for manual seat (if equipped)

The front seat can be adjusted by using the control levers located on the outside of the seat cushion.

Moving forward and backward

Adjust the seat before driving, and make sure the seat is locked securely by trying to move forward and backward without using the lever. If the seat moves, it is not locked properly.



- To move the seat forward or backward:
1. Pull the seat slide adjustment lever up and hold it.
 2. Slide the seat to the position you desire.
 3. Release the lever and make sure the seat is locked in place.

Reclining seatback



To recline the seatback:

1. Lean forward slightly and lift the seatback recline lever.
2. Carefully lean back on the seat and adjust the seatback of the seat to the position you desire.
3. Release the lever and make sure the seatback is locked in place. (The lever MUST return to its original position for the seatback to lock.)

⚠ WARNING

Reclining seatback

Sitting in a reclined position when the vehicle is in motion can be dangerous. Even when buckled up, the protections of your restraint system (seat belts and/or air bags) are greatly reduced by reclining your seatback.

Seat belts must be snug against your hips and chest to work properly. When the seatback is reclined, the shoulder belt cannot do its job because it will not be snug against your chest. Instead, it will be in front of you. During an accident, you could be thrown into the seat belt, causing neck or other injuries.

The more the seatback is reclined, the greater chance the passenger's hips will slide under the lap belt or the passen-

ger's neck will strike or become entangled in the shoulder belt.

Changing seat cushion height (if equipped)



To change the height of the seat cushion, push the lever upwards or downwards.

- To lower the seat cushion, push down the lever several times.
- To raise the seat cushion, pull up the lever several times.

Front seat adjustment for power seat (if equipped)

The front seat can be adjusted by using the control switches located on the outside of the seat cushion.

Before driving, adjust the seat to the proper position so you can easily control the steering wheel, pedals and switches on the instrument panel.

⚠ CAUTION

Power seating adjustments

- The power seating controls function by electronic motor. Excessive operation may cause damage to the electrical equipment.
- Do not operate two or more power seat control switches at the same

time. Doing so may damage the power seat motor or electrical components.

Moving forward and backward



To move the seat forward or backward:

1. Push the control switch forward or backward to move the seat to the desired position.
2. Release the switch once the seat reaches the desired position.

Reclining seatback



To recline the seatback:

1. Push the control switch forward or backward to move the seatback to the desired angle
2. Release the switch once the seat reaches the desired position.

Changing seat cushion tilt and height

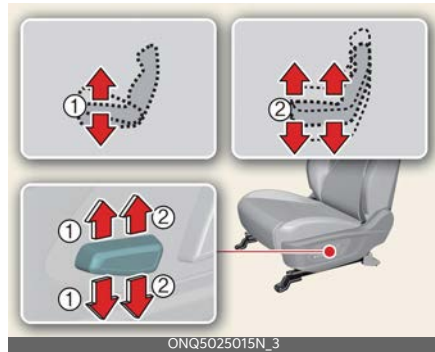

To change the height of the seat:

- Pull the front portion (1) of the control switch up to raise or press down to lower the front part of the seat cushion.
- Pull the rear portion (2) of the control switch up to raise or press down to lower the back part of the seat cushion.
- Release the switch once the seat reaches the desired position.

Adjusting lumbar support for driver's seat (if equipped)



The lumbar support can be adjusted by pressing the lumbar support switch on the side of the seat.

1. Press the front portion (1) of the switch to increase support, or the rear portion (2) of the switch to decrease support.
2. Release the switch once it reaches the desired position.

Headrest for front seat

The driver's and front passenger's seats are equipped with a headrest for the occupant's safety and comfort.



The headrest not only provides comfort for the driver and front passenger, but also helps protect the head and neck in the event of a collision.

For maximum effectiveness in case of an accident, the headrest should be adjusted so the middle of the headrest is as high as the center of gravity of an

occupant's head. Generally, the center of gravity of most people's heads is similar to the height of the top of their eyes.

Also, adjust the headrest as close to your head as possible. For this reason, the use of a cushion that holds the body away from the seatback is not recommended.

⚠ WARNING

Headrest removal/adjustment

- Do not operate the vehicle with the headrests removed. Headrests can provide critical neck and head support in a crash. Operating the vehicle without the headrest in position could lead to serious injury or death.
- Do not adjust the headrest height while the vehicle is in motion. Driver may lose control of the vehicle.

⚠ CAUTION

Excessive pulling or pushing may damage the headrest.

Adjusting the height up and down

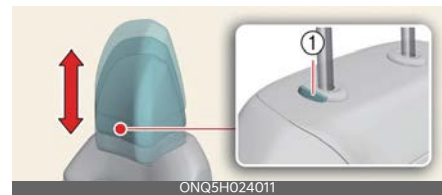

To raise the headrest:

- Pull it up to the desired position.
- To lower the headrest, push and hold the release button (1) on the headrest support.
- Lower the headrest to the desired position.

*** NOTICE**

If you recline the seatback towards the front with the headrest and seat cushion raised, the headrest may come in contact with the sun visor or other parts of the vehicle.



Removing/reinstalling the headrest

Front

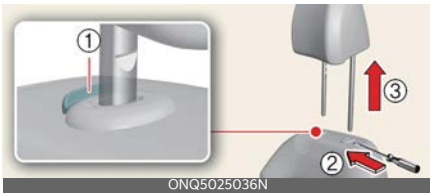

Operation

To remove the headrest:

1. Push and hold the release button (1). Raise the headrest.
2. Insert a short, flat object (such as a small flat-head screwdriver) into the opening on the outer base of the left post (2) and pull the headrest upward (3).

To reinstall the headrest:

1. Put the headrest poles into the holes while pressing the release button (1).

⚠ WARNING

- For maximum effectiveness in case of an accident, the headrest should be adjusted so the middle of the headrest is at the same height of the center of gravity of an occupant's head. Generally, the center of gravity of most people's head is similar with the height of the top of their eyes. Also, adjust the headrest as close to your head as possible. For this reason, the use of a cushion that holds the body away from the seatback is not recommended.



- Do not operate the vehicle with the headrests removed or reversed as severe injury to the occupants may occur in the event of an accident. Headrests may provide protection against neck injuries when properly adjusted.
- Do not adjust the headrest position of the driver's seat while the vehicle is in motion.
- Make sure the headrest locks in position after adjusting it to properly protect the occupants.
- NEVER allow anyone to ride in a seat with the headrests removed.
- Always make sure the headrest locks into position after reinstalling and adjusting it properly.

CAUTION

- When there is no occupant in the rear seats, adjust the height of the headrest to the lowest position. The rear seat headrest can reduce the visibility of the rear area.
- If you recline the seatback towards the front with the headrest and seat cushion raised, the headrest may come in contact with the sun visor or other parts of the vehicle.



Seatback pocket

There is a pocket (1) in the front seatback for storing simple books or atlases, and USB charger (2) (if equipped) for rear passengers.



WARNING

Seatback pockets

Do not put heavy or sharp objects in the seatback pockets. In an accident they could come loose from the pocket and injure vehicle occupants.

Headrest for rear seat

The rear seat is equipped with headrests in all the seating positions for the occupant's safety and comfort.



The headrest not only provides comfort for passengers, but also helps protect the head and neck in the event of a collision.

For maximum effectiveness in case of an accident, the headrest should be adjusted so the middle of the headrest is level with the seat occupant's eyes.

Also, adjust the headrest as close to your head as possible. For this reason, the use of a cushion that holds the body away from the seatback is not recommended.

Adjusting the height up and down

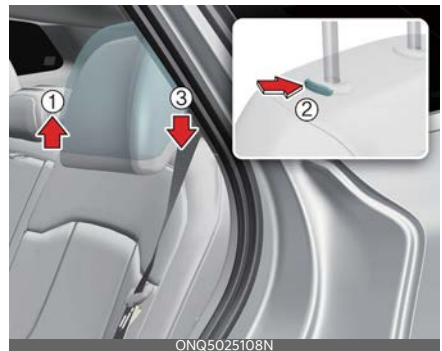

- To raise the headrest, pull it up to the desired position (1).
- To lower the headrest, push and hold the release button (2) on the headrest

support and lower the headrest to the desired position (3).

Removal and reinstallation



- To remove the headrest, raise it as far as it can go then, press the release button (1) while pulling the headrest upward (2).
 - To reinstall the headrest, put the headrest poles (3) into the holes while pressing the release button (1).
- Then adjust it to the appropriate height and ensure that it locks in position.

Armrest



To use the armrest, pull it forward from the seatback.

Folding the rear seat

The rear seatbacks may be folded to facilitate carrying long items or to increase the luggage capacity of the vehicle.

⚠ WARNING

Folded Seatback

The purpose of the fold-down rear seatbacks is to allow you to carry longer objects that could not otherwise be accommodated.

- Never allow a passenger to sit on top of the folded down seatback while the car is moving. This is not a proper seating position since no seat belts are available for use. This could result in serious injury or death, for example, in case of an accident or sudden stop.

⚠ WARNING

When folding the seatback, be sure to hold the seatback or headrest with your hands.

⚠ CAUTION

When folding or unfolding a rear seat, make sure to lower the seat's headrest as much as possible and put the front seat's seatback in the upright position. If there is any interference when folding or unfolding the seat, the interfered area of the seat may be damaged.

Folding down the rear seatback

1. Set the front seatback to the upright position and, if necessary, slide the front seat forward.
2. Lower the rear headrests to the lowest position.

⚠ WARNING

Objects

Objects carried on the folded down seatback should not extend higher than the top of the front seatbacks. Otherwise, cargo may slide forward and cause injury or damage during sudden stops.

3. When folding the seatback, insert the rear seat belt buckle in the pocket between the rear seatback and cushion. Make sure both seat belts do not interfere with stowed luggage and cargo. Then, the seat belt webbing should be placed in the webbing guide to prevent the seat belt from being damaged by loaded cargo, etc. If the seat belt is loose, it may cause damage or noise. In that case, return the seatback to the upright position and put the webbing out from the guide to realign it.



4. Pull on the seatback folding lever, then fold the seat toward the front of the vehicle. When you return the seatback to its upright position, always be sure it has locked into position by pushing on the top of the seatback.

Type A



Type B



Unfolding the rear seat



1. To use the rear seat, lift and pull the seatback backward while pulling on the seatback folding lever. Pull the seatback firmly until it clicks into place. Make sure the seatback is locked in place. When you return the seatback to its upright position, always be sure it has locked into position by pushing on the top of the seatback.
2. Return the rear seat belt to the proper position.
3. When the seatback is completely installed, check the seatback folding lever again.
4. If you want to tilt the rear seatback a bit more, pull on the seatback folding lever while pushing the top of the rear seatback towards the rear. Then release the lever and make sure that the rear seat is firmly locked.

⚠ WARNING

Uprighting seat

When you return the seatback to its upright position, hold the seatback and return it slowly. If the seatback is returned without holding it, the back of the seat could spring forward, resulting in injury caused by being struck by the seatback.

⚠ WARNING

Rear seatback

When returning the rear seat to the upright position:

- Be careful not to damage the seat belt webbing or buckle.
- Do not allow the seat belt webbing or buckle to become pinched or caught in the rear seat.
- Ensure the seatback is completely locked into its upright position by pushing on the top of the seatback. Failure to adhere to any of these instructions could result in serious injury or death in the event of a crash.

⚠ CAUTION

Damaging rear seat belt buckles

When you fold the rear seatback, insert the buckle between the rear seatback and cushion. Doing so can prevent the buckle from being damaged by the rear seatback.

⚠ CAUTION

Rear seat belts

When returning the rear seatbacks to the upright position, remember to return the rear shoulder belts to their proper position.

⚠ WARNING

Unless the driver's position is properly set according to the driver's physical figure, do not fold the rear seat. It may increase bodily injuries in a sudden stop or collision.

⚠ CAUTION

Be careful when loading cargo through the rear passenger seats to prevent damage to the vehicle interior.

⚠ WARNING**Cargo**

Cargo should always be secured to prevent it from being thrown about the vehicle in a collision and causing injury to the vehicle occupants. Do not place objects in the rear seats, since they cannot be properly secured and may hit the front seat occupants in a collision.

Cargo loading

Make sure the engine is off, the transmission is in P (Park) and the parking brake is securely applied whenever loading or unloading cargo. Failure to take these steps may allow the vehicle to move if the shift lever is inadvertently moved to another position.

Seat belts

Seat belts are designed to bear upon the bony structure of the body, and should be worn low across the front of the pelvis, chest and shoulders.

Seat belt restraint system

For maximum restraint system protection, the seat belts must always be used whenever the vehicle is moving.

- A properly positioned shoulder belt should be positioned midway over your shoulder, across your collarbone.
- Never allow children to ride in the front passenger seat. See "Child Restraint System (CRS)" on page 4-27 for further discussion.

⚠ WARNING**Twisted seat belt**

Make sure your seat belt is not twisted when worn. A twisted seat belt may not properly protect you in an accident and could even cut into your body.

⚠ WARNING**Shoulder Belt**

- Never wear the shoulder belt under your arm or behind your back. An improperly positioned shoulder belt cannot protect the occupant in the event of a crash.
- Always wear both the shoulder portion and lap portion of the lap/shoulder belt.

⚠ WARNING**Damaged seat belt**

Any damage in webbing or hardware may lead to serious injury or death in a crash. For your safety, replace the entire

seat belt assembly when any part of the webbing or hardware is damaged.

Seat belts are designed to bear upon the bony structure of the body, and should be worn low across the front of the pelvis, chest and shoulders, as applicable; wearing the lap section of the belt across the abdominal area must be avoided.

Seat belts should be adjusted as firmly as possible, consistent with comfort, to provide the protection for which they have been designed.

A slack belt will greatly reduce the protection afforded to the wearer.

Care should be taken to avoid contamination of the webbing with polishes, oils and chemicals, and particularly battery acid. Cleaning may safely be carried out using mild soap and water. The belt should be replaced if webbing becomes frayed, contaminated or damaged.

- No modifications or additions should be made by the user which would either prevent the seat belt adjusting devices from operating to remove slack, or prevent the seat belt assembly from being adjusted to remove slack.
- When you fasten the seat belt, be careful not to latch the seat belt in buckles of other seats. It is very dangerous and you may not be protected by the seat belt properly.
- When fastening the seat belt, make sure that the seat belt does not pass over objects that are hard or can break easily.

⚠ WARNING

Seat belt buckle

Do not allow foreign material (gum, crumbs, coins, liquids, etc.) to obstruct the seat belt buckle. This may prevent the seat belt from fastening securely.

⚠ WARNING

Do not unfasten the seat belt and do not fasten and unfasten the seat belt repeatedly while driving. This could result in loss of control, and an accident causing death, serious injury, or property damage.

Seat belt warning



The seat belt warning light and warning chime operate under the following conditions.

Driver's seat belt warning

As a reminder to the driver, the driver's seat belt warning lights will illuminate and the warning chime will sound for approximately 6 seconds each time you turn the ENGINE START/STOP button ON regardless of belt fastening.

If you start to drive without the seat belt fastened over 5 mph (9 km/h) and less than 12 mph (20 km/h), the corresponding warning light will illuminate. The warning light will turn off when the vehicle speed drops below 5 mph (9 km/h).

When the seat belt is unfastened during driving,

1. The warning light will illuminate when the speed is over 5mph (9km/h) and less than 12 mph (20 km/h).
2. When the speed is 12 mph (20 km/h) and faster, the warning light will blink and warning chime will sound for approximately 100 seconds.

Front passenger's seat belt warning

As a reminder to the driver, the passenger's seat belt warning lights will illuminate for approximately 6 seconds each time you turn the ENGINE START/STOP button ON regardless of belt fastening. If you start to drive without the seat belt fastened over 5 mph (9 km/h) and less than 12 mph (20 km/h), the corresponding warning light will illuminate. The warning light will turn off when the vehicle speed drops below 5 mph (9 km/h). If you start to drive without the seat belt fastened when you drive 12 mph (20 km/h) and faster, the warning light will blink and warning chime will sound for approximately 100 seconds.

When the seat belt is unfastened during driving,

1. The warning light will illuminate when the speed is over 5mph (9km/h) and less than 12 mph (20 km/h).
2. When the speed is 12 mph (20 km/h) and faster, the warning light will blink and warning chime will sound for approximately 100 seconds.

* NOTICE

- Even if the front passenger seat is not occupied, the seat belt warning light will appear for approximately 6 seconds.

- The front passenger's seat belt warning may operate when luggage is placed on the front passenger seat.

Rear passenger's seat belt warning



- Rear seat: (1) Driver's side, (2) Center, (3) Passenger's side

As a reminder to the rear passenger, the rear passenger's seat belt warning light will appear for approximately 6 seconds each time you turn the ENGINE START/STOP button ON regardless of belt fastening.

If you start to drive without the seat belt fastened, the seat belt warning light will appear for approximately 70 seconds.

If you unfasten the seat belt when you drive under 12 mph (20 km/h), the seat belt warning light will appear for approximately 70 seconds.

If you unfasten the seat belt when you drive over 12 mph (20 km/h), the seat belt warning chime will sound for approximately 35 seconds and the corresponding warning light will blink.

If the rear door is opened or closed under 6 mph (10 km/h), warning light and warning sound do not work even if driving over 12 mph (20 km/h).

*** NOTICE**

- Even if the front passenger seat is not occupied, the seat belt warning light will appear for approximately 6 seconds.
- The rear side passenger's seat belt warning may operate when luggage, laptop or, other electronic device is placed on the rear side passenger seat.

Seat belt - Driver's 3-point system with emergency locking retractor

The following explains how to fasten and adjust the driver's seat belt.

Fastening the seat belt:



- Pull it out of the retractor and insert the metal tab (1) into the buckle (2). There will be an audible "click" when the tab locks into the buckle.

⚠ WARNING

You should place the lap belt portion as low as possible and snugly across your hips. If the lap belt is located too high on your waist, it may increase the chance of injury in the event of a collision.



The arm closest to the seat belt buckle should be over the belt while the other arm should be under the belt as shown in the illustration. Never wear the seat belt under the arm closest to the door.

The seat belt automatically adjusts to the proper length only after the lap belt portion is adjusted manually so that it fits snugly around your hips. If you lean forward in a slow, easy motion, the belt will extend and let you move around. If there is a sudden stop or impact, however, the belt will lock into position. It will also lock if you try to lean forward too quickly.

*** NOTICE**

If you are not able to pull out the seat belt from the retractor, firmly pull the belt out and release it. Then you will be able to pull the belt out smoothly.

Adjusting the height of shoulder belt

You can adjust the height of the shoulder belt anchor to one of the 4 positions for maximum comfort and safety.



The height of the adjusted seat belt should not be too close to your neck. The shoulder portion should be adjusted so that it lies across your chest and mid-way over your shoulder near the door and not your neck.

To adjust the height of the seat belt anchor, lower or raise the height adjuster into an appropriate position.

- To raise the height adjuster, pull it up (1).
- To lower it, push it down (3) while pressing the height adjuster button (2).

Release the button to lock the anchor into position. Try sliding the height adjuster to make sure that it has locked into position.

Improperly positioned seat belts can cause serious injuries in an accident.

WARNING

Shoulder belt positioning

Verify the shoulder belt anchor is locked into position at the appropriate height. Never position the shoulder belt across your neck or face. Improperly positioned seat belts can cause serious injuries in an accident.

WARNING

Seat belt replacement

After a collision, the seat belt system should be inspected to ensure it is operating normally. Replace any belts that are not functioning appropriately.

Seat belts - Front passenger and rear seat 3-point system with combination locking retractor

The following explains how to fasten the passenger's and rear seat belts.

Fastening your seat belt:

Combination retractor type seat belts are installed in the rear seat positions to help accommodate the installation of Child Restraint System. Although a combination retractor is also installed in the front passenger seat position, it is strongly recommended that children always be seated in the rear seat. NEVER

place any infant restraint system in the front seat of the vehicle.

This type of seat belt combines the features of both an emergency locking retractor seat belt and an automatic locking retractor seat belts.

- Pull it out of the retractor and insert the metal tab into the buckle. There will be an audible "click" when the tab locks into the buckle. When not securing a child restraint, the seat belt operates in the same way as the driver's seat belt (emergency locking retractor type).

It automatically adjusts to the proper length only after the lap belt portion of the seat belt is adjusted manually so that it fits snugly around your hips.

When the seat belt is fully extended from the retractor to allow the installation of a Child Restraint System, the seat belt operation changes to allow the belt to retract, but not to extend (automatic locking retractor type). Refer to "Securing a child restraint with a lap/shoulder belt" on page 4-33.

NOTICE

Although the combination retractor provides the same level of protection for seated passengers in either emergency or automatic locking modes, have the seated passengers use the emergency locking feature for improved convenience. The automatic locking function is intended to facilitate child restraint installation. To convert from the automatic locking feature to the emergency locking operation mode, allow the unbuckled seat belt to fully retract.

⚠ CAUTION

Do NOT fold down the left portion of the rear seatback when the rear center seat belt is buckled. ALWAYS UNBUCKLE the rear center seat belt before folding down the left portion of the rear seatback. If the rear center seat belt is buckled when the left portion of the rear seatback is folded down, distortion and damage to the top portion of the seatback and seat belt garnish may result, causing the seatback to lock into the folded down position.

The seat belt should be locked into the buckle on each seat cushion to be properly fastened.



- 1 Rear right seat belt fastening buckle
- 2 Rear center seat belt fastening buckle
- 3 Rear left seat belt fastening buckle

⚠ WARNING

Prior to fastening the rear seat belts, ensure the latch matches the seat belt buckle. Forcefully fastening the left or right seat belt to the center buckle can result in an improper fastening scenario that will not protect you in an accident.

When using the rear center seat belt, the buckle with the "CENTER" mark must be used.



Stowing the rear seat belt

The rear seat belt buckles can be stowed in the pocket between the rear seatback and cushion when not in use.



- 1. Route the seat belt webbing through the rear seat belt guides. It will help keep the belts from being trapped behind or under the seats.
- 2. After inserting the seat belt, tighten the belt webbing by pulling it up.

⚠ CAUTION

When pulling out to wear the seat belt, the tongue should be slowly pulled out of the seat belt guide so that the seat belt guide does not come off the trim.

Releasing the seat belt:



- The seat belt is released by pressing the release button (1) on the locking buckle.

When it is released, the belt should automatically draw back into the retractor.

If this does not happen, check the belt to make sure it is not twisted, then try again.

Pre-tensioner seat belt

Your Kia is equipped with pre-tensioner seat belts for the front driver and passenger, as well as the rear passengers (except the center).



The pre-tensioner seat belts may be activated, when a frontal collision is severe enough, together with the air bags.

When the vehicle stops suddenly, or if the occupant tries to lean forward too quickly, the seat belt retractor may lock into position. In certain frontal collisions, the pre-tensioner will activate and pull the seat belt into tighter contact against the occupant's body.

1 Retractor Pre-tensioner

The purpose of the retractor pre-tensioner is to make sure that the shoulder belts fit in tightly against the occupant's upper body in certain frontal collisions.

2 EFD (Emergency Fastening Device) (if equipped)

The purpose of the EFD is to make sure that the pelvis belts fit in tightly against the occupant's lower body in certain frontal collisions.

If the system senses excessive tension on the front driver, front passenger, and rear passenger seat belts (except center) when the pre-tensioner system activates, the load limiter inside the retractor pre-tensioner will release some pressure on the affected seat belt.

* NOTICE

When the pre-tensioner seat belts are activated, a loud noise may be heard and fine dust, which may appear to be smoke, may be visible in the passenger compartment. These are normal operating conditions and are not hazardous.

The seat belt pre-tensioner system consists mainly of the following components. Their locations are shown in the illustration:

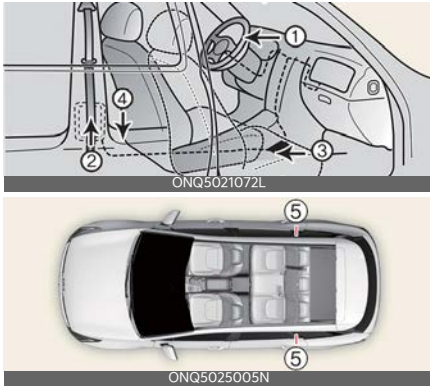

* The actual position of seat belt pre-tensioner system components may differ from the illustration.

- 1 SRS air bag warning light
- 2 Front retractor pre-tensioner assembly
- 3 SRS control module
- 4 Emergency fastening device (EFD)
- 5 Rear retractor pre-tensioner assembly

⚠ WARNING

Skin Irritation

Wash all exposed skin areas thoroughly after an accident in which the pre-tensioner seat belts were activated. The fine dust from the pre-tensioner activation may cause skin irritation and should not be inhaled for prolonged periods.

*** NOTICE**

- Both the driver's and front passenger's seat belt pre-tensioner systems may be activated not only in certain frontal collisions, but also in certain side collisions or rollovers, if the vehi-

cle is equipped with a side or curtain air bag.

- Because the sensor that activates the SRS air bag is connected with the pre-tensioner seat belt, the SRS air bag warning light  on the instrument panel will appear for approximately 6 seconds after the ENGINE START/STOP button has been turned to the "ON" position and then it should turn off.
- If the pre-tensioner seat belt system is not working properly, this warning light will appear even if there is not a malfunction with the SRS air bag. If the SRS air bag warning light does not illuminate when the ENGINE START/STOP button is turned to ON, or if it remains illuminated after appearing for approximately 6 seconds, or if it appears while the vehicle is being driven, have an authorized Kia dealer inspect the pre-tensioner seat belt and SRS air bag system as soon as possible.

*** NOTICE**

Do not attempt to service or repair the pre-tensioner seat belt system in any manner. Do not attempt to inspect or replace the pre-tensioner seat belts yourself. This must be done by an authorized Kia dealer.

⚠ WARNING

Hot pre-tensioner

Do not touch the pre-tensioner seat belt assemblies for several minutes after they have been activated. When the pre-tensioner seat belt mechanism fires

during a collision the pre-tensioner becomes hot and can burn you.

Pre-tensioners are designed to operate only one time. After activation, pre-tensioner seat belts must be replaced. If the pre-tensioner must be replaced, contact an authorized Kia dealer.

Seat belt precautions

Take the following precautions when using seat belts.

Infant or small child

All 50 states have child restraint laws. You should be aware of the specific requirements in your state. Child and/or infant seats must be properly placed and installed in the rear seat. For more information about the use of these restraints, refer to "Child Restraint System (CRS)" on page 4-27.

* NOTICE

Small children are best protected from injury in an accident when properly restrained in the rear seat by a Child Restraint System that meets the requirements of the Federal Motor Vehicle Safety Standards (FMVSS). Before buying any Child Restraint System, make sure that it has a label certifying that it meets Federal Motor Vehicle Safety Standard 213. The restraint must be appropriate for your child's height and weight. Check the label on the child restraint for this information. Refer to "Child Restraint System (CRS)" on page 4-27.

Larger children

Children who are too large for Child Restraint System should always occupy the rear seat and use the available lap/shoulder belts. The lap portion should be fastened and snug on the hips as low as possible. Check periodically to ensure that the belt fits. A child's squirming could put the belt out of position. Children are given the most safety in the event of an accident when they are restrained by a proper restraint system in the rear seat. If a larger child (over age 13) must be seated in the front seat, the child should be securely restrained by the available lap/shoulder belt and the seat should be placed in the rearmost position. Children age 13 and under should be restrained securely in the rear seat. NEVER place a child age 13 and under in the front seat. NEVER place a rear facing child seat in the front seat of a vehicle.

If the shoulder belt portion slightly touches the child's neck or face, try placing the child closer to the center of the vehicle. If the shoulder belt still touches their face or neck they need to be returned to a Child Restraint System.

⚠ WARNING

Small children

Do not allow small children to ride in the vehicle without an appropriate Child Restraint System. If the shoulder belt comes in contact with your child's neck or face, your child is too small to ride in the vehicle. In a crash, the seat belt will inflict injury to your child's neck, throat and face.

Restraint of pregnant women

Pregnant women should wear lap/shoulder belt assemblies whenever possible according to specific recommendations by their doctors. The lap portion of the belt should be worn AS SECURELY AND LOW AS POSSIBLE.

WARNING

Pregnant women

Pregnant women must never place the lap portion of the seat belt above or on the abdomen where the fetus is located. The force of the seat belt during a collision will crush the fetus.

Injured person

A seat belt should be used when an injured person is being transported. When this is necessary, you should consult a physician for recommendations.

One person per belt

Two people (including children) should never attempt to use a single seat belt. This could increase the severity of injuries in case of an accident.

Do not lie down

To reduce the chance of injuries in the event of an accident and to achieve maximum effectiveness of the restraint system, all passengers should be sitting up and the front and rear seats should be in an upright position when the vehicle is moving. A seat belt cannot provide proper protection if the person is lying down in the rear seat or if the front and rear seats are in a reclined position.

Care of seat belts

Seat belt systems should never be disassembled or modified. In addition, care should be taken to assure that seat belts and belt hardware are not damaged by seat hinges, doors or other abuse.

WARNING

Pinched seat belt

Make sure that the webbing and/or buckle does not get caught or pinched in the rear seat when returning the rear seatback to its upright position. A caught or pinched webbing/buckle may become damaged and could fail during a collision or sudden stop.

WARNING

Seat belts can become hot in a vehicle that has become hot or been in the sun. Please handle with care to avoid burns to infants, children, and people with limited sensation.

Periodic inspection

All seat belts should be inspected periodically for wear or damage of any kind. Any damaged parts should be replaced as soon as possible.

Keep belts clean and dry

Seat belts should be kept clean and dry. If belts become dirty, they can be cleaned by using a mild soap solution and warm water. Bleach, dye, strong detergents or abrasives should not be used because they may damage and weaken the fabric.

When to replace seat belts

The entire in-use seat belt assembly or assemblies should be replaced if the vehicle has been involved in an accident. This should be done even if no damage is visible. Additional questions concerning seat belt operation should be directed to an authorized Kia dealer.

Child Restraint System (CRS)

Infants and younger children must be restrained in an appropriate rear-facing or forward-facing Child Restraint System (CRS) that has first been properly secured to the rear seat of the vehicle. Please refer to your state or federal laws for child seating requirements in the operation of a motor vehicle.

Children always in the rear

Children under age 13 must always ride in the rear seats and must always be properly restrained to minimize the risk of injury in an accident, sudden stop or sudden maneuver.

WARNING

Restraint Location

Never install a child or infant seat on the front passenger's seat. A child riding in the front passenger seat can be forcefully struck by an inflating air bag and get seriously injured.

WARNING

Hot Child Restraint

A Child Restraint System can become very hot if it is left in a closed vehicle on a sunny day. Be sure to check the seat cover, buckles and latches before placing a child in the restraint system.

According to accident statistics, children are safer when properly restrained in the rear seats than in the front seat. Even with air bags, children can be seriously injured or killed. Children too large for a child restraint must use the seat belts provided.

All 50 states have child restraint laws which require children to travel in approved child restraint devices. The

laws governing the age or height/weight restrictions at which seat belts can be used instead of child restraints differ among states, so you should be aware of the specific requirements in your state, and where you are traveling.

The CRS must be properly placed and installed in the rear seat. You must use a commercially available CRS that meets the requirements of the Federal Motor Vehicle Safety Standards (FMVSS).

A CRS is generally designed to be secured in a vehicle seat by lap belt portion of a lap/shoulder belt, or by a LATCH system in the rear seats of the vehicle.

Child Restraint System (CRS)

Infants and younger children must be restrained in an appropriate rear-facing or forward-facing CRS that has first been properly secured to the rear seat of the vehicle. Read and comply with the instructions for installation and use provided by the manufacturer of the CRS.

Child Restraint Installation

An improperly secured child restraint can increase the risk of serious injury or death in an accident. Always take the following precautions when using a Child Restraint System:

- Always follow the Child Restraint System manufacturer's instructions for installation and use.
- Always properly restrain your child in the child restraint.
- If the vehicle head restraint prevents proper installation of a child seat (as described in the Child Restraint System manual), the head restraint of the

respective seating position shall be readjusted or entirely removed.

- Do not use an infant carrier or a child safety seat that "hooks" over a seat-back as it may not provide adequate protection in an accident.
- A child restraint in the center seating position may also contact or push up against the safety belt buckles, which can damage the buckles and make them unusable or unsafe. Always check that the child restraint does not contact any of the safety belt buckles. Check the placement of the child restraint regularly to make sure that it has not shifted and come into contact with any of the safety belt buckles.

* NOTICE

After an accident, have a Kia dealer check the Child Restraint System, seat belts, tether anchors and lower anchors.

Selecting a CRS

When selecting a CRS for your child, always:

- Make sure the CRS has a label certifying that it meets applicable Federal Motor Vehicle Safety Standards (FMVSS 213).
- Select a child restraint based on your child's height and weight. The required label or the instructions for use typically provide this information.
- Select a child restraint that fits the vehicle seating position where it will be used. Refer to the child seat and the child seat manufacturer's instructions for additional instructions.
- Read and comply with the warnings and instructions for installation and use provided with the CRS.

- The American Academy of Pediatrics provides helpful fit and safety information about child restraints at www.healthychildren.org.

⚠ WARNING

Holding children

Never hold a child in your arms or lap when riding in a vehicle. The violent forces created during a crash will tear the child from your arms and throw the child against the car's interior. Always use a Child Restraint System which is appropriate for your child's height and weight.

⚠ WARNING

Unattended children, the elderly or pets

An enclosed vehicle can become extremely hot, causing death or severe injury such as heatstroke to unattended children, the elderly or pets who cannot escape the vehicle. When left or trapped in a hot vehicle, make sure to stay hydrated and avoid sun exposure through the vehicle's windshield.

Furthermore, children might operate features of the vehicle that could injure them, or they could encounter other harm, possibly from someone gaining entry to the vehicle. Never leave children or animals unattended in your vehicle.

⚠ WARNING

Seat belt use

Do not use one seat belt for two occupants at the same time. This will eliminate any safety benefit provided by the seat belt to the occupants.

CRS types

There are three main types of CRS: rear-facing seats, forward-facing seats, and booster seats. They are classified according to the child's age, height and weight.

Rear-facing child seats



A rear-facing child seat provides restraint with the seating surface against the back of the child. The harness system holds the child in place, and in an accident, acts to keep the child positioned in the seat and reduces the stress to the neck and spinal cord.

All children under age one must always ride in a rear-facing infant child restraint. Convertible and 3-in-1 child seats typically have higher height and weight limits for the rear-facing position, allowing you to keep your child rear-facing for a longer period of time.

Continue to use a rear-facing child seat for as long as your child will fit within the height and weight limits allowed by the child seat manufacturer. It's the best way to keep them safe. Once your child has

outgrown the rear-facing child restraint, your child is ready for a forward-facing child restraint with a harness.

Forward-facing child restraints



A forward-facing child seat provides restraint for the child's body with a harness. Keep children in a forward-facing child seat with a harness until they reach the top height or weight limit allowed by your child restraint's manufacturer.

Once your child outgrows the forward-facing child restraint, your child is ready for a booster seat.

Booster seats

A booster seat is a restraint designed to improve the fit of the vehicle's seat belt system. A booster seat positions the seat belt so that it fits properly over the lap of your child.

Keep your child in a booster seat until they are big enough to sit in the seat without a booster and still have the seat belt fit properly. For a seat belt to fit properly, the lap belt must lie snugly across the upper thighs, not the stomach. The shoulder belt should lie snug across the shoulder and chest and not across the neck or face. Children under age 13 must always ride in the rear seats and must always be properly restrained to minimize the risk of injury.

Installing a CRS

After selecting a proper child seat for your child, check to make sure it fits properly in your vehicle.

Follow the instructions provided by the manufacturer when installing the child seat. Note these general steps when installing the seat to your vehicle:

- **Properly secure the child restraint to the vehicle.** All child restraints must be secured to the vehicle with the lap part of a lap/shoulder belt or with the LATCH system.
- **Make sure the child restraint is firmly secured.** After installing a child restraint to the vehicle, push and pull the seat forward and from side-to-side to verify that it is securely attached to the seat. A child restraint secured with a seat belt should be installed as firmly as possible. However, some side-to-side movement can be expected.
- **Secure the child in the child restraint.** Make sure the child is properly strapped in the child restraint according to the manufacturer instructions.

Lower Anchors and Tether for Children (LATCH) system

The LATCH system holds a child restraint during driving and in an accident. This system is designed to make installation of the child restraint easier and reduce the possibility of improperly installing your child restraint. The LATCH system uses anchors in the vehicle and attachments on the child restraint. The LATCH system eliminates the need to use seat belts to secure the child restraint to the rear seats.

Lower anchors are metal bars built into the vehicle. There are two lower anchors for each LATCH seating position that will accommodate a child restraint with lower attachments.

To use the LATCH system in your vehicle, you must have a child restraint with LATCH attachments.

The child seat manufacturer will provide you with instructions on how to use the child seat with its attachments for the LATCH lower anchors.



LATCH anchors have been provided in the left and right outboard rear seating positions. Their locations are shown in the illustration. There are no LATCH anchors provided for the center rear seating position.

⚠ WARNING

LATCH Lower Anchors

Never attempt to attach a LATCH equipped seat in the center seating position. LATCH lower anchors are only to be used in the left and right rear outboard seating positions. You may damage the anchors or the anchors may fail and break in a collision if the seat is in the center seating position.

The lower anchor position indicator symbols are located on the left and right rear seatbacks to identify the position of the lower anchors in your vehicle (see arrows in illustration).

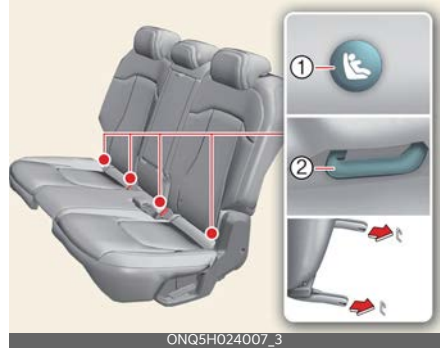

1 Lower Anchor position indicator

2 Lower Anchor

The LATCH anchors are located between the seatback and the seat cushion of the rear seat left and right outboard seating positions.

To use the lower anchor, push the upper portion of the lower anchor cover.

Securing a child restraint with the LATCH anchors system

To install a LATCH-compatible child restraint in either of the rear outboard seating positions:

1. Move the seat belt buckle away from the lower anchors. Otherwise, the webbing or buckle can be damaged by the latch anchor, which can make them become unusable or unsafe.
2. Move any other objects away from the anchors that could prevent a secure connection between the child restraint and the lower anchors.
3. Place the child restraint on the vehicle seat, then attach the seat to the lower anchors according to the instructions

provided by the child restraint manufacturer.

4. Follow the child restraint instructions for properly adjusting and tightening the lower attachments on the child restraint to the lower anchors.

⚠ WARNING

Take the following precautions when using the LATCH system:

- Read and follow all installation instructions provided with your Child Restraint System.
- To prevent the child from reaching and taking hold of the unused seat belts, buckle all unused rear seat belts before the child is placed into the vehicle. Lock each unused seatbelt following the instructions in the "automatic locking mode" subsection, and place the webbing behind the child seat or against an unused seatback. Children can be strangled if a shoulder belt becomes wrapped around their neck and the seat belt tightens.
- NEVER attach more than one child restraint to a single anchor. This could cause the anchor or attachment to come loose or break.
- Always have the LATCH system inspected by your authorized Kia dealer after an accident. An accident can damage the LATCH system and may not properly secure the child restraint.

*** NOTICE**

The recommended maximum weight for the LATCH system is 65 lbs. (30 kg). When selecting a proper child restraint, consider that the maximum total weight of the child plus the child restraint should be less than 65 lbs. (30 kg).

As a guide, the MAX child restraint weight should be determined by the following calculation:

$$\text{Child Restraint Weight} = 65 - (\text{child's total weight in lbs.})$$

Securing a child restraint seat with "Tether Anchor" system



First secure the child restraint with the LATCH lower anchors or the seat belt. If the child restraint manufacturer recommends that the top tether strap be attached, attach and tighten the top tether strap to the top tether strap anchor.

Child Restraint hook holders are located on the seatback.

⚠ WARNING

Take the following precautions when installing the tether strap:

- Read and follow all installation instructions provided with your Child Restraint System.
- NEVER attach more than one child restraint to a single tether anchor. This could cause the anchor or attachment to come loose or break.
- Do not attach the tether strap to anything other than the correct tether anchor. It may not work properly if attached to something else.
- Do not use the tether anchors for adult seat belts or harnesses, or for attaching other items or equipment to the vehicle.

- Always fasten the seat belts behind the child restraint seat when they are not used to secure the child seat. Failure to do so may result in child strangulation.

To install the tether anchor:



1. Route the Child Restraint System seat strap over the seatback.
For vehicles with adjustable headrest, route the tether strap under the headrest and between the headrest posts, otherwise route the tether strap over the top of the seatback.
2. Connect the tether to the tether anchorage, then tighten the tether according to the instructions of your Child Restraint System's manufacturer to firmly attach the Child Restraint System to the seat.
3. Check that the child restraint is securely attached to the seat by pushing and pulling the seat forward and from side-to-side.

Securing a child restraint with a lap/shoulder belt

When not using the LATCH system, all child restraints must be secured to a vehicle rear seat with the lap part of a lap/shoulder belt.

Automatic locking mode



All passenger seat belts move freely under normal conditions and only lock under extreme or emergency conditions (emergency locking mode). So, in order to secure a child restraint, you must manually pull the seat belt all the way out to shift the retractor to the "automatic locking" mode.

The "automatic locking" mode will help prevent the normal movement of the child in the vehicle from causing the seat belt to loosen and compromise the CRS. To install a CRS on the rear seats, do the following:

1. Place the CRS on a rear seat and route the lap/shoulder belt around or through the child restraint, following the restraint manufacturer's instructions.
Be sure the seat belt webbing is not twisted.

- Fasten the lap/shoulder belt latch into the buckle. Listen for the distinct "click" sound.
Position the release button so that it is easy to access in case of an emergency.



- Pull the shoulder portion of the seat belt all the way out. When the shoulder portion of the seat belt is fully extended, it will shift the retractor to the "automatic locking" (child restraint) mode.



- Slowly allow the shoulder portion of the seat belt to retract and listen for an audible "clicking" or "ratcheting" sound. This indicates that the retractor is in the "automatic locking" mode. If no distinct sound is heard, repeat steps 3 and 4.



- Remove as much slack from the belt as possible by pushing down on the CRS while feeding the shoulder belt back into the retractor.

- Push and pull on the CRS to confirm that the seat belt is holding it firmly in place. If it is not, release the seat belt and repeat steps 2 through 6.
- Double check that the retractor is in the "automatic locking" mode by attempting to pull more of the seat belt out of the retractor. If you cannot, the retractor is in the "automatic locking" mode.

If your CRS manufacturer instructs or recommends you to use a tether anchor with the lap/shoulder belt, refer to "Securing a child restraint with the LATCH anchors system" on page 4-31 for more information.

*** NOTICE**

When the seat belt is allowed to retract to its fully stowed position, the retractor will automatically switch from the "automatic locking" mode to the emergency lock mode for normal adult usage.

⚠ WARNING

Auto lock mode

Set the retractor to Automatic Lock mode when installing any Child Restraint System. If the retractor is not in the automatic locking mode, the child restraint can move when your vehicle turns or stops suddenly. A child can be seriously injured or killed if the child restraint is not properly anchored in the car.

To remove the child restraint, press the release button on the buckle and then pull the lap/shoulder belt out of the restraint and allow the seat belt to retract fully.

Air bag - advanced Supplemental Restraint System

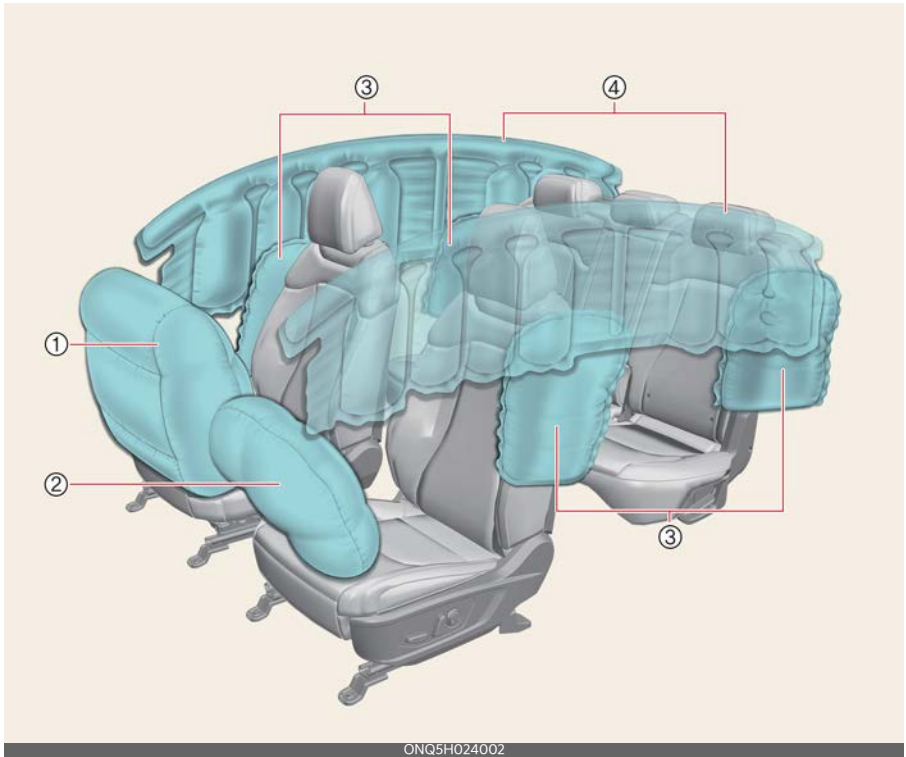

* The actual air bags in the vehicle may differ from the illustration.

- 1 Passenger's front air bag
- 2 Driver's front air bag
- 3 Side air bag
- 4 Curtain air bag

Even in vehicles with air bags, you and your passengers must always wear the safety belts provided in order to minimize the risk and severity of injury in the event of a collision or rollover.

How does the air bag system operate?

- Air bags are activated (able to inflate if necessary) only when the ENGINE START/STOP button has been turned to the ON position.
- The appropriate air bags inflate instantly in the event of a serious frontal collision or side collision in order to help protect the occupants from serious physical injury.
- There is no single speed at which the air bags will inflate. Generally, air bags are designed to inflate based upon the severity of a collision and its direction, etc. Several factors determine whether the sensors produce an electronic deployment/inflation signal.
- Air bags will not deploy in every crash or collision situations. Air bag deployment depends on a number of factors including vehicle speed, angles of impact, and, the density and stiffness of the vehicles or objects which your vehicle hits in the collision. The determining factors are not limited to those mentioned above.
- The front air bags will completely inflate and deflate in an instant. It is virtually impossible for you to see the air bags inflate during an accident. It is much more likely that you will simply see the deflated air bags hanging out of their storage compartments after the collision.
- In addition to inflating in serious side collisions, side and/or curtain air bags will inflate if the sensing system detects a rollover.
- When a rollover is detected, side and/or curtain air bags will remain inflated longer. This helps provide protection

from ejection, especially when used in conjunction with the seat belts.

- In order to help provide protection, the air bags must inflate rapidly. The air bag inflates extremely fast between the occupant and the vehicle structures before the occupant impacts the vehicle structures. This speed of inflation reduces the risk of serious or life-threatening injuries and is thus a necessary part of the air bag design. However, air bag inflation can also cause injuries which can include facial abrasions, bruises and broken bones. This is because the rapid inflation also causes the air bags to expand with a great deal of force.
- **There are even circumstances under which contact with the steering wheel or passenger air bag can cause fatal injuries, especially if the occupant is positioned excessively close to the steering wheel or passenger air bag.**

WARNING

Air bag inflation

Sit as far back as possible from the steering wheel while still maintaining comfortable control of the vehicle. A distance of at least 10 in (25 cm) from your chest to the steering wheel is recommended. Failure to do so can result in air bag inflation injuries to the driver.

Noise and smoke

When inflated, the air bags make a loud noise and leave smoke and powder in the air inside the vehicle. This is normal and is a result of the ignition of the air bag inflator. After the air bag inflates, you may feel substantial discomfort in breathing due to the contact of your chest with both the seat belt and the air bag, as well as from breathing the smoke and powder. **Open your doors and/or windows as soon as possible after impact in order to reduce discomfort and prevent prolonged exposure to the smoke and powder.**

Though smoke and powder are non-toxic, it may cause irritation to the skin (eyes, nose, throat and so on). If this is the case, wash and rinse with cold water immediately and consult a doctor if the symptom persists.

⚠ WARNING

Hot components

Do not touch the air bag storage area's internal components immediately after air bag inflation. The air bag related parts in the steering wheel, instrument panel and the roof rails above the front and rear doors are very hot. Hot components can result in burn injuries.

⚠ WARNING

Do not install or place accessories over the air bag's location or in areas where the air bags will extend if deployed. They can interfere with the air bag or harm occupants during a deployment and can cause serious injury or death.

Do not install a child restraint on the front passenger's seat

Never place a rear-facing child restraint in the front passenger's seat.



If the air bag deploys, it would impact the rear-facing child restraint, causing serious or fatal injury.

In addition, do not place front-facing child restraints in the front passenger's seat. If the front passenger air bag inflates, it could cause serious or fatal injuries to the child.

⚠ WARNING

Air bag deployment

When children are seated in the rear outboard seats of a vehicle equipped with side and/or curtain air bags, install the Child Restraint System as far away from the door side as possible. Inflation of the side and/or curtain air bags could impact the child.

Air bag warning light

The purpose of air bag warning light in your instrument panel is to alert you of a potential problem with your air bag system, which could include your side and/or curtain air bags used for rollover protection.



If the air bag warning light appears for more than 6 seconds after the ENGINE START/STOP button has been turned to the ON position, or if it appears during vehicle operation, an SRS component may not be functioning properly and you should have your vehicle checked by an authorized Kia dealer.

If any of the following conditions occur, this indicates a malfunction in the air bag system. Have an authorized Kia dealer inspect the air bag system as soon as possible.

- The light does not turn on briefly when you turn the ENGINE START/STOP button to the ON position.
- The light stays on after appearing for approximately 6 seconds.
- The light comes on while the vehicle is in motion.
- The light blinks when the ENGINE START/STOP button to the ON position.

Supplemental Restraint System (SRS) components and functions

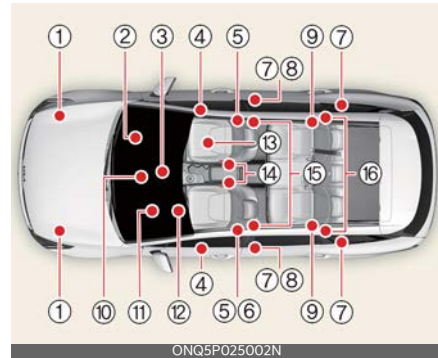

* The actual position of SRS components may differ from the illustration.

The SRS consists of the following components:

- 1 Front impact sensors
- 2 Passenger's front air bag module
- 3 SRS control module (SRSCM)/rollover sensor
- 4 Side pressure sensors
- 5 Front side air bag modules
- 6 EFD (Emergency Fastening Device)
- 7 Side impact sensors
- 8 Curtain air bag modules
- 9 Rear side air bag modules
- 10 Passenger's front air bag ON/OFF indicator (Over head console)
- 11 Air bag warning light
- 12 Driver's front air bag module
- 13 Occupant Detection System (ODS)
- 14 Front driver/passenger's seat belt buckle sensor
- 15 Front retractor pre-tensioner assemblies
- 16 Retractor pre-tensioner assemblies (rear side)

Driver's front air bag (1)



The front air bag modules are located both in the center of the steering wheel and in the front passenger's panel above the glove box. When the SRSCM detects a sufficiently severe impact to the front of the vehicle, it will automatically deploy the front air bags.

Driver's front air bag (2)



Upon deployment, tear seams molded directly into the pad covers will separate under pressure from the expansion of the air bags. Further opening of the covers then allows full inflation of the air bags.

Driver's front air bag (3)



A fully inflated air bag (with a properly fastened seat belt) slows the forward motion of the driver or passenger, reducing the risk of head and chest injury.

After complete inflation, the air bag immediately starts deflating, enabling the driver to maintain forward visibility and the ability to steer or operate other controls.

Passenger's front air bag



⚠ WARNING

Air bag obstructions

Do not install or place any accessories on the steering wheel, instrument panel, or on the front passenger's panel above the glove box in a vehicle. Such objects may become dangerous projectiles if the air bag deploys.

⚠ WARNING

Flying objects

Do not place any objects (an umbrella, bag, etc.) between the front door and the front seat. Such objects may become dangerous projectiles if the side air bag inflates.

- If an air bag deploys, there may be a loud noise followed by a fine dust released in the vehicle. These conditions are normal and are not hazardous - the air bags are packed in this fine powder. The dust generated during air bag deployment may cause skin or eye irritation as well as aggravate asthma for some persons. Always wash all exposed skin areas thoroughly with cold water and a mild

soap after an accident in which the air bags were deployed.

- The SRS can function only when the ENGINE START/STOP button is in the ON position. The SRS is not working properly if any of the following situations occur:
 - The SRS air bag warning light does not appear
 - The SRS air bag warning light remains on continuously after appearing for about 6 seconds when the ENGINE START/STOP button is turned to the ON position or after the vehicle is in ready mode
 - The SRS air bag warning light comes on while driving

If this occurs, have your vehicle immediately inspected by an authorized Kia dealer.

*** NOTICE**

Before you replace a fuse or disconnect a battery terminal, change the ENGINE START/STOP button to the OFF position. Never remove or replace the air bag related fuse(s) when the ENGINE START/STOP button is ON position. Failure to heed this warning will cause the SRS air bag warning light to appear.

Occupant Detection System (ODS)

Your vehicle is equipped with an Occupant Detection System (ODS) in the front passenger's seat.



The ODS is designed to detect the presence of a properly-seated front passenger and determine if the passenger's front air bag should be enabled (may inflate) or not. Only the front passenger front air bag is controlled by the ODS. Do not put anything in front of the passenger air bag "⊗" indicator.

Main components of the ODS

- A detection device is located within the front passenger seat cushion.
- An electronic system determines whether the passenger air bag systems should be activated or deactivated.
- An indicator light located on the overhead console which appears the words PASSENGER AIR BAG "⊗" indicates the front passenger air bag system is deactivated.
- The overhead console air bag warning light is interconnected with the ODS.

If the front passenger seat is occupied by a person that the system determines to be of sufficient mass, and he/she sits properly (sitting upright with the seat-back in an upright position, centered on the seat cushion with their seat belt on, legs comfortably extended and feet on

the floor), the PASSENGER AIR BAG



indicator will turn off and the front passenger's air bag will be able to inflate in frontal crashes.

You will find the PASSENGER AIR BAG



indicator on the overhead console.

This system detects the conditions 1-4 in the following table and activates or deactivates the front passenger air bag based on these conditions.

The ODS may not function properly if the passenger takes actions which can defeat the detection system. These include:

- Failing to sit in an upright position.
- Leaning against the door or center console.
- Sitting towards the sides or the front of the seat.
- Putting legs on the dashboard or resting them on other locations which reduce the passenger weight on the front seat.
- Improperly wearing the safety belt.
- Reclining the seatback.

Conditions and operation of the front passenger ODS

Condition detected by the occupant detection system	Indicator/Warning light		Devices
	"PASSENGER AIR BAG OFF" indicator light	SRS warning light	Front passenger air bag
1. Adult ¹	Off	Off	Activated
2. Child Restraint System (CRS) with child under 12 months old ^{2,3,4}	On	Off	Deactivated
3. Unoccupied	On	Off	Deactivated
4. Malfunction in the system	Off	On	Activated

- *1. The system judges a person of adult size as an adult. When a smaller adult sits in the front passenger seat, the system may recognize him/her as a child depending on his/her physique and posture.
- *2. Do not allow children to ride in the front passenger seat. When a larger child who has outgrown a CRS sits in the front passenger seat, the system may recognize him/her as an adult depending upon his/her physique or sitting position.
- *3. Never install a CRS on the front passenger seat.
- *4. The PASSENGER AIR BAG "" indicator may turn on or off when a child above 12 months to 12 years old (with or without a CRS) sits in the front passenger seat. This is a normal condition.

⚠ WARNING

- Do not install a child restraint seat in the passenger seat when the seat is heavily soaked with any type of liquid.
- Do not alter or remodel the Occupant Detection System (ODS). This may damage the system and prevent its proper function in a collision.

*** NOTICE**

- Do not use car seat cushions that cover up the surface of the seat and aftermarket manufactured passenger seat heaters.
- After conducting car interior cleaning using steam or detergent, the seat should be dried properly. Afterward, check for normal operation of the PASSENGER AIR BAG "OFF" and air bag warning lights.
- Any service related to the passenger seat and the ODS must be done at an authorized Kia dealership.
- After the passenger seat has been removed or installed for repair purposes, check for normal operation of the PASSENGER AIR BAG "⊗" and air bag warning lights with a person seated or not seated in the passenger seat.

⚠ WARNING

When the PASSENGER AIR BAG "⊗" symbol appears, the passenger air bag system will not operate. The passenger air bag system will operate when necessary if the symbol does not appear.

*** NOTICE**

Do not modify or replace the front passenger seat. Don't place anything on or attach anything such as a blanket, front seat cover or aftermarket seat heater to the front passenger seat. This can adversely affect the Occupant Detection System.

⚠ WARNING

ODS System

Riding in an improper position adversely affects the Occupant Detection System and may result in the deactivation of the front passenger air bag. It is important for the driver to instruct the passenger as to the proper seating instructions as contained in this manual.

- Do not place a heavy load in the front passenger seatback pocket or on the front passenger seat.



- Do not place feet on the front passenger seatback.



Safety features of your Kia

- Do not move your hips too forward in the seat.



- Never excessively recline the front passenger seatback.



- Never place feet on the dashboard.



- Never lean on the door or center console.
- Do not sit with your weight excessively skewing to the left or right on the front passenger seat.



Air bag - advanced Supplemental Restraint System

- Do not use car seat accessories, such as thick blankets and cushions, that cover up the car seat surface.



- Do not place electronic devices such as laptops or DVD players or heavy objects such as a large quantity of water bottles on the passenger seat.

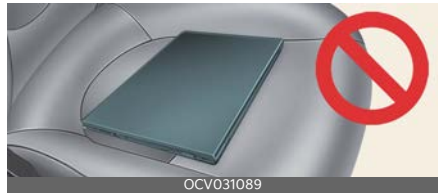

- Wet Passenger Seat

Do not spill liquid in the passenger seat. Spilled liquid on the passenger seat may cause the air bag warning light to appear or malfunction. If any liquid is spilled, make sure the seat has been completely dried before driving the vehicle.

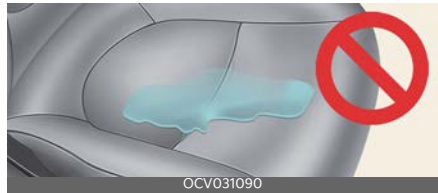

Proper position



OCV031081

When an adult is seated in the front passenger seat, if the PASSENGER AIR BAG "⊗" indicator is on, change the ENGINE START/STOP button to the OFF position and ask the passenger to sit properly (sitting upright with the seatback in an upright position, centered on the seat cushion with their seat belt on, legs comfortably extended and their feet on the floor). Restart the vehicle and have the person remain in that position. This will allow the system to detect the person and to enable the passenger air bag.

If the PASSENGER AIR BAG "⊗" indicator is still on, ask the passenger to move to the rear seat.

WARNING

PASSENGER AIR BAG "⊗" light

Do not allow an adult passenger to ride in the front seat when the PASSENGER AIR BAG "⊗" indicator appears, because the air bag will not deploy in the event of a crash. The driver must instruct the passenger to reposition himself in the seat. Failure to properly position yourself may lead to air bag deactivation resulting in air bag non-deployment in a collision. If the PASSENGER AIR BAG "⊗" indicator remains illuminated after the passenger repositions themselves properly and the car is restarted, it is recommended that passenger move to the rear seat because

the passenger's front air bag will not deploy.

*** NOTICE**

The PASSENGER AIR BAG "⊗" indicator appears for about 4 seconds after the ENGINE START/STOP button is turned to the ON position after the vehicle is started. If the front passenger seat is occupied, the occupant detection sensor will then classify the front passenger after several more seconds.

- Even though your vehicle is equipped with the Occupant Detection System, never install a Child Restraint System in the front passenger's seat. A deploying air bag can forcefully strike a child resulting in serious injuries or death.

Any child age 13 and under should ride in the rear seat. Children too large for child restraints should use the available lap/shoulder belts. No matter what type of crash, children of all ages are safer when restrained in the rear seat.

If the ODS is not working properly, the Supplemental Restraint System (SRS) air bag warning light on the instrument panel will appear because the passenger's front air bag is connected with the ODS. If there is a malfunction of the ODS the PASSENGER AIR BAG "⊗" indicator will not appear. In this case, the passenger's front air bag will inflate in frontal impact crashes even if there is no occupant in the front passenger seat.

Driver's and passenger's front air bag

Your vehicle is equipped with an advanced supplemental restraint (air bag) system and lap/shoulder belts at both the driver and passenger seating position.



The indication of the system's presence are the letters "AIR BAG" located on the air bag pad cover on the steering wheel and the passenger's side front panel pad above the glove box.

The Supplemental Restraint System (SRS) consists of air bags installed under the pad covers in the center of the steering wheel and the passenger's side front panel above the glove box.

The purpose of the SRS is to provide the vehicle's driver and/or the front passenger with additional protection than that offered by the seat belt system alone in case of a frontal impact of sufficient severity. The SRS uses sensors to gather information about the driver's and front passenger's seat belt usage and impact severity.

The seat belt buckle sensor determines if the front passenger's seat belt is fastened.

These sensors provide the ability to control the SRS deployment based on whether or not the seat belts are fastened, and how severe the impact is.

The advanced SRS offers the ability to control the air bag inflation with two levels. A first stage level is provided for

moderate-severity impacts. A second stage level is provided for more severe impacts.

According to the impact severity and seat belt usage, the SRS Control Module (SRSCM) controls the air bag inflation. Failure to properly wear seat belts can increase the risk or severity of injury in an accident.

Additionally, your vehicle is equipped with an Occupant Detection System (ODS) in the front passenger's seat. The ODS detects the presence of a passenger in the front passenger's seat and will turn off the front passenger's air bag under certain conditions. For more detail, see "Occupant Detection System (ODS)" on page 4-40.

⚠ WARNING

Modification to the seat structure can cause the air bag to deploy at a different level than should be provided.

Manufacturers are required by government regulations to provide a contact point concerning modifications to the vehicle for persons with disabilities, which modifications may affect the vehicle's advanced air bag system. That contact is Kia's toll-free Customer Assistance center at 1-800-333-4542(U.S. only). However, Kia does not endorse nor will it support any changes to any part or structure of the vehicle that could affect the advanced air bag system, including the ODS.

⚠ WARNING

Replacement/modifications

The front passenger seat, dashboard or door should not be replaced except by an authorized Kia dealer using original Kia parts designed for this vehicle and

model. Any other such replacement or modification could adversely affect the operation of the Occupant Detection System and your advanced air bags.

Advanced air bags are combined with pre-tensioner seat belts to help provide enhanced occupant protection in frontal crashes. Front air bags are not intended to deploy in collisions in which sufficient protection can be provided by the seat belt.

*** NOTICE**

Air bags can only be used once - have an authorized Kia dealer replace the air bag immediately after deployment.

Front air bags are not intended to deploy in side-impact, rear-impact or rollover crashes. However, when frontal deployment threshold is satisfied at side-impact, front air bags may deploy. In addition, front air bags will not deploy in frontal crashes below the deployment threshold.

▲ WARNING

SRS Wiring

Do not tamper with or disconnect SRS wiring or other components of the SRS system. Doing so could result in injury, due to accidental deployment of the air bags or by rendering the SRS inoperative.

▲ WARNING

No attaching objects

No objects (such as instrument panel cover, cellular phone holder, cup holder, perfume or stickers) should be placed over or near the air bag modules on the steering wheel, instrument panel, windshield glass, and the front passenger's

panel above the glove box. Such objects could cause harm if the vehicle is in a crash severe enough to cause the air bags to deploy.

To reduce the risk of serious injury and death, do not place any objects, arms, legs or feet over the air bag and do not place any objects between the air bag and yourself.

Additionally, never place or insert any object into any small opening near side air bag labels attached to the vehicle seats.

When the air bag deploys, the object may affect the deployment and result in unexpected accident or bodily harm.

Side air bag

Your vehicle is equipped with a side air bag in each front and rear seat.



* The actual air bags in the vehicle may differ from the illustration.

The purpose of the air bag is to provide the vehicle's driver and/or the front passenger and rear outboard passenger with additional protection than that offered by the seat belt alone.

- The side air bags are designed to deploy during certain side-impact col-

lisions, depending on the crash severity of impact.

- The side air bags may deploy on the side of the impact or on both sides.
- The side and/or curtain air bags on both sides of the vehicle will deploy if a rollover or possible rollover is detected.
- The side air bags are not designed to deploy in all side impact or rollover situations.

⚠ WARNING

Unexpected deployment

Avoid impact to the side impact air bag sensor when the ENGINE START/STOP button is ON to prevent unexpected deployment of the side air bag.

- The side air bag is supplemental to the driver's and the passenger's seat belt systems and is not a substitute for them. Therefore, your seat belts must be worn at all times while the vehicle is in operation.
- For best protection from the side air bag system and to avoid being injured by the deploying side air bag occupants should sit in an upright position with the seat belt properly fastened. The driver's hands should be placed on the steering wheel at the 9:00 and 3:00 positions. The passenger's arms and hands should be placed on their laps.

⚠ WARNING

Deployment

Do not install any accessories including seat covers, on the side or near the side air bag as this may affect the deployment of the side air bags.

- If the seat or seat cover is damaged, have the vehicle checked and repaired by an authorized Kia dealer. Inform the dealer that your vehicle is equipped with side air bags and an Occupant Detection System (ODS).

⚠ WARNING

Flying objects

Do not place any objects (an umbrella, bag, etc.) between the front door and the front seat. Such objects may become dangerous projectiles if the side air bag inflates.

⚠ WARNING

No attaching objects

- Do not place any objects over the air bag or between the air bag and yourself. Also, do not attach any objects around the area the air bag inflates such as the door, side door glass, front and rear pillar.
- Do not put any objects between the side air bag label and seat cushion. It could cause harm if the vehicle is in a crash severe enough to cause the air bags to deploy.
- Never place or insert any object into any small opening near side air bag labels attached to the vehicle seats. When the air bag deploys, the object may affect the deployment and result in unexpected accident or bodily harm.
- Do not install any accessories on the side or near the side air bags.

Curtain air bag

Curtain air bags are located along both sides of the roof rails above the front and rear doors.



* The actual air bags in the vehicle may differ from the illustration.

They are designed to help protect occupants in certain side impacts and to help prevent them from ejecting out of the vehicle as a result of a rollover, especially when the seatbelts are also in use.

- The curtain air bags are designed to deploy during certain side impact collisions, depending on the severity of impact. The curtain air bags on both sides of the vehicle will also deploy in certain rollover situations.
- The curtain air bags are not designed to deploy in all side impact or rollover situations.
- Depending upon the conditions, only one curtain air bag may deploy.

Do not allow the passengers to lean their heads or bodies against the doors, put their arms on the doors, stretch their arms out of the window or place objects between the doors and passengers when they are seated on seats equipped with side impact and/or curtain air bags.

* NOTICE

Never try to open or repair any components of the side and curtain air bag system. This should only be done by an authorized Kia dealer.

⚠ WARNING

No attaching objects

- Do not place any objects over the air bag. Also, do not attach any objects around the area the air bag inflates such as the door, side door glass, front and rear pillar, roof side rail.
- Do not hang hard, breakable, or heavy objects on the coat hooks for safety reasons.

Air bag collision sensors



* The actual shape and position of sensors may differ from the illustration.

- 1 Front impact sensors
- 2 Supplemental Restraint System (SRS) control module/rollover sensor
- 3 Side pressure sensors (front door)
- 4 Side impact sensors (B-pillar)
- 5 Side impact sensors (C-pillar)

WARNING

Air bag sensors

- Do not hit or allow any objects to impact the locations where air bags or sensors are installed.

This may cause unexpected air bag deployment, which could result in serious personal injury or death.

- If the installation location or angle of the sensors is altered in any way, the air bags may deploy when they should not or they may not deploy when they should.

Therefore, do not try to perform maintenance on or around the air bag sensors. Have the vehicle checked and repaired by an authorized Kia dealer.

- Do not handle or move the front impact sensors. Changing the position or angle of the sensor can interfere with the proper functioning of the air bag.

Problems may arise if the sensor installation angles are changed due to the deformation of the front bumper, front end module, body or front doors where side collision sensors are installed. Have the vehicle checked and repaired by an authorized Kia dealer.

Use only Kia Genuine Parts or those of an equivalent standard to install bumper guards or replace a bumper. If not, it may adversely affect your vehicle's collision and air bag deployment performance.

Why didn't my air bag go off in a collision? (Inflation and non-inflation conditions of the air bag)

There are many types of accidents in which the air bag would not be expected to provide additional protection.

These include rear impacts, second or third collisions in multiple impact accidents, as well as low speed impacts.

Air bag inflation conditions

Front air bags



Front air bags are designed to inflate in a frontal collision depending on several factors, including the severity of impact of the front collision.

Side and curtain air bags



* The actual air bags in the vehicle may differ from the illustration.

Side and/or curtain air bags are designed to inflate when an impact is detected by side collision sensors depending on several factors, including the severity of impact resulting from a side impact collision.

Also, the side and curtain air bags are designed to inflate when a rollover is detected by a rollover sensor.

Although the front air bags (driver's and front passenger's air bags) are primarily designed to inflate in frontal collisions, they may inflate in other types of collisions if the front impact sensors detect a sufficient frontal force in another type of impact.

Similarly, although side and curtain air bags are designed to inflate in certain side impact collisions, they may inflate in other types of collisions where a side force is detected by the sensors. For instance, side air bag and/or curtain air bags may inflate if rollover sensors indicate the possibility of a rollover occurring (even if none actually occurs) or in other situations, including when the vehicle is tilted while being towed.

Even if side and/or curtain air bags do not provide impact protection in a rollover, they will deploy to prevent ejection of occupants, especially those who are restrained with seat belts.

If the vehicle chassis is impacted by bumps or objects on unimproved roads, the air bags may deploy. Drive carefully on unimproved roads or on surfaces not designed for vehicle traffic to prevent unintended air bag deployment.

Air bag non-inflation conditions

- Air bags may not deploy in certain low-speed collisions where the air bag would not add any benefit beyond the protection already offered by the seat belts.



- Front air bags are not designed to inflate in rear collisions, because occupants are moved backward by the force of the impact. In this case, inflated air bags would not be able to provide any additional benefit.



- Front air bags may not inflate in side impact collisions, because passengers move in the direction of the collision. Thus, in side impacts, frontal air bag deployment would not provide additional occupant protection.



- In an angled collision, the force of impact may direct the occupants in a direction where the air bags would not be able to provide any additional benefit, and thus the sensors may not deploy any air bags.



- Just before impact, drivers often brake heavily. Such heavy braking lowers the front portion of the vehicle causing it to "ride" under a vehicle with a higher ground clearance. Be particularly careful when following a vehicle with a high ground clearance because air bags may not inflate when your vehicle overrides another vehicle during a crash.



- Front air bags may not inflate in all rollover accidents when the SRS Control Module (SRSCM) indicates that the front air bag deployment would not provide additional occupant protection.



- Air bags may not inflate if the vehicle collides with an object such as a utility pole or tree. This is because the point of impact is concentrated in one area and the full force of the impact is not delivered to the sensors.



Supplemental Restraint System (SRS) care

The Supplemental Restraint System (SRS) is virtually maintenance-free and so there are no parts you can safely service by yourself.

If the SRS air bag warning light does not appear, or continuously remains on, have your vehicle immediately inspected by an authorized Kia dealer.

Any work on the SRS, such as removing, installing, repairing, or any work on the steering wheel, the front passenger's panel, front seats and roof rails must be performed by an authorized Kia dealer. Improper handling of the SRS may result in serious personal injury.

For cleaning the air bag pad covers, use only a soft, dry cloth or one which has been moistened with plain water. Solvents or cleaners could adversely affect the air bag covers and proper deployment of the system.

If components of the air bag system must be discarded, or if the vehicle must be scrapped, certain safety precautions must be observed. An authorized Kia dealer knows these precautions and can give you the necessary information. Failure to follow these precautions and pro-

cedures could increase the risk of bodily injury.

WARNING

Tampering with SRS

Do not tamper with or disconnect SRS wiring or other components of the SRS system. Doing so could result in the accidental inflation of the air bag or render the SRS inoperative.

WARNING

Towing vehicle

Always have the ignition off and wait for 3 minutes when your vehicle is being towed. The side air bags may inflate if the vehicle is tilted such as when being towed because of the rollover sensors in the vehicle.

Additional safety precautions

- **Never let passengers ride in the cargo area or on top of a folded-down back seat.** All occupants should sit upright, fully back in their seats with their seat belts on and their feet on the floor.
- **Passengers should not move out of or change seats while the vehicle is moving.** A passenger who is not wearing a seat belt during a crash or emergency stop can be thrown against the inside of the vehicle, against other occupants, or out of the vehicle.
- **Each seat belt is designed to restrain one occupant.** If more than one person uses the same seat belt, they could be seriously injured or killed in a collision.
- **Do not use any accessories on seat belts.** Devices claiming to improve occupant comfort or reposition the seat belt can reduce the protection provided by the seat belt and increase the chance of serious injury in a crash.
- **Passengers should not place hard or sharp objects between themselves and the air bags.** Carrying hard or sharp objects on your lap or in your mouth can result in injuries if an air bag inflates.
- **Keep occupants away from the air bag covers.** All occupants should sit upright, fully back in their seats with their seat belts on and their feet on the floor. If occupants are too close to the air bag covers, they could be injured if the air bags inflate.
- **Do not attach or place objects on or near the air bag covers.** Any object attached to or placed on the front or side air bag covers could interfere with the proper operation of the air bags.
- **Do not modify the front and rear seats.** Modification of the front and rear seats could interfere with the operation of the supplemental restraint system sensing components or side air bags.
- **Do not place items under the front seats.** Placing items under the front seats could interfere with the operation of the supplemental restraint system sensing components and wiring harnesses.
- **Never hold an infant or child on your lap.** The infant or child could be seriously injured or killed in the event of a crash. All infants and children should be properly restrained in

appropriate child safety seats or seat belts in the rear seat.

⚠ WARNING

- Sitting improperly or out of position can cause occupants to be shifted too close to a deploying air bag, strike the interior structure or be thrown from the vehicle resulting in serious injury or death.
- Always sit upright with the seatback in an upright position, centered on the seat cushion with your seat belt on, legs comfortably extended and your feet on the floor.

Adding equipment to or modifying your air bag-equipped vehicle

If you modify your vehicle by changing your vehicle's frame, bumper system, front end or side sheet metal or ride height, this may affect the operation of your vehicle's air bag system.

Air bag warning labels

Air bag warning labels, some required by the U.S. National Highway Traffic Safety Administration (NHTSA, U.S. only), are attached to the sun visor to alert the driver and passengers of potential risks of the air bag system.



Features of your vehicle **5**

Keys	5-6
• Battery replacement	5-6
• Smart key.....	5-7
Immobilizer system	5-10
• This device complies with Part 15 of the FCC rules.....	5-11
Theft-alarm system	5-11
• Armed stage	5-12
• Theft-alarm stage	5-12
• Disarmed stage.....	5-12
Digital Key 2	5-14
• Digital Key 2 (Smart Phone)	5-14
• Digital Key 2 (Card Key)	5-19
• Personalized Profile and Vehicle Settings	5-22
• Used Vehicle/Digital Key 2 Maintenance.....	5-25
• Limitations of the System.....	5-25
• This device complies with Part 15 of the FCC rules.....	5-25
Door locks	5-26
• Door locks outside the vehicle	5-26
• Door locks inside the vehicle	5-28
• Door lock/unlock features.....	5-29
• Manual door lock switch	5-30
• Child-protector rear door lock.....	5-30
• Rear Occupant Alert (ROA) System.....	5-31
Integrated memory system	5-32
• Storing memory positions	5-32
• Recalling memory positions	5-32
• Resetting the System	5-33
• Seat easy access.....	5-33
Liftgate	5-34
• Opening the liftgate.....	5-34

5 Features of your vehicle

• Closing the liftgate	5-35
• Emergency liftgate safety release	5-36
Power liftgate.....	5-36
• Power liftgate operating conditions	5-36
• Operating the power liftgate	5-38
• Setting the power liftgate.....	5-39
• Resetting the power liftgate.....	5-40
• Emergency liftgate safety release.....	5-40
Smart Liftgate with Auto Open	5-41
• How to use the Smart Liftgate with Auto Open	5-41
• How to deactivate the Smart Liftgate with Auto Open function using the smart key.....	5-42
• Detecting area	5-43
• Emergency liftgate safety release.....	5-43
Windows	5-44
• Window opening and closing	5-45
• Power window lock button	5-47
Hood	5-48
• Opening the hood.....	5-48
• Hood open warning	5-49
• Closing the hood	5-49
Fuel filler door	5-50
• Opening the fuel filler door (hybrid vehicle).....	5-50
• Opening the fuel filler door (Plug-in hybrid vehicle).....	5-51
• Closing the fuel filler door	5-52
Panoramic sunroof	5-55
• Power sunshade.....	5-56
• Tilt open/close	5-56
• Slide open/close	5-56
• Automatic reversal	5-57
• Resetting the sunroof.....	5-58

Features of your vehicle **5**

• Sunroof open warning	5-58
Steering wheel	5-59
• Motor Driven Power Steering (MDPS)	5-59
• Tilt & telescopic steering wheel.....	5-60
• Heated steering wheel.....	5-60
• Horn	5-61
Mirrors.....	5-62
• Inside rearview mirror	5-62
• Outside rearview mirror	5-71
Instrument cluster	5-74
• Adjusting instrument cluster illumination	5-75
• Gauges.....	5-75
• Transmission shift indicator	5-79
• Warning and indicator lights.....	5-79
LCD display.....	5-89
• LCD display modes.....	5-89
• LCD display messages.....	5-93
Driver Assistance settings (infotainment system)	5-98
Head-Up Display (HUD).....	5-99
• Head-Up Display Information.....	5-99
• Head-Up Display Setting	5-100
Lighting.....	5-100
• Battery saver function.....	5-100
• Headlamp delay function.....	5-100
• Daytime Running Light (DRL).....	5-101
• Lighting control	5-101
• Operating high beam	5-102
• Operating turn signals and lane change signals	5-103
• Operating front fog lights	5-103
• High Beam Assist (HBA).....	5-103
Wipers and washers	5-106

5 Features of your vehicle

• Auto control.....	5-107
• Operating windshield washers	5-108
• Operating rear window wiper and washer switch	5-109
Welcome system	5-109
Interior lights	5-110
• Automatic turn off function.....	5-110
• Interior lights always on	5-110
• Map lamp.....	5-111
• Room lamp	5-111
• Personal lamp.....	5-111
• Luggage compartment lamp.....	5-112
• Vanity mirror lamp	5-112
• Glove box lamp.....	5-112
Climate control system	5-113
• System operation.....	5-113
• Climate control air filter.....	5-114
• Air conditioning refrigerant label.....	5-115
• Checking the amount of air conditioner refrigerant and compressor lubricant.....	5-115
Automatic climate control system.....	5-117
• Using the infotainment/climate switchable controller control panel.....	5-118
• Heating and air conditioning automatically.....	5-118
• Heating and air conditioning manually.....	5-120
Windshield defrosting and defogging.....	5-124
• Defogging inside windshield.....	5-125
• Defrosting outside windshield.....	5-125
• Auto defogging system (ADS).....	5-125
• Defroster.....	5-126
• Defogging logic.....	5-127
Front glass heater	5-128

Features of your vehicle **5**

Storage compartments	5-128
• Center console storage	5-128
• Glove box.....	5-129
Interior features	5-129
• Ambient lights.....	5-129
• Cup holder.....	5-129
• Seat warmer	5-130
• Air ventilation seat	5-131
• Sun visor.....	5-132
• USB charger	5-132
• Power outlet	5-133
• Wireless smartphone charging system.....	5-134
• Coat hook	5-136
• Floor mat anchors.....	5-137
• Luggage cover.....	5-137
• Luggage net holder.....	5-138
• Cargo security screen	5-138
Exterior features	5-139
• Roof rack.....	5-139
Infotainment system	5-142
• Over-The-Air software update	5-142
• Using the infotainment/climate switchable controller.....	5-144
• For Telematics button function.....	5-145
• Audio system.....	5-145
Declaration of Conformity	5-149

Features of your vehicle

Keys

⚠ WARNING

Never leave the keys in your vehicle

Leaving children unattended in a vehicle with the keys is dangerous even if the vehicle is ACC or ON position. Unattended children could press the ENGINE START/STOP button and may operate power windows or other controls, or even make the vehicle move, which could result in serious bodily injury or even death. Never leave the keys in your vehicle with unsupervised children, when the engine is running.

Record your key number.

The key code number is stamped on the key code tag attached to the key set. Should you lose your keys, this number will enable an authorized Kia dealer to duplicate the keys easily. Remove the key code tag and store it in a safe place. Record the key code number and keep it in a safe and handy place, but not in the vehicle.

⚠ WARNING

Aftermarket keys

Use only Kia original parts for the ignition key in your vehicle. If an aftermarket key is used, the ENGINE START/STOP button may not return to ON after START. If this happens, the starter will continue to operate causing possible fire due to excessive current in the wiring.

Battery replacement

The smart key uses a 3 volt lithium battery which will normally last for several years.



If you are unsure how to use or replace the battery, contact an authorized Kia dealer.

1. Detach mechanical key from your smart key.
2. Pry open the key cover.
3. Replace the smart key cover with a new battery (CR2450).
4. Install the battery in the reverse order of removal.

For smart key replacement, visit an authorized Kia dealer.

The smart key is designed to give you years of trouble-free use, however it can malfunction if exposed to moisture or static electricity. If you are unsure how to use or replace the battery, contact an authorized Kia dealer.

Using the wrong battery can cause smart key to malfunction. Be sure to use the correct battery.



An inappropriately disposed battery can be harmful to the environment and human health. Dispose the battery according to your local law(s) or regulation.

⚠ WARNING**THIS PRODUCT CONTAINS A BUT-TON BATTERY**

If swallowed, a lithium button battery can cause severe or fatal injuries within 2 hours.

Keep batteries out of reach of children.

If you think batteries may have been swallowed or placed inside any part of the body, seek immediate medical attention.

⚠ CAUTION**Smart key damage**

The smart key can malfunction if dropped, exposed to moisture, static electricity, heat or direct sunlight.

*** NOTICE**

Always insert the key battery with the correct polarity. Incorrect insertion may cause the key to malfunction or the battery to discharge prematurely.

This device complies with Part 15 of the FCC rules.

Operation is subject to the following two conditions:

1. This device may not cause harmful interference.
2. This device must accept any interference received, including interference that may cause undesired operation.

*** NOTICE**

Changes or modifications not expressly approved by the party responsible for compliance could void the user's authority to operate the equipment. If the smart key is inoperative due to changes

or modifications not expressly approved by the party responsible for compliance, it will not be covered by your manufacturer's vehicle warranty.

Smart key

With a smart key, you can lock or unlock a door and even start the vehicle without inserting the key.

**Lock  (1)**

All doors are locked if the lock button is pressed. If all doors are closed, the hazard warning lights will blink and the chime will sound once to indicate that all doors are locked.

Also, if the lock button is pressed once more within 4 seconds, the hazard warning lights will blink and the chime will sound once to confirm that the door is locked.

However, if any door remains open, the hazard warning lights (and/or the chime) will not operate. But if all doors are closed after the lock button is pressed, the hazard warning lights will blink once.

Unlock  (2)

The driver's door is unlocked if the unlock button is pressed once. The hazard warning lights will blink twice to indicate that the driver's door is unlocked.

All doors are unlocked if the unlock button is pressed once more within 4 seconds. The hazard warning lights will blink and the chime will sound twice again to indicate that all doors are

unlocked. After pressing this button, the doors will lock automatically unless you open any door within 30 seconds.

If you attempt to lock or unlock the door by pressing the door lock/unlock button under any of the following conditions, the door will not be locked or unlocked.

- When you want to lock or unlock the door in the ACC or ON state.
- When you want to lock a door in a car with one or more doors open.

Depending on the vehicle, the driver can turn off or set the 2-press unlock setting function.

* NOTICE

- If the smart key is inoperative due to exposure to water or liquids, it will not be covered by the vehicle warranty.
- Tinting the vehicle windows with film, especially metalized film, may interfere with receiving frequency transmitted by the smart key, reducing its operating range.

Liftgate unlock, Power liftgate open/close (3)

If you press this button for longer than a second, the lock will be released or the liftgate will be unlocked or opened according to the options of the vehicle. Once the liftgate is opened and then closed, the liftgate will lock automatically.

Panic alarm (4)

The horn sounds and the hazard warning lights blink for about 30 seconds if this button is pressed for more than 1

seconds. To stop the horn and lights, press any button on the transmitter.

Remote start (5)

You can start the vehicle using the remote start button (5) of the smart key.

To start the vehicle remotely:

- Lock the doors by pressing the door lock button (1) within 32 ft (10 m) of the vehicle.
- Press the remote start button for over 2 seconds within 4 seconds after locking the doors.

Press the remote start button once to turn off the vehicle.

If no further action for operating/driving the vehicle is taken, the vehicle will be turned off 10 minutes after starting the vehicle remotely.

While remote starting, the hazard warning lights blink 3 times. If you want to stop the engine, press the Remote Start button (5) again.

Remote smart parking assist (RSPA) (6, 7)

You can start the vehicle without inserting the key.

- * The Remote smart parking assist (RSPA) helps the drivers park their vehicle by using sensors to measure parking spaces and control the steering wheel, gear shift and vehicle speed to semi-automatically park the vehicle. With the smart key, the driver can move the vehicle forward or backward using the forward/backward buttons (6, 7) on the smart key. For more information, refer to "Remote Smart Parking Assist (RSPA) (if equipped)" on page 7-132.

Start-up

You can start the vehicle without inserting the key.

* For more information, refer to "ENGINE START/STOP button" on page 6-6.

Mechanical key

If the smart key does not operate normally, you can lock or unlock the door by using the mechanical key.



Pull the mechanical key from the protective cover (1).

Smart key precautions

The smart key may not work if any of the following occur:

- The smart key is close to a radio transmitter such as a radio station or an airport which can interfere with normal operation of the smart key.
- The smart key is near a mobile two-way radio system or a cellular phone.
- Another vehicle's smart key is being operated near your vehicle.

When the smart key does not work correctly, open and close the door with the mechanical key and if you want to purchase them, please contact an authorized Kia dealer.

If the smart key is near your mobile phone or smartphone, the signal from the smart key could be blocked by normal operation of your cellular phone or smartphone. This is especially important when the phone is active, such as when making calls, receiving calls, text mes-

saging, and/or sending/receiving emails. Avoid placing the smart key and your cellular phone or smartphone in the same pants or jacket pocket and maintain adequate distance between the two devices.

* NOTICE

Loss of the smart key

A maximum of 2 smart keys can be registered to a single vehicle.

If you happen to lose your smart key, you will not be able to start the vehicle. You should immediately take the vehicle and remaining key to your authorized Kia dealer (tow the vehicle, if necessary) to protect it from potential theft.

⚠ CAUTION

Transmitter

Keep the transmitter away from water or any liquid, as it can become damaged and not function properly.

* NOTICE

If the smart key is inoperative due to exposure to water or liquids, it will not be covered by your manufacturer's vehicle warranty.

* NOTICE

To prevent the smart key from becoming damaged by magnetic fields, do not leave it near the following electrical appliances:

- TVs
- Personal computers
- Mobile phones, cordless phones and battery chargers
- Table lamps

- Induction cookers

* NOTICE

If you must leave the vehicle's key with a parking attendant, remove the mechanical key for your own use and provide the attendant with the smart key only.

⚠ CAUTION

When bringing a smart key onto an airplane, make sure you do not press any button on the key while inside the cabin. If you are carrying the key in your bag etc., make sure that the buttons cannot be pressed accidentally. If you press a button, the key may emit radio waves that could interfere with the operation of the aircraft.

Immobilizer system

The immobilizer system protects your vehicle from theft. If an improperly coded key (or other device) is used, the vehicle's power system is disabled.

When the ENGINE START/STOP button is placed in the ON position, the immobilizer system indicator should come on briefly, then go off. If the indicator starts to blink, the system does not recognize the coding of the key.

Place the ENGINE START/STOP button in the OFF position, then place the ENGINE START/STOP button in the ON position again.

In some circumstances, the vehicle may not recognize your smart key if another smart key device is nearby or a metal object such as a keychain is causing interference with the smart key.

If this occurs, your vehicle may not start. Remove any metal objects or additional keys near the smart key before attempting to start the vehicle again.

If the system repeatedly does not recognize the coding of the key, contact your Kia dealer.

Do not attempt to alter this system or add other devices to it. Electrical problems could result that may make your vehicle inoperable.

Deactivating Immobilizer system

Change the ENGINE START/STOP button to the ON position.

Activating Immobilizer system

Change the ENGINE START/STOP button to the OFF position. The immobilizer system activates automatically. Without a valid smart key for your vehicle, the engine will not start.

*** NOTICE**

When starting the vehicle, do not use the key with other immobilizer keys around. Otherwise, the vehicle may not start or may stop soon after it starts. Keep each key separate in order to avoid a starting malfunction.

*** NOTICE**

If you need additional keys or lose your keys, contact an authorized Kia dealer.

This device complies with Part 15 of the FCC rules.

Operation is subject to the following two conditions:

1. This device may not cause harmful interference.
2. This device must accept any interference received, including interference that may cause undesired operation.

*** NOTICE**

Changes or modifications not expressly approved by the party responsible for compliance could void the user's authority to operate the equipment. If the smart key is inoperative due to changes or modifications not expressly approved by the party responsible for compliance, it will not be covered by your manufacturer's vehicle warranty.

Theft-alarm system

This system is designed to provide protection from unauthorized entry into the vehicle.

This system is operated in three stages:

- Armed stage
- Theft-alarm stage
- Disarmed stage

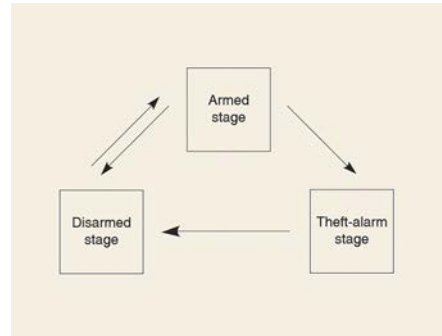

If triggered, the system provides an audible alarm with blinking of the hazard warning lights.

⚠ CAUTION

Do not attempt to alter this system or add other devices to it.

Armed stage

Park the vehicle and stop the engine. Arm the system as described below.

1. Turn off the engine.
2. Make sure that all doors, the hood and liftgate are closed and latched.
3. Lock the doors by pressing the button of the front outside door handle with the smart key in your possession. After completion of the steps above, the hazard warning lights will operate once to indicate that the system is armed. If any door (or liftgate) or hood remains open, the hazard warning lights, and the chime will not operate, and the theft-alarm will not arm. If all doors and liftgate and hood are closed after the lock button is pressed, the hazard warning lights blink once. The system can also be armed by locking the doors with the key from the front doors; however, the hazard warning lights will not blink using this method.
4. Lock the doors by pressing the lock button on the smart key. After completion of the steps above, the hazard warning lights will operate once to indicate that the system is armed.

* NOTICE

The theft-alarm system can be deactivated by an authorized Kia dealer. If you want this feature, consult an authorized Kia dealer.

* NOTICE

Do not arm the system until all passengers have left the vehicle. If the system is armed while a passenger(s) remains in the vehicle, the alarm may be activated when the remaining passenger(s) leaves the vehicle. If any door (or liftgate) or

hood is opened within 30 seconds after the system enters the armed stage, the system will be disarmed to prevent unnecessary alarm.

Theft-alarm stage

The alarm will be activated if any of the following occurs while the system is armed.

- A front or rear door is opened without using the smart key.
- The liftgate is opened without using the smart key.
- The hood is open.

The horn will sound, and the hazard warning lights will blink continuously for approximately 27 seconds, and repeat the horn 3 times unless the system is disarmed. To turn off the system, unlock the doors with the folding key or smart key.

Disarmed stage

The system will be disarmed when:

- The door unlock button is pressed.
- The button of the front outside door is pressed while carrying the smart key.
- The engine is started. (within 3 seconds)

After pressing the unlock button, the hazard warning lights will blink and the chime will sound twice (in smart key) to indicate that the system is disarmed.

After pressing the unlock button, if any door (or liftgate) is not opened within 30 seconds, the system will be rearmed.

* NOTICE

- Avoid trying to start the engine while the alarm is activated. The vehicle starting motor is disabled during the theft-alarm stage.

If the system is not disarmed with the folding key, insert the key into the ignition switch, turn the ignition switch to the ON position and wait for 30 seconds. Then the system will be disarmed.

- If you lose your keys, consult your authorized Kia dealer.

CAUTION

Adjusting alarm system

Do not modify, alter or adjust the theft alarm system in your vehicle. Improper installation of the alarm system could damage the vehicle or cause the system to malfunction.

* NOTICE

Malfunctions caused by improper alterations, adjustments or modifications to the theft-alarm system are not covered by your warranty.

This device complies with Part 15 of the FCC rules.

Operation is subject to the following two conditions:

1. This device may not cause harmful interference.
2. This device must accept any interference received, including interference that may cause undesired operation.

* NOTICE

Changes or modifications not expressly approved by the party responsible for compliance could void the user's authority to operate the equipment. If the smart key is inoperative due to changes or modifications not expressly approved by the party responsible for compliance, it will not be covered by your manufacturer's vehicle warranty.

Digital Key 2 (if equipped)

Kia Digital Key 2 provides convenience to the driver, such as locking or unlocking the driver and passenger doors or the liftgate and turning on the vehicle with a smartphone or card key, without a smart key.

Digital Key 2 (Smart Phone)

How to register Digital Key 2 (Smart phone)

Kia Digital Key 2 can only be used on the smartphones that support this function, and the smartphone's Digital Key 2 function is provided by the smartphone manufacturer. Some smartphone functions may be incompatible with your vehicle.

While updating the digital key 2 controller, the smart key function may not work temporarily. In this case, it can be operated with the door lock/unlock button of the smart key.

Smart Phone Set Up

In order to use Digital Key 2 (Smart phone) function, install the Kia Access App on your smart phone, register your information and subscribe the service.

Smart Phone Registration



- 1 Smartphone key
- 2 My Smartphone key
- 3 Save

1. Turn the vehicle on with the Smart key and make sure to keep the smart

key inside the vehicle during digital key registration.

2. Shift to P (Park), press **Digital Key Settings** → **Register** on Kia Access app on your smartphone, and register according to the messages on the app.

- For smartphones without UWB support, place the NFC antenna of the smartphone on the center of the wireless charging pad (1).



1. Charging pad

- For smartphones with UWB support, even if you don't put your smartphone on the indoor authentication pad (wireless charging pad)(1), if you carry your smartphone in the vehicle, you can register the digital key wirelessly.

2. When the digital key (smartphone) is saved, a message will appear on the instrument cluster or the infotainment system screen.

* NOTICE

You can check the location of the NFC antenna on your Samsung smartphone in the Settings app → Connections → NFC and contactless payments. The Apple iPhone®'s NFC antenna is located at the top of the back of the device (1), and the Apple Watch®'s NFC antenna is located in the center of the screen (2). Make sure that the location of the smartphone's NFC antenna touches the inve-

vehicle authentication pad (wireless charging pad).



However, as the location of the smartphone's NFC antenna may be different by smartphone model, contact the smartphone manufacturer for more details.

When it is not registered on the Kia Access app on your smartphone

Even if you put your smartphone on the indoor authentication pad, if the message of **Registering...** is not displayed on the infotainment system screen, you can register it as below.

1. After turning the vehicle OFF, use the smart key to turn POWER ON again, then place the smart key inside the vehicle.
2. Select **Setup** → **Vehicle** → **Digital Keys** → **Smartphone key** → **My Smartphone Key** on the infotainment system screen while the vehicle is in P (Park) position.

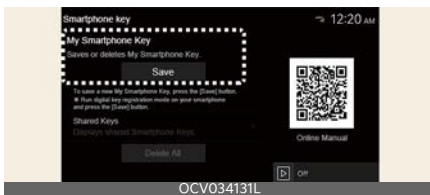

3. Place the NFC antenna of the smartphone on the center of the indoor

authentication pad (wireless charging pad).

When the digital key (smart phone) is saved, a message will appear on the infotainment system screen.

* INFORMATION

- The infotainment system may change after software updates. For more information, refer to the manual provided in the infotainment system and the quick reference guide.

- Vehicle

When there is a digital key (smart phone) already saved in the vehicle, Delete All will be displayed on the Smartphone Key menu screen of the infotainment system and Delete will be displayed on the My Smartphone Key screen. If you want to save a digital key again, "How to delete Digital Key (Smart Phone)" on page 5-18.

- Smart Phone

The digital key cannot be saved again while the vehicle's digital key is saved in the owner's smart phone. Save the digital key after deleting the digital key from the smartphone OEM wallet App or in the vehicle.

- During the digital key 2 saving process, the process will cancel when:
 - The smart phone is removed from the in-vehicle authentication pad (wireless charging pad)
 - Changing the infotainment system or instrument cluster screen
 - The vehicle is turned off
 - The gear is shifted
 - There is no smart key (saving process will not begin)
- As the in-vehicle authentication pad may not work smoothly depending on

the internal structure of the smartphones, the digital key may not be registered. Register the key by moving the smartphone to the left or right of the in-vehicle authentication pad (wireless charging pad).

- UWB (Ultra WideBand) means ultra-wideband wireless communication technology. NFC (Near Field Communication) means short-range wireless communication.

How to Use the Digital Key 2 (Smart Phone)

Smart Phone Touch Control

The driver can lock and unlock the door by touching the smart phone on the door handle without activating the Kia Access App. Also, the vehicle can be started by placing the smart phone on the charging pad. Make sure that the location of the smartphone's NFC (short-range wireless communication) antenna touches the door handle authentication pad.

The Apple iPhone®'s NFC antenna is located at the top of the back of the device, and the Apple Watch®'s NFC antenna is in the center of the screen. The NFC antenna is in the same location that you may use for tapping to make contactless payments. If you are uncertain about the location of the NFC antenna on your phone, contact the smartphone manufacturer for more details.

Locking/Unlocking the doors

- If the driver touches the smart phone antenna to the driver's or passenger's door handle authentication pad for more than 2 seconds, the door will lock or unlock.
- If 2 Press Unlock function is set, only the driver's door will be unlocked by touching the smart phone on the driver's door handle. Touch the smart phone once more within 4 seconds to unlock all doors.
- After unlocking the doors, the doors will automatically re-lock after 30 seconds unless a door is opened.
- If the smart phone digital key does not operate, move the smart phone more than 4 inches (0.1 m) from the door handle authentication pad and try it again.

For smartphones without UWB support:

To lock or unlock the doors with a registered smartphone, touch the NFC antenna on the smartphone on the authentication pad of the driver's or passenger's outside door handle for about 2 seconds.

For smartphones with UWB support:

- To lock or unlock the doors, carry your smartphone and touch the door handle lock/unlock sensor (curved area) on the outside door handle.

WARNING

- When you carry the smartphone supported by UWB and stay near the vehicle for about a few minutes, the door may not unlock automatically.
- If the smartphone is in a back pocket or bag, the signal may be blocked and could limit the Bluetooth connection and cause operation delay when lock-

ing/unlocking doors or starting the vehicle.

- If a tinting film containing metal components is applied, the digital key may not function properly.

* NOTICE

Note that the door will not lock and a beep sounds when using the Digital Key 2 if any of the following occur:

- When the Smart Key is in the vehicle
- The EV button is in POWER ON or DRIVE READY position
- Attempting to lock the door when more than one door, or hood, liftgate is opened
- If a tinting film containing metal substances is applied to the digital key, it may not function properly.

Starting the vehicle

After placing your registered smart phone on the charging pad, depress the brake pedal and press the EV button.

- Once the vehicle is started, you can remove the smart phone from the pad.

For more details, refer to "EV/HEV button" on page 1-25.

For smartphones without UWB support:

- Place the NFC antenna of the smartphone on the center of the charging pad, press the brake pedal, and then press the start button to start the vehicle.
- After starting the vehicle, you can remove the smartphone from the charging pad.

- Some smartphones may not have smooth NFC communication due to their internal structure. In such cases, move the smartphone to the right or left of the charging pad to operate it.
- The Apple iPhone®'s NFC antenna is located at the top of the back of the device, and the Apple Watch®'s NFC antenna is located in the center of the screen. The NFC antenna is in the same location that you may use for tapping to make contactless payments. If you are uncertain about the location of the NFC antenna on your phone, contact the smartphone manufacturer for more details.

For smartphones with UWB support:

- Carry the smartphone inside the vehicle, press the brake pedal, and then press the start button to start the vehicle.
- To start the vehicle remotely, use an app provided by the smartphone manufacturer to lock the vehicle using the door lock button, and then press the remote start button within 4 seconds. The vehicle will start, and the hazard warning light will flash
- To turn off the vehicle, press the remote start button again.

Operating the liftgate

For smartphones with UWB support:

- When the vehicle is locked, to open the liftgate, press the liftgate open button, carrying a smartphone registered.

- When Smart liftgate is selected, the liftgate automatically opens when you approach the detecting area behind the liftgate for more than 3 seconds, carrying a smartphone with Digital Key 2 registered.

CAUTION

- Always have the registered smartphone with you when you close the liftgate. The doors may not unlock if you close the liftgate when the doors are locked or close the liftgate using the liftgate button on the smartphone.
- The vehicle can be started when the registered smartphone is placed on the in-vehicle authentication pad (wireless charging pad). Therefore, do not leave unsupervised children or people who are not aware of the system since it can result in serious injury or death. In addition, always keep the registered smart phone with you to prevent vehicle theft when leaving the vehicle.

For smartphones with UWB support, Digital Key 2 is only available when the vehicle and the smartphone are connected through Bluetooth.

- The distance at which you can get a Bluetooth connection may vary depending on the surroundings.
- If a tinting film containing metal components is applied, it may cause poor Bluetooth connectivity.
- If the smartphone is in a back pocket or bag, the signal may be blocked, which could limit the Bluetooth connection and cause delays when locking/unlocking doors or starting the vehicle.

For smartphones with UWB support, Digital Key 2 is only available for a lim-

ited time to optimize the vehicle and smartphone batteries.

You can check the connection between the vehicle and smartphone in the smartphone's settings or in an app provided by the smartphone manufacturer.

How to delete Digital Key (Smart Phone)

Turn the vehicle on with the smart key and make sure to keep the smart key inside the vehicle during the digital key (smart phone) deleting process.

1. To Delete All Digital Keys

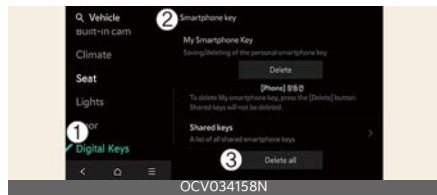

- 1) Digital Keys
- 2) Smartphone key
- 3) Delete all

With the vehicle on, touch **Setup** → **Vehicle** → **Digital Keys** → **Smartphone key** → **Shared keys** → **Delete all** on the infotainment system.

- The key of owner and the shared user will be deleted.
- If there is no registered key, the menu cannot be selected.

2. To Delete My Smartphone Key

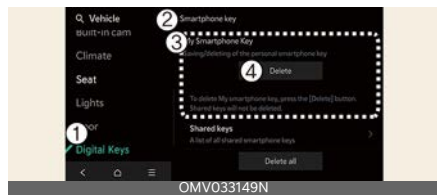

- 1) Digital Keys
- 2) Smartphone key
- 3) My Smartphone Key

4) Delete

If you want to change only the owner's smartphone key while keeping the shared key, delete **My Smartphone Key** not **Delete All** and then **Save** again.

With the vehicle on, touch **Setup** → **Vehicle** → **Digital Keys** → **Smartphone Key** → **My Smartphone key** → **Delete** on the infotainment system.

- After deleting My Smartphone key, the new smartphone can be registered.

Deleting the shared keys

Select **Setup** → **Vehicle** → **Digital Keys** → **Smartphone key** → **Shared Keys** → **[Group]** → **Delete** on the infotainment system screen.

Those digital keys other than the **My Smartphone Key** (smartphone) are classified by **[Group]** and displayed as 'Shared Key.'

If the account logged in the smartphone is the same, it is displayed as the same **[Group]**. You can delete the **Shared Key** by the unit of **[Group]**.

* NOTICE

- If digital key (smart phone) is deleted, the digital key saved in the smartphone is also deleted.
- If digital key (smart phone) is deleted on the smart phone, the digital key saved in the vehicle is also deleted.

* INFORMATION

The infotainment system may change after software updates. For more information, refer to the manual provided in

the infotainment system and the quick reference guide.

Digital Key 2 (Card Key)

How to register Digital Key 2 (Card Key)

To use the card key as a digital key 2, register the card key in your vehicle system in accordance with the following procedures.

1. Enter your Kia with two smart keys.
2. Check if **Use** menu is activated.

With the vehicle on, touch **Setup** → **Vehicle** → **Digital Keys** → **NFC Card key** → **Use** on the infotainment system.



- 1) **Digital Keys**
- 2) **NFC Card key**
- 3) **Use**
- 4) **Save**

3. With the vehicle on, place the card key on the charging pad and press the **Save** menu on the infotainment system screen. The saving process will begin automatically.

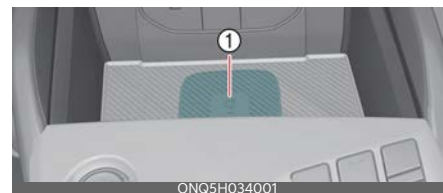

- 1) Charging pad

4. When the digital key (card key) is saved, a message will appear on the infotainment system screen.

* INFORMATION

- The infotainment system may change after software updates. For more information, refer to the manual provided in the infotainment system and the quick reference guide.
- When there is a digital key (card key) already saved in the vehicle, the **Save** menu is disabled. If you want to save a digital key again, refer to "How to delete Digital Key 2 (Card key)" on page 5-21 and follow the deleting procedure first before saving a digital key.
- To register the digital key (card key), the two smart keys must be in the vehicle.
- The registered digital key (card key) cannot be used for another vehicle.

How to use the Digital Key 2 (Card key)

Card key touch control

The driver can lock and unlock the door by touching the card key on the door handle. Also, the vehicle can be started by placing the card key on the charging pad.



1 Door handle authentication pad

Locking/Unlocking the doors

- If the driver touches the NFC antenna of the registered card key on the driver's or passenger's door handle authentication pad (1) for more than 2 seconds, the door will lock or unlock.
- If 2 Press Unlock function is set, only the driver's door will be unlocked by touching the smart phone on the driver's door handle. Touch the smart phone once more within 4 seconds to unlock all doors.
- After locking the door, make sure to check its locked state. After unlocking the doors, the doors will automatically re-lock after 30 seconds unless a door is opened.
- It works only if the center of the NFC card key touches the NFC authentication area of the vehicle door handle.

* NOTICE

When touching a smartphone NFC antenna to the center of the outside door handle authentication pad, the doors will not lock with a beep sound in following conditions:

- When the Smart Key is in the vehicle
- When the EV button is in POWER ON or DRIVE READY position
- When one or more doors, hood or lift-gate are open

Starting the vehicle

After placing your registered card key on the charging pad, depress the brake pedal and press the EV button to start the vehicle.

- Once the vehicle is started, you can remove the card key from the pad.

For more details, refer to "EV/HEV button" on page 1-25

⚠ WARNING

The vehicle can be started when the registered card key is placed on the charging pad. Therefore, do not leave unsupervised children or people who are not aware of the system since it can result in serious injury or death. In addition, always have the registered card key with you to prevent vehicle theft when leaving the vehicle.

⚠ CAUTION

- The digital key (card key) may not work under the following conditions:
 - When the card key is not touching the center of the door handle authentication pad or the charging pad correctly.
 - If the card key overlaps NFC-enabled cards such as credit card or smart phone.
 - If the card key does not work, move the card key approximately 4 inches (10 cm) away from the authentication pad and then touch it again.
- The card key can be damaged by impact. If the card key is damaged, replace the card key with a new one and register it again.
- A damaged or lost card key is not covered by the warranty. The replacement cost is the owner's responsibility.
- Long-time exposure to high temperature may cause the card key to malfunction. Be careful not to expose the key to direct sunlight or high temperature.
- If the card key is left on the charging pad while driving, it may cause malfunction of the card key. After starting the vehicle, make sure to separate the

card key from the in-vehicle charging pad.

- If the card key is placed between the charging pad and the smartphone and the smartphone is wirelessly charging, it may cause the card key to malfunction. For example, charging the smartphone while the card key is attached to the back of the smartphone case.

How to delete Digital Key 2 (Card key)

1. Turn the vehicle on with the smart key and make sure to keep the smart key inside the vehicle during the card key deleting process.
2. With the vehicle on, touch **Setup** → **Vehicle** → **Digital key** → **NFC card key** → **Delete** on the infotainment system.

The **Delete** menu will be disabled if there is no card key saved.



- 1) **Digital keys**
 - 2) **NFC card Key**
 - 3) **Use**
 - 4) **Delete**
3. When the card key is deleted, a message will appear on the infotainment screen or cluster.

* INFORMATION

The infotainment system may change after software updates. For more information, refer to the manual provided in the infotainment system and the quick reference guide.

Personalized Profile and Vehicle Settings

The digital key (smartphone) registered in the vehicle can be linked with user profile. If the account logged in the smartphone is the same, it is regarded as the same **[Group]**, and all digital keys (smartphone) of the **[Group]** are linked. If you get on the vehicle with the digital key 2 (smartphone), it automatically operates with the linked profile. The key included in the same **[Group]**, excluding My Smartphone Key, can be checked in the below menu.

* INFORMATION

The infotainment system may change after software updates. For more information, refer to the manual provided in the infotainment system and the quick reference guide.

Select **Setup** → **Vehicle** → **Digital Keys** → **Smartphone key** → **Shared Keys** → **[Group]** on the infotainment system screen.

Linking / Unlinking profile

How to link user profile

1. Select **Setup** → **User profile** → **Profile setting** → **Link Digital Key (Smartphone)** on the infotainment system settings menu.

2. If you select **Link**, the registered phone number's digital key of the **[Group]** and the user profile will link. Select **Link** according to the instruction.
3. When the process is complete, the message 'Digital Key Link Complete.' will appear on the infotainment system screen.
4. Click the **Link** button and select the smartphone you want to link from the smartphone list displayed on the screen. Link it according to the instructions.
5. When the process is complete, the message 'Digital Key Link Complete.' will appear on the infotainment system screen.

How to unlink user profile

1. Select **Setup** → **User Profile** → **Profile Setting** → **Link Digital Key (Smartphone)** on the infotainment system. Unlink the smartphone in the User Profile settings. Unlink the smartphone in the User Profile settings. Unlinking is possible only when user profile is linked.
2. When unlinking is complete, the message 'Digital key is unlinked.' will appear on the infotainment system screen.

* INFORMATION

- The user profile cannot be linked to both Driver 1 and Driver 2 that are connected to a single smartphone. Personalization will operate with the recently linked user profile, and the previously linked user profile will be automatically canceled.
- User profile can be linked when Digital Key is registered on the smart-

phone and the vehicle. The smartphone with another vehicle's digital key cannot be linked.

- NFC card key cannot be linked with personalized profile.
- Once the user profile linked Digital Key in the smartphone is deleted, Digital Key 2 should be re-registered and personalized by linking the user profile again.
- The infotainment system may change after software updates. For more information, refer to the manual provided in the infotainment system and the quick reference guide.

*** INFORMATION**

User profile operation according to door lock/unlock system is as follows.

Item	Personalization operation
Initial value	Guest
Profile linked smartphone key	Linked profile
Profile unlinked smartphone key	Recently activated profile
NFC card key	
Smart key	

Vehicle personalization operation

The personalization function linked with Digital Key 2 works under the following conditions:

- Touch the driver's door handle with the profile linked smartphone to lock or unlock the doors (Personalization does not operate when locking or unlocking the front passenger door.).
- The personalization function using the digital key can be operated after linking the digital key in the infotainment system profile menu.
- The personalization function works only when the vehicle is off or when the vehicle is started remotely. If the vehicle is not started remotely, personalization function does not work with the digital key.

Vehicle personalization with Digital Key 2

The available personalization function in the vehicle is as follows.

System	Personalization Item	
Infotainment Settings menu	Head Up Display (HUD)	Position adjustment of image, Information display selection
	Lamp	Blink number of one-touch signal lamps
	Cluster	Information display on the cluster, Voice volume, Welcome sound
	Seat	Seat position
		Smart heating wire ventilation On/Off
	Door	Automatic door lock/unlock
	Smartphone wireless charging	Wireless charging On/Off
	Air conditioning	Setting up temperature unit, Block air inflow/ Automatic ventilation Window defroster On/Off
	Navigation	Preferred volume of the navigation system
		Recent destination
User preset	My menu list settings, Radio preset	
Phone connectivity	Bluetooth preferential connection	
	CarPlay/Android Auto/MirrorLink On/Off	
Air conditioning	Operating condition	Latest operation setup of the following functions: Temperature (AUTO), air flow direction, air volume, air conditioner, air intake control, SYNC, Front windshield defroster, off

For more information of personalization, refer to the infotainment system manual.

CAUTION

If you leave the digital key in the vehicle after locking or unlocking the doors or starting the vehicle with the smart key, the doors can be locked with the central lock button. Have the digital key with you at all times.

Used Vehicle/Digital Key 2 Maintenance

Purchasing used vehicle

If you purchased a used car, please delete the smart phone key and card key (if equipped) registered by the previous user. Please let us know the purchase of a used vehicle through an authorized Kia dealer.

Check whether the card key (if equipped) that came with the used vehicle operates properly. If the digital key (card key) (if equipped) does not work properly, delete the card key (if equipped) and register the smartphone key. Then re-register the card key (if equipped).

Digital Key 2 Maintenance

If you need to have your Digital Key 2 System repaired or replaced, the registered digital key (smartphone/card key) (if equipped) can be deleted depending on the type of maintenance.

Limitations of the System

- Digital Key 2 may not work if any of the following occurs:
 - Smartphone battery or the vehicle battery is discharged
 - NFC or Bluetooth is turned off in the smartphone settings
 - A credit card overlaps the back of your smart phone, or metal or thick smartphone case is used
 - Using the card key (if equipped) with other cards, or using it in a wallet or card holder
 - There is electronic interference by other vehicles, objects, etc.

- There may be a communication error with Digital Key 2 NFC function if a metallic cover or communication device is attached to the smartphone. If there is a malfunction of Digital Key 2, remove the cover attached to the smartphone and try again.
- The vehicle may not be controlled by the smartphone if any of the following occurs:
 - Basic and necessary functions of the smartphone are operating (general call, urgent call, audio or contactless payment)
 - Using wireless earphone (general call, urgent call or audio)
 - When Kia Access app function is being limited due to smartphone default settings or app launch priority policy per manufacturer

This device complies with Part 15 of the FCC rules.

Operation is subject to the following two conditions:

1. This device may not cause harmful interference.
2. This device must accept any interference received, including interference that may cause undesired operation.

* NOTICE

Changes or modifications not expressly approved by the party responsible for compliance could void the user's authority to operate the equipment. If the digital key is inoperative due to changes or modifications not expressly approved by the party responsible for compliance, it will not be covered by your manufacturer's vehicle warranty.

Door locks

Know how to use the door lock so that you can lock or unlock the door if necessary.

Door locks outside the vehicle

Locking/unlocking with the smart key



Carrying the smart key, you may lock and unlock the vehicle doors (and lift-gate) and you may start the engine. Refer to the following for more details.

Locking

Pressing the button of the front door handles with all doors closed and any door unlocked, locks all the doors. If all doors and engine hood are closed, the hazard warning lights will blink once to indicate that all doors are locked.

The button will only operate when the smart key is within 40 inches (1 m) from the front door handle. If you want to make sure that a door has locked or not, you should pull the front door handle.

Even though you press the front door handle buttons, the doors will not lock, and the chime will sound for 3 seconds if any of following occur:

- The smart key is in the vehicle.
- The ENGINE START/STOP button is in the ACC or ON position.
- Any door except the liftgate is open.

Unlocking

Pressing the button of the front driver side door handles with all doors closed and locked, unlocks all the doors. The hazard warning lights blink twice to indicate that all doors are unlocked.

The button will only operate when the smart key is within 40 inches (1 m) from the front door handle.

When the smart key is within 40 inches (1 m) from the front door handle, other people can also open the door without possession of the smart key.

After pressing the button, the doors will lock automatically unless you open any door within 30 seconds.

Locking/unlocking with the mechanical key



1. Pull out the door handle.
2. Press the lever (1) located inside the bottom part of the cover with a key or flat-head screwdriver.
3. Push out the cover (2) while pressing the lever (only the driver's door can be locked/unlocked).
4. Turn the key toward the rear of the vehicle to unlock and toward the front of the vehicle to lock.
 - Doors can also be locked and unlocked with the transmitter.
 - Once the doors unlocked, it may be opened by pulling the door handle.

- When closing the door, push the door by hand. Make sure the door is closed securely.

* NOTICE

- When locking the door with a mechanical key, be aware that only the driver's door can be locked/unlocked.
- To lock all doors, operate the central lock switch inside the vehicle. Open the car door using the inner handle, then close the door and lock the driver's door with a mechanical key.
- Refer to "Unlocking with the door handle" on page 5-28 to lock from inside the vehicle.

* NOTICE

- Be careful not to lose or scratch the cover when removing it.
- When the key cover freezes and does not open, tap it lightly or indirectly warm (hand temperature, etc.) it up.
- Do not apply excessive force to the door and door handle. It may be damaged.

* NOTICE

- In cold and wet climates, door lock and door mechanisms may not work properly due to freezing conditions.
- If the door is locked/unlocked multiple times in rapid succession with either the vehicle key or door lock switch, the system may stop operating temporarily to protect the circuit and prevent damage to system components.

⚠ WARNING

- Securely close your door before you begin driving. Failure to fully close your door may cause it to be opened during vehicle operation.
- Keep your body out of the way of the closing door to prevent injuries.

⚠ WARNING

Do not leave anyone in the vehicle while it is very hot or cold outside. Vehicle interiors heat and cool very quickly. Do not lock the vehicle from the outside when there are passengers in the vehicle. Failure to follow these instructions could lead to serious injury or death.

⚠ CAUTION

Do not unnecessarily open and close the door repeatedly or with excessive force. Such action can damage the vehicle door.

* NOTICE

Always place the ENGINE START/STOP button in the OFF position, engage the parking brake, close all windows, and lock all doors when leaving your vehicle unattended.

- If you lock the door with the central door lock button (2), all vehicle doors will lock automatically.

* NOTICE

Always remove the ignition key, engage the parking brake, close all windows, and lock all doors when leaving your vehicle unattended.

Door locks inside the vehicle

Unlocking with the door handle



- **Front door**
If the inner door handle is pulled when the door is locked, the door will unlock and open.
- **Rear door**
If the inner door handle is pulled once when the door is locked, the door will unlock.
If the inner door handle is pulled once more, the door will open.

Door lock malfunction

If a power door lock ever fails to function while you are in the vehicle, try one or more of the following techniques to exit:

- Operate the door unlock feature repeatedly (both electronic and manual) while simultaneously pulling on the door handle.
- Operate the other door locks and handles, front and rear.
- Lower a front window and use the key to unlock the door from outside.
- Move to the cargo area and open the liftgate.

⚠ WARNING

Do not pull the inner door handle of driver's (or passenger's) door while the vehicle is moving. The door could open resulting in serious injury or death.

Locking/unlocking with the central door lock/unlock button

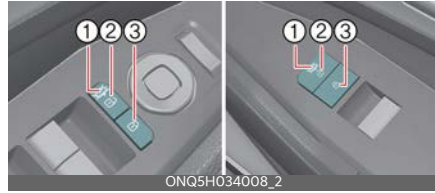

- 1 Door indicator light
- 2 Door unlock button
- 3 Door lock button

Operate by pressing the central door lock switch.

- To lock all vehicle doors, press the central door lock button (3) of driver and passenger side.
- To unlock all vehicle doors, press central door unlock button (2) of driver and passenger side.

When all vehicle doors are locked, the indicating lights (1) on the driver's door and passenger's door will turn off. If any door is unlocked, it will go on.

Any door is opened, the doors will not lock even though the central door lock switch is pressed.

⚠ WARNING

Doors

- The doors should always be fully closed and locked while the vehicle is in motion to prevent accidental opening of the door. Locked doors will also discourage potential intruders when the vehicle stops or slows down.
- Be careful when opening doors and watch out for vehicles, motorcycles, bicycles or pedestrians approaching the vehicle in the path of the door. Opening a door when something is approaching can result in an accident

to cause vehicle damage or serious injury.

* NOTICE

Unlocked vehicles

Leaving your vehicle unlocked can increase the risk of vehicle theft or any possible criminal harm caused by someone hiding in your vehicle while you are gone. Always remove the ignition key, engage the parking brake, close all windows and lock all doors when leaving your vehicle unattended.

⚠ WARNING

Unattended children, the elderly or pets

An enclosed vehicle can become extremely hot, causing death or severe injury such as heatstroke to unattended children, the elderly or pets who cannot escape the vehicle. When left or trapped in a hot vehicle, make sure to stay hydrated and avoid sun exposure through the vehicle's windshield. Furthermore, children might operate features of the vehicle that could injure them, or they could encounter other harm, possibly from someone gaining entry to the vehicle. Never leave children or animals unattended in your vehicle.

Door lock/unlock features

The vehicle is equipped with door lock/unlock features for the safety and convenience of passengers.

Impact sensing door unlock system

All doors will automatically unlock when an impact causes the air bags to deploy.

Speed sensing door lock system

All doors will automatically lock after the vehicle speed exceeds 10 mph (15 km/h).

You can activate or deactivate the auto door lock/unlock features in the vehicle. Refer to "LCD display" on page 5-89.

Auto lock enable on shift

When this feature is set in the cluster or infotainment system screen, all the doors will be locked automatically when the vehicle is shifted out of P (Park) while the vehicle is running.

Auto unlock on shift to P

When this feature is set in the infotainment system screen, all the doors will be unlocked automatically when the vehicle is shifted back into P (Park).

Auto unlock vehicle off

When this feature is set in the cluster or infotainment system screen, all the doors will be unlocked automatically when the vehicle is turned off. All doors will automatically lock after the vehicle speed exceeds 9 mph (15 km/h).

Manual door lock switch

If the electrical power door lock switch is not operating (e.g., dead car battery) the only way to lock the door(s) is with the mechanical key from the outside keyhole.

Doors without an outside keyhole can be locked as follows:

1. Open the door.
2. Insert the key into the door lock hole and turn the key to the lock position as shown.



3. Close the door securely.

* NOTICE

If electrical power to the door lock switch is not operating (e.g., dead car battery) and the liftgate is closed, you will not be able to open the liftgate until power is restored.

Child-protector rear door lock

The child safety lock is provided to help prevent children from accidentally opening the rear doors from inside the vehicle.



The rear door safety locks should be used whenever children are in the vehicle.

The child safety lock is located on the edge of each rear door. When the child safety lock is in the lock position (1), the rear door will not open if the inner door handle is pulled.

To lock the child safety lock, insert a key (or screwdriver) into the hole and turn it to the lock position.

To allow a rear door to be opened from inside the vehicle, unlock the child safety lock.

To open the rear door, pull the outside door handle (2).

⚠ WARNING

Rear door locks

If children accidentally open the rear doors while the vehicle is in motion, they could fall out and be severely injured or killed. To prevent children from opening the rear doors from the inside, the rear

door safety locks should be used whenever children are in the vehicle.

⚠ WARNING

- The system does not detect every obstacle approaching the vehicle exit.
- The driver and passenger are responsible for the accident occurred while exiting the vehicle. Always check the surrounding before you exit the vehicle.

Rear Occupant Alert (ROA) System

The ROA is provided to help prevent exiting the vehicle with a rear passenger left in the vehicle.

- When you open the front door after opening and closing the rear door and turning off the engine, the "Check rear seats" warning message appears on the cluster.

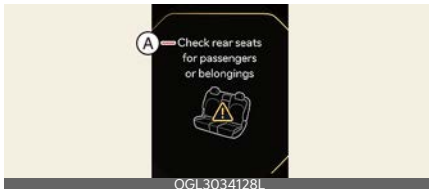

A: Check rear seat for passengers and belongings

You can activate or deactivate the ROA from the User Settings mode in the cluster LCD display. If your vehicle is equipped with an infotainment system, you can learn how to set up on the website via QR code in the infotainment quick reference guide.

The option can be found under the following menu:

1. Press the MODE button (⏸) several times on the steering wheel until 'User Settings' menu appears on the LCD.
2. Select **Convenience** → **Rear Occupant Alert** with the MOVE switch (↙ / ↘) and the OK button on the steering wheel.

If your vehicle is equipped with the infotainment system, the option can be found under the following menu:

1. Press the SETUP button of the infotainment system.
2. Press **Vehicle** → **Convenience** → **Rear Occupant Alert** on the infotainment system screen.

⚠ WARNING

The Rear Occupant Alert (ROA) system uses the door opening and closing history to issue a reminder. It does not actually detect objects or people in the rear seats. Check the rear seat for occupants before leaving the vehicle. Failure to do so can lead to serious injury or death.

⚠ CAUTION

- The ROA system uses a rear door opened and closed history.
- The history is reset after the vehicle is in OFF position, exits the vehicle and locks the door remotely. So even if a rear door does not reopen, the ROA system alert can occur.
- For example, if the driver does not lock the door and drives again even after the ROA alert occurs, the alert can occur.

Integrated memory system (if equipped)

The integrated memory system is provided to store and recall the following memory settings with a simple button operation.



- Driver's seat position
- Outside rear view mirror
- Head-Up Display (HUD)

⚠ WARNING

Never attempt to operate the integrated memory system while the vehicle is moving.

This could result in loss of control, and an accident causing death, serious injury, or property damage.

* NOTICE

- If the battery is disconnected, the memory settings will be erased.
- If the integrated memory system does not operate normally, have the system checked by an authorized Kia dealer.

Storing memory positions

1. The ENGINE START/STOP button is in the ON position.
2. Adjust the driver's seat position, outside rearview mirror position and head-up display height to the desired position.
3. Press one of the memory buttons (1 or 2) for more than 1 second. The system will beep twice.
4. "Settings 1 (or 2) saved" will appear on the LCD display.

Recalling memory positions

1. The ENGINE START/STOP button is in the ON position.
2. Press the desired memory button (1 or 2). The system will beep once, and then the driver's seat position, outside rearview mirror position and head-up display height will automatically adjust to the stored positions.
3. **Settings 1 (or 2) applied** will appear on the LCD display.

* NOTICE

- While recalling the "1" memory position, pressing 1 button temporarily stops the adjustment of the recalled memory position. Pressing the 2 button recalls the "2" memory position.
- While recalling the "2" memory position, pressing "2" button temporarily stops the adjustment of the recalled memory position. Pressing the "1" button recalls the "1" memory position.
- While recalling the stored positions, pressing one of the control buttons for the driver's seat and instrument panel illumination will cause the movement of that component to stop

and move in the direction that the control button is pressed.

Resetting the System

Take the following procedures to reset integrated memory system, when it does not operate properly.

Resetting integrated memory system

1. Stop the vehicle and open the driver's door with the Start/Stop button in the ON position and the vehicle shifted to P (Park).
2. Adjust the driver's seat and seatback to the foremost position.
3. Press the memory button 1 (or 2) and push forward the driver's seat movement switch over 2 seconds simultaneously.

While resetting integrated memory system

1. Resetting starts with a notification sound.
2. The driver's seat and seatback is adjusted to the rearward position with the notification sound.
3. The driver's seat and seatback is re-adjusted to the default position (central position) with the notification sound.

However, in the following cases, the resetting procedure and the notification sound may stop.

- The memory button is pressed.
- The seat control switch is operated.
- The gear is shifted out of P (Park).
- The driving speed exceeds 2 mph (3 km/h).
- The driver's door is closed.

* NOTICE

- While integrated memory system is being reset, if the resetting and notification sound stops incompletely, restart the resetting procedure again.
- Make sure that there is no objects around the driver's seat in advance of resetting the integrated memory system.
- After resetting the integrated memory system, the adjustment for the driver seat must be stored again to recall the memory position.

Seat easy access

Seat easy access will move the driver's seat and steering wheel automatically as follows:

Exiting the vehicle:

The driver's seat will move as follows when the Start/Stop button is in the OFF position with the gear in P (Park) and the driver's door open.

- Driver seat: Moves rearward depending on the distance selected from the Settings menu in the infotainment system. However, the driver's seat may not move rearward if there is not enough space between the driver's seat and the rear seats.

Entering the vehicle:

The driver's seat will move as follows when the Start/Stop button is pressed to the ACC, ON or START position or while carrying the smart key, the driver's door is closed with the Start/Stop button in the OFF position.

- Driver seat: Moves back to its original position.

You can set the Seat Easy Access function from the Settings menu in the infotainment system screen

- Driver seat Select: **Setup** → **Vehicle Settings** → **Seat** → **Seating Easy Access** → **Driver Seat Easy Access** → **Normal/Extended/Off**



Liftgate

⚠ WARNING

Exhaust fumes

If you drive with the liftgate open, you will draw dangerous exhaust fumes into your vehicle which can cause serious injury or death to vehicle occupants.

If you must drive with the liftgate open, keep the air vents and all windows open so that additional outside air comes into the vehicle.

⚠ WARNING

Rear cargo area

Occupants should never ride in the rear cargo area where no restraints are available. To avoid injury in the event of an accident or sudden stops, occupants should always be properly restrained.

Opening the liftgate

The liftgate is locked or unlocked when all doors are locked or unlocked with the key, smart key or central door lock/unlock switch.

⚠ CAUTION

Liftgate lift

Make sure that you close the liftgate before driving your vehicle. Possible damage may occur to the liftgate gas lifters and attached hardware if the liftgate is not closed prior to driving.



ONQ5H034011_2

- The liftgate is locked or unlocked when all doors are locked or unlocked with the transmitter (or smart key) or central door lock switch.
- If unlocked, the liftgate can be opened by pressing the handle and pulling it up.
- Once the liftgate is opened and then closed, the liftgate locks automatically. (All doors must be locked.)

*** NOTICE**

In cold and wet climates, door lock and door mechanisms may not work properly due to freezing conditions.

WARNING

The liftgate swings upward. Make sure no objects or people are near the rear of the vehicle when opening the liftgate.

Closing the liftgate



ONQ5035066N

- To close the liftgate, lower and push down the liftgate firmly. Make sure that the liftgate is securely latched.

WARNING

Make sure your hands, feet and other parts of your body are safely out of the way before closing the liftgate.

WARNING

Exhaust fumes

The liftgate lid should be always kept completely closed while the vehicle is in motion. If it is left open or ajar, poisonous exhaust gases may enter the car and serious illness or death may result.

CAUTION

Make sure nothing is near the liftgate latch and striker while closing the liftgate. It may damage the liftgate's latch.

Emergency liftgate safety release



To unlock and open the liftgate manually from inside the luggage compartment, perform the following procedure:

1. Insert a long, flat object into the opening at the bottom of the liftgate.
2. Slide the latch in the direction of the arrow to unlock the liftgate.
3. Push the liftgate to open.

⚠ WARNING

- For emergencies, be fully aware of the location of the emergency liftgate safety release latch in the vehicle and how to open the liftgate if you are accidentally locked in the luggage compartment.
- No one, including animals, should be allowed to occupy the luggage compartment of the vehicle at any time. The luggage compartment is a very dangerous location in the event of an accident.
- Use the release latch for emergencies only. Use extreme caution, especially while the vehicle is in motion.

Power liftgate (if equipped)

Power liftgate operating conditions

The power liftgate operates when the gear is in P (Park) with the engine running. However, the power liftgate will operate regardless of the gear position when the engine is off. Also, the liftgate can be opened only when vehicle speed is below 1.8 mph (3 km/h).

For safety, before attempting to open or close the liftgate, make sure the vehicle is in P (Park).

⚠ WARNING

- Never leave children or animals unattended in your vehicle. Children may operate the power liftgate. Doing so can result in injury to themselves or others and can damage the vehicle.



1. 27.6 in (70 cm)
2. 27.6 in (70 cm)

Make sure that there are no people or objects in the path of the power liftgate or smart liftgate prior to use. Serious injury, damage to the vehicle or damage to surrounding objects (for example, walls, ceilings, vehicles, etc.) may result if contact with the liftgate occurs.

- The liftgate may not open or may close unintentionally injuring people around the liftgate under the following situation:

- There is a lot of snow on the liftgate.
- There is a heavy object on the liftgate such as a bicycle carrier, ladder, etc.
- Do not open the liftgate before removing snow or heavy object on the liftgate.

* NOTICE

- Do not close or open the liftgate manually. This may cause damage to the power liftgate. If it is necessary to close or open the liftgate manually when the battery is discharged or disconnected, do not apply excessive force.
- Do not operate the power liftgate more than 10 times continuously when the engine is not running. Use the power liftgate with the engine running when the power liftgate is used repeatedly to prevent battery discharge.
- Do not leave the power liftgate open for a long period of time. This may drain the battery.
- Do not apply excessive force when the power liftgate is operating. Doing so could result in vehicle damage.



ONQ5H0340T3

Do not grab or hold on to the liftgate support struts at any time. Damage to the liftgate support struts could result. Deformation of the liftgate support

struts may cause vehicle damage and personal injury may occur.

- Do not modify or repair any part of the power liftgate by yourself. This must be done by an authorized Kia dealer.
- Do not operate the power liftgate under the following conditions. The power liftgate may not operate properly.
 - One side of the vehicle is lifted to inspect the vehicle or change a tire
 - Parking on an uneven road such as a slope, etc.
- Close the liftgate completely and lock all doors and liftgate using the central door lock button before using an automatic car wash.
- Do not spray high pressure water directly on the power liftgate outside open/close button. The liftgate may open unintentionally.

* INFORMATION

- If the liftgate is not fully closed and vehicle speed is at or above 1.8 mph (3 km/h), a warning will sound 10 times. Immediately park the vehicle at a safe place, close the liftgate, and check that the liftgate open warning on the instrument cluster is turned off.
- In cold and wet climates, the outside power liftgate open/close button may not work properly due to freezing conditions. If this occurs, remove the ice before using the outside power liftgate open/close button or use the power liftgate open/close button on the smart key or the instrument panel.
- Operating the power liftgate more than 5 times continuously could cause damage to the operating motor. If this

occurs, the power liftgate will not operate to prevent the motor from overheating. If any of the power liftgate buttons are pressed to try to open the liftgate, the chime will sound 3 times, but the liftgate will remain closed. Allow the power liftgate system to cool for about 1 minute before operating the system again.

Operating the power liftgate



Power liftgate open/close button (Smart key, Instrument panel) (1)

When the liftgate is closed, press the power liftgate open/close button for 1 second. The power liftgate opens with a warning sound.

While the liftgate is opening, press the button to stop liftgate operation.

When the power liftgate is opened, press and hold the power liftgate open/close button to close the liftgate. If you release the button while the liftgate is closing,

power liftgate operation will stop with a warning sound for 5 seconds.

Also, if the smart key is not within operation range (approximately 10 m) from the vehicle, power liftgate operation will stop with a warning sound for 5 seconds.

▲ WARNING

Make sure that there are no people or objects in the path of the liftgate before pressing the open/close button inside the power liftgate and the smart key. Otherwise, this may cause serious injury or damage to the vehicle or object.

Power liftgate open/close button (Outside the power liftgate) (2)

When the liftgate is closed, press the power liftgate open/close button to open the liftgate.

If the vehicle is locked, press the power liftgate open/close button with the smart key in your possession.

If the liftgate is unlocked, the liftgate will open or close with a warning sound when the power liftgate open/close button is pressed without carrying the smart key.

Power liftgate open/close button (Inside the power liftgate) (3)

Press the power liftgate open/close button. The liftgate opens or closes automatically.

Automatic reverse

During power liftgate operation if the power liftgate senses any obstacle, the liftgate will stop or will fully open. The automatic reverse feature may not operate properly, or it may operate unexpectedly under the following circumstances:

- The automatic reverse feature may not detect the resistance if the detected resistance is below a certain level, or if the liftgate is almost fully closed near the latched position.
- The automatic reverse feature may operate if a strong impact is applied with no obstructions placed.

⚠ WARNING

Never intentionally place any object or part of your body in the path of the power liftgate to make sure the automatic reverse feature operates. Serious injury, or damage to the vehicle or object may occur.

*** INFORMATION**

The power liftgate may stop operating if the automatic reverse feature operates more than two times while attempting to open or close the liftgate. If this occurs, carefully open or close the liftgate manually, and then after 30 seconds try to operate the power liftgate automatically again.

Setting the power liftgate

To use each feature, you must select the opening speed or opening height from the settings menu. Deselect the settings when you do not want to use the feature.

Power liftgate opening speed

To adjust the power liftgate speed, Select **Setup** → **Vehicle Settings** → **Door** → **Power Liftgate Opening Speed** → **Fast/Normal** in the infotainment system. (Default setting is **Fast**).

Power liftgate opening height

To adjust the power liftgate opening height, select **Setup** → **Vehicle Settings** → **Door** → **Power Liftgate Opening Height** → **Full Open/Level 3/Level 2/Level 1/User Height Setting** in the infotainment system.

*** INFORMATION**

The infotainment system may change after updates. For detailed information on system settings, see additional information in supplied Infotainment Manual.

User height setting

1. Position the liftgate manually to the height you prefer.
2. Press the power liftgate open/close button located inside the liftgate for more than approximately 3 seconds.

If **User Height Setting** is selected for the power liftgate opening height, the power liftgate will automatically open to the height manually set by you.

*** INFORMATION**

- If the power liftgate opening height has not been manually set, the power liftgate will fully open when 'User Height Setting' from the infotainment system is selected.
- If one of the height setting (**Full Open/Level 3/Level 2/Level 1/User Height Setting**) is selected from the settings menu in the infotainment system, and then 'User Height Setting' is selected, the liftgate will open to the height manually set by you.
- The power liftgate opening speed and opening height settings change according to the linked User Profile. If the User Profile is changed, power liftgate opening speed and opening

height settings will change accordingly.

Resetting the power liftgate

power liftgate operation may need to be performed. Some instances where resetting the power liftgate may be required include:

- When the 12-volt battery is recharged
- When the 12-volt battery is reinstalled after removal or replacement
- When the related fuse is reinstalled after removal or replacement



1. With the engine off or running, put the gear in P (Park).
2. Press the power liftgate open/close button inside the liftgate and the power liftgate open/close button outside the vehicle simultaneously until a chime sounds.
3. Slowly close the liftgate manually.
4. Press the power liftgate open/close outer button. The power liftgate will open with a chime sound.
Wait until the liftgate fully opens to complete resetting. If the liftgate stops before it is fully open, resetting cannot be completed.

* INFORMATION

If the power liftgate does not operate properly after the above procedure, this must be done by an authorized Kia dealer.

Emergency liftgate safety release



To unlock and open the liftgate manually from inside the luggage compartment, perform the following procedure:

1. Insert a long, flat object into the opening at the bottom of the liftgate.
2. Slide the latch in the direction of the arrow to unlock the liftgate.
3. Push the liftgate to open.

⚠ WARNING

- For emergencies, be fully aware of the location of the emergency liftgate safety release latch in the vehicle and how to open the liftgate if you are accidentally locked in the luggage compartment.
- No one, including animals, should be allowed to occupy the luggage compartment of the vehicle at any time. The luggage compartment is a very dangerous location in the event of an accident.
- Use the release latch for emergencies only. Use extreme caution, especially while the vehicle is in motion.

Smart Liftgate with Auto Open (if equipped)

On a vehicle equipped with a smart key, the liftgate can be opened using the Smart Liftgate with Auto Open system.



How to use the Smart Liftgate with Auto Open

The liftgate can be opened with no-touch activation under the conditions below.

- After 15 seconds when all doors are closed and locked
- Positioned in the detecting area for more than 3 seconds.

* NOTICE

The Smart Liftgate with Auto Open does not operate when:

- The smart key is detected within 15 seconds after the doors are closed and locked and is continuously detected.
- The smart key is detected within 15 seconds after the doors are closed and locked, and 5 ft (1.5 m) from the front door handles.
- A door is not locked or closed.
- The smart key is in the vehicle.

1. Setting

To activate the Smart Liftgate with Auto Open, go to '**Vehicle** → **Door** → **Smart Liftgate**' on the LCD display.

2. Detect and Alert



If you are positioned within the detecting area (40 inches [100 cm] behind the vehicle) carrying a smart key, the hazard warning lights will blink and chime will sound to alert you that the smart key has been detected and the liftgate will open.

* NOTICE

Do not approach the detecting area if you do not want the liftgate to open. If you have unintentionally entered the detecting area and the hazard warning lights and chime starts to operate, leave the detecting area with the smart key. The liftgate will stay closed.

3. Automatic opening



The hazard warning lights will blink and chime 6 times and then the liftgate will open.

⚠ WARNING

- Make sure you close the liftgate before driving your vehicle.
- Make sure there are no people or objects around the liftgate before opening or closing the liftgate.
- Make sure objects in the cargo area do not fall out when opening the liftgate on a slope. It may cause serious injury.
- Make sure to deactivate the Smart Liftgate with Auto Open when washing your vehicle. Otherwise, the liftgate may open inadvertently.
- The key should be kept out of reach of children. Children may inadvertently open the Smart Liftgate with Auto Open while playing around the rear area of the vehicle.

⚠ CAUTION

Liftgate lift

Make certain that you close the liftgate before driving your vehicle. Possible damage may occur to the liftgate gas lifters and attached hardware if the liftgate is not closed prior to driving.

How to deactivate the Smart Liftgate with Auto Open function using the smart key



OMQ4033461

- 1 Door lock button
- 2 Door unlock button

- 3 Power liftgate open/close button
- 4 Panic button
- 5 Remote start button

If you press any button of the smart key during the Detect and Alert stage, the Smart Liftgate with Auto Open function will be deactivated.

Make sure to be aware of how to deactivate the Smart Liftgate with Auto Open function for emergency situations.

*** NOTICE**

- If you press the door unlock button (2), the Smart Liftgate with Auto Open function will be deactivated temporarily. But, if you do not open any door for 30 seconds, the Smart Liftgate with Auto Open function will be reactivated.
- If you press the liftgate open button (3) for more than 1 second, the liftgate opens.
- If you press the door lock button (1) or liftgate open button (3) when the Smart Liftgate with Auto Open function is not in the Detect and Alert stage, the Smart Liftgate with Auto Open function will not be deactivated.
- In case you have deactivated the Smart Liftgate with Auto Open function by pressing the smart key button and opened a door, the Smart Liftgate with Auto Open function can be activated again by closing and locking all doors.

Detecting area



- The Smart Liftgate with Auto Open operates with a welcome alert if the smart key is detected within 40 inches (100 cm) from the liftgate.
- The alert stops at once if the smart key is positioned outside the detecting area during the Detect and Alert stage.

* NOTICE

- The Smart Liftgate with Auto Open function will not work if any of the following occurs:
 - The smart key is close to a radio transmitter such as a radio station or an airport which can interfere with normal operation of the transmitter.
 - The smart key is near a mobile two-way radio system or a cellular phone.
 - Another vehicle's smart key is being operated near your vehicle.
- The detecting range may decrease or increase when:
 - One side of the tire is raised to replace a tire or to inspect the vehicle.

- The vehicle is parked on a slope or unpaved road, etc.

Emergency liftgate safety release



To unlock and open the liftgate manually from inside the luggage compartment, perform the following procedure:

1. Insert a long, flat object into the opening at the bottom of the liftgate.
2. Slide the latch in the direction of the arrow to unlock the liftgate.
3. Push the liftgate to open.

⚠ WARNING

- For emergencies, be fully aware of the location of the emergency liftgate safety release latch in the vehicle and how to open the liftgate if you are accidentally locked in the luggage compartment.
- No one, including animals, should be allowed to occupy the luggage compartment of the vehicle at any time. The luggage compartment is a very dangerous location in the event of an accident.
- Use the release latch for emergencies only. Use extreme caution, especially while the vehicle is in motion.

Windows

The doors of this vehicle are equipped with power windows that can be operated by a switch.

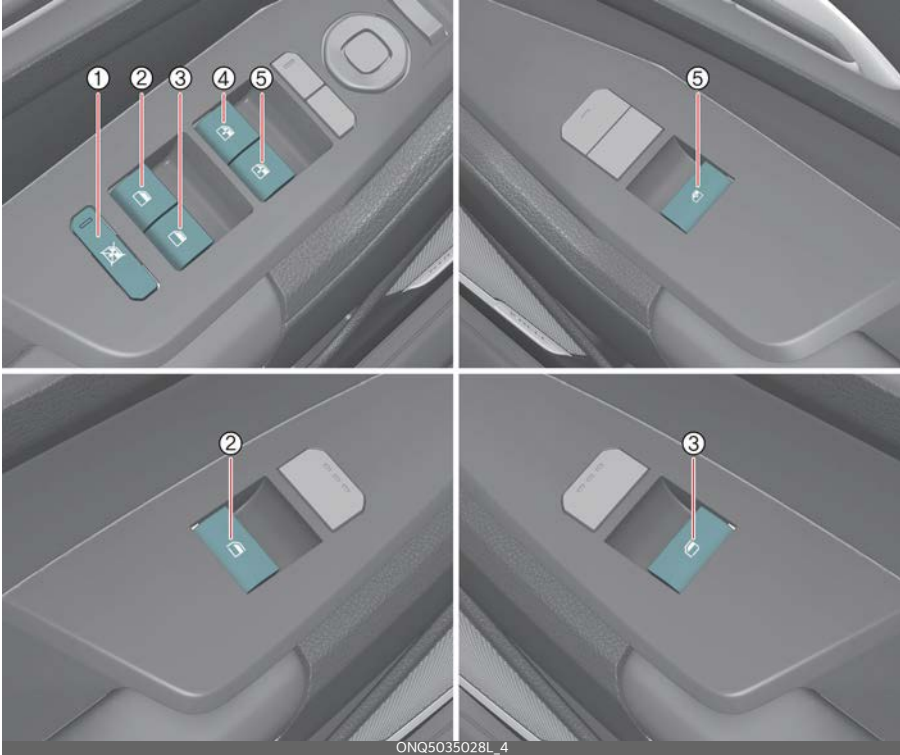

- 1 Power window lock switch
- 2 Rear door (left) power window switch
- 3 Rear door (right) power window switch
- 4 Driver's door power window switch
- 5 Front passenger's door power window switch

*** NOTICE**

In cold and wet climates, power windows may not work properly due to freezing conditions.

The ENGINE START/STOP button must be in the ON position for power windows to operate.

Each door has a power window switch that controls the door's window. The driver has a power window lock button which can block the operation of rear passenger windows. The power windows can be operated for approximately 3 minutes after ignition switch or ENGINE START/STOP button turned to the ACC or LOCK position. However, if the front doors are opened, the power windows cannot be operated even within the 3 minutes period.

The driver's door has a master power window switch that controls all the windows in the vehicle.

If the window cannot be closed because it is blocked by objects, remove the objects and close the window.

*** NOTICE**

While driving with the rear windows down or with the sunroof (if equipped) in an open (or partially open position), your vehicle may demonstrate a wind buffeting or pulsation noise. This noise is a normal occurrence and can be reduced or eliminated by taking the following actions. If the noise occurs with one or both of the rear windows down, partially lower both front windows approximately 1 inch (2.5 cm). If you experience the noise with the sunroof open, slightly reduce the size of the sunroof opening.

⚠ CAUTION

Do not install any accessory in the vehicle that extends into the open window area. Such an object will impact the proper function of the Automatic reversal "jam protection" feature.

*** NOTICE**

If you press the one-touch window button for micro adjustment, the glass will go down to a specific location for your convenience.

Window opening and closing

You can open and close windows using the power window switch.

**Type A**

To open or close a window, press down or pull up the front portion of the corresponding switch to the first detent position (1).

Type B - Auto up/down window (if equipped)

Pressing or pulling up the power window switch momentarily to the second detent position (2) completely lowers or raises the window even when the switch is released. To stop the window at the desired position while the window is in operation, pull up or press down and release the switch.

To reset the power windows

If the power window does not operate normally, the automatic power window system must be reset as follows:

1. Turn the ENGINE START/STOP button to the ON position.
2. Close the window and continue pulling up the power window switch for at least 1 second after the window is completely closed.

Automatic reversal (if equipped)



If the upward movement of the window is blocked by an object or part of the body, the window will detect the resistance and will stop upward movement. The window will then lower approximately 12 inches (30 cm) to allow the object to be cleared.

If the window detects the resistance while the power window switch is pulled up continuously, the window will stop upward movement and then lower approximately 1 inch (2.5 cm).

If the power window switch is pulled up continuously again within 5 seconds after the window is lowered by the automatic window reversal feature, the automatic window reversal will not operate.

* NOTICE

The automatic reverse feature for the window is only active when the "auto up" feature is used by fully pulling up the switch. The automatic reverse feature will not operate if the window is raised using the halfway position on the power window switch.

⚠ WARNING

Always check for obstructions before raising any window to avoid injuries or vehicle damage. If an object less than 0.16 of an inch (4 mm) in diameter is caught between the window glass and the upper window channel, the automatic reverse window may not detect the resistance and will not stop and reverse direction.

⚠ WARNING

The automatic reverse feature doesn't activate while resetting the power window system. Make sure body parts or other objects are safely out of the way before closing the windows to avoid injuries.

⚠ CAUTION

Do not install any accessory in the vehicle that extends into the open window area. Such objects could prevent the automatic reverse feature from functioning.

Power window lock button

The driver can disable the power window switches for the rear passengers' doors by pressing the power window lock button to the lock position (pressed).



When the power window lock button is pressed:

- The driver's master control can operate all passengers' power windows.
- The front passenger's control can operate the front passenger's power window.
- The rear passengers' control cannot operate the rear passenger's power window.

CAUTION

- To prevent damage to the power window system, do not open or close two windows or more at the same time. This will also ensure the longevity of the fuse.
- Never try to operate the main switch on the driver's door and the individual door window switch in opposite directions at the same time. If this is done, the window will stop and cannot be opened or closed.

WARNING

Windows

- NEVER leave the keys in your vehicle with unsupervised children, when the engine is running.
- NEVER leave any child unattended in the vehicle. Even very young children may inadvertently cause the vehicle to move, entangle themselves in the windows, or otherwise injure themselves or others.
- Always double check to make sure all arms, hands, heads or other obstructions are safely out of the way before closing a window.
- Do not allow children play with the power windows. Keep the driver's door power window lock button in the LOCK position (pressed). **SERIOUS INJURY** can result from unintentional window operation by a child.
- Do not extend heads or any limbs outside the window while the vehicle is in motion.

5

Remote window opening (if equipped)



You can still control the window movement with the vehicle turned off. Press the door unlock button (1) for more than 3 seconds. The window moves down after the doors are unlocked, as long as you press the door unlock button (1).

The window movement stops, when you release the door unlock button (1).

* The remote window function is operated on the window equipped with an auto up/down window.

⚠ CAUTION

- If you exit the vehicle with the windows down, theft could occur. Water damage could also occur while raining.
- The remote window opening function may abruptly stop, when you move away from your vehicle during operation. Stay close to your vehicle, while monitoring the window movement.
- One of the windows may stop operating, when the window is interrupted by certain force. However, the other windows will keep operating. Thus, you should make sure that all windows are opened.
- Be careful when using the remote window opening function, as the doors will be unlocked.

Hood

The hood serves as a cover for the engine compartment.

Open the hood if maintenance work needs to be performed in the engine compartment or if you need to look at the compartment.

Opening the hood

1. Pull the release lever (1) to unlatch the hood. The hood should slightly pop open.
2. Go to the front of the vehicle, raise the hood slightly, push the secondary hood release lever (2) to the left and lift the hood.

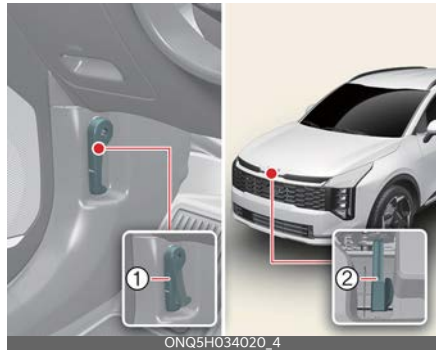

3. Pull out the support rod.
4. Hold the hood opened with the support rod (3).



⚠ WARNING**Support rod**

- After opening the hood, the support rod must be inserted completely into the hole provided to keep the hood up and to prevent the hood from falling and possibly injuring someone.
- If the engine is hot, grab the support rod by the area wrapped in rubber to prevent burns.

Hood open warning

The hood warning message will appear on the LCD display when hood is open.

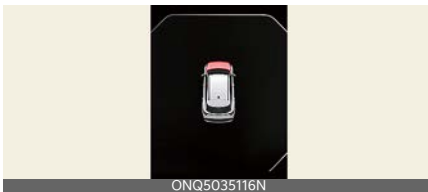

The warning chime will operate when the vehicle is being driven at or above 2 mph (3 km/h) with the hood open.

Closing the hood

1. Before closing the hood, check the following:
 - All filler caps in the engine compartment must be correctly installed.
 - Gloves, rags or any other combustible material must be removed from the engine compartment.

2. Return the support rod to its clip to prevent it from rattling.
3. Lower the hood until it is about 12 inches. (30 cm) above the closed position and let it drop. Make sure that it locks into place.
4. Check that the hood has engaged properly.
 - If the hood can be raised slightly, it is not properly engaged.
 - Open it again and close it with a little more force.

⚠ CAUTION**Hood obstruction**

Before closing the hood, ensure that all obstructions are removed from the hood opening. Closing the hood with an obstruction present inside the hood opening may result in severe personal injury or property damage.

⚠ WARNING**Fire risk**

Do not leave gloves, rags or any other combustible material in the engine compartment. Doing so may cause a heat-induced fire.

⚠ WARNING**Unsecured hood**

Always double check to be sure that the hood is firmly latched before driving away. If it is not latched, the hood could fly open while the vehicle is being driven, causing a total loss of visibility, which may result in an accident.

Fuel filler door

The vehicle's fuel filler door must be opened and closed by hand from outside the vehicle.

Opening the fuel filler door (hybrid vehicle)

1. Turn the engine off.
2. Ensure Driver's door is unlocked.
3. Press the rear center edge of the fuel filler door.
4. Pull the fuel filler door (1) out to fully open.



5. To remove the fuel tank cap (2), turn it counterclockwise. You may hear a hissing noise as the pressure inside the tank equalizes.
6. Place the cap on the fuel filler door.

* NOTICE

The fuel filler door will unlock when all doors are unlocked

To unlock fuel filler door:

- Press the unlock button on your smart key
- Press the Central Door unlock button on armrest trim of driver's door
- Pull the driver's inside door handle outward

The fuel filler door will lock when all doors are locked.

To lock fuel filler door:

- Press the lock button on your smart key

- Press the Central Door lock button on armrest trim of driver's door
- * All doors will automatically lock after the vehicle speed exceeds 9 mph (15 km/h).

Fuel door is also locked when vehicle speed exceeds 9 mph (15 km/h).

▲ CAUTION

Before refueling, be sure to check what type of fuel is used for your vehicle.

If you put diesel fuel into a gasoline-powered vehicle, it may affect the fuel system and cause serious damage to the vehicle.

* NOTICE

- If the fuel filler door does not open because ice has formed around it, tap lightly or push on the door to break the ice and release the door. Do not pry on the door. If necessary, spray around the door with an approved deicer fluid (do not use radiator anti-freeze) or move the vehicle to a warm place and allow the ice to melt.
- If the fuel filler door does not open under certain conditions, such as an electrical malfunction, contact an authorized Kia dealer

Opening the fuel filler door (Plug-in hybrid vehicle)

1. Stop the engine. To open the fuel filler door, push the fuel filler door opener button.



2. Wait until the fuel tank is depressurized. The message is displayed when the fuel filler door unlocks after the fuel tank is depressurized.



A: Unlocking fuel door...

3. The fuel door is unlocked when the message is displayed.

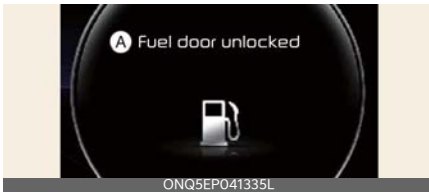

A: Fuel door unlocked

4. The fuel door is opened when the message is displayed.



A: Fuel door open

5. Pull open the fuel filler door (1).

To remove the cap, turn the fuel filler cap (2) counterclockwise.

Refuel as needed.



* NOTICE

- It may take up to 20 seconds to unlock fuel filler door.
- If the fuel filler door does not open because ice has formed around it, tap lightly or push on the door to break the ice and release the door.
- Do not pry on the door. If necessary, spray around the door with an approved deicer fluid (do not use radiator anti-freeze) or move the vehicle to a warm place and allow the ice to melt.
- If fuel filler door does not open in certain circumstances such as electrical malfunction, have the vehicle inspected by an authorized Kia dealer.

⚠ WARNING

Before refueling, be sure to check what type of fuel is used for your vehicle. If you put diesel fuel into a gasoline-powered vehicle or gasoline into a diesel-powered vehicle, it may affect the fuel system and cause serious damage to the vehicle.

*** NOTICE**

- Add fuel into the fuel tank within 20 minutes after opening the fuel filler door. After 20 minutes, the fuel tank may shut off, causing fuel to overflow. In this case, re-press the fuel filler door opening button.
- Do not leave the fuel filler door opened for an extended period. It may discharge the battery.
- Close the fuel filler door after fueling the vehicle. If you start the vehicle with the fuel filler door open, the "Check fuel door" message illuminates on the LCD display.
- Avoid refueling the vehicle while charging the (high-voltage) hybrid battery. It may cause a fire or an explosion due to static electricity.

Closing the fuel filler door

1. To install the fuel tank cap, turn it clockwise until it "Clicks".
2. Close the fuel filler door by pressing rear center edge of the fuel filler door.

*** NOTICE**

Make the vehicle door to LOCK position when the fuel filler door is completely closed in order to lock the fuel filler door.

If the fuel filler door is not completely closed, the fuel filler door will not be locked.

⚠ WARNING**Refueling**

Always remove the fuel cap carefully and slowly. If the cap is venting fuel or if you hear a hissing sound, wait until the condition stops before completely removing the cap.

If pressurized fuel sprays out, it can cover your clothes or skin and subject you to the risk of fire and burns.

*** NOTICE**

When refueling on unlevel ground, the fuel gauge may not point to the F position. It is not a malfunction. If you move your vehicle to a level ground, the fuel gauge will move to the full position.

*** NOTICE**

Tighten the cap until it clicks one time. Otherwise, the engine warning indicator light will illuminate.

⚠ CAUTION

Keep the door into LOCK position when the vehicle is being washed (i.e. high pressure washer, automatic car wash, etc.)

⚠ WARNING

Always tighten your fuel cap before you leave the fuel station. Failure to securely install your fuel cap can lead to fuel spillage in an accident and increase fire risk.

⚠ WARNING**Fire/explosion risk**

Read and follow all warnings posted at the gas station facility. Failure to follow all warnings will result in severe personal injury, severe burns or death due to fire or explosion.

⚠ WARNING**Static electricity**

- Before touching the fuel nozzle, you should eliminate potentially dangerous static electricity discharge by touching another metal part of the vehicle, a safe distance away from the fuel filler neck, nozzle, or other gas source.
- Do not get back into a vehicle once you have begun refueling since you can generate static electricity by touching, rubbing or sliding against any item or fabric (polyester, satin, nylon, etc.) capable of producing static electricity. Static electricity discharge can ignite fuel vapors resulting in rapid burning. If you must reenter the vehicle, you should once again eliminate potentially dangerous static electricity discharge by touching a metal part of the vehicle, away from the fuel filler neck, nozzle or other gasoline source.

⚠ WARNING**Portable fuel container**

When using an approved portable fuel container, be sure to place the container on the ground prior to refueling. Static electricity discharge from the container can ignite fuel vapors causing a fire. Once refueling has begun, contact with the vehicle should be maintained until

the filling is complete. Use only approved portable plastic fuel containers designed to carry and store gasoline.

⚠ WARNING**Cellular phone fires**

Do not use cellular phones while refueling. Electric current and/or electronic interference from cellular phones can potentially ignite fuel vapors causing a fire.

⚠ WARNING**Refueling & Vehicle fires**

When refueling, always shut the engine off. Sparks produced by electrical components related to the engine can ignite fuel vapors causing a fire. Once refueling is complete, check to make sure the filler cap and filler door are securely closed, before starting the engine.

⚠ WARNING**Smoking**

DO NOT use matches or a lighter and DO NOT SMOKE or leave a lit cigarette in your vehicle while at a gas station especially during refueling. Automotive fuel is highly flammable and can result in fire when ignited.

Make sure to refuel your vehicle according to "Fuel requirements" on page 2-2. If the fuel filler cap requires replacement, use only a genuine Kia cap or the equivalent specified for your vehicle. An incorrect fuel filler cap can result in a serious malfunction of the fuel system or emission control system.

⚠ CAUTION**Exterior paint**

Do not spill fuel on the exterior surfaces of the vehicle. Any type of fuel spilled on painted surfaces may damage the paint.

⚠ WARNING

- Do not allow anyone that has not discharged static electricity from their body to come close to an open fuel tank.
- Do not inhale vaporized fuel.

⚠ WARNING**Risk of injury from fuel**

Fuels are poisonous and harmful to your health.

- Fuel contains substances that are harmful if inhaled.
- Do not swallow fuel or let it contact skin, eyes or clothing.
- Do not inhale fuel vapors.
- Keep children away from fuel.

If you or other people come into contact with fuel, observe the following:

- Immediately rinse fuel off your skin with soap and water.
- If fuel contacts your eyes, immediately rinse them thoroughly with clean water. Seek medical attention immediately.
- If you swallow fuel, seek medical attention immediately. Do not induce vomiting.
- Change immediately out of clothing that has contacted fuel.

*** NOTICE****Damage caused by the wrong fuel**

Fuel that does not conform to the required quality can lead to increased wear as well as damage to the engine and exhaust system. Only use the fuel recommended.

*** NOTICE**

Do not use diesel to refuel vehicles with a gasoline engine.

*** NOTICE**

Do not press the ENGINE START/STOP button if you accidentally refuel with the wrong fuel. Otherwise, fuel can enter the fuel system.

Even small amounts of the wrong fuel could result in damage to the fuel system and the engine. Have the system serviced by an authorized Kia dealer.

*** NOTICE****Do not overfill the fuel tank**

Do not overfill the fuel tank. Fuel may spill, causing harm to the environment and damaging the vehicle.

⚠ WARNING

When using EV drive mode for a prolonged period without the engine running, the Engine Maintenance Mode (EMM) will automatically activate to protect the fuel system and the engine.

Even though it is possible to use EV drive mode with enough battery power, the engine may run by the system to protect the fuel system and engine. If you leave fuel in the tank without refueling for over 6 months, the remaining fuel

in the tank may deteriorate. Corrosion may occur.

It is recommended to use a minimum of 40% of remaining fuel at least every 6 months by selecting Hybrid (CS) mode and refueling with new fuel.

Panoramic sunroof (if equipped)

If your vehicle is equipped with a sunroof, you can slide or tilt your sunroof with the sunroof switch located on the overhead console.



The sunroof can only be operated when the Engine Start/Stop button is in the ON or START position.

The sunroof can be operated for approximately 3 minutes after the ENGINE START/STOP button is in the ACC or LOCK/OFF position. However, if the front door is open, the sunroof cannot be operated even within the 3 minutes.

⚠ WARNING

- Be sure to operate the sunroof while the car is stationary. If you operate the sunroof while driving, it may interfere with driving and cause an accident.
- Even when leaving the vehicle for a short time, turn off the ignition and carry the key to prevent children from operating the sunroof.
- Don't sit on the roof. Sitting on a roof or lifting heavy objects can damage the sunroof.

*** NOTICE**

Do not operate the sunroof when roof bars are installed on the vehicle or when there is luggage on the roof.

Power sunshade



Use the power sunshade to block direct sunlight coming through the sunroof glass.

- Push the sunroof switch rearward to the first detent position, the power sunshade automatically slides open.
- Push the sunroof switch forward to the first detent position, the power sunshade automatically closes. However, if the sunroof glass is open, the glass will close first.

To stop the power sunshade at any point, push the sunroof switch in any direction.

* NOTICE

Do not pull or push the power sunshade by hand as such action may damage the power sunshade or cause it to malfunction.

* INFORMATION

Wrinkles formed on the power sunshades are normal due to material characteristic.

Tilt open/close



- Push the sunroof switch upward, the sunroof glass tilts open. However, if the power sunshade is close, the sunshade will open first.
- Push the sunroof switch upward or forward when the sunroof glass is tilt opened, the sunroof glass automatically closes.

To stop the sunroof movement at any point, push the sunroof switch in any direction.

Slide open/close



- Push the sunroof switch rearward to the first detent position, the sunroof glass opens. However, if the power sunshade is in close condition, the power sunshade will open first. Push the sunroof switch forward to the first detent position, the sunroof glass closes. However, if the sunroof glass is in close condition, the power sunshade will close.
- Push the sunroof switch forward or rearward to the second detent position, the power sunshade and sunroof glass both close or open.

Automatic reversal



If the power sunshade or sunroof glass senses any obstacle while it is closing automatically, it will reverse direction then stop at a certain position.

The auto reverse function may not work if an object thin or soft is caught between the sliding power sunshade or sunroof glass and sunroof sash.

⚠ WARNING

- Make sure heads, hands, arms or any other body parts or objects are out of the way before operating the sunroof. Body parts or objects may get caught causing injuries or vehicle damage.
- Never deliberately use your body parts to test the automatic reversal function. The power sunshade or sunroof glass may reverse direction, but there is a risk of injury.

* NOTICE

- Do not continue to push the sunroof switch after the sunroof is fully opened, closed, or tilted. Damage to the sunroof motor could occur.
- Continuous operations such as slide open/close, tilt open/close, etc. may cause the motor or sunroof system to malfunction.
- Regularly remove any accumulated dust on the sunroof rail.
- Dust accumulated between the sunroof and roof panel can make noise

Open the sunroof and remove dust regularly using a clean cloth.

- Do not try to open the sunroof when the temperature is below freezing or when the sunroof is covered with snow or ice. The sunroof may not work properly and may break if opened by force.
- Do not open or drive with the sunroof glass open immediately after rain or washing the vehicle. Water may wet the interior of the vehicle.
- Do not extend any luggage outside the sunroof while driving. Vehicle damage may occur if the vehicle suddenly stops.

⚠ WARNING

Do not extend your head, arms, body parts or objects outside the sunroof while driving. Injuries may occur if the vehicle suddenly stops.

Resetting the sunroof



In some circumstances resetting the sunroof operation may need to be performed. Some instances where resetting the sunroof may be required include:

- When the 12-volt battery is either disconnected or discharged
- When the sunroof fuse is replaced
- If the sunroof one-touch AUTO OPEN/CLOSE operation is not functioning properly

Sunroof resetting procedure

1. It is recommended to perform the reset procedure with the vehicle engine running. Start the vehicle in P (Park).
2. Make sure the power sunshade and sunroof glass are in the fully closed position. If the power sunshade and sunroof glass are open, push the switch forward until the sunshade and sunroof glass are fully closed.
3. Release the switch when the power sunshade and sunroof glass are fully closed.
4. Push the switch forward until the power sunshade and sunroof glass moves slightly. Then release the switch.
5. Once again push and hold the sunroof switch forward until the sunroof glass slides open and close. Do not release the switch until the operation is completed.

If you release the switch during operation, start the procedure again from step 2.

* INFORMATION

If the sunroof does not reset when the vehicle battery is disconnected or discharged, or the sunroof fuse is blown, the sunroof may not operate normally.

Sunroof open warning

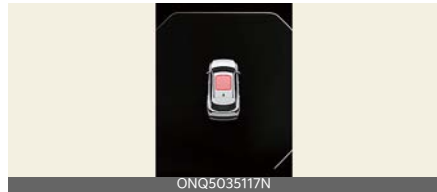

If the driver turns off the engine when the sunroof is not fully closed, the warning chime will sound for several seconds and the sunroof open warning will appear on the cluster LCD display. Close the sunroof securely when leaving your vehicle.

▲ CAUTION

Make sure the sunroof is closed fully when leaving your vehicle. If the sunroof is left open, rain or snow may wet the interior of the vehicle. Leaving the sunroof open when the vehicle is unattended may invite theft.

Steering wheel

The steering wheel of this vehicle is equipped with Motor Driven Power Steering.

Motor Driven Power Steering (MDPS)

Power steering uses an electric motor to assist you in steering the vehicle.

If the vehicle is off or if the power steering system becomes inoperative, the vehicle may still be steered, but it will require increased steering effort.

Motor Driven Power Steering is controlled by the power steering control unit which senses the steering wheel torque and vehicle speed to command the motor.

The steering effort becomes heavier as the vehicle's speed increases and becomes lighter as the vehicle's speed decreases for better control of the steering wheel.

Should you notice any change in the effort required to steer during normal vehicle operation, have the power steering checked by an authorized Kia dealer.

* NOTICE

The following symptoms may occur during normal vehicle operation:

- The MDPS warning light does not appear.
- The steering gets heavy immediately after turning the EV button in ON position. This happens as the system performs the MDPS system diagnostics. When the diagnostics are completed, the steering wheel will return to its normal condition.
- A click noise may be heard from the MDPS relay after turning the EV button in ON or OFF position.

- A motor noise may be heard when the vehicle is at a stop or at a low driving speed.
- When the charging system warning light comes on due to the low voltage (when the LDC or battery does not operate normally or malfunctions), the steering wheel may require increased steering effort.
- If the vehicle needs to be jump started due to battery discharge, the steering wheel may not function normally. This is a temporary situation caused by low battery voltage. It will be solved once the battery is charged. Check for normal steering function by turning the steering wheel slowly before driving the vehicle.
- The steering effort can suddenly increase, if the operation of the MDPS system is stopped to prevent serious accidents when MDPS control unit detects malfunction of the MDPS system by self-diagnosis.

If the Motor Driven Power Steering system does not operate normally, the warning light will appear on the instrument cluster. The steering wheel may become difficult to control or operate abnormally. In this case, have the system inspected by an authorized Kia dealer.

When you operate the steering wheel in low temperature, the steering effort may be high and abnormal noise could occur. If temperature rises, the noise will disappear. This is a normal condition.

When the vehicle is stationary, and the steering wheel is turned all the way to the left or right continuously, the steering wheel becomes harder to turn. The power assist is limited to protect the motor from overheating.

As time passes, the steering wheel will return to its normal condition.

Tilt & telescopic steering wheel

A tilt and telescopic steering wheel allows you to adjust the steering wheel before you drive. You can also raise it to give your legs more room when you exit and enter the vehicle.

The steering wheel should be positioned so that it is comfortable for you to drive, while permitting you to see the instrument panel warning lights and gauges.

⚠ WARNING

Steering wheel adjustment

Never adjust the angle and height of the steering wheel while driving. You may lose control of the vehicle.

Adjusting steering wheel angle and height



1. To change the steering wheel angle, pull down the lock release lever (1).
2. Adjust the steering wheel to the desired angle and distance forward/back.

Move the steering wheel so it points toward your chest, not toward your face. Make sure you can see the instrument panel warning lights and

gauges. After adjusting, pull up the lock.

3. Pull up the lock-release lever to lock the steering wheel in place.
Push the steering wheel both up and down to be certain it is locked in position.
4. Be sure to adjust the steering wheel to the desired position before driving.

*** NOTICE**

After adjustment, sometimes the lock-release lever may not lock the steering wheel.

It is not a malfunction. This occurs when two gears engage. In this case, adjust the steering wheel again to lock the steering wheel.

⚠ CAUTION

While adjusting the steering wheel angle and height, please do not push or pull it hard since the fixture can be damaged.

Heated steering wheel (if equipped)

When the ENGINE START/STOP button is in the ON position, pressing the heated steering wheel button warms the steering wheel. The indicator on the button will appear.



To turn off the heated steering wheel, press the button once again. The indicator on the button will turn off.

- The heated steering wheel defaults to the OFF position whenever the ENGINE START/STOP button is in the ON position.

* NOTICE

The heated steering wheel will turn off automatically approximately 30 minutes after the heated steering wheel is turned on.

⚠ CAUTION

- Do not install any type of grip cover for the steering wheel. It may impair the function of the heated steering wheel system.
- When cleaning the heated steering wheel, do not use an organic solvent such as paint thinner, benzene, alcohol or gasoline. Doing so may damage the surface of the steering wheel.
- If the surface of the steering wheel is struck by a sharp object, damage to the heated steering wheel components or steering wheel grip sensor could occur.

⚠ WARNING

If the steering wheel becomes too warm, turn the system off. The heated steering wheel may cause burns even at low temperatures, especially if used for a prolonged period.

Horn

To sound the horn, press the area indicated by the horn symbol on your steering wheel (see illustration).



The horn will operate only when this area is pressed. Check the horn regularly to be sure it operates properly.

⚠ CAUTION

Do not strike the horn severely to operate it, or hit it with your fist. Do not press on the horn with a sharp-pointed object.

Mirrors

This vehicle is equipped with inside and outside rearview mirrors to provide views of objects behind the vehicle.

Inside rearview mirror

Adjust the rearview mirror so that the center view through the rear window is seen. Make this adjustment before you start driving.

Do not place objects in the rear seat or cargo area which could interfere with your vision outside the rear window.

⚠ WARNING

Mirror adjustment

Do not adjust the rearview mirror while the vehicle is moving. This could result in loss of control.

*** NOTICE**

Do not modify the inside mirror in any manner, including installing a wide mirror. Doing so could result in injury during an accident or deployment of the air bag.

⚠ CAUTION

Cleaning mirror

When cleaning the mirror, use a paper towel or similar material dampened with glass cleaner. Do not spray glass cleaner directly on the mirror. It may cause the glass cleaner to enter the mirror housing.

Day/night rearview mirror (if equipped)



(A): Day, (B): Night

Make this adjustment before you start driving and while the day/night lever is in the day position (1).

Pull the day/night lever toward you (2) to reduce the glare from the headlamps of the vehicles behind you during night driving.

You lose some rearview clarity in the night position.

Electronic Chromic Mirror (ECM) (if equipped)



The sensor detects the light level and automatically controls the headlamp glare during low light and night driving conditions.

⚠ WARNING

- Do not place objects in the rear seat or cargo area which would interfere with your vision out the rear window.
- Do not adjust the rearview mirror while the vehicle is moving. This could result in loss of control, and an acci-

dent which could cause DEATH, SERIOUS INJURY, or property damage.

- Do not modify the inside mirror and don't install a wide mirror. It could result in injury, during an accident or deployment of the air bag.

ECM with HomeLink® system (if equipped)

ECM automatically controls the glare from the headlamps of the vehicles behind you in nighttime or low light driving conditions.

The sensor mounted in the mirror senses the light level around the vehicle, and automatically controls the headlamp glare from the vehicles behind you. When the engine is running, the glare is automatically controlled by the sensor mounted in the rearview mirror.



- 1 HomeLink Channel 1
- 2 HomeLink Channel 2
- 3 HomeLink Channel 3
- 4 Garage Door Opener Status Indicator: Closing or Closed
- 5 HomeLink Operation Indicator
- 6 Garage Door Opener Status Indicator: Opening or Opened
- 7 HomeLink User Interface Indicator

Your vehicle may be equipped with a Gentex Automatic-Dimming Mirror with an Integrated HomeLink® Wireless Control System.

During nighttime driving, this feature will automatically detect and reduce rear-

view mirror glare. The HomeLink® Universal Transceiver allows you to activate your garage door(s), electric gate, home lighting, etc.

Automatic-Dimming Night Vision Safety™ (NVS®) Mirror (if equipped)

The NVS® Mirror automatically reduces glare by monitoring light levels in the front and the rear of the vehicle. Any objects that obstruct the light sensor will degrade the NVS.

For more information regarding NVS® mirrors and other applications, please refer to the Gentex website:

www.gentex.com

Your mirror will automatically dim upon detecting glare from the vehicles traveling behind you.

The mirror defaults to the ON position each time the vehicle is started.

Integrated HomeLink® Wireless Control System

The HomeLink® Wireless Control System provides a convenient way to replace up to three handheld radio-frequency (RF) transmitters used to activate compatible devices such as gate operators, garage door openers, entry door locks, security systems, and home lighting.

* NOTICE

When the vehicle is parked outside the garage, the HomeLink will ONLY work when the ignition switch is in ACC position or ON position.

⚠ CAUTION

Before programming HomeLink to a garage door opener or gate operator, make sure that people and objects are

out of the way of the door or gate to prevent potential harm or damage. When programming a garage door opener, it is advised to park outside of the garage.

Do not use HomeLink with any garage door opener that lacks safety stop and reverse features as required by U.S. federal safety standards (this includes any garage door opener model manufactured before April 1, 1982). A garage door that cannot detect an object signaling the door to stop and reverse - does not meet current U.S. federal safety standards. For more information, contact HomeLink at **www.homelink.com**, or call HomeLink customer support at **1-800-355-3515**.

It is also recommended that a new battery be replaced in the hand-held transmitter of the device being trained to HomeLink for quicker training and accurate transmission of the radio frequency.

1. Programming HomeLink®

The following steps show how to program HomeLink. If you have any questions or are having difficulty programming your HomeLink buttons, refer to the HomeLink website or call the HomeLink customer support toll-free number (1-800-355-3515). Do this, before returning to the dealer who sold you the car.

- Visit the HomeLink website at: www.homelink.com. At the top of the page, choose your vehicle make. Then watch the YouTube video, and/or access additional website information.

- If you choose to access the website via your cellular phone, scan the QR code.



1) Programming Preparation

1. When programming a garage door opener, it is advised to park the vehicle outside the garage.
2. It is recommended that a new battery be placed in the hand-held transmitter of the device being programmed to HomeLink for quicker training and accurate transmission of the radio-frequency signal.
3. Place the ENGINE START/STOP button to the ACC (Accessory) position for programming of HomeLink.



2) Programming a New Home-Link® Button

1. Press and release the HomeLink button ((1), (2) or (3)) that you want to program. If successful, the HomeLink indicator light (7) will flash orange slowly. If the HomeLink indicator light does not blink orange slowly, then start over and perform the steps of "Erasing HomeLink Buttons" section again.



- Position the garage door opener remote 1-3 inches (2-8 cm) away from the HomeLink buttons.



- While the HomeLink indicator light (7) is flashing orange, press and hold the hand-held remote button. Continue pressing the hand-held remote button until the HomeLink indicator light (7) light changes from orange to green. You may now release the hand-held remote button. The garage door will move.

- Wait until your garage door comes to a complete stop, regardless of position, before proceeding to the next steps.

- Press and release the HomeLink button you are programming and observe the indicator light.

- If the indicator light remains solid green, your device should operate when the HomeLink button is pressed. If your device operates, programming is complete.
- If the indicator light rapidly flashes green, firmly press, hold for two seconds and release the HomeLink button up to three times in a row slowly to complete the programming process. Do not press the

HomeLink button rapidly. If your device operates, programming is complete. If the device does not operate, continue with step 6.

- At the garage door opener motor, (security gate motor, etc.) locate the "Learn", "Smart", "Set" or "Program" button. This can usually be found where the hanging antenna wire is attached to the motor-head unit (see the device's manual to identify this button). The name and color of the button may vary by manufacturer.

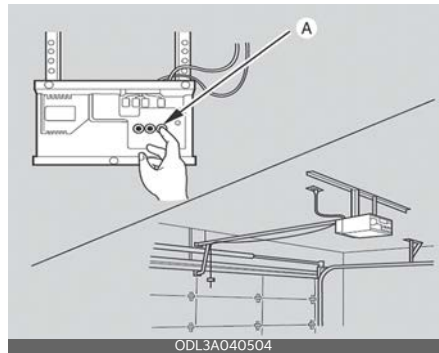

* A ladder and/or second person may simplify the following steps.

- Firmly press and release the "Learn", "Smart", "Set" or "Program" button. You now have up to 30 seconds in which to complete the next step.
- Return to the vehicle and firmly press, hold for two seconds and release the HomeLink button up to three times in a row slowly. Do not press the HomeLink button rapidly. As soon as you see the garage door start to move, stop pressing any buttons until a few seconds after the garage door has come to a complete stop, regardless of position. Programming is complete and your device should operate when

the HomeLink button is pressed and released.

3) Two-Way Communication Programming (For select garage door openers)

If your garage door opener has the 'myQ' logo on its side, your opener has Two-Way Communication capability. HomeLink has the capability to establish Two-Way Communication with your garage door opener. HomeLink can receive and display "closing" or "opening" status messages from compatible garage door openers. At any time, HomeLink can also recall and display the last recorded status communicated by the garage door opener to indicate that your garage door being "closed" or "opened".

To check if your garage door opener is compatible with this feature, refer to www.homelink.com/compatible/Two-way-Communication. If your garage door opener has this functionality, AND the Two-Way Communication indicators (4), (6) in the mirror appear while the garage door is opening/closing, then no further steps are needed. Two-Way Communication Programming is already complete. However, if your garage door opener has this functionality, AND the Two-Way Communication indicators (4), (6) in the mirror DO NOT appear while the garage door is opening/closing, use the following instructions to enable this functionality.

1. Press and hold the programmed HomeLink button for 2 seconds, then release. Confirm that the garage door is moving. AFTER it stops, you will have one minute to complete the following steps:

* A ladder and/or second person may simplify the following steps.

2. On your garage door opener in your garage, locate the "Learn" button (usually near where the hanging antenna wire is attached to the garage door opener). If there is difficulty locating this button, refer to the device's owner's manual.
3. Press and release the "Learn" button.
4. A light on your garage door opener may flash, and your Two-Way Communication indicators (4), (6) in your vehicle may flash, confirming completion of the process.
5. Return to the vehicle and firmly press and release the programmed HomeLink button to activate your garage door. The Two-Way Communication indicators (4), (6) flash in orange when the door is moving. Do not press any additional button presses until AFTER the garage door has come to a complete stop.
6. Your Two-Way Communication programming is now complete.

*** NOTICE**

If your garage door opener has Two-Way Communication functionality, HomeLink may stop functioning shortly after initial programming if the Two-Way Communication Programming wasn't properly completed. This usually happens after the first 10 times a programmed HomeLink button is pressed. Completing the "Programming a New HomeLink Button" and "Two-Way Communication Programming" will restore door operation.

4) Canadian Programming

Canadian radio-frequency laws require transmitter remote signals to "time-out" (or quit) after a couple seconds of transmission, which may not be long enough for HomeLink to pick up the signal during programming.

If you live in Canada or you are having difficulties programming a gate operator or garage door opener by using the programming procedures, replace "Programming a New HomeLink Button" step 3 with the following:

While the HomeLink indicator light (7) is flashing orange, press and release ("cycle") your device's hand-held remote every two seconds until the HomeLink indicator light (7) changes from orange to green. You may now release the hand-held remote button. Then proceed with "Programming a New HomeLink Button" step 4.

2. Operating HomeLink®

1) Operating HomeLink®

1. Press and release the desired programmed HomeLink button (1, 2 or 3).



* NOTICE

The HomeLink indicator (7) should light green, solid or flashing, and your programmed device should operate.

If your device does not operate, the HomeLink programming was not suc-

cessful, and you'll need to reprogram the button.

2) Two-Way Communication Display Behavior

1. Press and release one of the programmed HomeLink buttons (1, 2 or 3)



2. The indicator (4) and (6) operates as below, if your garage door opener has Two-Way Communication functionality.



- If the indicator (4) flashes in Orange, it indicates that the garage door is "Closing".
- The indicator (4) turns solid Green once the garage door has closed.
- If the indicator (6) flashes in Orange, it indicates that the garage door is "Opening".
- The indicator (6) turns solid Green once the garage door is fully opened.
- If the indicator (4) or (6) does not turn Green, it indicates that the last status of garage door was not received properly. The HomeLink mirror tries to receive the last

known status of the garage door for a few seconds.

3) Recalling Garage Door Status

HomeLink mirror with Two-Way Communication provides a way to view the last stored message from the garage door opener. In order to recall the last known status of the last activated device, press the buttons "1 and 2" OR "2 and 3" simultaneously.

- If the indicator (4) appears solid Green, it indicates that the last activated device was properly "closed".
- If the indicator (6) appears solid Green, it indicates that the last activated device was properly "opened".

3. Erasing HomeLink® Buttons

1) Erasing and Reprogramming a Single HomeLink® Button:

1. Press and hold the desired HomeLink button you want to re-program. DO NOT release the button.
2. The HomeLink indicator light (7) will begin appearing solid Green. Release the button as soon as the HomeLink indicator light (7) begins to flash Orange, usually about 20 seconds.
3. Proceed with the steps in the "Programming a New HomeLink Button" section.

* NOTICE

If you do not complete the re-programming of a new device, it will revert to the previously stored programming.

2) The following instructions will erase ALL HomeLink® programming from ALL buttons:



1. Press and hold the buttons (1) and (3) simultaneously.
2. The HomeLink indicator light (7) will appear solid Orange for about 10 seconds.
3. Release the buttons once the HomeLink indicator light (7) changes to Green and flashes rapidly.
4. Now all three HomeLink buttons (1), (2) and (3) are cleared of any programming.

Information

HomeLink and the HomeLink House logo are registered trademarks of Gen-tex Corporation.

The myQ logo is a registered trademark of The Chamberlain Group, Inc

FCC (USA) and ISED (Canada)

This device complies with FCC rules part 15 and Innovation, Science, and Economic Development Canada RSS-210. Operation is subject to the following two conditions: (1) This device may not cause harmful interference, and (2) This device must accept any interference that may be received including interference that may cause undesired operation. **WARNING:** The transmitter has been tested and complies with FCC and ISED rules. Changes or modifications not expressly approved by the party responsible for

compliance could void the user's authority to operate the device.

This equipment complies with FCC and ISED radiation exposure limits set forth for an uncontrolled environment. End Users must follow the specific operating instructions for satisfying RF exposure compliance. This transmitter must be at least 20 cm from the user and must not be co-located or operating in conjunction with any other antenna or transmitter.

FCC (États-Unis) et ISED (Canada)

Cet appareil est conforme aux règlements de la FCC, section 15, et au CNR-210 d'Innovation, Sciences et Développement économique Canada. Le fonctionnement est assujéti aux deux conditions suivantes: (1) cet appareil ne doit pas causer d'interférences nuisibles et (2) cet appareil doit accepter toute interférence reçue, y compris celle qui pourrait entraîner un dysfonctionnement. MISE EN GARDE: L'émetteur a subi des tests et est conforme aux règlements de la FCC et d'ISDE. Les changements ou modifications non approuvés explicitement par la partie responsable de la conformité pourraient rendre caduque l'autorisation de l'utilisateur de se servir du dispositif.

Cet appareil est conforme aux limites d'exposition aux radiations de la FCC et d'ISDE établies pour un environnement non contrôlé. Les utilisateurs finaux doivent respecter les instructions d'utilisation spécifiques pour satisfaire aux exigences de conformité aux expositions de RF. L'émetteur doit se trouver à 20 cm au minimum de l'utilisateur et ne doit pas être situé au même endroit que tout autre émetteur ou antenne ni fonctionner avec un autre émetteur ou antenne.

HomeLink 5 Programming Flow Chart

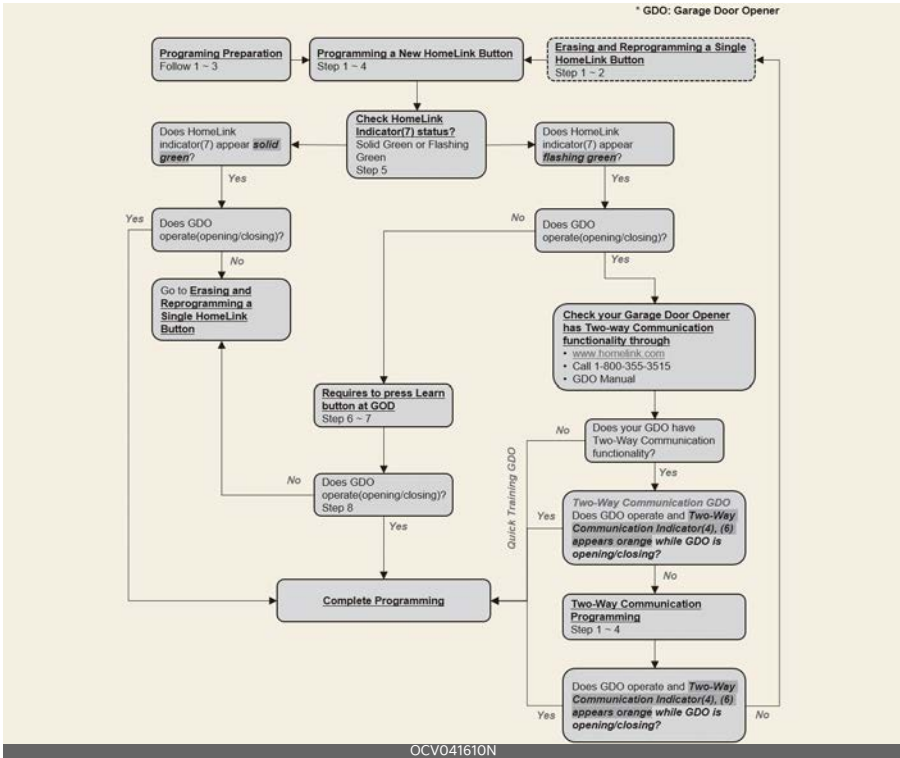

Outside rearview mirror

Your vehicle is equipped with both left-hand and right-hand outside rearview mirrors.

Be sure to adjust the mirror angles before driving.

The mirrors can be adjusted remotely with the control levers or remote switch, depending on the type of mirror control installed. The mirror heads can be folded back to prevent damage in an automatic car wash or when passing through a narrow street.

* NOTICE

Rearview mirrors

- The outside rearview mirror for passenger's side is convex. Objects seen in the mirror are closer than they appear.
- Use your interior rearview mirror or direct observation to determine the actual distance of following vehicles when changing lanes.

⚠ CAUTION

- Do not scrape ice off the mirror face as this may damage the glass.
- If ice should restrict the movement of the mirror, do not force the mirror for adjustment. To remove ice, use a deicer spray, or a sponge or soft cloth with warm water.

If the mirror is jammed with ice, do not adjust the mirror by force. Use an approved spray de-icer (not radiator antifreeze) to release the frozen mechanism or move the vehicle to a warm place and allow the ice to melt.

⚠ WARNING

Mirror Adjustment

Do not adjust or fold the outside rearview mirrors while the vehicle is moving. This could result in loss of control, and an accident which could cause DEATH, SERIOUS INJURY, or property damage.

Adjusting the outside rearview mirrors

The electric remote control mirror switch allows you to adjust the position of the left and right outside rearview mirrors.



Adjusting the rearview mirrors:

1. Move the R or L switch (1) to select the right side mirror or the left side mirror.
2. Press a corresponding point on the mirror adjustment control (2) to position the selected mirror up, down, left or right.
3. After adjustment, put the button into neutral (center) position to prevent inadvertent adjustment.

⚠ CAUTION

- The mirrors stop moving when they reach the maximum adjusting angles, but the motor continues to operate while the switch is pressed. Do not press the switch longer than necessary as the motor may be damaged.
- Do not adjust the outside rearview mirror by hand. Doing so may damage the parts.

Folding the outside rearview mirror

The outside rearview mirror can be folded or unfolded by pressing the switch as below.



The mirror will fold or unfold automatically as follows:

- The mirror will fold or unfold when the door is locked or unlocked by the smart key.
- The mirror will fold or unfold when the door is locked or unlocked by the button on the outside door handle.
- The mirror will unfold when you approach the vehicle (all doors closed and locked) with a smart key in possession. (if equipped)

CAUTION

The electric type outside rearview mirror is operable even when the EV button is in the OFF position. However, to prevent unnecessary battery discharge, do not adjust the mirrors longer than necessary while the EV button is ON.

Do not fold an electric type outside rearview mirror by hand as this could cause motor failure.

Reverse parking aid function

When the gear is shifted to the R (Reverse) position, the outside rear view lever(s) will rotate downwards to aid with driving in reverse.



The position of the outside rearview mirror switch (1) determines whether the mirrors will move:

- Left/Right: When either the L (left) or r (Right) switch is selected, both outside rearview mirrors will move.
- Neutral: When neither switch is selected, the outside rearview mirrors will not move.

The outside rearview mirrors will automatically revert to their original positions if any of the followings occur:

- The EV button is placed to either the OFF position.
- The gear is shifted to any position except R (Reverse).
- The remote control outside rear view mirror switch is not selected.

Reverse parking aid user settings mode

If you cannot see well enough with the angles provided as factory default conditions, you can readjust and store the angles of outside rearview mirrors.

The factory default angles of the right and left rearview mirrors can be set individually. To adjust the default angles:

1. Set the shift lever to P (Parking). Make sure that the vehicle is stopped and the mirrors are not working.
2. Position the lever to L (left) or R (right) depending on the mirror that you want to adjust.
3. Step on the brake pedal and shift the shift lever to R (Reverse).
4. When the downward movement of the rearview mirror is finished, adjust the mirror to the desired angle by pressing the switches, ▼, ▲, ◀, ▶.
5. Once you have the mirrors in the desired positions, shift to a gear other than R (Reverse), or change the rearview mirror selector lever to the neutral position.
6. You can adjust the rearview mirror on the other side by following the same procedures (1-5).

(Adjust the mirror in the higher position compared to its position in the driving mode)

5. Move the gear to a position other than R (Reverse) or change the rearview mirror selector lever to the neutral position. (The default settings will be applied from the next operation)
6. You can initialize settings for the mirror on the other side by following the same procedures (1-5).

* NOTICE

Follow these procedures in an orderly manner to change or initialize the auto reversing user settings.

If you move to the next step before completing the previous one, the changed angle may not be changed or initialization may not work properly.

Resetting reverse parking aid user settings mode

If you want to change the automatic control function of rearview mirrors to factory-default conditions, follow the steps below.

1. Shift the shift lever to P (Park).
2. Choose the mirror to be adjusted by positioning the lever to L (left) or R (right).
3. Step on the brake pedal and shift the shift lever to R (Reverse).
4. When the downward movement of the rear view mirror is finished, press the switch (▲) to locate the mirror in the position higher than before (P, N or D).

Instrument cluster

Type A

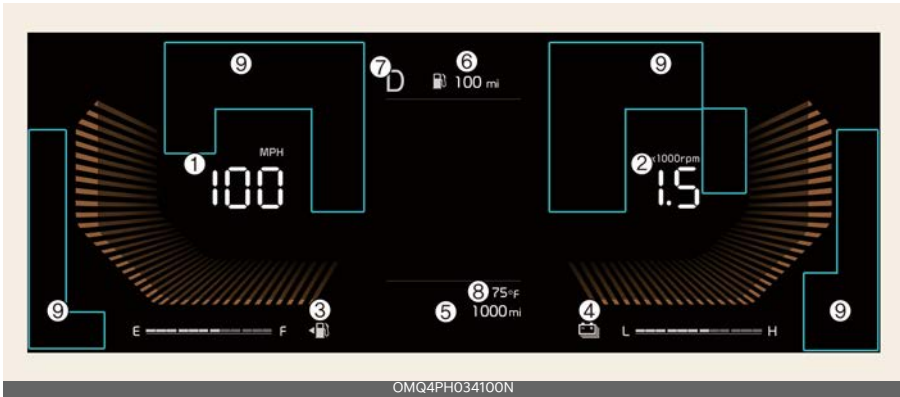

Type B



* The actual cluster in the vehicle may differ from the illustration.

- 1 Speedometer
- 2 Tachometer/Power gauge
- 3 Fuel gauge
- 4 Hybrid battery SOC gauge
- 5 Odometer
- 6 Distance to empty
- 7 Transmission shift indicator
- 8 Outside temperature gauge
- 9 Warning and indicator lights

Adjusting instrument cluster illumination

The brightness of the instrument panel illumination is changed by pressing the illumination control button ("+" or "-") when the ENGINE START/STOP button is ON, or the tail lights are turned on.

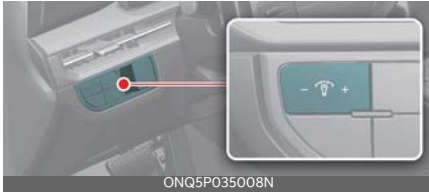

- If you hold the illumination control button ("+" or "-"), the brightness will be changed continuously.



A: Illumination

- If the brightness reaches to the maximum or minimum level, an alarm will sound.

WARNING

Never adjust the instrument cluster while driving. This could result in loss of control and lead to an accident that may cause DEATH, SERIOUS INJURY, or property damage.

Gauges

The gauges display various information such as the speed of the vehicle, and so on.

Speedometer

Type A

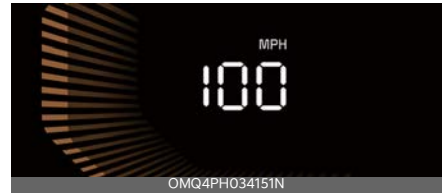

Type B

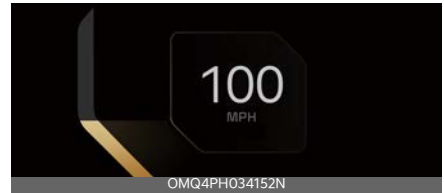

The speedometer indicates the speed of the vehicle and is calibrated in miles per hour (mph) and kilometers per hour (km/h).

Tachometer/Power gauge

Type A

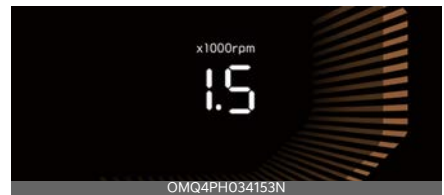

Type B

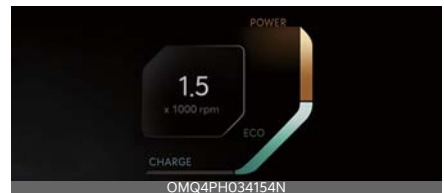

Tachometer

Indicates the approximate number of engine revolutions per minute (rpm).

Power gauge

The hybrid system gauge indicates whether the current driving condition is fuel efficient or not.

- **CHARGE:**
Shows that the energy made by the vehicle is being converted to electrical energy. (Regenerated energy)
- **ECO:**
Shows that the vehicle is being driven in an Eco-friendly manner.
- **POWER:**
Shows that the vehicle is exceeding the Eco-friendly range.

* NOTICE

According to the hybrid system gauge area, the "EV" indicator comes on or off.

- "EV" indicator ON : Vehicle is driven using the electric motor or the gasoline engine is stopped.
- "EV" indicator OFF: Vehicle is driven using the gasoline engine.

Hybrid battery (State of Charge) (SOC) gauge

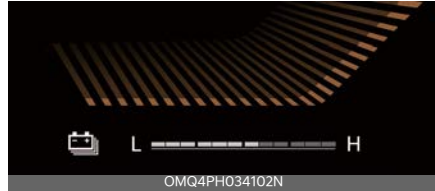

Type A



Type B



This gauge indicates the remaining hybrid battery power. If the SOC is near the "L (Low)" or "O" level, the vehicle automatically operates the engine to charge the battery.

However, if the Service Indicator () and Malfunction Indicator Lamp (MIL) () turn on when the SOC gauge is near the "L (Low)" or "O" level, have your vehicle inspected by an authorized Kia dealer as soon as possible.

* NOTICE

Never try to start the vehicle if the fuel tank is empty. In this condition, the engine cannot charge the high voltage battery of the hybrid system. If you try to start the vehicle when the fuel is empty, the high voltage battery will be discharged and be damaged.

Fuel gauge

Type A

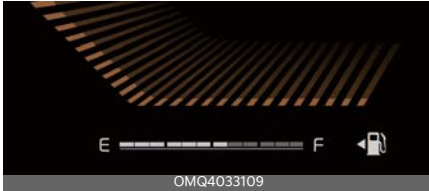

Type B



This gauge indicates the approximate amount of fuel remaining in the fuel tank.

* NOTICE

- The fuel tank capacity is given in "Reference weight and distance when towing a trailer" on page 10-3.
- The fuel gauge is supplemented by a low fuel warning light, which will appear when the fuel tank is nearly empty.
- On inclines or curves, the fuel gauge pointer may fluctuate or the low fuel warning light may come on earlier than usual due to the movement of fuel in the tank.

⚠ WARNING

Fuel gauge

Running out of fuel can expose vehicle occupants to danger.

You must stop and obtain additional fuel as soon as possible after the warning

light comes on or when the gauge indicator comes close to the "E" or "O" level.

⚠ CAUTION

Avoid driving with an extremely low fuel level. Running out of fuel could cause the engine to misfire, which could damage the catalytic converter.

* NOTICE

The fuel display may not be accurate if the vehicle is on an incline.

Odometer

Type A

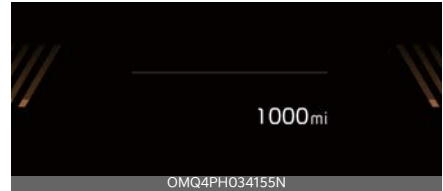

Type B



The odometer Indicates the total distance that the vehicle has been driven and should be used to determine when periodic maintenance should be performed.

- Odometer range: 0-999,999 miles or 1,599,999 km.

Distance to empty

Type A

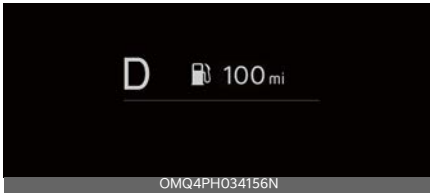

Type B

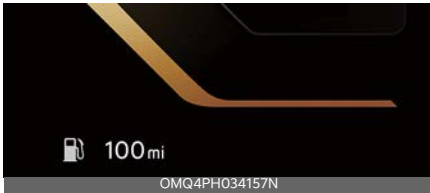

- The distance to empty is the estimated distance the vehicle can be driven with the remaining fuel.
 - Distance range: 1-9,999 miles or 1-9,999 km.
- If the estimated distance is below 1 mile (1 km), the trip computer will display "----" as distance to empty.
- In order for the vehicle to recognize that it has been refueled, at least 2.9 gallons (11 liters) of gas must be filled.

* NOTICE

- If the vehicle is not on level ground or the battery power has been interrupted, the distance to empty function may not operate correctly.
- The distance to empty may differ from the actual driving distance as it is an estimate of the available driving distance.
- The trip computer may not register additional fuel if less than 2.9 gallons (11 liters) of fuel are added to the vehicle.

- The fuel economy and distance to empty may vary significantly based on driving conditions, driving habits, and vehicle condition.

Outside temperature gauge

Type A

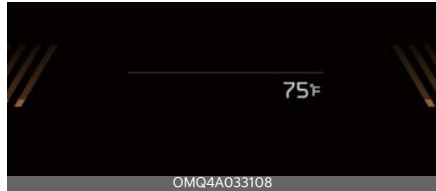

Type B

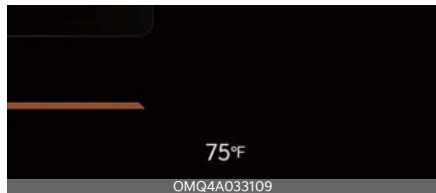

This gauge indicates the current outside air temperatures within 1 °F (1 °C).

- Temperature range: -40 °F-140 °F (-40 °C-60 °C)

The outside temperature on the display may not change immediately like a general thermometer to prevent the driver from being inattentive.

To change the temperature unit (from °C to °F or from °F to °C), select **Setup** → **General** → **Units** → **Temperature Unit** from the infotainment system.

Transmission shift indicator

Transmission shift indicator displays gear information depending on your vehicle's transmission type.

Automatic transmission shift indicator

Type A



Type B

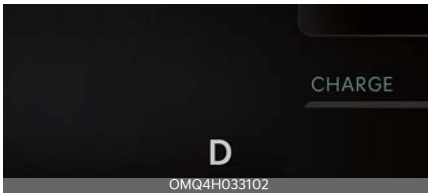

This indicator displays which automatic transmission gear is selected.

- Park: P
- Reverse: R
- Neutral: N
- Drive: D

Shift indicator pop-up

The pop-up that indicates the current gear position is displayed in the cluster for about 2 seconds when shifting into other positions (P/R/N/D).

Warning and indicator lights

The warning light and indicator light indicate a situation where the driver should be more careful and whether the various functions are activated.

Warning lights

The warning light indicates situations that require the driver to pay greater attention.

* NOTICE

Warning lights

Make sure that all warning lights are OFF after starting the engine. If any light remains ON, the situation needs attention.

Air bag warning light

This warning light appears:

- Once you set the ENGINE START/ STOP Button to the ON position.
 - It appears for approximately 3-6 seconds and then goes off.
- When there is a malfunction with the SRS. Have the vehicle inspected by an authorized Kia dealer.

Seat belt warning light

This warning light informs the driver that the seat belt is not fastened.

* For more details, refer to "Seat belts" on page 4-17.

Parking brake & brake fluid warning light

This warning light appears:

- Once you set the ENGINE START/ STOP Button to the ON position.
 - It appears for approximately 3 seconds
 - It remains on if the parking brake is applied.
- When the parking brake is applied.
- When the brake fluid level in the reservoir is low.
 - If the warning light appears with the parking brake released, it indicates the brake fluid level in reservoir is low.

If the brake fluid level in the reservoir is low:

1. Drive carefully to the nearest safe location and stop your vehicle.
2. With the engine stopped, check the brake fluid level immediately and add fluid as required (For more details, refer to "Brake fluid" on page 9-14). Check all brake components for fluid leaks. If any leak on the brake system is found, the warning light remains on, or the brakes do not operate properly, do not drive the vehicle.

Have your vehicle towed to an authorized Kia dealer and inspected.

Dual-diagonal braking system

Your vehicle is equipped with dual-diagonal braking systems. This means you still have braking on two wheels even if one of the dual systems fail.

If one of the systems stops working, a warning light will appear. More than nor-

mal pedal travel and greater pedal pressure are required to stop the vehicle. The vehicle will not stop in as short a distance with only a portion of the brake system working.

If the brakes fail while you are driving, shift to a lower gear for additional engine braking and stop the vehicle as soon as it is safe to do so.

* NOTICE

Parking brake & brake fluid warning light

Driving the vehicle with a warning light on is dangerous. If the Parking Brake & Brake Fluid Warning Light appears with the parking brake released, it indicates that the brake fluid level is low.

Have your vehicle inspected by an authorized Kia dealer.

Anti-lock brake system (ABS) warning light

This warning light appears:

- Once you set the ENGINE START/ STOP Button to the ON position.
 - It appears for approximately 3 seconds and then goes off.
- When there is a malfunction with the ABS (The normal braking system will still be operational without the assistance of the anti-lock brake system). If the light remains on, have the vehicle inspected by an authorized Kia dealer.

Electronic Brake Force Distribution (EBD) system warning light



These two warning lights appear at the same time while driving:

- When the ABS and regular brake system are not working, have your vehicle inspected by an authorized Kia dealer.

WARNING

Electronic Brake Force Distribution (EBD) system warning light

When both ABS and parking brake & brake fluid warning lights are on, the brake system will not operate normally, and you may experience an unexpected and dangerous situation during sudden braking.

Avoid high-speed driving and abrupt braking.

Have your vehicle inspected by an authorized Kia dealer as soon as possible.

Electronic Parking Brake (EPB) warning light

This warning light appears:

- Once you set the ENGINE START/STOP Button to the ON position.
 - It appears for approximately 3 seconds and then goes off.
- When there is a malfunction with the EPB.

Have the vehicle inspected by an authorized Kia dealer.

* NOTICE

EPB warning light

The EPB warning light may appear when the Electronic Stability Control (ESC) Indicator Light comes on to indicate that the ESC is not working properly (This does not indicate malfunction of the EPB).

Electric Power Steering (EPS) warning light

This warning light appears:

- Once you set the ENGINE START/STOP Button to the ON position.
 - This indicator light comes on after the ENGINE START/STOP Button is in the ON position and then goes out after approximately 3 seconds.
- When there is a malfunction with the EPS.

Have the vehicle inspected by an authorized Kia dealer.

Charging system warning light



This warning light appears:

- Once you set the ENGINE START/STOP Button to the ON position.
- When there is a malfunction with either the alternator or electrical charging system.

If there is a malfunction with either the alternator or electrical charging system:

1. Drive carefully to the nearest safe location and stop your vehicle.

- Turn the engine off and check the alternator drive belt for looseness or breakage.

Have the vehicle inspected by an authorized Kia dealer.

Malfunction Indicator Lamp (MIL)



This warning light appears:

- When you set the ignition switch or the ENGINE START/STOP button to the ON position.
 - The MIL appears for about 3 seconds and then goes off.
- When a malfunction is detected in the emission control system, the engine, the powertrain or the active air flap. Have the vehicle inspected by an authorized Kia dealer.

⚠ CAUTION

MIL

- Driving with the MIL on may cause damage to the emission control systems which could affect drivability and/or fuel economy.
- If the enhanced engine protection system becomes activated due to lack of engine oil, engine power will be limited. If the enhanced engine protection system activates due to the lack of engine oil, the engine power is limited.

⚠ CAUTION

If the oil pressure lowers due to insufficient engine oil, etc., the engine oil pressure warning light turns on and an enhanced engine protection system that limits the engine's power is activated.

The engine warning light turns on if driving repeatedly and continuously.

⚠ CAUTION

If the MIL appears, potential catalytic converter damage is possible which could result in loss of engine power. Have the vehicle inspected by an authorized Kia dealer.

Engine oil pressure warning light



This warning light appears:

- Once you set the ENGINE START/STOP Button to the ON position.
 - It remains on until the engine is started.
- When the engine oil pressure is low.

If the engine pressure is low:

- Drive carefully to the nearest safe location and stop your vehicle.
- Turn the engine off and check the engine oil level (For more details, refer to "Engine oil and filter" on page 9-13). If the level is low, add oil as required.
- If the warning light remains on after adding oil or if oil is not available, have the vehicle inspected by an authorized Kia dealer. Continuing driving with the warning light on may cause engine failure.

* NOTICE

- If engine oil pressure decreases due to insufficient engine oil, etc., the Engine Oil Pressure warning light appear.
- The enhanced engine protection system that limits engine power is acti-

vated. If the engine oil pressure is restored the warning light and the enhanced engine protection system turn off after the engine is restarted.

⚠ CAUTION

Engine overheating

Do not continue driving with the engine overheated. The engine may be damaged.

*** NOTICE**

Engine damage

- Continued driving with the warning light on may cause engine failure.
- If the engine is not stopped immediately after the engine oil pressure warning light appears and stays on while the engine is running, serious engine damage may result.

Exhaust system (GPF) warning light (Gasoline Engine)

This warning light appears:

- When there is a malfunction with Gasoline Particulate Filter (GPF) system.
- When this warning light appears, it may turn off after driving the vehicle:
 - The vehicle should be driven for more than 30 minutes at a speed of 50 mph (80 km/h) or faster.
 - Ensure the following conditions are all met: safe road conditions, transmission in 3rd gear or above, and engine speed of 1,500-4,000 rpm.

If this warning light blinks after following this procedure, have the GPF system checked by an authorized Kia dealer.

⚠ CAUTION

Gasoline engine with GPF (if equipped)

If you continue to drive with the GPF warning light blinking for a long time, the GPF system could be damaged, and fuel consumption could worsen.

Low fuel level warning light

This warning light appears:

When the fuel tank is nearly empty.

If the fuel tank is nearly empty:

Add fuel as soon as possible.

⚠ CAUTION

Low fuel level

Driving with the Low Fuel Level warning light on or with the fuel level below "E" can cause the engine to misfire and damage the catalytic converter.

Master warning light

This indicator light appears:

- This warning light informs the driver the following situations
 - LED headlamp malfunction (if equipped)
 - Lamp malfunction
 - High Beam Assist malfunction (if equipped)

To identify the details of the warning look at the LCD display.

If the situation is resolved, the master warning light will turn off.

Low tire pressure warning light



This warning light appears:

- Once you set the ENGINE START/ STOP Button to the ON position.
 - It appears for approximately 3 seconds and then goes off.
- When one or more of your tires are significantly under inflated. (The location of the underinflated tires is displayed on the LCD display).

* For more details, refer to "Tire Pressure Monitoring System (TPMS)" on page 8-8.

This warning light remains on after blinking for approximately 60 seconds or repeats blinking on and off at the intervals of approximately 3 seconds:

- When there is a malfunction with the TPMS.

Have the vehicle inspected by an authorized Kia dealer.

* For more details, refer to "Tire Pressure Monitoring System (TPMS)" on page 8-8.

⚠ WARNING

Low tire pressure

- Significantly low tire pressure makes the vehicle unstable and can contribute to loss of vehicle control and increased braking distances.
- Continued driving with low pressure tires will cause the tires to overheat and fail.

⚠ WARNING

Safe stopping

- The TPMS cannot alert you about severe and sudden tire damage caused by external factors.
- If you notice any vehicle instability, immediately take your foot off the accelerator pedal, apply the brakes gradually with light force, and slowly move to a safe position off the road.

LED headlamp warning light

This warning light appears:

- Once you set the ENGINE START/ STOP button to the ON position.
 - It appears for approximately 3 seconds and then goes off.
- When there is a malfunction with the LED headlamp.

Have the vehicle inspected by an authorized Kia dealer.

This warning light blinks:

- When there is a malfunction with a LED headlamp related part.

Have the vehicle inspected by an authorized Kia dealer.

⚠ CAUTION

LED headlamp warning light

Continuous driving with the LED Headlamp Warning Light on or blinking can reduce LED headlamp (low beam) life.

Forward Safety warning light

This indicator light appears:

- When there is a malfunction with Forward Collision-Avoidance Assist.

Have the vehicle inspected by an authorized Kia dealer.

- * For more details, refer to "Forward Collision-Avoidance Assist (FCA) (Sensor Fusion)" on page 7-5.

Icy road warning light (if equipped)

This warning light is to warn the driver the road may be icy. When the temperature on the outside temperature gauge is approximately below 39 °F (4 °C) the Icy Road warning light and outside temperature gauge blinks and then appears. The warning chime sounds 1 time.

All-Wheel Drive (AWD) warning light (if equipped)

This warning light appears:

- Once you set the ENGINE START/ STOP Button to the ON position.
 - It appears for approximately 3 seconds and then goes off.
- When there is a malfunction with the AWD.

Have your vehicle inspected by an authorized Kia dealer.

Indicator lights

Electronic stability control (ESC) indicator light

This indicator light appears:

- Once you set the ENGINE START/ STOP Button to the ON position.
 - It appears for approximately 3 seconds and then goes off.
- When there is a malfunction with the ESC system.

Have the vehicle inspected by an authorized Kia dealer.

This indicator light blinks:

While the ESC is operating.

- * For more details, refer to "Electronic Stability Control (ESC) system" on page 6-39.

ESC OFF indicator light

This indicator light appears:

- Once you set the ENGINE START/ STOP Button to the ON position.
 - It appears for approximately 3 seconds and then goes off.
- When you deactivate the ESC system by pressing the ESC OFF button.

- * For more details, refer to "Electronic Stability Control (ESC) system" on page 6-39.

AUTO HOLD indicator light (AUTO HOLD)

This indicator light appears:

- **White:** When you activate the auto hold system by pressing the AUTO HOLD button.
- **Green:** When you stop the vehicle completely by depressing the brake pedal with the auto hold system activated.
- **Yellow:** When there is a malfunction with the auto hold system. Have the vehicle inspected by an authorized Kia dealer.

* For more details, refer to "AUTO HOLD" on page 6-36.

Immobilizer indicator light (without smart key) (if equipped)

This indicator light appears:

- When the vehicle detects the immobilizer in your key properly while the ignition switch is ON.
 - You can then start the engine.
 - The indicator light goes off after starting the engine.

This indicator light blinks:

- When there is a malfunction with the immobilizer system.
Have the vehicle inspected by an authorized Kia dealer.

Immobilizer indicator light (with smart key)

This indicator light appears for up to 30 seconds:

- When the vehicle detects the smart key in the vehicle properly while the ENGINE START/STOP button is ACC or ON.
 - At this time, you can start the engine.
 - The indicator light goes off after starting the engine.

This indicator light blinks for a few seconds:

- When the smart key is not in the vehicle.
 - At this time, you cannot start the engine.

This indicator light appears for 2 seconds and goes off:

- When the vehicle cannot detect the smart key which is in the vehicle while the ENGINE START/STOP Button is ON.
Have the vehicle inspected by an authorized Kia dealer.

This indicator light blinks:

- When the battery of the smart key is weak.
 - At this time, you cannot start the engine. However, you can start the engine if you press the ENGINE START/STOP Button with the smart key. (For more details, refer to "Immobilizer system" on page 5-10).

- When there is a malfunction with the immobilizer system.
Have the vehicle inspected by an authorized Kia dealer.

Turn signal indicator light 

This indicator light blinks:

- When you turn the turn signal light on. If any of the following occurs, there may be a malfunction with the turn signal system. Have the vehicle inspected by an authorized Kia dealer.
 - The indicator light does not blink but appears.
 - The indicator light blinks more rapidly.
 - The indicator light does not appear at all.

Low beam indicator light 

This indicator light appears:

- When the headlamps are on.

High beam indicator light 

This indicator light appears:

- When the headlamps are on and in the high beam position.
- When the turn signal lever is pulled into the Flash-to-Pass position.

High Beam Assist indicator light



This indicator light appears:

- When the high beam is on with the light switch in the AUTO light position.

- If your vehicle detects oncoming or preceding vehicles, High Beam Assist will switch the high beam to low beam automatically.

* For more details, refer to "High Beam Assist (HBA) (if equipped)" on page 5-103.

Light ON indicator light 

This indicator light appears:

- When the taillamps or headlamps are on.

Front fog indicator light  (if equipped)

This indicator light appears:

- When the front fog lights are on.

Lane Safety indicator light 

The Lane Safety indicator will appear when you turn Lane Keeping Assist on by pressing the Lane Safety button.

If there is a problem with Lane Keeping Assist, the yellow Lane Safety indicator will appear.

* For more details, refer to "Lane Keeping Assist (LKA)" on page 7-27.

Downhill Brake Control (DBC)

indicator light 

This indicator light appears:

- When you set the ENGINE START/STOP Button to the ON position.
 - It appears for approximately 3 seconds and then goes off.

- When you activate the system by pressing the DBC button.

This indicator light blinks:

- When the DBC is operating.

This indicator light appears yellow:

- When there is a malfunction with the DBC system.

Have your vehicle inspected by an authorized Kia dealer.

* For more details, refer to "Downhill Brake Control (DBC)" on page 6-41.

All-Wheel Drive (AWD) LOCK indicator light  (if equipped)

This indicator light appears:

- Once you set the ENGINE START/STOP Button to the ON position.
 - It appears for approximately 3 seconds and then goes off.
- When you select AWD lock mode by pressing the AWD LOCK button.
 - The AWD lock mode is to increase the drive power when driving on wet pavement, snow covered roads and/or off-road.

*** NOTICE**

AWD lock mode

Do not use AWD LOCK mode on dry paved roads or highways, it can cause noise, vibration or damage of AWD related parts.

Ready indicator READY

This indicator illuminates:

When the vehicle is ready to be driven.

- ON: Normal driving is possible.
- OFF: Normal driving is not possible, or a problem has occurred.

Engine coolant temperature warning light 

The warning light appears:

When the temperature of the engine coolant is extremely high. Do not continue driving with an overheated engine. If your vehicle overheats, refer to "If the engine overheats" on page 8-7

*** NOTICE**

If the Engine Coolant Temperature warning light appears, it indicates overheating that may damage the engine.

EV mode indicator 

This indicator illuminates:

When the vehicle is driven by the electric motor.

- "EV" indicator ON: Vehicle is driven using the electric motor or the gasoline engine is stopped.
- "EV" indicator OFF: Vehicle is driven using the gasoline engine.

Charging cable connection indicator light  (Plug-in hybrid vehicle)

This indicator illuminates in red when the charging cable is connected.

Drive mode indicator light (ECO/NORMAL/SPORT)

This indicator light appears:

- When you select each mode as drive mode.

For more details, refer to "Drive mode integrated control system" on page 6-48.

LCD display

The LCD display modes can be changed by using the control buttons.

LCD Display Control



Switch	Control	Action
Mode (1) 	Short Press	Changing view modes
Up/Down (2) 	Short Press	Searching Utility information
OK (3)	Short Press	Operating additional functions
	Long Press	Resetting menu information

LCD display modes

View	Description
Driving Assist view	Displays information related to Driver assistance system
Navigation view	Displays information related to navigation system
Utility information view	Displays information related to driving, warning, etc.

Driving assist view



This mode displays the state of:

- Lane Keeping Assist
- Smart Cruise Control (if equipped)
- Navigation-based Smart Cruise Control (if equipped)
- Lane Following Assist
- Highway Driving Assist (if equipped)

* For more details, refer to each system information in "Driving your vehicle" on page 6-4.

Navigation view

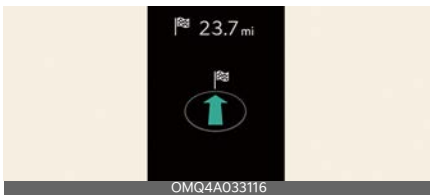

This mode displays the state of the navigation.

Utility information view

Low tire pressure warning display

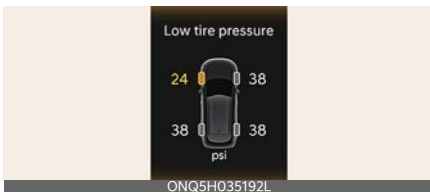

A: Tire pressure

Information related to tire pressure

* For more details, refer to each system information in "Tire Pressure Monitoring System (TPMS)" on page 8-8.

Drive info display

This display shows the trip distance (1), the average fuel efficiency (2), and the total driving time (3) information once per one ignition cycle.

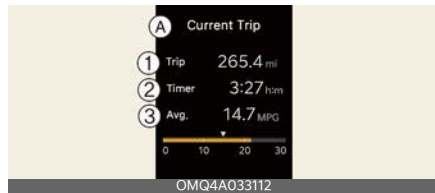

A: Current Trip

1 Trip

2 Timer

3 Avg.

- Fuel efficiency is calculated after the vehicle has run for more than 0.19 miles (300 m).
- The information will automatically reset when the driver's door is opened after the vehicle is turned off, or approximately 3 minutes have passed after the vehicle is turned off.
- If you press "OK" button for more than approximately 1 second after the Driving Information is displayed, the information will be reset.
- If the engine is running, even when the vehicle is not in motion, the information will be accumulated.

* NOTICE

The vehicle must be driven for a minimum of 0.19 miles (300 m) since the last ignition cycle before the average accu-

culated driving information is recalculated.

Information since refueling

This display shows the trip distance, the average fuel efficiency, and the instant fuel efficiency (or the total driving time) since refueling.

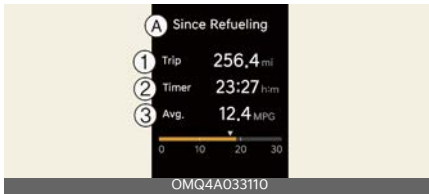

A: Since Refueling

- 1 Trip
- 2 Timer
- 3 Avg.

- Information since refueling is calculated after the vehicle has run for more than approximately 0.19 miles (300 m).
- If you press "OK" button for more than 1 second after the information since refueling is displayed, the information will be reset.
- When driving after refueling, the information will be automatically reset.
- If the engine is running, even when the vehicle is not in motion, the information will be accumulated.

* NOTICE

The vehicle must be driven for a minimum of 0.19 miles (300 m) since the last ignition cycle before the average accumulated driving information is recalculated.

Accumulated driving information mode

This display shows the accumulated trip distance, the average fuel efficiency, and the total driving time.

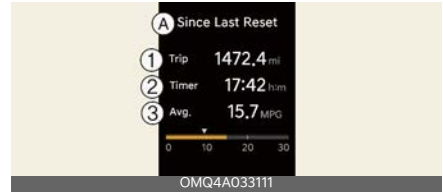

A: Since Last Reset

- 1 Trip
- 2 Timer
- 3 Avg.

- Accumulated information is calculated after the vehicle has run for more than 0.19 miles (300 m).
- If you press "OK" button for more than 1 second after the Cumulative Information is displayed, the information will be reset.
- If the engine is running, even when the vehicle is not in motion, the information will be accumulated.

Fuel economy

This information is always displayed at the bottom center of the Full LCD cluster.

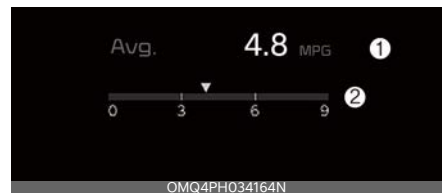

- 1 Average energy economy
- 2 Instant energy economy

Average Fuel Economy (1)

- The average fuel economy is calculated by the total driving distance and fuel consumption since the last average fuel economy resets.
 - Fuel economy range: 0-99.9 MPG or km/L, L/100 km

* NOTICE

The average fuel economy is not displayed for more accurate calculation if the vehicle does not drive more than 10 seconds or 0.03 mi (50 m) since the ENGINE START/STOP button is turned ON.

Instant Fuel Economy (2)

- This mode displays the instant fuel economy during the last few seconds when the vehicle speed is more than 6.2 mph (10 km/h).
 - Fuel economy range: 0.0-30 km/L, L/100 km or 0.0-50.0 MPG

Energy flow

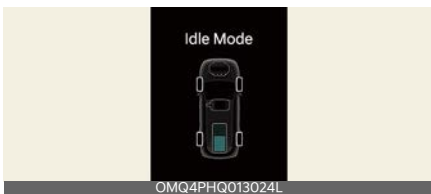

The hybrid system informs the driver about its energy flow in various operating modes. While driving, the current energy flow is specified in 11 modes.

* For more details, refer to "Energy flow" on page 1-35.

Other view modes

Service mode

This mode reminds you of scheduled maintenance information.

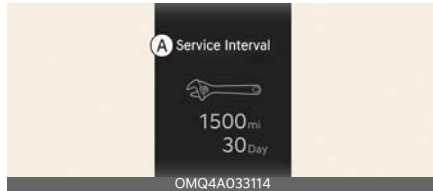

A: Service Interval

Service Interval

It calculates and displays when you need a scheduled maintenance service (mileage or days).

If the remaining mileage or time reaches 900 miles (1,500 km) or 30 days, "Service interval" message is displayed for several seconds each time you set the ENGINE START/STOP button to the ON position.

Service required

If you do not have your vehicle serviced according to the already inputted service interval, "Service required" message is displayed for several seconds each time you set the ENGINE START/STOP button to the ON position.

To reset the service interval to the mileage and days you inputted before:

- Press the OK button (Reset) for more than 1 second.

* NOTICE

If any of the following conditions occurs, the mileage and days may be incorrect.

- The battery connector is disconnected.

- The battery is discharged.

Master warning mode



This mode informs you of the following situations:

- Driver assistance system malfunction, limitation or radar/camera blockage (if equipped)
- LED headlamp malfunction
- Lamp malfunction
- TPMS (Tire Pressure Monitoring System) failure, low tire pressure, etc.

The Master Warning icon () will appear. If the situation resolves, the master warning light will turn off and the Master Warning icon will disappear.

LCD display messages

Door, hood, liftgate, sunroof open

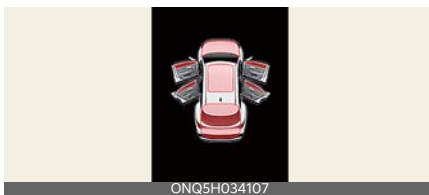

- This warning is displayed when a door, the hood, the liftgate or the sunroof is open.

Low tire pressure warning display



A: Low tire pressure

This warning message is displayed if the tire pressure is low. The corresponding tire on the vehicle will appear.

* For more details, refer to "Tire Pressure Monitoring System (TPMS)" on page 8-8.

Lights mode



A: Lights

This indicator displays which exterior light is selected using the lighting control.

You can activate or deactivate Wiper/Lights Display function from the User Settings mode in the cluster LCD display.

Wiper mode

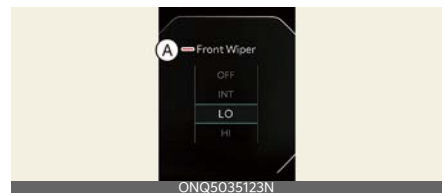

A: Front Wiper

This indicator displays which wiper speed is selected using the wiper control.

You can activate or deactivate Wiper/Lights Display function from the User Settings mode in the cluster LCD display.

Low washer fluid (if equipped)

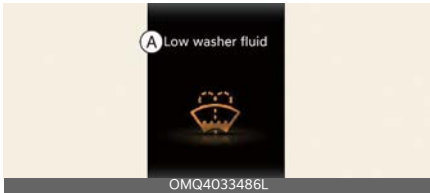

A: Low washer fluid

This warning message is displayed if the washer fluid level in the reservoir is nearly empty.

Refill the washer fluid reservoir.

Icy road warning

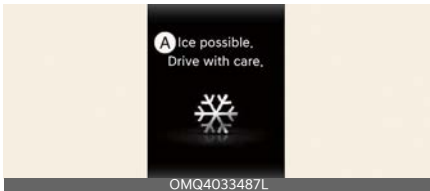

A: Ice possible. Drive with care

This warning is to warn the driver the road may be icy.

When the following conditions occur, the warning light (including outside temperature gauge) blinks 5 times and then remains illuminated. The warning chime sounds once.

- The temperature on the outside temperature gauge is below approximately 40 °F (4 °C).

* NOTICE

If the icy road warning appears while driving, you should drive even more attentively and safely refraining from speeding, rapidly accelerating, sudden braking or sharp turning, etc.

Engine overheated

- This warning message appears when the engine coolant temperature is above 248 °F (120 °C). This means that the engine is overheated and may be damaged.

* If your vehicle is overheated, refer to "If the engine overheats" on page 8-7.

Low engine oil

- This warning message appears when the engine oil level is insufficient.
 - Refill the engine oil.
- * For more details, refer to "Engine oil" on page 9-15.

⚠ WARNING

When the engine oil level warning light occurs, it is necessary to check whether maintenance schedule (Engine oil replacement) in owner's manual has been followed before replenishing the oil, and if not followed, the engine oil must be replaced first.

Engine oil change due soon. Reset oil life after oil change

- This warning message illuminates when the remaining engine oil life reaches 5% or below.
- Replace engine oil from an authorized Kia dealer. After that, select **Convenience** → **Oil Change Reminder** from the User Settings menu on the cluster or **Vehicle** → **Cluster** → **Oil Change Reminder** from Settings menu on the infotainment system screen to reset the remaining oil life.

* For more details, refer to "Engine oil and filter" on page 9-13.

Engine oil change due now. Reset oil life after oil change

- This warning message illuminates when the remaining engine oil life reaches 1% or below.
- Replace engine oil immediately from an authorized Kia dealer. After that, select **Convenience** → **Oil Change Reminder** from the User Settings menu on the cluster or **Vehicle** → **Cluster** → **Oil Change Reminder** from the Settings menu on the infotainment system screen to reset the remaining oil life.

* For more details, refer to "Engine oil and filter" on page 9-13.

Low key battery (for smart key system)

- This warning message appears if the battery of the smart key is discharged when the ENGINE START/STOP Button changes to the OFF position.

Press START button while turning wheel (for smart key system)

- This warning message appears if the steering wheel does not unlock normally when the ENGINE START/STOP Button is pressed.
- It means that you should press the ENGINE START/STOP Button while turning the steering wheel right and left.

Steering wheel not locked (for smart key system)

- This warning message appears if the steering wheel does not lock when the ENGINE START/STOP Button changes to the OFF position.

Check steering wheel lock system (for smart key system)

- This warning message appears if the steering wheel does not lock normally when the ENGINE START/STOP Button changes to the OFF position.

Key not in vehicle (for smart key system)

- This warning message appears if the smart key is not in the vehicle when you press the ENGINE START/STOP Button.

Key not detected (for smart key system)

- This warning message appears if the smart key is not detected when you press the ENGINE START/STOP Button.

Shift to P to start engine (for smart key system)

- This warning message appears if you try to start the engine with the gear not in the P (Park) position.

Press brake pedal to start engine (for smart key system)

- This warning message appears if the ENGINE START/STOP Button changes to the ACC position twice by pressing the button repeatedly without depressing the brake pedal.
- Depress the brake pedal to start the engine.

Battery discharging due to external electrical devices

The vehicle can detect self-discharge of the battery due to over-current that is generated by unauthorized electrical devices such as dashboard camera (dash cam).

If the warning continues even after external electrical devices are removed, have your vehicle inspected by an authorized Kia dealer.

Press START button again (for smart key system)

- This warning message appears if you cannot operate the ENGINE START/STOP Button when there is a problem with the ENGINE START/STOP Button system.
- Start the engine by pressing the ENGINE START/STOP button once more.
- If the warning appears each time you press the ENGINE START/STOP But-

ton, have the vehicle inspected by an authorized Kia dealer.

Press START button with key (for smart key system)

- This warning message appears if you press the ENGINE START/STOP Button while the warning message "Key not detected" is appeared.
- The immobilizer indicator light blinks.

Unplug vehicle to start (Plug-in hybrid vehicle)

The message is displayed when you start the engine without unplugging the charging cable.

Remaining Time (Plug-in hybrid vehicle)

The message is displayed to notify the remaining time to fully charge the battery.

Shift to P to charge (Plug-in hybrid vehicle)

The message is displayed when the charging connector is plugged with the shift dial in R (Reverse), N (Neutral) or D (Drive). Move the shift dial to P (Park) and re-start the charging process.

Electric mode/Automatic mode/Hybrid mode (Plug-in hybrid vehicle)

A corresponding message is displayed when a mode is selected by pressing the HEV button.

Low battery. Maintaining Hybrid mode (Plug-in hybrid vehicle)

This message is displayed when unable to convert to EV mode even when pressing the HEV button during HEV mode driving due to insufficient high-voltage (hybrid) battery level.

Low system temperature. Switching to Hybrid mode/High system temperature. Switching to Hybrid mode (Plug-in hybrid vehicle)

This message is displayed when the temperature of the high-voltage (hybrid) battery is too low or high.

This warning message is to protect the battery and the hybrid system.

Low system temperature. Maintaining Hybrid mode/High system temperature. Maintaining Hybrid mode (Plug-in hybrid vehicle)

This message is displayed when the temperature of the high-voltage (hybrid) battery is too low or too high. This warning message is to protect the battery and the hybrid system.

Wait until fuel door opens (Plug-in hybrid vehicle)

This message is displayed when you attempt to open the fuel filler door with the fuel tank pressurized. Wait until the fuel tank is depressurized.

Fuel door open (Plug-in hybrid vehicle)

This message is displayed when the fuel filler door opens after the fuel tank is depressurized. You can then refuel.

Charging stopped. Check the AC charger (Plug-in hybrid vehicle)

This message is displayed when charging fails because of an external charger error.

This message is to let you know the error has occurred in the charger itself, not in the vehicle.

Charging stopped. Check the cable connection (Plug-in hybrid vehicle)

This message is displayed when charging is stopped because the charging connector is not correctly connected to the charging inlet. If this occurs, separate the charging connector, re-connect it and check whether there is any problem (external damage, foreign substances, etc.) with the charging connector and charging inlet. If the problem recurs even after replacing charging cable or genuine Kia portable charger, have the vehicle inspected by an authorized Kia dealer.

Charging Door Open (Plug-in hybrid vehicle)

This message indicates that the charging door is open while in a driving ready state. Close the charging door. Driving with the charging door open may result in moisture inflow or damage.

Switching to Hybrid mode to allow heating or air conditioning (Plug-in hybrid vehicle)

- When the outdoor temperature is lower than 5 °F (-15 °C) and the coolant temperature is lower than 158 °F (70 °C), turn the climate control On for heating. The vehicle will automatically

switch to HEV mode and EV mode will not be activated (although EV/HEV button is pressed)

- When the outdoor temperature is higher than 14 °F (-10 °C), or the coolant temperature is higher than 176 °F (80 °C) or you turn the climate control Off, the vehicle will automatically return to EV mode.

Switching to Hybrid mode for self-diagnosis (Plug-in hybrid vehicle)

This message is displayed for self-diagnosis of the hybrid mode system.

Low fuel

- This warning message is displayed if the fuel tank is almost out of fuel.
- When this message is displayed, the low fuel level warning light in the cluster will come on.
- It is recommended to look for the nearest fuel station and refuel as soon as possible.

Check Active Air Flap System

This warning message appears in the following situations:

- There is a malfunction with the actuator flap.
- There is a malfunction with the actuator air flap controller.

When all of the above conditions are fixed, the warning disappears.

Driver Assistance settings (infotainment system)



Select **Setup** → **Vehicle** → **Driver Assistance** on the infotainment system screen to set the Driver Assistance function.

- **Driver Assistance**
 - **Driving Convenience**
 - **Speed Limit**
 - **Driver Attention Warning**
 - **Warning Methods**
 - **Driving Safety**
 - **Parking Safety**

* INFORMATION

- The infotainment system may change after software updates. For more information, refer to the manual provided in the infotainment system and the quick reference guide.

Head-Up Display (HUD) (if equipped)

The Head-Up Display is a transparent display that projects an image of certain information from the instrument cluster and navigation system on the windshield glass.



- The head up display image on the HUD screen may be hard to see when:
 - Sitting posture is bad.
 - Wearing polarized sunglasses.
 - There is an object on the cover of the head up display.
 - Driving on a wet road.
 - An inadequate lighting is turned on inside the vehicle.
 - Any light comes from the outside.
 - Wearing inadequate glasses for your eyesight.
- If the head up display image is hard to see, adjust the height, rotation or illumination of the head up display in the LCD display.
- If the Head-Up Display needs inspection or repair, have your vehicle inspected or repaired by an authorized Kia dealer.

WARNING

Head-Up Display

- Do not add tint or other types of metallic coating to the windshield. The Head-Up Display image may be obscured.

- Do not place any accessories on the instrument panel or attach any objects on the windshield.
- The Blind-Spot Collision Warning is a supplemental device to assist when changing lanes. It is not a substitute for the driver turning the head and looking directly to see that the adjacent lane is safe to enter. Do rely on only the Blind-Spot Collision Warning when changing lanes.

CAUTION

When replacing the front windshield glass of the vehicles equipped with the Head-Up Display, replace it with a windshield glass designed for the Head-Up Display operation. Otherwise, duplicate images may be displayed on the windshield glass.

Head-Up Display Information



- 1 Turn By Turn navigation information (if equipped)
- 2 Traffic information
- 3 Speedometer
- 4 Smart Cruise Control (SCC) set speed information (if equipped)
- 5 Smart Cruise Control (SCC) vehicle distance information (if equipped)
- 6 Lane Following Assist information (if equipped)
- 7 Lane Safety information (if equipped)
- 8 Blind-Spot Safety information (if equipped)

- 9 Highway Driving Assist information (if equipped)
- 10 Highway Auto Speed Change information (if equipped)
- 11 Surrounding vehicle information (if equipped)

* NOTICE

Road Signs and Turn By Turn navigation information are available in some regions.

Head-Up Display Setting

On the LCD display, you can change the head up display settings as follows.

1. Display height
2. Rotation
3. Brightness
4. Content selection

* For more details, refer to "LCD display modes" on page 5-89.

Lighting

This vehicle is equipped with a variety of lights to appear on the interior and exterior of the vehicle.

⚠ CAUTION

To prevent battery discharge, do not leave the headlamp and interior light on for a prolonged time while the engine is not running.

Battery saver function

The purpose of this feature is to prevent the battery from being discharged if the lights are left in the ON position. The system automatically shuts off the parking lights after the engine is off and the driver's door is opened.

The position lamps stay ON even when the driver-side door is opened if the light switch is operated after the engine is turned off.

If necessary, to keep the lamps on turn the position lamps OFF and ON again using the headlamp switch on the steering column after the engine is turned off.

Headlamp delay function

If you place the ENGINE START/STOP Button in the ACC or OFF position with the headlamps ON, the headlamps (and/or parking lights) remain on for about 5 minutes. However, with the engine off if the driver's door is opened and closed, the headlamps (and/or parking lights) turn off after 15 seconds.

The headlamps (and/or parking lights) can be turned off by pressing the lock button on the key twice or turning the light switch to the OFF or AUTO position. However, if you turn the light switch to the AUTO position when it is dark outside, the headlamps will not be turned off.

You can activate or deactivate the Headlamp Delay function from the User Settings Mode in the LCD display. For more details, refer to "LCD display" on page 5-89. If your vehicle is equipped with additional navigation, please refer to the infotainment system manual supplied separately.

*** NOTICE**

If the driver exits the vehicle through a door other than the driver door, the battery saver function does not operate and the headlamp delay function does not turn OFF automatically.

This may cause the battery to discharge. To avoid battery discharge, turn OFF the headlamps manually from the headlamp switch before exiting the vehicle.

Daytime Running Light (DRL)

The Daytime Running Lights (DRL) can make it easier for others to see the front of your vehicle during the day, especially after dawn and before sunset. The Daytime Running Lights (DRL) should be illuminated whenever you are driving during daylight hours.

The DRL system will be ON when the headlamp switch is in the OFF or the AUTO Position (when daylight is detected) and the Electronic Parking Brake (EPB) is released.

The DRL will turn the dedicated lamp OFF when:

- The headlamps are ON.
- The vehicle is off.
- The taillight is ON.
 - It includes that the taillight is on in the dark when the light switch is in the auto light position.
- Engaging the parking brake.

Lighting control

The light switch has a headlamp and a position lamp position.



To operate the lights, turn the knob at the end of the lights, turn the knob at the end of the control lever to one of the following positions:

- 1 OFF position
- 2 Auto light position
- 3 Position & Taillamp
- 4 Headlamp position

Position & Taillamp



When the light switch is in the position lamp position, the front position lamp, tail lamp, and the license plate lamp will turn ON.

Headlamp (Low Beam)



When the light switch is in the headlamp position, headlamp (low beam), tail, license light will turn ON.

*** NOTICE**

the ENGINE START/STOP Button must be in the ON position to turn on the headlamps.

Auto light



When the light switch is in the AUTO light position, the taillamps and headlamps will turn ON or OFF automatically depending on the amount of light outside the vehicle.

⚠ CAUTION

- Do not place anything over the sensor (1) located on the instrument panel. Objects will interfere with the auto-light system control.
- Don't clean the sensor using a window cleaner, the cleaner may leave a light film which could interfere with sensor operation.
- If your vehicle has window tint or other types of metallic coating on the windshield, the Auto light system may not work properly.

Operating high beam



To turn on the high beam headlamps:

- Push the lever away from you.
The lever will return to its original position.
The high beam indicator will light when the headlamp high beams are switched on.

⚠ WARNING

High beams

Do not use high beam when there are other vehicles in front of or approaching your vehicle. Using high beam could obstruct the other drivers vision.

To flash the headlamps:

- Pull the lever towards you.



It will return to the normal (low beam) position when released. The headlamp switch does not need to be on to use this flashing feature.

Operating turn signals and lane change signals



the ENGINE START/STOP Button must be on for the turn signals to function.

To turn on the turn signals:

- Move the lever up or down (1).

The green arrow indicators on the instrument panel indicate which turn signal is operating.

They will self-cancel after a turn is completed. If the indicator continues to flash after a turn, manually return the lever to the OFF position.

To signal a lane change:

- Move the turn signal lever slightly and hold it in position (2).

The lever will return to the OFF position when released.

If an indicator stays on and does not flash or if it flashes abnormally, one of the turn signal bulbs may be burned out and require replacement.

One-touch lane change function

To activate a one-touch lane change function, move the turn signal lever slightly and then release it. The lane change signals will blink 3, 5 or 7 times.

You can activate or deactivate the One Touch Turn Signal function or choose the number of blinking (3, 5, or 7) by selecting **Vehicle** → **Lights** → **One Touch Turn Signal**.

* NOTICE

If an indicator flash is abnormally quick or slow, a bulb may be burned out or have a poor electrical connection in the circuit. The bulb may require replacement.

Operating front fog lights \neq (if equipped)

Fog lights are designed to provide improved visibility when visibility is poor due to fog, rain or snow, etc.



The fog lights will turn on when the fog light switch (1) is turned to the on position after the headlamp is turned on.

To turn off the fog lights:

- Turn the fog light switch (1) to the ON position.

⚠ CAUTION

The fog lights consume large amounts of vehicle electrical power. Only use the fog lights when visibility is poor.

High Beam Assist (HBA) (if equipped)



High Beam Assist is a function that automatically adjusts the headlamp range

(switches between high beam and low beam) depending on the brightness of detected vehicles and certain road conditions.

Detecting sensor

Front view camera



The front view camera is used as a detecting sensor to detect ambient light and brightness while driving.

Refer to the picture above for the location of the front view camera.

* NOTICE

- Always keep the front view camera in good condition to maintain optimal performance of HBA.
- For more details on the precautions of the front view camera, refer to "Forward Collision-Avoidance Assist (FCA) (Sensor Fusion)" on page 7-5.

HBA setting



A: **Vehicle Settings**

1 Lights

2 High Beam Assist

With the vehicle in the ON position, select **Setup** → **Vehicle** → **Lights** →

High Beam Assist from the Settings menu to turn on High Beam Assist and deselect to turn off the function.

⚠ WARNING

For your safety, adjust your high beam settings only after parking the vehicle at a safe location.

High Beam Assist operation

Display and control

- After selecting '**High Beam Assist**' in the Settings menu, HBA will operate by following the procedure below.
 - Place the headlamp switch in the AUTO position and push the headlamp lever towards the instrument cluster. The HBA (≡D)_{AUTO} indicator light will appear on the cluster and the function will be enabled.
 - When the function is enabled, high beam will turn on when vehicle speed is above 20 mph (30 km/h). When vehicle speed is below 12 mph (20 km/h), high beam will not turn on, the white High Beam (≡D) indicator lights will appear on the cluster.
 - The High Beam (≡D)_{AUTO} indicator light will appear on the cluster when the high beam is on.
- When HBA is operating, if the headlight lever or switch is used, the function operates as follows:
 - If the headlamp lever is pulled towards you when the high beam is off, the high beam will turn on without HBA canceled. When you let go of the headlamp lever, HBA will turn on again.

- If you push the light switch towards the instrument cluster, the high beam is turned on and HBA is released.
- If the headlamp lever is pulled towards you when the high beam is on via HBA, the low beam will be on, and the function will turn off.
- If the headlamp switch is placed from AUTO to another position (headlamp/position/off), High Beam Assist will turn off and the corresponding lamp will turn on.
- When HBA is operating, high beam switches to low beam if any of the following conditions occur:
 - When the headlamps of an oncoming vehicle are detected.
 - When the taillamp of a vehicle in front is detected.
 - When the headlamp or taillamp of a motorcycle or a bicycle is detected.
 - When the surrounding ambient light is bright enough that high beams are not required.
 - When streetlights or other lights are detected.

Have the function inspected by an authorized Kia dealer.

Limitations

HBA may not work properly in the following situations:

- Light from a vehicle is not detected because of lamp damage, or because it is hidden from sight, etc.
- The headlamps of a vehicle are covered with dust, snow or water.
- A vehicle's headlamps are off, but the fog lamps are on. etc.
- There is a lamp that has a similar shape to a vehicle's lamp.
- Headlamps have been damaged or not repaired properly.
- Headlamps are not aimed properly.
- Driving on a narrow curved road, rough road, uphill or downhill.
- A Vehicle in front is partially visible on a crossroad or curved road.
- There is a traffic light, reflecting sign, flashing sign or mirror ahead.
- There is a temporary reflector or flash ahead (construction area).
- The road conditions are poor such as being wet, iced or covered with snow.
- A vehicle appears from a curve.
- The vehicle is tilted from a flat tire or is being towed.
- Light from a vehicle is not detected because of exhaust fumes, smoke, fog, snow, etc.
- When the lighting switch is not in the AUTO position.
- When the high beam assist function is turned off.
- When the vehicle speed is reduced to 35 km/h or lower.

Malfunction and limitations

Malfunction

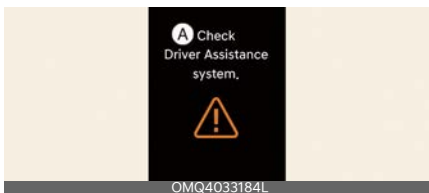

A: Check Driver Assistance system
 When HBA is not working properly, the **Check High Beam Assist (HBA) system** warning message will appear and warning light (⚠) will appear on the cluster.

*** NOTICE**

- Depending on the instrument cluster specification or theme, images or colors may be displayed differently.
- For more details on the limitations of the front view camera, refer to "Forward Collision-Avoidance Assist (FCA (Sensor Fusion))" on page 7-5.



*** NOTICE**

- At times, HBA may not work properly. The function is for your convenience only. It is the responsibility of the driver for safe driving practices and to always check the road conditions for your safety.
- When HBA does not operate normally, change the headlamp position manually between high beam and low beam.

Wipers and washers

The wipers and washers remove foreign substances from the windshield and rear window, helping to maintain visibility.



- 1 Wiper speed control**
 - MIST - Single wipe
 - OFF - Off
 - AUTO - Auto control wipe
 - LO - Low wiper speed
 - HI - High wiper speed
- 2 Rear wiper/washer control**
 - HI - Continuous wipe
 - LO - Intermittent wipe
 - OFF - Off
- 3 Wash with brief wipes**
 - Front - Pull lever towards you 
 - Rear - Push lever away from you 

Windshield wipers

Operate as follows when the ENGINE START/STOP Button is ON.

- MIST: For a single wiping cycle, move the lever to this position and release it. The wipers will operate continuously if the lever is held in this position.
- OFF: Wiper is not in operation
- LO: Normal wiper speed
- HI: Fast wiper speed

* NOTICE

If there is heavy accumulation of snow or ice on the windshield, defrost the windshield for about 10 minutes, or until the snow and/or ice is removed before using the windshield wipers to ensure proper operation. If you do not remove snow and ice before using the wiper and washer, it may damage the wiper and washer system.

⚠ WARNING

Do not use the washer in freezing temperatures without first warming the windshield with the defroster; the washer solution could freeze on the windshield and obscure your vision, resulting in an accident.

* INFORMATION

If you operate the wipers while driving on snowy roads, the wipers may stop due to snow buildup on your windshield. This is normal and not a failure because it is one of our safety features to prevent vehicle accidents and wiper damage from overloading the wiper motor. If the wipers stop, remove snow accumulated on the top or bottom of windshield before using them.

Auto control



The rain sensor (1) located on the upper edge of the windshield senses the amount of rainfall and controls the wip-

ing cycle for the proper interval. The more it rains, the faster the wiper operates. When the rain stops, the wiper stops.

To vary the speed setting, turn the speed control knob (B).

If the wiper switch is set in AUTO mode when the ENGINE START/STOP Button is ON, the wiper will operate once to perform a self-check of the system. Set the wiper to OFF position when the wiper is not in use.

⚠ WARNING

When the ENGINE START/STOP Button is ON and the windshield wiper switch is placed in the AUTO mode, use caution in the following situations to avoid any injury to the hands or other parts of the body:

- Do not touch the upper end of the windshield glass facing the rain sensor.
- Do not wipe the upper end of the windshield glass with a damp or wet cloth.
- Do not put pressure on the windshield glass.

⚠ CAUTION

- When washing the vehicle, set the wiper switch in the OFF position to stop the auto wiper operation.

The wiper may operate and be damaged if the switch is set in the AUTO mode while washing the vehicle.

- Do not remove the sensor cover located on the upper end of the passenger side windshield glass. Damage to system parts could occur and may not be covered by your warranty.

- If there is heavy snow or ice on the windshield, set the wiper switch in the OFF position before starting the vehicle. Otherwise, the snow and ice may damage the windshield wiper blades. Always remove all snow and ice and defrost the windshield properly before operating the windshield wipers.
- When tinting the windshield, be careful of any fluid getting into the sensor located in the top center of the front windshield. It may damage the related parts.

Operating windshield washers



1. Move the wiper speed control switch to the OFF position.
2. Pull the lever gently toward you to spray washer fluid on the windshield and to run the wipers 1-3 cycles. Use this function when the windshield is dirty. The spray and wiper operation will continue until you release the lever.

If the washer does not work, check the washer fluid level. If the fluid level is insufficient, you will need to add appropriate non-abrasive windshield washer fluid to the washer reservoir.

The reservoir filler neck is located in the front of the engine compartment on the passenger side.

⚠ CAUTION

To prevent damage to the washer pump, do not operate the washer when the fluid reservoir is empty.

⚠ CAUTION

- To prevent damage to the wipers or windshield, do not operate the wipers when the windshield is dry.
- To prevent damage to the wiper blades, do not use gasoline, kerosene, paint thinner, or other solvents on or near them.
- To prevent damage to the wiper arms and other components, do not attempt to move the wipers manually.
- To prevent possible damage to the wipers and washer system, use anti-freezing washer fluids in winter or cold weather.

Operating rear window wiper and washer switch

The rear window wiper and washer switch is located at the end of the wiper and washer switch lever.

- Turn the switch to the desired position to operate the rear wiper and washer.



- HI - Normal wiper operation
- LO - Intermittent wiper operation
- OFF - Wiper is not in operation
- Push the lever away from you to spray rear washer fluid and to operate the rear wipers several times.



The spray and wiper operation will continue until you release the lever.

When the front wiper is activated and the gear is switched to R (Reverse) position, the rear wiper will be activated once to provide better visibility.

Welcome system (if equipped)

The welcome system illuminates the surroundings and the interior when the driver approaches or exits the vehicle.

Door handle lamp (if equipped)



When all the doors (and liftgate) are closed and locked, the door handle lamp will come on for about 15 seconds if any of the below is performed.

- When the door unlock button is pressed on the smart key.
- When the button of the outside door handle is pressed.
- When you approach the vehicle with the smart key in possession.

Headlamp (headlamp) escort function

The headlamps (and/or taillamps) remain on for approximately 5 minutes after the ignition key is removed or turned to the ACC or LOCK position. However, if the driver's door is opened and closed, the headlamps are turned off after 15 seconds.

The headlamps can be turned off by pressing the lock button on the transmitter or smart key twice or turning off the light switch from the headlamp or Auto light position.

Interior light

When the interior light switch is in the DOOR position and all doors (and lift-gate) are locked and closed, the room lamp will come on for 30 seconds if any of the following occurs:

- With the smart key system
 - When the door unlock button is pressed on the smart key.
 - When the button of the outside door handle is pressed.

If you press the door lock button, the lamps will turn off immediately.

Dynamic Welcome Light (if equipped)

This feature dynamically represents the vehicle's lights for a certain period of time when the driver unlocks the vehicle, enhancing its aesthetic appeal.

Dynamic Welcome Light will turn on for approximately 2 seconds when all the doors (and trunk) are closed and locked.

- The smart key's door unlock button is pressed (if the Headlight time-out activates).
- Select **Setup** → **Vehicle** → **Lights** → **Headlight time-out** on the infotainment system screen.

Interior lights

This vehicle is equipped with lights throughout the vehicle to illuminate the interior.

CAUTION

Do not use the interior lights for extended periods when the engine is not running.

It may cause battery discharge.

WARNING

Do not use the interior lights when driving in the dark. Accidents could happen because the view may be obscured by interior lights.

Automatic turn off function

The interior lights automatically turn off approximately 20 minutes after the ENGINE START/STOP button is turned off, if the lights are in the ON position.

If your vehicle is equipped with the theft alarm system, the interior lights automatically turn off approximately 5 seconds after the system is armed.

Interior lights always on

The Interior lights always on function turns on the interior button lights regardless of the day or night condition. Select **Setup** → **Vehicle** → **Lights** → **Interior Lights Always On** on the infotainment system screen.

After the function is enabled, the Interior button lights are turned on or off in the following situations:

- When all doors are closed and locked, if you unlock the door, the interior button lights will illuminate for approximately 5 minutes.

- When the vehicle is turned off, the interior button lights are turned on for approximately 5 minutes.
At this time, if you open and close the door or lock the doors, the interior button lights are turned off immediately.

Map lamp

Type A



Type B



- Press the lens (1) to turn ON the map lamp.
To turn the map lamp OFF press the lens (1) again.
-  (2): DOOR mode
 - The map lamp and room lamp come on when a door is opened. The lamps go out after approximately 30 seconds.
 - The map lamp and room lamp come on for approximately 30 seconds when doors are unlocked with a smart key if the doors are not opened.
 - The map lamp and room lamp will stay on for approximately 20 minutes if a door is opened with the

ENGINE START/STOP button in the ACC or OFF position.

- The map lamp and room lamp will stay on continuously if the door is opened with the ENGINE START/STOP button in the ON position.
- The map lamp and room lamp will go out immediately if the ENGINE START/STOP button is changed to the ON position or all doors are locked.
- To turn off the DOOR mode, press the DOOR button (2) once again (not pressed).
-  (3): Press this switch to turn the front and rear room lamps on and off.

* NOTICE

The DOOR mode and ROOM mode cannot be selected at a time.

Room lamp (if equipped)



Press the switch to turn the room lamp on and off.

Personal lamp (if equipped)



Press the switch to turn the room lamp on and off.

Luggage compartment lamp

- ☀️: The lamp will always turn on when the liftgate is opened/closed.
- 🚗: The lamp is on when the liftgate is opened, and off when the liftgate is closed.
- ☾: The lamp will always turn off when the liftgate is opened/closed.



The luggage compartment lamp comes on when the liftgate is opened.

⚠️ CAUTION

The luggage room lamp comes on if the liftgate opens. To prevent unnecessary charging system drain, close the liftgate securely after using the luggage compartment.

Vanity mirror lamp (if equipped)



Push the switch to turn the light on or off.

- ☀️: The lamp will turn on if this button is pressed.
- : The lamp will turn off if this button is pressed.

⚠️ CAUTION

Vanity mirror lamp

Always close the lid of the vanity mirror in the off position when the vanity mirror lamp is not in use. If the sun visor is closed with the lamp on, it may drain the battery or damage the sun visor.

Glove box lamp



The glove box lamp turns on when the glove box is opened.

* NOTICE

To prevent unnecessary charging system drain, close the glove box securely after using the glove box.

Climate control system



The climate control system uses cooling and heating to help maintain a pleasant environment inside the vehicle.

System operation

Ventilation

1. Set the mode to the  position.
2. Set the air intake control to the outside (fresh) air position.
3. Set the temperature control to the desired position.
4. Set the fan speed control to the desired speed.

Heating

1. Set the mode to the  position.
2. Set the air intake control to the outside (fresh) air position.
3. Set the temperature control to the desired position.
4. Set the fan speed control to the desired speed.
5. If dehumidified heating is desired, turn the air conditioning system on.
 - If the windshield fogs up, set the mode to the  or  position.

Operation tips

- To keep dust or unpleasant fumes from entering the vehicle through the ventilation system, temporarily set the air intake control to the recirculated air position. Be sure to return the control to the fresh air position when the irritation has passed to keep fresh air in the vehicle. This will help keep the driver alert and comfortable.

- Air for the heating/cooling system is drawn in through the grilles just at the base of the windshield. Care should be taken that these are not blocked by leaves, snow, ice or other obstructions.
- To prevent fog from forming on the inside of the windshield:
 - Set the air intake control to the fresh air position and the fan speed to the desired position.
 - Turn on the air conditioning system and adjust the temperature control to desired temperature.

Air conditioning (A/C)

All Kia A/C systems are filled with R-1234yf refrigerant.

1. Start the vehicle. Press the A/C button.
2. Set the mode to the  position.
3. Set the air intake control to the outside-air or recirculated air position.
4. Adjust the fan speed control and temperature control to maintain maximum comfort.

CAUTION

- The refrigerant system should only be serviced by trained and certified technicians to insure proper and safe operation.
- The refrigerant system should be serviced in a well-ventilated place.
- The air conditioning evaporator (cooling coil) shall never be repaired or replaced with one removed from a used or salvaged vehicle and new replacement Mobile Air Conditioning (MAC) evaporators should be certified

(and labeled) as meeting SAE Standard J2842.

⚠ CAUTION

Excessive air conditioning use

When using the A/C system, monitor the temperature gauge closely while driving up hills or in heavy traffic when outside temperatures are high. A/C system operation may cause vehicle overheating. Continue to use the blower fan but turn the A/C system off if the temperature gauge indicates vehicle overheating.

⚠ CAUTION

The A/C system should only be used with the windows and sunroof closed to prevent condensation inside the vehicle that may cause damage to electrical components.

A/C system operation tips

- If your vehicle has been parked in direct sunlight during hot weather, open the windows for a short time to let the hot air inside the vehicle escape.
- To help reduce moisture inside the windows on rainy or humid days, decrease the humidity inside the vehicle by operating the air conditioning system.
- During A/C system operation, you may occasionally notice a slight change in vehicle speed as the air conditioning compressor cycles.
- To ensure maximum system performance, the A/C system should be run for a few minutes each month.
- When using the A/C system, you may notice clear water dripping (or even

puddling) on the ground under the passenger side of the vehicle. This is a normal characteristic of system operation.

- Operating the A/C system in the recirculated air position provides maximum cooling; however, continual operation in this mode may cause the air inside the vehicle to become stale.
- During cooling operation, you may occasionally notice a misty air flow because of rapid cooling and humid air intake. This is a normal characteristic of system operation.

Climate control air filter

The climate control air filter removes dust and other pollutants that enter the vehicle from the outside. If dust or other pollutants accumulate in the filter over time, the airflow from the air vents may decrease. This leads to moisture accumulating on the inside of the windshield even when the fresh air intake mode is selected.

At this time, replace the climate control filter. If you find it challenging to do so yourself, have the climate control filter replaced by an authorized Kia dealer. For details on how to replace the climate control air filter, refer to "Climate control air filter" on page 9-24.

⚠ CAUTION

Replace the climate control air filter according to the Maintenance Schedule. Failure to replace the climate control air filter on a regular basis can result in decreased airflow, diminished heating and cooling performance, and unpleasant odors.

*** NOTICE**

If the airflow from the air vents suddenly decreases, have your vehicle checked by an authorized Kia dealer.

Air conditioning refrigerant label

Example



* The A/C refrigerant label in the vehicle may differ from the illustration.

Each symbol and specification on the A/C refrigerant label is represented below:

- 1 Caution
- 2 Classification of refrigerant
- 3 Classification of Compressor lubricant
- 4 Flammable Refrigerant
- 5 Registered technician to service Air Conditioning system
- 6 Amount of refrigerant

You can find out which air conditioning refrigerant applied to your vehicle on the label inside the engine compartment.

Refer to "Refrigerant label" on page 10-9 for more detail on the location of air conditioning refrigerant label.

Checking the amount of air conditioner refrigerant and compressor lubricant

When the amount of refrigerant is low, the performance of the air conditioning is reduced. Overfilling also has a negative impact on the air conditioning system.

If abnormal operation occurs, have the system inspected by an authorized Kia dealer.

⚠ WARNING

The oil and refrigerant in your vehicle's air conditioning system are under very high pressure. If proper service procedures are not followed, an explosion may result. To reduce the risk of serious injury or death, the air conditioning system in your vehicle should only be serviced by trained and certified Kia technicians.

⚠ CAUTION

It is important that the correct type and amount of oil and refrigerant is used. Otherwise, damage to the vehicle may occur. To prevent damage, the air conditioning system in your vehicle should only be serviced by trained and certified Kia technicians.

⚠ WARNING

Vehicles equipped with R-1234yf



Since the refrigerant is mildly flammable and operated at high pressure, the air conditioning system should only be serviced by trained and certified Kia technicians. (Refer to the SAE J2845)

It is important that the correct type and amount of oil and refrigerant are used. All refrigerants should be reclaimed with proper equipment. Venting refrigerants directly into the atmosphere is harmful to individuals and the environment. Failure to heed these warnings can lead to serious injuries.



Automatic climate control system

The automatic climate control system uses cooling and heating to help maintain a pleasant environment inside the vehicle.

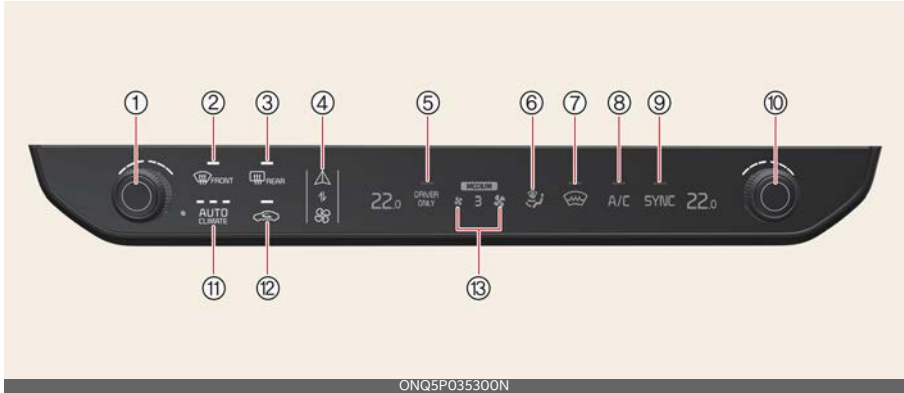

- 1 Driver's temperature control knob
- 2 Front windshield defroster icon
- 3 Rear window defroster icon
- 4 Infotainment/climate control mode switching icon
- 5 Driver's side only icon
- 6 Mode selection icon
- 7 Front glass heater icon (if equipped)
- 8 Air conditioning (A/C) icon
- 9 SYNC icon
- 10 Passenger's temperature control knob
- 11 AUTO (automatic control) icon
- 12 Air intake control icon
- 13 Fan speed control icon

* NOTICE

Operating the blower without the engine running could drain the battery. Operate the blower only when the engine is running.

Using the infotainment/climate switchable controller control panel



Press the button on the switchable controller to switch between infotainment system or climate control panel. Press and hold the button to select the default mode for the control panel.

Switching between panels

Infotainment control panel



Climate control panel



Press the button on the switchable controller to select the desired control panel. The selected control panel icon will appear, and the control panel will be changed.

- The knob display will appear according to the selected control panel mode.

- When the vehicle is in the ACC position, only the infotainment system will be activated.

Setting the default mode



Press and hold the button to select the default mode for the control panel.

- After the setting, the control panel will return to the default mode after a certain period even if the control panel is switched to the different mode.
- If the mode is set to 'OFF', the control panel will display the mode used recently.

Heating and air conditioning automatically

1. Press the AUTO button.

The modes, fan speeds, air intake and air-conditioning will be controlled automatically by setting the temperature.



You can control the air flow in three stages by pushing the AUTO button during automatic operation.

Level	Indicator	LCD Display	Air flow
High			2-8
Medium			1-6
Low			1-4

- HIGH: Provide rapid air conditioning and heating with strong air flow
- MEDIUM: Provide air conditioning and heating with medium strength air flow.
- LOW: It is suitable for drivers who prefer soft air flow. When you select the temperature to HI or LO in AUTO mode, the air flow strength is automatically set to 'HIGH'.

2. Set the temperature control switch to the desired temperature.



The climate control system is automatically controlled according to the desired temperature.

- To turn the automatic operation off, select any of the following buttons or switches:
 - Mode selection button
 - Air conditioning (A/C) button
 - Front windshield defroster button (Press the button one more time to deselect the front windshield defroster function. The 'AUTO' sign

will appear on the information display once again.)

- Fan speed control switch
The selected function will be controlled manually while other functions operate automatically.
- For your convenience and to improve the effectiveness of the climate control, use the AUTO button and set the temperature to 72 °F (22 °C).

*** NOTICE**

Do not place anything over the sensor located on the instrument panel to ensure better control of the heating and cooling system.



Heating and air conditioning manually

The heating and cooling system can be controlled manually by pressing buttons other than the AUTO button.



ONQ5A035300

In this case, the system works sequentially according to the order of buttons selected.

1. Start the vehicle.
2. Set the mode to the desired position.
For improving the effectiveness of heating and cooling;
 - Heating:
 - Cooling:
3. Set the temperature control to the desired position.
4. Set the air intake control to the outside (fresh) air position.
5. Set the fan speed control to the desired speed.

If air conditioning is desired, turn the air conditioning system on.

Press the AUTO button in order to convert to fully automatic control of the system.

Mode selection

The mode selection button controls the direction of the air flow through the ventilation system.



The air flow outlet ports are switched in the following sequence:



Face-Level (2, 3, 6)

Air flow is directed toward the upper body and face. Additionally, each outlet can be controlled to direct the air discharged from the outlet.

Bi-Level (2, 3, 4, 5, 6)

Air flow is directed towards the face and the floor.

Floor-Level (1, 2, 4, 5, 6)

Most of the air flow is directed to the floor, with a small amount of the air being directed to the windshield, side window defrosters and side air vents.

Floor/Defrost-Level (1, 2, 4, 5, 6)

Most of the air flow is directed to the floor and the windshield with a small amount directed to the side window defrosters and side air vents.

Defrost-Level (1, 2)

Most of the air flow is directed to the windshield with a small amount of air directed to the side window defrosters and side air vents.

Controlling the vents

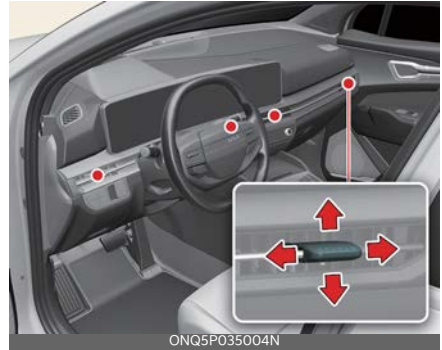

You can adjust the direction of air delivery from these vents using the vent control lever as shown.

To close the vent, push the air vent lever in the opposite direction of the passenger.

To open the vent, push the air vent lever in the same direction as the passenger.

Temperature control



The temperature will increase to the maximum (Hi) by turning the knob all the way to the right.

The temperature will decrease to the minimum (Lo) by turning the knob all the way to the left.

When turning the knob, the temperature will increase or decrease by 1 °F (0.5 °C in Celsius). When set to the lowest temperature setting, the air conditioning will operate continuously.

*** NOTICE**

When starting the vehicle in cold weather using manual temperature control, operate the system in the following method to improve heating.

- Turn off or lower the blower, right after starting the engine.
- Allow the engine to warm up during this time since the air flow from the heater is still cold.
- After a few minutes of engine warming up, turn on or set the fan to a higher level and adjust the temperature setting to hot.

Adjusting the driver and passenger side temperature equally



1. Press the "SYNC" button to adjust the driver and passenger side temperature equally.
The passenger side temperature will be set to the same temperature as the driver side temperature.
2. Turn the driver side temperature control knob. The driver and passenger side temperature will be adjusted equally.
3. If you rotate the passenger's temperature control knob, the SYNC button is turned off and the passenger side temperature can be operated individually.

Adjusting the driver and passenger side temperature individually

Press the "SYNC" button again to adjust the driver and passenger side temperature individually. The button indicator will turn off.

Changing temperature scale

- Go to **Setup** → **General** → **Unit** → **Temperature unit** on the infotainment system.

The display will change from Centigrade to Fahrenheit, or from Fahrenheit to Centigrade. If the battery has been discharged or disconnected, the temperature mode display will reset to Fahrenheit.

Air conditioning for driver only



Press the DRIVER ONLY button and the indicator light appears, cold air mostly blows in the direction of the driver's seat. However, some of the cold air may come out of other seats' ducts to keep indoor air pleasant.

Controlling air intake

This is used to select the outside (fresh) air position or recirculated air position.



To change the air intake control position:

- Push the desired control button.

Outside (fresh) air position

The indicator light on the button appears when the recirculated air position is selected.

With the outside (fresh) air position selected, air enters the vehicle from outside and is heated or cooled according to the function selected.

Recirculated air position

The indicator light on the button will turn off when the outside (fresh) air position is selected.

With the recirculated air position selected, air from the passenger compartment will be drawn through the heating system and heated or cooled according to the function selected.

Prolonged operation of the heater in the recirculated air position (without air conditioning selected) may cause fogging of the windshield and side windows and make the air in the passenger compartment stale.

In addition, prolonged use of the air conditioning with the recirculated air position selected will result in excessively dry air in the passenger compartment.

* NOTICE

Prolonged operation of the heater in the recirculated air position (without air conditioning selected) may cause fogging of the windshield and side windows and the air within the passenger compartment may become stale.

In addition, prolonged use of the air conditioning with the recirculated air position selected will result in excessively dry air in the passenger compartment.

⚠ WARNING

Continued climate control system operation in the recirculated air position may allow humidity to increase inside the vehicle which may fog the glass and obscure visibility.

Controlling fan speed

The fan speed can be set to the desired speed by operating the fan speed control button.

To change the fan speed:

- Press button right for higher speed, or press button left for lower speed.



To turn the fan speed control off:

- Press the front blower OFF button.

Air conditioning (A/C)



- Press the A/C button to turn the air conditioning system on (indicator light will appear).
- Press the button again to turn the air conditioning system off.

⚠ WARNING

Reduced Visibility

Continuous use of the climate control system in the recirculated air position may allow humidity to increase inside

the vehicle, which may fog the glass and obscure visibility.

⚠ WARNING

Recirculated Air

Continued use of the climate control system in the recirculated air position can cause drowsiness or sleepiness, and loss of vehicle control. Set the air intake control to the outside (fresh) air position as much as possible while driving.

⚠ WARNING

Sleeping with A/C on

Do not sleep in a vehicle with the air conditioning or heating on as this may cause serious harm or death due to a drop in the oxygen level and/or body temperature.

Turning off the front air climate control



- Press the OFF button to turn off the front and rear air climate control system.

However, you can still operate the mode and air intake buttons as long as the ENGINE START/STOP Button is in the ON position.

Windshield defrosting and defogging

When the windshield is covered with frost or moisture, the front view is blurred, you should remove the frost and moisture.

⚠ WARNING

Windshield heating

Do not use the or position during cooling operation in extremely humid weather. The difference between the temperature of the outside air and the windshield could cause the outer surface of the windshield to fog up, causing loss of visibility. In this case, set the mode selection to the position and fan speed control to the lower speed.

- For maximum defrosting, set the temperature control to the extreme right/hot position and the fan speed control to the highest speed.
- If warm air to the floor is desired while defrosting or defogging, set the mode to the floor-defrost position.
- Before driving, clear all snow and ice from the windshield, rear window, outside rearview mirrors, and all side windows.
- Clear all snow and ice from the hood and air inlet in the cowl grill to improve heater and defroster efficiency and to reduce the probability of fogging up the inside of the windshield.

Defogging inside windshield

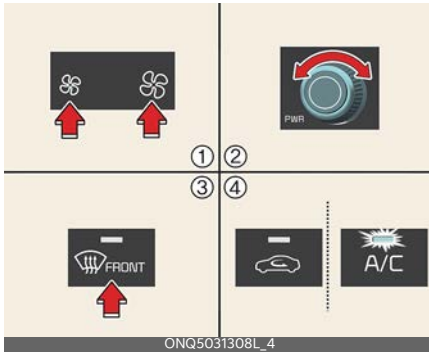

1. Set the fan speed to the desired position.
2. Select desired temperature.
3. Press the defroster button ().
4. The outside (fresh) air position will be selected automatically, and the air conditioning will turn on according to the detected ambient temperature.

If the air conditioning and outside (fresh) air position are not selected automatically, adjust the corresponding button manually. If the  position is selected, the lower fan speed is adjusted to a higher fan speed.

Defrosting outside windshield

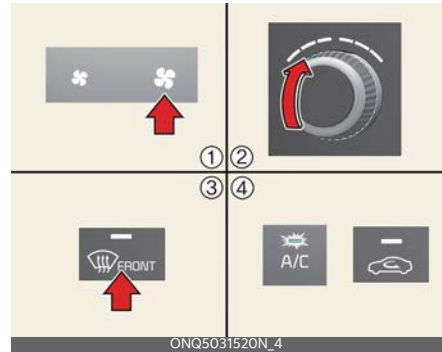

1. Set the fan speed to the highest position.
2. Set the temperature to the extreme hot (HI) position.
3. Press the defroster button ().
4. The outside (fresh) air position will be selected automatically, and the air conditioning will turn on according to the detected ambient temperature.

Auto defogging system (ADS)

Auto defogging helps reduce the possibility of fogging up the inside of the windshield by automatically sensing the moisture on inside the windshield.



 The ADS operates when the heater or air conditioning is on.

When the ADS operate, the indicator will appear.

If a high amount of humidity is detected in the vehicle, the ADS will be enabled.

The following steps will be performed automatically:

1. The A/C button will turn ON.
2. The air intake control will change to Fresh mode under low outside temperature.
3. The mode will be changed to defrost to direct airflow to the windshield.
4. The fan speed will be increased.

To cancel or reset the ADS

Press the front windshield defroster button for 3 seconds when the ENGINE START/STOP Button is in the ON position.

When the ADS is canceled, the defrost button indicator will blink 3 times.

When the ADS is reset, the defrost button indicator will blink 6 times without a signal.

*** NOTICE**

- When the air conditioning is turned on by ADS, if you try to turn off the air conditioning, the indicator will blink 3 times and the air conditioning will not be turned off.
- To maintain the effectiveness and efficiency of the ADS, do not select Recirculation mode while the system is operating.
- When the ADS is operating, the fan speed adjustment knob, the temperature adjustment knob, and the air intake control button are all disabled.

*** NOTICE**

Do not remove the sensor cover located on the upper end of the driver side windshield glass.

Damage to system parts could occur and may not be covered by your warranty.

Defroster

The vehicle is equipped with a defroster for removing frost or fog from the rear window.

⚠ CAUTION

Conductors

To prevent damage to the conductors bonded to the inside surface of the rear window, never use sharp instruments or window cleaners containing abrasives to clean the window.

If you want to defrost and defog the front windshield, refer to "Windshield defrosting and defogging" on page 5-124.

Operating rear window defroster

The defroster heats the window to remove frost, fog and thin ice from the rear window, while the engine is on.

If there is heavy accumulation of snow on the rear window, brush it off before operating the rear defroster.



To activate the rear window defroster:

- Press the rear window defroster button located in the heater control panel.

The indicator on the rear window defroster button illuminates when the defroster is ON.

The rear window defroster automatically turns off after approximately 20 minutes or when the ENGINE START/STOP button is turned off.



To turn off the defroster:

- Press the rear window defroster button again.

Outside mirror defroster (if equipped)

If your vehicle is equipped with outside mirror defrosters, they will operate at the same time you turn on the rear window defroster.

Defogging logic (if equipped)

To reduce the possibility of fogging up the inside of the windshield, the air intake or air conditioning is controlled automatically according to certain conditions such as  or  position.

To cancel automatic defogging logic or return to the automatic defogging logic, do the following.

Canceling/returning automatic defogging logic

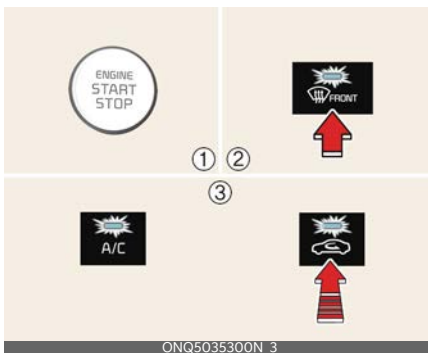

1. Turn the vehicle to the ON position.
2. Press the defroster button (.
3. While pressing the air conditioning (A/C) button, press the air intake control

button at least 5 times within 3 seconds.

The recirculation indicator blinks 3 times in 0.5 second intervals. It indicates that the defogging logic is canceled or returned to the programmed status.

If the battery has been discharged or disconnected, it resets to the defogging logic status.

Front glass heater (if equipped)

The front glass heater heats the window to remove frost, fog and thin ice from the interior and exterior of the front window, while the engine is running.



If there is heavy accumulation of snow on the front window, brush it off before operating the front glass heater.



To activate the front glass heater:

- Press the front glass heater button. The indicator on the front glass heater button illuminates when the front glass heater is ON.

The front glass heater automatically turns off after approximately 15 minutes or when the ENGINE START/STOP Button is turned off. However, if you press the button again after the heater is turned off automatically after 15 minutes, the heater will stay on only for approximately 5 minutes. To turn off the front glass heater while it is operating, press the front glass heater button again.

Storage compartments

These compartments can be used to store small items required by the driver or passengers.

- To avoid possible theft, do not leave valuables in the storage compartment.
- Always keep the storage compartment covers closed while driving. Do not attempt to place so many items in the storage compartment that the storage compartment cover cannot close securely.

WARNING

Flammable materials

Do not store glasses, gas lighters, portable batteries, canned beverages, spray cans, propane cylinders, cosmetic tubes or other flammable/explosive materials in the vehicle. These items may catch fire and/or explode if the vehicle is exposed to hot temperatures for extended periods.

Center console storage



To open the center console storage:

- Pull up the lever.

Glove box



To open the glove box:

- Pull the lever and the glove box will automatically open.

Close the glove box after use.

⚠ WARNING

Glove box

To reduce the risk of injury in an accident or sudden stop, always keep the glove box cover closed while driving.

An open glove box cover can cause serious injury to the passenger in an accident, even if the passenger is wearing a seat belt.

⚠ CAUTION

Do not keep food in the glove box for a long time.

*** NOTICE**

If the temperature control switch is in the warm or hot position, warm or hot air will flow into the glove box.

Interior features

There are various features inside the vehicle for the convenience of the occupants.

Ambient lights (if equipped)



The ambient lights are applied to the front crash pad and the center console. When the headlamp light is on, the ambient light is on at the same time could be set in the infotainment menu.

Refer to the infotainment manual for details.

Cup holder



Cups or small beverage cans may be placed in the cup holders.

⚠ WARNING

Hot liquids

Do not place uncovered cups with hot liquid in the cup holder while the vehicle is in motion. If the hot liquid spills, you may burn yourself. Such a burn to the

driver could lead to loss of control of the vehicle.

⚠ WARNING

Keep cans or bottles out of direct sunlight and do not put them in a hot vehicle. They could explode.

⚠ CAUTION

- Keep your drinks sealed while driving to prevent spillage. If liquid spills, it may get into the vehicle's electrical/electronic system and damage electrical/electronic parts.
- When cleaning spilled liquids, do not use heat to dry the cup holders. This may damage the cup holder.

Seat warmer (if equipped)

The seat warmer is provided to warm the front seats during cold weather.

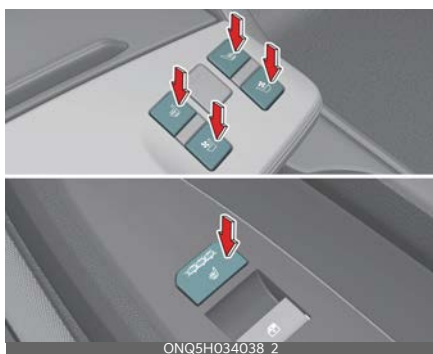

With the ENGINE START/STOP Button in the ON position:

- Push either of the buttons to warm the front and rear seats.

During mild weather or under conditions where the operation of the seat warmer is not needed, keep the buttons in the "OFF" position.

The seat warmer defaults to the OFF position whenever the ENGINE START/STOP button is turned on.

Temperature control (Manual)

- Each time you press the buttons, the temperature setting of the seat will change as follows:
 - Front seat

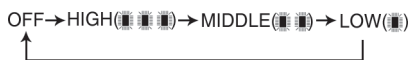

- Rear seat



Temperature control (Automatic)

The seat warmer starts to automatically control the seat temperature in order to prevent low temperature burns after being manually turned ON.



You may manually press the button to increase the seat temperature. However, it soon returns to automatic mode again.

- When pressing the buttons for more than 1.5 seconds with the seat warmer operating, the seat warmer will turn OFF.

*** NOTICE**

With the seat warmer buttons in the ON position, the heating system in the seat turns off or on automatically depending on the seat temperature.

CAUTION

- When cleaning the seats, do not use organic solvents such as paint thinner, benzene, alcohol and gasoline. It may damage the surface of the heater or seats.
- To prevent overheating the seat warmer, do not place anything on the seats that insulates against heat, such as blankets, cushions or seat covers while the seat warmer is in operation.
- Do not place heavy or sharp objects on seats equipped with seat warmers. Damage to the seat warming components could occur.
- Do not change the seat cover. It may damage the seat warmer or air ventilation system.

WARNING**Seat warmer burns**

Passengers should use extreme caution when using seat warmers due to the possibility of excess heating or burns. The seat warmer may cause burns even at low temperatures, especially if used for long periods of time. In particular, the driver must exercise extreme care for the following types of passengers:

1. Infants, children, elderly or disabled persons, or hospital outpatients
2. Persons with sensitive skin, those unable to detect heat or pain in parts of the body that are next to the heaters, or those that burn easily
3. Fatigued individuals
4. Intoxicated individuals
5. Individuals taking medication that can cause drowsiness or sleepiness (sleeping pills, cold tablets, etc.)

Air ventilation seat (if equipped)

The temperature setting of the seat changes according to the buttons position.

- To ventilate front seats cushion, push the buttons.

Each time you push the buttons, the airflow will change as follows:

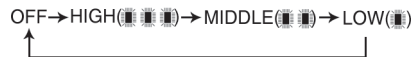

The air ventilation seat defaults to the OFF position whenever the ENGINE START/STOP button is turned on.

CAUTION**Seat damage**

- When cleaning the seats, do not use organic solvent such as paint thinner, benzene, alcohol and gasoline. It may damage the air ventilation seat.
- Do not place heavy or sharp objects on the seat. They may damage the air ventilation seat.
- Be careful not to spill liquid on the seat. If you spill liquid, wipe the seat with a dry towel. Before using the air ventilation seat, dry the seat completely.

Sun visor

Use the sun visor to shield direct light through the front or side windows.

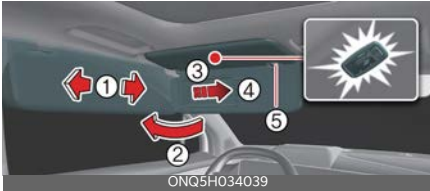

The actual sun visor lamp in the vehicle may differ from the illustration.

- To use the sun visor, pull it downward.
- To use the sun visor for the side window, pull it downward, unsnap it from the bracket (5) and swing it to the side (2).
- To use the vanity mirror, pull down the visor and slide the mirror cover (3). Adjust the sun visor extension forward or backward (1). The ticket holder (4, if equipped) is provided for holding a tollgate ticket.

⚠ WARNING

Do not block your view when using the sun visor.

*** NOTICE**

Do not put several tickets in the ticket holder at one time. This could cause damage to the ticket holder.

USB charger (if equipped)

The USB car charger allows drivers to charge their digital devices such as smartphones, and PC tablets.



Plug the cable into the USB port, and charging will begin.

The USB car charger is available with either the ACC on or the ignition on. Connect the USB port and digital devices with the engine running. Check the display screen of the device to check its charging process completion. Your smartphone or tablets could get hot while charging. This is no reason to worry, as it doesn't impact the life or functions of the device. For safety, charging can be stopped if the battery gets too high where the temperature can negatively affect the device. Charging some digital devices is not available or requires some special dedicated adapters if their charging methods don't fit in the USB car charger.

Power Delivery 3.0 is available on a smartphone or tablet equipped with fast charging capabilities. It is applicable to digital devices with USB C-type.

Charging speed is determined according to the charging specification of the connected digital device.

Rated output:

- Rated output: 9.0 V/Max 3.0 A

⚠ CAUTION

- Use the USB car charger with the ignition on. Vehicle battery can be discharged.
- Use the official USB cable of the manufacturer of the digital device to be charged.
- Make sure that any foreign object or liquid do not contact the USB car charger. Liquid or a foreign object can damage the USB charger.
- Do not connect an electrical device that generates excessive electromagnetic noise to the USB car port. Vehicle electronic devices can be interrupted while audio or AV is on.
- If the charger is connected incorrectly, it can cause serious damage to the device. Please note that damages due to incorrect usage are not covered by your warranty.

Power outlet

The power outlet is designed to provide power for mobile phones or other devices designed to operate with vehicle electrical systems or other devices that are compatible with the power outlet and vehicle electrical system.

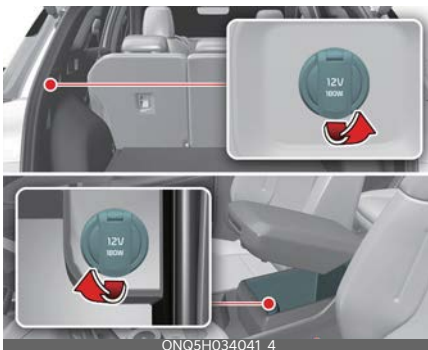

The devices should draw less than 15 amps with the vehicle on.

* NOTICE

- Use the power outlet only when the vehicle is on and remove the accessory plug after use. Using the accessory plug for prolonged periods of time with the vehicle off could cause the battery to drain.
- Only use 12 V electric accessories which are less than 15 A in electric capacity.
- Adjust the air-conditioner or heater to the lowest operating level when using the power outlet.
- Close the cover when not in use.
- Some electronic devices can cause electronic interference when plugged into a vehicle's power outlet. These devices may cause excessive audio static and malfunctions in other electronic systems or devices used in your vehicle.
- Push the plug in as far as it will go. If good contact is not made, the plug may overheat, and the fuse may open.
- Plug in battery equipped electronic devices with reverse current protection. The current from the battery may flow into the vehicle's electrical/electronic system and cause system malfunction.

⚠ WARNING

Electric shock

Do not put a finger or a foreign object (pen, etc.) into a power outlet and do not touch it with a wet hand. You may get an electric shock.

Wireless smartphone charging system (if equipped)

A wireless smartphone charging system is in the front of the center console.



1 Indicator

2 Charging pad

Firmly close all doors, and make sure to turn ON the ignition switch or press the ENGINE START/STOP button. To start wireless charging, place the smartphone equipped with wireless charging function on the wireless charging pad.

For the best wireless charging results, place the smartphone in the center of the charging pad.

The wireless charging system is designed for use with one compatible smartphone at a time. Please consult your smartphone or its manufacturer to determine if it is compatible.

⚠ WARNING

If any metallic object such as a coin is located between the wireless charging system and the smartphone, the charging may be disrupted. Metallic objects may heat up.

Wireless smartphone charging

1. Remove any object on the smartphone charging pad including the smart key. If there is any foreign object on the pad other than a smartphone, the wireless charging function may not operate properly.
2. Place the smartphone in the center of the wireless charging pad.
3. The indicator light will change to orange once the wireless charging begins. After the charging is complete, the orange light will change to green.
4. You can choose to turn the wireless charging function to either ON or OFF by selecting **Setup** → **Vehicle** → **Convenience** → **Wireless Charging System for Mobile Devices** on the infotainment system screen.

If the wireless charging does not work, gently move your smartphone around the pad until the charging indicator light turns yellow. Depending on the smartphone, the charging indicator light may not turn green even after the charging is complete.

If the wireless charging is not functioning properly, the orange light will blink and flash for ten seconds then turn off. In such cases, remove the smartphone from the pad and replace it on the pad, or double-check the charging status.

If you leave the smartphone on the charging pad when the vehicle ignition is in OFF, the vehicle will alert you through warning messages and sound (applicable for vehicles with voice guidance function) after the 'Goodbye' function on the instrument cluster ends.

For some manufacturers' smartphones, the system may not warn you even though the smartphone is left on the wireless charging unit. This is due to the particular characteristic of the smartphone and is not a malfunction of the wireless charging.

⚠ WARNING**Distracted driving**

The driver's primary responsibility is the safe and legal operation of a vehicle to protect vehicle occupants and others from serious injury or death. Driving while distracted by anything could result in a loss of vehicle control. Any use of handheld devices, vehicle systems, or other equipment that take the driver's attention away from the driving task is dangerous.

⚠ CAUTION**Liquid in wireless charging system**

To prevent liquid from damaging the wireless smartphone charging system in your vehicle, be sure not to spill liquid over the charging system.

⚠ CAUTION**Metal in wireless charging system**

If any metallic object such as a coin is located between the wireless charging system and the smartphone, the charging may be disrupted. The metallic object may heat up and potentially damage the charging system. If there is any metallic object between the smartphone and the charging pad, immediately remove the smartphone. Remove the metallic object after it has cooled down.

⚠ CAUTION

- When the interior temperature of the wireless charging system rises above a pre-set temperature, the wireless charging will cease to function. After the interior temperature drops below the threshold, the wireless charging function will resume.

- The wireless charging may not function properly when there is a heavy accessory cover on the smartphone.
- The wireless charging will stop when using the wireless smart key search function to prevent radio wave disruption.
- The wireless charging will stop when the smart key is moved out of the vehicle with the vehicle in ON.
- The wireless charging will stop when any of the doors are opened (applicable for vehicles equipped with smart keys).
- The wireless charging will stop when the vehicle is turned OFF.
- The wireless charging will stop when the smartphone is not in complete contact with the wireless charging pad.
- Items equipped with magnetic components such as a credit card, telephone card, bankbook or any transportation ticket may become damaged during wireless charging.
- Place the smartphone in the center of the charge pad for the best results. The smartphone may not charge when placed near the rim of the charging pad. When the smartphone charges, it may heat up excessively.
- For smartphones without built-in wireless charging system, an appropriate accessory must be used in order to use the vehicle's wireless charging system.
- Certain smartphones may display messages on a weak current. This is due to the particular characteristics of that smartphone and is not a malfunction of the wireless charging function.

- The indicator light of some manufacturers' smartphones may still be orange after the smartphone is fully charged. This is due to the particular characteristic of the smartphone and is not a malfunction of the wireless charging system.
- When any smartphone without a wireless charging function or a metallic object is placed on the charging pad, a noise may sound. This noise is due to the vehicle discerning compatibility of the object placed on the charging pad. It does not affect your vehicle or the smartphone in any way.
- The wireless cellular phone charging system may not support certain cellular phones, which are not verified for the Qi specification (Qi).
- When placing your smartphone on the charging pad, position the phone in the middle of the pad for maximum efficiency.
If your smartphone is off to the side, the charging speed may slow down, and in some cases, your phone may heat up.
- When charging some smartphones with a self-protection feature, the wireless charging speed may decrease, and the charging may stop.
- A smartphone that supports wireless charging can only be charged wirelessly.
- The wireless charging pad has an internal cooling system which can create noise to keep your phone cool while it charges.

* NOTICE

- When using a smartphone application (such as Android Auto) while charging, charging may be delayed or stopped. This is not a problem with the wireless charging system but is caused by the smartphone overheating. Please remove the smartphone from the charging pad.
- During wireless charging, an internal fan operates to prevent overheating. Fan noise may sound.

This device complies with part 15 of the FCC Rules

Operation is subject to the following two conditions:

1. This device may not cause harmful interference.
2. This device must accept any interference received, including interference that may cause undesired operation.

Coat hook

A coat hook is next to the rear grab handle.



* This actual feature may differ from the illustration.

⚠ CAUTION

Hanging clothing

Do not hang heavy clothes, since they may damage the hook.

WARNING

Do not hang other objects such as hangers or hard objects except clothes. Do not put heavy, sharp or breakable objects in the clothing pockets. In an accident or when the curtain air bag is inflated, it may cause vehicle damage or injury.

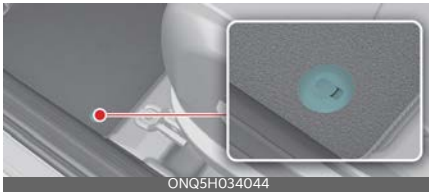
**Floor mat anchors**

When using a floor mat on the front floor carpet, make sure it attaches to the floor mat anchors in your vehicle. This keeps the floor mat from sliding forward.

WARNING**• Aftermarket floor mat**

Do not install aftermarket floor mats that are not capable of being securely attached to the vehicle's floor mat anchors.

Unsecured floor mats can interfere with pedal operation.

- Use floor mats that are not too thick and designed to be properly secured on the floor to avoid interference with pedals. Make sure to remove the plastic film before installing the floor mats. It may damage or break floor mat fix

rings, resulting in unsecured mats. For a driver, the unsecured mat may cause unintended acceleration/brake. Ensure to remove all the plastic film on the carpets before installing the mats.

The following must be observed when installing ANY floor mat in the vehicle.

- Ensure that the floor mats are securely attached to the vehicle's floor mat anchor(s) before driving the vehicle.
- Do not use ANY floor mat that cannot be firmly attached to the vehicle's floor mat anchors.
- Do not stack floor mats on top of one another (e.g., an all-weather rubber mat on top of a carpeted floor mat). Only a single floor mat should be installed in each position.

Luggage cover

- If a temporary tire or full-size tire is equipped in the luggage compartment, you can place the reflector triangle in the luggage compartment.
- If the Tire Mobility Kit (TMK) is equipped in the luggage compartment, a first aid kit, tools, etc. can be placed in the compartment for easy access.



1. Grasp the handle on the top of the cover and lift it (1).
2. Fold the rear part of luggage board frontward.
3. Lift the cover frontward.

Luggage net holder

To keep items from shifting in the cargo area, you can use the 4 holders located in the cargo area to attach the luggage net (if equipped), or you can fold the luggage net in half and attach it by using the additional 2 holders located on each side.

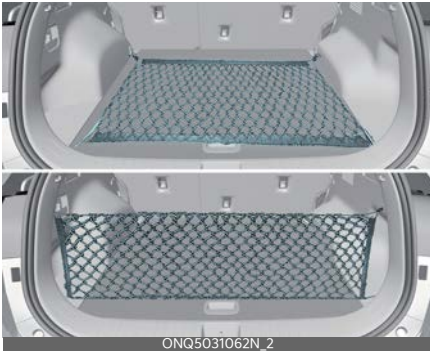

To purchase luggage nets, contact an authorized Kia dealer.

⚠ CAUTION

To prevent damage to personal items or the vehicle, be careful when placing fragile or bulky objects in the luggage compartment.

⚠ WARNING

DO NOT over-stretch the luggage net and ALWAYS keep your face and body out of the luggage net's recoil path. Failure to comply with these instructions may result in severe facial injuries. DO NOT use the luggage net when the strap has visible signs of wear or damage.

Cargo security screen (if equipped)

Use the cargo security screen to hide items stored in the cargo area.

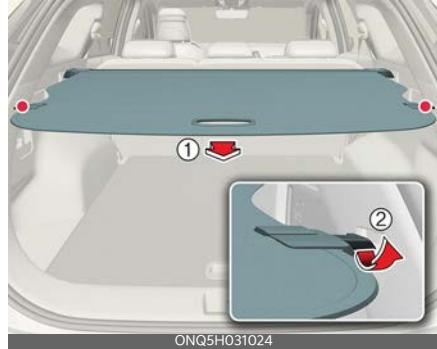

- 1 Cargo security screen handle
- 2 Cargo security screen guide

To use the cargo security screen, pull the handle backward and insert the edges into the slots.



Follow these steps to remove the security screen.

1. Push the guide pin in the direction shown.
2. Pull the cargo security screen out.
3. Open the luggage cover (1) and side tray cover (2) and keep the cargo security screen in the tray (3) (if gasoline engine and temporary spare tire are equipped in the luggage compartment).

⚠ WARNING

- Do not place objects on the cargo security screen. Such objects may move around inside the vehicle and possibly injure vehicle occupants during an accident or when braking.
- Never allow anyone to ride in the luggage compartment. It is designed for luggage only.
- Maintain the balance of the vehicle and locate weight as forward as possible.

* NOTICE

- Do not put luggage on the cargo security as it may be damaged.
- Pull out the cargo security screen using the handle in the center to prevent the guide pin from falling out of the guide.
- The cargo security screen may not automatically slide back if the cargo security screen is not fully pulled out. Fully pull it out and then let go.

Exterior features

Roof rack (if equipped)

If your vehicle has a roof rack, you can load cargo and accessories (e.g., cargo carrier, roof tent) on top of your vehicle.

Type A



Type B



* The actual shape may differ from the illustration.

Cargo and accessories can be attached directly to the roof rack or to Kia cross members (available from an authorized Kia dealer).

* NOTICE

- The crossbars (if equipped) should be placed in the proper load carrying positions prior to placing items onto the roof rack.
- When the roof rack is not being used to carry cargo, the crossbars may need to be repositioned if wind noise is detected.

⚠ CAUTION

- When carrying cargo on the roof rack, make sure the cargo does not damage the roof of the vehicle.
- When carrying large objects on the roof rack, make sure they do not

exceed the overall roof length or width.

- If the vehicle is equipped with a sunroof, ensure that cargo loaded onto the roof rack does not interfere with sunroof operation.
- When carrying cargo on the roof rack, do not operate the sunroof. (if equipped)
- Never place load directly on the sunroof or the roof panels. They are not designed to carry loads and may break. Never let anything interfere with the movement of the sunroof.
- Do not operate the sunroof when carrying cargo or roof accessories.

Load limits

The Kia roof rack can support up to 880 lbs. (400 kg.), evenly distributed (i.e., side to side and front to back), but only when the vehicle is parked.

Never drive the vehicle with more than 220 lbs. (100 kg) of cargo and accessories on the roof racks.

The maximum load limits may vary depending on accessories attached. Check the accessory label before loading cargo on the accessory.

Never allow the combined weight of occupants and cargo to exceed the Gross Vehicle Weight Rating (GVWR) of your vehicle.

WARNING

- Never drive your vehicle when combined weight of occupants and cargo exceeds GVWR. That can cause loss of control and an accident.
- Never drive your vehicle with more than 220 lbs. (100 kg) of cargo on the

roof rack. Heavier loads may result in loss of control and rollover.

- The maximum load limits may vary depending on accessories attached. Check the accessory label before loading cargo on the accessory.
- Loads on the roof rack raise your vehicle's center of gravity and may change the ways in which your vehicle handles. Avoid sudden starts and braking, sharp turns, abrupt maneuvers, and high speeds that may result in loss of control or rollover.
- Always drive slowly and turn corners carefully when carrying items on the roof rack. Severe wind updrafts, caused by passing vehicles or natural causes, can cause sudden upward pressure on items loaded on the roof rack. This is especially true when carrying large, flat items such as wood panels or mattresses. This could cause the items to fall off the roof rack and cause damage to your vehicle or others around you.
- Failure to heed these warnings may lead to serious injury and death.

CAUTION

- Overloading the roof racks may also damage them.
- Overloading the vehicle may also damage the vehicle.

Securing items to the roof rack

Plan carefully before attempting to put cargo and accessories on the roof racks. Be sure the items can be secured and that you have the equipment to do so. Get help from those close to you whenever appropriate.

Be sure that the cargo and accessories will not extend too far forward, rearward, or sideways.

Do not allow anything to obscure the view out the windshield or the front view camera. Do not allow anything to obscure the High Mounted Stop Lamp.

Obey applicable laws regarding flags and signals on cargo extending beyond the rear of your vehicle.

Be careful to account for the effects that wind may have on the cargo and accessories while moving. Flexible cargo, such as a mattress, can bend under wind loads. Wind effects from driving, passing vehicles, or natural causes can cause sudden upward or downward pressure, resulting in damage to the items, damage to the cross members or roof rack, damage to attachments, loss of visibility, distraction, and loss of control.

Park your vehicle on solid, level ground, place it in P (Park) and set the parking brake before loading and securing items.

If your cargo is covered, be sure that the cover is secure and will not blow off or distract the driver.

Check the security of the attachments after driving for a short distance, and from time to time during your journey.

Securing accessories

Before installing an accessory such as a cargo carrier or roof tent, make sure that the item is compatible with your Kia's roof racks.

Check the accessory manufacturer's manual and online information. Do not attempt to connect an accessory that the manufacturer deems incompatible.

Contact the manufacturer or your Kia dealer if you need additional information.

Follow the accessory manufacturer's instructions, warnings, and cautions in addition to those above.

Roof tents

In addition, when using a roof tent:

- Be sure that the weight of occupants does not exceed the load capacity of the roof racks.
- Confirm the roof tent is securely fastened to the crossbars and roof rails before using it.
- Never move the vehicle with occupants in a roof tent.
- Never leave the engine running with occupants in a roof tent. Never run an internal combustion engine (such as a generator), gas stove, gas lantern, or other device that burns fuel near an occupied roof tent or awning. Those emit carbon monoxide, which is colorless, odorless, and deadly.
- Follow the roof tent manufacturer's instructions, warnings, and cautions.

WARNING

Failure to follow the instructions, warnings and cautions above, and those of the accessory manufacturer, could result in damage to your vehicle, to your cargo, and to other road users. It could also result in an accident and in serious injury and death.

Infotainment system

* NOTICE

- If you install an aftermarket HID head lamp, your vehicle's audio and electronic device may malfunction.
- When attaching metallic tinted paper to the glass, the communication function of the hi-pass system, radio reception function, connected car service, and automatic headlight turn-on function may not work normally. Also, be careful as the solution used in the construction of the tinted paper may permeate the inside of the vehicle, which may cause the electronic device to fail.

Over-The-Air software update (if equipped)

The Over-The-Air software update feature allows you to wirelessly update software to the latest version. Using this feature, you can keep your vehicle system up to date with the latest software.

Downloading software

The latest software can be downloaded automatically while driving. After the latest software has been successfully downloaded, you will receive a notification on your phone or the vehicle screen that the software update and ready to install.

Approving software update



1 Update Now

2 Later

After the vehicle is turned off, the vehicle system will allow you to start the update.

- To start the update, press **Update Now** (1).
- To postpone the update, press **Later** (2).

Preparing software update



1 Update Now

2 Cancel Update

If you press the Start button on the screen, the vehicle will begin installing the update automatically. The following conditions must be satisfied:

- The vehicle must be off.
- The gear must be in P (Park).
- The Electronic Parking Brake (EPB) must be applied.
- The exterior lights must be turned off.
- The hood must be closed.
- The battery must be sufficient.
- The systems to be updated must not be running.
- To update immediately, press **Update Now**.
- To cancel the update, press **Cancel Update**.

* INFORMATION

The battery and system status are automatically checked by the vehicle.

Updating software



1 Details

2 Close

You can see the progress of the update on the screen.

After the update is complete, you will receive a notification on your phone or the vehicle screen that the software update is complete.

* INFORMATION

- The screen turns off automatically after 3 minutes to save the battery. If the screen turns off automatically, you can check the update progress by pressing the ENGINE START/STOP button.
- After the update starts, you can exit the vehicle.
- The OTA software update feature is only available for Kia Connect service users.
- The update details may vary depending on the installed software version.
- Check the notice for the OTA software update on the Kia brand web.
- If the update fails, the update recovery will automatically proceed. If you want to retry the software update, even after a successful recovery, contact an authorized Kia call center.
- If the update or recovery fails, we recommended contact an authorized Kia dealer.

- After the update is complete, it may provide new functions or improvements. For more information, refer to Kia website or scan the QR code on the infotainment screen.

* NOTICE

- Observe the following restrictions during the update.
 - You cannot use the vehicle during the update. Be sure to have enough time for the update, and safely park the vehicle before starting the update process.
 - You cannot use remote features, including remote start.
 - The vehicle cannot be charged. Charge your vehicle after completing the update.
 - The Rear Occupant Alert may not work. Check if there are any occupants in the rear seat after the update starts.
 - If the digital key function is included in the update history, the door lock/unlock function through digital key or fingerprint authentication may not work. Check the notice and use the smart key button to lock or unlock the door if the digital key function is updated.
- The update will be automatically canceled if any vehicle conditions required for the update are changed before starting the update.
- Once the update has started, you cannot cancel the update.
- You cannot use the Over-The-Air software update feature if you modify or replace any vehicle software.

- Do not open the hood or replace the battery in the vehicle during the update. The update may fail.
- Note that the high-voltage-related module for charging the 12 V battery may be activated during the software update.
- If a diagnostic tool of any kind is connected to the vehicle OBD (On-board Diagnostic) terminal, the vehicle cannot be updated. The vehicle can be updated by removing the diagnostic tool connected to the OBD terminal and then restarting the vehicle.
- If the update is not complete successfully, contact Kia.
- Vehicle reception must be identified to safely install any downloaded software.
- Vehicle signal strength must be strong (above -82 dBm) to safely install any downloaded software.

Using the infotainment/climate switchable controller

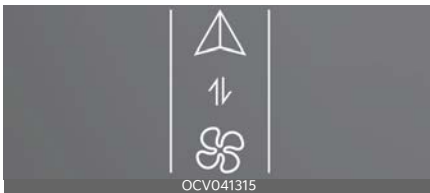

Press the button on the switchable controller to switch between infotainment system or climate control panel.

Press and hold the button to select the default mode for the control panel.

Switching between panels

Infotainment control panel



Climate control panel



Press the button on the switchable controller to select the desired control panel. The selected control panel icon will appear, and the control panel will be changed.

- The knob display will appear according to the selected control panel mode.
- When the vehicle is in the ACC position, only the infotainment system will be activated.

Setting the default mode



Press and hold the button to select the default mode for the control panel.

- After the setting, the control panel will return to the default mode after a cer-

tain period even if the control panel is switched to the different mode.

- If the mode is set to 'OFF', the control panel will display the mode used recently.

For Telematics button function



- 1 Kia Connect button
- 2 Roadside assist button

Audio system

* NOTICE

If you install an aftermarket HID head-lamp, your vehicle's audio and electronic device may malfunction.

- * If your vehicle is equipped with Infotainment system, refer to a separately supplied manual for detailed information.

Shark-fin antenna

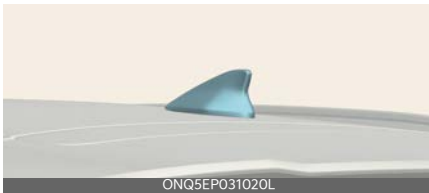

Shark-fin antenna transmit and receive signals such as AM/FM and GPS. Additional signals are sent and received according to vehicle options.

* NOTICE

- Be careful of antenna damage by checking the height of the vehicle before entering low-ceiling spaces such as automated parking lots or automated washing machines.
- Be careful not to contact the antenna when loading cargo on the roof rack. Antenna transmission/reception performance may be degraded.

USB port

You can use the USB port to plug in a USB.



⚠ CAUTION

Depending on the size, length, or shape of the USB stick, if you forcibly close the tray cover, the USB device may be damaged, deformed or the cover may not reopen.

When the USB device is stuck, forcibly opening the cover can also cause damage to the device.

If the USB stick does not fit, do not close the cover. Try another USB stick with different specifications.

AI Assistant



AI Assistant can be operated using voice recognition.

Operation

Press the **AI Assistant** button or say "Hey, Kia."

- Example (Vehicle control)
 - "Turn on the air conditioner."
 - "Turn off the air conditioner."
- Example (Question)
 - "Can you explain why the ocean is blue in a way that a 7-year-old can understand?"

* NOTICE

- AI assistants may provide inaccurate answers. Please check important details separately.
- AI assistant may not support certain languages or regions.

How vehicle radio works

FM reception

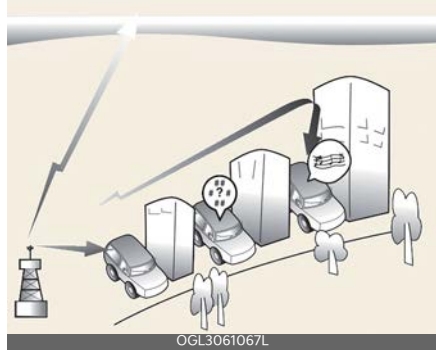

AM and FM radio signals are broadcast from transmitter towers located around your city. They are intercepted by the radio antenna on your vehicle. This signal is then processed by the radio and sent to your vehicle speakers.

However, in some cases the signal coming to your vehicle may not be strong and clear.

This can be due to factors such as the distance from the radio station, closeness of other strong radio stations or the presence of buildings, bridges or other large obstructions in the area.

AM reception

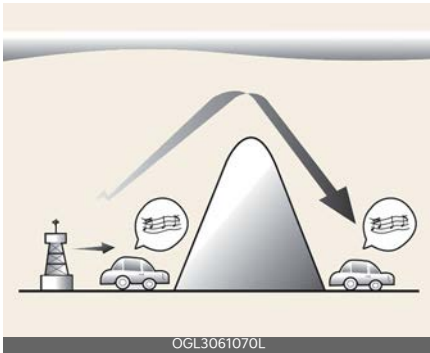

AM broadcasts can be received at greater distances than FM broadcasts. This is because AM radio waves are transmitted at low frequencies. These long-distance, low-frequency radio waves can follow the curvature of the earth rather than traveling straight. In addition, they curve around obstructions resulting in better signal coverage.

FM radio station

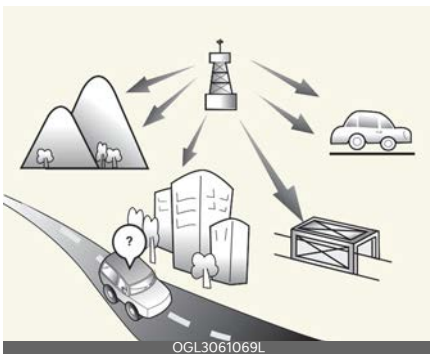

FM broadcasts are transmitted at high frequencies and do not bend to follow the earth's surface. Because of this, FM broadcasts generally begin to fade within short distances from the station. Also, FM signals are easily affected by buildings, mountains, and obstructions.

This can lead to undesirable or unpleasant listening conditions which might lead you to believe a problem exists with your radio.

The following conditions are normal and do not indicate radio trouble:

- **Fading** - As your vehicle moves away from the radio station, the signal will weaken, and sound will begin to fade. When this occurs, we suggest that you select another station with a stronger signal.

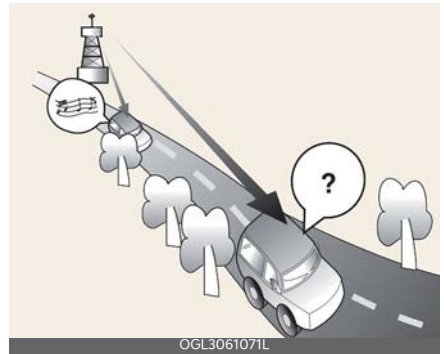

- **Flutter/Static** - Weak FM signals or large obstructions between the transmitter and your radio can disturb the signal causing static or fluttering noises to occur. Reducing the treble level may lessen this effect until the disturbance clears.

- **Station Swapping** - As an FM signal weakens, another more powerful signal near the same frequency may begin to play. This is because your radio is designed to lock onto the clearest signal. If this occurs, select another station with a stronger signal.

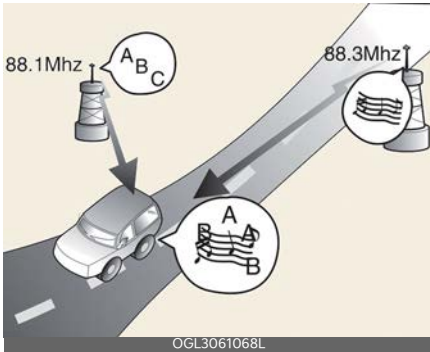

- **Multi-Path Cancellation** - Radio signals being received from several directions can cause distortion or fluttering. This can be caused by a direct and reflected signal from the same station, or by signals from two stations with close frequencies. If this occurs, select another station until the condition has passed.

Using a mobile phone or a two-way radio

When a mobile phone is used inside the vehicle, noise may be produced from the audio system. This does not mean that something is wrong with the audio equipment. In such a case, try to operate mobile devices as far from the audio equipment as possible.

When using a communication system such as a mobile phone or a radio set inside the vehicle, a separate external antenna must be used. When a mobile phone or a radio set is used with only the

internal antenna, it may interfere with the vehicle's electrical system and adversely affect the safe operation of the vehicle.

⚠ WARNING

Cellular phone use

Do not use a cellular phone while driving. Stop at a safe location to use a cellular phone.

⚠ WARNING

Distracted driving

Driving while distracted can result in a loss of vehicle control that may lead to an accident, severe bodily injury, or death. The driver's primary responsibility is in the safe and legal operation of a vehicle. Any use of handheld devices, other equipment, or vehicle systems that take the driver's eyes, attention, and focus away from the safe operation of a vehicle are not permissible by law. These should never be used during the operation of the vehicle.

Declaration of Conformity

FCC

This equipment has been tested and found to comply with the limits for a Class B digital device, pursuant to part 15 of the FCC Rules. These limits are designed to provide reasonable protection against harmful interference in a residential installation.

This equipment generates, uses and can radiate radio frequency energy and, if not installed and used in accordance with the instructions, may cause harmful interference to radio communications. However, there is no guarantee that interference will not occur in a particular installation. If this equipment does cause harmful interference to radio or television reception, which can be determined by turning the equipment off and on, the user is encouraged to try to correct the interference by one or more of the following measures:

- Reorient or relocate the receiving antenna.
- Increase the separation between the equipment and receiver.
- Connect the equipment into an outlet on a circuit different from that to which the receiver is connected.
- Consult the dealer or an experienced radio/TV technician for help.

CAUTION

Any changes or modifications to this device that are not explicitly approved by the manufacturer could void your authority to operate this equipment.

This device complies with part 15 of the FCC Rules. Operation is subject to the following two conditions:

1. This device may not cause harmful interference.
2. This device must accept any interference received, including interference that may cause undesired operation.

This equipment complies with FCC radiation exposure limits set forth for an uncontrolled environment.

This equipment should be installed and operated with a minimum of minimum 8 in (20 cm) between the radiator and your body. This transmitter must not be collocated or operating in conjunction with any other antenna or transmitter unless authorized to do so by the FCC.

Be sure the exhaust system does not leak.....	6-4
Before driving	6-4
ENGINE START/STOP button.....	6-6
• Illuminated ENGINE START/STOP button.....	6-6
• ENGINE START/STOP button position	6-6
• Starting the engine.....	6-7
Automatic transmission (Dial Shift By Wire (SBW)).....	6-9
• Automatic transmission operation	6-9
• Transmission position	6-9
• Good driving practices	6-13
Paddle shifter.....	6-15
• Regenerative braking mode.....	6-15
• Smart regeneration system.....	6-16
All-Wheel Drive (AWD) system.....	6-22
• AWD (AWD/TERRAIN MODE)	6-22
• For safe All-Wheel Drive (AWD) operation.....	6-25
Brake system.....	6-30
• Power brakes.....	6-30
• Electronic Parking Brake (EPB).....	6-32
• AUTO HOLD	6-36
• Anti-lock Brake System (ABS)	6-38
• Electronic Stability Control (ESC) system.....	6-39
• Downhill Brake Control (DBC)	6-41
• Hill-start Assist Control (HAC)	6-44
• Crosswind Stability Control (CSC)	6-44
• Vehicle Stability Management (VSM) system.....	6-45
• Trailer Stability Assist (TSA) system.....	6-46
• Good braking practices.....	6-46
Vehicle Auto Shut-off system.....	6-47
• Operating Conditions	6-47

6 Driving your vehicle

• Deactivating Conditions.....	6-47
• System Operation.....	6-48
Drive mode integrated control system	6-48
• Drive mode	6-48
Active air flap	6-49
• Active air flap malfunction.....	6-49
Green Zone Drive Mode.....	6-50
• Green Zone Drive Mode LCD display	6-50
• Green zone registration point	6-50
Economical operation.....	6-51
Special driving conditions	6-53
Winter driving	6-56
Trailer towing	6-60
• Hitches.....	6-61
• Safety chains.....	6-61
• Trailer brakes.....	6-62
• Driving with a trailer	6-62
• Maintenance when trailer towing	6-64
• If you decide to pull a trailer	6-65
Vehicle load limit	6-66
• Steps For Determining Correct Load Limit—.....	6-67
• Certification label	6-69
Vehicle weight.....	6-70
• Base curb weight	6-70
• Vehicle curb weight	6-70
• Cargo weight.....	6-70
• Gross axle weight (GAW).....	6-70
• Gross axle weight rating (GAWR)	6-71
• Gross vehicle weight (GVW)	6-71
• Gross vehicle weight rating (GVWR)	6-71

- Overloading 6-71

Driving your vehicle

Be sure the exhaust system does not leak.

The exhaust system should be checked whenever the vehicle is raised to change the oil or for any other purpose.

If you hear a change in the sound of the exhaust or if you drive over something that strikes the under side of the vehicle, have the exhaust system checked as soon as possible by an authorized Kia dealer.

WARNING

Engine exhaust

Do not inhale exhaust fumes or leave your engine running in an enclosed area for a prolonged time. Exhaust fumes contain carbon monoxide, a colorless and odorless gas that can cause unconsciousness and death by asphyxiation.

WARNING

Open liftgate

Do not drive with the liftgate open. Poisonous exhaust gases can enter the passenger compartment. If you must drive with the liftgate open proceed as follows:

1. Close all windows.
2. Open side vents.
3. Set the air intake control at "Fresh", the air flow control at "Floor" or "Face", and the fan at the highest speed.

Before driving

Before entering your Kia, examine it and its surroundings. After getting into the vehicle, you should check a number of things before driving.

Before entering vehicle

- Be sure that all windows, outside mirror(s), and outside lights are clean.
- Check the condition of the tires.
- Check under the vehicle for any sign of leaks.
- Be sure there are no obstacles behind you if you intend to back up.

Necessary inspections

Fluid levels such as engine oil, engine coolant, brake fluid, and washer fluid should be checked on a regular basis, at the exact interval depending on the fluid. Further details are provided in "Maintenance" on page 9-4.

WARNING

Distracted driving

Focus on the road while driving. The driver's primary responsibility is the safe and legal operation of the vehicle. Use of any hand-held devices, other equipment or vehicle systems that distract the driver should not be used during vehicle operation.

Before starting

- Close and lock all doors.
- Position the seat so that all controls are easily reached.
- Buckle your seat belt.
- Adjust the inside and outside rearview mirrors.

- Be sure that all lights work.
- Check all gauges.
- Check the operation of warning lights when the ENGINE START/STOP button is turned to the ON position.
- Release the parking brake and make sure the brake warning light is off.

For safe operation, be sure you are familiar with your Kia and its equipment.

⚠ WARNING

When you intend to park or stop the vehicle with the engine on, be careful not to depress the accelerator pedal for a long period of time. It may overheat the engine or exhaust system and cause fire.

⚠ WARNING

Check surroundings

Always check the surrounding areas near your vehicle for people, especially children, before putting a vehicle into D (Drive) or R (Reverse).

⚠ WARNING

Loose objects

Securely store items in your vehicle. When you make a sudden stop or turn the steering wheel rapidly, loose objects may drop on the floor and it could interfere with the operation of the foot pedals, possibly causing an accident.

⚠ WARNING

Driving under the influence

Do not drive while under the influence of alcohol, drugs, or other impairing substances. Drinking and driving is dangerous. Even a small amount of alcohol will

affect your reflexes, perceptions and judgment.

Driving while under the influence of drugs or other impairing substances is as dangerous as or more dangerous than driving drunk.

⚠ WARNING

Proper footwear

Always wear appropriate shoes when operating your vehicle. Unsuitable shoes (high heels, ski boots, sandals, etc.) may interfere with your ability to use the brake and accelerator pedals.

⚠ WARNING

California Proposition 65

Engine exhaust and a wide variety of automobile components and parts, including components found in the interior furnishings in a vehicle, contain or emit chemicals known to the State of California to cause cancer and birth defects and reproductive harm. In addition, certain fluid contained in vehicles and certain products of component wear contain or emit chemicals known to the State of California to cause cancer and birth defects or other reproductive harm.

ENGINE START/STOP button

Illuminated ENGINE START/STOP button



The light will turn off after about 30 seconds when the door is closed. It will also turn off immediately when the theft-alarm system is armed.

ENGINE START/STOP button position

Your vehicle is equipped with four different ignition positions.

OFF

To turn off the engine (START/RUN position) or vehicle power (ON position), press the ENGINE START/STOP button with the gear in the P (Park) position. When you press the ENGINE START/STOP button and the gear is not in the P (Park) position, the ENGINE START/STOP button will not change to the OFF position but to the ACC position.

ACC (Accessory)



Press the ENGINE START/STOP button while it is in the OFF position without depressing the brake pedal.

The electrical accessories are operational.

If the ENGINE START/STOP button is in the ACC position for more than 1 hour, the button is turned off automatically to prevent battery discharge.

ON

Press the ENGINE START/STOP button while it is in the ACC position without depressing the brake pedal.

The warning lights can be checked before the engine is started. Do not leave the ENGINE START/STOP button in the ON position for a long time. The battery may discharge because the engine is not running.

* NOTICE

If you leave the ENGINE START/STOP button in the ACC or ON position for a long time, the battery will discharge.

START/RUN

To start the engine, depress the brake pedal and press the ENGINE START/STOP button with the gear in the P (Park) or the N (Neutral) position. For your safety, start the engine with the gear in the P (Park) position.

* NOTICE

If you press the ENGINE START/STOP button without pressing the brake pedal, the engine will not start, and the ENGINE START/STOP button changes as follows:
OFF → ACC → ON → OFF or ACC

⚠ WARNING

- Never press the ENGINE START/STOP button while the vehicle is in motion.

This would result in loss of directional control and braking function, which could cause an accident.

- Before exiting, always make sure the gear is shifted to P (Park) position, set the parking brake fully and shut the engine off. Unexpected and sudden vehicle movement may occur if these precautions are not taken.
- Never reach for controls through the steering wheel while the vehicle is in motion. The presence of your hand or arm in the area could cause loss of vehicle control, an accident and serious bodily injury or death.
- Do not place any movable objects around the driver's seat as they may move while driving, interfere with the driver and lead to an accident.

Starting the engine

⚠ WARNING

- Do not start the vehicle with the accelerator pedal engaged. The vehicle can move and lead to an accident.
- Wait until the engine rpm is normal. The vehicle may suddenly move if the brake pedal is released when the rpm is high.

Starting the engine with smart key

When the doors are opened or when the ENGINE START/STOP button is pressed the vehicle will check for the smart key. If the smart key is not in the vehicle, the "P" indicator and a message "Key is not in the vehicle" will appear on the instrument cluster and LCD window. If all doors are closed, the chime will sound for 5 seconds. The indicator or warning

will turn off while the vehicle is moving. Always have the smart key with you.

⚠ WARNING

The engine will start only when the smart key is in the vehicle. Never allow children or any person who is unfamiliar with the vehicle to touch the ENGINE START/STOP button or related parts. Pushing the ENGINE START/STOP button while the smart key is in the vehicle may result in unintended engine activation and/or unintended vehicle movement.

⚠ CAUTION

If the engine stalls while the vehicle is in motion, do not attempt to move the gear to the P (Park) position. If the traffic and road conditions permit, you may put the gear in the N (Neutral) position while the vehicle is still moving and press the ENGINE START/STOP button to restart the engine.

* NOTICE

- If the battery is weak or the smart key does not work properly, you can start the engine by pressing the ENGINE START/STOP button with the smart key.

When you press the ENGINE START/STOP button directly with the smart key, the smart key should contact the button at a right angle.



- When the stop lamp fuse blows, you cannot start the engine normally. Replace the fuse with a new one. If not possible, you can start the engine by pressing the ENGINE START/STOP button for 10 seconds while it is in the ACC position. The engine can start without pressing the brake pedal. But for your safety always press the brake pedal before starting the engine.

CAUTION

- Do not press the ENGINE START/STOP button for more than 10 seconds except when the stop lamp fuse is blown.

Starting the engine

1. Carry the smart key or leave it inside the vehicle.
2. Make sure the parking brake is firmly applied.
3. Make sure the gear is shifted to P (Park) position. Depress the brake pedal fully.
4. Press the ENGINE START/STOP button.

It should be started without depressing the accelerator pedal.

5. Do not wait for the engine to warm up while the vehicle remains stationary. Start driving at moderate speeds. (Fast accelerating and decelerating should be avoided.)

Starting the gasoline engine

Operation

1. Make sure the parking brake is applied.
2. Make sure the gear is in P (Park).
3. Fully depress the brake pedal.
4. Turn the key to START position or press the ENGINE START/STOP button.

Automatic transmission (Dial Shift By Wire (SBW))

The automatic transmission has 6 forward speeds and one reverse speed. The individual speeds are selected automatically depending on the balance between the fuel economy and the power.

Automatic transmission operation

Select transmission positions by turning the shift dial SBW.



WARNING

Automatic transmission

To reduce the risk of serious injury or death:

- ALWAYS check the surrounding areas near your vehicle for people, especially children, before shifting a vehicle into D (Drive) or R (Reverse).
- Before leaving the driver's seat, always make sure the gear is in the P (Park) position, then set the parking brake, and place the ENGINE START/STOP button in the OFF position. Unexpected and sudden vehicle movement can occur if these precautions are not followed.

For your safety, always depress the brake pedal while shifting to another gear.

Transmission position

Type A

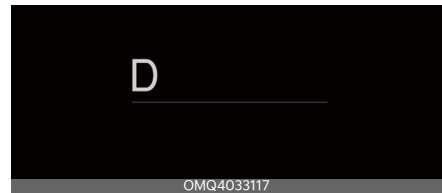

Type B

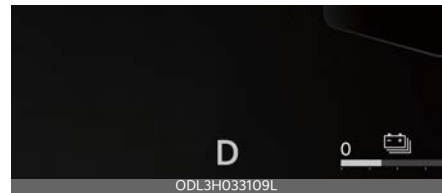

The indicator in the instrument cluster displays the transmission position when the ENGINE START/STOP button is in the ON position.

P (Park)

Always come to a complete stop before shifting into P (Park).

To shift the gear from R (Reverse), N (Neutral) or D (Drive) to P (Park), press the [P] button.

If you turn off the vehicle in D (Drive), N (Neutral) or R (Reverse), the gear automatically shifts to P (Park).

With the vehicle on, the gear automatically shifts to P (Park) if you open the driver's door when the gear is in N (Neutral), R (Reverse) or D (Drive) and the following conditions are met:

- The brake/accelerator pedal is not depressed.
- The seat belt is unfastened.
- The vehicle speed is below 1 mph (2 km/h).

When the vehicle speed is greater, the gear does not shift to P (Park) when the P (Park) button is pressed.

⚠ WARNING

- Shifting into P (Park) while the vehicle is in motion may cause you to lose control of the vehicle.
- After the vehicle has stopped, always make sure the gear is in P (Park), apply the parking brake, and turn the vehicle off.
- Do not use the P (Park) position in place of the parking brake.

R (Reverse)

Use this position to drive the vehicle backward.

To shift to R (Reverse), turn the shift dial SBW to the [R] position while depressing the brake pedal.

⚠ CAUTION

Shifting

Always come to a complete stop before shifting into or out of R (Reverse); you may damage the transmission if you shift into R (Reverse) while the vehicle is in motion, except when "Rocking the vehicle" ("Rocking the vehicle" on page 6-54).

N (Neutral)

The wheels and gear are not engaged. To shift to N (Neutral), turn the shift dial SBW to the N (Neutral) position while depressing the brake pedal. Always depress the brake pedal when you are shifting from N (Neutral) to another gear.

In N (Neutral), if the driver attempts to turn off the vehicle, the vehicle is turned OFF and shifted to the P (Park) position automatically.

Stay in N (Neutral) position when engine is Off

If you want to stay in the N (Neutral) position after the engine is OFF, do the following.



1. Deactivate the AUTO HOLD and release the parking brake when the ENGINE START/STOP button is ON.
2. Turn the shift dial SBW to the N (Neutral) position by depressing the brake pedal. If the message ("Press and hold OK button to stay in Neutral when vehicle is Off") appears on the cluster LCD display, press and hold the OK button on the steering wheel for more than 1 second. After the message disappears, the vehicle will stay the N position when the engine is off.
3. Turn off the engine after the message ("Vehicle will stay in N (Neutral). Change gear to cancel") appears on the cluster LCD display.

Unfasten the driver's seat belt and open the driver's door within 3 minutes. The

gear shifts to P (Park) position and the ENGINE START/STOP button turns off.

When the battery is discharged:

You cannot shift the shift dial SBW when the battery is discharged.

In emergencies, do the following to move the shift dial SBW to N (Neutral) on a level ground.

1. Connect battery cables from another vehicle or from another battery to the jump starting terminals inside the engine compartment. For more details, refer to "Emergency starting" on page 8-5.
2. Release the parking brake with the ENGINE START/STOP button in the ON position.
3. Shift the gear to the N (Neutral) position. If you want to stay in the N (Neutral) position after the engine is off, disconnect the battery from the vehicle or refer to "Stay in N (Neutral) position when engine is Off" on page 6-10.

CAUTION

- Always park the vehicle in "P" (Park) and engage the parking brake. If left in "N (Neutral)", the vehicle may move and cause serious damage and injury.
- After the ENGINE START/STOP button has been turned off, the Electronic Parking Brake (EPB) cannot be disengaged.
- When the engine has been turned "OFF" in a vehicle equipped with EPB and the AUTO HOLD function turned on, the EPB will be engaged automatically.

D (Drive)

This is the normal driving position.

To shift to D (Drive), move the shift dial SBW to the D (Drive) position while depressing the brake pedal.

In D (Drive), if the driver attempts to turn off the vehicle, the vehicle is turned OFF and shifted to the P (Park) position automatically.

Shift-lock system

For your safety, your vehicle has a shift-lock system which prevents shifting the gear from P (Park) or N (Neutral) into R (Reverse) or D (Drive) unless the brake pedal is depressed.

To shift from P (Park) or N (Neutral) into R (Reverse) or D (Drive), from R (Reverse) into D (Drive) or from D (Drive) into R (Reverse):

1. Depress and hold the brake pedal.
2. Start the vehicle or place the ENGINE START/STOP button in the ON position.
3. Turn the shift dial SBW to the R (Reverse) or D (Drive) position.

LCD display messages

If a message appears on the LCD display, refer to the next section for the appropriate steps to take.

Shifting conditions not met

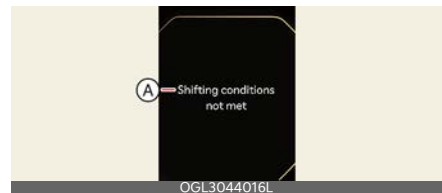

A: Shifting conditions not met

The message appears on the LCD display in the following conditions:

- When driving speed is too fast to shift the gear. Decrease the vehicle speed or slow down before shifting the gear.

Press brake pedal to change gear

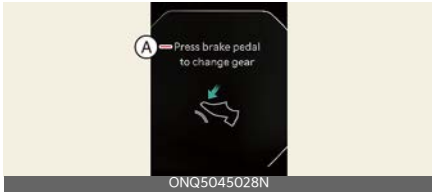

A: Press brake pedal to change gear

The message appears on the LCD display, when the brake pedal is not depressed while shifting the gear. Depress the brake pedal and then shift the gear.

PARK engaged

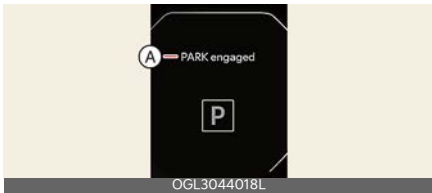

A: PARK engaged

The message appears on the LCD display when the gear is shifted to P (Park) while the vehicle is moving. Stop the vehicle before shifting to P (Park).

Shift button is stuck



A: Shift button is stuck

The message appears on the LCD display when the P (Park) is reselected, or the gear is overheated.

PARK button error! Engage parking brake when parking vehicle



A: PARK button error! Engage parking brake when parking vehicle

The message is displayed when there is a problem with function engaging P (Park) position.

Immediately have the vehicle inspected by an authorized Kia dealer.

Check P button

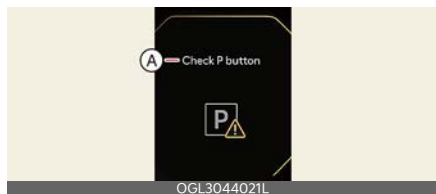

A: Check P button

The message appears on the LCD display when there is problem with the P button.

Immediately have the vehicle inspected by an authorized Kia dealer.

Check shifter dial



A: Check shifter dial

The message appears on the LCD display when there is problem with the shift dial SBW.

Immediately have the vehicle inspected by an authorized Kia dealer

Rotary shifter stuck

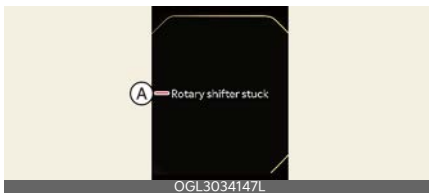

A: Rotary shifter stuck

The message appears on the LCD display when the shift dial SBW is continuously stuck or there is problem with the shift dial SBW.

Make sure that there is no object around the shift dial SBW. If the problem persists, immediately have the vehicle inspected by an authorized Kia dealer.

When the battery (12 V) is discharged

You cannot shift the gear when the battery is discharged.

Jump start your vehicle (refer to "Emergency starting" on page 8-5) or contact an authorized Kia dealer.

Good driving practices

- Never move the shift dial SBW from P (Park) or N (Neutral) to any other position with the accelerator pedal depressed.
- Never move the shift dial SBW into P (Park) when the vehicle is in motion.
- Be sure the vehicle is completely stopped before you attempt to shift into R (Reverse) or D (Drive).
- Never move the transmission out of gear and coast down a hill. This may be extremely hazardous. Always leave the vehicle in gear when moving.
- Do not "ride" the brakes. This can cause them to overheat and malfunction. Instead, When you are driving down a long hill, slow down and shift to a lower gear. When you do this, engine braking will help slow down the vehicle.
- Slow down before shifting to a lower gear. Otherwise, the lower gear may not be engaged.
- Always use the parking brake. Do not depend on placing the transmission in P (Park) to keep the vehicle from moving.
- Exercise extreme caution when driving on a slippery surface. Be especially careful when braking, accelerating or shifting gears. On a slippery surface, an abrupt change in vehicle speed can cause the drive

wheels to lose traction and the vehicle to go out of control.

- Optimum vehicle performance and economy is obtained by smoothly depressing and releasing the accelerator pedal.

⚠ WARNING

- When driving uphill or downhill, ensure that the gear position is set for the direction of travel: D (Drive) for forward and R (Reverse) for rearward. Driving in the opposite direction of the selected gear can cause the engine to shut off and can affect braking performance, increasing the risk of a crash.
- Always wear your seatbelt. In a collision, an unbelted occupant is significantly more likely to be seriously injured or killed than a properly belted occupant.
- Avoid high speeds when cornering or turning.
- Do not make quick steering wheel movements, such as sharp lane changes or fast, sharp turns.
- The risk of a rollover is greatly increased if you lose control of your vehicle at highway speeds.
- Losing control often occurs if two or more wheels drop off the roadway and the driver oversteers to reenter the roadway.
- In the event your vehicle leaves the roadway, do not steer sharply. Instead, slow down before pulling back into the travel lanes.
- Never exceed posted speed limits.

⚠ WARNING

If your vehicle becomes stuck in snow, mud, sand, etc., then you may attempt to rock the vehicle free by moving it forward and backward. Do not attempt this procedure if people or objects are anywhere near the vehicle. During the rocking operation the vehicle may suddenly move forward or backward as it becomes unstuck, causing injury or damage to nearby people or objects.

Moving up a steep grade from a standing start

To move up a steep grade from a standing start:

1. Depress the brake pedal, shift the shift dial SBW to D (Drive).
2. Select the appropriate gear depending on load weight and steepness of the grade and release the parking brake. Depress the accelerator gradually after releasing the service brakes.

Paddle shifter

The paddle shift function is available when the shift dial SBW is in the D (Drive) position.



With the shift dial SBW in the D position

Pull the [+] or [-] paddle shifter once to shift up or down one gear and the system changes from automatic mode to manual mode.

To change back to automatic shift mode from manual shift mode, do one of the following:

- Pull the [+] paddle shifter for more than one second.

The manual shift mode also changes back to automatic shift mode in one of following situations:

- When the accelerator pedal is gently depressed for more than approximately 6 seconds while driving
- When the vehicle speed is lower than 2 mph (3 km/h) (after driving more than 7 mph (10 km/h))

* NOTICE

If you pull the [+] and [-] paddle shifters at the same time, you cannot shift the gear.

Regenerative braking mode



- Pull the left side (-) of the paddle shifter to increase regenerative braking and deceleration.
- Pull the right side (+) of the paddle shifter to decrease regenerative braking and deceleration.
Pull and hold the right side (+) of the paddle shifter to turn on or off smart regeneration system.

⚠ CAUTION

- The initial setting will be set to 0 when the vehicle is in D (Drive) and in ECO mode.
- If the vehicle changes to P (Park), R (Reverse), N (Neutral) or manual mode (shift lever), or vehicle is in SPORT or TERRAIN mode (if equipped), the vehicle regenerative braking system control will not be operated. Resetting the vehicle in D (Drive) will set the regenerative system settings to the previously set steps.

- ABS and ESC will deactivate the regenerative system.
- Even if the setting for regenerative braking system is identical, it might feel different due to various vehicle speeds. (the higher speed, the less deceleration feeling)
- The regenerative braking system can be controlled
 - When the vehicle is nearly stopped in D (Drive).
 - When you are not depressing brake pedal while the vehicle is driving in D (Drive).

*** NOTICE**

Regenerative braking uses motor's power to conserve energy to the high-voltage battery when braking to gain more fuel economy and higher efficiency.

Battery charged, Regenerative braking mode deactivated

The message will appear when the high-voltage battery amount is charged enough.

Regenerative braking mode by paddle shifter not activated

The message will appear when:

- When the battery is in high or low temperature
- When the battery or transmission is not functioning properly
- Regenerative braking mode is activated while ABS/Cruise Control/Smart Cruise Control is operating

Drive normally and use the function again to dismiss the message.

Smart regeneration system

The Smart Regeneration System controls the regenerative braking automatically according to the road gradient and driving condition of the vehicle in front. The system minimizes the unnecessary operation of the brake and acceleration pedal, improving the electric efficiency and assisting the driver.

Setting smart regeneration system



- With the vehicle on, touch **Setup** → **Vehicle** → **Eco Vehicle** → **Smart Recuperation** on the infotainment system or pull and hold the right side paddle shifter for over 1 second to turn on and off the automatic change of the regenerative braking.

The level of regenerative braking displayed on the cluster in stages is converted to the 'AUTO' indicator light.

- When the vehicle is turned off and then turned on again, the regenerative braking mode returns to step '0'.

*** INFORMATION**

The infotainment system may change after software updates. For more information, refer to the manual provided in the infotainment system and the quick reference guide.

Smart regeneration system activation

With 'AUTO' for the regenerative braking level displayed on the cluster, the regenerative braking level is controlled automatically when vehicle speed is above 3.1 mph (5 km/h) and one of the condition below is met.

- The road gradient changes
- Distance from the vehicle ahead reduces or increases
- Speed of the vehicle ahead reduces or increases

* NOTICE

When vehicle speed is under 3 mph (5 km/h), the Smart Regeneration System is canceled. The driver must adjust the vehicle speed by depressing the accelerator or brake pedal according to the road condition ahead and driving condition.

When the system is turned on from the Vehicle Settings menu, but the front radar does not recognize the vehicle in front, 'AUTO' is displayed in white.



If the front radar recognizes the vehicle in front, 'AUTO' is displayed in green. The regenerative braking level is automatically controlled depending on the driving condition of the vehicle in front and the level is indicated with arrows. And, the system is canceled temporarily if the accelerator pedal is depressed.

⚠ WARNING

The Smart Regeneration System which automatically controls the regenerative braking level when coasting is only a supplemental system for the driver's convenience. Do not solely rely on this system to stop the vehicle. **The system cannot completely stop the vehicle in all situations nor avoid all collisions.**

The brake control may be insufficient depending on the speed of the vehicle in front and when the vehicle in front suddenly stops, a vehicle cuts in suddenly or there is a steep slope. Always look ahead cautiously to prevent unexpected and sudden situations from occurring.

Smart regeneration system will be temporarily canceled when:

- Canceled manually

With the vehicle on, touch **Setup** → **Vehicle** → **Eco Vehicle** → **Smart Recuperation** on the infotainment system or pull and hold the right side paddle shifter for over 1 second.

The Smart Regeneration System turns off and switches to the regenerative braking level indicator or turned off depending on currently set regenerative braking level.
- Canceled automatically
 - The vehicle is shifted to N (Neutral), R (Reverse) or P (Park) or shift lever in manual mode.
 - Switch the DRIVE mode to SPORT or TERRAIN mode. (if equipped)
 - Smart Cruise Control is in activation.
 - The ESC (Electronic Stability Control) or ABS is operating.

- If the motor and battery are in high or low temperature, or there is a problem with the battery or transmission.
- SOC (State of Charge) gauge indicates high level.

⚠ WARNING

When the Smart Regeneration System is canceled automatically, adjust the vehicle speed directly by depressing the accelerator or brake pedal according to the road and driving conditions ahead.

* INFORMATION

The infotainment system may change after software updates. For more information, refer to the manual provided in the infotainment system and the quick reference guide.

Resuming smart regeneration system

To re-activate the Smart Regeneration System while driving, with the vehicle on, touch **Setup** → **Vehicle** → **Eco Vehicle** → **Smart Recupera-tion** on the infotainment system or pull and hold the right side paddle shifter for over 1 second.

Then AUTO for the regenerative braking level will appear on the cluster.

* INFORMATION

The infotainment system may change after software updates. For more information, refer to the manual provided in the infotainment system and the quick reference guide.

Basic setting of smart regeneration system

With the Smart Regeneration System ON, Pull and hold the right side of the paddle shifter for more than 1 second to set the regenerative braking level.

The automatic regenerative braking step adjustment by the smart regenerative system operates in steps beyond the set basic step.

Vehicle-to-vehicle distance recognition sensor

In order for the Smart Regeneration System to operate properly, always make sure the radar sensor cover is clean and free of dirt, snow, and debris.

Dirt, snow, or foreign substances on the lens may adversely affect the sensing performance of the sensor. In this case, the system operation may stop temporarily and not operate normally.

Front radar



⚠ CAUTION

- Do not apply license plate frame or foreign objects such as a bumper sticker or a bumper guard near the radar sensor. Doing so may adversely affect the sensing performance of the radar.
- Always keep the radar sensor and lens cover clean and free of dirt and debris.
- Use only a soft cloth to wash the vehicle. Do not spray pressurized water directly on the sensor or sensor cover.

- Be careful not to apply unnecessary force on the radar sensor or sensor cover. If the sensor is forcibly moved out of proper alignment, the Smart Regeneration System may not operate correctly. In this case, a warning message may not be displayed. Have the vehicle inspected by an authorized Kia dealer.
- If the front bumper becomes damaged in the area around the radar sensor, the Smart Regeneration System may not operate properly. Have the vehicle inspected by an authorized Kia dealer.
- Use only Kia Genuine Parts or those of an equivalent standard to repair or replace a damaged sensor or sensor cover. Do not apply paint to the sensor cover.

System malfunction

The following message will appear when the Smart Regeneration System is not functioning normally.

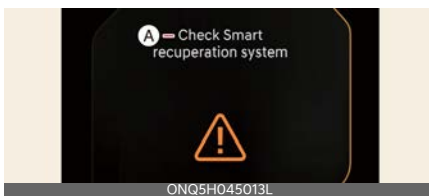

A: Check smart recuperation system

The message will appear when the system is not functioning normally. The system will be canceled and the word 'AUTO' on the cluster will disappear and instead display regenerative braking level. Check for foreign substances on the front radar. Remove any dirt, snow, or foreign material that could interfere with the radar sensors. If the system still does not operate normally, take your

vehicle to an authorized Kia dealer and have the system checked.

Limitations of the system

The Smart Regeneration System may not operate properly in certain situations when the driving condition is beyond the performance of the front radar sensor. Driver's attention is required in such cases when the system does not react properly or operate unintentionally.

Driving on a curved road



When driving on the curve, the system may not detect the vehicle in your lane and the regenerative braking level will reduce automatically, making you feel that the vehicle is accelerating.

Also, if the system suddenly recognizes the vehicle in front, the regenerative braking level will increase automatically, making you feel that the vehicle is decelerating.

The driver must maintain a safe braking distance, and if necessary, depress the brake pedal to reduce your driving speed in order to maintain a safe distance.



The smart regeneration system may recognize a vehicle in an adjacent lane when driving on a curved road. In this case, the system increase the braking level and slow the vehicle.

Always pay attention to road and driving conditions while driving. If necessary, depress the brake pedal to reduce your driving speed in order to maintain a safe distance. Also, when necessary, you may depress the accelerator pedal to prevent the system from unnecessarily decelerating your vehicle.

Always check the traffic conditions around the vehicle.

Driving on a sloped road



When driving uphill or downhill, the system may not detect the vehicle in your lane and the regenerative braking level will reduce automatically, making you feel that the vehicle is accelerating.

Also, if the system suddenly recognizes the vehicle in front, the regenerative braking level will increase automatically, making you feel that the vehicle is decelerating.

The driver must maintain a safe braking distance, and if necessary, depress the brake pedal to reduce your driving speed in order to maintain a safe distance.

Changing lanes

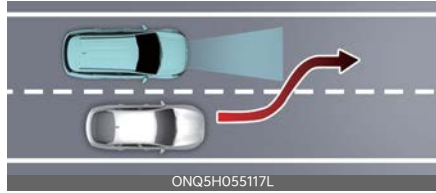

When a vehicle changes lanes in front of you, the smart regeneration system may not immediately detect the vehicle, especially if the vehicle changes lanes abruptly. In this case, you must maintain a safe braking distance, and if necessary, depress the brake pedal to reduce your driving speed in order to maintain a safe distance.

Recognizing the vehicle



Some vehicles in your lane cannot be recognized by the sensor:

- Narrow vehicles such as motorcycles or bicycles
- Vehicles offset to one side
- Slow-moving vehicles or sudden-decelerating vehicles
- Stopped vehicles (When the vehicle ahead drives away, the system may not detect a stopped vehicle.)
- Vehicles with small rear profile such as trailers with no loads

A vehicle ahead cannot be recognized correctly by the sensor if any of following occurs:

- When the vehicle is pointing upwards due to overloading in the luggage compartment
- While the steering wheel is operating
- When driving to one side of the lane
- When driving on narrow lanes or on curves

Apply the brake or accelerator pedal if necessary.

WARNING

When using the Smart Regeneration System take the following precautions:

- If an emergency stop is necessary, you must apply the brakes.
- Keep a safe distance according to road conditions and vehicle speed. If the vehicle distance is too close during high-speed driving, a serious collision may result.
- Always maintain sufficient braking distance and decelerate your vehicle by applying the brakes if necessary.
- The Smart Regeneration System is designed to detect and monitor the vehicle ahead in the roadway through radar signals. It is not designed to detect oncoming vehicles, pedestrians, bicycles, motorcycles, or smaller wheeled objects such as luggage bags, shopping carts, or strollers.
- Vehicles moving in front of you with frequent lane changes may cause a delay in the system's reaction or may cause the system to react to a vehicle actually in an adjacent lane. Always drive cautiously to prevent unexpected and sudden situations from occurring.
- The Smart Regeneration System may not recognize complex driving situations so always pay attention to driv-

ing conditions and control your vehicle speed.

NOTICE

The Smart Regeneration System may not operate temporarily due to:

- Electrical interference
- Modifying the suspension
- Differences of tire abrasion or tire pressure
- Installing different type of tires

All-Wheel Drive (AWD) system (if equipped)

The All-Wheel Drive (AWD) system delivers engine power to front and rear wheels for maximum traction.

AWD is useful when extra traction is required, such as when driving slippery, muddy, wet, or snow-covered roads.



If the system determines there is a need for four-wheel drive, the engine's driving power will be distributed to all four wheels automatically.

WARNING

Off-road driving

This vehicle is designed primarily for on road use although it can operate effectively off-road. However, it was not designed to drive in challenging off-road conditions. Driving in conditions that exceed the vehicle's intended design or the driver's experience level may result in severe injury or death.

NOTICE

If the AWD warning light () stays on the instrument cluster, your vehicle may have a malfunction with the AWD system. When the AWD warning light () appears, have your vehicle checked by an authorized Kia dealer.

WARNING

To reduce the risk of SERIOUS INJURY or DEATH:

- Do not make quick steering wheel movements, such as sharp lane changes or fast, sharp turns.
- The risk of a rollover is greatly increased if you lose control of your vehicle at highway speeds.
- Loss of control often occurs if two or more wheels drop off the roadway and the driver over steers to reenter the roadway.
- In the event your vehicle leaves the roadway, do not steer sharply. Instead, slow down before pulling back into the travel lanes.

AWD (AWD/TERRAIN MODE)

AWD helps the vehicle to maintain its best driving performance by controlling 4 wheels, engine, transmission and braking according to road conditions such as snow, mud, sand, etc.

Advantages of AWD

- Enhance safety when driving straight.
- Improve performance when cornering.
- Ensure operability in tough driving conditions such as snow, rain, sand, etc.

Switching from/to TERRAIN MODE (if equipped)



- Press TERRAIN MODE button.
- Select SNOW, MUD or SAND mode.

* NOTICE

- When you turn off Terrain Mode, it can lead to little shocks but this is a normal phenomenon that lasts until the traction forces on the front and rear wheels of the vehicle are released.
- Even though you turned off the vehicle in TERRAIN mode, DRIVE mode will be set when you restart the vehicle.

AWD transfer mode selection

Transfer mode	Selection mode	Description
DRIVE MODE	ECO SPORT MY DRIVE	<ul style="list-style-type: none"> • DRIVE MODE is used when driving on roads in normal conditions, roads in urban areas, and on highways. • All wheels are in operation when a vehicle travels at a constant speed. Required traction applying on front and rear wheels vary depending on road driving conditions and driving conditions, which will be automatically controlled by the computing system. • When the cluster's DRIVE MODE display mode is selected, the cluster displays the status of how four wheels' traction forces are distributed.
TERRAIN MODE	SNOW	SNOW mode is used to appropriately distribute the vehicle's traction forces and prevent wheel slippage when driving on snowy or slippery road.
	MUD	MUD mode is used to ensure safe driving by appropriately distributing the vehicle's traction forces when driving on muddy, unpaved or rough roads.
	SAND	SAND mode is used to ensure safe driving by appropriately distributing the vehicle's traction forces when driving on sandy, graveled or unpaved off-roads.

* SNOW ↔ MUD ↔ SAND

CAUTION

Maintain DRIVE mode when driving on roads in normal conditions. Driving in TERRAIN mode on normal roads may damage the AWD system and cause mechanical vibration or noise.

When driving (especially when cornering) under normal road conditions in TERRAIN mode, a driver may find minor mechanical vibration or noise, which is extremely normal phenomenon, not a malfunction. When TERRAIN mode is released, such noise or vibration will be immediately gone. When you turn off TERRAIN mode, it can lead to little shocks but this is a normal phenomenon that lasts until the traction forces on the front and rear wheels of the vehicle are released.

For safe All-Wheel Drive (AWD) operation

* NOTICE

All-Wheel Drive

The conditions of on-road or off-road that demand All-Wheel Drive mean all functions of your vehicle are exposed to extreme stress than under normal road conditions. Slow down and be ready for changes in the composition and traction of the surface under your tires. If you have any doubt about the safety of the conditions you are facing, stop and consider the best way to proceed.

- Do not try to drive in deep standing water or mud since such conditions can stall your engine and clog your exhaust pipes. Do not drive down steep hills since it requires extreme skill to maintain control of the vehicle.



- When you are driving up or down hills drive as straight as possible. Use extreme caution in going up or down steep hills, since you may flip your vehicle over depending on the grade, terrain and water/mud conditions.



⚠ WARNING

Hills

Driving across the contour of steep hills can be extremely dangerous. This danger can come from slight changes in the wheel angle which can destabilize the vehicle or, even if the vehicle is maintaining stability under power, it can lose that stability if the vehicle stops its forward motion. Your vehicle may roll over without warning and without time for you to correct a mistake that could cause serious injury or death.

- You must learn how to corner in an AWD vehicle. Do not rely on your experience in conventional FWD vehicles when cornering the vehicle in AWD mode. For starters, you must drive slower in AWD.

⚠ WARNING**All-Wheel Drive (AWD)**

Reduce speed when you turn corners. The center of gravity of AWD vehicles is higher than that of conventional FWD vehicles, making them more likely to roll over when you turn corners too fast.

**⚠ WARNING****Steering wheel**

Do not grab the inside of the steering wheel when you are driving on unpaved roads. You may hurt your arm by a sudden steering maneuver or from steering wheel rebound due to impact with objects on the ground. You could lose control of the steering wheel.

- Always hold the steering wheel firmly when you are driving on unpaved roads.
- Make sure all passengers are wearing seat belts.

⚠ WARNING**Wind danger**

If you are driving in heavy wind, the vehicle's higher center of gravity decreases your steering control capacity and requires you to drive more slowly.

⚠ WARNING**Driving through water**

Drive slowly. If you are driving too fast in water, the water can get into the engine compartment and wet the ignition system, causing your vehicle to suddenly stop. If this happens and your vehicle is in a tilted position, your vehicle may roll over.

*** NOTICE**

- Do not drive in water if the level is higher than the bottom of the vehicle.
- Check your brake condition once you are out of mud or water. Press the brake pedal several times as you move slowly until you feel normal braking forces return.
- Shorten your scheduled maintenance interval if you drive in off-road conditions such as sand, mud or water (refer to "Scheduled maintenance service" on page 9-8). Always wash your vehicle thoroughly after off-road use, especially cleaning the bottom of the vehicle.
- Since the driving torque is always applied to the 4 wheels the performance of the AWD vehicle is greatly affected by the condition of the tires. Be sure to equip the vehicle with four tires of the same size and type.
- A full time All-Wheel Drive vehicle cannot be towed by an ordinary tow

truck. Make sure that the vehicle is placed on a flat bed truck for moving.

⚠ WARNING

All-Wheel Drive (AWD) driving

- Avoid high cornering speed.
- Do not make quick steering wheel movements, such as sharp lane changes or fast, sharp turns.
- The risk of rollover is greatly increased if you lose control of your vehicle at high speed.
- In a collision, an unbelted person is significantly more likely to die compared to a person wearing a seat belt.
- Loss of control often occurs if two or more wheels drop off the roadway and the driver over-steers to re-enter the roadway. In the event your vehicle leaves the roadway, do not steer sharply. Instead, slow down before pulling back into the travel lanes.

⚠ CAUTION

Mud or snow

If one of the front or rear wheels begins to spin in mud, snow, etc. the vehicle can sometimes be driven out by engaging the accelerator pedal further; however avoid running the engine continuously at high rpm because doing so could damage the AWD system.

Driving in sand or mud

- Maintain slow and constant speed. Operate the accelerator pedal slowly to ensure safe driving (wheel-slip prevention).
- Keep sufficient distance between the vehicle in operation in front of your vehicle.

- Reduce vehicle speed and always check the road condition.
- Avoid speeding, rapid acceleration, sudden brake applications, and sharp turns to prevent getting stuck.
- When the vehicle is stuck in snow, sand or mud, the tires may not operate.
- This is to protect the transmission and not a malfunction.

*** NOTICE**

Moving the vehicle forcibly to get out of mud or sand can cause damage/over-heat of the engine or damage/break-down of the transmission, differential or AWD system as well as damage to tires. If excessive wheel slip occurs after entering a sandy/muddy road, the vehicle may fall into the sand/mud. When it happens, put a stone or a tree branch under the tire, and then try to pull out the vehicle, or try to get it unstuck by repeatedly moving forwards and backwards.

Transmission overheated

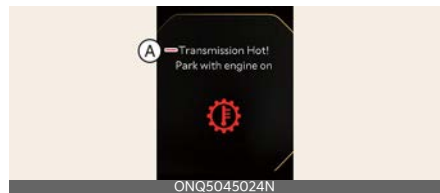

A: Transmission Hot! Park with engine on

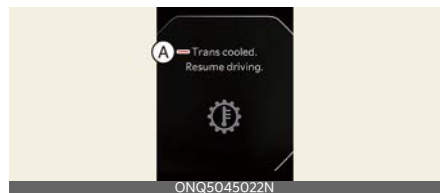

A: Trans cooled. Resume driving

- When driving on muddy and sandy roads under the severe condition, the transmission could be overheated.
- When the transmission is overheated, the safe protection mode engages and the "Transmission Hot! Park with engine on" warning message will appear on the LCD display with a chime.
- If this occurs, pull over to a safe location, stop the vehicle with the engine running, apply brake, shift the gear to P (Park) and allow the transmission to cool.
- If you ignore this warning, the driving condition may become worse. You may experience abrupt shifts, frequent shifts, or jerkiness. To return to the normal driving condition, stop the vehicle and apply the foot brake or shift into P (Park). Then allow the transmission to cool for a few minutes with engine on, before driving off.
- When the message "Trans cooled. Resume driving" appears you can resume driving your vehicle.

If the warning messages in the LCD display continue to blink, for your safety, have the system checked by an authorized Kia dealer.

Tire precautions

Always pay attention to tires for AWD (all-wheel drive) vehicles.

When driving in all-wheel drive, driving force is applied to all tires, and the driving performance of the vehicle is greatly affected by the degree of tire wear:

⚠ WARNING

- Each tire should be checked monthly when cold and inflated to inflation pressure recommended by the vehicle manufacturer on the vehicle placard or tire inflation pressure label.
- Rotate the tires every 6,000 miles (10,000 km).
- When replacing tires, be sure to equip all four tires with the same size, type, tread, brand and load-carrying capacity. Do not use tire and wheel with different size and type from the one originally installed on your vehicle. It can affect the safety and performance of your vehicle, which could lead to steering failure or rollover causing serious injury.

* Refer to "Tire chains" on page 6-57.

Towing precautions

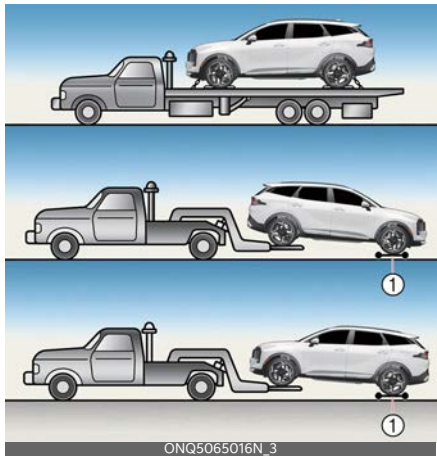

AWD vehicle



FWD vehicle



The AWD vehicle should never be towed with the wheels on the ground. Your vehicle must be towed with a wheel lift and dollies or flatbed equipment with all the wheels off the ground.

* Refer to "Trailer towing (if equipped)" on page 6-60.

⚠ CAUTION

The AWD vehicle cannot be towed with sling-type equipment. Use wheel lift or flatbed equipment.

⚠ WARNING

Your vehicle is equipped with tires designed to provide safe ride and handling capability. Do not use tires and wheels that are different in size and type from the originally installed ones. It can affect the safety and performance of your vehicle, which could lead to steering failure or rollover and serious injury. When replacing the tires, be sure to equip all four tires with tires and wheels of the same size, type, tread, brand and load-carrying capacity.

⚠ WARNING

Jacked vehicle

While the full-time AWD vehicle is being raised on a jack, never start the engine or cause the tires to rotate.

There is the danger that rotating tires touching the ground could cause the vehicle to go off the jack and to jump forward.

- Full-time AWD vehicles must be tested on a special four wheel chassis dynamometer.

*** NOTICE**

Never engage the parking brake while performing these tests.

- A full-time AWD vehicle should not be tested on a FWD roll tester. If a FWD roll tester must be used, perform the following:

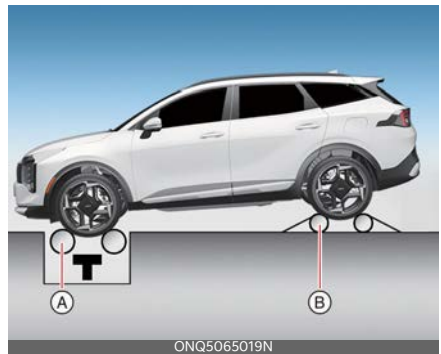

[A]: Roll tester

[B]: Temporary free roller

1. Check the tire pressures recommended for your vehicle.
2. Place the front wheels on the roll tester (A) for a speedometer test.
3. Release the parking brake.

4. Place the rear wheels on the temporary free roller (B).

WARNING

Dynamometer testing

Keep away from the front of the vehicle while the vehicle is in gear on the dynamometer. This is very dangerous as the vehicle can jump forward and cause serious injury or death.

CAUTION

- When lifting up the vehicle, do not operate front and rear wheel separately. All four wheels should be operated.
- If you need to operate the front wheel and rear wheel when lifting up the vehicle, you should release the parking brake.

Brake system

Your vehicle has power-assisted brakes, parking brakes, and various braking systems for safe driving.

Power brakes

Your vehicle has power-assisted brakes that adjust automatically through normal usage.

If the power-assisted brakes lose power because of a stalled engine or some other reason, you can still stop your vehicle by applying greater force to the brake pedal than you normally would. The stopping distance, will be longer.

When the engine is not running, the reserve brake power is partially depleted each time the brake pedal is applied. Do not pump the brake pedal when the power assist has been interrupted.

Pump the brake pedal only when necessary to maintain steering control on slippery surfaces.

* NOTICE

- When pressing the brake pedal under a certain driving or weather conditions, you may hear your car make a squealing sound or some other noises. This is not a brake malfunction but a normal phenomenon.
- When driving on a road to which deicing chemicals are applied, the vehicle may make noises from the brake or abnormal abrasion of tires because of the deicing chemicals. Under safe driving conditions, you should depress the brake several times to remove the deicing chemicals on the brake discs and pads.

⚠ CAUTION**Brake pedal**

Do not drive with your foot resting on the brake pedal. This will create abnormally high brake temperatures which can cause excessive brake lining and pad wear.

⚠ WARNING**Hybrid Electric Vehicle (HEV) driving down hill**

Do not turn off the vehicle while driving down a hill. The brake booster may not work properly and the braking distance may be longer.

⚠ WARNING**Steep hill braking**

Avoid continuous application of the brakes when descending a long or steep hill by shifting to a lower gear. Continuous brake application will cause the brakes to overheat and could result in a temporary loss of braking performance.

Wet brakes may impair the vehicle's ability to safely slow down. The vehicle may pull to one side when the brakes are applied. Applying the brakes lightly will indicate whether they have been affected in this way. Always test your brakes in this fashion after driving through deep water. To dry the brakes, apply them lightly while maintaining a safe forward speed until brake performance returns to normal.

In the event of brake failure

If the service brakes fail to operate while the vehicle is in motion, you can make an emergency stop with the parking

brake. The stopping distance, however, will be much greater than normal.

⚠ WARNING**Parking brake**

Avoid applying the parking brake to stop the vehicle while it is moving except in an emergency. Applying the parking brake while the vehicle is moving at normal speeds can cause a sudden loss of control of the vehicle. If you must use the parking brake to stop the vehicle, use greater caution in applying the brake.

Brake Over Accelerator

In the event the accelerator pedal becomes stuck or entrapped, apply steady and firm pressure to the brake pedal to slow the vehicle and reduce engine power.

If you experience this condition, take the following steps:

1. Apply the brakes and take your vehicle to a safe stop.
2. Move the transmission to P (Park), switch the engine off and apply the parking brake.
3. Inspect the accelerator pedal for any interference.

If none is found and the condition persists, have your vehicle towed to an authorized Kia dealer.

Disc brakes wear indicator

When your brake pads are worn and new pads are required, you will hear a high-pitched warning sound from your front brakes or rear brakes. You may hear this sound periodically or it may occur whenever you press the brake pedal.

Always replace the front or rear brake pads as pairs.

⚠ CAUTION

Replace brake pads

Do not continue to drive with worn brake pads. It can damage the braking system and result in costly brake repairs.

⚠ WARNING

Brake wear

Do not ignore high-pitched wear sounds from your brakes. If you ignore this audible warning, you will eventually lose braking performance, which could lead to a serious accident.

* NOTICE

Brake dust may accumulate on the wheels even under normal driving conditions. Some dust is inevitable as the brakes wear and contributes to brake noise.

Electronic Parking Brake (EPB)

After parking the vehicle, apply the EPB to prevent the vehicle from being moved by an external force.

Applying the parking brake

Applying the parking brake with EPB switch



1. Depress the brake pedal.
2. Pull up the EPB switch.

Make sure the warning light comes on.

The EPB is applied automatically if the Auto Hold button is on when the vehicle is turned off. If you pull up the EPB switch after the vehicle is turned off, the EPB will be applied.

⚠ WARNING

Never leave children or animals unattended in the vehicle. If you leave children unaccompanied in the vehicle, they may be able to set the vehicle in motion, for example by:

- Releasing the parking brake.
- Shifting the transmission out of P (Park) position.
- Starting the engine.

They may also operate vehicle equipment.

* NOTICE

On a steep incline or when pulling a trailer, if the vehicle does not remain at a standstill, do as follows:

1. Apply the EPB.
2. Pull up the EPB switch for more than 3 seconds.

Do not operate the EPB while the vehicle is moving except in an emergency.

* NOTICE

A click or electric brake motor whine sound may be heard while operating or releasing the EPB.

These conditions are normal and indicate that the EPB is functioning properly.

Automatic application of EPB

The EPB is applied automatically under the following conditions.

- Engine OFF while AUTO HOLD is enabled

- Conditions below while AUTO HOLD is activated
 - Driver's door is opened
 - Hood is opened
 - Liftgate is opened
 - Vehicle stops for more than approximately 10 minutes
 - Vehicle stops on a steep slope
- Requested by other systems

* NOTICE

For EPB equipped vehicles with AUTO HOLD function used while driving, if the ENGINE START/STOP button has been turned OFF, the EPB will be engaged automatically.

The AUTO HOLD function should be turned off before the ENGINE START/STOP button is turned off.

Emergency braking with the EPB switch

If there is a problem with the brake pedal while driving, emergency braking is possible by pulling up and holding the EPB switch.

Braking is possible only while you are holding the EPB switch.

▲ WARNING

Do not operate the EPB while the vehicle is moving except in an emergency. Applying the EPB while the vehicle is moving at normal speeds can cause a sudden loss of control of the vehicle. If you must use the EPB to stop the vehicle, use greater caution in applying the brake.

* NOTICE

During emergency braking by the EPB, the parking brake warning light will

appear to indicate that the system is operating.

If you notice a continuous noise or burning smell when the EPB is used for emergency braking, Have your vehicle checked by an authorized Kia dealer.

Releasing the parking brake with EPB switch



Releasing the parking brake with EPB switch,

1. Put the ENGINE START/STOP button in the ON position.
2. Press the brake pedal.
3. Press the EPB switch.
4. Make sure the brake warning light goes off.

Automatic release of EPB

The EPB is released automatically under the following conditions.

- Gear in P (Park)
 - With the engine running, engage the brake pedal and shift out of P (Park) to R (Reverse) or D (Drive).
- Gear in N (Neutral)
 - With the engine running, engage the brake pedal and shift out of N (Neutral) to R (Reverse) or D (Drive).
- Automatic transmission
 1. Start the engine.
 2. Fasten the driver's seat belt.
 3. Close the driver's door, hood and liftgate.

- Press the accelerator pedal while the gear is in R (Rear), D (Drive) or Sports mode.

Make sure the brake warning light goes off.

* NOTICE

- You can engage the EPB even though the ENGINE START/STOP button is in the OFF position, but you cannot release it.
- Press the brake pedal and release the parking brake manually with the EPB switch when you drive downhill or when backing up the vehicle.

Do not follow the above procedure when driving on flat level ground. The vehicle may suddenly move forward.

* NOTICE

If the parking brake warning light remains on even though the EPB has been released, have the system checked by an authorized Kia dealer.

⚠ CAUTION

Do not drive your vehicle with the EPB applied. It may cause excessive brake pad and rotor wear.

EPB warning

The EPB will display a warning message with sound under certain conditions.

- If you try to drive off while engaging the accelerator pedal with the EPB applied, but the EPB doesn't release automatically, a warning will sound, and a message will appear.
- If the driver's seat belt is not fastened and the vehicle hood, driver's door or liftgate is opened, a warning will sound, and a message will appear.

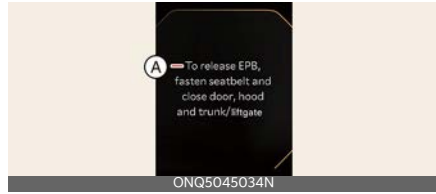

A: To release EPB, fasten seatbelt and close door, hood and trunk/liftgate

- If there is a problem with the vehicle, a warning may sound, and a message may appear.

If the above occurs, press the brake pedal and release EPB by pressing the EPB switch.

⚠ WARNING

Parking Brake Use

- Never allow a passenger to touch the parking brake. If the parking brake is released unintentionally, serious injury may occur.
- All vehicles should always have the parking brake fully engaged when parked to avoid inadvertent movement of the vehicles which can injure occupants or pedestrians.
- A click or electric brake motor whine sound may be heard while operating or releasing the EPB. These conditions are normal and indicate that the EPB is functioning properly.
- When leaving your keys with a parking lot attendant or valet, make sure to inform him/her how to operate the EPB.
- The EPB may malfunction if you drive with the EPB applied.
- When you automatically release EPB by pressing the accelerator pedal, press it slowly.

When the conversion from Auto Hold to EPB is not working properly a warning will sound and a message will appear.

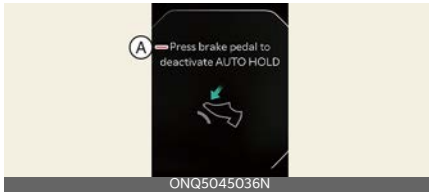

A: Press brake pedal to deactivate AUTO HOLD

*** NOTICE**

Engage the brake pedal when the above message appears for the Auto Hold and EPB may not activate.

If the EPB is applied while Auto Hold is activated because of an Electronic Stability Control (ESC) signal, a warning will sound, and a message will appear.

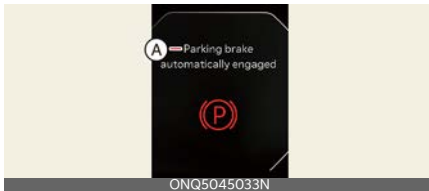

A: Parking brake automatically engaged

EPB malfunction indicator

This warning light appears if the ENGINE START/STOP button is changed to the ON position and goes off in approximately 3 seconds if the system is operating normally.

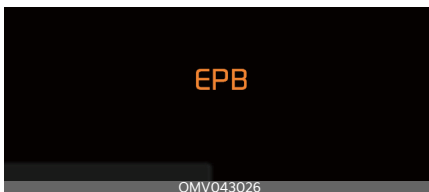

If the EPB malfunction indicator remains on, comes on while driving, or does not come on when the ENGINE START/STOP button is changed to the ON position, this indicates that the EPB may have malfunctioned.

Have your vehicle checked by an authorized Kia dealer.

The EPB malfunction indicator may appear when the ESC indicator comes on to indicate that the ESC is not working properly, but it does not indicate a malfunction of the EPB.

*** NOTICE**

The EPB warning light may appear if the EPB switch operates abnormally. Shut off and turn it on again after a few minutes. The warning light should go off and the EPB switch will operate normally. If the EPB warning light is still on, have the system checked by an authorized Kia dealer.

If the parking brake warning light does not appear or blinks even though the EPB switch was pulled up, the EPB is not on.

If the parking brake warning light blinks when the EPB warning light is on, press the EPB switch, then pull it up. Press it back to its original position and pull it back up. If the EPB warning does not turn off, have the system checked by an authorized Kia dealer.

When the EPB is not released

If the EPB does not release normally, take your vehicle to an authorized Kia dealer by loading the vehicle on a flat-bed tow truck and have the system checked.

AUTO HOLD

The Auto Hold is designed to maintain the vehicle in a standstill even though the brake pedal is not pressed after the driver brings the vehicle to a complete stop by pressing the brake pedal.

Applying Auto Hold function

1. Press the brake pedal and start the vehicle.
2. Press the Auto Hold button. The white AUTO HOLD indicator will come on indicating the system is in standby.



Before the Auto Hold will engage, the driver's door and engine hood must be closed.

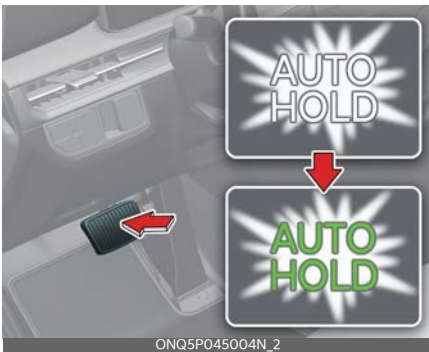

When coming to a complete stop by pressing the brake pedal, the AUTO HOLD indicator changes from white to green indicating the AUTO HOLD is engaged. The vehicle will remain at a standstill even if you release the brake pedal.

If EPB is applied, Auto Hold will be released.

If you press the accelerator pedal with the gear in D (Drive) or Manual mode, the Auto Hold will be released automatically, and the vehicle will start to move. The indicator changes from green to white indicating the Auto Hold is in standby and the EPB is released.

When driving from Auto Hold by pressing the accelerator pedal, always check the surrounding area near your vehicle. Slowly press the accelerator pedal for a smooth launch.

Canceling Auto Hold function



- To cancel the Auto Hold operation, press the Auto Hold switch. The AUTO HOLD indicator will turn off.
- To cancel the Auto Hold operation when the vehicle is at a standstill, press the Auto Hold switch while pressing the brake pedal.

* NOTICE

- The following are conditions when the Auto Hold will not engage (Auto Hold light will not turn green and the Auto Hold system remains in standby):
 - The driver's door is opened
 - The engine hood is opened
 - The gear is in P (Park)
 - The gear is in R (Reverse)
 - The EPB is applied
- For your safety, the Auto Hold automatically switches to EPB under any of the following conditions (Auto Hold

light remains white and the EPB automatically applies):

- The driver's door is open.
- The engine hood is open.
- The vehicle is in a standstill for more than 10 minutes.
- The vehicle is standing on a steep slope.
- The vehicle moved for a few seconds.

In these cases, the brake warning light comes on, the AUTO HOLD indicator changes from green to white, a warning sounds and a message will appear to inform you that EPB has been automatically engaged. Before driving off again, press the brake pedal, check the surrounding area near your vehicle and release parking brake manually with the EPB switch.

- If the AUTO HOLD indicator lights up yellow, the Auto Hold is not working properly. Have the system checked by an authorized Kia dealer.

⚠ WARNING

To reduce the risk of an accident, do not activate the Auto Hold while driving downhill, backing up or parking your vehicle.

If there is a malfunction with the driver's door, liftgate or engine hood open detection system, the Auto Hold may not work properly.

Have the system checked by an authorized Kia dealer.

*** NOTICE**

A click or electric brake motor whine sound may be heard while operating or releasing the EPB. These conditions are normal and indicate that the EPB is functioning properly.

Warning messages

The Auto Hold function will display a warning message with sound under certain conditions.

When the EPB is applied from Auto Hold, a warning will sound, and a message will appear.

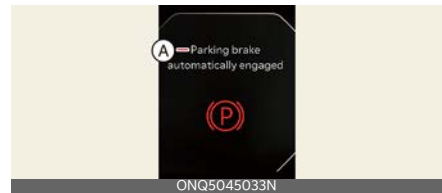

A: Parking brake automatically engaged

When the conversion from Auto Hold to EPB is not working properly, a warning will sound, and a message will appear.

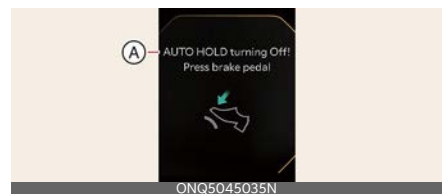

A: AUTO HOLD turning Off! Press brake pedal

*** NOTICE**

When this message is displayed, the Auto Hold and EPB may not operate. For your safety, press the brake pedal.

If you do not apply the brake pedal when you release the Auto Hold by

pressing the [AUTO HOLD] switch, a warning will sound, and a message will appear.

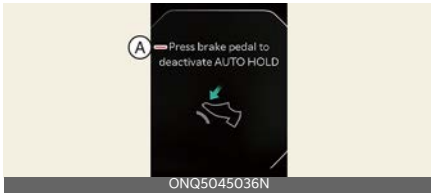

A: Press brake pedal to deactivate AUTO HOLD

When you press the [AUTO HOLD] switch, if the driver’s door and engine hood are not closed, a warning will sound, and a message will appear on the LCD display.

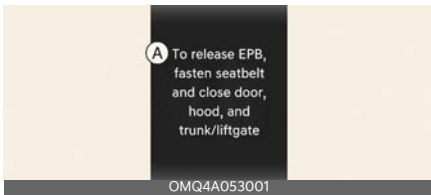

A: AUTO HOLD conditions not met. Close door, hood and trunk/liftgate

Press the [AUTO HOLD] button after closing the driver’s door and engine hood.

Anti-lock Brake System (ABS)

The ABS prevents the wheels from locking during hard braking. This helps to stabilize the vehicle and allows it to be steered.

When you apply your brakes under conditions which may lock the wheels, you may hear a "tik-tik" sound from the brakes or feel a corresponding sensation in the brake pedal. This is normal and it means your ABS is active. To obtain the maximum benefit from your ABS in an emergency, do not attempt to modulate

your brake pressure and do not pump your brakes.

ABS (or Electronic Stability Control (ESC)) will not prevent accidents due to improper or dangerous driving maneuvers. Even though vehicle control is improved during emergency braking, always maintain a safe distance between you and objects ahead. Reduce vehicle speed:

- When driving on rough or gravel road
- When driving on roads where the road surface is pitted or has different surface heights.
- When approaching standing or puddled water
- When driving on snow-covered or icy roads
- When driving with tire chains installed

Driving under these conditions increases stopping distance.

*** NOTICE**

A click sound may be heard in the occupant compartment when the vehicle begins to move after the vehicle is started. This is normal and indicates that the ABS is functioning properly.

Even with ABS, your vehicle still requires sufficient stopping distance. Always maintain a safe distance from the vehicle in front of you.

Always slow down when cornering. ABS cannot prevent accidents resulting from excessive speeds.

On loose or uneven road surfaces, operation of the ABS may result in a longer stopping distance than for vehicles equipped with a conventional brake system.

The ABS warning light will stay on for approximately 3 seconds after the ENGINE START/STOP button is ON.



The ABS will perform self-diagnosis and the light will go off if everything is normal. If the light stays on, you may have a problem with your ABS. Visit an authorized Kia dealer.

When you drive on a road with poor traction (such as an icy road) and have operated your brakes continuously, the ABS will be active continuously and the ABS warning light may appear. Pull over to a safe place and stop the vehicle.

Restart the vehicle. If the ABS warning light goes off, your ABS is normal. Otherwise, you may have a problem with the ABS. Visit an authorized Kia dealer.

* NOTICE

When you jump start your vehicle because of a drained battery, the vehicle may not run as smoothly, and the ABS warning light may turn on. This happens because of low battery voltage. It does not mean your ABS has malfunctioned.

- Do not pump your brakes.
- Have the battery recharged before driving the vehicle.

Electronic Stability Control (ESC) system

The ESC system can reduce the risk of spinning or plowing during cornering maneuvers and under certain conditions. It can automatically brake individual wheels and moderate engine speed to reduce those risks. When the ESC system intervenes, you may hear a ticking

sound from the braking and feel vibration on the brake pedal. Your engine power may decrease.



ESC cannot intervene in all conditions, particularly when exceeding the safe speed for the road conditions, in slick conditions, and when puddled water can cause hydroplaning. Always drive at the safest speed for the road and weather conditions. Avoid sharp turns and abrupt maneuvers when driving at speed. ESC is not a substitute for safe driving.

⚠ WARNING

For maximum protection, always wear your seat belt. No system, no matter how advanced, can compensate for all driver errors and/or driving conditions. Always drive responsibly.

The ESC system is an electronic system designed to help the driver maintain vehicle control under adverse conditions. It is not a substitute for safe driving practices. Factors including speed, road conditions and driver steering input can all affect whether ESC will be effective in preventing a loss of control. It is your responsibility to drive and corner at reasonable speeds and to leave a sufficient margin of safety.

When you apply your brakes under conditions which may lock the wheels, you may hear a "tik-tik" sound from the brakes or feel a corresponding sensation in the brake pedal. This is normal and it means your ESC is active.

* NOTICE

A click sound may be heard in the occupant compartment when the vehicle begins to move after the vehicle is started. This condition is normal and indicates that the ESC system is functioning properly.

ESC operation

ESC ON condition

- When the ENGINE START/STOP button is turned ON, ESC and ESC OFF indicator lights appear for approximately 3 seconds, then ESC is turned on.
- Press the ESC OFF button for at least half a second after turning the vehicle ON to turn ESC off. (ESC OFF indicator will appear). To turn the ESC on, press the ESC OFF button (ESC OFF indicator light will go off).
- When starting the vehicle, you may hear a slight ticking sound. This is the ESC performing an automatic system self-check and does not indicate a problem.

When operating



When the ESC is in operation, the ESC indicator light blinks.

When the ESC is operating properly, you may feel a slight pulsation in the vehicle. This is an effect of brake control and indicates nothing unusual. When moving out of the mud or driving on a slippery road, pressing the accelerator pedal may not cause the vehicle rpm (revolutions per minute) to increase.

ESC operation off





This vehicle has 2 kinds of ESC off states.

OFF

If the vehicle stops when ESC is off, ESC remains off. Upon restarting the vehicle, the ESC will automatically turn on again.

ESC off state 1

To turn off the traction control function and only operate the brake control function of the ESC, press the ESC OFF button (ESC OFF ) for less than 3 seconds and the ESC OFF indicator light (ESC OFF ) will appear.

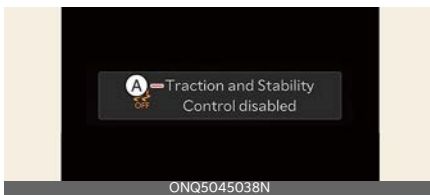

A: Traction and Stability Control disabled

ESC off state 2

To turn off the traction control function and the brake control function of the ESC, press the ESC OFF button (ESC OFF ) for more than 3 seconds. ESC

OFF indicator light (ESC OFF ) will appear and ESC OFF warning chime will sound. At this state, the vehicle stability control function does not operate anymore.

Indicator light

ESC indicator light



ESC OFF indicator light



When the ENGINE START/STOP button is turned ON, the indicator light appears and then turns off if the ESC system is operating normally.

The ESC indicator light blinks whenever ESC is operating or appears when ESC fails to operate.

The ESC OFF indicator light turns on when the ESC is turned off with the button.

⚠ WARNING

ESC

Drive carefully even though your vehicle has ESC. It can only assist you in maintaining control under certain circumstances.

ESC OFF usage

When driving

- Do not turn off ESC during ordinary driving.
- To turn ESC off while driving, press the ESC OFF button while driving on a flat road surface.

⚠ WARNING

Operating ESC

Never press the ESC OFF button while ESC is operating (ESC indicator light blinks).

If ESC is turned off while ESC is operating, the vehicle may slip out of control.

*** NOTICE**

- When operating your vehicle on a dynamometer, ensure that the ESC is turned off (ESC OFF light appears). If the ESC is left on, it may prevent the vehicle speed from increasing, and result in false diagnosis.
- Turning the ESC off does not affect ABS or brake system operation.

Downhill Brake Control (DBC)



The DBC feature assists the driver to descend down a steep hill without having to depress the brake pedal.

The system automatically applies the brakes to maintain the vehicle speed 2.5-25 mph (4-40 km/h) and allows the driver to concentrate on steering the vehicle downhill.

Always turn off the DBC on flat roads. The DBC might activate inadvertently from the standby mode when driving through speed bumps or making sharp curves.





*** NOTICE**

The DBC defaults to the OFF position whenever the ignition switch or ENGINE START/STOP button is placed in the ON position.

Noise or vibration may occur from the brakes when the DBC is activated. The

rear stop light comes on when the DBC is activated.

DBC operation

Mode	Indicator light	Description
Standby	 appear	Press the DBC button when vehicle speed is under 38 mph (60 km/h). The DBC system will turn ON and enter standby mode. The system does not turn ON if vehicle speed is over 38 mph (60 km/h).
Activated	 blinks	In the standby mode, it enters the operating mode when the following conditions are met. <ul style="list-style-type: none"> • The road surface should be more than a certain angle of inclination • The accelerator pedal must not be depressed. • The vehicle speed should be within 2.5-25 mph (4-40 km/h). Within operating vehicle speed 2.5-25 mph (4-40 km/h), the driver can lower or raise the vehicle speed by stepping on the brake pedal or accelerator pedal.
Temporarily deactivated	 appear	In the activated mode, the DBC will temporarily deactivate under the following conditions: <ul style="list-style-type: none"> • The hill is not steep enough. • The accelerator pedal is depressed. • When the vehicle speed is in the range of 25-38 mph (40-60 km/h) If the above conditions are not met, the DBC will automatically activate again.
OFF	 not appeared	The DBC will turn OFF under the following conditions: <ul style="list-style-type: none"> • The DBC button is pressed again. • When the accelerator pedal is depressed, and the vehicle speed exceeds 38 mph (60 km/h)

* NOTICE

If the DBC yellow indicator light appears, the system may have overheated or malfunctioned. When the warning light appears even though the DBC system has cooled off, have your vehicle checked by an authorized Kia dealer as soon as possible.

* NOTICE

- The DBC may not deactivate on steep inclines even though the brake or accelerator pedal is depressed.
- The DBC does not operate when:
 - The gear is in P (Park).
 - ESC is activated.

Hill-start Assist Control (HAC)

A vehicle has the tendency to roll back on a steep hill when it starts to go after stopping. The HAC prevents the vehicle from rolling back by applying the brakes automatically for about 2 seconds.

The brakes are released when the accelerator pedal is engaged or after about 2 seconds.

The HAC is activated only for about 2 seconds, so when the vehicle is starting off always engaged the accelerator pedal.

⚠ WARNING

Maintaining brake pressure on incline

HAC does not replace the need to apply brakes while stopped on an incline.

While stopped, make sure you maintain brake pressure sufficient to prevent your vehicle from rolling backward and causing an accident. Don't release the brake pedal until you are ready to accelerate forward.

Crosswind Stability Control (CSC)

CSC works with ESC and Motor Driven Power Steering (MDPS) to stabilize the vehicle when it shakes, or loses traction from a strong crosswind.

CSC system operation



1 Crosswind stability control activated.

- When driving over a bridge or next to a large truck or bus, strong crosswinds may cause the vehicle to shake

or lose traction. The CSC automatically adjusts the vehicle position and steering wheel to correct course.

- When activated, the ESC (🚗) indicator light illuminates and warning message appears on the instrument cluster display with a warning sound.
- When activated, the driver may feel a slight vibration of the vehicle and steering wheel, due to braking and MDPS.

CSC system off

Crosswind Stability Control may not operate, or may cancel its operation in the following conditions:

- Vehicle speed is under 45 mph (70 km/h) or over 112 mph (180 km/h)
- If the driver makes a sharp turn while driving.
- Driving on a bumpy road, ice, snow, or slippery surface such due to ice, snow, or rain.
- Turning ESC on cancels the operation of CSC.
- Driving assistance system (FCA, BCA, LKA, LFA, etc.) are turned on.

CSC malfunction

- When ESC has problems, CSC does not operate.
- When MDPS has problems, CSC may partially operate.
- If the ESC (🚗) or MDPS (🚗) warning light stays illuminated or blinks, you have your vehicle inspected by an authorized Kia dealer.

⚠ WARNING

Crosswind Stability Control is a supplementary system to assist the driver. The driver remains responsible for the control of the vehicle.

Always hold the steering wheel while driving and depress the brake pedal to reduce speed if necessary.

Vehicle Stability Management (VSM) system

VSM provides further enhancements to vehicle stability and steering responses under the following condition:

- When driving on a slippery road or
- When a change in the coefficient of friction between left and right wheels is detected.

WARNING

Tire/wheel size

When replacing tires and wheels, make sure they are the same size as the original-installed tires and wheels. Driving with different tire or wheel sizes may diminish any supplemental safety benefits of the VSM system.

VSM operation

When the VSM is operating properly, you may feel a slight pulsation in the vehicle and/or abnormal steering responses from EPS. This is only an effect of brake and EPS control and indicates nothing unusual.

The VSM does not operate when:

- Driving on a slope such as a gradient or incline
- Driving in reverse
- ESC OFF indicator light () remains on the instrument cluster
- EPS indicator light remains on the instrument cluster

VSM operation off

If you press the ESC OFF button to turn off the ESC, the VSM will also cancel and the ESC OFF indicator light () appears.

To turn on the VSM, press the button again. The ESC OFF indicator light goes out.

WARNING

VSM

Drive carefully even though your vehicle has VSM. It can only assist you in maintaining control of the vehicle under certain circumstances.

Malfunction indicator

The VSM can be deactivated even if you don't cancel the VSM operation by pressing the ESC OFF button. It indicates that a malfunction has been detected in the EPS or VSM system. If the ESC indicator light () or EPS warning light remains on, have the system checked by an authorized Kia dealer.

The VSM is not a substitute for safe driving practices but is only a supplementary function. It is the responsibility of the driver to always check the speed and the distance to a vehicle ahead. Always hold the steering wheel firmly while driving.

Your vehicle is designed to activate according to the driver's intention, even with installed VSM. Always follow all the normal precautions for driving at safe speeds for the conditions - including driving in inclement weather or on a slippery road.

WARNING

For maximum protection, always wear your seat belt. No system, no matter how advanced, can compensate for all driver errors and/or driving conditions. Always drive responsibly.

Trailer Stability Assist (TSA) system

TSA can help stabilize the vehicle and trailer during trailer towing by automatically braking to help slow and stabilize the vehicle and trailer. There are various factors that make the vehicle sway, such as

- High speed
- Strong crosswinds
- Improper overloading
- Sudden controlling of steering wheel
- Uneven road

When towing, drive at a safe speed and beware of conditions that can cause swaying.

Good braking practices

Good braking practices help keep occupants safe and extend brake life.

- Check to be sure the parking brake is not engaged and the parking brake indicator light is off before driving.
- Driving through water may wet the brakes. They can also get wet when the vehicle is washed. Wet brakes can be dangerous. Your vehicle will not stop as quickly if the brakes are wet. Wet brakes may cause the vehicle to pull to one side.

To dry the brakes, apply the brakes lightly until the braking action returns to normal, taking care to always keep the vehicle under control. If the braking action does not return to normal,

stop as soon as it is safe to do so and visit an authorized Kia dealer.

- Don't coast downhill with the vehicle out of gear. This is extremely hazardous. Always keep the vehicle in gear, use the brakes to slow down, then shift to a lower gear so that vehicle braking will help you maintain a safe speed.
- Don't "ride" the brake pedal. Resting your foot on the brake pedal while driving can be dangerous because the brakes might overheat and lose its effectiveness. It also increases the wear of the brake components.
- If a tire goes flat while you are driving, apply the brakes gently and keep the vehicle pointed straight ahead while you slow down. When you are moving slowly enough for it to be safe to do so, pull off the road and stop in a safe place.
- Be cautious when parking on a hill. Firmly engage the parking brake and place the shifter dial in P (Park). If your vehicle is facing downhill, turn the front wheels into the curb to help keep the vehicle from rolling. If your vehicle is facing uphill, turn the front wheels away from the curb to help keep the vehicle from rolling. If there is no curb or if it is required by other conditions to keep the vehicle from rolling, block the wheels.
- Under some conditions your parking brake can freeze in the engaged position. This is most likely to happen when there is an accumulation of snow or ice around the rear brakes or if the brakes are wet. If there is a risk that the parking brake may freeze, apply it only temporarily while you put the shifter dial in P (Parking) and

block the rear wheels so the vehicle cannot roll. Then release the parking brake.

- Do not hold the vehicle on an incline with the accelerator pedal. This can cause the transmission to overheat. Always use the brake pedal or parking brake.

Vehicle Auto Shut-off system (if equipped)

If your vehicle is parked and the engine is left on for a long period of time, the engine will turn off automatically to help reduce fuel consumption and prevent accidents caused by carbon monoxide poisoning.

Operating Conditions

Vehicle Auto-Shut Off timer operates when all the following conditions are satisfied:

- Vehicle speed is below 2 mph (3 km/h), and the gear is shifted to P (Park)
- The brake pedal and accelerator pedal are not depressed
- The driver's seat belt is unfastened
- The passenger seat is empty
- The infotainment system is being updated

Deactivating Conditions

Vehicle Auto-Shut Off timer turns off when one of these situations occur:

- Vehicle speed is above 2 mph (3 km/h)
- The gear is shifted to R (Reverse), D (Drive) or N (Neutral)
- The brake pedal or accelerator pedal is depressed
- The driver's seat belt is fastened
- A passenger is in the passenger's seat

System Operation

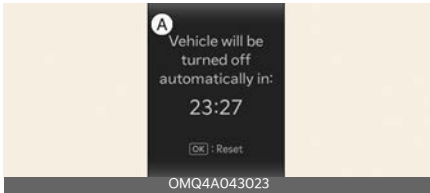

A: Vehicle will be turned off automatically in:

B: Reset

When all the conditions are satisfied, the Vehicle Auto-Shut Off operates and turns the engine off automatically after 60 minutes.

A timer appears on the instrument cluster 30 minutes before the vehicle shuts off.

Resetting cluster timer

To reset the cluster timer, do one of following:

- Release the accelerator pedal or brake pedal after Vehicle Auto-Shut Off is complete.
- Press the OK button on the steering wheel while the timer appears on the instrument cluster.

CAUTION

Do not leave passengers or pets in the vehicle with the engine running in hot or cold weather. This is dangerous and can lead to injury and death. The air conditioning system will turn off when the engine turns off.

Drive mode integrated control system

Drive mode

The drive mode integrated control system allows the driver to select the drive mode most appropriate to the surrounding environment.



The Drive mode is activated by press the **DRIVE MODE** button.

When NORMAL mode is selected, it is not displayed on the instrument cluster.

- MY DRIVE mode:
 - The driver can separately adjust modes of each driving system.
 - SPORT mode:
 - SPORT mode provides sporty driving.
 - ECO mode:
 - ECO mode provides soft driving.
- The drive mode will change to ECO mode when the engine is restarted.

MY DRIVE mode

In MY DRIVE mode, the driver can select separate modes and combine them on the infotainment system screen.

- Select 'Drive mode → MY DRIVE MODE' from the vehicle settings menu on the infotainment system screen. Then select MY DRIVE MODE on the infotainment screen to select powertrain and steering wheel mode.
- Engine/Transmission: ECO/SPORT/SMART/BABY
- Steering wheel: NORMAL/SPORT

- When MY DRIVE mode is selected by using the drive mode button, the MY DRIVE mode indicator will illuminate according to the selected mode.

SPORT mode

SPORT mode manages the driving dynamics by automatically adjusting the steering effort, the engine and transmission control logic for enhanced driver performance.

- When SPORT mode is selected by using the DRIVE MODE button, the SPORT indicator will appear.
- Whenever the engine is restarted, the Drive Mode will revert to ECO mode. If SPORT mode is desired, re-select SPORT mode from the DRIVE MODE button.
- When SPORT mode is activated:
 - The engine rpm will tend to remain raised over a certain length of time even after releasing the accelerator
 - Upshifts are delayed when accelerating

* NOTICE

In SPORT mode, the fuel efficiency may decrease.

Active air flap



Active air flap system controls the air flap below the front bumper to cool the vehicle components and improve fuel efficiency.

Active air flap malfunction

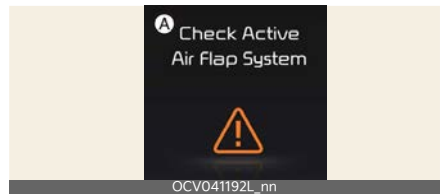

A: Check Active Air Flap System

The active air flap system may not operate normally if the air flap is temporarily opened due to foreign factors or if the controller is contaminated by snow or rain, etc.

When the message is displayed, stop the vehicle in a safe place and check the status of the air flap.

Start the vehicle after removing the foreign matter and waiting 10 minutes. If the message remains, have the vehicle inspected by an authorized Kia dealer.

⚠ CAUTION

- Regardless of the warning message display, if the air flaps are visually asymmetrical (vehicles with exposed flap applied), turn off the engine, inspect the air flap and restart after about 10 minutes.
- The active air flap system is actuated by motors. Do not disturb actuation or

apply force excessively. It may cause failure.

* NOTICE

Active air flap system could be activated regardless of the vehicle condition.(Parking, driving, charging, etc.)

Green Zone Drive Mode

In order to protect the atmospheric environment in urban areas, EV mode is expanded when entering the road inside the green zone based on the navigation information.

Also, EV mode is expanded based on the driving history when departing from home.

Operation

With the vehicle on, **Setup** → **Vehicle** → **ECO Vehicle** → **Green Zone EV Drive** on the infotainment system.

Green Zone Drive Mode LCD display



Enable Green Zone Drive Mode when entering green zone in ECO mode.

Green zone registration point

Based on navigation information and driving history.

1. School
2. Large hospitals
3. Registered favorites (Home/Office)

* INFORMATION

A change may occur through regular navigation updates.

⚠ CAUTION

Even in the Green Zone, the EV mode driving ability may be reduced or the engine may start in the following situations:

- If the battery charge is low.
 - If the engine power is required (acceleration/climbing/heating/cooling) or engine start is required for driving system operation.
 - If Green Zone recognition is not possible due to navigation problems.
-

Economical operation

Your vehicle's fuel economy depends mainly on your style of driving, where you drive and when you drive.

Each of these factors affects how many miles (kilometers) you can get from a gallon (liter) of fuel. To operate your vehicle as economically as possible, use the following suggestions to help save money in both fuel and repairs:

- Drive smoothly. Accelerate at a moderate rate. Don't make "jackrabbit" starts or full-throttle shifts and maintain a steady cruising speed. Don't race between stoplights. Adjust your speed to the traffic so you don't have to change speeds unnecessarily. Avoid heavy traffic whenever possible.
Always maintain a safe distance from other vehicles so you can avoid unnecessary braking. This will also reduce brake wear.
- Drive at a moderate speed. The faster you drive, the more fuel your vehicle uses. Driving at a moderate speed, especially on the highway, is one of the most effective ways to reduce fuel consumption.
- Take care of your tires. Keep them inflated to the recommended pressure. Incorrect inflation, either too much or too little, results in tire wear. Check the tire pressures at least once a month.
- Be sure that the wheels are aligned correctly. Improper alignment can result from hitting curbs or driving too fast over irregular surfaces. Poor alignment causes faster tire wear and may also result in other problems such as greater fuel consumption.

- Keep your vehicle in good condition. For better fuel economy and reduced maintenance costs, maintain your vehicle in accordance with the maintenance schedule in "Scheduled maintenance service" on page 9-8. If you drive your vehicle in severe conditions, more frequent maintenance is required (Refer to "Scheduled maintenance service" on page 9-8).
- Travel lightly. Don't carry unnecessary weight in your vehicle. Weight reduces fuel economy.
- Don't let the engine idle longer than necessary. If you are waiting (and not in traffic), turn off your engine and restart only when you're ready to go.
- Don't "lug" or "over-rev" the engine. Lugging is driving too slowly in too high a gear resulting in the engine bucking. If this happens, shift to a lower gear. Over-revving is racing the engine beyond its safe limit. This can be avoided by shifting at the recommended speeds.
- Opened windows at high speeds can reduce fuel economy.
- Fuel economy is less in crosswinds and headwinds. To offset some of this loss, slow down when driving in these conditions.

Keeping a vehicle in good operating condition is important both for economy and safety.

Have the function checked by an authorized Kia dealer.

WARNING

Engine off during motion

Never turn the engine off to coast downhill or anytime the vehicle is in motion. The power steering and power brakes will not function properly without the engine running. In addition, turning off the ignition while driving could engage the steering wheel lock resulting in loss of vehicle steering. Keep the engine on and downshift to an appropriate gear for engine braking effect.

Special driving conditions

If driving conditions deteriorate due to poor weather or road conditions, you should pay even more attention than usual to your driving.

Hazardous driving conditions

When hazardous driving conditions are encountered such as water, snow, ice, mud, sand, or similar hazards, follow these suggestions:

- Drive cautiously and allow extra distance for braking.
- Avoid sudden braking or steering.
- Do not pump the brake pedal on a vehicle equipped with ABS.
- If stalled in snow, mud, or sand, use the second gear. Accelerate slowly to avoid spinning the drive wheels.
- Use sand, rock salt or other nonslip material under the drive wheels to provide traction when stalled in ice, snow, or mud.

Reducing the risk of a rollover

This multi-purpose passenger vehicle is defined as a Sports Utility Vehicle (SUV). Utility vehicles have a significantly higher rollover rate than other types of vehicles. SUVs have higher ground clearance and a narrower track to make them capable of performing in a wide variety of offroad applications.

Specific design characteristics give them a higher center of gravity than ordinary vehicles. An advantage of the higher ground clearance is a better view of the road, which allows you to anticipate problems.

They are not designed for cornering at the same speeds as conventional passenger vehicles, any more than low-

slung sports vehicles are designed to perform satisfactorily in off-road conditions. Due to this risk, driver and passengers must buckle their seat belts.

In a rollover crash, an unbelted person is significantly more likely to die than a person wearing a seat belt. There are steps that a driver can take to reduce the risk of a rollover.

If possible, avoid sharp turns or abrupt maneuvers, do not load your roof rack with heavy cargo and never modify your vehicle in any way.

WARNING

Rollover

As with other SUVs, failure to operate this vehicle correctly may result in loss of control, an accident or vehicle rollover.

- SUVs have a significantly higher rollover rate than other types of vehicles.
- Specific design characteristics (higher ground clearance, narrower track, etc.) give this vehicle a higher center of gravity than ordinary vehicles.
- An SUV is not designed for cornering at the same speeds as a conventional vehicles.
- Avoid sharp turns or abrupt maneuvers.
- In a rollover, an unbelted person is significantly more likely to die than a person wearing a seat belt. Make sure everyone in the vehicle is properly belted.

WARNING

Your vehicle is equipped with tires designed to provide safe ride and handling capability. Do not use tires and wheels that are different in size and type from the originally installed ones. It can

affect the safety and performance of your vehicle, which could lead to steering failure or rollover and serious injury. When replacing the tires, be sure to equip all four tires with the same size, type, tread, brand and load-carrying capacity.

Rocking the vehicle

If it is necessary to rock the vehicle to free it from snow, sand, or mud, first turn the steering wheel right and left to clear the area around your front wheels. Then, shift back and forth between R (Reverse) and any forward gear.

Do not race the engine and spin the wheels as little as possible. If you are still stuck after a few tries, have the vehicle pulled out by a tow vehicle to avoid engine overheating and possible damage to the transmission.

WARNING

Sudden vehicle movement

Do not attempt to rock the vehicle if people or objects are nearby. The vehicle may suddenly move forward or backwards as it becomes unstuck.

CAUTION

Vehicle rocking

Prolonged rocking may cause vehicle overheating, transmission damage or failure, and tire damage.

CAUTION

Spinning tires

Do not spin the wheels, especially at speeds more than 35 mph (56 km/h). Spinning the wheels at high speeds when the vehicle is stationary could

overheat and damage tires and the rotating wheels may fly away and injure bystanders.

NOTICE

ESC should be turned OFF prior to rocking the vehicle.

Smooth cornering

Avoid braking or gear changing in corners, especially when roads are wet. Ideally, corners should always be taken under gentle acceleration. If you follow these suggestions, tire wear will be minimized.

Driving at night

Because night driving presents more hazards than driving in the daylight, here are some important tips to remember:

- Slow down and keep more distance between you and other vehicles, as it may be more difficult to see at night, especially in areas where there may not be any streetlights.
- Adjust your mirrors to reduce the glare from other driver's headlamps.
- For vehicles not equipped with the automatic headlamp aiming feature, keep your headlamps clean and properly aimed. Dirty or improperly aimed headlamps will make it much more difficult to see at night.
- Avoid staring directly at the headlamps of oncoming vehicles. You could be temporarily blinded and it will take several seconds for your eyes to readjust to the darkness.

Driving in the rain

Rain and wet roads can make driving dangerous, especially if you're not prepared for the slick pavement.

Consider when driving in the rain:

- A heavy rainfall will make it harder to see and will increase the distance needed to stop your vehicle, so slow down.
- Keep your windshield wiping equipment in good shape. Replace your windshield wiper blades when they show signs of streaking or missing areas on the windshield.
- If your tires are not in good condition, making a quick stop on wet pavement can cause a skid and possibly lead to an accident. Be sure your tires are in good shape.
- Turn on your headlamps to make it easier for others to see you.
- Driving too fast through large puddles can affect your brakes. If you must go through puddles, drive through them slowly.
- If you believe your brakes are wet, gently apply them several times while driving until normal braking operation returns.

Hydroplaning

If the road is wet enough and you are driving too fast, your vehicle may have little or no contact with the road surface and ride on the water. The best advice is SLOW DOWN when the road is wet.

The risk of hydroplaning increases as the depth of tire tread decreases, refer to "Tires and wheels" on page 9-32.

Driving in flooded areas

Avoid driving through flooded areas unless you are sure the water is no higher than the underside of the wheel.

Drive through any water slowly. Allow adequate stopping distance because brake performance may be affected.

After driving through water, dry the brakes by gently applying them several times while the vehicle is moving slowly.

Highway driving

Tires

Adjust the tire pressure to its specification. Low tire inflation pressures will result in overheating and possible failure of the tires.

Avoid using worn or damaged tires which may result in reduced traction or tire failure.

Never exceed the maximum tire inflation pressure shown on the tires.

WARNING

Under/over inflated tires

Always check the tires for proper inflation before driving. Underinflated or overinflated tires can cause poor handling, loss of vehicle control and sudden tire failure, leading to accidents, injuries, and even death. For proper tire pressures, refer to "Tires and wheels" on page 9-32.

WARNING

Tire tread

Always check the tire tread before driving your vehicle. Worn tires can result in loss of vehicle control. Worn-out tires should be replaced as soon as possible.

For further information and tread limits, refer to "Tires and wheels" on page 9-32.

Fuel, engine coolant and engine oil

High speed travel consumes more fuel than urban driving. Check both the engine coolant and engine oil.

Drive belt

A loose or damaged drive belt may result in overheating of the engine.

Winter driving

Winter driving presents additional challenges and risks.

For AWD (all-wheel drive) vehicles, install the chains on the front wheels. However, this may damage the AWD system, so keep the travel distance as short as possible.

Snowy or icy conditions

Pay particular attention to your speed, to other vehicles, and to road conditions when it is snowy and icy.

Snow and ice reduce road friction. Speed increases the risk of a loss of control. Sudden brake applications on snowy or icy roads may cause skids to occur. Apply the brakes gently whenever possible. Use engine braking to further reduce the risk of skidding. Avoid abrupt maneuvers.

ESC, Traction Control and ABS can reduce the risk of skidding to some extent, but are no substitute for reducing speed, braking moderately, and avoiding abrupt maneuvers.

It may sometimes be necessary or advisable to use snow tires or tire chains or both. Follow the instructions below. Note that snow tires and chains do not reduce the risks of speeding, sudden braking, or abrupt maneuvers.

WARNING

Failure to follow the instructions above can lead to serious injury and death.

Snow tires

If you mount snow tires on your vehicle, make sure they are radial tires of the same size and load range as the original tires. Mount snow tires on all four wheels to balance your vehicle's handling in all weather conditions.

Do not install studded snow tires without first checking local, state and municipal regulations for possible restrictions against their use.

⚠ WARNING

Failure to follow the instructions above can lead to serious injury and death.

⚠ WARNING

Snow tire size

Snow tires should be equivalent in size and type to the vehicle's standard tires. Safety and handling of your vehicle may be adversely affected.

Tire chains

wire-type



ONQ5065020N

fabric-type



ONQ5064012

Since the sidewalls of radial tires are thinner, they can be damaged by attaching some types of snow chains. Use of snow tires is recommended instead of snow chains. Do not attach tire chains to vehicles equipped with aluminum wheels; snow chains may cause damage to the wheels. If snow chains must be used, use fabric-type chains for 18/19-inch tires or wire-type chains for 17-inch tires with a thickness of less than 0.47 inches (12 mm).

Damage to your vehicle caused by improper snow chain use is not covered by your warranty.

When using tire chains, attach them to the drive wheels as follows.

* FWD/AWD: Front Wheel Drive

- FWD vehicles move the front wheel as a power source. Snow chains must be attached to the front tires.
- Chains must also be attached to the front tires only on AWD vehicles. Minimize the driving distance in order to prevent damage to the AWD system.
- After attaching snow chains, drive slowly. If you hear noise caused by chains contacting the vehicle, slow down until the noise stops and remove the chains as soon as you begin driving on cleared roads to prevent damage.
- Wrong sized chains or improperly installed chains can damage your vehicle's brake lines, suspension, body and wheels. When attaching snow chains, follow the manufacturer's instructions and attach them as tightly as possible. Drive slowly (less than 20 mph (30 km/h)) with chains installed.

CAUTION

- Make sure the snow chains are the correct size and type for your tires. Incorrect snow chains can cause damage to the vehicle body and suspension and may not be covered by your warranty. The snow chain connecting hooks may be damaged from contacting vehicle components causing the snow chains to come loose from the tire. Make sure the snow chains are SAE class "S" certified.
- Always check chain installation for proper attachment after driving approximately 0.3 to 0.6 miles (0.5 to 1 km) to ensure safe attaching. Retighten or reattach the chains if they are loose.
- Fabric-type chains must be used on the vehicle with 18/19-inch (235/60R18, 235/55R19) tires.

Use high quality ethylene glycol coolant

Your vehicle is delivered with high quality ethylene glycol coolant in the cooling system. It is the only type of coolant that should be used because it helps prevent corrosion in the cooling system, lubricates the water pump and prevents freezing. Be sure to replace or replenish your coolant in accordance with the maintenance schedule in section 8.

Before winter, have your coolant tested to ensure that its freezing point is sufficient for the temperatures anticipated during the winter.

Check battery and cables

Winter puts additional burdens on the battery system. Visually inspect the battery and cables as described in section 8. Have the level of charge in your battery checked by an authorized Kia dealer.

If the vehicle is not being used for a long time, park the vehicle indoors if possible.

Change to "winter weight" oil if necessary

In some climates it is recommended that a lower "winter weight" oil be used during cold weather. See "Recommended SAE viscosity number" on page 10-7. If you aren't sure what weight oil you should use, consult an authorized Kia dealer.

Check spark plugs and ignition system

Inspect your spark plugs as described in "Scheduled maintenance service" on page 9-8 and replace them if necessary. Check all ignition wiring and components to be sure they are not cracked, worn or damaged in any way.

To keep locks from freezing

To keep the locks from freezing, squirt an approved deicer fluid or glycerin into the key opening. If a lock is covered with ice, squirt it with an approved de-icing fluid to remove the ice. If the lock is frozen internally, you may be able to thaw it out by using a heated key. Handle the heated key with care to avoid injury.

Use approved window washer anti-freeze in system

To keep the water in the window washer system from freezing, add an approved window washer anti-freeze solution in accordance with instructions on the container. Window washer anti-freeze is available from an authorized Kia dealer and most auto parts outlets. Do not use engine coolant or other types of anti-freeze as these may damage the paint finish.

Don't let your parking brake freeze

Under some conditions your parking brake can freeze while in the engaged position. This is most likely to happen when there is an accumulation of snow or ice around or near the rear brakes or if the brakes are wet. If there is a risk that the parking brake may freeze, temporarily apply it with the gear in P (Park) and block the rear wheels in advance, so the vehicle may not roll. Then release the parking brake.

Don't let ice and snow accumulate underneath

Under some conditions, snow and ice can build up under the fenders and interfere with steering. When driving in severe winter conditions where this may happen, periodically check underneath the vehicle to be sure the movement of the front wheels and the steering components is not obstructed.

Carry emergency equipment

Depending on the severity of the weather, carry appropriate emergency equipment. Some items to carry include tire chains, tow straps or chains, flashlight, emergency flares, sand, shovel, jumper cables, window scraper, gloves, ground cloth, coveralls, blanket, etc.

Do not place objects or materials in the engine compartment

Putting objects or materials in the engine compartment may cause an engine failure or combustion, because they may block the engine cooling. Such damage will not be covered by your warranty.

Drive your vehicle when water vapor condenses and accumulates inside the exhaust pipes

When the vehicle is stopped for a long time in winter while the engine is running, water vapor may condense and accumulate inside the exhaust pipes. Water in the exhaust pipes may cause noise, etc., but is drained driving at medium to high speed.

Trailer towing (if equipped)

If you tow with your vehicle, first check with your country's Department of Motor Vehicles to determine their legal requirements.

Laws vary for towing trailers, cars, or other types of vehicles or apparatus may differ by state. Ask an authorized Kia dealer.

WARNING

Towing a trailer

If you don't use the correct equipment and drive improperly, you can lose control when you pull a trailer. For example, if the trailer is too heavy, the brakes may not perform well - or even at all. You and your passengers could be seriously or fatally injured. Pull a trailer only if you have followed all the steps in this section.

WARNING

Weight limits

Before towing, make sure the total trailer weight, gross combination weight, gross vehicle weight, gross axle weight and trailer tongue load are all within the limits.

NOTICE

- The technically permissible maximum load on the rear axle(s) may be exceeded by not more than 15 % and the technically permissible maximum laden mass of the vehicle may be exceeded by not more than 10% or 220.4 lbs. (100 kg), whichever value is lower. In this case, do not exceed 60 mph (100 km/h) for vehicles of category M1 or 50 mph (80 km/h) for vehicles of category N1.

- When towing a trailer, the additional load imposed at the trailer coupling device may cause the rear tire maximum load ratings to be exceeded, but not by more than 15%. Do not exceed 60 miles (100 km/h), and the rear tire pressure should be at least 0.2 bar (20 kPa) above the tire pressure(s) as recommended for normal use (i.e., without a trailer attached).

CAUTION

Pulling a trailer improperly can damage your vehicle and result in costly repairs not covered by your warranty. To pull a trailer correctly, follow the advice in this section.

Your vehicle can tow a trailer. To identify what the vehicle trailering capacity is for your vehicle, refer to "Weight of the trailer" on page 6-65 that appears later in this section.

Remember that trailering is different from just driving your vehicle by itself. Trailering means changes in handling, durability, and fuel economy. Successful, safe trailering requires correct equipment, and it must be used properly.

This section contains many time-tested, important trailering tips and safety rules. Many of these are important for your safety and that of your passengers. Please read this section carefully before you pull a trailer.

Load-pulling components such as the engine, transmission, wheel assemblies and tires are forced to work harder against the load of the added weight. The engine is required to operate at relatively higher speeds and under greater loads. This additional burden generates extra heat. The trailer also adds consid-

erable wind resistance, increasing pulling requirements.



ONQ5045046N

* NOTICE

Location of trailer mounting

The mounting holes for hitches are located on both sides of the underbody behind the rear tires.

Hitches

It's important to have the correct hitch equipment. Crosswinds, large trucks going by, and rough roads are examples of why the correct hitch is needed. Rules to follow:

- If you need to make any holes in the body of your vehicle when you install a trailer hitch, be sure to seal the holes later when you remove the hitch. If you don't seal them, deadly carbon monoxide (CO) from your exhaust, water and dirt can enter your vehicle.
- The bumpers on your vehicle are not intended for hitches. Do not attach rental hitches or other bumper-type hitches. Use only a frame-mounted hitch that does not attach to the bumper.
- Any part of the rear license plate or lighting devices of the vehicle must not be obscured by the mechanical

coupling device. The mechanical coupling device that is not in use should always be removed or repositioned if the rear license plate and/or rear lighting devices are obscured.

If the rear license plate or lighting devices are partially obscured by the mechanical coupling device, and the device cannot be easily removed or repositioned without use of any tools, except an easily operated (i.e. an effort not exceeding 20Nm) release key which is supplied by the manufacturer of the coupling device, are not permitted for use.

Please note that the mechanical coupling device that is fitted and not in use must always be removed or repositioned if the rear number plate and/or rear lighting devices are obscured by any part of the mechanical coupling device.

- A Kia trailer hitch accessories are available at an authorized Kia dealer.

Safety chains

You should always attach chains between your vehicle and your trailer. Cross the safety chains under the tongue of the trailer so that the tongue will not drop to the road if it becomes separated from the hitch.

Instructions about safety chains may be provided by the hitch manufacturer or by the trailer manufacturer. Follow the manufacturer's recommendation for attaching safety chains. Always leave just enough slack so you can turn with your trailer. Never allow safety chains to drag on the ground.

Trailer brakes

If your trailer is equipped with a braking system, make sure it conforms to your state's regulations and that it is properly installed and operating correctly.

If your trailer weighs more than the maximum trailer weight without trailer brakes loaded, it needs its own adequate brakes. Read and follow the instructions for the trailer brakes so you'll be able to install, adjust and maintain them properly.

- Don't tap into your vehicle's brake system.

WARNING

Trailer brakes

Do not use a trailer with its own brakes unless you are absolutely certain that you have properly set up the brake system. This is not a task for amateurs. Use an experienced, competent trailer shop for the setup.

Driving with a trailer

Towing a trailer requires a certain amount of experience. Before driving on the open road, you must get to know your trailer. Acquaint yourself with the feel of handling and braking with the added weight of the trailer. Keep in mind that the vehicle you are driving is longer and not nearly as responsive as your vehicle without one.

Before you drive, check the trailer hitch and platform, safety chains, electrical connector(s), lights, tires and mirror adjustments. If the trailer has electric brakes, move your vehicle and trailer moving and then apply the trailer brake controller by hand to ensure the brakes are working. This also checks the electrical connection at the same time.

During your trip, check to ensure that the load is secure, and that the lights and trailer brakes are still working.

Following distance

Stay at least twice as far behind the vehicle ahead as you would when driving your vehicle without a trailer. This can help you avoid situations that require heavy braking and sudden turns.

Passing

You'll need more passing distance when you're towing a trailer. Because of the increased vehicle length, drive much farther beyond the passed vehicle before you can return to your lane.

Backing up

Hold the bottom of the steering wheel with one hand. To move the trailer to the left, just move your hand to the left. To move the trailer to the right, move your hand to the right. Always back up slowly and, have someone guide you.

Making turns

When you're turning with a trailer, make wider turns than normal. Do this so your trailer won't strike soft shoulders, curbs, road signs, trees or other objects. Avoid jerky or sudden maneuvers. Signal well in advance.

Turn signals when towing a trailer

When towing a trailer, your vehicle has different turn signal flashers and extra wiring. The green arrows on your instrument panel will flash whenever you signal a turn or lane change. Properly

connected, the trailer lights will also flash to alert other drivers when you're about to turn, change lanes, or stop. When towing a trailer, the green arrows on your instrument panel will flash for turns even if the bulbs on the trailer are burned out. You may think driver's behind you are seeing your signals when, in fact, they are not. It's important to check occasionally to be sure the trailer bulbs are still working. Check the lights every time you disconnect and then reconnect the wires.

Do not connect a trailer lighting system directly to your vehicle's lighting system. Use only an approved trailer wiring harness.

Have an authorized Kia dealer install a wiring harness.

Visit an authorized Kia dealer.

⚠ WARNING

Failure to use an approved trailer wiring harness could result in damage to the vehicle's electrical system and/or cause personal injury.

Detection of trailer light connection

This function only given with genuine Kia accessories (tow bar and wiring harness) that recognize when a trailer is connected and consequently communicates with vehicle systems. Trailer recognition works as follows: when a trailer socket is plugged in, either depress the brake pedal or activate the turn signal so that the control unit will be able to detect that there is no power to the trailer lighting; the assistance systems that were turned off will automatically turn on again.

It is your responsibility to ensure that all electrical connections are working, and all trailer lights are operating before and during towing. You must perform manual checks.

⚠ CAUTION

Use only genuine Kia electrical connections. Do not attempt to arbitrarily splice or directly connect the trailer wiring using any other method. This may damage the vehicle's electrical system, resulting in malfunctions

Driving on grades

Reduce the speed and shift to a lower gear before you start down a long or steep downgrade. If you don't down shift, you might have to use your brakes so much that they will get hot and no longer operate efficiently.

On a long uphill grade, downshift and reduce your speed to around 45 mph (70 km/h) to reduce the possibility of engine and transmission overheating.

⚠ CAUTION

- When towing a trailer on steep grades (in excess of 6%) pay close attention to the engine coolant temperature gauge to ensure the engine does not overheat. If the needle of the coolant temperature gauge moves across the dial towards "H (HOT) (or 260 °F/130 °C)", pull over and stop as soon as it is safe to do so, and allow the engine to idle until it cools down. You may proceed once the engine has cooled sufficiently.
- Drive at a speed depending on trailer weight and uphill grade to reduce the

possibility of engine and transmission overheating.

Parking on hills

If a trailer is attached to your vehicle, do not park your vehicle on a hill. People can be seriously or fatally injured, and both your vehicle and the trailer can be damaged if unexpectedly rolls downhill.

WARNING

Parking on a hill

Parking your vehicle on a hill with a trailer attached could cause serious injury or death if, the trailer breaks loose.

However, if you ever must park your trailer on a hill, follow these procedures:

1. Pull the vehicle into the parking space. Turn the steering wheel in the direction of the curb (right if headed downhill, left if headed up hill).
2. Set the parking brake and shut off the vehicle.
3. Place chocks under the trailer wheels on the downhill side of the wheels.
4. Start the vehicle, hold the brakes, shift to neutral, release the parking brake and slowly release the brakes until the trailer chocks absorb the load.
5. Reapply the brakes and, parking brake.
6. Shut off the vehicle and release the vehicle brakes but leave the parking brake set.

WARNING

Parking brake

It can be dangerous to exit your vehicle if the parking brake is not firmly set.

If you have left the engine running, the vehicle can move suddenly. You or others could be seriously or fatally injured.

When you are ready to exit after parking on a hill

1. Apply your brakes and hold the brake pedal down while you:
 - Start your engine;
 - Shift into gear; and
 - Release the parking brake.
2. Slowly remove your foot from the brake pedal.
3. Drive slowly until the trailer is clear of the chocks.
4. Stop and have someone pick up and store the chocks.

Maintenance when trailer towing

Your vehicle will need service more often when you regularly pull a trailer. Be sure to check engine oil, axle lubricant, cooling system fluid and brake condition. Each item is covered in this manual, and the Index will help you find them quickly. If you're trailering, it's a good idea to review these sections before you start your trip.

Maintain your trailer and hitch. Follow the maintenance schedule that accompanied your trailer and check it periodically. Conduct the check at the start of each day's driving. All hitch nuts and bolts should be tight.

CAUTION

- Due to higher load during trailer usage, overheating might occur on hot days or while uphill driving. If the coolant gauge indicates overheating, switch off the A/C and stop the vehi-

cle in a safe area to cool down the engine.

- When towing, check the transmission fluid more frequently.
- If your vehicle is not equipped with an air conditioner, you should install a condenser fan to improve engine performance when towing a trailer.

If you decide to pull a trailer

Important points if you decide to pull a trailer:

- Consider using a sway control. You can ask a hitch dealer about sway control.
- Do not tow with your vehicle during its first 1,200 miles (2,000 km) in order to allow the engine to properly break in. Failure to heed this caution may result in serious engine or transmission damage.
- When towing a trailer, consult an authorized Kia dealer for additional requirements such as a towing kit, etc.
- Always drive your vehicle at a moderate speed (less than 60 mph (100 km/h)).
- On a long uphill grade, do not exceed 45 mph (70 km/h) or the posted towing speed limit, whichever is lower.
- The chart contains important considerations regarding weight: For more details, refer to "Reference weight and distance when towing a trailer" on page 10-3.

Weight of the trailer

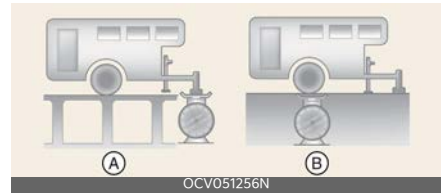

A: Tongue Load

B: Total Trailer Weight

The maximum safe weight of a trailer should never exceed the maximum trailer weight with trailer brakes. Even that may be too heavy.

Weight depends on how you plan to use your trailer. For example, speed, altitude, road grades, outside temperature and how often your vehicle is used to pull a trailer are all important. The ideal trailer weight can also depend on any special equipment that you have on your vehicle.

Weight of the trailer tongue



A: Gross Axle Weight

B: Gross Vehicle Weight (GVW)

The tongue load of any trailer is an important weight because it affects the total GVW of your vehicle. This weight includes the curb weight of the vehicle, any cargo you may carry in it, and the people who will be riding in the vehicle. If you tow a trailer, you must add the tongue load to the GVW because your vehicle will also be carrying that weight.

The trailer tongue should weigh a maximum of 10% of the total loaded trailer weight, within the limits of the maximum trailer tongue load permissible.

After loading your trailer, weigh the trailer and then the tongue, separately, to see if the weights are proper. If they aren't, you may be able to correct them simply by moving some items around in the trailer.

⚠ WARNING

Trailer

- Never load a trailer with more weight in the rear than in the front. The front should be loaded with approximately 60% of the total trailer load; the rear should be loaded with approximately 40% of the total trailer load.
- Never exceed the maximum weight limit of the trailer or trailer towing equipment. Improper loading can result in damage to your vehicle and/or personal injury. Check weights and loading at a commercial scale or highway patrol office equipped with scales.
- An improperly loaded trailer can cause loss of vehicle control.

Vehicle load limit

The vehicle load limit is displayed on the tire and loading information label on the driver's door.

Tire and loading information label

The label located on the driver's door sill gives the original tire size, cold tire pressures recommended for your vehicle, the number of people that can be in your vehicle and vehicle capacity weight.

Example for spare tire or TMK

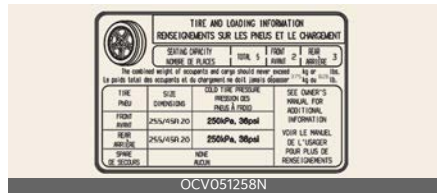

Vehicle capacity weight:

- 5 seats: 926 lbs. (420 kg)

Vehicle capacity weight is the maximum combined weight of occupants and cargo. If your vehicle is equipped with a trailer, the maximum combined weight includes the tongue load.

Seating capacity:

Total: 5 persons (Front seat: 2 persons, Rear seat: 3 persons)
Seating capacity is the maximum number of occupants that your vehicle may carry.

The seating capacity may be reduced based upon the combined weight of all of the occupants, and the weight of the cargo being carried or towed.

Do not overload the vehicle as there is a limit to the total weight that, the vehicle can carry.

Towing capacity:

Smartstream G1.6 T-GDi HEV/
PHEV

- With brake system: 2,000 lbs. (907 kg)
- Without brake system: 1,653 lbs. (750 kg)

Cargo capacity:

The cargo capacity of your vehicle will increase or decrease depending on the weight and the number of occupants.

Steps For Determining Correct Load Limit—

1. Locate the statement "The combined weight of occupants and cargo should never exceed XXX kg or XXX lbs." on your vehicle's placard.
2. Determine the combined weight of the driver and passengers that will be riding in your vehicle.
3. Subtract the combined weight of the driver and passengers from XXX kg or XXX lbs.
4. The resulting figure equals the available amount of cargo and luggage load capacity. For example, if the "XXX" amount equals 1400 lbs. and there will be five 150 lbs passengers in your vehicle, the amount of available cargo and luggage load capacity is 650 lbs. $(1400 - 750 (5 \times 150) = 650 \text{ lbs.})$
5. Determine the combined weight of luggage and cargo being loaded on the vehicle. That weight may not safely exceed the available cargo and luggage load capacity calculated in Step 4.
6. If your vehicle will be towing a trailer, load from your trailer will be transferred to your vehicle. Consult this manual to determine how this reduces the available cargo and lug-

gage load capacity of your vehicle.

⚠ WARNING

Loose cargo

Do not travel with unsecured blunt objects in the passenger compartment of your vehicle (e.g., suitcases cases or unsecured child seats). These items may strike an occupant during a sudden stop or accident.

Example 1



Item	Description	Total
A	Vehicle Capacity Weight	849 lbs. (385 kg)
B	Subtract Occupant Weight 150 lbs. (68 kg)×2	300 lbs. (136 kg)
C	Available Cargo and Luggage weight	549 lbs. (249 kg)

Example 2

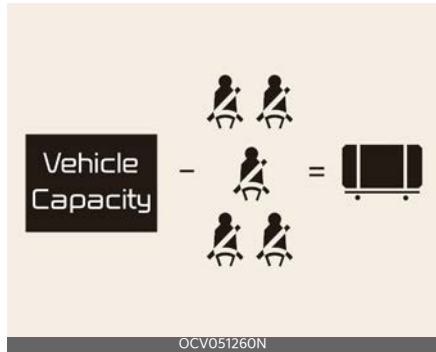

Item	Description	Total
A	Vehicle Capacity Weight	849 lbs. (385 kg)
B	Subtract Occupant Weight 150 lbs. (68 kg)×5	750 lbs. (340 kg)
C	Available Cargo and Luggage weight	99 lbs. (45 kg)

Example 3

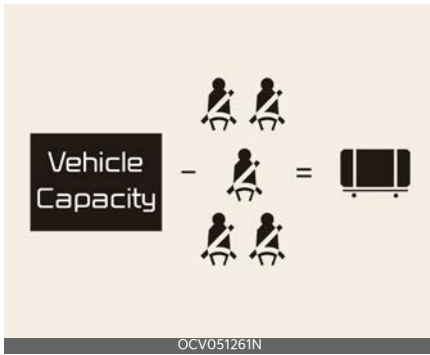

Item	Description	Total
A	Vehicle Capacity Weight	849 lbs. (385 kg)
B	Subtract Occupant Weight 161 lbs. (73 kg)×5	805 lbs. (365 kg)
C	Available Cargo and Luggage weight	44 lbs. (20 kg)

Refer to your vehicle's tire and loading information label for specific information about your vehicle's capacity weight and seating positions. The combined weight of the driver, passengers and cargo should never exceed your vehicle's weight capacity.

Certification label

The certification label is located on the driver's door sill at the center pillar.



This label shows the maximum allowable weight of the fully loaded vehicle. This is called the GVWR (Gross Vehicle Weight Rating). The GVWR includes the weight of the vehicle, all occupants and cargo.

This label also shows the maximum weight that can be supported by the front and rear axles, called Gross Axle Weight Rating (GAWR).

To determine the actual loads on your front and rear axles, you need to go to a weigh station and weigh your vehicle. Your dealer can help you with this. Be sure to spread out your load equally on both sides of the centerline.

⚠ WARNING

Over loading

Never exceed the GVWR for your vehicle, the GAWR for either the front or rear axle and vehicle capacity weight. Exceeding these

ratings can affect your vehicle's handling and braking ability.

The label will help you determine how much cargo and installed equipment your vehicle can carry.

If you carry items inside your vehicle - like suitcases, tools, packages, or anything else - they move as fast as the vehicle. If you must stop or turn quickly, or if there is a collision, the items will keep moving and can cause an injury if they strike the driver or a passenger.

WARNING

Over loading

Do not overload your vehicle. Overloading your vehicle can cause heat buildup in your vehicle's tires and possible tire failure, increased stopping distances and poor vehicle handling--all of which may result in an accident.

NOTICE

Overloading your vehicle may cause damage. Repairs are not be covered by your warranty. Do not overload your vehicle.

Vehicle weight

This section will guide you in the proper loading of your vehicle, to keep your loaded vehicle weight within its design rating capability. Properly loading your vehicle will provide maximum vehicle performance. Before loading your vehicle, familiarize yourself with the following terms for determining your vehicle's weight ratings, from the vehicle's specifications and the certification label:

Base curb weight

This is the weight of the vehicle including a full tank of fuel and all standard equipment. It does not include passengers, cargo or optional equipment.

Vehicle curb weight

This is the weight of your new vehicle when purchased plus any installed aftermarket equipment.

Cargo weight

This figure includes all weight added to the Base Curb Weight, including cargo and optional equipment.

Gross axle weight (GAW)

This is the total weight placed on each axle (front and rear) - including vehicle curb weight and all payloads.

Gross axle weight rating (GAWR)

This is the maximum allowable weight that can be carried by a single axle (front or rear). These weight are shown on the certification label.

The total load on each axle must never exceed the GAWR.

Gross vehicle weight (GVW)

This is the Base Curb Weight plus actual Cargo Weight plus passengers.

Gross vehicle weight rating (GVWR)

This is the maximum allowable weight of the fully loaded vehicle (including all options, equipment, passengers and cargo). The GVWR is shown on the certification label located on the driver's (or front passenger's) door sill.

Overloading

⚠ WARNING

The GAWR and the GVWR for your vehicle are on the Certification Label attached to the driver's (or front passenger's) door. Exceeding these ratings can cause an accident or vehicle damage. You can calculate the weight of your load by weighing the items (and people) before putting them in the vehicle. Be careful not to overload your vehicle

Forward Collision-Avoidance Assist (FCA) (Sensor Fusion)....	7-5
• Forward Collision-Avoidance Assist settings	7-8
• Forward Collision-Avoidance Assist operation	7-10
• Forward Collision-Avoidance Assist malfunction and limitations.....	7-20
Lane Keeping Assist (LKA)	7-27
• Lane Keeping Assist settings	7-28
• Lane Keeping Assist operation.....	7-29
• Lane Keeping Assist malfunction and limitations.....	7-31
Blind-Spot Collision-Avoidance Assist (BCA)	7-33
• Blind-Spot Collision-Avoidance Assist settings.....	7-34
• Blind-Spot Collision-Avoidance Assist operation	7-36
• Blind-Spot Collision-Avoidance Assist malfunction and limitations.....	7-38
Safe Exit Warning (SEW)	7-42
• Safe Exit Warning settings	7-42
• Safe Exit Warning operation	7-43
• Safe Exit Warning malfunction and limitations	7-44
Manual Speed Limit Assist (MSLA)	7-46
• Manual Speed Limit Assist operation.....	7-46
Intelligent Speed Limit Assist (ISLA).....	7-48
• Intelligent Speed Limit Assist settings.....	7-48
• Intelligent Speed Limit Assist operation.....	7-49
• Intelligent Speed Limit Assist malfunction and limitations.....	7-51
Driver Attention Warning (DAW)	7-53
• Driver Attention Warning settings	7-53
• Warning Methods.....	7-53
• Driver Attention Warning operation	7-54
• Driver Attention Warning malfunction and limitations.....	7-55
Forward Attention Warning (FAW).....	7-57

7 Driver assistance system

- Forward Attention Warning settings 7-57
- Forward Attention Warning operation..... 7-58
- Forward Attention Warning malfunction and limitations..... 7-59
- Blind-Spot View Monitor (BVM) 7-61**
 - Blind-Spot View Monitor settings 7-61
 - Blind-Spot View Monitor operation..... 7-61
 - Blind-Spot View Monitor malfunction..... 7-62
- Smart Cruise Control (SCC) 7-62**
 - Smart Cruise Control settings 7-63
 - Smart Cruise Control operation..... 7-64
 - Smart Cruise Control malfunction and limitations..... 7-72
- Emergency Stop (ES) 7-77**
 - Detecting sensor 7-77
 - Emergency Stop operation..... 7-77
 - Emergency Stop malfunction and limitation 7-79
- Navigation-based Smart Cruise Control (NSCC) 7-79**
 - Navigation-based Smart Cruise Control settings 7-80
 - Navigation-based Smart Cruise Control operation 7-80
 - Navigation-based Smart Cruise Control limitations 7-81
 - This device complies with Part 15 of the FCC rules..... 7-84
 - Radio frequency radiation exposure information: 7-84
- Lane Following Assist (LFA) 7-84**
 - Lane Following Assist settings 7-85
 - Lane Following Assist operation..... 7-85
 - Lane Following Assist malfunction and limitations..... 7-87
- Highway Driving Assist (HDA) 7-88**
 - Highway Driving Assist settings 7-89
 - Highway Driving Assist operation 7-90
 - Highway Driving Assist malfunction and limitations..... 7-95
 - This device complies with Part 15 of the FCC rules..... 7-97
 - Radio frequency radiation exposure information: 7-97

Rear View Monitor (RVM)	7-97
• Rear View Monitor settings.....	7-97
• Rear View Monitor operation.....	7-98
• Rear View Monitor malfunction and limitations.....	7-100
Surround View Monitor (SVM)	7-101
• Surround View Monitor settings.....	7-101
• Surround View Monitor operation.....	7-103
• Surround View Monitor malfunction and limitations.....	7-106
Rear Cross-Traffic Collision-Avoidance Assist (RCCA)	7-107
• Rear Cross-Traffic Collision-Avoidance Assist settings.....	7-107
• Rear Cross-Traffic Collision-Avoidance Assist operation.....	7-108
• Rear Cross-Traffic Collision-Avoidance Assist malfunction and limitations.....	7-111
Forward/Reverse Parking Distance Warning (PDW)	7-115
• Forward/Reverse Parking Distance Warning settings.....	7-115
• Forward/Reverse Parking Distance Warning operation.....	7-116
• Forward/Reverse Parking Distance Warning malfunction and precautions	7-118
Forward/Side/Reverse Parking Distance Warning (PDW) ..	7-120
• Forward/Side/Reverse Parking Distance Warning settings.....	7-120
• Forward/Side/Reverse Parking Distance Warning operation ...	7-121
• Forward/Side/Reverse Parking Distance Warning malfunction and precautions	7-123
Reverse Parking Collision-Avoidance Assist (PCA)	7-126
• Reverse Parking Collision-Avoidance Assist settings	7-126
• Parking Safety	7-126
• Reverse Parking Collision-Avoidance Assist operation.....	7-127
• Reverse Parking Collision-Avoidance Assist malfunction and limitations.....	7-128
Remote Smart Parking Assist (RSPA)	7-132
• Remote Smart Parking Assist settings	7-133

7 Driver assistance system

- Remote Smart Parking Assist operation.....7-134
 - Remote Smart Parking Assist malfunction and limitations.....7-139
- Declaration of conformity7-143**

Driver assistance system

* INFORMATION

The description of the driver assistance system displayed on the screen may differ from the content of the owner's manual depending on the infotainment software version.

Forward Collision-Avoidance Assist (FCA) (Sensor Fusion)

Basic function



Forward Collision-Avoidance Assist detects a vehicle, a powered two-wheeler, a pedestrian, or a cyclist ahead on the road and may warn you of a possible collision with a warning message on the instrument cluster, a warning sound and vibration of the steering wheel.

Forward Collision-Avoidance Assist will detect vehicles ahead and adjacent lanes even at high speeds. If the driver makes a lane change at those speeds, your vehicle will apply emergency braking to mitigate or avoid a collision. (if equipped)

Junction Turning function

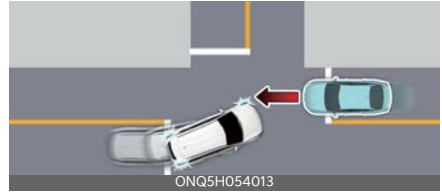

Junction Turning function will help avoid a collision with an oncoming vehicle in an adjacent lane when turning left at a crossroad with the turn signal on by applying emergency braking.

Junction Crossing function (if equipped)

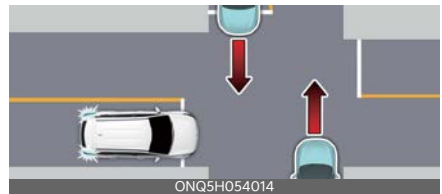

The Junction Crossing function can help mitigate or avoid a collision with oncoming vehicles on the left or right when crossing an intersection by applying emergency braking.

Direct Oncoming Vehicle function

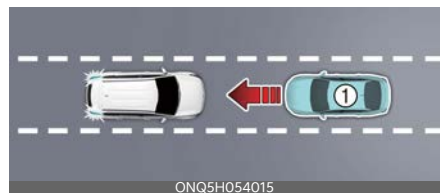

[1]: Oncoming vehicle

The Direct Oncoming Vehicle function can help reduce the speed at the collision when with a vehicle or powered

two-wheeler approaching from the opposite direction is detected.

Lane-Change Oncoming function (if equipped)



[1]: Oncoming vehicle

Lane-Change Oncoming function can help mitigate or avoid a collision with oncoming vehicles or powered two-wheelers when changing lanes by assisting the driver's steering.

Lane-Change Side function (if equipped)

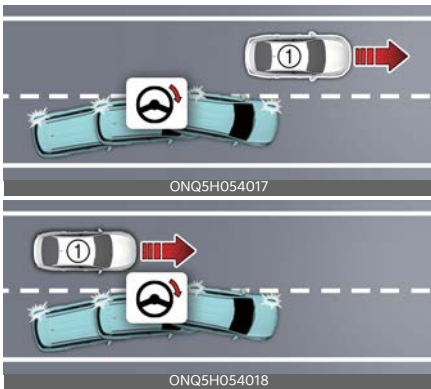

[1]: Approaching car from side

Lane-Change Side function can help mitigate or avoid a collision with vehicles or powered two-wheelers in the next lane when changing lanes by assisting the driver's steering.

Evasive Steering Assist function (if equipped)



- Driver steering assist
If a possible collision with a vehicle ahead, pedestrian, cyclist, and powered two-wheeler is detected and you steer to avoid the collision, Evasive Steering Assist can assist the driver in steering.
- Evasive steering assist
The Evasive Steering Assist function can help mitigate or avoid a collision with a vehicle, pedestrian cyclist, etc. in the same lane in front of you. When a risk of collision is detected, Evasive Steering Assist function can warn you and assist your steering if you move the steering wheel.

Detecting sensor

Front camera



Front radar



Front corner radar (if equipped)



Rear corner radar (if equipped)



Refer to the picture above for the detailed location of the detecting sensors.

CAUTION

- Never disassemble the detecting sensor or sensor assembly, or cause any damage to it.
- If the detecting sensors have been replaced or repaired, have your Kia

inspected by an authorized Kia dealer as soon as possible.

- If the radar or around the radar experiences an impact, Forward Collision-Avoidance Assist may not operate properly even if a warning message is not displayed on the cluster. Visit an authorized Kia dealer.
- Never install any accessories or stickers on the windshield or tint the windshield.
- Pay extreme caution to keep the front view camera dry.
- Never place any reflective objects (for example, white paper, mirror) over the instrument panel.
- Do not place any objects near the front windshield or install any accessories on the front windshield. It can affect the performance of the defogging and defrosting function of the climate control system, which may prevent the Driver Assistance systems from operating.
- Do not apply license plate frame or objects, such as a bumper sticker, film or a bumper guard, near the front radar cover.
- Always keep the front radar and cover clean and free of dirt and debris. Use only a soft cloth to wash the vehicle. Do not spray pressurized water directly on a sensor or sensor cover.
- The genuine Kia front/front corner/rear corner radar sensor covers are parts with quality and performance ensured. If arbitrarily applying paint on or changing the cover, Forward Collision-Avoidance Assist may not function properly. Use only Kia Genuine Parts or those of an equivalent standard with proven

quality and performance to repair or replace the radar sensor covers.

- The function may not work properly when the bumper has been replaced, or the surroundings of the front corner radar or rear corner radar has been damaged or paint has been applied.
- If a trailer, carrier, etc. is installed, it may adversely affect the performance of Forward Collision-Avoidance Assist may not operate properly.

Forward Collision-Avoidance Assist settings

Forward Safety



- 1 Driver Assistance
- 2 Driving Safety
- 3 Forward Safety

With the vehicle on, select **Setup** → **Vehicle** → **Driver Assistance** → **Driving Safety** on the infotainment system. The initial warning activation timing of Forward Collision-Avoidance Assist can be changed.

- **Forward safety:** Collision warning or emergency braking may operate in a collision-imminent situation. If you deselect the setting, Forward safety will turn off and the Forward Safety warning light (🚗) will appear on the cluster.

Forward Cross-Traffic Safety (if equipped)



- 1 Driver Assistance
 - 2 Driving Safety
 - 3 Forward Cross-Traffic Safety
- With the vehicle on, select **Setup** → **Vehicle** → **Driver Assistance** → **Driving Safety** → **Forward Cross-Traffic Safety** from the infotainment system screen to turn on Junction Crossing function and deselect to turn off the function.

Forward/Side Safety (if equipped)

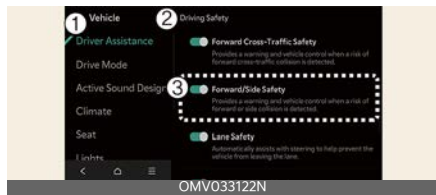

- 1 Driver Assistance
 - 2 Driving Safety
 - 3 Forward/Side Safety
- With the vehicle on, select **Setup** → **Vehicle** → **Driver Assistance** → **Driving Safety** → **Forward/Side Safety** on the infotainment system.

- **Forward/Side Safety:** Collision warning or emergency steering may assist the driver in a collision-imminent situation. If you deselect the setting, Forward safety will turn off and the Emergency steering warning light (🚗) will appear on the cluster.

The driver can monitor Forward Collision-Avoidance Assist On/Off status from the Settings menu. If the Forward Safety warning light (🚗) or Emergency steering warning light (🚗) remains ON when Forward safety or Forward/side safety is selected, have your Kia inspected by an authorized Kia dealer as soon as possible.

⚠️ WARNING

When the vehicle is restarted, Forward Collision-Avoidance Assist will always turn on. However, if **Forward safety**, **Forward Cross-Traffic Safety**, or **Forward/Side Safety** is deselected, the driver should always be aware of the surroundings and drive safely.

⚠️ CAUTION

- **Forward safety** settings include 'Basic function', 'Junction Turning function', and 'Direct Oncoming function'. **Forward Cross-Traffic Safety** include 'Junction Crossing function' (if equipped), **Forward/Side Cross-Traffic Safety** includes 'Lane change oncoming function', 'Lane change side function' and 'Evasive Steering Assist function'. (if equipped)
- If **Forward safety** is set to Off 'Junction Crossing function' (if equipped) will not operate even if **Forward Cross Traffic Safety** and **Forward/Side Cross Traffic Safety** are selected.
- When the vehicle and the trailer are connected electrically, Forward/Side Safety automatically turns off. In this case, you cannot get help from Forward/Side Safety. Always drive with care. (if Kia genuine part equipped)

Forward Safety Warning Timing



1 Driver Assistance

2 Driving Safety

3 Forward Safety Warning Timing

With the vehicle on, select **Setup** → **Vehicle** → **Driver Assistance** → **Driving Safety** → **Forward Safety Warning Timing** on the infotainment system to change the initial warning activation timing of Forward Collision-Avoidance Assist.

- Use **Standard** in normal driving conditions. If the Warning Timing seems sensitive, change it to **Late**.
- If **Late** is selected, Forward Collision-Avoidance Assist, warns the driver more slowly.

⚠️ CAUTION

- Even though **Standard** is selected for Warning Timing, if the front vehicle suddenly stops, the warning may seem delayed.
- Select **Later** for Warning Timing when traffic is light and when driving speed is slow.

* INFORMATION

- **Forward/side safety** does not provide the warning timing setting.
- The warning timing you have set will be maintained even if the vehicle is restarted.

Warning Methods

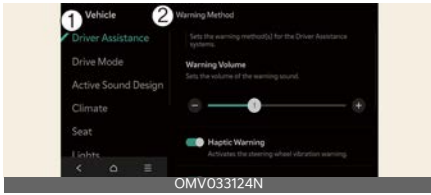

1 Driver Assistance

2 Warning Methods

Your vehicle may allow you to change the **Warning Methods** setting. To do so, select **Setup** → **Vehicle** → **Driver Assistance** → **Warning Methods** in the infotainment system to change the following settings:

- **Warning Volume:** Adjusts the volume of the warning sound.
- **Haptic Warning:** Activate the steering wheel vibration warning.
- **Driving Safety Priority:** Lowers all other audio volumes when the Driving Safety system sounds a warning.

* NOTICE

- Ensure that **Warning Methods** you have set may apply to the **Warning Methods** of other driver assistance systems.
- **The Warning Methods** will maintain their last settings when the vehicle is restarted.
- The setting menu may not be available for your vehicle depending on the vehicle features and specifications.

Forward Collision-Avoidance Assist operation

Basic function

Warning and control

The basic function for Forward Collision-Avoidance Assist is warned and controlled in the following way.

- Collision warning
- Emergency braking
- Stopping vehicle and ending brake control

Collision Warning



A: Collision Warning

Collision Warning can alert the driver with the Forward Safety warning light blinking (🚨), warning message, an audible warning and steering wheel vibration.

The collision warning operates under the following vehicle speed conditions, depending on the vehicle in front.

- Vehicle or powered two-wheeler: 6-124 mph (10-200 km/h)
- Pedestrian or cyclist: 6-53 mph (10-85 km/h)

Emergency Braking

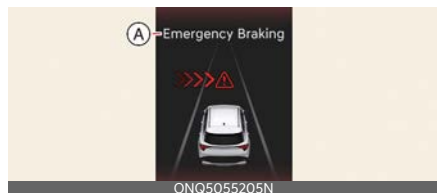

A: Emergency Braking

If Emergency braking recognizes a hazard, it will alert the driver with the Forward Safety warning light blinking (🚨), warning message, an audible warning and steering wheel vibration.

The brake assist will be activated to help avoid a collision with a vehicle, pedestrian, cyclist and powered two-wheeler.

Emergency braking will be activated according to oncoming objects and danger levels in the following conditions.

- Vehicle or powered two-wheeler:

-	Driving target	Stopped target
Weak braking power	6-124 mph (10-200 km/h)	
Strong braking power	6-80 mph (10-130 km/h)	6-53 mph (10-85 km/h) (6-62 mph (10-100 km/h)*

*: If Forward Collision Avoidance Assist judges that avoiding a collision is difficult even by changing the driving lane due to surroundings of the vehicle, The function operate earlier. (if equipped)

- Pedestrian or cyclist: 6-40 mph (10-65 km/h)

⚠ CAUTION

- The function operation range may decrease due to the front traffic condition or the surroundings of the vehicle.
- When driving at night, the performance of powered two-wheeler recognition is decreased, so the Forward Collision-Avoidance Assist system may be temporarily limited or may not work.

Stopping vehicle and ending brake control



A: Drive carefully

When the vehicle is stopped due to emergency braking, a warning message will appear on the cluster.

For your safety, the driver should depress the brake pedal immediately and check the surroundings.

- Brake control will end after the vehicle is stopped by emergency braking for approximately 2 seconds.

Junction Turning function

Warning and control

The Junction turning function is warned and controlled in the following way.

- Collision Warning
- Emergency Braking
- Stopping vehicle and ending brake control

Collision Warning

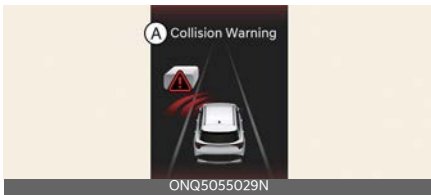

A: Collision Warning

Collision Warning can alert the driver with the Forward Safety warning light blinking (🚨), warning message, an audible warning and steering wheel vibration.

Collision warning will be activated in the following conditions:

- Your driving speed: Approximately 6-19 mph (10-30 km/h)
- Oncoming vehicle speed: Approximately 19-44 mph (30-70 km/h)
- Powered two-wheeler and cyclist speed: Approximately 9-44 mph (15-70 km/h)

Emergency Braking

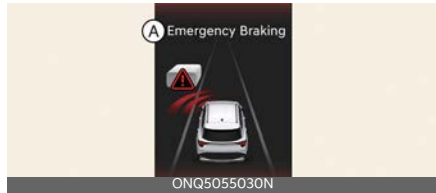

A: Emergency Braking

Emergency braking can alert the driver with the Forward Safety warning light blinking (🚨), warning message, an audible warning and steering wheel vibration. The brake assist can be activated and to help avoid a collision with an oncoming vehicle, pedestrian, cyclist and powered two-wheeler.

Emergency braking will be activated in the following conditions.

- Your driving speed: 6-19 mph (10-30 km/h)
- Oncoming vehicle speed: Approximately 19-44 mph (30-70 km/h)
- Powered two-wheeler and cyclist speed: Approximately 9-44 mph (15-70 km/h)

Stopping vehicle and ending brake control

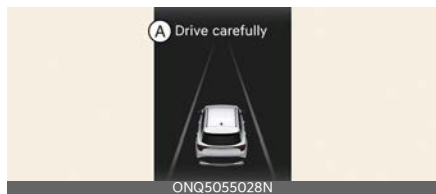

A: Drive carefully

When the vehicle is stopped due to emergency braking, a warning message will appear on the cluster.

For your safety, the driver should depress the brake pedal immediately and check the surroundings.

- Brake control will end after the vehicle is stopped by emergency braking for approximately 2 seconds.

* NOTICE

When turning right at an intersection, braking is assisted to reduce or avoid collisions if there is a collision risk with a cyclist approaching at the speed of 6 to 12 mph (10 to 20 km/h) from the opposite side.

Direct Oncoming function

Warning and control

The Direct Oncoming function is warned and controlled in the following way.

- Collision Warning
- Emergency Braking
- Stopping vehicle and ending brake control

Collision Warning

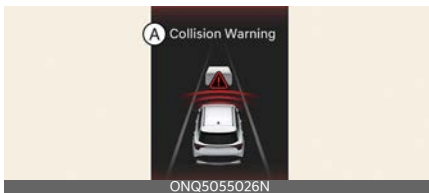

A: Collision Warning

Collision warning can alert the driver with a forward safety warning light blinking (🚨), warning message, an audible warning and steering wheel vibration.

Collision Warning will be activated in following conditions.

- Your driving speed: Approximately 19-80 mph (30-130 km/h)
- Oncoming vehicle or powered two-wheeler speed: Approximately above 6 mph (10 km/h)

Emergency braking

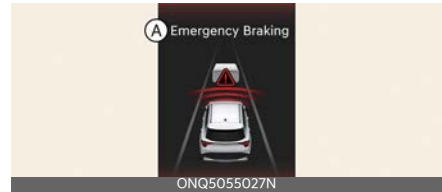

A: Emergency Braking

Emergency braking can alert the driver with a forward safety warning light blinking (🚨), warning message, an audible warning and steering wheel vibration.

Emergency braking will be activated in following conditions.

- Your driving speed: Approximately 6-80 mph (10-130 km/h)
- Oncoming vehicle or powered two-wheeler speed: Approximately above 6 mph (10 km/h)

Stopping vehicle and ending brake control

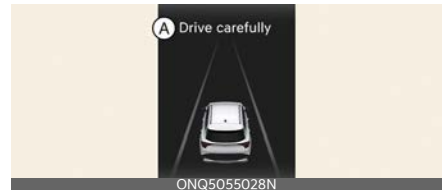

A: Drive carefully

When the vehicle is stopped due to emergency braking, a warning message will appear on the cluster.

For your safety, the driver should depress the brake pedal immediately and check the surroundings.

- Brake control will end after the vehicle is stopped by emergency braking for approximately 2 seconds

CAUTION

- If your vehicle or the oncoming vehicle is not driving straight, Front Oncoming function warning and control may be delayed or may not operate.
- When driving at night, the performance of the powered two-wheeler recognition is decreased, so the Forward Collision-Avoidance Assist system may be temporarily limited or may not work.

Junction Crossing function (if equipped)

Warning and control

The Junction Crossing function is warned and controlled by the following level.

- Collision Warning
- Emergency Braking
- Stopping vehicle and ending brake control

Collision Warning



A: Collision Warning

Collision Warning can alert the driver with the Forward Safety warning light blinking (⚠️), warning message, an audible warning and steering wheel vibration.

Forward collision warning will be activated in the following conditions.

- Your driving speed: Approximately 6-34 mph (10-55 km/h)

- Crossing vehicle speed: Approximately 6-37 mph (10-60 km/h)

Emergency Braking



A: Emergency Braking

The Forward Safety warning light blinking (⚠️), warning message, an audible warning and the steering wheel vibration that emergency braking will be assisted. The brake assist can be activated and help mitigate or avoid a collision with a vehicle, pedestrian cyclist, or powered two-wheeler.

Emergency braking will be activated in the following conditions.

- Your driving speed: Approximately 6-34 mph (10-55 km/h)
- Crossing vehicle speed: Approximately 6-25 mph (10-40 km/h)

Stopping vehicle and ending brake control

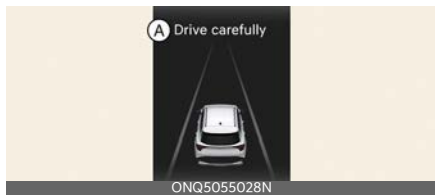

A: Drive carefully

When the vehicle is stopped due to emergency braking, a warning message will appear on the cluster.

For your safety, the driver should depress the brake pedal immediately and check the surroundings.

- Brake control will end after the vehicle is stopped by emergency braking for approximately 2 seconds.

CAUTION

If the collision angle with the crossing vehicle is beyond a certain range, Junction Crossing Warning and control may be delayed or may not operate.

Lane-Change Oncoming function (if equipped)

Warning and control

The Lane-change oncoming function is warned and controlled in the following way.

- Collision Warning
- Emergency Steering

Collision Warning

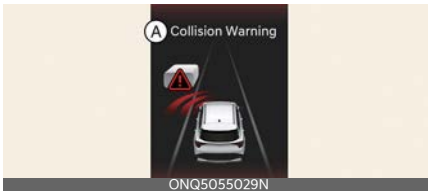

A: Collision Warning

Collision warning can alert the driver with the emergency steering warning light blinking (🚨), warning message, an audible warning and steering wheel vibration.

Collision warning will be activated in the following conditions.

- Your driving speed: Approximately 25-90 mph (40-145 km/h)
- Oncoming vehicle or powered two-wheeler speed: Approximately above 6 mph (10 km/h)
- Relative speed: Approximately below 124 mph (200 km/h)

Emergency Steering



A: Emergency Steering

Emergency steering can alert the driver with the emergency steering warning light blinking (🚨), warning message, an audible warning and steering wheel vibration. The steering assist will be activated to help mitigate or avoid a collision with an oncoming vehicle or powered two-wheelers.

Emergency steering will be activated in following conditions.

- Your driving speed: Approximately 25-90 mph (40-145 km/h)
- Oncoming vehicle or powered two-wheeler speed: Approximately above 6 mph (10 km/h)
- Relative speed: Approximately below 124 mph (200 km/h)

Lane-Change Side function (if equipped)

Warning and control

Lane-change Side function is warned and controlled in the following way.

- Collision Warning
- Emergency Steering

Collision Warning

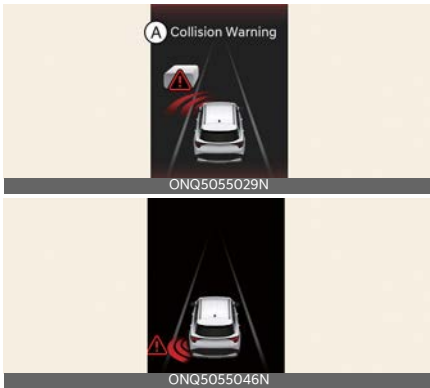

A: Collision Warning

If Collision warning recognizes a hazard, it will alert the driver with the emergency steering warning light blinking (⚠️), warning message, an audible warning and steering wheel vibration. The warning light will appear on the outside rear-view mirror (side-view mirror) when the vehicle or powered two-wheeler either on a right or left lane is detected from the rear.

Collision warning will be activated in following conditions.

- Your driving speed: Approximately 25-90 mph (40-145 km/h)

Emergency Steering



A: Emergency Steering

To warn the driver that emergency steering will be assisted, the emergency steering warning light blinking (⚠️), warning message will appear on the cluster, an audible warning will sound and the steering wheel will vibrate.

The warning light on the outside rear-view mirror (side-view mirror) will appear when the vehicle or powered two-wheeler on both lanes is detected from the rear. Steering will be assisted to avoid collision.

Emergency steering will be activated in following conditions.

- Your driving speed: Approximately 25-90 mph (40-145 km/h)
- The Lane Changing vehicle or Powered two-wheeler is moving

⚠️ CAUTION

- Lane-Change Side function does not operate if the oncoming vehicle or powered two-wheeler from the front side is stopped.
- These functions do not work when a flanking car or two-wheeled vehicle is stationary.
- The detection range of the front-side and rear-side radars is based on the standard lane width of ordinary roads. On narrow roads, warnings may be triggered by a vehicle or powered two-wheeler driving in the next lane. Conversely, on wide roads, radars

may fail to recognize a vehicle or powered two-wheeler driving in the next lane and not issue warnings.

- The lateral approaching vehicle response function is deactivated in the following situations:
 - If you drive more than a certain distance into the next lane
 - If you move away from the direction where there is a risk of collision
 - If the steering wheel is rotated rapidly
 - If you step on the brake pedal
 - If FCA is activated
- After the lateral approaching vehicle response function has been triggered or after changing lanes, be sure to move into the center of the lane. If you continue to drive along the edge of the lane without moving to the lane's center, the lateral approaching vehicle response function will be deactivated.

* NOTICE

- If an additional accident is expected due to emergency steering, only a collision warning will be issued to notify of the danger.
- If the driver's seat is on the left, a collision warning may be issued when turning left; if the driver's seat is on the right, a collision warning may be issued when turning right.

Evasive Steering Assist function (if equipped)

Warning and control

The Evasive Steering Assist function is warned and controlled in the following way.

- Emergency Steering

Emergency Steering (Driver steering assist)



A: Emergency Steering

If Emergency steering recognizes a hazard, it will alert the driver with the emergency steering warning light blinking (A), warning message, an audible warning and steering wheel vibration.

If there is a risk of collision with a vehicle, a pedestrian, a cyclist, or a powered two-wheeler in front, the steering will be assisted to help prevent collision when the driver steers the vehicle to avoid collision.

Emergency Steering can be activated in following conditions.

- Your driving speed: Approximately 25-53 mph (40-85 km/h)

Emergency Steering (Evasive steering assist)



A: Emergency Steering

If Emergency steering recognizes a hazard, it will alert the driver with the emergency steering warning light blinking (🚨), warning message, an audible warning and steering wheel vibration.

If there is a risk of collision with a pedestrian, a cyclist, or a powered two-wheeler in front and your vehicle already exceeded the emergency braking speed limit, the steering will be assisted to help prevent collision when the driver steers the vehicle to avoid collision.

Emergency Steering will be activated in following conditions.

- Your driving speed: Approximately 40-47 mph (65-75 km/h)

The recognized pedestrian or cyclist moves in the same direction as your vehicle, or in the opposite direction. In addition, there is sufficient space for an evasive movement for your vehicle. However, this function may not operate for pedestrians or cyclists moving in the horizontal direction.

⚠ CAUTION

- The steering wheel may turn automatically when emergency steering is operating.
- Emergency steering will automatically cancel when risk factors disappear. If necessary, the driver must steer the vehicle.

- Emergency steering may not operate or may cancel during operation if the steering wheel is held tight or steered in the opposite direction.
- When steering is assisted to avoid collision with a vehicle, pedestrian, cyclist and two-wheeler Evasive steering assist will be canceled if collisions with other objects (vehicle, powered two-wheeler, pedestrians, or cyclists) are expected.
- Evasive steering assist may not operate if space to avoid collision in the driving lane is insufficient.
- When driving at night, the performance of powered two-wheeler recognition is decreased, so the Forward Collision-Avoidance Assist system may be temporarily limited or may not work.

* NOTICE

For more details on warning messages, refer to "Collision Warning" on page 7-10.

⚠ WARNING

- For your safety, change the Settings after parking the vehicle at a safe location.
- Forward Collision-Avoidance Assist does not operate in all situations or cannot avoid all collisions.
- The driver should hold the responsibility to control the vehicle. Do not solely depend on Forward Collision-Avoidance Assist. Rather, maintain a safe braking distance, and if necessary, depress the brake pedal to reduce driving speed or to stop the vehicle.

- Never deliberately operate Forward Collision-Avoidance Assist on people, objects, etc. It may cause serious injury or death.
- Forward Collision-Avoidance Assist may not operate if the driver depresses the brake pedal to avoid collision.
- Depending on the road and driving conditions, Forward Collision-Avoidance Assist may be unable to timely warn the driver.
- During Forward Collision-Avoidance Assist operation, the vehicle may stop suddenly injuring passengers and shifting loose objects. Always have the seat belt on and keep loose objects secured.
- If any other function's warning message is displayed or audible warning is generated, Forward Collision-Avoidance Assist warning message may not be displayed and audible warning may not be generated.
- You may not hear the warning sound of Forward Collision-Avoidance Assist if the environment is noisy.
- Forward Collision-Avoidance Assist may turn off or may not operate properly or may operate unnecessarily depending on the road conditions and the surroundings.
- During emergency braking, braking control by Forward Collision-Avoidance Assist will automatically cancel when the driver excessively depresses the accelerator pedal or sharply steers the vehicle.

CAUTION

- The surroundings and pedestrians, cyclists and powered two-wheeler or other vehicles in front of you may affect the speed or detection range to operate Forward Collision-Avoidance Assist, resulting in Forward Collision-Avoidance Assist temporarily limited or disabled.
- Forward collision avoidance assistance operates under specific conditions, taking into account the status of the oncoming vehicle, powered two-wheeler and cyclist, driving direction, speed, and surrounding environment to judge the level of risk.
- The function may be limited or deactivated in cases where the driving speed is excessively high or there is a significant speed difference between the vehicle and the oncoming powered two-wheelers or cyclists.
- When a collision with a surrounding vehicle is expected, Lane-change oncoming, Lane-change side and Evasive steering assist functions will only warn the driver.

NOTICE

- When a collision is imminent, the Forward Collision-Avoidance Assist may assist the driver with brakes if the driver fails to brake enough.
- The images or colors on the instrument cluster may be different from those in this manual.

Forward Collision-Avoidance Assist malfunction and limitations

Forward Collision-Avoidance Assist malfunction

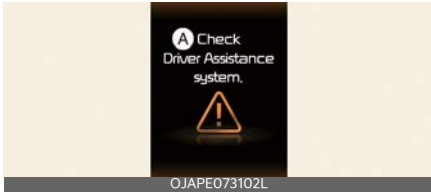

A: Check Driver Assistance system
 When Forward Collision-Avoidance Assist is not working properly, a warning message will appear, and the Forward Safety warning light (⚠️), the Emergency steering warning light (⚠️) and the Master warning light (⚠️) will appear on the cluster. Visit an authorized Kia dealer.

Forward Collision-Avoidance Assist disabled

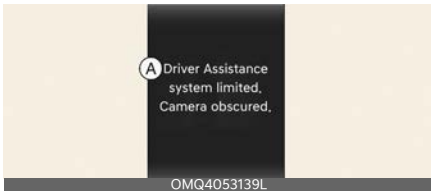

A: Driver Assistance system limited. Camera obscured.

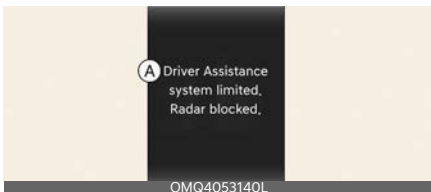

A: Driver Assistance system limited. Radar blocked.

When the windshield where the front view camera is located, front radar cover, bumper or sensor is covered with

foreign material, such as snow or rain, it can reduce the detecting performance and temporarily limit or disable Forward Collision-Avoidance Assist.

If this occurs a warning message, and the Forward Safety warning light (⚠️), the Emergency steering warning light (⚠️) and the Master warning light (⚠️) will appear on the cluster.

Forward Collision-Avoidance Assist will operate normally when snow, rain or foreign material is removed.

If Forward Collision-Avoidance Assist does not operate properly after obstruction (snow, rain, or foreign material) is removed (including trailer, carrier, etc. from the rear bumper), have the vehicle inspected by an authorized Kia dealer as soon as possible.

⚠️ WARNING

Even though a warning message or warning light does not appear on the cluster, Forward Collision-Avoidance Assist may not properly operate.

*** NOTICE**

You can check it in the service message of the utility information view of the cluster display window.

Limitations of Forward Collision-Avoidance Assist

Forward Collision-Avoidance Assist may not operate normally, or it may operate unexpectedly under the following circumstances:

- A sensor or its surroundings are contaminated or damaged
- The temperature around the front view camera is extremely high or low
- The camera lens is obscured by a tinted, filmed or coated windshield, by damaged glass, or by foreign material (e.g., sticker, bug) on the glass
- Heavy rain, snow, or fog obscure the camera's view
- The field of view of the front view camera is obstructed by sun glare
- Light is reflected off a wet road surface, such as a puddle in the road
- The surroundings are very bright (e.g., glare) or very dark (e.g., in a tunnel).
- The light changes suddenly, (e.g., when entering or exiting a tunnel)
- Dark conditions, when the headlamps are not on or are obscured, or the other vehicle has no taillights
- Only part of the vehicle, powered two-wheeler, pedestrian or cyclist is detected
- The vehicle in front is a bus, heavy truck, truck with an unusually shaped cargo, trailer, etc.
- The vehicle or powered two-wheeler in front has no taillights or its, taillights are in unusual positions
- The rear of the front vehicle is small, or the vehicle does not look normal, such as when the vehicle is tilted or overturned Clarify
- The other vehicle's ground clearance is extremely low or high
- A vehicle, powered two-wheeler, pedestrian or cyclist suddenly cuts in front
- The front radar or its surroundings are impacted, damaged, or out of position
- The temperature around the front radar is high or low
- Driving in areas where there are few vehicles or structures (e.g., desert, meadow)
- Driving near areas containing metal substances, such as a construction zone, railroad, metal plates on the road.
- A material is near that reflects very well on the front radar, such as a guardrail, nearby vehicle.
- The cyclist in front is on a bicycle made of material that does not reflect on the front radar's signal
- The vehicle or powered two-wheeler in front is detected late
- The view of the vehicle or powered two-wheeler is suddenly blocked
- The vehicle or powered two-wheeler in front suddenly changes a lane or suddenly reduces speed
- The vehicle or powered two-wheeler in front is bent out of shape
- The vehicle in front is covered with snow
- You are departing or returning to the lane
- Unstable driving
- You are on a roundabout and the vehicle or powered two-wheeler in front is not detected
- You are continuously driving in a circle
- The vehicle or powered two-wheeler in front has an unusual shape

- The vehicle or powered two-wheeler in front is on a steep hill, out of range of the camera and radar



The illustration above shows the kinds of images that the front view camera and front radar are capable of detecting as a vehicle, powered two-wheeler, pedestrian and cyclist. The system may not detect a pedestrian or cyclist in case of:

- The pedestrian or cyclist is leaning over or is not fully walking upright
- The pedestrian or cyclist is wearing clothing or equipment that makes it difficult to detect
- The pedestrian or cyclist in front is moving very quickly
- The pedestrian or cyclist in front is short or is posing a low posture
- The pedestrian or cyclist in front has impaired mobility or moving intersected with the driving direction
- There is a group of pedestrians, cyclists or a large crowd in front
- The pedestrian or cyclist is wearing clothing that easily blends into the background and difficult to detect
- The pedestrian or cyclist is difficult to distinguish from the similarly shaped structure in the surroundings
- You are driving by a pedestrian, cyclist, traffic signs, structures, etc., near the intersection
- When driving in the following places

- Driving through steam, smoke, or shadow
- Driving through a tunnel or iron bridge
- Driving in large areas where there are few vehicles or structures (i.e., desert, meadow, suburb, etc.)
- Driving in a car park
- Driving through tollgate, construction areas, partially paved roads, bumpy roads, speed bumps, etc.
- Driving near areas containing metal substances, such as a construction zone, railroad, etc.
- Driving on an inclined road, curved road, etc.
- Driving through a roadside with trees or streetlights
- Driving through a narrow road where trees or grass are overgrown
- There is interference by electromagnetic waves, such as driving in an area with strong radio waves or electrical noise
- The vehicle unstably moves or violently shakes
- If there is severe tilting of the overall height due to abnormal tire pressure or excessive loading in the cargo area
- A snow chain, spare tire or wheel of a different size is installed

Junction Crossing, Lane-Change Oncoming, Lane-Change Side, Evasive Steering Assist function (if equipped)

- The temperature around the front corner radar or rear corner radar is high or low
- A trailer or carrier is installed around the rear corner radar

- The front corner radar or rear corner radar is covered with snow, rain, dirt, etc.
- The bumper around the front corner radar or rear corner radar is covered with objects, such as a bumper sticker, bumper guard, bike rack, etc.
- The bumper around the front corner radar or rear corner radar is impacted, damaged or the radar is out of position
- The front corner radar or rear corner radar is blocked by other vehicles, walls or pillars
- Driving on a highway (or motorway) ramp
- Driving on a road where the guardrail or wall is in double structure
- The other vehicle or powered two-wheeler drives very close behind your vehicle, or the other vehicle passes by your vehicle in proximity
- The speed of the other vehicle or powered two-wheeler is very fast that it passes by your vehicle in a short time
- Your vehicle passes by the other vehicle or powered two-wheeler
- Your vehicle has started at the same time as the vehicle or powered two-wheeler next to you and has accelerated
- The vehicle or powered two-wheeler in the next lane moves two lanes away from you, or when the vehicle two lanes away moves to the next lane from you
- A motorcycle or bicycle is detected
- A vehicle such as a flat trailer is detected
- A big vehicle such as a bus or truck is detected
- A small moving obstacle such as a pedestrian, animal, shopping cart or a baby pushchair is detected
- A vehicle with low height such as a sports car is detected
- The lane is difficult to see due to foreign material, such as rain, snow, dust, sand, oil and water puddles
- The color of the lane marking is not distinguishable from the road
- There are markings on the road near the lane or the markings on the road looks similar to the lane markings
- The shadow is on the lane marking by a median strip, trees, guardrail, noise barriers, etc.
- The lane number increases or decreases, or the lane markings are crossing
- There are more than two-lane markings on the road
- The lane markings are complicated or a structure substitutes for the lines, such as a construction area
- There are road markings, such as zig-zag lanes, crosswalk markings and road signs
- The lane suddenly disappears, such as at the intersection
- The lane is very wide or narrow
- There is a curb or road edges without a lane
- The vehicle in front is driving with one side on the lane marking
- The distance to the front vehicle is extremely short

* NOTICE

For more details on the limitations of detecting rear corner vehicles and cautions regarding the rear corner sensor, please refer to the "Blind-Spot Collision-

Avoidance Assist (BCA) (if equipped)" on page 7-33.

Limitations of Evasive Steering Assist

Evasive Steering Assist function may not work properly in the following situations when:

- The pedestrians or cyclists are positioned outside the operating area

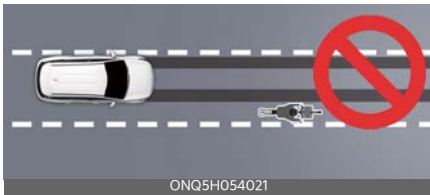

- The pedestrians or cyclists are moving laterally



- The pedestrians or cyclists are positioned inside the operating area, but there is not enough space available for evasive steering

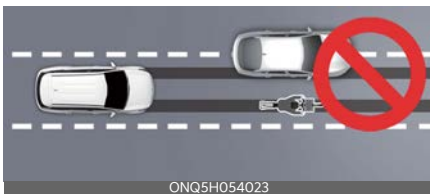

WARNING

- Driving on a curved road



Forward Collision-Avoidance Assist may not detect other vehicles, powered two-wheelers, a pedestrians or cyclists in front of you when driving on curved roads. This may result in no warning, braking assist or steering assist (if equipped) when necessary. When driving on a curve, you must maintain a safe braking distance, and if necessary, steer the vehicle and depress the brake pedal to reduce your driving speed in order to maintain a safe distance.

Forward Collision-Avoidance Assist may detect a vehicle, powered two-wheeler, pedestrian or cyclist in the next lane or outside the lane when driving on a curved road.

If this occurs, Forward Collision-Avoidance Assist may unnecessarily warn the driver and control the brake or steering. Always check the traffic conditions around the vehicle.

- Driving on an inclined road

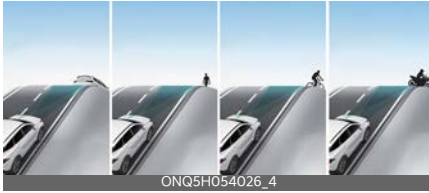

Forward Collision-Avoidance Assist may not detect other vehicles, powered two-wheelers, pedestrians or cyclists in front of you while driving uphill or downhill, adversely affecting the performance of the sensors.

This may result in unnecessary warning, braking assist, steering assist (if equipped) or no warning, braking assist, steering assist (if equipped) when necessary.

Also, vehicle speed may rapidly decrease when a vehicle, powered two-wheeler, pedestrian or cyclist ahead is suddenly detected.

Always have your eyes on the road while driving uphill or downhill and if necessary, steer your vehicle and depress the brake pedal to reduce your driving speed in order to maintain a safe distance.

- Changing lanes

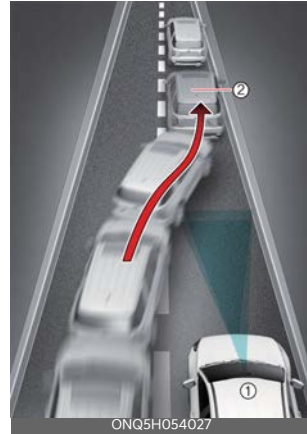

1. Your vehicle
2. Lane changing vehicle or powered two-wheeler

When a vehicle or powered two-wheeler (2) moves into your lane from an adjacent lane, it cannot be detected by the sensor until it is in the sensor's detection range.

Forward Collision-Avoidance Assist may not immediately detect the vehicle or powered two-wheeler when the vehicle or powered two-wheeler changes lanes abruptly. In this case, you must maintain a safe braking distance, and if necessary, steer your vehicle and depress the brake pedal to reduce your driving speed in order to maintain a safe distance.

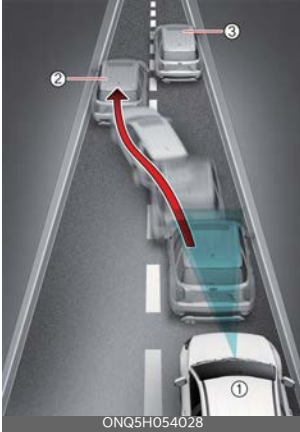

1. Your vehicle
2. Lane changing vehicle or powered two-wheeler
3. Same lane vehicle

When a vehicle (2) in front of you merges out of the lane, Forward Collision-Avoidance Assist may not immediately detect the vehicle or powered two-wheeler (3) that is now in front of you. In this case, you must maintain a safe braking distance, and if necessary, steer your vehicle and depress the brake pedal to reduce your driving speed in order to maintain a safe distance.

- Detecting a vehicle



If the vehicle in front of you has cargo that extends rearward from the cab, or when the vehicle in front of you has higher ground clearance, additional special attention is required. Forward Collision-Avoidance Assist may not be able to detect the cargo extending from the vehicle. In these instances, you must maintain a safe braking distance from the rearmost object, and if necessary, steer your vehicle and depress the brake pedal to reduce your driving speed in order to maintain distance.

- When you are towing a trailer or another vehicle, we recommend that Forward Collision-Avoidance Assist is turned off due to safety reasons.
- Forward Collision-Avoidance Assist may operate if objects that are similar in shape or characteristics to vehicles, powered two-wheelers, pedestrians and cyclists are detected.
- Forward Collision-Avoidance Assist does not operate on bicycles, motorcycles, or smaller wheeled objects, such as luggage bags, shopping carts, or strollers.
- Forward Collision-Avoidance Assist may not operate normally if interfered with by strong electromagnetic waves.
- Forward Collision-Avoidance Assist may not operate for 15 seconds after the vehicle is started, or the front view camera is initialized.

*** NOTICE**

For more details on the limitations of detecting rear corner vehicles and cautions regarding the rear corner sensor, please refer to "Blind-Spot Collision-Avoidance Assist (BCA) (if equipped)" on page 7-33.

This device complies with Part 15 of the FCC rules.

Operation is subject to the following three conditions:

1. This device may not cause harmful interference, and
2. This device must accept any interference received, including interference that may cause undesired operation.
3. Changes or modifications not expressly approved by the party responsible for compliance could void the user's authority to operate the device.

Radio frequency radiation exposure information:

This equipment complies with FCC radiation exposure limits set forth for an uncontrolled environment. This equipment should be installed and operated with minimum distance of 8 in (20 cm) between the radiator (antenna) and your body.

This transmitter must not be colocated or operating in conjunction with any other antenna or transmitter.

Lane Keeping Assist (LKA)

While driving over a certain speed, Lane Keeping Assist detects lane markings (or road edges) and may warn you if your vehicle leaves the lane without using the turn signal and may assist with steering to prevent your vehicle departing from its travel lane.

Detecting sensor

Front view camera



The front view camera is used as a detecting sensor to detect lane markings (or road edges).

⚠ CAUTION

For more details on the precautions of the front view camera, refer to "Forward Collision-Avoidance Assist (FCA) (Sensor Fusion)" on page 7-5.

Lane Keeping Assist settings

Lane Safety



- 1 Driver Assistance
- 2 Driving Safety
- 3 Lane Safety

With the vehicle on, select **Setup** → **Vehicle** → **Driver Assistance** → **Driving Safety** on the infotainment system.

- **Lane Safety:** When lane departure is detected, the system assists with steering to prevent leaving the lane, and if lane departure occurs, it alerts the driver with an audible sound and steering wheel vibration. If Lane safety is deselected, the indicator light (🚗) will be turned off.

⚠️ WARNING

- Lane Keeping Assist does not control the steering wheel when the vehicle is driven in the middle of the lane.
- The driver should always be aware of the surroundings and steer the vehicle if **Lane safety** is deselected.

⚠️ CAUTION

When the vehicle and the trailer are connected electrically, Lane Keeping Assist automatically turns off. In this case, you cannot get help from Lane Keeping Assist. Always drive with care. (if Kia genuine part equipped)

* NOTICE

By pressing the Lane Driving Assist button (🚗), the Lane Keeping Assist will be turned off, and it will also deactivate the Lane Safety.

Warning Methods

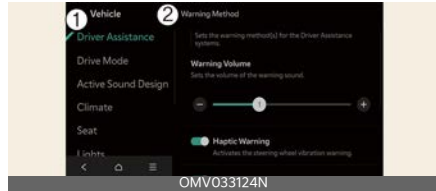

- 1 Driver Assistance
- 2 Warning Methods

Warning Methods can be set with the vehicle on. Select **Setup** → **Vehicle** → **Driver Assistance** → **Warning Methods** from the settings menu in the infotainment system to change the following settings:

- **Warning Volume:** Adjusts the volume of the warning sound.
- **Haptic Warning:** Activates the steering wheel vibration warning.
- **Lane Safety Warning Sound:** You can turn on or off the Lane Safety warning sound when the Haptic warning is on.
- **Driving Safety Priority:** Lowers all other audio volumes when the Driving Safety system sounds a warning.

* NOTICE

- Ensure that **Warning Methods** you have set may apply to the **Warning Methods** of other driver assistance systems.
- **Warning Methods** will maintain its last setting even if the vehicle is restarted.

- The setting menu may not be available for your vehicle depending on the vehicle features and specifications.
- The **Lane Safety Warning Sound** can be set when the Haptic Warning is on

Lane Keeping Assist operation

Turning Lane Keeping Assist On/Off



With the vehicle on, press and hold the Lane Driving Assist (LDA) button located on the steering wheel to turn on and off Lane Keeping Assist.

The gray or green indicator (LKA) on the cluster will light up if you turn on Lane Keeping Assist.

* NOTICE

- When the operating condition of LKA are met, the cluster is illuminated with a green (LKA) indicator.
- When the operating conditions are not met, a gray (LKA) indicator is illuminated.

Warning and control

The Lane Keeping Assist function is warned and controlled in the following way.

- Lane Departure Warning
- Lane Keeping Assist

Lane Departure Warning (left side)



Lane Departure Warning (right side)



Lane Departure Warning

Lane departure warning is issued through a green indicator light on the cluster, a blinking indicator in the direction you departed from, a warning sound, and the steering wheel will vibrate.

Lane Departure Warning will be activated in the following conditions.

- Your driving speed: Approximately 40-120 mph (60-200 km/h)

Lane Keeping Assist

The green (LKA) indicator light will blink on the cluster, and the steering wheel makes adjustments to keep vehicle inside the lane.

Lane Keeping Assist will be activated in the following conditions.

- Your driving speed: Approximately 40-120 mph (60-200 km/h)

Hands-off warning

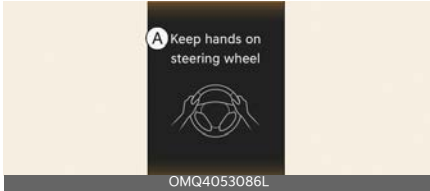

A: Keep hands on steering wheel

If the driver takes their hands off the steering wheel for several seconds, a warning message will appear on the cluster, and an audible warning will sound in stages.

WARNING

- The steering wheel may not be assisted if the steering wheel is held very tight or the steering wheel is steered over a certain degree.
- Lane Keeping Assist does not operate at all times. It is the responsibility of the driver to safely steer the vehicle and to maintain the vehicle in its lane.
- The hands-off warning message may appear delayed depending on road conditions. Always have your hands on the steering wheel while driving.
- If the steering wheel is held very lightly, the hands-off warning message may appear because Lane Keeping Assist may not recognize that the driver has their hands on the steering wheel.
- If you attach objects to the steering wheel, the hands-off warning may not work properly.

* NOTICE

- Even when Lane Keeping Assist is active, the driver can still control the steering wheel.
- The steering wheel may feel heavier or lighter when the steering wheel is assisted by Lane Keeping Assist than when it is not.
- If the vehicle detects the lane markings, the gray-colored lane lines on the cluster turns into white.

Lane undetected



Lane detected



- If you select Highway Lane Change Assist, the green lane will appear on the cluster. (if equipped)
- The images and colors in the instrument cluster may differ depending on the cluster type or theme selected from the settings menu.
- The lane marker in the instrument cluster may differ to actual lane.
- For more details on the instrument cluster, refer to "Forward Collision-Avoidance Assist (FCA) (Sensor Fusion)" on page 7-5.

Lane Keeping Assist malfunction and limitations

Lane Keeping Assist malfunction

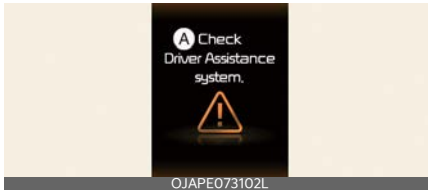

A: Check Driver Assistance system

When Lane Keeping Assist is not working properly, a warning message will appear and the yellow (🚗) indicator light will appear on the instrument cluster.

If this occurs, have the function inspected by an authorized Kia dealer as soon as possible.

Lane Keeping Assist disabled

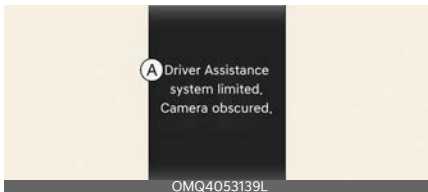

A: Driver Assistance system limited. Camera obscured.

If foreign materials such as snow or rain block the sensors or the windshield where the front view camera is located, the detecting performance may be reduced, resulting in Lane Keeping Assist temporarily limited or disabled.

In this case, a warning message is displayed with the Master warning light (⚠️) and the Lane safety warning lights (🚗) on the cluster. This is normal operation.

Lane Keeping Assist will operate normally after cleaning snow, rain or foreign materials. Always keep it clean.

If Lane Keeping Assist still does not operate normally after cleaning foreign materials (snow, rain, etc.) or removing obstructions (including trailer, carrier, etc. from the rear bumper), have the vehicle inspected by an authorized Kia dealer as soon as possible.

⚠️ WARNING

- Even though a warning message or warning light does not appear temporarily on the cluster, Lane Keeping Assist may not operate normally.
- Even after starting the vehicle again, Lane Keeping Assist may not function normally when the obstruction or malfunction condition persists.

* NOTICE

You can check it in the service message of the utility information view of the cluster display window.

Limitations of Lane Keeping Assist

Lane Keeping Assist may not operate normally or may operate unexpectedly under the following circumstances:

- The lane is contaminated or difficult to detect because:
 - The lane markings (or road edges) are covered with rain, snow, dirt, oil, etc.
 - The color of the lane marking (or road edges) is not distinguishable from the road.
 - There are markings (or road edges) on the road near the lane or the markings (or road edges) on the

road look similar to the lane markings (or road edges).

- The lane marking (or road edges) is indistinct or damaged.
- When the shadow of objects around the road (central reservation, crash barrier, noise barrier, surrounding bushes, etc.) or the shadow of a vehicle covers the lane.
- The lane number increases or decreases, or the lane markings (or road edges) are crossing.
- There are more than two lane markings (or road edges) on the road.
- The lane markings (or road edges) are complicated or a structure is substituted for the lines, such as in a construction area.
- There are road markings, such as zig-zag lanes, crosswalk markings and road signs.
- The lane suddenly disappears, such as at the intersection.
- The lane (or road width) is very wide or narrow.
- There is a road edge without a lane
- There is a boundary structure in the roadway, such as a tollgate, sidewalk, curb, etc.
- When driving in a bus-only lane (HOV lane) or the left/right lane of a bus-only lane
- The distance to the front vehicle is extremely short or the vehicle in front is covering the lane marking (or road edge).

* NOTICE

For more details on the limitations of the front view camera, refer to "Forward Collision-Avoidance Assist (FCA) (Sensor Fusion)" on page 7-5.

⚠ WARNING

- The driver should hold the responsibility to safely drive and control the vehicle. Do not solely rely on Lane Keeping Assist and drive dangerously.
- The operation of Lane Keeping Assist can be canceled or not work normally depending on road conditions and surroundings. Always be cautious while driving.
- Refer to "Lane Keeping Assist malfunction and limitations" on page 7-31. If the lane is not detected properly.
- When you are towing a trailer or another vehicle, turn off Lane Keeping Assist for safety reasons.
- If the vehicle is driven at high speed, the steering wheel will not be controlled. The driver must always follow the speed limit when using Lane Keeping Assist.
- If any other function's warning message is displayed or audible warning is generated, Lane Keeping Assist warning message may not be displayed and audible warning may not be generated.
- You may not hear the warning sound of Lane Keeping Assist if the environment is noisy. Adjust the vehicle volume moderately and always pay attention to the surrounding.
- If you attach objects to the steering wheel, steering may not be assisted normally.

- Lane Keeping Assist may not operate for approximately 15 seconds after the vehicle is started, or the front view camera is initialized.
- Lane Keeping Assist will not operate when:
 - The turn signal or hazard warning flasher is turned on.
 - The vehicle is not driven in the center of the lane when Lane Keeping Assist is turned on or right after changing a lane.
 - ESC (Electronic Stability Control) or VSM (Vehicle Stability Management) is activated.
 - The vehicle is turning quickly on a curved road.
 - Vehicle speed is below 35 mph (55 km/h) or above 130 mph (210 km/h).
 - The driver makes sharp lane changes.
 - The driver brakes suddenly.
 - Driving stability can deteriorate when loading cargo in excess of the maximum allowable weight or concentrated to one cargo area. Also, it can reduce the Lane Keeping Assist performance.
- Driving stability can deteriorate when loading cargo in excess of the maximum allowable weight or concentrated to one cargo area. Also, it can reduce the Lane Keeping Assist performance.

Blind-Spot Collision-Avoidance Assist (BCA) (if equipped)

Blind-Spot Collision-Avoidance Assist detects approaching vehicles in the driver's blind spot areas and warn you of a possible collision with a warning light and a warning sound. If there is a collision risk when exiting a parallel space, Blind-Spot Collision-Avoidance Assist may assist with braking your vehicle to help avoid a collision.



Blind-Spot Collision-Avoidance Assist helps detect and inform the driver that a vehicle is in the blind spot.

⚠ CAUTION

The detecting range may vary depending on the speed of your vehicle. However, even if there is a vehicle in the blind spot area, the function may not warn you when you pass by at high speeds.



Blind-Spot Collision-Avoidance Assist helps detect and inform the driver that a vehicle is approaching at high speed from the blind spot area.

CAUTION

Warning Timing may vary depending on the speed of the vehicle approaching at high speed.

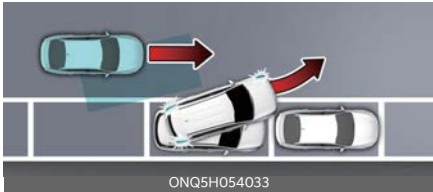

When you are driving forward out of a parking space, if Blind-Spot Collision-Avoidance Assist judges that there is a collision risk with an approaching vehicle in the blind spot, it will help avoid collision by applying the brake.

Detecting sensor

Rear corner radar



CAUTION

- Never disassemble the detecting sensor assembly, or cause any damage to it.
- If the detecting sensor or near the sensor has been damaged or impacted in any way, even though a warning message does not appear on the cluster, Blind-Spot Collision-Avoidance Assist may not operate properly. Have the function inspected by an authorized Kia dealer.

- If the detecting sensors have been replaced or repaired, have the vehicle inspected by an authorized Kia dealer.
- The genuine Kia rear bumpers which the Rear corner radar sensors are mounted are parts with quality and performance ensured. If arbitrarily applying paint on or changing the bumper, the Blind-Spot Collision-Avoidance Assist may not function properly. Use only Kia Genuine Parts or those of an equivalent standard with proven quality and performance to repair or replace the bumper.
- Do not apply license plate frame or objects, such as a bumper sticker, film or a bumper guard near the rear corner radar.
- Blind-Spot Collision-Avoidance Assist may not work properly if the bumper has been replaced, or the surroundings of the rear corner radar has been damaged or paint has been applied.
- If a trailer, carrier, etc., is installed, it may adversely affect the performance of the rear corner radar or Blind-Spot Collision-Avoidance Assist may not operate.

Blind-Spot Collision-Avoidance Assist settings

Blind-Spot Safety

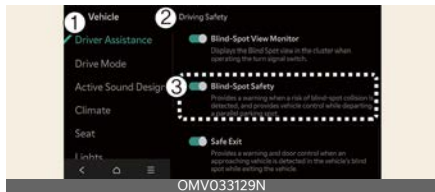

- 1 Driver Assistance
- 2 Driving Safety
- 3 Blind-Spot Safety

With the vehicle on, select **Setup** → **Vehicle** → **Driver Assistance** → **Blind-Spot Safety** on the infotainment system.

- **Blind-Spot Safety:** Blind-Spot Collision-Avoidance Assist will warn and braking assist will be applied depending on the collision risk levels.



A: Blind-Spot Safety System is Off

When activating Blind-Spot Collision-Avoidance Assist or restarting the vehicle with this function activated, the warning light on the side mirrors will appear for approximately 3 seconds. When the vehicle is restarted with Blind-Spot Collision-Avoidance Assist inactivated, a warning message will appear on the cluster.

⚠ WARNING

If **Blind-Spot Safety** is deselected, the driver should always be aware of the surroundings and drive safely.

⚠ CAUTION

When the vehicle and a trailer are connected electrically, Blind-Spot Collision-Avoidance Assist automatically turns off. In this case, you cannot get help from Blind-Spot Collision-Avoidance Assist. Always drive with care. (if Kia genuine part equipped)

* NOTICE

If the vehicle is restarted, Blind-Spot Collision-Avoidance Assist will maintain the last setting.

Warning Methods

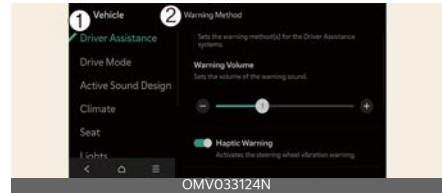

1 Driver Assistance

2 Warning Methods

Warning Methods can be set with the vehicle on. Select **Setup** → **Vehicle** → **Driver Assistance** → **Warning Methods** from the settings menu in the infotainment system to change the following settings:

- **Warning Volume:** Adjusts the volume of the warning sound.
- **Haptic Warning:** Activate the steering wheel vibration warning.
- **Blind-Spot Safety Warning Sound:** Blind-Spot Safety Warning Sound can be turned off separately.
- **Driving Safety Priority:** Lowers all other audio volumes when the Driving Safety system sounds a warning.

* NOTICE

- Ensure that **Warning Methods** you have set may apply to the **Warning Methods** of other driver assistance systems.
- **Warning Methods** will maintain its last setting even if the vehicle is restarted.
- The setting menu may not be available for your vehicle depending on

the vehicle features and specifications.

Blind-Spot Collision-Avoidance Assist operation

Blind-Spot Collision-Avoidance Assist will warn and control as following operation.

- Collision warning
- Collision-avoidance assist (while departing)

Collision warning (while driving)

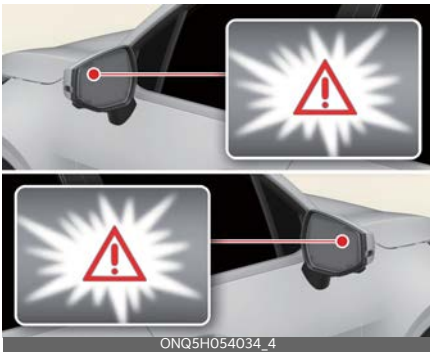

The warning light on the cluster, outside rear view mirror (side view mirror) and head-up display (if equipped) will appear when the vehicle on both lanes is detected from the rear.

A vehicle is detected in the following conditions.

- Your driving speed: Above 12 mph (20 km/h)
- The speed of the vehicle in your blind spot area: Above 7 mph (10 km/h)

With the vehicle detection in use, Collision warning will alert the driver when the turn signal is activated to make a lane change with an adjacent car in the blind spot area.

- Collision warning will alert the driver with the warning light on the cluster, outside rearview mirrors (side-view mirrors) and head-up display (if equipped), audible warning and steering wheel vibration.
- When the turn signal is turned off or you move away from the lane, the collision warning will be canceled and the function will return to Vehicle detection state.

Collision Warning operate in the following conditions.

- Your driving speed: Above 25 mph (40 km/h)
- The speed of the vehicle in your blind spot area: Above 7 mph (10 km/h)

⚠ WARNING

- The detecting range of the front corner radar or rear corner radar is determined by a standard road width, therefore, on a narrow road, Blind-Spot Collision-Avoidance Assist may detect other vehicles two lanes over and warn you. In contrast, on a wide road, Blind-Spot Collision-Avoidance Assist may not be able to detect a vehicle driving in the next lane and may not warn you.
- When the hazard warning flasher is on, the collision warning by the turn signal will not operate.

* NOTICE

- If the driver's seat is on the left side, the collision warning may occur when you turn left. If the driver's seat is on the right side, the collision warning may occur when you turn right. Maintain a proper distance with the vehicles in the lane.

- Images or colors may be displayed differently depending on the instrument cluster specifications or theme.

Collision-Avoidance Assist (while departing)

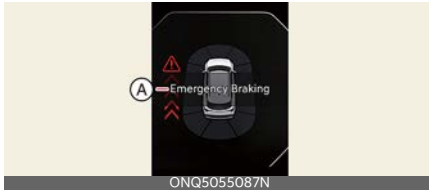

A : Emergency Braking

The warning light on the outside rear-view mirror (side view mirror), head-up display (if equipped), an audible warning and the steering wheel vibration will warn the driver of a collision. It assists in braking control to prevent a collision with a vehicle approaching from the blind spot area.

Collision-Avoidance Assist will be activated in the following conditions.

- Your driving speed: Below 2 mph (3 km/h)
- Speed of the vehicle in your blind spot area: Above 3 mph (5 km/h)

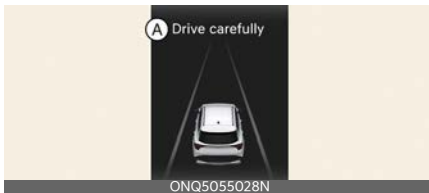

A: Drive carefully

When the vehicle is stopped due to emergency braking, a warning message will appear on the instrument cluster. For your safety, the driver should depress the brake pedal immediately and check the surroundings.

- Brake control will end after the vehicle is stopped by emergency braking for approximately 2 seconds.

⚠ WARNING

- For your safety, change the Settings after parking the vehicle at a safe location.
- If any other function's warning message is displayed or audible warning is generated, BCA warning message may not be displayed and audible warning may not be generated.
- You may not hear the warning sound of Blind-Spot Collision-Avoidance Assist if the environment is noisy. Always pay attention and keep the vehicle volume at a moderate level.
- Blind-Spot Collision-Avoidance Assist may not operate if the driver applies the brake pedal to avoid collision.
- When Blind-Spot Collision-Avoidance Assist is operating, braking control by the function will automatically cancel when the driver excessively depresses the accelerator pedal or sharply steers the vehicle.
- During Blind-Spot Collision-Avoidance Assist operation, the vehicle may stop suddenly injuring passengers and shifting loose objects. Always have the seat belt on and keep loose objects secured.
- Even if there is a problem with Blind Spot Collision-Avoidance Assist, the vehicle's basic braking performance will operate properly.
- Blind-Spot Collision-Avoidance Assist may not operate in all situations, and even if it works, it may not be able to avoid collisions.

- Blind-Spot Collision-Avoidance Assist may not warn the driver depending on the road and driving conditions.
- The responsibility for safe operation lies with the driver. Do not rely solely on Blind-Spot Collision-Avoidance Assist for driving and always check the surrounding conditions directly and drive safely.
- Never operate Blind-Spot Collision-Avoidance Assist on people, animal, objects, etc. It may cause serious injury or death.

⚠ WARNING

The brake control may not operate properly depending on the status of ESC (Electronic Stability Control).

There will only be a warning when:

- The ESC (Electronic Stability Control) warning light is on.
- ESC (Electronic Stability Control) is engaged in a different function.

Blind-Spot Collision-Avoidance Assist malfunction and limitations

Blind-Spot Collision-Avoidance Assist malfunction

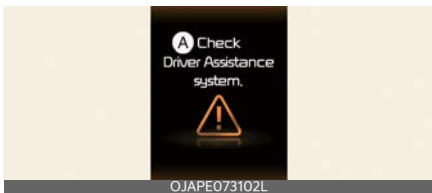

A: Check Driver Assistance system.

When Blind-Spot Collision-Avoidance Assist is not working properly, a warning message will appear on the cluster for several seconds, and the master (⚠) warning light will appear on the cluster.

Avoidance Assist inspected by an authorized Kia dealer.

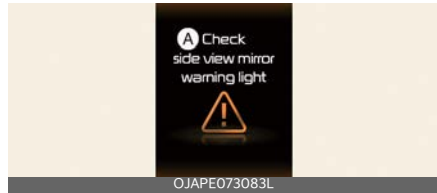

A: Check side view mirror warning light

When the outside rearview mirror warning light is not working properly, a warning message will appear on the cluster for several seconds and the master warning light (⚠) will appear on the cluster. If this occurs, have Blind Spot Collision Avoidance Assist inspected by an authorized Kia dealer.

Blind-Spot Collision-Avoidance Assist disabled

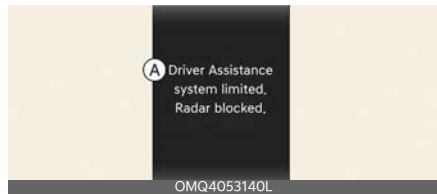

A: Driver Assistance system limited. Radar blocked.

Covering the rear bumper around the rear corner radar or sensor with foreign materials, such as snow or rain, or installing a trailer or carrier can reduce the detecting performance, resulting in Blind-Spot Collision-Avoidance Assist temporarily limited or disabled.

A warning message and the Master warning light (⚠) are displayed on the cluster display, but it does not indicate a malfunction of Blind-Spot Collision-Avoidance Assist.

Blind-Spot Collision-Avoidance Assist will operate normally when such foreign material or trailer, etc., is removed, and then the vehicle is restarted.

If Blind-Spot Collision-Avoidance Assist does not operate normally after it is removed, have Blind Spot Collision Avoidance Assist inspected by an authorized Kia dealer.

WARNING

- Even though a warning message does not appear on the cluster, Blind-Spot Collision-Avoidance Assist may not properly operate.
- Blind-Spot Collision-Avoidance Assist may not properly operate in an area (for example, open terrain) where any objects are not detected right after the vehicle is turned on, or when the detecting sensor is blocked with foreign material right after the vehicle is turned on.

CAUTION

Turn off Blind-Spot Collision-Avoidance Assist to install or remove a trailer, carrier, or another attachment. Turn on Blind-Spot Collision-Avoidance Assist when finished.

NOTICE

You can check it in the service message of the utility information view of the cluster display window.

Limitations of Blind-Spot Collision-Avoidance Assist

Blind-Spot Collision-Avoidance Assist may not operate properly, or it may operate unexpectedly under the following circumstances:

- There is inclement weather, such as heavy snow and rain.
- The detecting sensor is covered with snow, rain, dirt, etc.
- The ambient temperature around the detecting sensor is high or low.
- The detecting sensor is blocked while driving near a vehicle, pillar, or wall.
- Driving on a highway ramp or through a tollgate.
- The pavement abnormally contains metallic components (such as subway construction).
- There are fixed objects near the vehicle, such as sound barriers, guardrails, central dividers, entry barriers, streetlights, signs, tunnels, walls, etc.
- Driving on a narrow road with overgrown foliage.
- Driving in wide open areas where there are few vehicles or structures
- Driving on a wet road surface.
- Other vehicles are moving very close behind you, or are passing.
- Other vehicles are moving is very fast when passing.
- You pass another vehicle.
- You change lane.
- Your accelerate at the same time as a vehicle next to you.
- A vehicle in the next lane moves two lanes away from you, or when the vehicle two lanes away moves to the next lane from you

- A trailer or carrier is installed around the rear corner radar
- The bumper around the rear corner radar is covered with objects, such as a bumper sticker, bike rack, etc.
- The bumper around the rear corner radar is impacted, damaged or the radar is out of position
- When snow chains or wheels of different sizes are installed
- Your vehicle height is low or high due to heavy loads, abnormal tire pressure, etc.
- When the following objects are detected:
 - A motorcycle or bicycle is detected
 - A vehicle such as a flat-bed trailer is detected
 - A large vehicle such as a bus or truck is detected
 - A moving obstacle such as a pedestrian, animal, shopping cart or baby carriage is detected
 - A vehicle with low height such as a sports car is detected

Pay extra attention. Braking control may not operate under the following conditions:

- The vehicle severely vibrates while driving over a bumpy road or pothole.
- Driving on a slippery surface such as snow, water, ice, etc.
- Tire pressure is low or is damaged
- The braking system has been modified
- When steering abruptly

WARNING

- Driving on a curved road

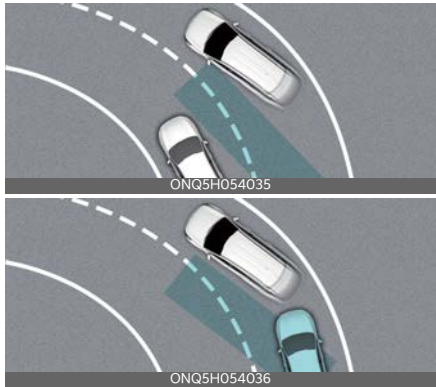

Blind-Spot Collision-Avoidance Assist may not operate properly on a curved road. Blind-Spot Collision-Avoidance Assist may not detect the vehicle in the next lane.

Always pay attention to road and driving conditions.

Blind-Spot Collision-Avoidance Assist may not operate properly when driving on a curved road.

Always pay attention to road and driving conditions while driving.

- Driving on an inclined road



Driving where the road is merging/dividing



Blind-Spot Collision-Avoidance Assist may not operate properly when driving on a slope. The function may not detect the vehicle in the next lane or may incorrectly detect the ground or structure.

Always pay attention to road and driving conditions while driving.

Blind-Spot Collision-Avoidance Assist may not operate properly when driving where the road merges or divides. The function may not detect the vehicle in the next lane.

Always pay attention to road and driving conditions while driving.

- Driving where the heights of the lanes are different



Always pay attention to road and driving conditions while driving.

Blind-Spot Collision-Avoidance Assist may not operate properly when driving where the heights of the lanes are different. The function may not detect the vehicle on a road with different lane heights (underpass joining section, grade separated intersections, etc.).

⚠ WARNING

- When you are towing a trailer or another vehicle, make sure that you turn off Blind-Spot Collision-Avoidance Assist.
- Blind-Spot Collision-Avoidance Assist may not operate properly if interfered by strong electromagnetic waves.
- Blind-Spot Collision-Avoidance Assist may not operate for approximately 3 seconds after the vehicle is started, or the front view camera or rear corner radars are initialized.

This device complies with Part 15 of the FCC rules.

Operation is subject to the following two conditions:

1. This device may not cause harmful interference, and
2. This device must accept any interference received, including interference that may cause undesired operation.

Safe Exit Warning (SEW) (if equipped)



After the vehicle stops, when an approaching vehicle from the rear area is detected as soon as a passenger opens a door, Safe Exit Warning will warn the driver with a warning message and an audible warning to help prevent a collision.

⚠ CAUTION

Warning Timing may vary depending on the speed of the approaching vehicle.

Detecting sensor

Rear corner radar



Refer to the picture above for the detailed location of the detecting sensors.

⚠ CAUTION

For more details on the precautions of the rear corner radars, refer to "Blind-Spot Collision-Avoidance Assist (BCA) (if equipped)" on page 7-33.

Safe Exit Warning settings

Safe Exit



- 1 Driver Assistance
- 2 Driving Safety
- 3 Safe Exit

With the vehicle on, select **Setup** → **Vehicle** → **Driver Assistance** → **Driving Safety** → **Safe Exit** on the infotainment system.

⚠ WARNING

If **Safe Exit** is deselected, Safe Exit Warning cannot warn you. The driver should always be aware of unexpected and sudden situations that may occur.

⚠ CAUTION

When the vehicle and a trailer are connected electrically, Safe Exit Warning automatically turns off. In this case, you cannot get help from Safe Exit Warning. Always drive with care. (if Kia genuine part equipped)

*** NOTICE**

If the vehicle is restarted, Safe Exit Warning will maintain the last setting.

Warning Methods

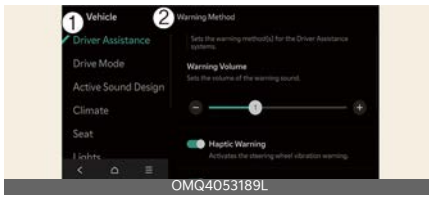

1 Driver Assistance

2 Warning Methods

Warning Methods can be set with the vehicle on. Select **Setup** → **Vehicle** → **Driver Assistance** → **Warning Methods** from the settings menu in the infotainment system to change the following settings:

- **Warning Volume:** Adjusts the volume of the warning sound.
- **Driving Safety Priority:** Lowers all other audio volumes when the Driving Safety system sounds a warning.

* NOTICE

- Ensure that **Warning Methods** you have set may apply to the **Warning Methods** of other driver assistance systems.
- **Warning Methods** will maintain its last setting even if the vehicle is restarted.
- The setting menu may not be available for your vehicle depending on the vehicle features and specifications.

Safe Exit Warning operation

Warning

Safe Exit Warning warns the following actions.

Collision warning when exiting vehicle



A: Collision Warning

- The warning light on the outside rearview mirror will blink and the warning message will appear on the cluster, and an audible warning will sound.
- Safe Exit Warning will warn under the following circumstances:
 - Your driving speed: below 2 mph (3 km/h)
 - The speed of the approaching vehicle from the rear: above 4 mph (6 km/h)

⚠ WARNING

Take the following precautions when using Safe Exit Warning:

- For your safety, change the Settings after parking the vehicle at a safe location.
- If any other function's warning message is displayed or audible warning

is generated, Safe Exit Warning warning message may not be displayed and audible warning may not be generated.

- You may not hear the warning sound of Safe Exit Warning if the surroundings are noisy.
- Safe Exit Warning does not operate in all situations or cannot prevent all collisions.
- Safe Exit Warning may warn the driver late or may not warn the driver depending on driving conditions. Always check vehicle surroundings.
- The driver and passengers are responsible for accidents that occur while exiting the vehicle. Always check the surroundings before you exit the vehicle.

*** NOTICE**

- After the vehicle is turned off, Safe Exit Warning operates for 3 minutes, but turns off immediately if the doors are locked.
- Images or colors may be displayed differently depends on the instrument cluster specifications or theme.

Safe Exit Warning malfunction and limitations

Safe Exit Warning malfunction

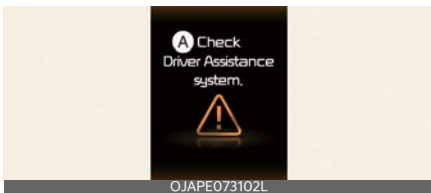

A: Check Driver Assistance system.

When Safe Exit Warning is not working properly, a warning message will appear on the instrument cluster for several seconds, and the Master warning light (⚠) will appear on the cluster. If there is a malfunction in Safe Exit Warning, a warning message will be displayed on the instrument cluster display for a certain period, and the Master warning light (⚠) will turn on. If it does not work properly, visit an authorized Kia dealer.



A: Check side-view mirror warning light

When the outside rearview mirror warning light is not working properly, a warning message will appear on the instrument cluster for several seconds, and the Master warning light (⚠) will appear on the instrument cluster.

Have Safe Exit Warning be inspected by an authorized Kia dealer.

Safe Exit Warning disabled

When the rear bumper around the rear corner radar or sensor is covered with foreign material, such as snow, rain, a trailer or carrier, it can reduce the detecting performance and temporarily limit or disable Safe Exit Warning.

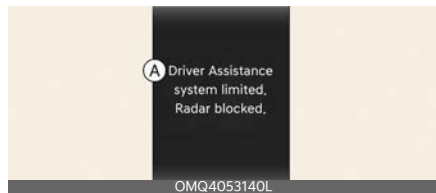

A: Driver Assistance system limited. Radar blocked.

A warning message and the Master warning light (▲) are displayed on the instrument cluster, but it does not indicate a malfunction of Safe Exit Warning. Safe Exit Warning will operate properly when such foreign material or trailer, etc., is removed, and then the vehicle is restarted.

If Safe Exit Warning does not operate properly after it is removed, have your Kia inspected by an authorized Kia dealer.

▲ WARNING

- Even though a warning message does not appear on the instrument cluster, Safe Exit Warning may not properly operate.
- Safe Exit Warning may not properly operate in an open terrain where any objects are not detected or when the detecting sensor is blocked with foreign material immediately after the vehicle is turned on, or when the detecting sensor is blocked with foreign material.

* NOTICE

You can check it in the service message of the utility information view of the instrument cluster display window.

▲ CAUTION

Turn off Safe Exit Warning to install or remove a trailer, carrier, or another attachment. Turn on Safe Exit Warning when finished.

Limitations of Safe Exit Warning

Safe Exit Warning may not operate normally, or Safe Exit Warning may operate unexpectedly under the following conditions:

- Exiting the vehicle where there is overgrown foliage
- Exiting the vehicle where the road is wet
- An approaching vehicle is moving very fast or very slow

* NOTICE

For more details on the precautions of the rear corner radars, refer to "Blind-Spot Collision-Avoidance Assist (BCA) (if equipped)" on page 7-33.

▲ WARNING

- Safe Exit Warning may not operate normally if interfered with by strong electromagnetic waves.
- Safe Exit Warning may not operate for approximately 3 seconds after the vehicle is restarted, or the rear corner radars are initialized.
- Even after starting the vehicle again, Safe Exit Warning not function properly if the obstruction or malfunction condition persists.

This device complies with Part 15 of the FCC rules.

Operation is subject to the following two conditions:

1. This device may not cause harmful interference, and
2. This device must accept any interference received, including interference that may cause undesired operation.

Manual Speed Limit Assist (MSLA)

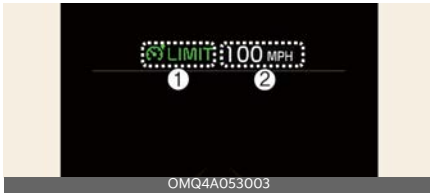

- 1 Speed Limit indicator
- 2 Set speed

You can set the speed limit when you do not want to drive over a specific speed. If you drive over the preset speed limit, Manual Speed Limit Assist operates (set speed limit will blink and chime will sound) until the vehicle speed returns within the speed limit.

Manual Speed Limit Assist operation

Setting speed limit

1. Press and hold Driving Assist (DA) button at the desired speed. The Speed Limit (LIMIT) indicator will appear on the cluster.



2. Push the (+) switch up or (-) switch down, and release it at the desired speed. The set speed will increase by 1 mph (1 km/h) each time the switch is operated in this manner. Push the (+) switch up or (-) switch down and hold it. The speed will increase or decrease to by multiple of 5 mph (10 km/h).



3. The set speed limit will be displayed on the instrument cluster. If you would like to drive over the preset speed limit, depress the accelerator pedal. The set speed limit will blink and chime will sound until you return the vehicle speed to the set limit.

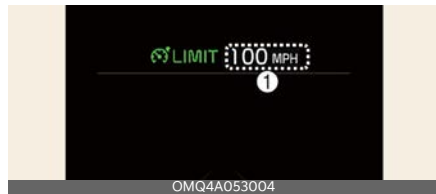

* NOTICE

To drive faster than the set speed limit, press the accelerator pedal deeply until the kickdown function activates.

Temporarily pausing Manual Speed Limit Assist



Press the (⏏) button to temporarily pause the set speed limit. The set speed limit will turn off but the Speed Limit (S LIMIT) indicator will stay on.

Resuming Manual Speed Limit Assist



To resume Manual Speed Limit Assist after the function was paused, operate the (+), (-), (⏏) switch.

If you push the (+) switch up or (-) switch down, vehicle speed will be set to the current speed on the instrument cluster.

If you press the (⏏) button, vehicle speed will resume to the preset speed.

Turning off Manual Speed Limit Assist



Press the Driving Assist (DA) button to turn Manual Speed Limit Assist off. The Speed Limit (S LIMIT) indicator will go off.

⚠ WARNING

Take the following precautions when using Manual Speed Limit Assist:

- Always set the vehicle speed under the posted speed limit.
- Keep Manual Speed Limit Assist off when the function is not in use, to avoid inadvertently setting a speed. Check that the Speed Limit (S LIMIT) indicator is off.
- Manual Speed Limit Assist does not substitute for proper and safe driving. It is the responsibility of the driver to always drive safely and to be aware of unexpected and sudden situations. Pay attention to the road conditions at all times.

Intelligent Speed Limit Assist (ISLA) (if equipped)

Intelligent Speed Limit Assist uses information from the detected road signs and uses the navigation system data to inform you of the posted speed limit and to help you maintain it.

CAUTION

- Intelligent Speed Limit Assist may not operate properly if the function is used in other countries.
- If a navigation is applied to your vehicle, the navigation needs to be regularly updated for Intelligent Speed Limit Assist to operate properly.

Detecting sensor

Front camera



CAUTION

For more details on the precautions of the front view camera, refer to "Forward Collision-Avoidance Assist (FCA) (Sensor Fusion)" on page 7-5.

Intelligent Speed Limit Assist settings

Speed Limit



- 1 Driver Assistance
- 2 Speed Limit
- 3 Speed Limit Assist
- 4 Speed Limit Warning
- 5 Off

With the vehicle on, select **Setup** → **Vehicle** → **Driver Assistance** → **Speed Limit** on the infotainment system.

- **Country Selection:** If navigation is not enabled, you can manually select the country from the menu. Please select the country you are currently driving in for proper functionality.
- **Speed Limit Offset:** The offset for Speed limit can be adjusted. The vehicle will warn the speed limit or adjust the driving speed when the current driving speed is higher than the recognized speed limit added with set tolerance value.
- **Speed Limit Assist:** Intelligent Speed Limit Assist will inform the driver of speed limit and additional road signs and warn the driver when the vehicle is driven faster than the speed limit. Intelligent Speed Limit Assist will also inform the driver to change set speed of Manual Speed Limit Assist or Smart Cruise Control to help the driver stay within the speed limit.

- **Speed Limit Warning:** Intelligent Speed Limit Assist will inform the driver of speed limit and additional road signs. Intelligent Speed Limit Assist will also warn the driver when the vehicle is driven faster than the posted speed limit.
- **Off:** Intelligent Speed Limit Assist will turn off.

⚠ WARNING

Be sure to park in a safe place before setting Intelligent Speed Limit Assist.

* NOTICE

- Speed limit and Speed warning function operates based on an offset value added to the speed limit. Set the offset value to '0' to change or warn the speed according to the posted speed limit.
- The setting of Speed limit offset is not reflected in Navigation-based Smart Cruise Control.

Intelligent Speed Limit Assist operation

Warning and control

Intelligent Speed Limit Assist is warned and controlled by the following level.

- Displaying speed limit
- Speeding warning
- Changing set speed
- Auto set speed change

* NOTICE

- Intelligent Speed Limit Assist warning and control are described based on the Offset adjust to '0'. For details on Offset setting, refer to "Intelligent

Speed Limit Assist settings" on page 7-48.

Displaying speed limit



Speed limit information is displayed on the instrument cluster.

* NOTICE

- If speed limit information of the road cannot be recognized, '---' sign will be displayed. Please refer to "Intelligent Speed Limit Assist malfunction and limitations" on page 7-51 if the road signs are difficult to recognize.
- Intelligent Speed Limit Assist provides additional road sign information in addition to speed limit. Additional road sign information provided may vary according to your region.
- The images and colors in the instrument cluster may differ depending on the instrument cluster type or theme selected from the settings menu.

Speeding warning

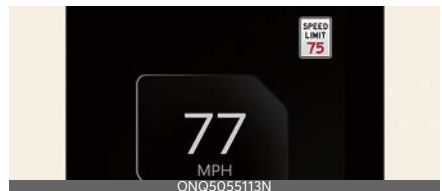

When driving at a speed higher than the displayed speed limit, the red speed limit indicator will appear.

Changing set speed

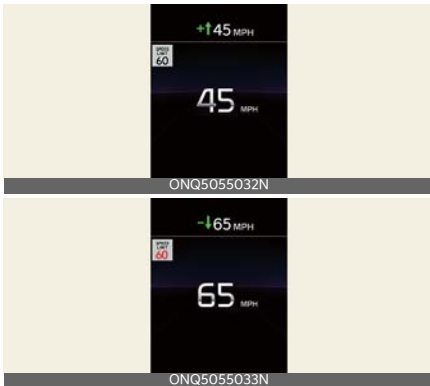

If the speed limit of the road changes during the operation of Manual Speed Limit Assist or Smart Cruise Control, an arrow in the direction of up or down is displayed to inform the driver that the set speed needs to be changed. The driver can change the set speed according to the speed limit by using the (+) or (-) switch on the steering wheel.

Auto set speed change (if the navigation equipped)



When operating Manual Speed Limit Assist or Smart Cruise Control, if the speed set by the driver is the same as the speed limit on the road, the set speed is automatically adjusted accordingly the speed limit afterward. The auto set speed change function operates on roads with a speed limit of above 45 mph (70 km/h). When the function is activated, the set speed on the instrument cluster is displayed in green.

⚠ WARNING

- When driving at a speed lower than the speed limit, set the offset under '0', or press (-) switch to decrease your set speed.
- Even after changing the set speed according to the speed limit of the road, the vehicle can still be driven over the speed limit. If necessary, depress the brake pedal to reduce your speed.
- If the posted speed limit is under 20 mph (30 km/h), the set speed change and auto set speed change function will not work.
- Intelligent Speed Limit Assist operates using the speed unit in the instrument cluster set by the driver. If the speed unit is set to a unit other than the speed unit used in your state, Intelligent Speed Limit Assist may not operate properly. (Except Australia/Russia)

* NOTICE

- For more details on Manual Speed Limit Assist operation, refer to "Manual Speed Limit Assist (MSLA)" on page 7-46.
- For more details on Smart Cruise Control operation, refer to "Smart Cruise Control (SCC)" on page 7-62.

Intelligent Speed Limit Assist malfunction and limitations

Intelligent Speed Limit Assist malfunction

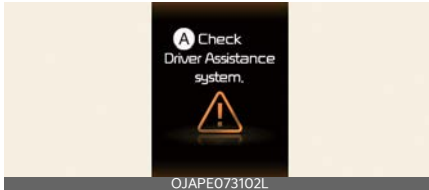

A: Check Driver Assistance system.

When Intelligent Speed Limit Assist is not working properly, a warning message will appear on the cluster for several seconds, the Master warning light (▲), and the Intelligent Speed Limit Assist warning light (☐) will appear on the cluster.

If this occurs, have the vehicle inspected by an authorized Kia dealer.

Intelligent Speed Limit Assist disabled

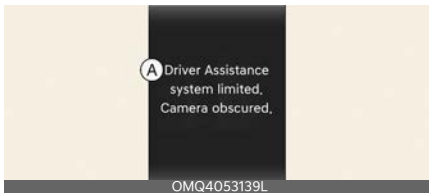

A: Driver Assistance system limited. Camera obscured.

When the windshield where the front view camera is located is covered with foreign material, such as snow or rain, it can reduce the detecting performance and temporarily limit or disable Intelligent Speed Limit Assist. If this occurs, a warning message and the Intelligent Speed Limit Assist warning light (☐) will appear on the cluster.

Intelligent Speed Limit Assist will operate properly when snow, rain or foreign

material is removed. Always keep it clean.

If Intelligent Speed Limit Assist does not operate properly after it is removed, have your vehicle checked by an authorized Kia dealer.

⚠ WARNING

- Even though a warning message or warning light does not appear on the cluster, Intelligent Speed Limit Assist may not operate properly.
- Even if restarting the vehicle with the sensors blocked or malfunctioned, Intelligent Speed Limit Assist may not properly operate as the function maintains the broken/covered state.

* NOTICE

You can check it in the service message of the utility information view of the cluster display window.

Limitations of Intelligent Speed Limit Assist

Intelligent Speed Limit Assist may not operate properly, or it may operate unexpectedly under the following circumstances:

- The road sign is contaminated or indistinguishable
 - The road sign is difficult to see due to bad weather, such as rain, snow, fog.
 - The road sign is partially obscured by surrounding objects or shadow
- The road signs do not conform to the standard
 - The text or picture on the road sign is different from the standard

- The road sign is installed between the main line and the exit road or between diverging roads
- A sign is attached to another vehicle such as a construction truck
- The distance between the vehicle and the road signs is far
- The vehicle encounters illuminating road signs
- Intelligent Speed Limit Assist incorrectly recognizes numbers or pictures in the street signs or other signs as the speed limit
- A road sign near the road you are driving is detected
- Multiple signs are installed close together
- The minimum speed limit sign is misidentified
- The minimum speed limit sign is on the road
- The brightness changes suddenly, for example when entering or exiting a tunnel or passing under a bridge
- Headlamps are not used or the brightness of the headlamps are weak at night or in the tunnel
- The field of view of the front view camera is obstructed by sun glare
- Road signs are difficult to recognize due to the reflection of sunlight, streetlights, or oncoming vehicles
- The navigation information or GPS information contains errors.
- The driver does not follow the guide of the navigation.
- Driving on a road that is sharply curved or continuously curved
- Driving through speed bumps, or driving up and down or left to right on steep inclines

- The vehicle is shaking heavily
- Driving on a new road
- Driving on a road under construction.
- When the navigation software updates during driving
- when the navigation re-start during driving

WARNING

- Intelligent Speed Limit Assist is a supplemental function that can help the driver to comply with the speed limit on the road. It is not a substitute for driver attention.
- It is the responsibility of the driver to follow the speed limit.
- It may not operate for 15 seconds after the vehicle is started, or the front view camera is initialized or restarted.

NOTICE

For more details on the limitations of the front view camera, refer to "Forward Collision-Avoidance Assist (FCA) (Sensor Fusion)" on page 7-5.

Driver Attention Warning (DAW)

Inattentive Driving Warning function

Driver Attention Warning monitors your driving pattern while driving. When it detects that the driver's attention level is below a certain level, Driver Attention Warning recommends a break to help with safe driving.

Leading Vehicle Departure Alert function

Leading Vehicle Departure Alert function will inform the driver when a detected vehicle in front departs from a stop.

Detecting sensor

Front camera



The front view camera is used as a detecting sensor to help detect driving patterns and front vehicle departure while vehicle is being driven. Refer to the picture above for the detailed location of the detecting sensor.

CAUTION

- Always keep the front view camera in good condition to maintain optimal performance of DAW.
- For more details on the precautions of the front view camera, refer to "Forward Collision-Avoidance Assist (FCA) (Sensor Fusion)" on page 7-5.

Driver Attention Warning settings



1 Driver Assistance

2 Driver Attention Warning

3 Leading Vehicle Departure Alert

4 Inattentive Driving Warning

With the vehicle on, select **Setup** → **Vehicle** → **Driver Assistance** → **Driver Attention Warning** → **Leading Vehicle Departure Alert** on the infotainment system.

- **Leading Vehicle Departure Alert:** Driver Attention Warning will inform the driver when a detected vehicle in front departs from a stop.
- **Inattentive Driving Warning:** Inattentive Driving Warning can be turned on or off.

Warning Methods

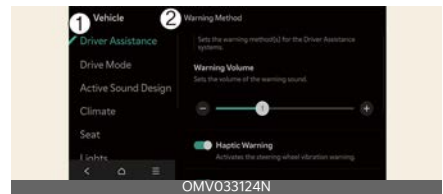

1 Driver Assistance

2 Warning Methods

The **Warning Methods** can be set with the vehicle on. Select **Setup** → **Vehicle** → **Driver Assistance** → **Warning Methods** → **Warning Volume** from the settings menu in the infotainment system to change the following settings:

- **Warning Volume:** Adjusts the volume of the warning sound.
- **Driving Safety Priority:** Lowers all other audio volumes when the Driving Safety system sounds a warning.

*** NOTICE**

- Ensure that **Warning Methods** you have set may apply to the **Warning Methods** of other driver assistance systems.
- **Warning Methods** will maintain its last setting even if the vehicle is restarted.
- The setting menu may not be available for your vehicle depending on the vehicle features and specifications.

Driver Attention Warning operation

Inattentive Driving Warning function

The basic function of Driver Attention Warning is as follows.

- Taking a break

Taking a break



A: Consider taking a break

The inattentive warning light (A) blinking and warning message will appear on the instrument cluster and an audible warning will sound to suggest that the driver take a break, when the driver's attention level is below a certain level.

- Driver Attention Warning will not suggest a break when the total driving time is shorter than 4 minutes or 4 minutes has not passed after the last break was suggested.

⚠ WARNING

For your safety, change the Settings after parking the vehicle at a safe location.

⚠ CAUTION

- Driver Attention Warning may suggest a break depending on the driver's driving pattern or habits, even if the driver doesn't feel fatigue.
- Driver Attention Warning is a supplemental function and may not be able to determine whether the driver is inattentive.
- If you feel fatigued, you should take a break at a safe location, even if there is no break suggestion by Driver Attention Warning.

Leading Vehicle Departure Alert function

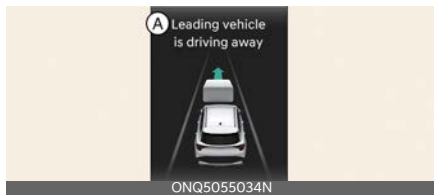

A: Leading vehicle is driving away

When a detected vehicle in front departs from a stop, Leading Vehicle Departure Alert will inform the driver by displaying a warning message on the cluster and an audible warning will sound.

⚠ WARNING

- If any other function's warning message is displayed or audible warning is generated, Leading Vehicle Departure Alert's warning message may not be displayed and audible warning may not be generated.
- The driver should hold the responsibility to safely drive and control the vehicle.

⚠ CAUTION

- Leading Vehicle Departure Alert is a supplemental function and may not alert the driver whenever the front vehicle departs from a stop.
- Always check the front of the vehicle and road conditions before departure.

*** NOTICE**

The images and colors in the instrument cluster may differ depending on the cluster type or theme selected from the settings menu.

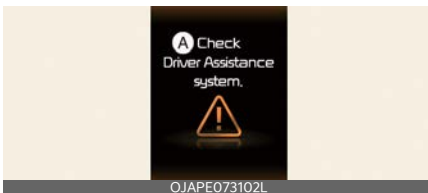
Driver Attention Warning malfunction and limitations**Driver Attention Warning malfunction****A: Check Driver Assistance system.**

When Driver Attention Warning is not working properly, a warning message will appear on the cluster for several seconds, the Master warning light (⚠) and

the inattentive warning light (🚦) will appear on the cluster.

If this occurs, have Driver Attention Warning inspected by an authorized Kia dealer.

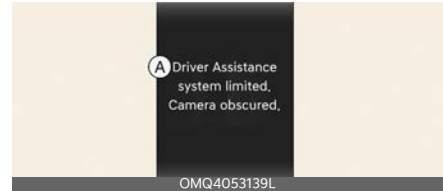
Driver Attention Warning disabled**A: Driver Assistance system limited. Camera obscured.**

When the front windshield (where the front view camera is located), front radar cover, bumper or sensor is covered with foreign material, such as snow or rain, it can reduce the detecting performance and temporarily limit or disable Driver Attention Warning.

A warning message, the inattentive warning light (🚦) and the Master warning light (⚠) will appear on the cluster.

Driver Attention Warning will operate properly when snow, rain or foreign material is removed.

If Driver Attention Warning does not operate properly after obstruction (snow, rain, or foreign material) is removed (including trailer, carrier, etc. from the rear bumper), have your Kia inspected by an authorized Kia dealer.

⚠ WARNING

- Even though a warning message or warning light does not appear on the instrument cluster, Driver Attention Warning may not properly operate.

- Driver Attention Warning may not properly operate in an open area where there is nothing to detect or the detecting sensor is covered with foreign material after turning ON the vehicle.

*** NOTICE**

You can check it in the service message of the utility information view of the instrument cluster display window.

Limitations of Driver Attention Warning

Driver Attention Warning may not work properly in the following situations:

- The vehicle is driven violently
- The vehicle intentionally crosses over lanes frequently
- The vehicle is controlled by Driver Assistance system, such as Lane Keeping Assist
- When lanes are blurred or disappear

Leading vehicle departure alert function

- When a vehicle cuts in



ONQ5H054046



ONQ5H054045

[1]: Your vehicle, [2]: Front vehicle

If a vehicle cuts in front of you, Leading Departure Alert may not operate properly.

- When the vehicle ahead sharply steers



ONQ5H054047

[1]: Your vehicle, [2]: Front vehicle

If a vehicle in front makes a sharp turn, such as to turn left or right or making a U-turn, etc., Leading Vehicle Departure Alert may not operate properly.

- When the vehicle ahead abruptly departs



ONQ5H054048

If the vehicle in front abruptly departs, Leading Vehicle Departure Alert may not operate properly.

- When a pedestrian or bicycle is between you and the vehicle ahead



ONQ5H054049

If there is a pedestrian(s) or bicycle(s) in between you and the vehicle in front, Leading Vehicle Departure Alert may not operate properly.

- When in a parking lot



If a vehicle parked in front drives away from you, Leading Vehicle Departure Alert may alert you that the parked vehicle is driving away.

- When driving at a tollgate or intersection



If you pass a tollgate or intersection with lots of vehicles or you drive where lanes are merged or divided frequently, Leading Vehicle Departure Alert may not operate properly.

WARNING

Driver Attention Warning may not operate for 15 seconds after the vehicle is started, or the front view camera is initialized.

NOTICE

For more details on the precautions of the front view camera, refer to "Forward Collision-Avoidance Assist (FCA) (Sensor Fusion)" on page 7-5.

Forward Attention Warning (FAW) (if equipped)

Forward Attention Warning uses the in-cabin camera to help prevent the driver from being distracted while driving with an audible warning and warning light.

Detecting sensor



1 In-cabin camera

The picture above shows the detailed location of the detecting sensor.

CAUTION

Always keep the in-cabin camera in good condition to maintain optimal performance of Forward Attention Warning.

Forward Attention Warning settings

Forward attention warning

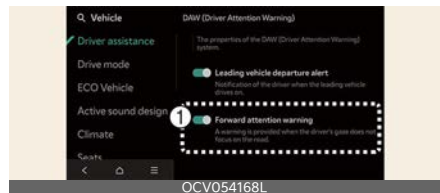

1. Forward Attention Warning

With the vehicle on, select **Settings** → **Vehicle** → **Driver assistance** → **DAW (Driver Attention Warning)** → **Forward attention warning** in the infotainment system to set whether to use the function.

- **Forward Attention Warning:** It will warn the driver when the driver's gaze is not focused on the road.

* INFORMATION

Forward Attention Warning will always turn on when the vehicle restarts.

Forward Attention Warning operation

Forward Attention Warning

Forward Attention Warning determines whether the driver is focused on the road according to information such as the amount of time the driver is looking elsewhere, the amount of time the eyes are closed, and so on. If it determines the driver is not focused, an audible warning sounds for about 1 second, and the Forward attention warning light (👁️) appears on the cluster until the conditions to turn it off are met.

Operating conditions

- When the driver's gaze is not focused on the road continuously for 3 seconds while driving above 12 mph (20 km/h)
- When glances away from the road total 10 seconds or more within a 30-second time frame in a car traveling at a speed of 12 mph (20 km/h) or more
- When the driver's eyes are closed for 2 seconds or more while driving above 6 mph (10 km/h)

Off conditions

- When the driver looks forward continuously for over 2 seconds

Driver Drowsiness Attention Warning

The Driver Drowsiness Attention Warning monitors your eyes while driving. When the driver's eyes are constantly closed or not facing forward frequently, the Driver Drowsiness Attention Warning recommends a break to help with safe driving.

A warning message and the Inattentive warning light (👁️) appears on the cluster, and an audible warning sounds until the conditions to turn it off are met.

Warning message: **Consider taking a break**

Operating conditions

- When the driver's eyes are constantly closed or not facing forward frequently while driving above 6 mph (10 km/h)

Off conditions

- When the driver's gaze is focused on the road

⚠️ WARNING

If any other system's warning message is displayed or audible warning is generated, Forward Attention Warning's warning message may not be displayed and an audible warning may not be generated.

⚠️ CAUTION

- Forward Attention Warning may warn the driver even when the driver is focused on the road due to their driving style or driving pattern.
- Forward Attention Warning is a supplemental function and may not

determine whether the driver is distracted while driving.

- The driver is responsible for safe driving and must focus on the road.

* INFORMATION

- Forward Attention Warning does not transmit recorded videos outside the vehicle or store the video.
- The Warning Method for Forward Attention Warning cannot be changed.

Forward Attention Warning malfunction and limitations

* NOTICE

- The following warning message will appear on the LCD display.
For more details, refer to the malfunction and limitations section of the function.
 - **Check forward attention warning system**
 - **Forward attention warning disabled. Camera obscured**

Forward Attention Warning malfunction

When Forward Attention Warning is not working properly, the warning message appears on the instrument cluster for several seconds, the Forward attention warning light (👁️) lights up on the instrument cluster, and an audible warning sounds until it is working properly.



A: Check forward attention warning system

If this occurs, have the function inspected by an authorized Kia dealer.

Forward Attention Warning disabled

When there is an object right in front of the in-cabin camera or between the driver and the camera for a certain period of time, Forward Attention Warning does not operate properly. If this occurs, the warning message appears on the instrument cluster for several seconds, the Forward attention warning light (👁️) lights up on the instrument cluster, and an audible warning sounds until it is working properly.

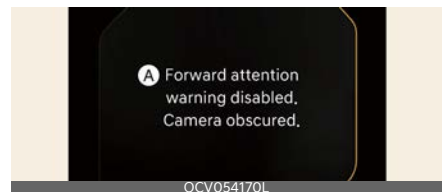

A: Forward attention warning disabled. Camera obscured.

If the object is removed or the camera is able to detect the driver's face, the function will operate normally. If Forward Attention Warning does not operate properly after the object is removed, have the function inspected by an authorized Kia dealer.

⚠ CAUTION

- Do not impact the surface of the camera or around the camera. If the in-cabin camera is damaged, Forward Attention Warning may not work properly.
- Do not place anything on the camera or in front of the camera while driving. The in-cabin camera may not operate properly.
- When cleaning the camera, wipe with a soft and clean cloth to prevent damage to the surface of the camera lens. In addition, do not use sharp tools near the camera and do not use chemicals to clean the camera.
- Always keep the camera and its surroundings clean and dry.
- Do not place foreign objects, such as stickers, around the infrared LED located near the camera.

*** INFORMATION**

Two red lights may appear on the camera in the following conditions:

- The outside brightness is dim or when driving at night
- The vehicle drives inside a building, such as a basement car park, garage or tunnel
- The camera case is partially broken

Limitations of Forward Attention Warning

Forward Attention Warning may not operate properly or may operate unexpectedly under the following circumstances:

- The driver is wearing sunglasses, special glasses, infrared cutoff glasses, refracting glasses or thick glasses

- The driver has heavy eye makeup (eyeliner, mascara, color makeup, false eyelash) or piercings around the eyes
- The view of the driver is blocked by their hair, hat, etc.
- The driver is winking or wearing an eye patch on one eye
- The driver's face is covered partially by a mask, muffler, etc.
- The view of the driver is blocked by incoming light from outside the vehicle
- Light from outside, sunlight or infrared LED light of the camera is reflected by glasses or sunglasses
- The driver turns or lowers their head so that the face or eyes are hidden from the camera
- The driver shakes their head or adverse road conditions cause excessive vehicle vibrations while driving
- The driver is improperly positioned in the driver's seat so that their face is not detected
- The driver is too tall or short
- The camera is blocked by the driver's grip on the steering wheel
- More than two people are looking at the instrument cluster simultaneously from the driver's seat
- The driver's eyes are narrowed due to laughing or sun glare
- The camera incorrectly recognizes a picture or mannequin that is of similar size to the driver's face
- There are other devices using infrared light in the vehicle

Blind-Spot View Monitor (BVM) (if equipped)

Left side



Right side



Blind-Spot View Monitor displays the rear blind spot area of the vehicle in the cluster when the turn signal is turned on to help safely change lanes.

Detecting sensor

Wide-side view camera (if equipped)



(camera located at bottom of the outside rearview mirror)

Refer to the picture above for the detailed location of the detecting sensors.

Blind-Spot View Monitor settings

Blind-Spot View

With the vehicle on, select **Driver Assistance** → **Blind-Spot Safety** → **Blind-Spot View** from the Settings menu to turn on Blind-Spot View Monitor and deselect to turn off the function.

Blind-Spot View Monitor operation

Turn signal switch



Blind-Spot View Monitor will turn on and off when the turn signal is turned on and off.

Blind-Spot View Monitor

Operating conditions

- When the left or right turn signal turns on, the image on the instrument cluster will turn on.

Off conditions

Blind-Spot View Monitor will turn off when one of the following conditions are satisfied:

- When the turn signal is turned off.
- When the hazard warning flasher is on.
- When other important warning is displayed on the instrument cluster.

Blind-Spot View Monitor malfunction

When Blind-Spot View Monitor is not working properly, or the cluster display flickers, or the camera image does not display normally, have Blind-Spot View Monitor inspected by an authorized Kia dealer.

WARNING

- The image shown on the cluster may differ from the actual distance of the object. Make sure to directly check the vehicle's surroundings for safety.
- If the camera lens is covered with foreign material, Blind-Spot View Monitor may not operate normally.

Always keep the camera lens clean.

However, do not use chemical solvents such as strong detergents containing high alkaline or volatile organic solvents (gasoline, acetone etc.). This may damage the camera lens.

Smart Cruise Control (SCC)

Basic function

Smart Cruise Control detects a vehicle ahead and can help maintain the distance from the vehicle ahead and the set speed.

Overtake Acceleration Assist function

When Smart Cruise Control judges you are attempting to overtake a vehicle in front, Smart Cruise Control helps with accelerating.

Based On Driving Style function (if equipped)

Smart Cruise Control will operate based on the driver's driving style, such as inter-vehicle distance, acceleration, reaction speed.

NOTICE

Emergency stop may be activated while Smart Cruise Control is in operation. Make sure to understand the contents of the Emergency Stop (ES).

Detecting sensors

Front camera



Front radar



Front corner radar (if equipped)



⚠ CAUTION

- Always keep the front view camera and front radar in good condition to maintain optimal performance of Smart Cruise Control.
- For more details on the precautions of the front view camera and front radar, refer to "Forward Collision-Avoidance Assist (FCA) (Sensor Fusion)" on page 7-5.

Smart Cruise Control settings

Smart Cruise Control

With the vehicle on, select **Setup** → **Vehicle** → **Driver Assistance** → **Smart Cruise Control** on the infotainment system to set the distance, acceleration and the reaction speed.

Based on driving style (if equipped)

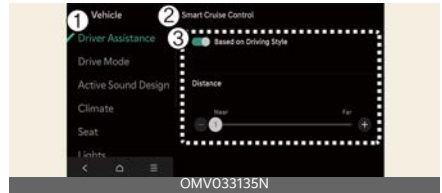

- 1 Driver Assistance
- 2 Smart Cruise Control
- 3 Based on Driving Style

With the vehicle on, if **Setup** → **Vehicle** → **Driver Assistance** → **Smart Cruise Control** → **Based on Driving Style** is selected from the infotainment system screen, Smart Cruise Control will operate based on the driver's driving style, such as vehicle distance, acceleration, reaction speed.

The driving style can be adjusted manually.

* NOTICE

- If equipped with Based on Driving Style, Based on driving mode and Based on driving style can be selected from the infotainment system screen by selecting **Setup** → **Vehicle** → **Driver Assistance** → **Smart Cruise Control**.
- While Smart Cruise Control is operating with Based on driving style selected, if you press and hold the Vehicle Distance (🚗) button, based on

driving mode will be disabled. Press and hold the Vehicle Distance (🚗) button to change Smart Cruise Control to Based on Driving Style mode.

- Smart Cruise Control learns your driving styles only when drive the vehicle.
- When Based On Driving Style is disabled, your driving style (inter-vehicle distance, acceleration, response speed) remains at the same level as the Based On Driving Style.
- When the Based On Driving Style is enabled or disabled, the displayed driving style (including inter-vehicle distance, acceleration, and response speed) may vary between different controlled styles.

Warning Methods

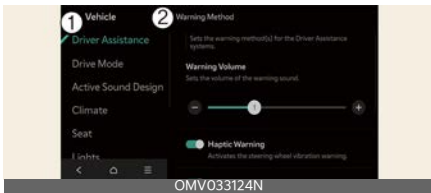

- 1 Driver Assistance
- 2 Warning Methods

The **Warning Methods** can be set with the vehicle on. Select **Setup** → **Vehicle** → **Driver Assistance** → **Warning Methods** → **Warning Volume** from the settings menu in the infotainment system to change the following settings:

- **Warning Volume:** Adjusts the volume of the warning sound.
- **Haptic Warning:** Activate the steering wheel vibration warning.
- **Driving Safety Priority:** Lowers all other audio volumes when the Driving Safety system sounds a warning.

* NOTICE

- Ensure that **Warning Methods** you have set may apply to the **Warning Methods** of other driver assistance systems.
- **Warning Methods** will maintain its last setting even if the vehicle is restarted.
- The setting menu may not be available for your vehicle depending on the vehicle features and specifications.

Smart Cruise Control operation Operating conditions

Basic function

Smart Cruise Control operates when the following conditions are satisfied.

- The gear is in D (Drive)
- Your driving speed is within the operating speed range
 - 5-125 mph (10-200 km/h): when there is no vehicle in front
 - 0-125 mph (0-200 km/h): when there is a vehicle in front
- ESC (Electronic Stability Control) or ABS is on

Smart Cruise Control does not operate in the following conditions.

- The driver's door is open
- Engine RPM is high
- EPB (Electronic Parking Brake) is applied
- ESC (Electronic Stability Control) or ABS is controlling the vehicle
- Forward Collision-Avoidance Assist brake control is operating
- Remote Smart Parking Assist brake control is operating (if equipped)

* NOTICE

When stopped behind another vehicle, you can turn on Smart Cruise Control while the brake pedal is depressed.

Overtake Acceleration Assist function

Overtaking Acceleration Assist will operate when the turn signal indicator is turned on to the left (left-hand drive) or turned on to the right (right-hand drive) while Smart Cruise Control is operating, and the following conditions are satisfied:

- Your driving speed is above 40 mph (60 km/h)

- A vehicle is detected in front of you

Overtaking Acceleration Assist does not operate in the following conditions.

- The hazard warning flasher is on
- Vehicle speed is reduced to maintain distance with a vehicle in front

⚠ WARNING

- When the turn signal indicator is turned on to the left (left-hand drive) or turned on to the right (right-hand drive) while there is a vehicle ahead, the vehicle may accelerate temporarily. Always pay attention to the road conditions.
- Regardless of your country's driving direction, Overtaking Acceleration Assist will operate when the conditions are satisfied. When using the function in countries with different driving direction, always check the road conditions.

Turning on Smart Cruise Control



Press the Driving Assist button to turn on Smart Cruise Control. The set speed will be set to the current speed on the cluster.

- If there is no vehicle in front of you, the set speed will be maintained.
- If there is a vehicle in front of you, the speed may be adjusted to maintain the distance to the vehicle ahead. If the vehicle ahead accelerates, your vehicle will travel at a steady cruising speed after accelerating to the set speed.

* NOTICE

- If your vehicle speed is between 0-20 mph (0-30 km/h) when you press the Driving Assist button, the Smart Cruise Control speed will be set to 20 mph (30 km/h).
- If the driver changes to the lower gear, the driving speed may not reach the set speed.

Setting vehicle distance



Each time the button is pressed, the headway changes as follows:

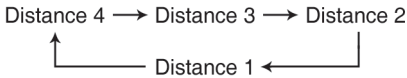

For example, if you drive at 56 mph (90 km/h), the distance is maintained as follows:

- Distance 4: approximately 172 ft (52.5 m)
- Distance 3: approximately 130 ft (40 m)
- Distance 2: approximately 106 ft (32.5 m)
- Distance 1: approximately 82 ft (25 m)

* NOTICE

The distance is set to the last set distance when the vehicle is restarted, or when Smart Cruise Control was temporarily canceled.

Increasing set speed



- Push the (+) switch up and release it immediately. The set speed will increase by 1 mph (1 km/h) each time the switch is operated in this manner.

- Push the (+) switch up and hold it. The set speed will increase by 5 mph (10 km/h) each time the switch is operated in this manner. You can increase the set speed to 125 mph (200 km/h).

⚠ WARNING

Check the driving condition before using the (+) switch. Driving speed may sharply increase when you push up and hold the (+) switch.

Decreasing set speed



- Push the (-) switch down and release it immediately. The set speed will decrease by 1 mph (1 km/h) each time the switch is operated in this manner.
- Push the (-) switch down and hold it. The set speed will decrease by 5 mph (10 km/h) each time the switch is operated in this manner. You can decrease the set speed to 20 mph (30 km/h).

Temporarily canceling Smart Cruise Control



Press the (|||) button or press the brake pedal to temporarily cancel Smart Cruise Control.

Resuming Smart Cruise Control



To resume Smart Cruise Control after the function was canceled, operate the (+), (-) or (||◁) switch.

If you push the (+) switch up or (-) switch down, the set speed will be set to the current speed on the cluster.

If you press the (||◁) button, vehicle speed will resume to the preset speed.

⚠ WARNING

Check the driving conditions before using the (||◁) button. Driving speed may sharply increase or decrease when you press the (||◁) button.

Turning off Smart Cruise Control



Press the Driving Assist button to turn Smart Cruise Control off.

*** NOTICE**

If your vehicle is equipped with Manual Speed Limit Assist, press and hold the Driving Assist button to turn off Smart Cruise Control. However, Manual Speed Limit Assist will turn on.

⚠ WARNING

Do not use the switches and buttons at the same time. Smart Cruise Control may not operate properly.

Smart Cruise Control display and control

You can see the status of the Smart Cruise Control operation in the Driving Assist view on the instrument cluster.

Refer to "LCD display" on page 5-89.

Smart Cruise Control will be displayed as below depending on the status of the function.



Smart Cruise Control will be displayed as below depending on the status of the function.

- When operating
 1. Whether there is a vehicle ahead and the selected distance level
 2. Set speed
 3. Whether there is a vehicle ahead and the target vehicle distance
- When temporarily canceled
 1. Your vehicle (gray)
 2. Previous set speed (gray)
 3. Whether there is a vehicle ahead (gray) (if equipped)

*** NOTICE**

- The distance of the front vehicle on the instrument cluster is displayed according to the actual distance between your vehicle and the vehicle ahead.

- The target distance may vary according to the vehicle speed and the set distance level. If vehicle speed is low, even though the vehicle distance has changed, the change of the target vehicle distance may be small.
- The images or colors displayed on the cluster may vary depending on the instrument cluster specifications or themes.

Accelerating temporarily



If you want to speed up temporarily without altering the set speed while Smart Cruise Control is operating, depress the accelerator pedal. While the accelerator pedal is depressed, the set speed, distance level and target distance will blink on the instrument cluster. However, if the accelerator pedal is depressed insufficiently, the vehicle may decelerate.

⚠ WARNING

Be careful when accelerating temporarily as, because the speed and distance is not controlled automatically even if there is a vehicle in front of you.

Based on Driving Style operating



When the Based on Driving Style is enabled, the instrument cluster will show the set vehicle distance level and target vehicle distance in white. It will also display the distance level and target distance based on your driving behavior.

Temporarily canceling Smart Cruise Control

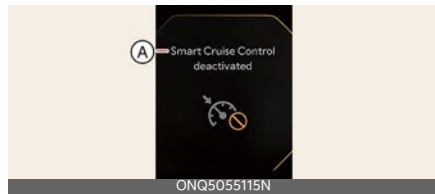

A: Smart Cruise Control deactivated

If Smart Cruise Control is temporarily canceled automatically, a warning message will appear on the instrument cluster, and an audible warning will sound to warn the driver.

Smart Cruise Control will be temporarily canceled automatically when:

- Your driving speed is above 130 mph (210 km/h)
- The vehicle is stopped for a certain period
- The accelerator pedal is continuously depressed for a certain period
- The conditions for the Smart Cruise Control to operate are not satisfied

*** NOTICE**

If Smart Cruise Control is temporarily canceled while the vehicle is at a standstill with the function activated, EPB (Electronic Parking Brake) maybe applied.

▲ WARNING

When Smart Cruise Control is temporarily canceled, the distance to a vehicle in front will not be maintained. Always have your eyes on the road and, if necessary, depress the brake pedal to reduce your speed to maintain a safe distance.

Smart Cruise Control conditions not satisfied

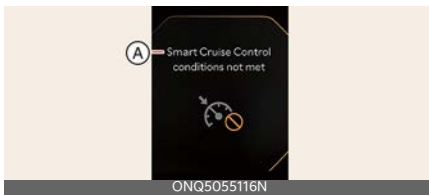

A: Smart Cruise Ctrl. conditions not met

If the Driving Assist button, (+) switch, (-) switch or (||◁) button is operated when Smart Cruise Control operating conditions are not satisfied, a warning message will appear on the instrument cluster and an audible warning will sound.

In traffic situation



A: Use switch or pedal to accelerate

In traffic, your vehicle will stop if the vehicle ahead of you stops. If the vehicle ahead starts moving, your vehicle will start as well.

After the vehicle has stopped and a certain time has passed, a warning message will appear on the instrument cluster. Depress the accelerator pedal or operate the (+) switch, (-) switch or (||◁) button to start driving.

*** NOTICE**

If your vehicle is equipped with an in-cabin camera, the system may allow a longer stop time before automatic departure based on the driver's forward gaze.

Warning road conditions ahead



A: Watch for surrounding vehicles

In the following situation, a warning message will appear on the instrument cluster, and an audible warning will sound to warn the driver of road conditions ahead.

⚠ WARNING

Always pay attention to vehicles or objects that may suddenly appear in front of you, and if necessary, depress the brake pedal to reduce your speed to maintain a safe distance.

Collision Warning**A: Collision Warning**

While Smart Cruise Control is operating, when a collision risk with a vehicle ahead is high, a warning message will appear on the cluster, an audible warning will sound and the steering wheel will vibrate to warn the driver.

Always have your eyes on the road and, if necessary, depress the brake pedal to reduce your speed in order to maintain a safe distance.

⚠ WARNING

In the following situations, Smart Cruise Control may not warn the driver of a collision.

Always pay attention to road conditions.

- The distance from a vehicle ahead is near or the speed of the vehicle in front is faster or similar to yours
- The speed of a vehicle in front is very slow or is at a standstill
- The accelerator pedal is depressed right after Smart Cruise Control is turned on

- When Forward Collision-Avoidance Assist function is disabled

⚠ WARNING

- Smart Cruise Control does not substitute for proper and safe driving. It is your responsibility to always check the speed and distance to a vehicle ahead.
- Smart Cruise Control may not recognize unexpected, sudden or complex situations, so always pay attention to driving conditions and control your vehicle speed.
- Keep Smart Cruise Control off when the function is not in use to avoid inadvertently setting a speed.
- Do not open the door or leave the vehicle when Smart Cruise Control is operating, even if the vehicle is stopped.
- Always be aware of the selected speed and distance ahead.
- Keep a safe distance according to road conditions and vehicle speed. If the distance is too close when driving at high speed, a serious collision may result.
- When maintaining distance with a vehicle ahead, if that vehicle disappears from view, Smart Cruise Control may suddenly accelerate to the set speed. Always be aware of unexpected and sudden situations.
- Vehicle speed may decrease on an upward slope and increase on a downward slope.
- Always be aware of emergent situations such as when a vehicle cuts in suddenly.
- When towing a trailer or something similar, your vehicle may experience

frequent shifting and high RPM and the performance of Smart Cruise Control may be compromised. Always drive with caution.

- Turn off Smart Cruise Control when your vehicle is being towed.
 - Smart Cruise Control may not operate properly if interfered with by strong electromagnetic waves.
 - Smart Cruise Control may not detect an obstacle in front and lead to a collision. Always look ahead to prevent unexpected and sudden situations from occurring.
 - Vehicles moving in front of you with frequent lane changes may cause a delay in Smart Cruise Control reaction or may cause Smart Cruise Control to react to a vehicle that is actually in an adjacent lane. Always drive cautiously to prevent unexpected and sudden situations from occurring.
 - Always be aware of the surroundings and drive safely, even though a warning message does not appear, or an audible warning does not sound.
 - If any other function's warning message is displayed or warning sound is generated, Smart Cruise Control warning message may not be displayed and warning sound may not be heard.
 - You may not hear the warning sound of Forward Collision-Avoidance Assist if the environment is noisy.
 - The vehicle manufacturer is not responsible for any traffic violation or accident caused by the driver.
 - Always set the vehicle speed under the posted speed limit.
- If your driving style changes, distance, acceleration and reaction speed may change.

⚠ CAUTION

- Your vehicle must be driven sufficiently to analyze your actual driving style, such as vehicle distance, acceleration and reaction speed.
- Based on Driving Style may not reflect the driver's driving style or driving conditions which could affect driving safety.
- If you are driving in special conditions, such as snow, rain, fog or steep hills, your vehicle may not be driven according to your driving style.

*** NOTICE**

- Smart Cruise Control may not operate for a few seconds after the vehicle is restarted or the front view camera or front radar is initialized.
 - You may hear a sound when the brake is controlled by Smart Cruise Control.
 - Based on Driving Style may not reflect your driving style if it is not safe such as rapid acceleration.
 - Based on Driving Style does not reflect any driving style other than vehicle distance, acceleration and reaction speed.
-

Smart Cruise Control malfunction and limitations

Smart Cruise Control malfunction

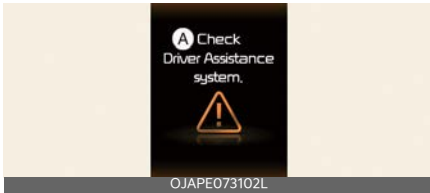

A: Check Driver Assistance system
 If there is a malfunction in Smart Cruise Control, a warning message will be displayed on the instrument cluster (and turned off after a certain period), and the Master warning light (⚠) will turn on. Have Smart Cruise Control inspected by an authorized Kia dealer.

Smart Cruise Control disabled

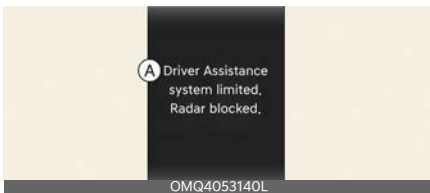

A: Driver Assistance system limited. Radar blocked.

When the front radar cover or sensor is covered with snow, rain, or foreign material, it can reduce the detecting performance and temporarily limit or disable Smart Cruise Control.

A warning messages and the Master warning light (⚠) are displayed on the instrument cluster (and turn off after a certain period). This does not indicate a malfunction of Smart Cruise Control. Smart Cruise Control will operate properly when snow, rain or foreign material is removed. Always keep it clean.

⚠ WARNING

Even though a warning message does not appear on the instrument cluster, Smart Cruise Control may not properly operate.

⚠ CAUTION

Smart Cruise Control may not properly operate in an open area where there is nothing to detect, or the detecting sensor is covered with foreign material after turning ON your vehicle.

* NOTICE

You can check it in the service message of the utility information view of the instrument cluster display window.

Limitations of Smart Cruise Control

Smart Cruise Control may not operate normally under the following circumstances:

- The detecting sensor or the surroundings are contaminated or damaged
- Washer fluid is continuously sprayed, or the wiper is on
- The camera lens is contaminated due to tinted, filmed or coated windshield, damaged glass, or sticky foreign material (sticker, bug, etc.) on the glass
- Moisture is not removed or frozen on the windshield
- The field of view of the front view camera is obstructed by sun glare
- Streetlights or light from an oncoming vehicle is reflected on a wet road.
- The temperature around the front view camera is high or low

- An object is placed on the instrument panel
- The surroundings are very bright
- The surroundings are very dark, such as in a tunnel, etc.
- The brightness changes suddenly, for example when entering or exiting a tunnel
- The brightness outside is low, and the headlight are not on or are not bright
- Driving in heavy rain, snow or thick fog
- Driving through steam, smoke or shadows
- Only part of a vehicle is detected
- A vehicle in front has no taillights, taillights are atypically located, etc.
- The brightness outside is low, and the taillights are not on or are not bright
- The rear of a front vehicle in front is small or does not look normal (for example, tilted, overturned, etc.)
- A front vehicle's ground clearance is low or high
- A vehicle suddenly cuts in front
- Your vehicle is being towed
- An object reflects off the front radar such as a guardrail, nearby vehicle, etc.
- The bumper around the front radar is impacted, damaged, or the front radar is out of position
- The temperature around the front radar is high or low
- The vehicle in front is made of material that does not reflect on the front radar
- Driving near a highway, interchange or tollgate
- Driving on a slippery surface due to snow, rain, ice, etc.
- Driving on a curved road
- A vehicle in front is detected late
- A vehicle in front is suddenly blocked by an obstacle
- A vehicle in front suddenly changes a lane or suddenly reduces speed
- A vehicle in front is bent out of shape
- A vehicle in front's speed is fast or slow
- With a vehicle in front, you change lane suddenly
- A vehicle in front is covered with snow
- Unstable driving
- You are on a roundabout (rotary) and a vehicle in front is not detected
- You are continuously driving in a circle
- Adverse road conditions cause excessive vehicle vibration
- Your vehicle height is low or high due to heavy loads, abnormal tire pressure, etc.
- Driving in the following places
 - Driving in a parking lot
 - Driving through a construction area, unpaved road, partially paved road, uneven road, speed bumps, etc.
 - Driving on an inclined road, curved road, etc.
 - Driving through a roadside with trees or streetlights
 - Driving through a narrow road with overgrown foliage
 - There is interference from electromagnetic waves, such as driving in an area with strong radio waves or electrical noise
- Driving through a tunnel or on an iron bridge

- Driving near areas containing metal substances, such as a construction zone, railroad, etc.
- Driving in wide open areas where there are few vehicles or structures
 - Driving through steam, smoke, or shadow
 - Driving near a highway interchange or tollgate
- Driving on a curved road



On curves, Smart Cruise Control may not detect a vehicle in the same lane and may accelerate to the set speed. Vehicle speed may rapidly decrease when a vehicle ahead is detected suddenly.

Select the appropriate set speed on curves and apply the brake pedal or accelerator pedal according to the road and driving conditions ahead.



Your vehicle speed can reduce due to a vehicle in an adjacent lane.

Check that the road conditions permit safe operation of Smart Cruise Control and if necessary, depress the brake pedal to reduce your driving speed to maintain a safe distance

- Driving on an incline

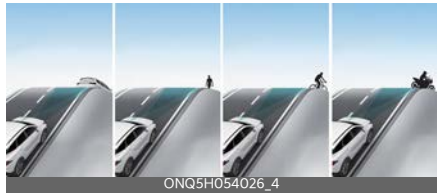

During uphill or downhill driving, the Smart Cruise Control may not detect a moving vehicle in your lane and cause your vehicle to accelerate to the set speed. Vehicle speed will rapidly decrease when a vehicle ahead is detected suddenly.

Select the appropriate set speed on inclines and apply the brake pedal or accelerator pedal according to the road and driving conditions ahead.

- Changing lanes

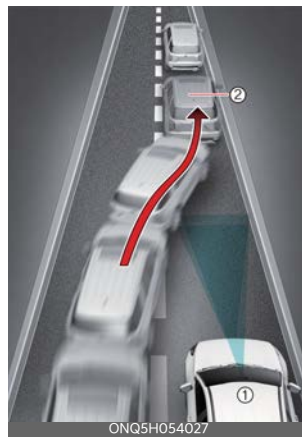

1. Your vehicle,
2. Lane changing vehicle

When a vehicle (2) moves into your lane from an adjacent lane, it cannot be detected by the sensor until it is in the sensor's detection range. Smart Cruise Control may not immediately detect the vehicle when that vehicle

changes lanes abruptly. You must maintain a safe braking distance and, if necessary, depress the brake pedal to reduce your driving speed in order to maintain a safe distance.

- Detecting a vehicle



In the following cases, some vehicles in your lane cannot be detected by the sensor:

- Vehicles offset to one side
- Slow-moving vehicles or sudden-decelerating vehicles
- Vehicles with higher ground clearance or vehicles carrying loads that stick out of the back of the vehicle
- Vehicles that have the front lifted due to heavy loads
- Vehicles within approximately 6 ft (2 m) from your vehicle
- Oncoming vehicles
- Stopped vehicles
- Vehicles with small rear profile, such as trailers
- Narrow vehicles, such as motorcycles or bicycles
- Specialty vehicles
- Animals and pedestrians



In the following cases, the vehicle in front cannot be detected by the sensor. Always pay attention to the road and driving conditions and drive safely. If necessary, adjust your vehicle speed.

- You are steering your vehicle
- Driving on narrow or sharply curved roads
- When a vehicle ahead disappears from view at an intersection



When a vehicle ahead disappears from view at an intersection, your vehicle may accelerate.

Always pay attention to road and driving conditions while driving.

- When a vehicle in front of you merges out of the lane



When a vehicle in front of you merges out of the lane, Smart Cruise Control may not immediately detect the new vehicle that is now in front of you.

Always pay attention to road and driving conditions while driving.

- Always look out for pedestrians



Always look out for pedestrians when your vehicle is maintaining a distance with the vehicle ahead.

This device complies with Part 15 of the FCC rules.

Operation is subject to the following three conditions:

1. This device may not cause harmful interference, and
2. This device must accept any interference received, including interference that may cause undesired operation.
3. Changes or modifications not expressly approved by the party responsible for compliance could void the user's authority to operate the device.

Radio frequency radiation exposure information:

This equipment complies with FCC radiation exposure limits set forth for an uncontrolled environment. This equipment should be installed and operated with minimum distance of 8 in (20 cm) between the radiator (antenna) and your body.

This transmitter must not be colocated or operating in conjunction with any other antenna or transmitter.

Emergency Stop (ES)

When determining if the driver is unresponsive, the system maintains the car in the center of the road and assists in stopping through deceleration control.

Detecting sensor

Front view camera



Front radar sensors



Refer to the picture above for the detailed location of the detecting sensors.

⚠ CAUTION

For more details on the precautions of the front view camera and front radar sensors, refer to "Forward Collision-Avoidance Assist (FCA) (Sensor Fusion)" on page 7-5.

Emergency Stop operation

Operating conditions

Emergency Stop is ready to operate when both Smart Cruise Control and Lane Following Assist operate.

- Emergency Stop is also ready to operate when both **Navigation-based Smart Cruise Control** and **Lane Following Assist** operate simultane-

ously, or **Highway Driving Assist** operates. For more information about **Smart Cruise Control**, **Navigation-based Smart Cruise Control**, **Lane Following Assist**, and **Highway Driving Assist**, refer to the "Smart Cruise Control (SCC)" on page 7-62, "Navigation-based Smart Cruise Control (NSCC) (if equipped)" on page 7-79, "Lane Following Assist (LFA)" on page 7-84, and "Highway Driving Assist (HDA) (if equipped)" on page 7-88.

- Once Emergency Stop is ready to operate, the driver's focus on the road will be monitored continuously even if Forward Attention Warning (if equipped) is turned off. For more information, refer to the "Forward Attention Warning (FAW)" section in this chapter.
- Lane Following Assist cannot be turned on if the in-cabin camera (if equipped) is malfunctioning.

Emergency Stop forewarning and braking control

Emergency Stop determines that the driver is unresponsive if the hands-off warning is continued. When the driver is determined to be unresponsive, a warning message appears on the instrument cluster, an audible warning sounds, and the steering wheel vibrates as a forewarning.

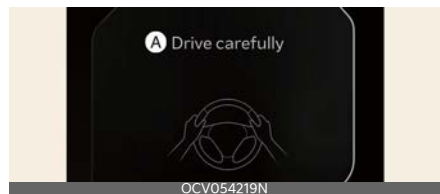

A: Drive carefully

Deceleration and steering control

If the driver is still unresponsive despite the prior warning, Emergency Stop controls the steering wheel and brake pedal to stop the vehicle within the driving lane. It is also notified to the driver that Emergency Stop is operating with a warning message, a warning sound, and vibration on the steering wheel.



A: Take control of the vehicle immediately. Vehicle is stopping.

- While Emergency Stop is operating, the vehicle distance setting of Smart Cruise Control is changed to Distance 4. The vehicle distance setting is set to the last distance setting after Emergency Stop is deactivated.

The forewarning and Emergency Stop are deactivated if one of the following conditions is met:

- The driver controls the steering wheel.
- Smart Cruise Control is temporarily disabled or turned off.
- Lane Following Assist is turned off.

After stopping

After the vehicle is stopped by ES, a warning message appears on the instrument cluster, an audible warning sounds, and the hazard warning flasher blinks.

After your vehicle has stopped, the following is performed:

- Doors are unlocked.
- SOS call is made. (if equipped)

- EPB (Electronic Parking Brake) is applied.

Deactivating Emergency Stop

If the function judges you have responded, Emergency Stop is deactivated when one of the following conditions is met:

- The driver focuses on the road ahead (if in-cabin camera equipped) and controls the steering wheel.
- The driver strongly and continuously depresses the accelerator pedal.
- The driver strongly depresses the brake pedal.
- The driver presses the Lane Driving Assist button (LDA).
- The driver presses the Driving Assist button (DA).
- The driver presses the hazard warning flasher button after the vehicle has stopped.
- The front door is opened.

The vehicle needs to be restarted to reactivate Lane Following Assist or Highway Driving Assist after the vehicle is stopped and Emergency Stop is deactivated.

⚠ CAUTION

Smart Cruise Control operation is limited if the in-cabin camera is unable to detect your face. (if equipped)

Emergency Stop malfunction and limitation

Emergency Stop malfunction

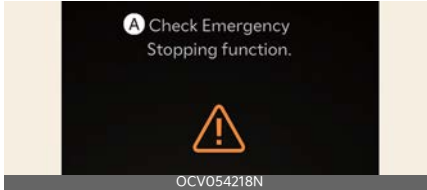

A: Check Emergency Stopping function.

When **Emergency Stop** is not working properly, the warning message and Master warning light (⚠) will appear on the cluster. If this occurs, have the function inspected by an authorized Kia dealer.

* NOTICE

You can check it in the service message of the utility information view of the cluster display window.

Limitations of Emergency Stop

For more details on the limitations of **Emergency Stop**, refer to limitations of "Smart Cruise Control (SCC)" on page 7-62 and "Lane Following Assist (LFA)" on page 7-84

Navigation-based Smart Cruise Control (NSCC) (if equipped)

Navigation-based Smart Cruise Control can help maintain safe speed depending on the road conditions by using information from the navigation system when driving on highways while Smart Cruise Control is operating.

* NOTICE

- Navigation-based Smart Cruise Control is available only on controlled access road of certain highways.
 - * Controlled access road indicates roads with limited entrances and exits that allow uninterrupted high speed traffic flow. Only passenger cars and motorcycles are allowed on controlled access roads.
- Additional highways may be added by future navigation updates.

* NOTICE

Navigation-based Smart Cruise Control operates on main roads and highways, and does not operate on interchanges or junctions.

⚠ WARNING

Navigation-based Smart Cruise Control (NSCC) is a supplemental system and is not a substitute for safe driving. It is your responsibility to always check the speed and distance to the vehicle ahead. Always drive safely and use caution.

Highway Curve Zone Auto Slow-down

If vehicle speed is high, Highway Curve Zone Auto Slowdown function will temporarily decelerate your vehicle or limit acceleration to help you drive safely on a curve based on the curve information from the navigation.

Navigation-based Smart Cruise Control settings

Auto Highway Speed Change



1 Driver Assistance

2 Driving Convenience

3 Auto Highway Speed Change

With the vehicle on, select **Setup** → **Vehicle** → **Driver Assistance** → **Auto Highway Speed Change** on the infotainment system.

* NOTICE

If there is a problem with Navigation-based Smart Cruise Control, the function cannot be set from the Settings menu.

Navigation-based Smart Cruise Control operation

Operating conditions

Navigation-based Smart Cruise Control is ready to operate if all the following conditions are satisfied:

- Smart Cruise Control is operating
- Driving on main roads of highways (or motorways)

* NOTICE

For more details on how to operate Smart Cruise Control, refer to "Smart Cruise Control (SCC)" on page 7-62.

Navigation-based Smart Cruise Control display and control



When Navigation-based Smart Cruise Control operates, it will be displayed on the instrument cluster as follows:

Navigation-based Smart Cruise Control standby

If all the operating conditions are satisfied, the green (NAV) indicator will appear.

Navigation-based Smart Cruise Control operating

During speed control, the green (NAV) indicator will blink.

Navigation-based Smart Cruise Control pause/driver operation

If Smart Cruise Control cannot be operated due to pause or rerouting, the gray

(NAV) indicator will appear on the instrument cluster.

If the accelerator pedal is depressed, the white (NAV) indicator will blink on the instrument cluster.

⚠ WARNING

A warning message will appear in the following circumstances:



A: Drive carefully

- Navigation-based Smart Cruise Control is not able to slow down your vehicle to a safe speed

*** NOTICE**

The images and colors in the instrument cluster may differ depending on the cluster type or theme selected from the settings menu.

Highway Curve Zone Auto Slow-down

Depending on the curve ahead on the highway, the vehicle will decelerate, and after passing the curve, the vehicle will accelerate to Smart Cruise Control set speed.

*** NOTICE**

The starting point of deceleration depends on the vehicle's driving speed and the curvature of the road. The higher the driving speed, the earlier the deceleration start point.

Navigation-based Smart Cruise Control limitations

Navigation-based Smart Cruise Control may not operate normally (For example, deceleration may occur if the driver's predicted path differs from the navigation-guided route due to operational limitations or other factors.) under the following circumstances:

- The navigation is not working properly
- Map information is not transmitted due to infotainment system's abnormal operation
- The map information and the actual road is different because of real-time GPS data or map information error
- The navigation searches for a route while driving
- GPS signals are blocked (e.g., in a tunnel, under trees)
- The vehicle enters a service station or rest area
- Android Auto or CarPlay is operating
- The navigation cannot detect the current vehicle position (for example, elevated roads, including overpasses adjacent to general roads or nearby parallel roads)
- The navigation is updating while driving
- The navigation is restarting while driving
- The speed limit of some sections of the road changes
- Driving on a road under construction
- Driving on a controlled road
- Driving in bad weather, such as heavy rain or snow.

- Driving on a sharply curved road

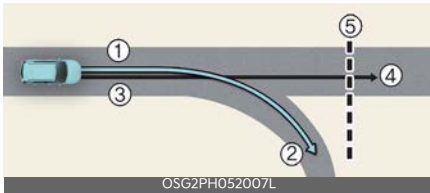

- 1 Set route
- 2 Branch line
- 3 Driving route
- 4 Main road
- 5 Curved road section

- When there is a difference between the navigation set route (branch line) and the driving route (main road), Highway Curve Zone Auto Slowdown function may not operate until the driving route is recognized as the main road.
- When the vehicle's driving route is recognized as the main road by maintaining the main road instead of the navigation set route, Highway Curve Zone Auto Slowdown function will operate. Depending on the distance to the curve and the current vehicle speed, vehicle deceleration may be insufficient or decelerate rapidly.

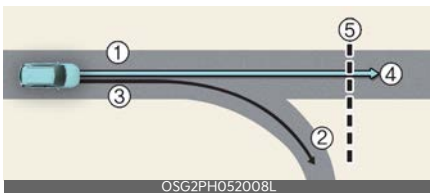

- 1 Main road
- 2 Branch line
- 3 Driving route
- 4 Set route
- 5 Curved road section

- When there is a difference between the navigation route (main road) and the driving route (branch line), Highway Curve Zone Auto Slowdown function will operate temporarily based on the curve information on the main road.
- When it is determined that you are driving out of the route by entering the highway interchange or junction, Highway Curve Zone Auto Slowdown function will not operate.

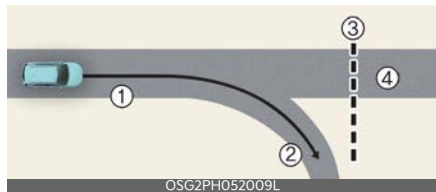

- 1 Driving route
 - 2 Branch line
 - 3 Curved road section
 - 4 Main road
- If there is no destination set on the navigation, Highway Curve Zone Auto Slowdown function will operate based on the curve information on the main road.
 - Even if you depart from the main road, Highway Curve Zone Auto Slowdown function may temporarily operate due to navigation information of the highway curve section.

⚠ WARNING

- Navigation-based Smart Cruise Control is not a substitute for safe driving practices, but a convenience function. Always have your eyes on the road, and it is the responsibility of the driver to avoid violating traffic laws.
- The navigation's speed limit information may differ from the actual speed

limit information on the road. It is your responsibility to check the speed limit on the actual driving road or lane.

- Navigation-based Smart Cruise Control will automatically be canceled when you leave the highway main road. Always pay attention to road and driving conditions while driving.
- Navigation-based Smart Cruise Control may not operate due to the presence of lead vehicles and their driving conditions. Always pay attention to road and driving conditions while driving.
- When towing a trailer or something similar, your vehicle's deceleration may be insufficient. Always drive with caution.
- After you pass through a tollgate on a highway, Navigation-based Smart Cruise Control will operate based on the first lane. If you enter one of the other lanes, Navigation-based Smart Cruise Control might not operate properly.
- Your vehicle will accelerate if you depress the accelerator pedal while Navigation-based Smart Cruise Control is operating. The function will not decelerate your vehicle. If you depress the accelerator pedal too lightly, the vehicle may decelerate.
- If the driver accelerates and releases the accelerator pedal while Navigation-based Smart Cruise Control is operating, the vehicle may not decelerate sufficiently or may rapidly decelerate to a safe speed.
- If the curve is too large or too small, Navigation-based Smart Cruise Control may not operate.
- Navigation-based Smart Cruise Control is a supplemental function and is

not a substitute for safe driving. It is your responsibility to always check the speed and distance to the vehicle ahead. Always drive safely and use caution.

* NOTICE

- A time gap could occur between the navigation's guidance and when Navigation-based Smart Cruise Control operation starts and ends.
 - The speed information on the instrument cluster and navigation may differ.
 - Even if you are driving at a speed lower than Smart Cruise Control set speed, acceleration may be limited by curved road sections ahead.
 - If Navigation-based Smart Cruise Control is operating while leaving the main road to enter an interchange, junction, rest area, etc., the function may operate for a certain period.
 - Deceleration by Navigation-based Smart Cruise Control may feel it is not sufficient due to road conditions such as uneven road surfaces and narrow lanes.
-

This device complies with Part 15 of the FCC rules.

Operation is subject to the following three conditions:

1. This device may not cause harmful interference, and
2. This device must accept any interference received, including interference that may cause undesired operation.
3. Changes or modifications not expressly approved by the party responsible for compliance could void the user's authority to operate the device.

Radio frequency radiation exposure information:

This equipment complies with FCC radiation exposure limits set forth for an uncontrolled environment. This equipment should be installed and operated with minimum distance of 8 in (20 cm) between the radiator (antenna) and your body.

This transmitter must not be colocated or operating in conjunction with any other antenna or transmitter.

Lane Following Assist (LFA)

Lane Following Assist can detect lane markings and/or a vehicle ahead on the road and center your vehicle in the lane.

Detecting sensor

Front camera



The front view camera is used as a detecting sensor to detect lane markings and front vehicles.

Refer to the picture above for the detailed location of the detecting sensor.

CAUTION

For more details on the precautions of the front view camera, refer to "Forward Collision-Avoidance Assist (FCA) (Sensor Fusion)" on page 7-5.

Lane Following Assist settings

Warning Methods

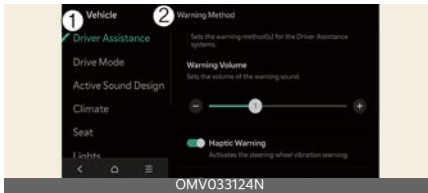

1 Driver Assistance

2 Warning Methods

The **Warning Methods** can be set with the vehicle on. Select **Setup** → **Vehicle** → **Driver Assistance** → **Warning Methods** from the settings menu in the infotainment system to change the following settings:

- **Warning Volume:** Adjusts the volume of the warning sound.
- **Driving Safety Priority:** Lowers all other audio volumes when the Driving Safety system sounds a warning.

⚠ CAUTION

When the vehicle and a trailer are connected electrically, Lane Following Assist automatically turns off. In this case, you cannot get help from Lane Following Assist. Always drive with care. (if Kia genuine part equipped)

* NOTICE

- Ensure that **Warning Methods** you have set may apply to the **Warning Methods** of other driver assistance systems.
- **Warning Methods** will maintain its last setting even if the vehicle is restarted.
- The setting menu may not be available for your vehicle depending on

the vehicle features and specifications.

Lane Following Assist operation

Turning Lane Following Assist On/Off



With the vehicle on, shortly press the Lane Driving Assist button located on the steering wheel to turn on Lane Following Assist. The gray or green (LFA) indicator light will appear on the cluster. Press the Lane Driving Assist button again to turn off Lane Following Assist.

⚠ CAUTION

If there are some vehicles that are supported by trailer mode, when the trailer is connected, the performance of Driver Assistance function may not operate properly. Always drive with care.

Warning and control

* NOTICE

- The following warning message will appear on the LCD display.
For more details, refer to the warning and control section of the function.
 - **Keep hands on steering wheel**
 - **Lane Following Assist Canceled**

Lane Following Assist



If the vehicle ahead and/or both lane markings are detected and Your driving speed is below 125 mph (200 km/h).

CAUTION

When the steering wheel is not assisted, the white (A) indicator light blinks and change to gray.

Hands-off warning

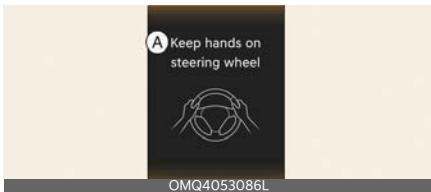

A: Keep hands on steering wheel

When the driver takes off their hands from the steering wheel for a few seconds, a warning message will appear and an audible warning will sound in stages.

- First stage: Warning message
- Second stage: Warning message (red steering wheel) and audible warning

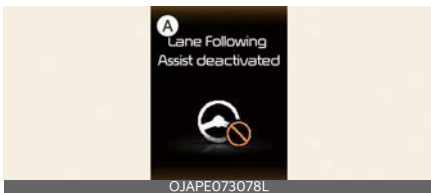

A: Lane Following Assist deactivated

If the driver still does not have their hands on the steering wheel after the hands-off warning message will appear and Lane Following Assist be automatically canceled.

WARNING

- The steering wheel may not be assisted if the steering wheel is held very tight or the steering wheel is steered over a certain degree.
- Lane Following Assist does not operate at all times. It is the responsibility of the driver to safely steer the vehicle and to maintain the vehicle in its lane.
- The hands-off warning message may appear late depending on road conditions. Always have your hands on the steering wheel while driving.
- If you attach objects to the steering wheel, the hands-off warning may not work properly.
- If gloves are worn or the steering wheel is held lightly, it may be perceived as not being held, resulting in the Hands-Off Warning being displayed.

* NOTICE

- When both lane markings are detected, the lane lines on the cluster will change from gray to white.

Lane undetected

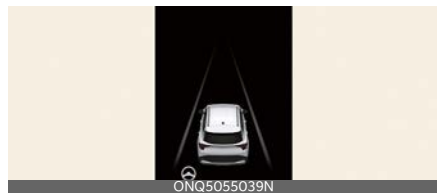

Lane detected



- The images and colors in the instrument cluster may differ depending on the cluster type or theme selected from the settings menu.
- If lane markings are not detected, steering wheel control by Lane Following Assist can be limited depending on whether a vehicle is in front or the driving conditions of the vehicle.
- Even though the steering is assisted by Lane Following Assist, the driver may control the steering wheel.
- The steering wheel may feel heavier or lighter when the steering wheel is assisted by Lane Following Assist than when it is not.

Lane Following Assist malfunction and limitations

Lane Following Assist malfunction

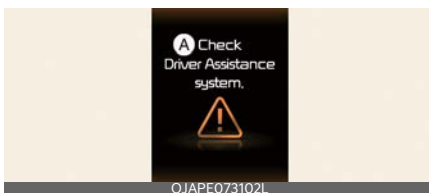

A: Check Driver Assistance system

When Lane Following Assist is not working properly, a warning message will appear and the Master warning light (⚠) will appear on the instrument cluster.

If this occurs, have Lane Following Assist inspected by an authorized Kia dealer.

* NOTICE

You can check it in the service message of the utility information view of the cluster display window.

Limitations of Lane Following Assist

⚠ WARNING

- For more details on Lane Following Assist precautions, refer to "Lane Keeping Assist (LKA)" on page 7-27.
- Driving stability can deteriorate when loading cargo in excess of the maximum allowable weight or concentrated to one cargo area. Also, it can reduce the lane keeping assist performance.

Highway Driving Assist (HDA) (if equipped)

Highway Driving Assist



Highway Driving Assist detect lanes and vehicles ahead and help maintain the distance from the vehicle ahead and the set speed and center your vehicle in the lane while driving on the highway.

Highway Lane Change Assist (if equipped)



Highway Lane Change Assist function can help change lanes to the direction you operate the turn signal switch if the function determines that lane change is possible.

* NOTICE

- Highway Driving Assist is available only on controlled access roads of certain highways.
 - * A controlled access road indicates roads with limited entrances and exits that allow uninterrupted high speed traffic flow. Only passenger cars and motorcycles are allowed on controlled access roads.
- Additional highways may be added by future navigation updates.

Highway Driving Assist operates on main roads of highways and does not operate on interchanges or junctions.

Detecting sensor

Front view camera



Front radar



Front corner radar (if equipped)



Rear corner radar (if equipped)



Refer to the pictures above for the detailed location of the detecting sensors.

CAUTION

For more details on the precautions of the detecting sensors, refer to "Forward Collision-Avoidance Assist (FCA) (Sensor Fusion)" on page 7-5.

Highway Driving Assist settings

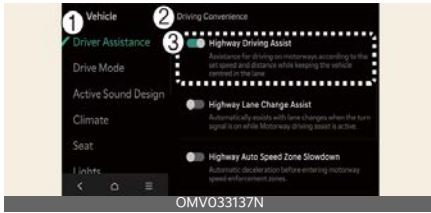

- 1 Driver Assistance
- 2 Driving Convenience
- 3 Highway Driving Assist

With the vehicle on, touch or select **Setup** → **Vehicle** → **Driver Assistance** → **Driving Convenience** on the infotainment system to set whether to use each function.

- If **Highway Driving Assist** is selected, it can help maintain distance from the vehicle ahead, maintain the set speed, and can help center the vehicle in the lane.

Highway Lane Change Assist (if equipped)

- If **Highway Lane Change Assist** is selected, it can help change lanes safely.

WARNING

For your safety, change the Settings after parking the vehicle at a safe location.

CAUTION

When the vehicle and a trailer are connected electrically, Highway Driving Assist automatically turns off. In this case, you cannot get help Highway Driving Assist. Always drive with care. (if KIA genuine part equipped)

NOTICE

- Highway Driving Assist should be selected to use Highway Lane Change Assist.
- If there is a problem with the function, the settings cannot be changed. Have the function inspected by an authorized Kia dealer.
- If the vehicle is restarted, the functions will maintain their last settings.

Warning Methods

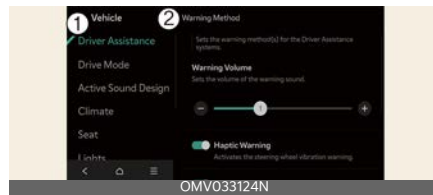

- 1 Driver Assistance
- 2 Warning Methods

The **Warning Methods** can be set with the vehicle on. Select **Setup** → **Vehicle** → **Driver Assistance** → **Warning Methods** from the settings menu in the infotainment system to change the following settings:

- **Warning Volume:** Adjusts the volume of the warning sound.
- **Driving Safety Priority:** Lowers all other audio volumes when the Driving Safety system sounds a warning.

*** NOTICE**

- Ensure that **Warning Methods** you have set may apply to the **Warning Methods** of other driver assistance systems.
- **Warning Methods** will maintain its last setting even if the vehicle is restarted.
- The setting menu may not be available for your vehicle depending on the vehicle features and specifications.

Highway Driving Assist operation

Highway Driving Assist

Display and control

You can see the status of the Highway Driving Assist operation in the Driving Assist view on the instrument cluster. Refer to "LCD display" on page 5-89.

Operating State



Standby State

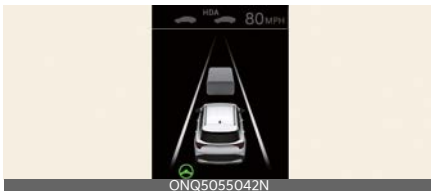

Highway Driving Assist will be displayed as below depending on the status of the function.

- 1 Highway Driving Assist indicator, whether there is a vehicle ahead and

the selected distance level is displayed.

- Highway Driving Assist indicator
 - Green HDA: Operating state
 - Gray HDA: Standby state
 - White HDA blink: Accelerator depressed state
 - None: Off state

- 2 Set speed
- 3 Lane Following Assist indicator
- 4 Whether there is a vehicle ahead and the selected headway
- 5 Whether the lane is detected or not

*** NOTICE**

- For more details on the display, refer to "Lane Following Assist (LFA)" on page 7-84.
For more details on the display refer to "Smart Cruise Control (SCC)" on page 7-62.
- The images and colors in the instrument cluster may differ depending on the cluster type or theme selected from the settings menu.

Turning on Highway Driving Assist

Highway Driving Assist operates when:

- When driving on available roads, press Drive Assist button to turn on Highway Driving Assist.
- When entering the main roads of highways while Smart Cruise Control is operating, Driving Assist will not turn on if Lane Following Assist is turned off.

Restarting after stopping

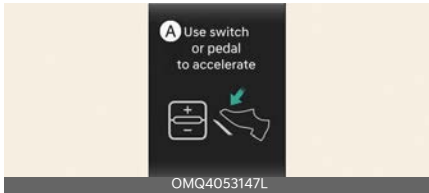

A: Use switch or pedal to accelerate

When Highway Driving Assist is operating, your vehicle will stop if a vehicle ahead of you stops. If a vehicle ahead of you starts moving within 30 seconds after the stop, your vehicle will start as well. In addition, after the vehicle has stopped and 30 seconds have passed, a message will appear on the instrument cluster. Depress the accelerator pedal or operate the (+) switch, (-) switch or (||◁) switch to start driving.

* NOTICE

If your vehicle is equipped with an in-cabin camera, the system may allow a longer stop time before automatic departure based on the driver's forward gaze.

Hands-off warning

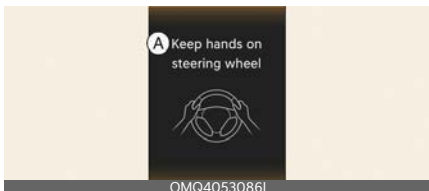

A: Keep hands on steering wheel

If you take your hands off the steering wheel for several seconds, a warning message will appear and an audible warning will sound in stages.

- First stage: Warning message

- Second stage: Warning message (red steering wheel) and audible warning

⚠ CAUTION

If you keep taking your hands off the steering wheel, then the Emergency Stop will activate. "Emergency Stop (ES)" on page 7-77

Driving to one side within lane (if equipped)



When your vehicle speed is above 40 mph (60 km/h), if a vehicle around you is driving at a close distance, your vehicle will control steering in the opposite direction of the vehicle to assist in safe driving. If there are vehicles in both sides of the lane that are driving close to you, the function will not veer to the opposite side of the lane.

Highway Driving Assist standby

When the Smart Cruise Control is temporarily canceled while Highway Driving Assist is operating, Highway Driving Assist will be in the standby state. At this time, Lane Following Assist will operate properly.

Highway Lane Change Assist (if equipped)

Display and control

You can see the status of the Highway Lane Change Assist function operation in the Driving Assist view on the instrument cluster. Refer to "LCD display" on page 5-89.

Highway Lane Change Assist function will be displayed as below depending on the status of the function.

Ready/Operating



Standby/Canceled



- 1 Highway Lane Change Assist indicator
 - Green (↔↔) on: Ready state
 - Green (↔↔) blink: Operating state
 - Gray (↔↔) on: Standby state
 - White (↔↔) blink: Canceled state (display only a certain time)
- 2 Lane line

The lane line is displayed identical to Highway Lane Change Assist indicator (1). However, the lane detection availability will be showed on Standby state.
- 3 Green arrow and shade

The green arrow is displayed when a certain amount of time has passed after the function has started operating, and until the lane change has completed.
- 4 Message
 - Message is displayed when the function does not operate even though the turn signal lever is used.

- Message is displayed when the function is canceled while operating.

Highway Lane Change Assist function will turn on when the following conditions are satisfied.

- The Driving Assist button or Lane Driving Assist button is used to turn on Highway Driving Assist.

Turning on Highway Lane Change Assist

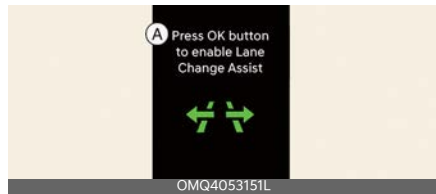

A: Press OK button to enable Lane Change Assist

While Highway Lane Change Assist function is on, the function will be ready to operate when all the following conditions are satisfied:

- Highway Driving Assist is operating
- Lane Following Assist is operating
- A vehicle behind your vehicle is detected more than once after your vehicle is turned on
- Your driving speed is above 20 mph (30 km/h)
- When driving at low speeds (20-40 mph (30-60 km/h)), your vehicle can only be operated if vehicles in the left and right adjacent lanes are recognized, and there is no risk of collision when changing lanes.
- Hands-off warning is not displayed on the instrument cluster
- Hazard warning flasher is off

* NOTICE

- While Lane Change Assist function is turned on (indicator on), Lane Following Assist will not cancel even if the turn signal indicator or hazard warning flasher is operating.
- Lane Change Assist function turns off automatically when driven in the following road conditions:
 - One driving lane
 - Roads lacking physical center separation structures (such as guard-rails)
 - There is a pedestrian or cyclist on the road ahead
- If the driving speed slows down to less than 15 mph (25 km/h) when it is in ready state, it will change to standby state.
- When driving at low speeds (20-40 mph (30-60 km/h)), the vehicle will change to standby state if it is not recognized by vehicles in the left and right adjacent lanes.
- If a risk of collision is detected, the system will change to standby state.
- The images or colors may be displayed differently depending on the specifications of the instrument cluster or theme.
- Lanes and surrounding objects displayed within a cluster may differ from actual ones.

⚠ WARNING

When Highway Lane Change Assist function turns off while operating, steering assist will be temporarily canceled. Always be cautious while driving.

Highway Lane Change Assist operating



Highway Lane Change Assist function will operate, when you push the turn signal lever to (A) or (B) position while the function is in the ready state (() indicator is green), and all the following conditions are satisfied:

- Your hands are on the steering wheel
- There is no collision risk in the direction of lane change
- There is a two-lane road with broken lines of any colors in the direction of the lane change
- There are no Forward Collision-Avoidance Assist and Blind Spot Collision-Avoidance Assist warnings
- You are driving in the middle of the lane (should not be driving close to one side of the lane)
- The road you are driving on, or the road you are about to change lane is a road that the function can operate

* NOTICE

- When the turn signal lever is placed at (A) position, the Highway Lane Change Assist function is performed. After that, if the turn signal lever is placed in neutral, Highway Lane Change Assist function is canceled before stepping on the lane. The Highway Lane Change Assist function is not canceled after stepping on the lane, but when the lane change

is complete, it is canceled and the turn signal turns off.

- When the turn signal lever is placed at B position for a certain period, the green arrow will appear. Even when the lever is released and returns to its original position, lane change will still be assisted.
- While lane change is occurring, the turn signal indicator will blink even when not holding the turn signal lever. The turn signal indicator will turn off when the lane change is complete.

Highway Lane Change Assist standby

Highway Lane Change Assist function will be in the standby state when one of the ready state conditions is not satisfied, or when entering or driving on one of the following roads:

- Road within a certain distance from the tollgate on the main road of the highway (or motorway)
- Road ahead ends without an interchange or junction
- Road with sharp curves
- Road with narrow lanes

Canceling Highway Lane Change Assist

The function will be canceled when:

- The turn signal lever is turned in the opposite direction of lane change
- The steering wheel is steered sharply
- If the turn signal switch is moved to position (A) while the Lane Change Assist is operating and then returned to the N (Neutral) position before changing lanes

WARNING

- While the function is operating, it will cancel if one of the following occurs:
 - Highway Driving Assist is turned off
 - Lane Following Assist or Smart Cruise Control is turned off or temporarily canceled
 - Hands-off warning message is displayed on the instrument cluster
 - The hazard warning flasher is turned on
 - Forward Collision-Avoidance Assist or Blind-Spot Collision-Avoidance Assist warning message is displayed
 - Possible collision is detected in the next lane, even though there are no Forward Collision-Avoidance Assist and Blind Spot Collision-Avoidance Assist warning
 - The target lane disappears
 - The target lane is not detected
 - There is a problem with turn signal lights
 - Highway Lane Change Assist function is off. (The function turns off when: it is turned off from the settings menu; when the road changes to a one-way road; when there is an intersection or crosswalk ahead; when you enter a road with no structure, such as a medium strip, guardrail, etc., or; when there is a pedestrian or cyclist in the driving lane.)
 - If the driving speed slows down to less than 15 mph (25 km/h) when it is in ready state, it will change to standby state.
 - When driving at low speeds (20-40 mph (30-60 km/h)), the vehicle will change to standby state if it is not

- recognized by vehicles in the left and right adjacent lanes.
 - If a risk of collision is detected
- While the function is operating, if it is canceled, depending on the driving conditions, the vehicle may drive to the middle of the driving lane or steering assist may stop. Always pay attention to the road and driving conditions.
- The function may not operate normally on roads with pedestrians or cyclists, such as an intersection or crosswalk. Always pay attention to the road and driving conditions.

Highway Driving Assist malfunction and limitations

Highway Driving Assist malfunction

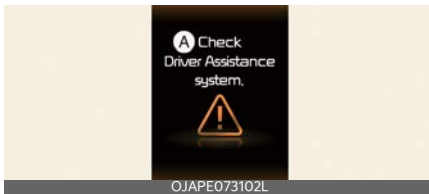

A: Check Driver Assistance system
 When Highway Driving Assist is not working properly, a warning message will appear, and the Master warning light (⚠) will appear on the instrument cluster.

Have Highway Driving Assist inspected by an authorized Kia dealer.

⚠ WARNING

- You are responsible for controlling the vehicle for safe driving.
- Always have your hands on the steering wheel while driving.

- Highway Driving Assist is a supplemental function that assists you in driving the vehicle. It is not a complete autonomous driving system. Always check road conditions take appropriate actions to drive safely.
- Always have your eyes on the road. It is your responsibility to avoid violating traffic laws. Kia is not responsible for any traffic violations or accidents caused by you.
- Highway Driving Assist may not be able to recognize all traffic situations. Highway Driving Assist may not detect possible collisions due to its limitations. Obstacles such as vehicles, motorcycles, bicycles, pedestrians, or unspecified objects or structures such as guardrails, tollgate, etc., that may collide with your vehicle may not be detected.
- Highway Driving Assist will turn off automatically under the following situations:
 - Driving on roads that Highway Driving Assist does not operate, such as a rest area, intersection, junction, etc.
 - The navigation does not operate properly such as when the navigation is updating or restarting.
- Highway Driving Assist may inadvertently operate or turn off depending on road conditions (navigation information) and surroundings.
- Lane Following Assist function may be temporarily disabled when the front view camera cannot detect lanes properly or the hands-off warning is on.

- You may not hear the warning sound of Highway Driving Assist in noisy surroundings.
- If the vehicle is driven at a speed above a certain speed on a curve, your vehicle may drive to one side or may depart from the driving lane.
- When you are towing a trailer or another vehicle, turn off Highway Driving Assist for safety reasons.
- The hands-off warning message may appear early or delayed depending on how you grip the steering wheel or the road conditions. Always have your hands on the steering wheel while driving.
- For your safety, please read the owner's manual before using the Highway Driving Assist.
- Highway Driving Assist will not operate when the vehicle is started, or when the detecting sensors or navigation is being initialized.
- The infotainment system is overloaded by simultaneously performing functions such as route search, video playback, voice recognition, etc.
- GPS signals are blocked in areas such as a tunnel
- You veer off course, reset the navigation route by changing the destination (including route change according to real-time road traffic information) or cancel the route to the destination
- The vehicle enters a service station or rest area
- Android Auto or CarPlay is operating
- The navigation cannot detect the current vehicle position (for example, elevated roads, including overpasses adjacent to general roads or nearby parallel roads)
- If your vehicle fails to recognize white single dashed lane lines and road boundaries
- If some lanes are temporarily restricted
- If there are no physical separation structures, such as a center median, in the middle of the road
- If the lane you intend to change to is a bus lane or a variable lane
- If you have a trailer, carrier, or other equipment attached

* NOTICE

You can check it in the service message of the utility information view of the instrument cluster display window.

Limitations of Highway Driving Assist

Highway Driving Assist and Highway Lane Change Assist may not operate properly, or it may not operate under the following circumstances:

- The map information and the actual road is different because the navigation is not updated
- The map information and the actual road is different because of real-time GPS data or map information error

* NOTICE

For more details of front camera, front radar, front corner radar and rear corner radar sensor, refer to "Forward Collision-Avoidance Assist (FCA) (Sensor Fusion)" on page 7-5.

This device complies with Part 15 of the FCC rules.

Operation is subject to the following three conditions:

1. This device may not cause harmful interference, and
2. This device must accept any interference received, including interference that may cause undesired operation.
3. Changes or modifications not expressly approved by the party responsible for compliance could void the user's authority to operate the device.

Radio frequency radiation exposure information:

This equipment complies with FCC radiation exposure limits set forth for an uncontrolled environment. This equipment should be installed and operated with minimum distance of 8 in (20 cm) between the radiator (antenna) and your body.

This transmitter must not be colocated or operating in conjunction with any other antenna or transmitter.

Rear View Monitor (RVM) (if equipped)

Rear View Monitor displays the area behind your vehicle to help with safe parking.

Detecting sensor

Wide-rear view camera (if equipped)



Refer to the picture above for the detailed location of the detecting sensor.

Rear View Monitor settings

Warning Methods

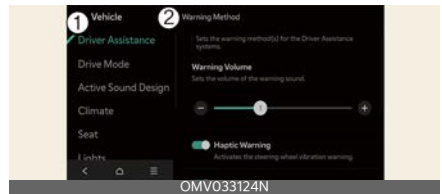

1 Driver Assistance

2 Parking Safety Priority

The **Warning Methods** can be set with the vehicle on. Select **Setup** → **Vehicle** → **Driver Assistance** → **Warning Methods** from the settings menu in the infotainment system to change the following settings:

- **Parking Safety Priority:** Lowers all other audio volumes when Rear View Monitor is active.

* NOTICE

- Ensure that **Warning Methods** you have set may apply to the **Warning**

Methods of other driver assistance systems.

- **Warning Methods** will maintain its last setting even if the vehicle is restarted.
- The setting menu may not be available for your vehicle depending on the vehicle features and specifications.

Camera Settings

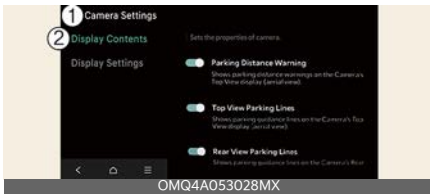

1 Camera Settings

2 Display Contents

With the vehicle on, select the setup icon (⚙️) on the screen or **Setup** → **Vehicle** → **Driver Assistance** → **Parking Safety** → **Camera Settings** from the infotainment system screen to change the Rear View Monitor settings.

Extended Rear View Monitor

If Extended Rear View Monitor use is selected, the rear camera is displayed even when shifting from R (Reverse) to N (Neutral) or D (Drive).

Rear view Parking Guidance

If Rear view Parking Guidance in the display information is selected, Rear view Parking Guidance and Top Rear view Parking Guidance are displayed in the rear monitor.

Display settings

- You can set the brightness (day/night) and contrast of the camera image in Display settings.

* NOTICE

- The setting menu may not be available for your vehicle depending on vehicle specifications.
- The horizontal guideline of the rear top view guide lines is based on the empty freight condition. This shows the liftgate opening distance and the distance of about 60 in. (1.5 m) from the vehicle.
- The horizontal guideline of the Rear view parking guide lines is based on the empty freight condition. This shows the distance of about 20 in. (0.5 m), 40 in. (1 m) and 91 in. (2.3 m) from the vehicle.

Rear View Monitor operation

Parking/View button



Press the Parking/View button (P) to turn on Rear View Monitor.

Press the button again to turn off the function.

Rear view

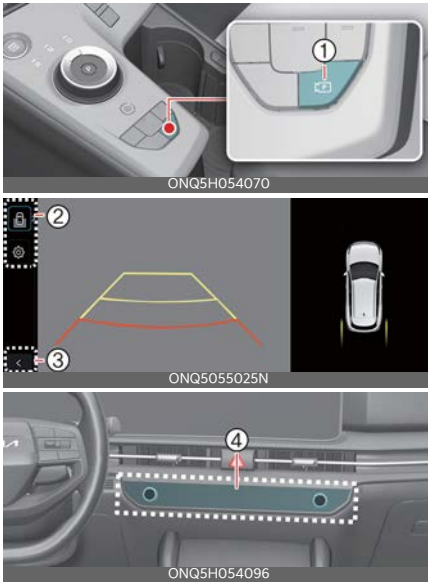

Operating conditions

The Rear view function will turn on under the following conditions:

- Shifting the gear to R (Reverse).
- Pressing the Parking/View button (1) while P (Park), or N (Neutral) and the vehicle speed is slower than 6 mph (10 km/h)

Pressing the View switching button (2) with the Rear top view on the screen allows you to select rear top view, rear view, or rear wide view.

Off conditions

The rear view while parking function will turn off under the following conditions while parking:

- Shifting the gear to P (Park)
- Pressing the Parking/View button (1)

- Pressing the back button (3) on the rear monitor screen
- Pressing the infotainment system operation button (4)
- N (Neutral) or D (Drive) and the vehicle speed is faster than 6 mph (10 km/h)

* NOTICE

Rear view will not turn off when the vehicle is in R (Reverse).

Extended Rear View Monitor

Extended Rear View Monitor function maintains the rear view of the vehicle when shifting the gear from R (Reverse) to N (Neutral) or D (Drive) to help you park safely.

Operating conditions

Rear View Monitor will maintain when the following conditions are satisfied:

- Shifting the gear from R (Reverse) to N (Neutral) or D (Drive).
- Your driving speed is below approximately 6 mph (10 km/h).

Off conditions

Extended Rear View Monitor function will turn off when one the following conditions are satisfied:

- Shifting the gear to P (Park)
- Pressing the Parking/View button (1)
- Pressing the back button (3) on the rear monitor screen
- Pressing the infotainment system operation button (4)
- The vehicle speed is faster than 6 mph (10 km/h)

Rear top view

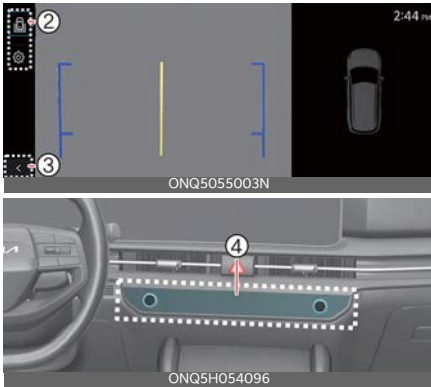

The rear top view shows an image of the vehicle looking down from above, allowing you to determine the distance from the rear vehicle or object when parking. Press the Rear Top View button to turn on the Rear Top View.

* NOTICE

- In all views, the video will not turn off when your vehicle is in R (Reverse) mode.
- The rear view will always be displayed in R (Reverse).
- Rear parking guidelines are displayed in the rear view and rear top view. Select **Setup** → **Vehicle** → **Driver Assistance** → **Parking Safety** → **Camera Settings** → **Display Information** → **Rear Parking Guidelines** from the settings menu in the infotainment system to display this function. Rear parking guidelines are not displayed in the rear view while parking.

Rear View Monitor malfunction and limitations

Rear View Monitor malfunction

When Rear View Monitor malfunctions, the image on the screen may appear green, blue, or black.

When Rear View Monitor is not working properly, the screen flickers, or the camera image does not display properly, have your Kia inspected by an authorized Kia dealer.

Limitations of Rear View Monitor

When the vehicle is idling for a long time or when the vehicle is parked in an indoor parking lot, exhaust fumes may temporarily blur the image.

- The screen may appear abnormally under the following circumstances:
 - When the liftgate is open

⚠ WARNING

- The wide angle-rear camera does not cover the complete area behind your vehicle. You should always check the rear area from the inside and outside rear view mirror before parking or backing up.
- The image shown on the screen may differ from the actual distance of the object because the Rear View Monitor calibrates and displays images from the wide angle-rear camera. In addition, Parking Guidance may be incorrect if the vehicle tilts due to loading of cargo. Make sure to check your surroundings for safety.
- Always keep the wide angle-rear camera lens clean. If the lens is covered with foreign material, it may adversely affect camera performance and Rear View Monitor may not operate properly. Do not use chemical solvents

such as strong detergents containing high alkaline or volatile organic solvents (petrol, acetone etc.). This may damage the camera lens.

- Driving with the liftgate open is abnormal. For your safety, be aware and drive safely.

Surround View Monitor (SVM) (if equipped)

Surround View Monitor can assist in parking by allowing the driver to see around the vehicle.

Detecting sensor

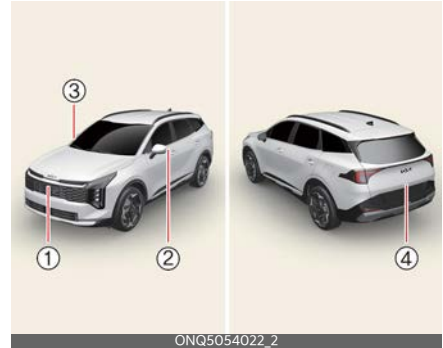

- 1 Wide-front view camera (if equipped)
- 2, 3 Wide-side view camera (if equipped)
- 4 Wide-rear view camera (if equipped)

Refer to the picture above for the detailed location of the detecting sensor.

Surround View Monitor settings

Warning Methods

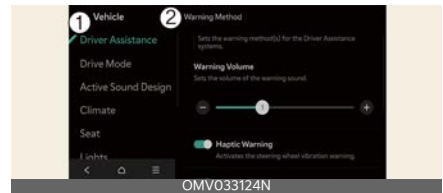

- 1 Driver Assistance
- 2 Warning Methods

The **Warning Methods** can be set with the vehicle on. Select **Setup** → **Vehicle** → **Driver Assistance** → **Warning Methods** from the settings menu in the infotainment system to change the following settings:

- **Parking Safety Priority:** Lowers all other audio volumes when Surround View Monitor is active.

* NOTICE

- Ensure that **Warning Methods** you have set may apply to the **Warning Methods** of other driver assistance systems.
- **Warning Methods** will maintain its last setting even if the vehicle is restarted.
- The setting menu may not be available for your vehicle depending on vehicle features and specifications.

Camera Settings



1 Camera Settings

2 Display Contents

3 Display Settings

With the vehicle on, select the setup icon (⚙️) on the screen or **Setup** → **Vehicle** → **Driver Assistance** → **Parking Safety** → **Camera Settings** from the infotainment system screen to change the Rear View Monitor settings.

- **Display Contents:** Specify information that will be displayed on the parking assistance screen.

Display information

- **Parking Distance Warning:** When the Parking Distance Warning is selected, the Parking Distance Warning is displayed on the top view to the right of the surround view monitor

screen when the Parking Distance Warning is activated.

- **Top View Parking Guidance:** When **Top View Parking Guidance** is selected, it is displayed on the top view to the right of the surround view monitor screen when the front or rear top view is activated.
- **Rear view Parking Guidance:** Rear view Parking Guidance is displayed in the rear view when **Rear view Parking Guidance** is selected.

Display settings

- You can set the brightness (day/night) and contrast of the camera image in Display settings.

* NOTICE

- The setting menu may not be available for your vehicle depending on vehicle features and specifications.
- The horizontal guideline of the rear view parking guide lines is based on the empty freight condition. This shows the distance of about 20 in (0.5 m), 40 in (1 m) and 91 in (2.3 m) from the vehicle.
- The horizontal scale of the Top View Parking Lines indicates distances of liftgate opening distance and about 79 in (2 m) from the vehicle.

Surround View Monitor Auto On



1 Driver Assistance

2 Parking Safety

3 Surround View Monitor Auto On

With the vehicle on, select **Setup** → **Vehicle** → **Driver Assistance** → **Parking Safety** → **Surround View Monitor Auto On** from the infotainment system screen to use the function.

* NOTICE

For more details on Surround View Monitor Auto On, refer to "Surround View Monitor Auto On" on page 7-103.

Surround View Monitor operation

Parking/View button



Press the Parking/View button (P) to turn on Rear View Monitor.

Press the button again to turn off the function.

Front view function

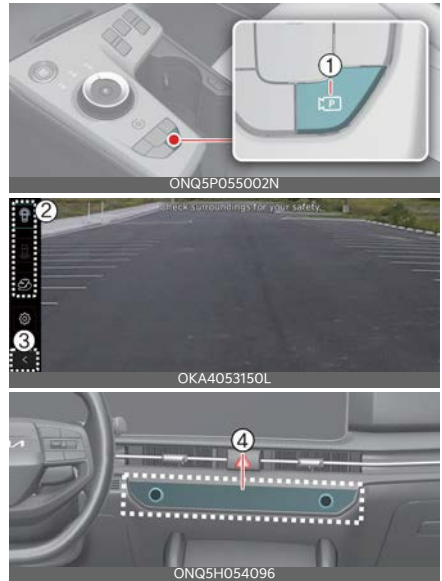

The front view function displays the vehicle's front situation on the navigation system according to the driver's settings, assisting in safe driving.

Parking

While parking, the front view of the Surround View Monitor is activated under the following conditions:

- P (Park) or N (Neutral) or D (Drive) position with a speed slower than 6 mph (10 km/h), Pressing the Parking/View button (1).
- Shifting from R (Reverse) to N (Neutral) or D (Drive) and the vehicle speed is slower than 6 mph (10 km/h).
- Forward Parking Distance Warning warns the driver when the vehicle is in D (Drive)

* (If **Setup** → **Vehicle** → **Driver Assistance** → **Parking Safety** → **Surround**

View Monitor Auto On on the infotainment system selected)

Pressing the view switching button (2) on the Surround View Monitor to select the Top View, Front view, Side view, or Wide View.

While parking, the front view of the Surround View Monitor will be turned off under the following conditions:

- Shifting to P (Park) or R (Reverse)
- Pressing the Parking/View button (1)
- Pressing the back button (3) on the Surround View Monitor screen
- Pressing the infotainment system power button (4)
- Driving faster than 6 mph (10 km/h)

*** NOTICE**

When the front view is activated, the last used view is displayed.

Rear view function

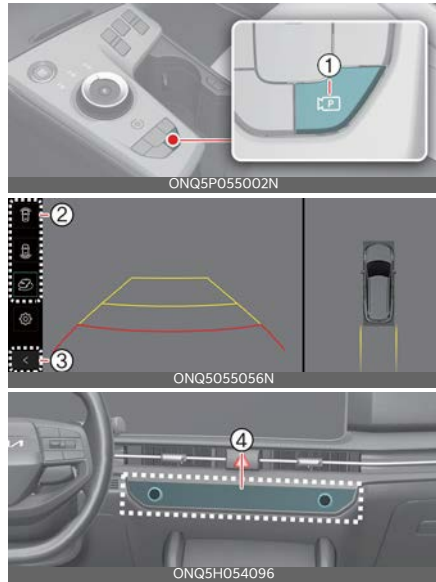

The rear view function of the Surround View Monitor displays the vehicle's rear situation on the navigation system according to the driver's settings, assisting in safe parking.

Parking

While parking, the rear view of the Surround View Monitor is activated in the following cases:

- P (Parking) or N (Neutral) or D (Drive) position with a vehicle speed slower than 6 mph (10 km/h), Pressing the Parking/View button (1) and then pressing the view switching button (2) to select the rear view
- Shifting to R (Reverse)

Pressing the view switching button (2) on the Surround View Monitor to select the rear view, rear top view, rear side-view, or rear wide view.

While parking, the rear view function of the Surround View Monitor is turned off under the following conditions when the vehicle is in P (Park) or N (Neutral) or D (Drive) mode:

- Shifting from N (Neutral) or D (Drive) to P (Parking)
- Pressing the Parking/View button (1)
- Pressing the back button (3) on the Surround View Monitor screen
- Pressing the infotainment system power button (4)
- Driving faster than 6 mph (10 km/h)

When the vehicle is in R (Reverse), the rear view function of the Surround View Monitor will turn off under the following conditions:

- Shifting to P (Park)

*** NOTICE**

- The rear view will always be displayed in R (Reverse).
- In R (Reverse) position, the video will not be turned off by pressing the infotainment system power button (4).

3D view function

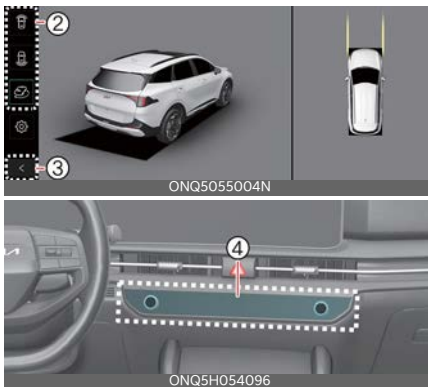

3D view function shows the vehicle in various angles. Press the 3D view icon

on the Surround View Monitor screen to choose the angle. Press the 3D view icon again to reset the angle.

The 3D view of the Surround View Monitor is activated under the following conditions:

- P (Park) or N (Neutral) or D (Drive) position with a vehicle speed slower than 6 mph (10 km/h), or when selecting the 3D view button (2) while the Surround View Monitor is activated in R (Reverse) mode.

The 3D view function of the Surround View Monitor while parking will be turned off under the following conditions:

- Shifting from N (Neutral) or D (Drive) to P (Park)
- Pressing the Parking/View button (1)
- Pressing the back button (3) on the Surround View Monitor screen
- Pressing the infotainment system power button (4)
- Driving faster than 6 mph (10 km/h)

When the vehicle is in R (Reverse), the 3D view function of the Surround View Monitor will turn off under the following conditions:

- Shifting to P (Park)

*** NOTICE**

- The 3D view does not display parking guidelines.
- The top view screen, which is displayed with a Front/Rear view or 3D view, converts the original images entered from the four wide-angle cameras to provide a 360-degree image around the vehicle that is viewed down.
- Top view is not displayed with front/rear wide view.

- Zoom in or out on the top view by pinching the top view area.

Surround View Monitor malfunction and limitations

Surround View Monitor malfunction

When Surround View Monitor malfunctions, the image on the screen may appear green, blue, or black.

If Surround View Monitor is not working properly, the screen flickers, or the camera image does not display normally, have the vehicle inspected by an authorized Kia dealer.

Limitations of Surround View Monitor

- When the vehicle is stopped for a long time in winter or when the vehicle is parked in an indoor car park, the exhaust fumes may temporarily blur the image.
- The screen may display abnormally and an icon will appear at the top left side of the screen under the following circumstances:
 - The liftgate is opened.
 - The driver or front passenger door is opened.
 - The outside rearview mirror is folded.

WARNING

- ALWAYS look around your vehicle to make sure there are no objects or obstacles before moving the vehicle. What you see on the screen may differ from the actual vehicle's location.
- The image shown on the screen may differ from the actual distance of the object because the Surround View

Monitor calibrates and displays images from the wide angle-rear camera. In addition, Parking Guidance may be incorrect if the vehicle tilts due to loading of cargo. Make sure to check your surroundings for safety.

- Surround View Monitor is designed to be used on a flat surface. If used on roads with different heights such as curbs and speed bumps, the image on the screen may not look correct.
- Always keep the camera lens clean. If the lens is covered with foreign material, it may adversely affect camera performance and Surround View Monitor may not operate normally. Do not use chemical solvents such as strong detergents containing high alkaline or volatile organic solvents (gasoline, acetone etc.). This may damage the camera lens.
- Driving with the liftgate open is abnormal. For your safety, be aware and drive safely.

NOTICE

The Surround View Monitor shows the surrounding images of the vehicle by cameras mounted on the vehicle. The image shown on the screen may look unnatural depending on the vehicle and the surrounding conditions. The Surround View Monitor can improve its image by calibrating image through daily driving.

Rear Cross-Traffic Collision-Avoidance Assist (RCCA)

Rear Cross-Traffic Collision-Avoidance Assist detects vehicles approaching from the rear left or right while your vehicle is reversing and warns you of a possible collision with a warning message and a warning sound. Also, Rear Cross-Traffic Collision-Avoidance Assist may assist with braking your vehicle to help avoid a collision.



1 Rear Cross-Traffic Collision Warning operating range

2 Rear Cross-Traffic Collision-Avoidance Assist operating range

⚠ CAUTION

Warning time may vary depending on the speed of approaching vehicle.

Detecting sensor

Rear corner radar (if equipped)



Refer to the picture above for the detailed location of the detecting sensors.

* NOTICE

For more details on the precautions of the rear corner radar, refer to "Blind-Spot Collision-Avoidance Assist (BCA) (if equipped)" on page 7-33.

Rear Cross-Traffic Collision-Avoidance Assist settings

Rear Cross-Traffic Safety



1 Driver Assistance

2 Parking Safety

3 Rear Cross-Traffic Safety

With the vehicle on, select **Setup** → **Vehicle** → **Driver Assistance** → **Parking Safety** → **Rear Cross-Traffic Safety** on the infotainment system screen to turn on Rear Cross-Traffic Collision-Avoidance Assist.

⚠ WARNING

When you restart the vehicle, Rear Cross-Traffic Collision-Avoidance Assist will always turn on. If **Rear Cross-Traffic Safety** is deselected after restart, you should always be aware of the surroundings and drive safely.

⚠ CAUTION

- From the setting menu, steering wheel vibration can be turned on or off.
- When the vehicle and the trailer are connected electrically, Rear Cross-Traffic Collision-Avoidance Assist

automatically turns off. In this case, you cannot get help from Rear Cross-Traffic Collision-Avoidance Assist. Always drive with care. (if Kia genuine part equipped)

Warning Methods

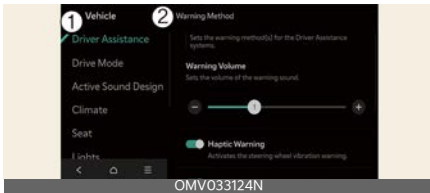

1 Driver Assistance 2 Warning Methods

The **Warning Methods** can be set with the vehicle on. Select **Setup** → **Vehicle** → **Driver Assistance** → **Warning Methods** from the settings menu in the infotainment system to change the following settings

- **Warning Volume:** Adjusts the volume of the warning sound.
- **Haptic Warning:** Activate the steering wheel vibration warning.

* NOTICE

- Ensure that **Warning Methods** you have set may apply to the **Warning Methods** of other driver assistance systems.
- **Warning Methods** will maintain its last setting even if the vehicle is restarted.
- The setting menu may not be available for your vehicle depending on the vehicle features and specifications.

Rear Cross-Traffic Collision-Avoidance Assist operation

Rear Cross-Traffic Collision-Avoidance Assist will warn and control your vehicle depending on collision risk level:

- Collision warning
- Emergency braking
- Stopping vehicle and ending brake control

Collision warning

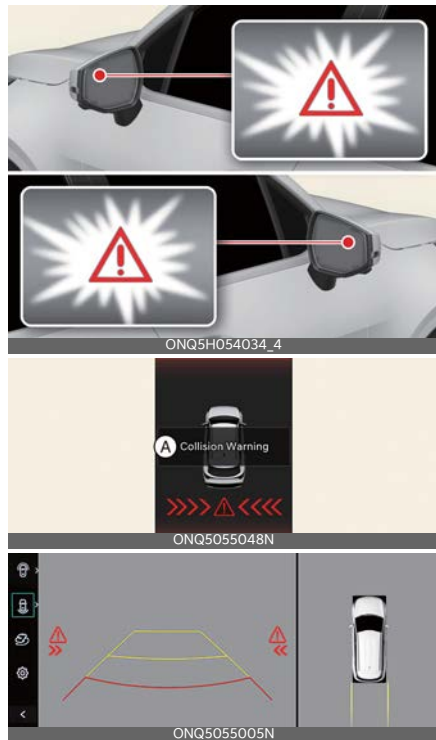

A: Collision Warning

If Collision warning recognizes a hazard, it will alert you with a warning light on the outside rear view mirror, a warning message, an audible warning and steering wheel vibration.

Collision warning will also appear on the infotainment system screen.

Collision warning will operate when all the following conditions are satisfied:

- The gear is shifted to R (Reverse)
- Your driving speed is below 5 mph (8 km/h)
- The approaching vehicle is within approximately 82 ft (25 m) from the left and right side of your vehicle
- The speed of the vehicle approaching from the left and right is above 3 mph (5 km/h)

*** NOTICE**

- If the operating conditions are satisfied, there will be a warning whenever the vehicle approaches from the left or right side even though your vehicle speed is 0 mph (0 km/h).
- The images and colors on the instrument cluster may differ depending on the instrument cluster type or theme selected from the instrument cluster.

Emergency braking

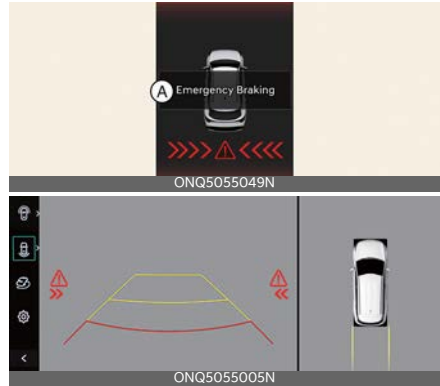
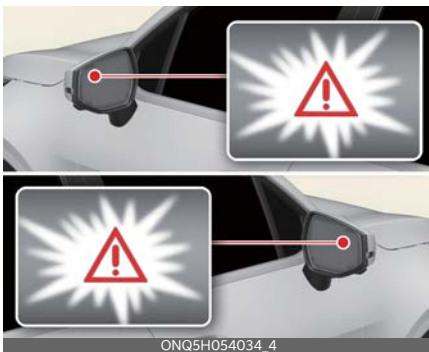

A: Emergency Braking

If Collision warning recognizes a hazard, it will alert the driver with a warning light on the outside rear view mirror, a warning message, an audible warning and steering wheel vibration.

Collision warning will also appear on the infotainment system screen.

Emergency braking will be assisted to help prevent collision with approaching vehicles from the left and right.

Emergency braking will operate when all the following conditions are satisfied:

- The gear is shifted to R (Reverse) while your driving speed is below 5 mph (8 km/h)
- The approaching vehicle is within approximately 5 ft (1.5 m) from the left and right side of your vehicle
- The speed of the vehicle approaching from the left and right is above 3 mph (5 km/h)

⚠ WARNING

Brake control ends when the conditions of the approaching vehicle from the rear left or right side are as below:

- The approaching vehicle is out of the detecting range

- The approaching vehicle passes behind your vehicle
- The approaching vehicle does not drive toward your vehicle
- The approaching vehicle speed slows down
- You depress the brake pedal with sufficient power

Stopping vehicle and ending brake control



A: Drive carefully

When your vehicle stops due to emergency braking, a warning message will appear on the instrument cluster.

You should depress the brake pedal immediately and check your surroundings.

- Brake control will end after your vehicle is stopped by emergency braking for approximately 2 seconds.
- During emergency braking, braking control by Rear Cross-Traffic Collision-Avoidance Assist will automatically cancel when the driver excessively depresses the brake pedal.

WARNING

- For your safety, change the Settings after parking the vehicle at a safe location.
- If any other function's warning message is displayed or audible warning is generated, Rear Cross-Traffic Colli-

sion-Avoidance Assist's warning message may not be displayed and audible warning may not be heard.

- You may not hear the warning sound of Rear Cross-Traffic Collision-Avoidance Assist in noisy surroundings.
- Rear Cross-Traffic Collision-Avoidance Assist may not operate if you apply the brake pedal to avoid collision.
- During Rear Cross-Traffic Collision-Avoidance Assist operation, your vehicle may stop suddenly injuring passengers and shifting loose objects. Always have seat belts on and keep loose objects secured.
- Even if there is a problem with Rear Cross-Traffic Collision-Avoidance Assist, your vehicle's basic braking performance will operate properly.

WARNING

- When Rear Cross-Traffic Collision-Avoidance Assist is operating, its braking control will automatically cancel when you excessively depress the accelerator pedal.
- Rear Cross-Traffic Collision-Avoidance Assist does not operate in all situations and cannot avoid all collisions.
- Rear Cross-Traffic Collision-Avoidance Assist may not warn you depending on the road and driving conditions.
- It is your responsibility to control your vehicle. Do not solely depend on Rear Cross-Traffic Collision-Avoidance Assist. Maintain a safe braking distance, and if necessary, depress the brake pedal to reduce speed or to stop your vehicle.

- Never deliberately operate Rear Cross-Traffic Collision-Avoidance Assist on people, animals, objects, etc. It may cause serious injury or death.

WARNING

The brake control may not operate properly depending on the status of ESC (Electronic Stability Control).

There will only be a warning when:

- The ESC (Electronic Stability Control) warning light is on
- ESC (Electronic Stability Control) is engaged with a different function

*** NOTICE**

- If braking is assisted by Rear Cross-Traffic Collision-Avoidance Assist, you must immediately depress the brake pedal and check the surroundings.
- After shifting the gear to R (Reverse), braking control will operate once for left and right vehicle approach.

Rear Cross-Traffic Collision-Avoidance Assist malfunction and limitations

Rear Cross-Traffic Collision-Avoidance Assist malfunction

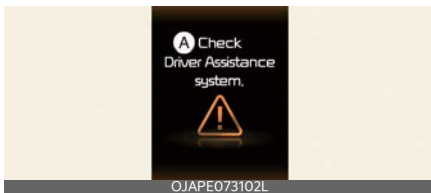

A: Check Driver Assistance system
If Rear Cross-Traffic Collision-Avoidance Assist is not working properly, a warning message will appear on the instrument cluster for several seconds,

and the Master warning light (⚠) will appear on the instrument cluster. Visit an authorized Kia dealer.

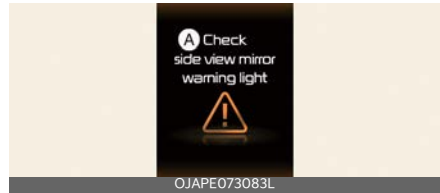

A: Check side view mirror warning light

When the outside rear view mirror warning light is not working properly, a warning message will appear on the instrument cluster for several seconds, and the Master warning light (⚠) will appear on the instrument cluster. Have the function be inspected by an authorized Kia dealer.

Rear Cross-Traffic Collision-Avoidance Assist disabled

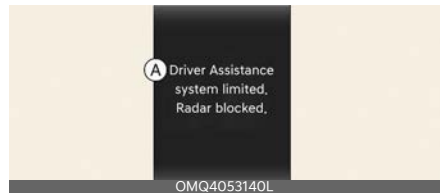

A: Driver Assistance system limited. Radar blocked.

When the rear bumper around the rear-side radar or sensor is covered with foreign material, such as snow, rain, trailer or carrier, it can reduce the detecting performance and temporarily limit or disable Rear Cross-Traffic Collision-Avoidance Assist.

If this occurs, a warning message will appear on the instrument cluster. Rear Cross-Traffic Collision-Avoidance Assist will operate properly when such

foreign material or trailer, etc., is removed.

If Rear Cross-Traffic Collision-Avoidance Assist does not operate properly after it is removed, have the function be inspected by an authorized Kia dealer.

⚠ WARNING

- Even though a warning message does not appear on the cluster, Rear Cross-Traffic Collision-Avoidance Assist may not operate properly.
- Rear Cross-Traffic Collision-Avoidance Assist may not operate properly in an open area where any substances are not detected after turning ON your vehicle.

⚠ CAUTION

Turn off Rear Cross-Traffic Collision-Avoidance Assist to install or remove a trailer, carrier, or another attachment. Turn on Rear Cross-Traffic Collision-Avoidance Assist when finished.

Limitations of Rear Cross-Traffic Collision-Avoidance Assist

Rear Cross-Traffic Collision-Avoidance Assist may not operate properly, or it may operate unexpectedly under the following circumstances:

- Departing from areas with overgrown foliage
- Departing from areas where roads are wet
- Speed of an approaching vehicle is fast or slow

Braking control may not work, and your attention is required in the following circumstances:

- The vehicle vibrates severely while driving over a bumpy, uneven road or pothole
- Driving on a slippery surface such as snow, rain, ice, etc.
- The tire pressure is low or a tire is damaged
- Remote Smart Parking Assist is operating (if equipped)

*** NOTICE**

For more details on the limitations of the rear corner radar, refer to "Blind-Spot Collision-Avoidance Assist (BCA) (if equipped)" on page 7-33.

⚠ WARNING

- Driving near a vehicle or structure



1 Structure

Rear Cross-Traffic Collision-Avoidance Assist may be limited when driving near a vehicle or structure, and may not detect a vehicle approaching from the left or right. The function may not warn you or control the brakes when necessary.

Always check your surroundings while backing up.

- When the vehicle is in a complex parking environment

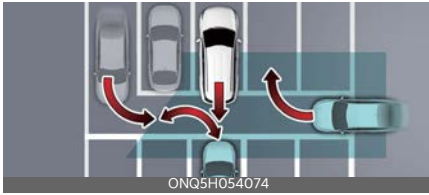

Rear Cross-Traffic Collision-Avoidance Assist may detect vehicles which are parking or pulling out near your vehicle (for example, a vehicle leaving beside your vehicle, a vehicle parking or pulling out in the rear area, a vehicle approaching your vehicle making a turn, etc.).

The function may unnecessarily warn the driver and control the brake.

Always check your surroundings while backing up.

- When the vehicle is parked diagonally



1 Vehicle

Rear Cross-Traffic Collision-Avoidance Assist may be limited when backing up diagonally and may not detect the vehicle approaching from the left or right. The function may not warn you or control the brakes when necessary.

Always check your surroundings while backing up.

- When the vehicle is on or near a slope



Rear Cross-Traffic Collision-Avoidance Assist may be limited when your vehicle is on an uphill or downhill slope, or near it, and may not detect a vehicle approaching from the left or right. The function may not warn you or control the brakes when necessary. Always check your surroundings while backing up.

- Pulling into a parking space where there is a structure



1 Structure,

2 Wall

Rear Cross-Traffic Collision-Avoidance Assist may detect vehicles passing by in front of you when parking in reverse into a parking space with a wall or structure in the rear or side area. The function may unnecessarily warn the driver and control the brake. Always check your surroundings while backing up.

- When the vehicle is parked rearward

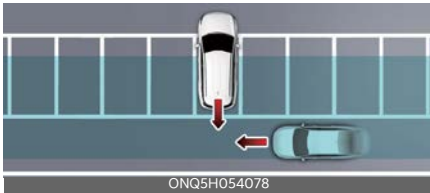

Rear Cross-Traffic Collision-Avoidance Assist may detect vehicles passing by behind you when parking in reverse into a parking space. The function may unnecessarily warn the driver and control the brake.

Always check your surroundings while backing up.

⚠ WARNING

- When you are towing a trailer or another vehicle, turn off Rear Cross-Traffic Collision-Avoidance Assist for safety reasons.
- Rear Cross-Traffic Collision-Avoidance Assist may not operate properly if interfered with by strong electromagnetic waves.
- Rear Cross-Traffic Collision-Avoidance Assist may not operate for 3 seconds after your vehicle is started, or the rear corner radars are initialized.
- Even if restarting the vehicle with the sensors blocked or malfunctioning, Rear Cross-Traffic Collision-Avoidance Assist may not properly operate as the function maintains the last setting.

This device complies with Part 15 of the FCC rules.

Operation is subject to the following two conditions:

1. This device may not cause harmful interference, and
2. This device must accept any interference received, including interference that may cause undesired operation.

Forward/Reverse Parking Distance Warning (PDW) (if equipped)

Forward/Reverse Parking Distance Warning uses the front and rear ultrasonic sensors to detect and warns you if a person, animal, or object is within a certain distance when your vehicle is stopped or driving at low speed.

Detecting sensor

Front ultrasonic sensors



Rear ultrasonic sensors



Refer to the pictures above for the detailed locations of the detecting sensors.

Forward/Reverse Parking Distance Warning settings

Warning Methods

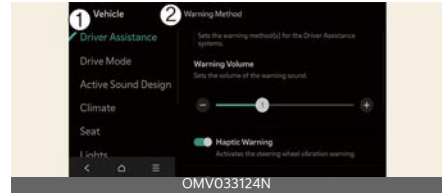

1 Driver Assistance

2 Warning Methods

The **Warning Methods** can be set with the vehicle on. Select **Setup** → **Vehicle** → **Driver Assistance** → **Warning Methods** from the settings menu in the infotainment system to change the following settings:

- **Warning Volume:** Adjusts the volume of the warning sound.

* INFORMATION

- Ensure that **Warning Methods** you have set may apply to the **Warning Methods** of other driver assistance systems.
- **Warning Methods** will maintain its last setting even if the vehicle is restarted.
- The setting menu may not be available for your vehicle depending on your vehicle features and specifications.

⚠ CAUTION

When the vehicle and a trailer are connected electrically, Reverse Parking Distance Warning automatically turns off. In this case, you cannot get help from Parking Distance Warning. Always drive with care. (if Kia genuine part equipped)

Parking Distance Warning Auto On

You can set the parking distance warning to be ON at low speeds. To use Parking Distance Warning Auto On function, select **Setup** → **Vehicle** → **Driver Assistance** → **Parking Safety** → **Parking Distance Warning Auto On** on the infotainment system.

*** NOTICE**

When **Parking Distance Warning Auto On** is selected, the Parking Safety button indicator (P_{SA}) stays on.

Forward/Reverse Parking Distance Warning operation**Parking Safety button**

Press the Parking Safety (P_{SA}) button to turn on Forward/Reverse Parking Distance Warning. Press the button again to turn it off.

- When the gear is shift to R (Reverse), Parking Distance Warning will automatically turn on (Parking Safety button indicator on).

Forward Parking Distance Warning

Forward Parking Distance Warning will operate when one of these conditions is satisfied:







- The gear is shifted from R (Reverse) to D (Drive) with Reverse Parking Distance Warning on
- The gear is in D (Drive) and the Parking Safety (P_{SA}) button indicator light is on
- Forward Parking Distance Warning warns the driver when the vehicle is in D (Drive)

(If **Setup** → **Vehicle** → **Driver Assistance** → **Parking Safety** → **Parking Distance Warning Auto On** on the infotainment system selected)

*** NOTICE**

- Forward Parking Distance Warning operate when the vehicle's speed is below 6 mph (10 km/h).
- When in R (Reverse), no warning is issued for objects inside the front. Only objects within 24 in (60 cm) outside the front will be alerted.
- If you do not select Parking Distance Warning Auto On, the Forward Parking Distance Warning function will turn off (the indicator light in the button will turn off) when the vehicle speed exceeds 18 mph (30 km/h). Even if you drive below 6 mph (10 km/h) again, the function will not turn on automatically.

Warning indication and warning sound

Distance from object	Warning indicator		Warning sound
	Cluster	Infotainment	
24-48 in (60-120 cm)			Buzzer beeps intermittently (Front inner side)
12-24 in (30-60 cm)			Beeps more frequently
within 12 in (30 cm)			Beeps continuously







- The corresponding indicator will appear whenever each ultrasonic sensor detects a person, animal or object in its sensing range. An audible warning will sound.
- When more than two objects are detected at the same time, the closest one will be warned with an audible warning.
- When the distance from the object is more than 24 in (60 cm), it is not displayed on the instrument cluster.
- The shape of the indicator in the illustration may differ from the actual vehicle.

Reverse Parking Distance Warning

Reverse Parking Distance Warning will operate under the following conditions.

- The gear is shifted to R (Reverse).

Warning indication and warning sound

Distance from object	Warning indicator		Warning sound
	Cluster	Infotainment	
24-48 in (60-120 cm)			Buzzer beeps intermittently
12-24 in (30-60 cm)			Beeps more frequently
within 12 in (30 cm)			Beeps continuously

- The corresponding indicator will appear whenever each ultrasonic sensor detects a person, animal or object in its sensing range. An audible warning will sound.
- When more than two objects are detected at the same time, the closest one will be warned with an audible warning.
- The shape of the indicator in the illustration may differ from the actual vehicle.

Forward/Reverse Parking Distance Warning malfunction and precautions

Forward/Reverse Parking Distance Warning malfunction

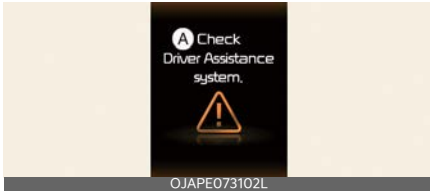

A: Check Driver Assistance system
If there is a problem with Forward/Reverse Parking Distance Warning or related functions and parts, a warning message is displayed on the instrument cluster.

The contents of the warning can be checked in the service message of the utility information view of the instrument cluster display window. If it still does not work properly, have the vehicle inspected by an authorized Kia dealer.

Parking Distance Warning disabled

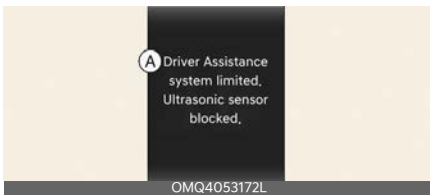

A: Driver Assistance system limited. Ultrasonic sensor blocked.

The ultrasonic sensor can detect objects around the vehicle. The Parking Distance Warning may be temporarily limited or may not operate if snow, rain, foreign substances, etc. get on the sensor. You can check the detection sensor blind warning target (ultrasonic sensor)

in the service message of the utility information view in the instrument cluster display window.

Parking Distance Warning will work normally if you remove the contamination from the recognition sensor. Always keep it clean.

If it still does not work properly even after you have removed the contamination, have the vehicle inspected by an authorized Kia dealer.

* NOTICE

- The Master warning light (⚠) is displayed in the target direction if a malfunction or ultrasonic sensor is blocked while Parking Distance Warning is operating.

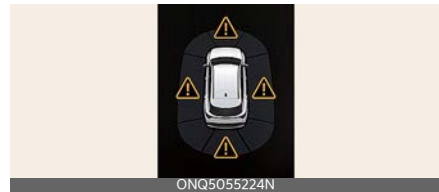

- You can check it in the service message of the utility information view of the instrument cluster display window.

Limitations of Forward/Reverse Parking Distance Warning

Parking Distance Warning may not operate properly when:

- Ice is on the sensor
- Sensor is covered with foreign material, such as snow or water (Parking Distance Warning will operate properly when such substance is removed.)
- The weather is extremely hot or cold
- The sensor or sensor assembly is disassembled

Driver assistance system

- The surface of the sensor is pressed hard or hit with a hard object
- The surface of the sensor is scratched with a sharp object
- The sensors or its surrounding area is directly sprayed with a high pressure washer
- When objects emitting ultrasonic waves, such as a vehicle's horn, motorcycle engine, or large vehicle air brakes are nearby.

Parking Distance Warning may not work normally when:

- Heavy rain or water spray is present
- Water flows on the surface of the sensor
- Affected by another vehicle's sensors
- The sensor is covered with snow or ice
- Driving on uneven road, gravel roads or bushes
- Objects that generate ultrasonic waves are near the sensor
- License plate is installed in a different spot from the original location
- The vehicle bumper height or ultrasonic sensor installation has been modified
- Attaching equipment or accessories next to the ultrasonic sensors

The following objects may not be detected:

- Sharp or slim objects, such as ropes, chains or small poles.
- Narrow objects, such as corners of a square column
- Objects, which tend to absorb sensor frequency, such as clothes, spongy material or snow.
- Objects smaller than 40 in (100 cm) in length and narrower than 6 in (14 cm) in diameter.

Forward/Reverse Parking Distance Warning (PDW)

- Pedestrians, animals, or objects that are very close to the ultrasonic sensors

WARNING

- Parking Distance Warning is a supplemental function. The operation of Parking Distance Warning can be affected by several factors including environmental conditions. It is your responsibility to always check the front and rear view before and while parking.
- Your new vehicle warranty does not cover any accidents or damage to your vehicle due to the malfunction of Parking Distance Warning.
- Pay close attention when driving near objects, pedestrians and especially children. Some objects may not be detected by the ultrasonic sensors due to the objects distance, size or material, all of which can limit the effectiveness of the sensor.
- Parking Distance Warning does not warn you in the order of detection. It varies depending on the speed of your vehicle or the shape of a person, animal or object.
- If the Parking Distance Warning does not operate properly, have the vehicle inspected by an authorized Kia dealer.

Forward/Side/Reverse Parking Distance Warning (PDW) (if equipped)

Forward/Side/Reverse Parking Distance Warning uses the front, side and rear ultrasonic sensors to detect and warns you if a person, animal, or object is within a certain distance when your vehicle is stopped or driving at low speed.

Detecting sensor

Front ultrasonic sensors (if equipped)



Rear ultrasonic sensors (if equipped)



Front side ultrasonic sensors (if equipped)



Rear side ultrasonic sensors (if equipped)



Forward/Side/Reverse Parking Distance Warning settings

Warning Methods

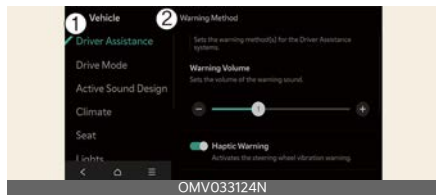

- 1 Driver Assistance
- 2 Warning Methods

The **Warning Methods** can be set with the vehicle on. Select **Setup** → **Vehicle** → **Driver Assistance** → **Warning Methods** from the settings menu in the infotainment system to change the following settings:

- **Warning Volume:** Adjusts the volume of the warning sound.

* NOTICE

- Ensure that **Warning Methods** you have set may apply to the **Warning Methods** of other driver assistance systems.
- **Warning Methods** will maintain its last setting even if the vehicle is restarted.
- The setting menu may not be available for your vehicle depending on your vehicle features and specifications.

▲ CAUTION

When the vehicle and the trailer are connected electrically, Reverse Parking Distance Warning automatically turns off. In this case, you cannot get help from Parking Distance Warning. Always drive with care. (if Kia genuine part equipped)

Parking Distance Warning Auto On

You can set the parking distance warning to be ON at low speeds. To use Parking Distance Warning Auto On function, select **Setup** → **Vehicle** → **Driver Assistance** → **Parking Safety** → **Parking Distance Warning Auto On** on the infotainment system.

* NOTICE

When **Parking Distance Warning Auto On** is selected, the Parking Safety button indicator (P_▲) stays on.

Forward/Side/Reverse Parking Distance Warning operation

Parking Safety button



Press the Parking Safety (P_▲) button to turn on Forward/Side/Reverse Parking Distance Warning. Press the button again to turn off the function.

- When the gear is shifted to R (Reverse), Parking Distance Warning will automatically turn on (Parking Safety button indicator on).

Forward Parking Distance Warning

Forward Parking Distance Warning will operate when one of these conditions is satisfied:

- The gear is shifted from R (Reverse) to D (Drive) with Reverse Parking Distance Warning on
- The gear is in D (Drive) and the Parking safety (P_▲) button indicator light is on
- Forward Parking Distance Warning warns the driver when the vehicle is in D (Drive)

(If **Setup** → **Vehicle** → **Driver Assistance** → **Parking Safety** → **Parking Distance Warning Auto On** on the infotainment system selected)

* NOTICE

- Forward Parking Distance Warning operate when the vehicle's speed is below 6 mph (10 km/h).

- When in R (Reverse), no warning is issued for objects inside the front. Only objects within 24 in (60 cm) outside the front will be alerted.
- If you do not select Parking Distance Warning Auto On, the Forward Parking Distance Warning function will turn off (the indicator light in the button will turn off) when the vehicle speed exceeds 18 mph (30 km/h). Even if you drive below 6 mph (10 km/h) again, the function will not turn on automatically.

- When the distance from the object is more than 24 in (60 cm), it is not displayed on the instrument cluster.
- The shape of the indicator in the illustration may differ from the actual vehicle.

Side Parking Distance Warning







Side Parking Distance Warning will operate when one of these conditions is satisfied:

- Shifting the gear to R (Reverse)
- The gear is in D (Drive) and the Parking Safety (P+L) button indicator light is on
- Forward Parking Distance Warning warns the driver when the vehicle is in D (Drive)

(If **Setup** → **Vehicle** → **Driver Assistance** → **Parking Safety** → **Parking Distance Warning Auto On** on the infotainment system selected)

- Your driving speed is below 6 mph (10 km/h).

Warning indication and warning sound

Distance from object	Warning indicator		Warning sound
	Cluster	Infotainment	
24-48 in (60-120 cm)			Buzzer beeps intermittently (Front inner side)
12-24 in (30-60 cm)			Beeps more frequently
within 12 in (30 cm)			Beeps continuously

- The corresponding indicator will appear whenever each ultrasonic sensor detects a person, animal or object in its sensing range. An audible warning will sound.
- When more than two objects are detected at the same time, the closest one will be warned with an audible warning.

* NOTICE

- Side Parking Distance Warning only works when the vehicle speed is below 6 mph (10 km/h).
- Side Parking Distance Warning function works only when the Forward/Reverse Parking Distance Warning function is turned on.

Warning indication and warning sound

Distance from object	Warning indicator		Warning sound
	Cluster	Infotainment	
24-48 in (60-120 cm)			-
12-24 in (30-60 cm)			-
within 12 in (30 cm)			Beeps continuously

- When the side ultrasonic sensor detects a person or object, it displays indicator lights for each distance on the instrument cluster or infotainment system screen.
- A warning sounds when an object within 12 in (30 cm) of the side is detected in the vehicle's exit path.
- If it detects an object to the side outside the vehicle's exit path, it only displays the indicator light.
- In D (driving), when the distance from the object is 12 in (30 cm) or more, the side-way warning is not displayed on the instrument cluster.
- The shape of the indicator may differ from the actual vehicle.

Reverse Parking Distance Warning

Reverse Parking Distance Warning will operate under the following conditions.

- The gear is shifted to R (Reverse).

Warning indicator and warning sound

Distance from object	Warning indicator		Warning sound
	Cluster	Infotainment	
24-48 in (60-120 cm)			Buzzer beeps intermittently
12-24 in (30-60 cm)			Beeps more frequently
within 12 in (30 cm)			Beeps continuously

- The corresponding indicator will appear whenever each ultrasonic sensor detects a person, animal or object in its sensing range. An audible warning will sound.
- When more than two objects are detected at the same time, the closest one will be warned with an audible warning.
- The shape of the indicator in the illustration may differ from the actual vehicle.

Forward/Side/Reverse Parking Distance Warning malfunction and precautions

Forward/Side/Reverse Parking Distance Warning malfunction

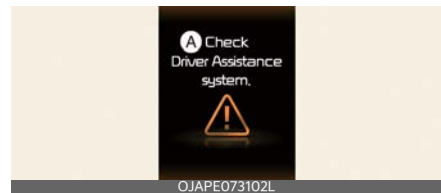

A: Check Driver Assistance system

If there is a problem with the Parking Distance Warning or related functions and parts, a warning message is displayed on the instrument cluster.

The contents of the warning can be checked in the service message of the utility information view of the instrument cluster display window. If it still does not work properly, have the vehicle inspected by an authorized Kia dealer.

Parking Distance Warning disabled

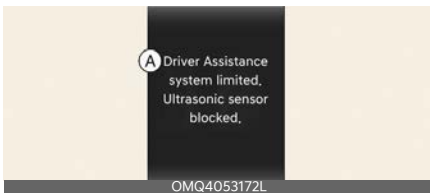

A: Driver Assistance system limited. Ultrasonic sensor blocked.

The ultrasonic sensor can detect objects around the vehicle. The Parking Distance Warning may be temporarily limited or may not operate if snow, rain, foreign substances, etc. get on the sensor. You can check the detection sensor blind warning target (ultrasonic sensor) in the service message of the utility information view in the instrument cluster display window. The Parking Distance Warning will work normally if you remove the contamination from the recognition sensor. Always keep it clean. If it still does not work properly even after you have removed the contamination, have the vehicle inspected by an authorized Kia dealer.

*** NOTICE**

- The Master warning light (⚠) is displayed in the target direction if a malfunction or ultrasonic sensor is blocked while the Parking Distance

Warning is operating. You can check it in the service message of the utility information view of the instrument cluster display window.

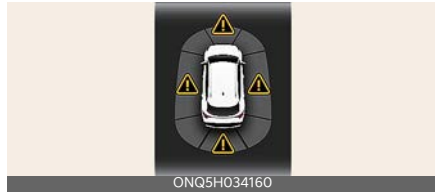

Limitations of Forward/Side/Reverse Parking Distance Warning

Parking Distance Warning may not operate properly when:

- Ice is on the sensor
- Sensor is covered with foreign material, such as snow or water (Parking Distance Warning will operate properly when such substance is removed.)
- The weather is extremely hot or cold
- The sensor or sensor assembly is disassembled
- The surface of the sensor is pressed hard or hit with a hard object
- The surface of the sensor is scratched with a sharp object
- The sensors or its surrounding area is directly sprayed with a high pressure washer
- When objects emitting ultrasonic waves, such as a vehicle's horn, motorcycle engine, or large vehicle air brakes are nearby.

Parking Distance Warning may not work normally when:

- Heavy rain or water spray is present

- Water flows on the surface of the sensor
- Affected by another vehicle's sensors
- The sensor is covered with snow or ice
- Driving on uneven road, gravel roads or bushes
- Objects that generate ultrasonic waves are near the sensor
- License plate is installed in a different spot from the original location
- The vehicle bumper height or ultrasonic sensor installation has been modified
- Attaching equipment or accessories next to the ultrasonic sensors

The following objects may not be detected:

- Sharp or slim objects, such as ropes, chains or small poles.
- Narrow objects, such as corners of a square column
- Objects, which tend to absorb sensor frequency, such as clothes, spongy material or snow.
- Objects smaller than 40 inch (100 cm) in length and narrower than 6 in (14 cm) in diameter.
- Pedestrians, animals, or objects that are very close to the ultrasonic sensors
- Objects in the side space between the front side ultrasonic sensor and the rear side ultrasonic sensor or approaching the side space.

WARNING

- Parking Distance Warning is a supplemental function. The operation of Parking Distance Warning can be affected by several factors, including environmental conditions. It is your responsibility to always check the

front and rear views before and while parking.

- Your new vehicle warranty does not cover any accidents or damage to the vehicle due to the malfunction of Parking Distance Warning.
- Pay close attention when driving near objects, pedestrians and especially children. Some objects may not be detected by the ultrasonic sensor, due to the objects distance, size or material, all of which can limit the effectiveness of the sensor.
- Parking Distance Warning does not warn you in the order of detection. It varies depending on the speed of the vehicle or the shape of a person, animal, or object.
- If the Parking Distance Warning does not operate properly, have the vehicle inspected by an authorized Kia dealer.

Reverse Parking Collision-Avoidance Assist (PCA) (if equipped)

Reverse Parking Collision-Avoidance Assist can detect pedestrians or objects behind your vehicle and may warn you or assist you with braking to help avoid a collision while your vehicle is reversing.

Detecting sensor

Wide-rear view camera (if equipped)



Rear ultrasonic sensors (if equipped)



Reverse Parking Collision-Avoidance Assist settings

Warning Methods

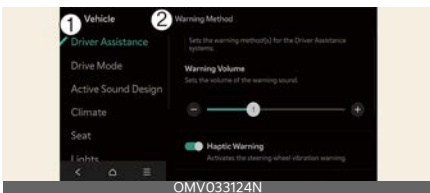

1 Driver Assistance

2 Warning Methods

The **Warning Methods** can be set with the vehicle on. Select **Setup** → **Vehicle** → **Driver Assistance** → **Warning Meth-**

ods from the settings menu in the infotainment system to change the following settings:

- **Warning Volume:** Adjusts the volume of the warning sound.
- **Haptic Warning:** Activate the steering wheel vibration warning

* INFORMATION

- Ensure that **Warning Methods** you have set may apply to the **Warning Methods** of other driver assistance systems.
- **Warning Methods** will maintain its last setting even if the vehicle is restarted.
- The setting menu may not be available for your vehicle depending on the vehicle features and specifications.

Parking Safety

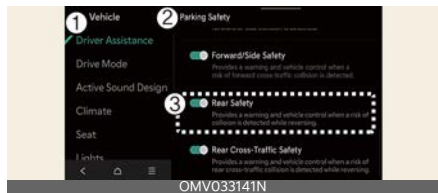

1 Driver Assistance

2 Parking Safety

3 Rear Safety

With the vehicle on, touch **Setup** → **Vehicle** → **Driver Assistance** → **Parking Safety** on the infotainment system.

- **Rear Safety:** It warns or assists in braking when there is a high risk of collision with pedestrians or objects in the rear direction.

⚠ CAUTION

When the vehicle and a trailer are connected electrically, Parking Collision-Avoidance Assist automatically turns off. In this case, you cannot get help Parking Collision-Avoidance Assist. Always drive with care. (if KIA genuine part equipped)

*** NOTICE**

Rear safety will be selected when the vehicle on and **Rear safety** settings will be retained even if the vehicle is restarted.

Reverse Parking Collision-Avoidance Assist operation

Turning On/Off



Press and hold the Parking Safety button (P+) more than 2 seconds to turn the Parking Collision-Avoidance Assist on or off.

Reverse Parking Collision-Avoidance Assist

When detecting a risk of collision with pedestrians or objects behind the vehicle, the warning sound and steering wheel will vibrate and the warning appears in the cluster. If the Surround View Monitor is active, the Infotainment system screen also displays a warning. If a collision is urgent, the Reverse Parking Collision-Avoidance Assist controls the breaking of the vehicle.

Backward safety function

Reverse Parking Collision-Avoidance Assist is enabled when the following conditions are satisfied:

- The liftgate and doors are closed
- The Electronic Parking Brake (EPB) is released
- The gear is shifted to R (Reverse)
- Your driving speed is below 6 mph (10 km/h) (detecting pedestrians)
- Your driving speed is below 1 mph (4 km/h) (detecting objects)
- Parking Collision-Avoidance Assist components such as the wide-rear view camera and the rear ultrasonic sensors are in normal conditions

Braking assist is released after 5 minutes. Immediately depress the brake pedal and check your surroundings.

Braking assist is also released under the following conditions when:

- The gear is shifted to P (Park) or D (Drive)
- The brake pedal is depressed with sufficient power

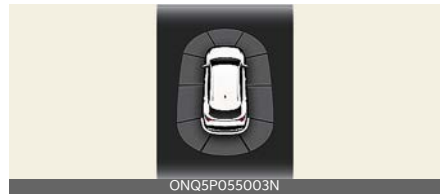

When Parking Collision-Avoidance Assist activates, a line appears at the bottom of the vehicle image in the instrument cluster.

*** NOTICE**

- Parking Collision-Avoidance Assist operates only once after shifting the gear to R (Reverse). To reactivate Parking Collision-Avoidance Assist,

shift the gear from another gear to R (Reverse).

- When Parking Collision-Avoidance Assist is activated while reversing, braking control will be released after 5 minutes and the Electronic Parking Brake (EPB) will be engaged.

Reverse Parking Collision-Avoidance Assist malfunction and limitations

Reverse Parking Collision-Avoidance Assist malfunction

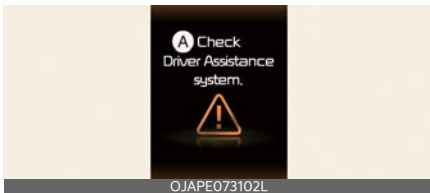

A: Check Driver Assistance system

If there is a problem with Parking Collision-Avoidance Assist or related functions and parts, a warning message is displayed on the instrument cluster. If it still does not work properly, have the vehicle inspected by an authorized Kia dealer.

Reverse Parking Collision-Avoidance Assist disabled

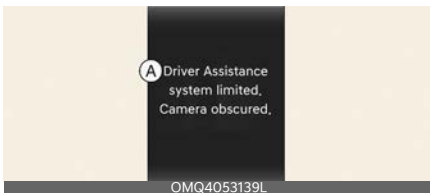

A: Driver Assistance system limited. Camera obscured.

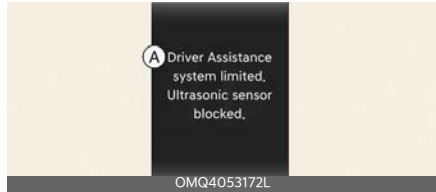

A: Driver Assistance system limited. Ultrasonic sensor blocked.

The wide-rear view camera and rear ultrasonic sensors detect objects around your vehicle. Parking Collision-Avoidance Assist may be temporarily limited or may not operate if snow, rain, foreign substances, etc. get on the sensor. You can check the detection sensor blind warning target (wide-rear view camera, rear ultrasonic sensor) in the service message of the utility information view in the instrument cluster display window. Parking Collision-Avoidance Assist works normally if you remove the contamination from the recognition sensor. Always keep it clean. If it still does not work properly even after decontamination is removed, have the vehicle inspected by an authorized Kia dealer.

* NOTICE

You can check it in the service message of the utility information view of the cluster display window.

Limitations of Reverse Parking Collision-Avoidance Assist

Parking Collision-Avoidance Assist may not assist braking or warn the driver even if there are pedestrians or objects under the following circumstances:

- There is a problem with the vehicle
 - Any non-factory equipment or accessory is installed

- Braking system components, such as brake discs and calipers, are modified
- Wheels are misaligned or suspension components are modified
- Accessories are attached to the steering wheel or steering components are modified
- Your vehicle is unstable due to an accident or other causes
- Bumper height or ultrasonic sensor installation has been modified
- If there is severe tilting of the overall height due to abnormal tire pressure or excessive loading in the cargo area
- Wide view camera(s) or ultrasonic sensor(s) is damaged
- Wide view camera(s) or the ultrasonic sensor(s) is covered with foreign material, such as snow, dirt, etc.
- A snow chain, spare tire, or wheel of a different size is installed
- There is a problem with the surroundings
 - If there is a pattern on the road
 - When the shadow on the ground or reflected light
 - Pedestrians or objects are nearby the vehicle's path
 - Driving through a narrow track or a parking space
 - Driving on uneven roads such as unpaved roads, gravel roads, speed bumps or inclined roads, etc.
 - A trailer or carrier is installed around the rear corner radar
 - Wide view camera(s) is obscured by a light source or by inclement weather, such as heavy rain, fog, snow, etc.

- The surroundings are very bright or very dark
- Outside temperature is very high or very low
- The wind is either strong (above 12 mph (20 km/h)) or blowing perpendicular to the rear bumper
- Objects generating excessive noise, such as vehicle horns, loud motorcycles or truck air brakes, are near your vehicle
- An object that generates ultrasonic waves is nearby
- A wireless device with a transmission function operates near the rear ultrasonic sensor
- It is affected by another vehicle's parking distance warning function
- The road is slippery or inclined
- There is a situation with pedestrians or objects
 - The pedestrians are difficult to detect
 - There is ground height difference between your vehicle and the pedestrian
 - The image of a pedestrian in the wide-rear view camera is indistinguishable from the background
 - The pedestrian is near the rear edge of the vehicle
 - The pedestrian is not standing upright
 - The pedestrian is either too short or tall to detect
 - The pedestrian or cyclist is wearing clothing that easily blends into the background, making it difficult to detect
 - The pedestrian is wearing clothing that does not reflect ultrasonic waves

- Size, thickness, height, or shape of the object does not reflect ultrasonic waves (for example, a pole, bush, curbs, carts, edge of a wall, etc.)
- The pedestrian or the object is moving
- The pedestrian or object is very close to the rear of your vehicle
- There is a large object such as a wall behind a pedestrian or the object
- The object is not located at the rear center of your vehicle
- The object is not parallel to the rear bumper
- The face of the object is not parallel to the bumper
- There is a situation with the driving conditions
 - You drive the vehicle immediately after shifting to R (Reverse) or D (Drive)
 - You accelerate or circle the vehicle

⚠ WARNING

- Always use extreme caution while driving. You are responsible for controlling the brake for safe driving.
- Always look around your vehicle to make sure there are no pedestrians or objects before moving your vehicle.
- The performance of Parking Collision-Avoidance Assist may vary under certain conditions. If vehicle speed is above 2 mph (4 km/h), Parking Collision-Avoidance Assist will provide collision avoidance assistance only when pedestrians are detected. Always look around and pay attention when driving your vehicle.

- Some objects may not be detected by the rear ultrasonic sensors due to the objects distance, size or material, all of which can limit the effectiveness of the sensors.
- Parking Collision-Avoidance Assist may not operate properly or may operate unnecessarily depending on the road conditions and the surroundings.
- Do not solely rely on Parking Collision-Avoidance Assist. Doing so may lead to vehicle damage or injuries.
- Always keep the wide angle cameras and ultrasonic sensors clean.
- Do not use any cleaner containing acid or alkaline detergents when cleaning the camera lens. Use only a mild soap or neutral detergent and rinse thoroughly with water.
- Do not spray the wide angle cameras or the rear ultrasonic sensors or their surrounding area directly with a high pressure washer. It may cause the wide angle cameras or the ultrasonic sensors to malfunction.
- Do not apply objects, such as a bumper sticker or a bumper guard, near the wide angle cameras or ultrasonic sensors or apply paint to the bumper. Doing so may adversely affect the performance of Parking Collision-Avoidance Assist.
- Never disassemble or impact the wide angle cameras or the components of the ultrasonic sensor.
- Do not apply unnecessary force on the wide angle cameras or the ultrasonic sensors. Parking Collision-Avoidance Assist may not operate properly if the wide angle cameras or the ultrasonic sensor(s) are forcibly moved out of proper alignment. Have

your Kia inspected by an authorized Kia dealer.

- Noise may be heard when sudden braking occurs to avoid a collision.
 - If any other warning sound such as the seat belt warning chime is already generated, Parking Collision-Avoidance Assist warning may not sound.
 - Parking Collision-Avoidance Assist may not work properly if the bumper has been damaged, replaced or repaired.
 - Parking Collision-Avoidance Assist may not operate properly if interfered with by strong electromagnetic waves.
 - Playing the vehicle audio system at high volume may prevent passengers from hearing Parking Collision-Avoidance Assist warning sounds.
 - The brake control may not operate properly depending on the status of ESC (Electronic Stability Control).
There will only be a warning when:
 - The ESC (Electronic Stability Control) warning light is on
 - ESC (Electronic Stability Control) is engaged in a different function
 - Check your brake fluid and brake pad conditions regularly. The brake performance may decrease depending on brake condition.
 - Turn off Parking Collision-Avoidance Assist when towing a trailer. If towing and moving in reverse, Parking Collision-Avoidance Assist will activate as it detects the trailer.
-

* NOTICE

Parking Collision-Avoidance Assist can detect a pedestrian or an object when:

- A pedestrian is standing behind the vehicle
 - A large obstacle, such as a vehicle, is parked in the rear center of your vehicle
-

Remote Smart Parking Assist (RSPA) (if equipped)

Remote Smart Parking Assist uses the front, front side, rear side, and rear ultrasonic sensors to detect parking spaces and control vehicle steering, speed, gear shifts, and help enter and exit parking spaces remotely from outside your vehicle.

Function	Description
Remote Operation	Remotely moving forward or backward  OGL3051091

- Remote Operation function may be operated from outside the vehicle using the smart key.
- When Remote Smart Parking Assist operates, Parking Distance Warning and Surround View Monitor will also operate. For more details, refer to "Forward/Side/Reverse Parking Distance Warning (PDW) (if equipped)" on page 7-120 and "Surround View Monitor (SVM) (if equipped)" on page 7-101.

Detecting sensor

Front ultrasonic sensors



Rear ultrasonic sensors



Front side ultrasonic sensors (if equipped)



Rear side ultrasonic sensors (if equipped)





⚠ WARNING

- Never arbitrarily disassemble or apply impact on the ultrasonic sensors or their surrounding area.
- When the ultrasonic sensor surface is covered with foreign material, such as snow or water droplets, it can reduce the detecting performance and temporarily limit or disable of the ultrasonic sensor. Check the status of the ultrasonic sensor or the surroundings and if they are contaminated, clean them by using a soft cloth.
- Do not press hard to the ultrasonic sensor surface, hit it with a hard object, or scrape or scratch the ultrasonic sensor surface. This may result in damage to the ultrasonic sensor surface.
- When using a high-pressure washer, do not spray high pressure water directly on the ultrasonic sensor surface.
- If the bumper height or rear ultrasonic sensor installation has been modified or accessories are attached to the detecting area of the ultrasonic sensor, Remote Smart Parking Assist may not operate properly.

Remote Smart Parking Assist settings

Warning Method



1 Driver Assistance

2 Warning Method

The **Warning Method** can be set with the vehicle on. Select **Setup** → **Vehicle** → **Driver Assistance** → **Warning Method** from the settings menu in the infotainment system to change the following settings:

- **Warning Volume:** Adjusts the volume of the warning sound.





* NOTICE

- Ensure that **Warning Method** you have set may apply to the **Warning Method** of other driver assistance systems.
- **Warning Method** will maintain its last setting even if the vehicle is restarted.
- The setting menu may not be available for your vehicle depending on the vehicle features and specifications.

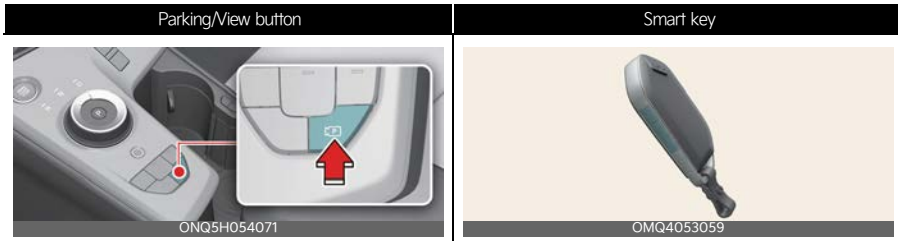
Remote Smart Parking Assist operation

Parking/View button



Location	Name	Symbol	Description
Inside vehicle	Parking/View button		<ul style="list-style-type: none"> Press and hold the Parking/View button to turn on Remote Smart Parking Assist. Also, Forward/Reverse Parking Distance warning will automatically turn on.
Smart key	Remote Start button		<ul style="list-style-type: none"> Press the Remote Start button after the door is locked with the vehicle off to start the vehicle remotely. Press the Remote Start button while Remote Operation function is operating to end function operation.
	Forward button		<ul style="list-style-type: none"> When using the Remote Operation function, the vehicle moves in the direction of the button while the button is pressed.
	Backward button		

Remote Operation

Operating order

Remote Operation operates in the following order:

1. Getting ready to remotely move forward and backward
2. Remotely moving forward and backward

1. Getting ready to remotely move forward and backward

There are two ways to operate Remote Operation function.

Method (1): Using the function with vehicle off



1. Within a certain range from the vehicle press the door lock button (🔒) (1) on the smart key and lock all doors.
2. Press and hold the Remote Start button (🔑) (2) within 4 seconds until the vehicle starts.

* For more details on remotely starting the vehicle, refer to "Smart key" on page 5-7.

Method (2): Using the function with vehicle on

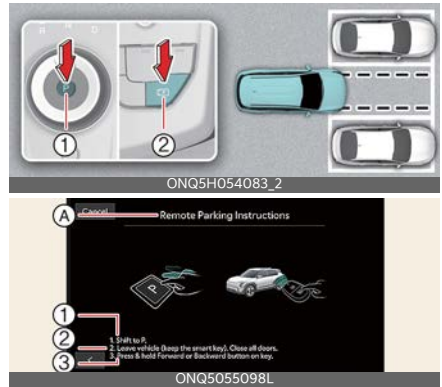

A: Remote Parking Instructions

1. Shift to P.
2. Leave vehicle (keep the smart key). Close all doors.
3. Press and hold the Forward or Backward button on the smart key.
 1. Park the vehicle in front of the space where you want to use Remote Operation function, and shift the gear to P (Park).
 2. Press and hold the Parking/View button (🅅) to turn on Smart Parking Assist. A message **Under REMOTE control** will appear on the infotainment system screen.
 3. Get out of the vehicle with the smart key and close all doors.

* NOTICE

- **Agree** must be selected on the infotainment system screen and the infotainment system has to operate properly to use Remote Operation function.
- Before initiating the Remote Operation function from outside the vehicle,

make sure not to leave any smart keys inside the vehicle.

- The Remote Operation function will not work if there is a spare smart key inside the vehicle.

2. Remote Operation



1. Press and hold one of the Forward (⏪) or Backward (⏩) button on the smart key.
 - Remote Smart Parking Assist will automatically control the steering wheel, vehicle speed and gear shift. The vehicle will move in the direction of the button pressed.
 - While Remote Operation function is operating, if the you let the button, the vehicle will stop and function control will pause. The function will start operating again when the button is pressed and held again.
2. Hold down the Forward (⏪) or Backward (⏩) button until the vehicle reaches the target location.
3. When Remote Operation is done, get in the vehicle with the smart key or press the Remote Start button (⏻) on the smart key from outside the vehicle.
 - The message will appear on the infotainment system screen. The vehicle will automatically shift to P (Park) and engage the parking brake.
 - When the Remote Start button (⏻) is pressed, the vehicle will turn off.

If the driver is in the vehicle, the vehicle will retain ON position.

* NOTICE

- Remote Operation can control the vehicle remotely using the smart key outside the vehicle.
- Check that all smart keys are outside the vehicle when using Remote Operation function.
- Remote Operation function will operate only when the smart key is within 13 ft (4 m) from the vehicle. If there is no vehicle movement even when the Forward or Backward button is pressed on the smart key, check the distance to the vehicle and press the button again.
- The detecting range of the smart key may vary depending on the surroundings that are affected by radio waves such as transmission tower, broadcast station, etc.
- When remotely moving forward using method (1), it is recognized as an exit situation, and the vehicle moves 13 ft (4 m) to check for pedestrians, animals or objects around the vehicle. After confirmation, the steering wheel is controlled according to the condition ahead.
- When remotely moving forward using method (2), it is recognized as a parking situation, and will immediately control the steering wheel according to the condition ahead to assist with entering the parking space and aligning the vehicle. However, performance may reduce depending on the pedestrians, animals, shape of objects, location, etc. around the vehicle.

- For moving remotely backward, both method (1) and (2) aligns the steering wheel first, and then will only move the vehicle straight.

⚠ WARNING

- When using Remote Operation function, make sure that all passengers have gotten out of the vehicle.
- Before leaving the vehicle, close windows and sunroofs, and make sure the vehicle is off before locking the doors.
- If the vehicle's battery is discharged or Remote Smart Parking Assist malfunctions when parked in a narrow parking space, Remote Operation function will not operate. Always park your vehicle in a space wide enough for you to get in or out of your vehicle.
- Please note that depending on the parking space, you may not be able to exit from the space you have entered by using Remote Operation function.
- After parking, the surrounding may change due to the movement of surrounding vehicles. If this occurs, Remote Operation function may not operate.

Remote Smart Parking Assist operation status

Operation Status	Smart key LED	Hazard warning light
Under control	Green LED Continuously blinks	-
Pause	Red LED Continuously blinks	Blinks
Off	Red LED illuminates for 4 seconds and then turns off	Blinks 3 times and turns off
Complete	Green LED illuminates for 4 seconds and then turns off	Blinks 1 time and turns off

*** NOTICE**

If the smart key is not within the operating range from the vehicle (approximately 13 ft (4 m)), the smart key LED will not appear or blink. Use the smart key within the operating range.

How to turn off Remote Operation function while operating

- Press the Parking/View (P/V) button or shift the gear except to P (Park) while the infotainment system screen guides the driver using method 2.
- Press the Parking Safety button (P-S) or select **Cancel** on the infotainment system screen.
- Press the Remote Start button (R) on the smart key while the vehicle is being controlled by Remote Operation function. Remote Operation function will turn off. At this time, the vehicle will turn off.
- Get on the vehicle with the smart key. Remote Operation function will turn off. At this time, the vehicle will remain on.

The function will pause in the following conditions when:

When Remote Operation function is paused, the vehicle will stop. If the condition that made the function to pause disappears, the function may operate again.

- There is a pedestrian, animal or object in the direction the vehicle is moving
- The door or trunk is open
- The Forward (⏪) or Backward (⏩) button is not continuously pressed
- Simultaneously pressing multiple buttons on a smart key
- The smart key is not operated within 13 ft (4 m) from the vehicle
- Button of another smart key is pressed in addition to the operating smart key (Excluding start button)
- When Parking Collision-Avoidance Assist, Blind-Spot Collision-Avoidance Assist or Rear Cross-Traffic Collision-Avoidance Assist operates
- The vehicle moves 22 ft (7 m) while the smart key is pressed with Remote Operation function (maximum travel distance per button press)
- The brake pedal or accelerator pedal is depressed when all the doors are closed
- The smart key is outside the vehicle when the brake pedal is depressed while the driver's door is open
- Rapid acceleration occurs
- Vehicle skid occurs
- The wheel is stuck by an obstacle and cannot move
- Approximately 3 minutes and 50 seconds have past after Remote Operation function has started to operate
- The slope of the road exceeds the operational range
- The function is paused for more than 1 minute
- The total travel distance of the vehicle has exceeded 45 ft (14 m) after Remote Operation function operation
- The steering wheel, gearshift, braking, and drive controls are not working normally
- There is a problem with the smart key or the smart key battery is low
- ABS, TCS or ESC system operates due to slippery road conditions
- The alarm of the Theft Alarm System sounds

The function will cancel in the following conditions when:

When Remote Operation function is canceled, the vehicle will automatically stop, shift the gear to P (Park) and engage EPB (Electronic Parking Brake).

- The steering wheel is steered
- The gear is shifted while the vehicle is moving
- Operating EPB while the vehicle is moving
- The vehicle hood is open

Remote Smart Parking Assist malfunction and limitations

Remote Smart Parking Assist malfunction

Remote Smart Parking Assist check



- 1 Check Parking Assist
- 2 Visit a dealer or nearby service center.

When Remote Smart Parking Assist is not working properly, the **Check Parking Assist** warning message will appear on the infotainment system screen. If the message appears, stop using the function, and we recommend that the function be inspected by an authorized Kia dealer/service partner.

Remote Smart Parking Assist canceled



- 1 Parking Assist Canceled
- 2 Please refer to the owner's manual.

When Remote Smart Parking Assist is operating, the function can be canceled, and the **Parking Assist Canceled.** warning message may appear regardless of

the parking order. Other messages may appear depending on the situations. Follow the instructions provided on the infotainment system screen while parking your vehicle with Remote Smart Parking Assist. Always look around and pay attention when using the function.

Remote Smart Parking Assist standby



- 1 Parking Assist Conditions Not Met
- 2 Please refer to the owner's manual.

When **Parking Assist Conditions Not Met** message appears, when Parking/View (Ⓜ) button has been pressed and held, Remote Smart Parking Assist is in standby. After a while, press and hold the Parking/View (Ⓜ) button again to see if the function works.

The message appears even when the smart key's battery is low. Check the smart key battery level.

Limitations of Remote Smart Parking Assist

In the following circumstances, function performance to park or exit the vehicle may be limited, there may be a risk of collision, or Remote Smart Parking Assist may turn off. Park or exit the vehicle manually if necessary.

- Accessories are attached to the steering wheel or steering components are modified

- The vehicle is installed with a snow chain, spare tire or different size wheel
- Braking system components, such as brake discs and calipers, are modified
- Drive unit components, such as the engine (motor), transmission, etc., are modified
- Tire pressure is lower or higher than the standard tire pressure
- Your vehicle is loaded with cargo longer or wider than your vehicle or a trailer is connected to your vehicle
- Wheels are misaligned or suspension components are modified
- Your vehicle is leaned severely to one side
- Your vehicle is equipped with a trailer hitch
- The license plate is installed differently from the original location
- There is a person, animal or object above or below the ultrasonic sensor when Remote Smart Parking Assist is activated
- The parking space is curved or diagonal
- There is an obstacle such as a person, animal or object (trash can, bicycle, motorcycle, shopping cart, narrow pillar etc.) near the parking space
- There is a circular pillar or narrow pillar, or a pillar surrounded by objects such as fire extinguisher, etc. near the parking space
- The road surface is bumpy (curb-stone, speed bump, etc.)
- The road is slippery
- The parking space is near a vehicle with higher ground clearance or big, such as a truck, etc.
- The parking space is Inclined

- There is heavy wind
- Operating Remote Parking Assist on uneven roads, gravel roads, bushes, etc.
- The performance of the ultrasonic sensor is affected by extremely hot or cold weather
- The ultrasonic sensor is covered with snow or water
- An object that generates ultrasonic waves is nearby
- A wireless device with a transmission function operates near the ultrasonic sensors
- Your vehicle is affected by another vehicle's Parking Distance Warning
- The sensor is mounted or positioned incorrectly by an impact to the bumper
- When the ultrasonic sensor cannot detect the following objects: Sharp or slim objects, such as ropes, chains or small poles
- Objects smaller than 40 in (100 cm) in length and narrower than 6 in (14 cm) in diameter
- Objects which tend to absorb sensor frequency, such as clothes, spongy material or snow

Remote Smart Parking Assist may not operate normally under the following circumstances:

Parking on inclines



Park manually when parking on inclines.

Parking on uneven road



ONQ5H054086

Remote Smart Parking Assist may cancel when the vehicle slips, or the vehicle cannot move due to road conditions such as pebbles or fragmented stones.

Parking behind a truck



ONQ5H054087

Do not use Remote Smart Parking Assist around vehicles with higher ground clearance, such as a bus, truck, etc. It may lead to an accident.

Parking near a pillar



ONQ5H054088

Remote Smart Parking Assist performance may reduce or collision with an obstacle may occur when there is a narrow object, circular pillar, square pillar, or a pillar surrounded by objects such as a fire extinguisher, etc. near the parking space. The driver should park the vehicle manually.

Parking in a parking space with a vehicle on one side only



ONQ5H054089

If Remote Smart Parking Assist is used, when parking in a parking space with a vehicle only on one side, your vehicle may cross the parking line to avoid the parked vehicle.

Parking in snow



ONQ5H054090

Snow may interfere with sensor operation, or Remote Smart Parking Assist may cancel if the road is slippery while parking.

Parking diagonally

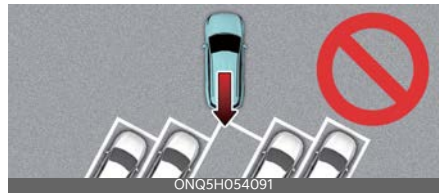

ONQ5H054091

Remotely Operation function may not operate properly in a diagonal parking space.

⚠ WARNING

- It is the driver's responsibility to park and exit safely. Use Remote Smart Parking Assist while checking your surroundings at all times when park-

ing and exiting. Under various environmental conditions, braking control may not operate because people, animals, other vehicles or objects around the vehicle may not be properly detected. If there is a risk of collision with a nearby obstacle, release the control button to stop the function.

- When using Remote Smart Parking Assist, stay out of the way in the direction the vehicle moves for your safety.
- Always check surroundings when using Remote Smart Parking Assist. You may collide with pedestrians, animals, or objects if they are near the sensor or are in the sensor's blind spot area.
- A collision may occur if a pedestrian, animal, or object suddenly appears while Remote Smart Parking Assist is operating.
- Do not use Remote Smart Parking Assist when under the influence of alcohol.
- Do not let children or other people to use the smart key.
- If Remote Smart Parking Assist is used continuously for a long period, it may adversely affect Remote Smart Parking Assist performance.
- Remote Smart Parking Assist may not operate normally if the vehicle needs wheel alignment adjustment such as when the vehicle tilts to one side. Have the vehicle be inspected by an authorized Kia dealer as soon as possible.
- Noise may be heard when braking occurs by Remote Smart Parking Assist or when the brake pedal is depressed by the driver.

- Remote Smart Parking Assist may suddenly apply the brake to avoid collision.
- Use Remote Smart Parking Assist only in a parking space that is large enough for the vehicle to move safely.
- When Remote Smart Parking Assist is not working properly, have the vehicle inspected by an authorized Kia dealer as soon as possible.

* NOTICE

- If the 3rd stage warning (continuous beep) of the Forward/Reverse Parking Distance Warning sounds while Remote Smart Parking Assist is operating, it means the obstacle detected is close to your vehicle. At this time, Remote Smart Parking Assist will temporarily stop operating. Make sure there are no pedestrians, animals, or objects around your vehicle.
 - Depending on brake operation, the stop lights may come on while the vehicle is moving.
 - If the vehicle is remotely started that has been parked in cold weather for a long time, the operation of Remote Smart Parking function may be delayed or canceled depending on vehicle condition.
-

Declaration of conformity (if equipped)

The radio frequency components (Front Radar) complies:

For the United States and United States territories



OCV051263N

The antenna(s) must be installed such that a minimum separation distance of at least 20 cm is maintained between the radiator (antenna) and all persons at all times. This device must not be co-located or operating in conjunction with any other antenna or transmitter.

ONQ5051134N

For Canada

This device complies with Innovation, Science and Economic Development Canada's licence-exempt RSS standard(s). Operation is subject to the following two conditions:

- (1) this device may not cause interference, and
- (2) this device must accept any interference, including interference that may cause undesired operation of the device.

Le présent appareil est conforme aux CNR d'Industrie Canada applicables aux appareils radio exempts de licence. L'exploitation est autorisée

aux deux conditions suivantes:

- (1) l'appareil ne doit pas produire de brouillage, et
- (2) l'utilisateur de l'appareil doit accepter tout brouillage radioélectrique subi, même si le brouillage est susceptible d'en compromettre le fonctionnement.

ONQ5051135N

The radio frequency components (Rear Corner Radar) complies:

For the United States and United States territories



OCV051263N

FCC ID : LTQ2H5TR

This device complies with Part 15 of the FCC Rules. Operation is subject to the following two conditions:

- (1) this device may not cause harmful interference, and

- (2) this device must accept any interference received, including interference that may cause undesired operation.

CAUTION TO USERS

Changes or modifications not expressly approved by the party responsible for compliance could void the user's authority to operate the equipment.

ONQ5P052042N

For Canada

Model: 2H5TR

IC: 3659A-2H5TR

This device complies with Industry Canada licence-exempt RSS standard(s). Operation is subject to the following two conditions:

- (1) this device may not cause interference, and
- (2) this device must accept any interference, including interference that may cause undesired operation of the device.

Le présent appareil est conforme aux CNR d'Industrie Canada applicables aux appareils radio exempts de licence. L'exploitation est autorisée aux deux conditions suivantes:

- (1) l'appareil ne doit pas produire de brouillage, et
- (2) l'utilisateur de l'appareil doit accepter tout brouillage radioélectrique subi, même si le brouillage est susceptible d'en compromettre le fonctionnement.

ONQ5P052043N

Radio frequency radiation exposure information:

This equipment complies with FCC radiation exposure limits set forth for an uncontrolled environment. This equipment should be installed and operated with minimum distance of 8 in (20 cm) between the radiator (antenna) and your body. This transmitter must not be co-located or operating in conjunction with any other antenna or transmitter.

Road warning	8-3
• Hazard warning flasher.....	8-3
In case of an emergency while driving	8-3
• If the vehicle stalls while driving.....	8-3
• If the engine stalls at a crossroad or crossing.....	8-3
• If you have a flat tire while driving.....	8-3
If the engine does not start	8-4
• If engine doesn't turn over or turns over slowly.....	8-4
• If engine turns over normally but does not start.....	8-4
Emergency starting	8-5
• Before jump starting (for hybrid vehicle).....	8-5
• Jump starting.....	8-5
If the engine overheats	8-7
Tire Pressure Monitoring System (TPMS)	8-8
• Effective use of TPMS.....	8-9
• Low tire pressure telltale.....	8-10
• TPMS malfunction indicator.....	8-11
• Tire replacement with TPMS.....	8-11
• This device complies with Part 15 of the FCC rules.....	8-12
If you have a flat tire (with spare tire)	8-13
• Jack and tools.....	8-13
• Removing and storing the spare tire.....	8-14
• Changing tires.....	8-15
• Important - use of compact spare tire.....	8-18
• Jack label.....	8-20
If you have a flat tire (with tire mobility kit (TMK))	8-21
• Introduction.....	8-21
• Components of the Tire Mobility Kit.....	8-22
• Using the TMK.....	8-23
• Distributing the sealant.....	8-24

8 What to do in an emergency

- Checking the tire inflation pressure8-24
- Towing..... 8-26**
- When flatbed is unavailable..... 8-27

What to do in an emergency

Road warning

When an emergency situation occurs on or near roadway, you must alert approaching or passing vehicles to be careful as they pass. Use the hazard warning flasher.

Hazard warning flasher

The hazard warning flasher serves as a warning to other drivers to exercise extreme caution when approaching, overtaking, or passing your vehicle.



It should be used whenever emergency repairs are being made or when the vehicle is stopped near the edge of a roadway.

Depress the flasher switch with the ENGINE START/STOP button in any position. The flasher switch is located in the center of the dashboard. Turn signal lights will flash simultaneously.

- The hazard warning flasher can be operated whether your vehicle is running or not.
- The turn signals will not operate when the hazard flasher is on.
- Care must be taken when using the hazard warning flasher while the vehicle is being towed.

In case of an emergency while driving

If an emergency occurs while driving, stay calm and take the following steps.

If the vehicle stalls while driving

1. Reduce your speed gradually, keeping a straight line.
2. Move cautiously off the road to a safe place.
3. Turn on your hazard warning flasher.
4. Try to start the vehicle again. If it does not start, contact an authorized Kia dealer or seek other qualified assistance.

If the engine stalls at a crossroad or crossing

- If the engine stalls at a crossroad or crossing, set the shifter dial in the N (Neutral) position and then push the vehicle to a safe place.

If you have a flat tire while driving

1. Take your foot off the accelerator pedal and let the vehicle slow down while driving straight ahead.
Do not immediately apply the brakes or attempt to pull off the road. You may lose control.
2. When the vehicle has slowed to such a speed that it is safe to do so, brake carefully and pull off the road.
3. Drive off the road as far as possible and park on firm level ground.
If you are on a divided highway, do not park in the median area between the two traffic lanes.
4. When the vehicle is stopped, turn on your emergency hazard flashers, set the parking brake and put the transmission in P (Park).

5. Have all passengers exit the vehicle. Be sure they all exit on the side of the vehicle that is away from traffic.
6. When changing a flat tire, follow the instruction provided later in this section.

*** NOTICE**

If there was a check engine light and loss of power or stall and if safe to do so, wait at least 10 seconds to restart the vehicle after it stalls. This may reset the car so it will no longer run at low power (limp home) condition.

If the engine does not start

When the engine doesn't start, first check to see how much fuel there is and whether the battery is discharged.

If engine doesn't turn over or turns over slowly

1. Be sure the shifter dial is in N (Neutral) or P (Park) and the emergency brake is set.
2. Check the battery connections to be sure they are clean and tight.
3. Turn on the interior light. If the light dims or goes out when you operate the starter, the battery is discharged.
4. Check the starter connections to be sure they are securely tightened.

⚠ WARNING

Do not push or pull the vehicle to start it. This could cause damage to your vehicle. Refer to "Emergency starting" on page 8-5.

If engine turns over normally but does not start

1. Check the fuel level and add fuel if necessary.
2. With the ENGINE START/STOP button in the OFF position, check all connectors at the ignition coils and spark plugs. Reconnect any that may be disconnected or loose.
3. Check the fuel line in the engine compartment.
4. If the engine still does not start, call an authorized Kia dealer or seek other qualified assistance.

Emergency starting

Before jump starting (for hybrid vehicle)

This vehicle does not have a regular 12V battery that needs periodic replacement. It is lithium-ion type integrated into the HEV high voltage battery. The vehicle has a 12V battery protection system that cuts 12V battery from vehicle draw to prevent full discharge.

Jump starting

In the event vehicle still does not have a functional 12V battery (check if interior lights do not turn on) then you can try a jump start to the engine compartment jumper terminals using a 12V booster pack or jumper cables from another vehicle's 12V battery according to the following instructions.

CAUTION

Jump starting can be dangerous if done incorrectly. Follow the jump starting procedure in this section to avoid serious injury or damage to your vehicle. If in doubt about how to properly jump start your vehicle, we strongly recommend that you have a service technician or towing service do it for you.

1. Position the vehicles close enough that the jumper cables will reach, but do not allow the vehicles to touch. Avoid fans or any moving parts in the engine compartment at all times, even when the vehicles are turned off.
2. Turn off all electrical devices such as radios, lights, air conditioning, etc. Put the vehicles in P (Park) and set the parking brakes. Turn both vehicles OFF.

3. Connect the jumper cables in the exact sequence shown in the illustration. First connect one jumper cable to the red, positive (+) jumper terminal of your vehicle (1).



4. Connect the other end of the jumper cable to the red, positive (+) battery/jumper terminal of the assisting vehicle (2).
5. Connect the second jumper cable to the black, negative (-) battery/chassis ground of the assisting vehicle (3).
6. Connect the other end of the second jumper cable to the black, negative (-) chassis ground of your vehicle (4).

Do not allow the jumper cables to contact anything except the correct battery or jumper terminals or the correct ground. Do not lean over the battery when making connections.

7. Press the 12V Battery Reset button.



8. Start the engine of the assisting vehicle and let it run for a few minutes.
9. Start your vehicle as soon as possible. After starting the vehicle (READY indicator on), operate the vehicle safely outdoors in ready mode stopped and/or drive it for 30 minutes total to charge the 12V battery fully.

If your vehicle does not start after a few attempts, it probably requires servicing. Seek qualified assistance. If the cause of your battery discharging is not apparent, have your vehicle checked by an authorized Kia dealer.

Disconnect the jumper cables in the exact reverse order you connected them:

1. Disconnect the jumper cable from the black, negative (-) chassis ground of your vehicle (4).
2. Disconnect the other end of the jumper cable from the black, negative (-) battery/chassis ground of the assisting vehicle (3).
3. Disconnect the second jumper cable from the red, positive (+) battery/jumper terminal of the assisting vehicle (2).
4. Disconnect the other end of the jumper cable from the red, positive (+) jumper terminal of your vehicle (1).

*** NOTICE**

The voltage range of the charger should be 13.3-14 V and its current range should be less than 60 A. (13.8V is recommended).

⚠ CAUTION

- The use of an improper charger with a voltage and current range higher than specified may cause overheating and damage to the 12V battery.
- The use of an incorrect charger will lead to a power shut-off to save the 12V battery. Stop using the incorrect charger once the power of the vehicle is shut off.

*** NOTICE**



An inappropriately disposed battery can be harmful to the environment and human health. Dispose the battery according to your local law(s) or regulation.

*** NOTICE**

To prevent damage to your vehicle:

- Only use a 12-volt power supply (battery or jumper system) to jump start your vehicle.
- Do not attempt to jump start your vehicle by push-starting.

Push-starting

Vehicles equipped with automatic transmission cannot be push-started, and only jump starting can be applied. Refer to "Emergency starting" on page 8-5.

⚠ WARNING

Tow starting vehicle

Never tow a vehicle to start it. When the engine starts, the vehicle can suddenly surge forward and could cause a collision with the tow vehicle.

If the engine overheats

If your temperature gauge indicates overheating, you experience a loss of power, or hear a loud pinging or knocking, the engine will probably be too hot. You should:

1. Pull off the road and stop as soon as it is safe to do so.
2. Shift the gear to P (Park) and set the parking brake.
3. If the air conditioning is on, turn it off.
4. If engine coolant is leaking under the vehicle or steam is coming out from underneath the hood, stop the engine. Do not open the hood until the coolant has stopped leaking or the steaming has stopped.
5. If there is no visible loss of engine coolant and no steam, leave the engine running and check to be sure the engine cooling fan is operating.
 - 1) If the fan is not operating, turn the engine off.
6. Check to see if the water pump drive belt is missing.
 - 1) If it is not present, check to see that it is tight.
 - 2) If the drive belt seems to be satisfactory, check for coolant leaking from the radiator, hoses or under the vehicle. (If the air conditioning had been in use, it is normal for cold water to drain from it when you stop).

WARNING

Under the hood



While the engine is running, keep hair, hands and clothing away from moving parts, such as the fan and drive belts, to prevent injury.

7. If the water pump drive belt is broken or engine coolant is leaking out, stop the engine immediately and call an authorized Kia dealer.
8. If you cannot find the cause of the overheating, wait until the engine temperature has returned to normal. If coolant has been lost, carefully add coolant to the reservoir to bring the fluid level in the reservoir up to the halfway mark.
9. Proceed with caution, keeping alert for further signs of overheating. If overheating recurs, call an authorized Kia dealer.

WARNING

Coolant reservoir cap



Do not remove the engine coolant reservoir cap when the engine is hot. This may result in coolant being blown out of the opening and cause serious burns.

If the inverter coolant is running out, call the nearest a professional workshop for assistance. Have the vehicle inspected by an authorized Kia dealer.

Use of other coolant type or water may damage the inverter.

⚠ CAUTION

- Serious loss of coolant indicates there is a leak in the cooling system and this should be checked as soon as possible. Have your vehicle checked by an authorized Kia dealer.
- When the engine overheats from low engine coolant, suddenly adding engine coolant may cause cracks in the engine. To prevent damage, add engine coolant slowly in small quantities.

Tire Pressure Monitoring System (TPMS)

The TPMS detects the pressure of vehicle's tires and displays it on the LCD display.



- 1 Low tire pressure telltale/TPMS malfunction indicator
- 2 Low tire pressure position telltale (shown on the LCD display)

Tire Pressure Indicator

- You can check the tire pressure in the assist mode on the instrument cluster.
 - Refer to "Driving assist view" on page 5-90.
- Tire pressure is displayed for 1-2 minutes later after driving.
- If tire pressure is not displayed when the vehicle is stopped, "Drive to display" message displays. After driving, check the tire pressure.
- You can change the tire pressure unit in the user settings mode on the cluster.
 - psi, kPa, bar (Refer to "Utility information view" on page 5-90).

*** NOTICE**

- The tire pressure may change due to factors such as parking condition, driving style, and altitude above sea level.
- The tire pressure shown on the dashboard may differ from the tire pressure measured by tire pressure gauge.
- Low tire pressure warning may sound when a tire's pressure unit is equal or lower than nearby tires. This is a normal occurrence, due to the change in tire pressure along with tire temperature. This is a normal occurrence, due to the change in tire pressure along with tire temperature.

Effective use of TPMS**▲ WARNING**

Over-inflation or under-inflation can reduce tire life, adversely affect vehicle handling, and lead to sudden tire failure that may cause loss of vehicle control resulting in an accident

Each tire, including the spare (if provided), should be checked monthly when cold and inflated to the inflation pressure recommended by the vehicle manufacturer on the vehicle placard or tire inflation pressure label.

(If your vehicle has tires of a different size than the size indicated on the vehicle placard or tire inflation pressure label, you should determine the proper tire inflation pressure for those tires.)

As an added safety feature, your vehicle has been equipped with a tire pressure monitoring system (TPMS) that illuminates a low tire pressure telltale when one or more of your tires is significantly

under-inflated. Accordingly, when the low tire pressure telltale illuminates, you should stop and check your tires as soon as possible, and inflate them to the proper pressure. Driving on a significantly under-inflated tire causes the tire to overheat and can lead to tire failure. Under-inflation also reduces fuel efficiency and tire tread life, and may affect the vehicle's handling and stopping ability.

Please note that the TPMS is not a substitute for proper tire maintenance, and it is the driver's responsibility to maintain correct tire pressure, even if under-inflation has not reached the level to trigger illumination of the TPMS low tire pressure telltale.

Your vehicle has also been equipped with a TPMS malfunction indicator to indicate when the system is not operating properly. The TPMS malfunction indicator is combined with the low tire pressure telltale. When the system detects a malfunction, the telltale will flash for approximately one minute and then remain continuously illuminated. This sequence will continue upon subsequent vehicle start-ups as long as the malfunction exists. When the malfunction indicator is illuminated, the system may not be able to detect or signal low tire pressure as intended. TPMS malfunctions may occur for a variety of reasons, including the installation of replacement or alternate tires or wheels on the vehicle that prevent the TPMS from functioning properly.

Always check the TPMS malfunction telltale after replacing one or more tires or wheels on your vehicle to ensure that the replacement or alternate tires and wheels allow the TPMS to continue to function properly.

*** NOTICE**

If any of the below occurs, have the system checked by an authorized Kia dealer:

1. The low tire pressure telltale/TPMS malfunction indicator does not appear for 3 seconds when the ENGINE START/STOP button is turned to the ON position or engine is running.
2. The TPMS malfunction indicator remains illuminated after blinking for approximately 1 minute.
3. The Low tire pressure position telltale remains illuminated.

Low tire pressure telltale (!)

Low tire pressure position telltale

When the TPMS warning indicators appear, one or more of your tires are significantly under-inflated.

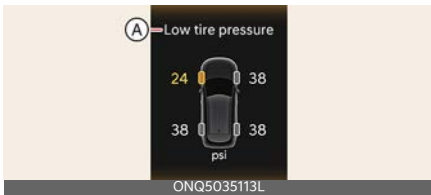

A: Low tire pressure

If the telltale appears, immediately reduce your speed, avoid hard cornering and anticipate increased stopping distances. Stop and check your tires as soon as possible.

Inflate the tires to the proper pressure as indicated on the vehicle's placard or tire inflation pressure label located on the driver's side center pillar outer panel. If you cannot reach a service station or if the tire cannot hold the newly added air, replace the underinflated tire with the spare tire.

Then the TPMS malfunction indicator and the Low Tire Pressure telltale may turn on and appear after restarting and about 20 minutes of continuous driving before the underinflated tire is repaired and replaced.

In winter or cold weather, the low tire pressure telltale may appear if the tire pressure was adjusted to the recommended tire inflation pressure in warm weather. It does not mean your TPMS is malfunctioning because the decreased temperature leads to a proportional lowering of tire pressure.

You should check the tire inflation pressure and adjust the tires to the recommended tire inflation pressure when driving your vehicle in the following conditions.

- from a warm area to a cold area
- from a cold area to a warm area
- the outside temperature is extremely high or low

When filling tires with more air, the low tire pressure telltale may not appear. This is because of its performance margin of error. The low tire pressure telltale will turn off when the tire pressure is above the recommended tire inflation pressure.

! WARNING

Low pressure damage

Do not drive on underinflated tires. Significantly low tire pressure can cause the tires to overheat and fail, causing instability, resulting in increased braking distances and a loss of vehicle control.

TPMS malfunction indicator

The low tire pressure telltale will appear after it blinks for approximately one minute when there is a problem with the TPMS.

If the system can correctly detect an underinflation warning at the same time as system failure, it will appear both the TPMS malfunction and the low tire pressure position telltales. (e.g., if the Front Left sensor fails, the TPMS malfunction indicator appears, but if the Front Right, Rear Left, or Rear Right tire is underinflated, the low tire pressure position telltales may appear together with the TPMS malfunction indicator).

Have the system checked by an authorized Kia dealer as soon as possible to determine the cause of the problem.

- The TPMS malfunction indicator may appear if the vehicle is moving around electric power supply cables or radios transmitters such as near police stations, government and public offices, broadcasting stations, military installations, airports, or transmitting towers, etc. These can interfere with normal operation of the TPMS.
- The TPMS malfunction indicator may appear if the vehicle is equipped with snow chains or some personal electronic devices (such as a laptop computer, mobile charger, remote starter or navigation) are being used. These can interfere with normal operation of the TPMS.

Tire replacement with TPMS

If you have a flat tire, the Low Tire Pressure telltale will come on. Have the flat tire repaired by an authorized Kia dealer as soon as possible or replace the flat tire with the spare tire.

CAUTION

Repair Agents

Never use a puncture-repairing agent not approved by Kia to repair and/or inflate a low pressure tire. Sealant that is not approved by Kia may damage the tire pressure sensor.

Each wheel is equipped with a tire pressure sensor mounted inside the tire behind the valve stem. You must use TPMS specific wheels. Always have your tires serviced by an authorized Kia dealer.

Even if you replace the low pressure tire with the spare tire, the Low Tire Pressure telltale will remain on until the low pressure tire is repaired and placed on the vehicle.

After you replace the low pressure tire with the spare tire, the TPMS malfunction indicator may appear after a few minutes because the TPMS sensor mounted on the spare tire may not initiate.

Once the low pressure tire is inflated to the recommended pressure and installed, or the TPMS sensor mounted on the replaced spare wheel is initiated by an authorized Kia dealer, the TPMS malfunction indicator and the low tire pressure telltale will turn off within a few minutes of driving.

If the indicator has not disappeared after a few minutes of driving, please visit an authorized Kia dealer.

If an original mounted tire is replaced with the spare tire, the TPMS sensor on the replaced spare wheel should be initiated and the TPMS sensor on the original mounted wheel should be deactivated. If the TPMS sensor on the original mounted wheel located in the

spare tire carrier still activates, the Tire Pressure Monitoring System may not operate properly. Have the tire with TPMS serviced or replaced by an authorized Kia dealer.

You may not be able to identify a low tire by simply looking at it. Always use a good quality tire pressure gauge to measure the inflation pressure. Please note that a tire that is hot (from being driven) will have a higher pressure measurement than a tire that is cold (from sitting stationary for at least 3 hours and driven less than 1 mile (1.6 km) during that 3-hour period).

Allow the tire to cool before measuring the inflation pressure. Always be sure the tire is cold before inflating to the recommended pressure.

A cold tire means the vehicle has been sitting for 3 hours and driven for less than 1 mile (1.6 km) in that 3-hour period.

Never use tire sealant if your vehicle is equipped with a TPMS. The liquid sealant can damage the tire pressure sensors.

- The TPMS cannot alert you to severe and sudden tire damage caused by external factors such as nails or road debris.
- If you feel any vehicle instability, immediately take your foot off the accelerator, apply the brakes gradually and lightly force, and slowly move to a safe position off the road.

*** NOTICE**

Protecting TPMS

Tampering with, modifying, or disabling the TPMS components may interfere with the system's ability to warn the driver of low tire pressure conditions and/or TPMS malfunctions. Tampering

with, modifying, or disabling the Tire Pressure Monitoring System (TPMS) components may void the warranty for that part of the vehicle.

This device complies with Part 15 of the FCC rules.

Operation is subject to the following three conditions:

1. This device may not cause harmful interference.
2. This device must accept any interference received, including interference that may cause undesired operation.
3. Changes or modifications not expressly approved by the party responsible for compliance could void the user's authority to operate the device.

If you have a flat tire (with spare tire) (if equipped)

If you have a flat tire, you can change the flat tire to a spare tire using tools.

⚠️ WARNING

Driving on a flat tire will cause permanent damage to the tire. Re-inflating a tire after it has been driven on while severely underinflated or flat may cause a blowout and a serious collision. Never attempt to re-inflate a tire that has been driven while severely underinflated or flat. Repair or replace the flat tire as soon as possible.

⚠️ WARNING

Changing a tire can be dangerous. Follow the instructions in this section when changing a tire to reduce the risk of serious injury or death.

⚠️ CAUTION

Be careful as you use the jack handle to stay clear of the flat end. The flat end has sharp edges that could cause cuts.

Jack and tools



The jack, jack handle and wheel lug nut wrench are stored in the luggage compartment.

Pull up the luggage compartment cover to reach this equipment.

1 Jack handle

2 Jack

3 Wheel lug nut wrench

4 Tool for removing wheel cover (if equipped)

Jacking instructions

The jack is provided for emergency tire changing only.

- To prevent the jack from "rattling" while the vehicle is in motion, store it properly.
- Follow jacking instructions to reduce the possibility of personal injury.

⚠️ WARNING

Changing tires

- Never attempt vehicle repairs in the traffic lanes of a public road or highway.
- Always move the vehicle completely off the road and onto the shoulder before trying to change a tire. The jack should be used on firm level ground. If you cannot find a firm level place off the road, call a towing service company for assistance.
- Be sure to use the correct front and rear jacking positions on the vehicle; never use the bumpers or any other part of the vehicle for jacking support.
- The vehicle can roll off the jack causing serious injury or death.
- Do not go under a vehicle that is supported by a jack.
- Do not start or run the engine while the vehicle is on the jack.
- Do not allow anyone to remain in the vehicle while it is on the jack.
- Make sure any children present are in a secure place, away from the road and from the vehicle to be raised with the jack.

⚠ WARNING

Tire jack

Do not place any portion of your body under a vehicle that is only supported by a jack since the vehicle can easily roll off the jack. Use vehicle support stands.

⚠ WARNING

Changing tires

Never attempt vehicle repairs in the traffic lanes of a public road or highway.

⚠ WARNING

Running vehicle on jack

Do not start or run the engine of the vehicle while the vehicle is on the jack as this may cause the vehicle to fall off the jack.

To prevent the jack from rattling while the vehicle is in motion, store it properly.

*** NOTICE**

Retreaded tires

Substantial design variations and the age of the retreaded tire casing can limit service life and have negative impact on road safety.

Removing and storing the spare tire

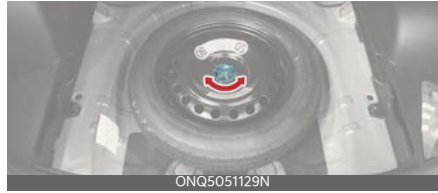

Your spare tire is stored in the cargo area.

- Turn the tire hold-down wing bolt counterclockwise to remove.
- Store the tire in the reverse order of removal.
- To prevent the spare tire and tools from "rattling" while the vehicle is in motion, store them properly.

⚠ WARNING

Touching surface of the luggage compartment floor

Do not touch the metal surface of the luggage compartment floor while the engine is operating or hot. This could result in serious bodily injury.

Turn the engine off and wait until it cools down or wear gloves to remove the spare tire from the luggage compartment.

If it is hard to loosen the tire hold-down wing bolt by hand, you can loosen it easily using the jack handle.



- Put the jack inside the tire hold-down wing bolt.

- Turn the tire hold-down wing bolt counterclockwise with the jack handle. Use caution when utilizing the sharp jack handle.

Changing tires

⚠️ WARNING

A vehicle can slip or roll off a jack causing serious injury or death to you or those nearby. Take the following safety precautions:

- Never place any portion of your body under a vehicle that is supported by a jack.
- NEVER attempt to change a tire in a traffic lane. ALWAYS move the vehicle completely off the road on level, firm ground away from traffic before trying to change a tire. If you cannot find a level, firm place off the road, call a towing service for assistance.
- Be sure to use the jack provided with the vehicle.
- ALWAYS place the jack on the designated jacking positions and NEVER on the bumpers or any other part of the vehicle for jacking support.
- Do not start or run the engine while the vehicle is on the jack.
- Do not allow anyone to remain in the vehicle while it is on the jack.
- Keep children away from the road and the vehicle.

1. Park on a firm level surface and apply the parking brake firmly.



2. Shift the gear to P (Park), apply the parking brake, and turn the engine OFF.
3. Activate the hazard warning flasher.
4. Remove the wheel lug nut wrench, jack, jack handle, and spare tire from the vehicle.
5. Block both the front and rear of wheel that is diagonally opposite the jack position.



⚠️ WARNING

Jack location

- To reduce the possibility of injury, be sure to only use the jack provided with the vehicle in the correct jack position; never use any other part of the vehicle for jack support.
- Never allow any part of a person's body under a vehicle that is being jacked or that is on a jack. Jacks can be unstable and can fall leading to serious injury or death.

⚠️ WARNING

Changing a tire

- To prevent vehicle movement while changing a tire, always set the parking brake fully and block the wheel diagonally, opposite the wheel being changed.

- We recommend that all wheels of the vehicle be blocked, and that no person remain in a vehicle that is being jacked.

6. Insert the tool (4, if equipped) into the hole and pull out the wheel cover.



*** NOTICE**

When removing the wheel cover, if you use any other tool except the tool provided, the wheel cover may be damaged.

7. Loosen the wheel lug nuts counter-clockwise one turn each, but do not remove any nut until the tire has been raised off the ground.



8. Place the jack at the front (1) or rear (2) jacking position closest to the tire you are changing. Place the jack at the designated locations under the frame. The jacking positions are plates welded to the frame with two tabs and a raised dot to index with the jack.



9. Insert the jack handle into the jack and turn it clockwise, raising the vehicle until the tire just clears the ground. This measurement is approximately 1.2 inches (30 mm). Before removing the wheel lug nuts, make sure the vehicle is stable and that there is no chance for movement or slippage.



10. Loosen the lug nuts and remove them with your fingers. Slide the wheel off the studs and lay it flat so it cannot roll away. To put the wheel on the hub, pick up the spare tire, line up the holes with the studs and slide the wheel onto them.

If this is difficult, tip the wheel slightly and get the top hole in the wheel lined up with the top stud. Then jiggle the wheel back and forth until the wheel can slide over the other studs.

11. To reinstall the wheel, hold it on the studs, put the lug nuts on the studs and finger tighten them. Jiggle the tire to be sure it is completely seated, then

tighten the nuts as much as possible with your fingers again.

12. Lower the vehicle to the ground by turning the jack handle counterclockwise.



Position the wrench as shown in the drawing and tighten the lug nuts. Be sure the socket is seated completely over the nut. Do not stand on the wrench handle or use an extension pipe over the wrench handle. Go around the wheel tightening every other nut until they are all tight. Then double-check each nut for tightness. After changing wheels, have the system checked by an authorized Kia dealer.

⚠ WARNING

Installing a wheel

- When you install a wheel, always remove any corrosion, dirt or foreign materials present on the mounting surfaces of the wheel or the surface of the wheel hub, brake drum or brake disc that contacts the wheel. Make sure to secure any fasteners that attach the rotor to the hub so they do not interfere with the mounting surfaces of the wheel. Installing wheels without correct metal-to-metal contact at the wheel mounting surfaces can cause the lug nuts to loosen and the wheel to come off while your vehicle is in motion. This can result in loss of vehicle control, personal injury or death.

- Make sure the wheel makes good contact with the hub when installed. If the contact of the mounting surface between the wheel and hub is not proper, the lug nuts could come loose and cause the loss of a wheel. Loss of a wheel may result in loss of control of the vehicle, serious injury or death.

Wheel nut tightening torque:

Steel wheel and aluminum alloy wheel:
79-94 lbf-ft (11-13 kgf-m)

If you have a tire gauge, remove the valve cap and check the air pressure. If the pressure is lower than recommended, drive slowly to the nearest service station and inflate to the correct pressure. If it is too high, adjust it until it is correct. Always reinstall the valve cap after checking or adjusting tire pressure. If the cap is not replaced, air may leak from the tire. If you lose a valve cap, buy another and install it as soon as possible. After you have changed wheels, always secure the flat tire in its place and return the jack and tools to their proper storage locations.

⚠ CAUTION

Reusing lug nuts

Make certain during wheel removal that the same nuts that were removed are reinstalled - or, if replaced, that nuts with metric threads and the same chamfer configuration are used. Your vehicle has metric threads on the wheel studs and nuts. Installation of a non-metric thread nut on a metric stud will not secure the wheel to the hub properly and will damage the stud so that it must be replaced.

Note that most lug nuts do not have metric threads. Be sure to use extreme care in checking for thread style before installing aftermarket lug nuts or wheels. If in doubt, consult an authorized Kia dealer.

⚠ WARNING

Wheel studs

If the studs are damaged, they may lose their ability to retain the wheel. This could lead to the loss of the wheel and a collision resulting in serious injuries.

⚠ WARNING

Never use oil or grease on bolts or nuts because the nuts might come loose. The vehicle's wheel could fall off, causing an accident.

Important - use of compact spare tire (if equipped)

Your vehicle is equipped with a compact spare tire. This compact spare tire takes up less space than a regular-sized tire. This tire is smaller than a conventional tire and is designed for temporary use only.

- You should drive carefully when the compact spare is in use. The compact spare should be replaced by the proper conventional tire and rim at the first opportunity.
- The compact spare tire is provided only to get you to the nearest tire store or repair facility. Do not drive on the compact spare longer than necessary. When driving on a compact spare, drive more slowly and carefully than usual. It may not corner the same as a full sized tire, and it may not be as durable. Failure to follow

these instructions can lead to an accident or to being stranded.

- The operation of this vehicle is not recommended with more than one compact spare tire in use at the same time.

⚠ WARNING

Spare tire

The compact spare tire is for emergency use only. Do not operate your vehicle on this compact spare at speeds over 50 mph (80 km/h). The original tire should be repaired or replaced as soon as possible to avoid failure of the spare, possibly leading to bodily injury or death.

The compact spare tire should be inflated to 60 psi (420 kPa).

*** NOTICE**

Check the inflation pressure after installing the spare tire. Adjust it to the specified pressure as necessary.

When using a compact spare tire, observe the following precautions:

- Do not exceed 50 mph (80 km/h); a higher speed could damage the tire.
- Ensure that you drive slowly enough for the road conditions to avoid all hazards. Any road hazard, such as a pothole or debris, could seriously damage the compact spare.
- Continuous road use of this tire could result in tire failure, loss of vehicle control, and possible personal injury.
- Do not exceed the vehicle's maximum load rating or the load-carrying capacity shown on the sidewall of the compact spare tire.
- Avoid driving over obstacles. The compact spare tire diameter is smaller

than the diameter of a conventional tire and reduces the ground clearance approximately 1 inch (25 mm), which could result in damage to the vehicle.

- Do not take this vehicle through an automatic car wash while the compact spare tire is installed.
- Do not use tire chains on the compact spare tire. Because of the smaller size, a tire chain will not fit properly. This could damage the vehicle and result in loss of the chain.
- Do not use the compact spare tire on any other vehicle because this tire has been designed especially for your vehicle.
- The compact spare tire's tread life is shorter than a regular tire. Inspect your compact spare tire regularly and replace worn compact spare tires with the same size and design, mounted on the same wheel.
- The compact spare tire should not be used on any other wheels, nor should standard tires, snow tires, wheel covers or trim rings be used with the compact spare wheel. Damage to these items or other vehicle components may occur.
- Do not use more than one compact spare tire at a time.
- Do not tow a trailer when the compact spare tire is installed.

Jack label

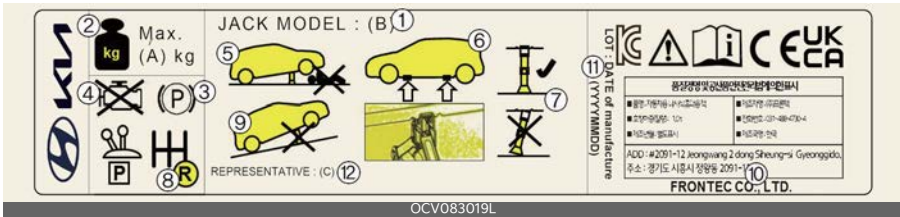

* The actual Jack label in the vehicle may differ from the illustration. For more detailed specifications, refer to the label attached to the jack.

- 1 Model Name
- 2 Maximum allowable load
- 3 When using the jack, set your parking brake.
- 4 When using the jack, stop the engine.
- 5 Do not get under a vehicle that is supported by a jack.
- 6 The designated locations under the frame
- 7 When supporting the vehicle, the baseplate of jack must be vertical under the lifting point.
- 8 Move the shift position to the P (Park) position on vehicles.
- 9 The jack should be used on firm level ground.
- 10 Jack manufacturer
- 11 Production date
- 12 Representative company and address

If you have a flat tire (with tire mobility kit (TMK)) (if equipped)

For safe operation, carefully read and follow the instructions in this manual before use.



- 1 Compressor
- 2 Sealant bottle

The TMK is a temporary fix to the tire. Have your vehicle inspected by an authorized Kia dealer.

CAUTION

One sealant for one tire

When two or more tires are flat, do not use the TMK because the sealant of TMK is used only for one flat tire.

WARNING

Do not use the TMK to repair punctures in the tire walls. This can result in an accident due to tire failure.

WARNING

Have your tire repaired as soon as possible. The tire may lose air pressure at any time after inflating with the TMK.

Introduction

With the TMK properly used, the vehicle can be operated even after experiencing a tire puncture.

The system of compressor and sealing compound effectively and comfortably seals most punctures (from nails or similar objects) and reinflates the tire.

After you ensured that the tire is properly sealed you can drive cautiously on the tire (distance up to 120 miles (200 km)) at a max. speed of 50 mph (80 km/h) in order to reach a service station or tire dealer to replace the tire.

It is possible that some tires, especially with larger punctures or damage to the sidewall, cannot be sealed completely.

Air pressure loss in the tire may adversely affect tire performance.

Avoid abrupt steering or other driving maneuvers, especially if the vehicle is heavily loaded or if a trailer is in use.

The TMK is not designed or intended as a permanent tire repair method and is to be used for one tire only. This instruction shows you step by step how to temporarily seal the puncture simply and reliably.

Read the section "Notes on the safe use of the TMK" on page 8-25.

WARNING

Do not use the TMK if a tire is severely damaged by driving run flat or with insufficient air pressure.

Only punctured areas located within the tread region of the tire can be sealed using the TMK.

Components of the Tire Mobility Kit

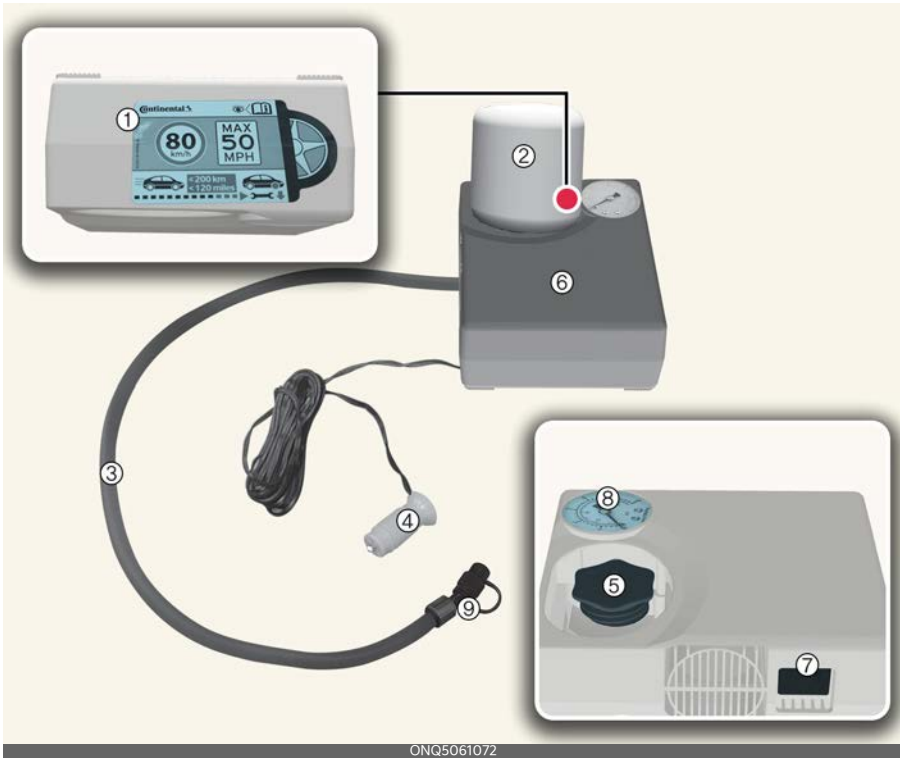

ONQ5061072

- 1 Speed-restriction label
- 2 Sealant bottle
- 3 Filling hose from sealant bottle to wheel
- 4 Connectors and cable for the power outlet direct connection
- 5 Holder for the sealant bottle
- 6 Compressor
- 7 ON/OFF switch
- 8 Pressure gauge for displaying the tire inflation pressure
- 9 Valve for reducing the tire inflation pressure

* Connectors, cable and connection hose are stored in the compressor housing.

* Strictly follow the specified sequence, otherwise the sealant may escape under high pressure.

⚠ WARNING

Expired sealant

Do not use the Tire sealant after the sealant has expired (i.e. past the expiration date on the sealant container). This can increase the risk of tire failure.

⚠ WARNING

Sealant

- Keep out of reach of children.
- Avoid contact with skin or eyes.
- Do not swallow.

Using the TMK

⚠ CAUTION

Detach the speed restriction label from the sealant bottle and place it in a highly visible place inside the vehicle such as on the steering wheel to remind the driver not to drive too fast.



1. Shake the sealant bottle.



2. Remove the cap of the sealant bottle and screw the connection hose onto the connector of the sealant bottle.



3. Ensure that valve on the compressor is locked.



4. Unscrew the valve cap from the valve of the defective tire and screw the filling hose of the sealant bottle onto the tire valve.



⚠ CAUTION

- Securely install the sealant filling hose on the valve. If not, sealant may flow backward, possibly clogging the filling hose.
- Do not connect another vehicle's TMK to the power outlet or battery terminal. The unmatched power requirement between the vehicle power outlet and the TMK can cause a fire or circuit damage to the vehicle and the TMK.

What to do in an emergency

5. Ensure that the compressor is switched off, position 0.
6. Connect the compressor and the vehicle power outlet using the cable and connectors.



7. Make sure the ENGINE START/STOP button position is on or ignition switch position is on.
8. Switch on the compressor and let it run for approximately 5-7 minutes to fill the sealant up to proper pressure. (refer to "Tires and wheels" on page 9-32). The inflation pressure of the tire after filling is unimportant and can be checked/corrected later. Be careful not to overinflate the tire and stay away from the tire when filling it. When the tire and wheel are damaged, do not use TMK.

⚠ WARNING

If the tire pressure is below 26psi (180kPa), do not drive the vehicle. The tire may cause an accident.

9. Switch off the compressor.
10. Detach the sealant filling hoses from the sealant bottle connector and the tire valve. After using, leave the sealant bottle and the compressor attached together.

Return the TMK to its storage location in the vehicle.

If you have a flat tire (with tire mobility kit (TMK))

⚠ WARNING

Carbon monoxide

Do not leave your vehicle running in a poorly ventilated area for extended periods of time. Carbon monoxide poisoning and suffocation can occur.

Distributing the sealant



- Immediately drive approximately 4-6 miles (7-10 km or, about 10 min) to evenly distribute the sealant in the tire.

⚠ CAUTION

Do not exceed a speed of 50 mph (80 km/h). If possible, do not fall below a speed of 12 mph (20 km/h).

While driving, if you experience any unusual vibration, ride disturbance or noise, reduce your speed and drive with caution until you can safely pull to the side of the road. Call for roadside service or towing.

When you use the TMK, the wheel may be stained by sealant. Remove the wheel stained by sealant and have the vehicle inspected at an authorized Kia dealer.

Checking the tire inflation pressure

1. After driving approximately 4-6 miles (7-10 km or about 10 min), stop at a safe location.

2. Connect the filling hose of the compressor directly to the tire valve.



3. Connect the compressor and the vehicle power outlet using the cable and connectors.
4. Adjust the tire inflation pressure to the recommended tire inflation.

With the ignition switch on, proceed as follows.

- To increase the inflation pressure: Switch on the compressor. To check the current inflation pressure setting, briefly switch off the compressor.
- To reduce the inflation pressure: Turn the valve on the compressor.

⚠ WARNING

Do not let the compressor run for more than 10 minutes. The device will overheat and may be damaged.

⚠ CAUTION

If the inflation pressure is not maintained, drive the vehicle a second time, refer to "Distributing the sealant" on page 8-24. Then repeat steps 1 to 4. Use of the TMK may be ineffectual for tire damage larger than approximately 0.16 inch (4 mm).

Please contact the nearest Kia dealership if the tire cannot be made roadworthy with the TMK.

⚠ WARNING

The inflation pressure must be at least 26 psi (180 kPa). If not, do not continue driving. Call for roadside service or towing.

*** NOTICE**

When reinstalling the repaired or replaced tire and wheel on the vehicle, tighten the wheel lug nut to 79-94 lbf·ft (11-13 kgf·m).

Notes on the safe use of the TMK

- Park your car at the side of the road so that you can work with the TMK away from moving traffic. Place your warning triangle in a prominent place to make passing vehicles aware of your location.
- To be sure your vehicle will not move, even when you're on level ground, always set your parking brake.
- Only use the TMK for sealing/inflation passenger car tires. Do not use on motorcycles, bicycles or any other type of tires.
- Do not remove any foreign objects—such as nails or screws—that have penetrated the tire.
- Before using the TMK, read the information printed on the sealant bottle.
- Provided the car is outdoors, leave the engine running. Otherwise, operating the compressor may drain the car battery.
- Never leave the TMK unattended while it is being used.
- Do not leave the compressor running for more than 10 min. at a time or it may overheat.

- Do not use the TMK if the ambient temperature is below -22 °F (-30 °C).
- When the tire and wheel are damaged, do not use TMK.

Technical Data

- System voltage: DC 12 V
 - Working voltage: DC 12 V
 - Amperage rating: max. 15 A
 - Suitable for use at temperatures: -22 to 158 °F (-30 to 70 °C)
 - Max. working pressure: 101 psi (7 bar)
 - Size
 - Compressor: 150 x 130 x 60 mm (5.9 x 5.1 x 2.4 in.)
 - Sealant bottle: 115.3 x 87.3 ø mm (4.5 x 3.4 ø in.)
 - Compressor weight: 620 g (1.36 lbs)
 - Sealant volume: 400 ml (24.4 cu. in.)
- * Sealant and spare parts can be obtained and replaced at an authorized vehicle or tire dealer. Empty sealant bottles may be disposed of at home. Liquid residue from the sealant should be disposed of by your vehicle or tire dealer or in accordance with local waste disposal regulations.

Towing

Towing service

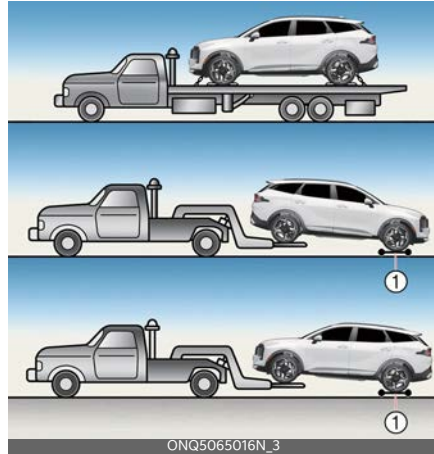

If towing is necessary, we recommend having it done by an authorized Kia dealer or a commercial tow-truck service.

Proper lifting and towing procedures are necessary to prevent damage to the vehicle. The use of wheel dollies (1) or a flatbed is recommended.

⚠ WARNING

Side and curtain air bags

If your vehicle is equipped with side and curtain air bag, set the vehicle to ACC position when the vehicle is being towed. The side and curtain air bag may deploy when the vehicle is in ON position and the rollover sensor detects the situation as a rollover.

⚠ CAUTION

The AWD vehicle should never be towed with the wheels on the ground. Always use wheel dollies or flatbed. If not, the transmission and the AWD system could be seriously damaged.

*** NOTICE**

- Shift to N (Neutral) to tow a vehicle with the tires on the ground. For more details, refer to "Stay in N (Neutral) position when engine is Off" on page 6-10.
- If the Electronic Parking Brake (EPB) does not release normally, take your vehicle to an authorized Kia dealer by loading the vehicle on a flatbed tow truck and have the system checked.

- Do not tow with sling-type equipment. Use wheel lift or flatbed equipment.



- Do not tow the vehicle backwards with the driven wheels on the ground as this may cause damage to the vehicle.



When flatbed is unavailable



2-wheel drive vehicle can be towed with the opposite tires on the ground (without dollies) and parking brake released before turning off the vehicle.

If you must tow the vehicle using only two wheels, lift the driven wheels off the ground and tow the vehicle.

⚠ CAUTION

- If any of the loaded wheels or suspension components are damaged or the vehicle is being towed with the driven wheels on the ground, use a towing dolly under the driven wheels.

Precautions for moving your vehicle a short distance with a tow hook to prepare for towing

When moving your vehicle for loading onto a towing truck or repositioning it for towing, drive at a speed of 3 mph (5 km/h) or less over a distance of 32 ft (10 m) or less.

In this situation, shift to N (Neutral) and disengage the parking brake. When the transmission or parking brake is not functioning, ensure that all wheels of your vehicle are elevated using a tow dolly or tire skates.

Emergency towing

Front



Rear



If towing is necessary, we recommend you have it done by an authorized Kia dealer or a commercial tow truck service.

If a towing service is not available in an emergency, your vehicle may be temporarily towed using a cable or chain secured to the emergency towing hook at the front (or rear) of the vehicle.

Use extreme caution when towing the vehicle with a cable or chain. A driver must be in the vehicle to steer it and operate the brakes.

Towing in this manner may be done only on hard-surfaced roads for a short distance and at low speeds. The wheels, axles, power train, steering and brakes must all be in good condition.

⚠ CAUTION

The driver must be in the vehicle for steering and braking operations when the vehicle is being towed. Passengers other than the driver must not be in the vehicle.

Always follow these emergency towing precautions:

- Place the ignition switch in the ACC position so the steering wheel is not locked.
- Place the shift button in N (Neutral).
- Release the parking brake.
- Depress the brake pedal with more force than normal as you will have reduced braking performance.
- More steering effort will be required because the power steering system will be disabled.
- Use a vehicle heavier than your own to tow your vehicle.
- The drivers of both vehicles should communicate with each other frequently.
- Before emergency towing, check that the hook is not broken or damaged.
- Fasten the towing cable or chain securely to the hook.
- Do not jerk the hook. Apply steady and even force.

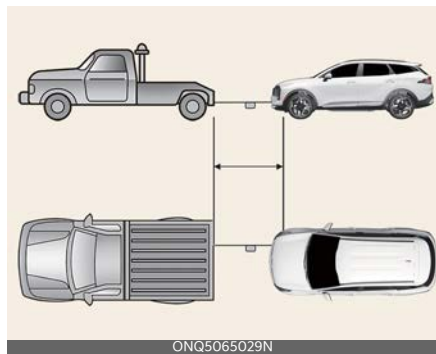

- Use a towing cable or chain less than 16 feet (5 m) long. Attach a white or red cloth (about 12 inches (30 cm) wide) in the middle of the cable or chain for easy visibility.

- Drive carefully so the towing cable or chain remains tight during towing.
- Before towing, check the automatic transmission for fluid leaks under your vehicle. If fluid is leaking, flatbed equipment or a towing dolly must be used.

*** NOTICE**

- Accelerate or decelerate the vehicle in a slow and gradual manner while maintaining tension on the tow-rope or chain to start or drive the vehicle. Tow hooks and the vehicle may be damaged.
 - To avoid damage to your vehicle and vehicle components when towing:
 - Always pull straight ahead when using the towing hooks. Do not pull from the side or at a vertical angle.
 - Do not use the towing hooks to pull a vehicle out of mud, sand or other conditions from which the vehicle cannot be driven out under its own power.
 - Limit the vehicle speed to 10 mph (15 km/h) and drive less than 1 mile (1.5 km) when towing to avoid serious damage to the automatic transmission.
-

Engine compartment	9-4
Maintenance services	9-5
Owner maintenance	9-6
• Owner maintenance schedule	9-6
Scheduled maintenance service	9-8
• Scheduled maintenance service precaution	9-8
Explanation of scheduled maintenance items	9-13
• Engine oil and filter	9-13
• Hybrid Starter & Generator (HSG) belt.....	9-13
• Fuel filter	9-13
• Fuel lines, fuel hoses and connections.....	9-13
• Vapor hose and fuel filler cap	9-13
• Vacuum crankcase ventilation hoses.....	9-13
• Air cleaner filter.....	9-13
• Spark plugs.....	9-13
• Cooling system.....	9-14
• Coolant.....	9-14
• Automatic transmission (AT) fluid	9-14
• Brake hoses and lines	9-14
• Brake fluid	9-14
• Exhaust pipe and muffler.....	9-14
• Brake discs, pads and calipers.....	9-14
• Suspension mounting bolts	9-14
• Steering gear box, linkage & boots/lower arm ball joint.....	9-14
• Drive shafts and boots.....	9-14
• Air conditioning refrigerant	9-14
• Propeller shaft	9-15
• Checking fluid levels.....	9-15
Engine oil	9-15
• Checking the engine oil level.....	9-15
• Changing the engine oil and filter	9-16

9 Maintenance

Coolant	9-17
• Checking the engine coolant level	9-17
• Checking the inverter coolant level (HEV).....	9-19
• Checking the inverter coolant level (PHEV).....	9-20
Hybrid starter & generator (HSG) belt	9-21
• Checking the HSG belt	9-21
Brake fluid	9-21
• Checking the brake fluid level.....	9-21
Washer fluid	9-22
• Checking the washer fluid level	9-22
Air cleaner filter	9-23
• Replacing air cleaner filter	9-23
Climate control air filter	9-24
• Filter inspection	9-24
Wiper blades	9-25
• Blade inspection	9-25
• Blade replacement	9-26
Battery	9-28
• Plug-in hybrid vehicle	9-28
• Hybrid vehicle.....	9-30
• Reset items	9-31
Tires and wheels	9-32
• Checking tire inflation pressure	9-33
• Tire rotation.....	9-34
• Wheel alignment and tire balance	9-35
• Wheel and tire installation	9-35
• Tire replacement	9-36
• Wheel replacement	9-36
• Tire traction	9-37
• Tire maintenance	9-37

• Tire sidewall labeling	9-37
• Tire terminology and definitions	9-40
• All-season tires	9-43
• Summer tires	9-43
• Snow tires	9-43
• Tire chains	9-44
• Radial-ply tires	9-44
Fuses	9-45
• Inner panel fuse replacement	9-47
• Engine compartment fuse replacement	9-48
• Fuse/relay panel description	9-48
Light bulbs	9-56
• Bulb replacement precaution	9-56
• Light bulb position (Front)	9-57
• Light bulb position (Rear)	9-57
• Light bulb position (Side)	9-58
• Replacing lights (LED type)	9-58
• Replacing high mounted stop lamp (LED type)	9-58
• Replacing license plate lamp (Bulb type)	9-58
• Replacing map lamp (Bulb type)	9-58
• Replacing room lamp (Bulb type)	9-59
• Replacing vanity mirror lamp (Bulb type)	9-59
• Replacing glove box lamp (Bulb type)	9-60
• Replacing luggage lamp (Bulb type)	9-60
Appearance care	9-61
• Exterior care	9-61
• Interior care	9-65
Emission control system	9-67
• Procedure for entering forced engine activation mode	9-69
California perchlorate notice	9-70

Maintenance

Engine compartment

Smartstream G1.6 T-GDi HEV

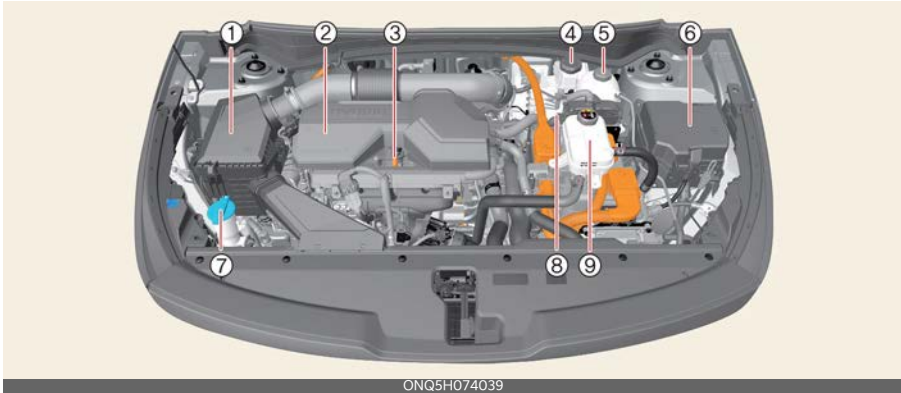

ONQ5H074039

Smartstream G1.6 T-GDi PHEV

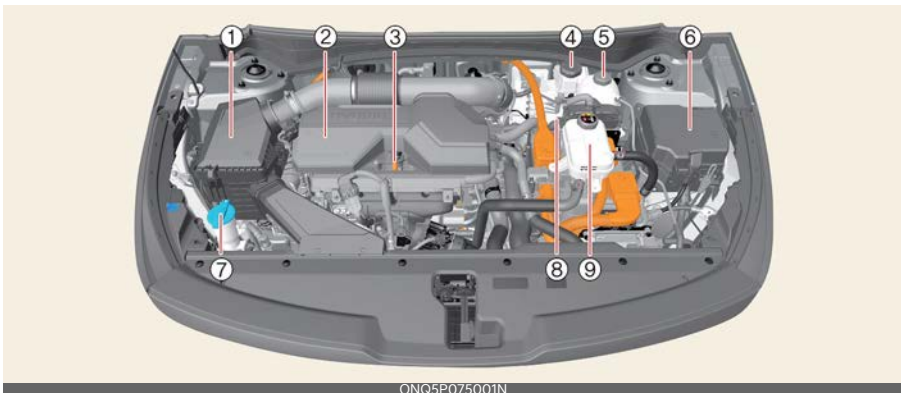

ONQ5P075001N

* The actual engine compartment in your Kia may differ from the illustration.

- 1 Air cleaner
- 2 Engine oil filler cap
- 3 Engine oil dipstick
- 4 Brake fluid reservoir
- 5 Engine coolant reservoir
- 6 Fuse box
- 7 Windshield washer fluid reservoir
- 8 Electric Control Unit (ECU)
- 9 Inverter coolant reservoir

Maintenance services

Exercise care to prevent damage to your vehicle and injury to yourself whenever performing any maintenance or inspection procedures.

Should you have any doubts concerning the inspection or servicing of your vehicle, have an authorized Kia dealer perform this work.

An authorized Kia dealer has factory-trained technicians and genuine Kia parts to service your vehicle properly. For expert advice and quality service, see an authorized Kia dealer.

Inadequate, incomplete or insufficient servicing may result in operational problems with your vehicle that could lead to vehicle damage, an accident, or personal injury.

Owner's responsibility

* NOTICE

Maintenance Service and Record Retention are the owner's responsibility.

You should retain documents that show proper maintenance has been performed on your vehicle in accordance with the scheduled maintenance service charts shown on the following pages. You need this information to establish your compliance with the servicing and maintenance requirements of your vehicle warranties.

Detailed warranty information is provided in your Warranty & Consumer Information manual.

Repairs and adjustments required because of improper maintenance, or a lack of required maintenance are not covered.

Have your vehicle maintained and repaired by an authorized Kia dealer. Authorized Kia dealers meet Kia's high service quality standards and receive technical support from Kia to provide you with a high level of service satisfaction.

* NOTICE

NHTSA Safety Corrosion Alert

The National Highway Traffic Safety Administration (NHTSA) has issued a general warning to all vehicle owners of all brands regarding the risks associated with vehicle underbody corrosion. From your initial purchase, take the following steps to prevent unsafe corrosion damage to your vehicle:

- Wash the undercarriage of your vehicle regularly during the winter and whenever your vehicle has been exposed to such salts or chemicals.
- Do a thorough washing of the undercarriage at the end of the winter.
- Use professional service technicians or governmental inspection stations to annually inspect for corrosion.
- Immediately seek an inspection of your vehicle if you notice corrosion, flaking, scaling or changes in vehicle performance, such as soft or spongy brakes, fluids leaking, impairment of directional control, suspension noises or rattling metal straps.
- NHTSA further advises that after a vehicle is 7 years old, it is essential that you take these indicated maintenance steps to ensure that you protect yourself from unsafe corrosion conditions.

Owner maintenance precautions

Improper or incomplete service may result in problems. This section gives instructions only for the maintenance items that are easy to perform.

As explained earlier in this section, several procedures can be done only by an authorized Kia dealer with special tools.

* NOTICE

Improper owner maintenance during the warranty period may affect warranty coverage. For details, read the separate Warranty & Consumer Information manual provided with the vehicle. If you're unsure about any servicing or maintenance procedure, have it done by an authorized Kia dealer.

⚠ WARNING

Maintenance work

Do not wear jewelry or loose clothing while working under the hood of your vehicle with the engine running. These items can become entangled in moving parts, if you must run the engine while working under the hood, make certain that you remove all jewelry (especially rings, bracelets, watches, and necklaces) and all neckties, scarves, and similar loose clothing before getting near cooling fans.

⚠ WARNING

Touching metal parts

Do not touch metal parts (including strut bars) while the vehicle is operating or hot. Doing so could result in serious bodily injury. Turn the vehicle off and wait until the metal parts cool down to perform maintenance work on the vehicle.

Owner maintenance

The following lists are vehicle checks and inspections that should be performed by the owner or an authorized Kia dealer at the frequencies indicated to help ensure safe, dependable operation of your vehicle.

Any adverse conditions should be brought to the attention of your dealer as soon as possible.

These owner maintenance checks are generally not covered by your warranty and you may be charged for labor, parts and lubricants used.

Owner maintenance schedule

When you stop for fuel:

- Check the coolant level in coolant reservoir.
- Check the windshield washer fluid level.
- Look for low or under-inflated tires.
- Check if the front of the radiator and condenser are clean and not blocked with leaves, dirt or insects etc. If any of these parts are dirty or you are not sure of their condition, take your vehicle to an authorized Kia dealer.

⚠ WARNING

Hot coolant



Be careful when checking your engine coolant level when the engine is hot. Scalding hot coolant and steam may blow out under pressure.

While operating your vehicle:

- Note any changes in the sound of the exhaust or any smell of exhaust fumes in the vehicle.
- Check for vibrations in the steering wheel. Notice any increased steering effort or looseness in the steering wheel or change in its straight-ahead position.
- Notice if your vehicle constantly turns slightly or "pulls" to one side when traveling on smooth, level road.
- When stopping, listen and check for unusual sounds, pulling to one side, increased brake pedal travel or "hard-to-push" brake pedal.
- If any slipping or changes in the operation of your transmission occurs, take your vehicle to an authorized Kia dealer.
- Check the P (Park) function.
- Check the parking brake.
- Check for fluid leaks under your vehicle (water dripping from the air conditioning system during or after use is normal).

At least monthly:

- Check the coolant level in the coolant reservoir.
- Check the operation of all exterior lights, including the stoplights, turn signals and hazard warning flashers.
- Check the inflation pressures of all tires including the spare (if provided) for tires that are worn, show uneven wear, or are damaged.
- Check for loose wheel lug nuts.

At least once every 6 months:

- Check the radiator, heater and air conditioning hoses for leaks or damage.
- Check the windshield washer spray and wiper operation. Clean the wiper blades with a clean cloth dampened with washer fluid.
- Check the headlamp alignment.
- Check the muffler, exhaust pipes, shields and clamps.
- Check the lap/shoulder belts for wear and function.

At least once a year:

- Clean the body and door drain holes.
- Lubricate the door hinges and check the hood hinges.
- Lubricate the door, hood locks and latches.
- Lubricate the door rubber weatherstrips.
- Check the air conditioning system.
- Inspect and lubricate transmission linkage and controls.
- Clean the battery and terminals.
- Check the brake fluid level.
- Visually inspect steering, suspension, and chassis components for damaged, loose, or missing parts or signs of wear.

Scheduled maintenance service

Scheduled maintenance service precaution

Follow the Normal Maintenance Schedule if the vehicle is usually operated when none of the following conditions apply. If any of the following conditions apply, follow the Maintenance Under Severe Usage Conditions.

- Repeated driving short distance of less than 5 miles (8 km) in normal temperature or less than 10 miles (16 km) in freezing temperature
- Extensive engine idling or low speed driving for long distances
- Driving on rough, dusty, muddy, unpaved, graveled or salt-spread roads
- Driving in areas using salt or other corrosive materials or in very cold weather
- Driving in heavy dust condition
- Driving in heavy traffic area
- Driving on uphill, downhill, or mountain road repeatedly
- Using for towing or camping and driving with loading on the roof
- Driving as a patrol car, taxi, other commercial use of vehicle towing
- Frequently driving at high speeds or with rapid acceleration/deceleration.
- Frequently driving in stop-and-go conditions

If your vehicle is operated in any of the prior listed conditions, you should inspect, replace or refill more frequently, using the severe usage maintenance schedule instead of the normal usage maintenance schedule.

* NOTICE

Your vehicle may be equipped with the Oil Life Management System that predicts engine oil life based on the driver's driving history and alerts the driver to change engine oil.

- If the deterioration of the engine oil increases depending on the driver's driving severity, the remaining oil life alert appears on the instrument cluster before the normal engine oil replacement interval. Have the engine oil and filter be changed by an authorized Kia dealer.
- Oil Life Management System works when the recommended engine oil is used. So, if recommended engine oil is not used, replace the engine oil according to the maintenance schedule under severe usage condition. Check the amount of engine oil regularly as this system assumes that the engine oil is being filled normally.
- Always reset the remaining engine oil life whenever the engine oil is changed. Otherwise, the Oil Life Management System will not be correct.
- If there is no alert until the maximum maintenance interval, have vehicle be checked by an authorized Kia dealer.

* NOTICE

After 10 years or 100,000 miles (150,000 km), we recommend using severe maintenance schedule.

Normal maintenance schedule

The following maintenance services must be performed to ensure good emission control and performance. Keep receipts for all vehicle services to protect your warranty. Where both mileage and date are shown, the frequency of service is determined by whichever occurs first.

I: Inspect and adjust, correct, clean, or replace if necessary.
 R: Replace or change.

Number of months or driving distance, whichever comes first												
Months	12	24	36	48	60	72	84	96	108	120	132	144
Miles x 1,000	8	16	24	32	40	48	56	64	72	80	88	96
Km x 1,000	13	26	39	52	65	78	91	104	117	130	143	156
Rotate Tires (Includes tread wear inspection and tire pressure check)		Rotate every 8,000 miles (13,000 km) or 12 months										
Fuel additives ¹		Add every 8,000 miles (13,000 km) or 12 months										
Engine oil and engine oil filter ²	Smartstream G1.6 T-GDi HEV/PHEV	R	R	R	R	R	R	R	R	R	R	R
Climate control air filter		I	R	I	R	I	R	I	R	I	R	I
Air cleaner filter (Engine)		I	I	R	I	I	R	I	I	R	I	I
Brake fluid		Inspect every 8,000 miles (13,000 km) or 12 months Replace every 48,000 miles (78,000 km) or 48 months										
Spark plugs	Smartstream G1.6 T-GDi HEV/PHEV	Replace every 48,000 miles (78,000 km)										
Coolant (Engine) ³		At first, replace at 120,000 miles (195,000 km) or 120 months After that, replace every 24,000 miles (39,000 km) or 24 months										
Coolant (Inverter)	HEV ⁴	At first, replace at 120,000 miles (195,000 km) or 120 months After that, replace every 24,000 miles (39,000 km) or 24 months										
	PHEV ⁵	Replace every 32,000 miles (52,000 km) or 36 months										
Air conditioner refrigerant												
Air conditioner compressor												
12V Battery condition	PHEV											
Brake discs and pads												
Brake lines, hoses and connections		I	I	I	I	I	I	I	I	I	I	I
Suspension ball joints												
Steering gear rack, linkage and boots												
Exhaust system												
Cooling system												
Intercooler in/out hose, air intake hose	Smartstream G1.6 T-GDi HEV/PHEV	I	-	I	-	I	-	I	-	I	-	I
Drive shaft and boots												
Propeller shaft (AWD)												
Fuel tank and fuel cap		-	I	-	I	-	I	-	I	-	I	-
Fuel tank air filter												
Fuel lines, hoses and connections												

Number of months or driving distance, whichever comes first												
Months	12	24	36	48	60	72	84	96	108	120	132	144
Miles x 1,000	8	16	24	32	40	48	56	64	72	80	88	96
Km x 1,000	13	26	39	52	65	78	91	104	117	130	143	156
HSG (Hybrid Starter & Generator) belt ⁶		Inspect every 8,000 miles (13,000 km) or 12 months Replace every 64,000 miles (104,000 km) or 48 months										
Differential oil (rear) (AWD) ⁷		Inspect every 40,000 miles (65,000 km) or 48 months										
Transfer case oil (AWD) ⁸												
Automatic transmission (AT) fluid*	Smartstream G1.6 T-GDi HEV/PHEV	No service required										

*1. Fuel additives

If TOP TIER Detergent Gasoline is not available, one bottle of additive is recommended. Additives are available from your authorized Kia dealer along with information on how to use them. Do not mix other additives.

*2. Engine oil and engine oil filter

It is normal for engine oil to be consumed during driving. Check your engine oil level regularly.

The engine oil change interval for normal operating conditions is based on the use of the recommended engine specification. If the recommended engine oil specification is not used, then replace the engine oil according to the maintenance schedule for severe operating conditions.

Never add any additives to the engine oil. Engine oil additives can change its properties of engine oil and may cause serious engine failure.

*3. Coolant (Engine)

When adding coolant, use only deionized water or soft water for your vehicle and never mix hard water in the coolant filled at the factory. An improper coolant mixture can result in serious malfunction or engine damage.

*4. Coolant (HEV Inverter)

When adding coolant, use only deionized water or soft water for your vehicle and never mix hard water in the coolant filled at the factory. An improper coolant mixture can result in serious malfunction or engine damage.

*5. Coolant (PHEV Inverter)

Have the coolant replaced by an authorized Kia dealer.

*6.HSG (Hybrid Starter & Generator) belt

Inspect HSG belt for evidence of cuts, cracks, excessive wear or oil saturation and replace if necessary.

*7. Differential oil (rear) (AWD)

If the vehicle has been submerged in water or in a flooded area, the fluids should be changed as a precaution.

*8. Transfer case oil (AWD)

If the vehicle has been submerged in water or in a flooded area, the fluids should be changed as a precaution.

* Transmission fluid

If the vehicle has been submerged in water or in a flooded area, the fluids should be changed as a precaution.

Fuel filter (Gasoline engine)

The fuel filter is normally maintenance free but periodic inspection is recommended during scheduled maintenance to look for conditions caused by poor fuel quality.

- If there are safety risks such as fuel flow restriction, surging, loss of power, hard starting problem etc., replace the fuel filter immediately regardless of maintenance schedule and consult an authorized Kia dealer for details.

Maintenance under severe usage conditions

I: Inspect and if necessary, adjust, correct, clean or replace.

R: Replace or change.

Maintenance item	Maintenance operation	Maintenance intervals	Driving condition
Engine oil and engine oil filter	R	Every 5,000 miles (8,000 km) or 6 months	D, H, I
HSG (Hybrid Starter & Generator) belt	R	Every 30,000 miles (48,000 km) or 24 months	B, C, D, E, I, K
	I	Every 5,000 miles (8,000 km) or 6 months	
Spark plugs	R	More frequently	A, B, F, G, H, I, K
Air cleaner filter	R	More frequently	C, E
Climate control air filter	R	More frequently	C, E, G
Automatic transmission (AT) fluid	R	Every 56,000 miles (91,000 km)	A, C, F, G, H, I, J, K
Differential oil (rear) (AWD)	R	Every 72,000 miles (117,000 km)	C, E, G, H, I, J
Transfer case oil (AWD)	R	Every 72,000 miles (117,000 km)	C, E, G, H, I, J
Steering gear rack, linkage and boots	I	More frequently	C, D, E, F, G, H, I
Suspension ball joints	I	More frequently	C, D, E, G, H, I
Brake discs, pads and calipers	I	More frequently	C, D, E, G, H, I, J, K
Drive shaft and boots	I	More frequently	C, D, E, F, G, H, I, J
Propeller shaft (AWD)	I	More frequently	C, D, E, F, G, H, I, J

Severe driving conditions

A: Repeatedly driving short distance of less than 5 miles (8 km) in normal temperature or less than 10 miles (16 km) in freezing temperature.

B: Extensive engine idling or low speed driving for long distances.

C: Driving on rough, dusty, muddy, unpaved, graveled, or salt-spread roads

D: Driving in areas using salt or other corrosive materials or in very cold weather

E: Driving in heavy dust condition.

F: Driving in heavy traffic

G: Driving on uphill, downhill, or mountain roads repeatedly.

H: Towing a trailer or using a camper, or driving with loads on the roof

I: Driving as a patrol car, taxi, towing vehicle, or other commercial use

J: Frequently driving at high speeds or rapid acceleration/deceleration

K: Frequently driving in stop-and-go traffic

Explanation of scheduled maintenance items

Engine oil and filter

The engine oil and filter should be changed at the intervals specified in the maintenance schedule. If the vehicle is being driven in severe conditions, more frequent oil and filter changes are required.

Hybrid Starter & Generator (HSG) belt

Inspect HSG belt for evidence of cuts, cracks, excessive wear or oil saturation and replace if necessary.

CAUTION

When you are inspecting the belt, place the ignition switch or ENGINE START/STOP button in the LOCK/OFF or ACC position.

Fuel filter

The fuel filter is maintenance free but periodic inspection is recommended for this maintenance schedule depends on fuel quality.

If there are some important safety matters like fuel flow restriction, surging, loss of power, hard starting problem etc., replace the fuel filter immediately regardless of maintenance schedule and consult an authorized Kia dealer for details.

Fuel lines, fuel hoses and connections

Check the fuel lines, fuel hoses and connections for leakage and damage. Have the fuel lines, fuel hoses and connections replaced by an authorized Kia dealer.

Vapor hose and fuel filler cap

The vapor hose and fuel filler cap should be inspected at those intervals specified in the maintenance schedule. Make sure that a new vapor hose or fuel filler cap is correctly replaced.

Vacuum crankcase ventilation hoses

Inspect the surface of hoses for evidence of heat and/or mechanical damage. Hard and brittle rubber, cracking, tears, cuts, abrasions, and excessive swelling indicate deterioration. Particular attention should be paid to examine those hose surfaces nearest to high heat sources, such as the exhaust manifold.

Inspect the hose routing to assure that the hoses do not contact any heat source, sharp edges or moving component which might cause heat damage or mechanical wear. Inspect all hose connections, such as clamps and couplings, to make sure they are secure, and that no leaks are present. Hoses should be replaced immediately if there is any evidence of deterioration or damage.

Air cleaner filter

Have the air cleaner filter replaced by an authorized Kia dealer.

Spark plugs

Make sure to install new spark plugs of the correct heat range.

When assembling parts, be sure to wipe the inside and outside of the boot bottom of the ignition coil and the insulator of the spark plug with a soft cloth to prevent contamination of the spark plug insulator.

⚠ WARNING

Do not disconnect and inspect spark plugs when the engine is hot. You may burn yourself.

Cooling system

Check the cooling system components, such as the radiator, coolant reservoir, hoses and connections for leakage and damage. Replace any damaged parts.

Coolant

The coolant should be changed at the intervals specified in the maintenance schedule.

Automatic transmission (AT) fluid

AT fluid should not be checked under normal usage conditions. Have the AT fluid changed by an authorized Kia dealer.

*** NOTICE**

AT fluid color is basically red.

As the vehicle is driven, the AT fluid will begin to look darker. It is normal condition and you should not need to replace the fluid based upon the changed color.

⚠ CAUTION

The use of a non-specified fluid could result in transmission malfunction and failure.

Use only specified AT fluid. (Refer to "Recommended lubricants and capacities" on page 10-6.)

Brake hoses and lines

Visually check for improper installation, chafing, cracks, deterioration or leakage. Replace any deteriorated or damaged parts immediately.

Brake fluid

Check the brake fluid level in the brake fluid reservoir. The level should be between "MIN" and "MAX" marks on the side of the reservoir. Use only hydraulic brake fluid conforming to DOT 4 specification.

Exhaust pipe and muffler

Visually inspect the exhaust pipes, muffler and hangers for cracks, deterioration, or damage. Start the engine and listen carefully for any exhaust gas leakage. Tighten connections or replace parts as necessary.

Brake discs, pads and calipers

Check the pads for excessive wear, discs for run out and wear, and calipers for fluid leakage.

Suspension mounting bolts

Check the suspension connections for looseness or damage. Retighten to the specified torque.

Steering gear box, linkage & boots/lower arm ball joint

With the vehicle stopped and engine off, check for excessive free play in the steering wheel.

Check the linkage for bends or damage. Check the dust boots and ball joints for deterioration, cracks, or damage. Replace any damaged parts.

Drive shafts and boots

Check the drive shafts, boots and clamps for cracks, deterioration, or damage. Replace any damaged parts and, if necessary, repack the grease.

Air conditioning refrigerant

Check the air conditioning lines and connections for leakage and damage.

Propeller shaft (if equipped)

Check the propeller shaft, boots, clamps, rubber coupling and center bearing rubber for cracks, deterioration, or damage. Replace any damaged parts and if necessary, repack the grease.

Checking fluid levels

When checking engine oil, engine coolant, brake fluid, and washer fluid, always be sure to clean the area around any filler plug, drain plug, or dipstick before checking or draining any lubricant or fluid. This is especially important in dusty or sandy areas and when the vehicle is used on unpaved roads. Cleaning the plug and dipstick areas will prevent dirt and grit from entering the engine and other mechanisms that could be damaged.

Engine oil

Checking the engine oil level

Engine oil is used for lubricating, cooling, and operating various hydraulic components in the engine. Engine oil consumption while driving is normal, and it is necessary to check and refill the engine oil regularly. Also, check and refill the oil level within the recommended maintenance schedule to prevent deterioration of oil performance.

Check the engine oil following the below procedure.

Smartstream G1.6 T-GDi HEV/PHEV



1. Be sure the vehicle is on level ground.
2. Start the engine and allow it to reach normal operating temperature.
3. Turn the engine off, remove the oil filler cap and pull the dipstick out. Wait for 15 minutes for the oil to return to the oil pan.
4. Wipe the dipstick clean and reinsert it fully.
5. Pull the dipstick out again and check the level. Check if the oil level is between the F-L line, and if it is below the L line, add enough oil to bring the level to F line.

⚠ WARNING**Radiator hose**

Be very careful not to touch the radiator hose when checking or adding the engine oil as it may be hot enough to burn you.

⚠ CAUTION

When you wipe the oil level gauge, you should wipe it with a clean cloth. When mixed with debris, it can cause engine damage.

Smartstream G1.6 T-GDi HEV/PHEV

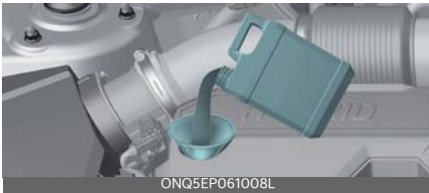

ONQ5EP061008L

Use a funnel to help prevent oil from being spilled on engine components.

Use only the specified engine oil. (Refer to "Recommended lubricants and capacities" on page 10-6.)

- Do not spill engine oil when adding or changing engine oil. Wipe off spilled oil immediately.
- The engine oil consumption may increase while you break in a new vehicle and it will be stabilized after driving 4,000 miles (6,000 km).
- The engine oil consumption can be affected by driving habits, climate conditions, traffic conditions, oil quality, etc. Therefore, it is recommended that you inspect the engine oil level regularly and refill it if necessary.

Changing the engine oil and filter

The lubrication, rust prevention, cooling, and cleaning effect of the engine oil will gradually degrade during its use. Have the engine oil and filter changed by an authorized Kia dealer according to the Engine Oil Life Management System instructions or the maintenance schedule.

- If the maintenance schedule to replace engine oil is exceeded, the engine oil performance may deteriorate, and the engine condition may be affected. Therefore, replace the engine oil according to the maintenance schedule.
- To keep the engine in optimal condition, use the recommended engine oil and filter. If the recommended engine oil and filter are not used, replace them according to the maintenance schedule under severe usage conditions.
- The purpose of the maintenance schedule for engine oil replacement is to prevent oil deterioration and it is irrelevant to oil consumption. Check and refill engine oil regularly.

⚠ WARNING**Used engine oil**

Used engine oil may cause irritation or cancer of the skin if left in contact with the skin for prolonged periods of time. Used engine oil contains chemicals that have caused cancer in laboratory animals. Always protect your skin by washing your hands thoroughly with soap and warm water as soon as possible after handling used oil. Do not leave used engine oil within the reach of children.

* NOTICE

- If the oil pressure is low due to insufficient engine oil, the Engine Oil Pressure (🛢️) warning light will appear. The enhanced engine protection system that limits the engine's power is activated and the Malfunction Indicator Lamp (🚗) appears. After sufficient engine oil is added, the Engine Oil Pressure warning light turns off and the engine power is no longer limited.
- When the engine oil pressure is restored, the warning light and the enhanced engine protection system turn off after the engine is restarted.

⚠️ CAUTION

Engine oil is very hot immediately after the vehicle has been driven and can cause burns during replacement. Replace the engine oil only after the engine oil has cooled down.

* NOTICE

Never add any additives to the engine oil. Engine oil additives can change its properties of engine oil and may cause serious engine failure.

Coolant

The high pressure cooling system has a reservoir filled with year round anti-freeze coolant. The reservoir is filled at the factory.

Check the antifreeze protection and coolant level at least once a year, at the beginning of winter, and before traveling to a colder climate.

Checking the engine coolant level

When adding coolant, use only deionized water, distilled water or soft water for your vehicle and never mix hard water in the coolant filled at the factory.

- An incorrect coolant mixture can result in severe malfunction or engine/hybrid system damage.
- The engine in your vehicle has aluminum engine parts and must be protected by a phosphate based ethylene glycol coolant to prevent corrosion and freezing.
- Do not use alcohol or methanol coolant or mix them with the specified coolant.
- Do not use a solution that contains more than 60% antifreeze or less than 35% antifreeze, which would reduce the effectiveness of the solution.



⚠️ WARNING

Make sure the engine coolant reservoir cap is properly closed after refill or coolant.

The engine could be overheated while driving.

1. Check if the engine coolant reservoir cap label is straight in front.



2. Make sure that the tiny protrusions inside the engine coolant reservoir cap are securely interlocked.



⚠ WARNING



Removing engine coolant reservoir cap

Never attempt to remove the engine coolant reservoir cap while the engine is operating or hot. Doing so might lead to cooling system damage and could result in serious personal injury from escaping hot coolant or steam.

⚠ WARNING

Turn the vehicle off and wait until the engine cools down. Use extreme care when removing the engine coolant cap. Wrap a thick towel around it and turn it slowly to the first stop. Step back while the pressure is released from the cooling system. When all the pressure has been released, press down on the cap, using a thick towel, and continue turning to remove it.

*** NOTICE**

The engine coolant level is influenced by the hybrid system temperature. Before checking or refilling the engine coolant, turn the hybrid vehicle off.

*** NOTICE**

For mixture percentage, refer to the following table.

Ambient Temperature	Mixture Percentage (volume)	
	Antifreeze	Water
5 °F (-15 °C)	35	65
-13 °F (-25 °C)	40	60
-31 °F (-35 °C)	50	50
-49 °F (-45 °C)	60	40

*** NOTICE**

To prevent damage to engine parts, put a thick towel around the engine coolant cap and/or inverter coolant cap before refilling the coolant to prevent the coolant from overflowing into engine parts, such as the alternator.

Changing the coolant

We recommend that the coolant be replaced by an authorized Kia dealer according to the Maintenance Schedule at the beginning of this chapter.

⚠ WARNING



Cooling fan

Use caution when working near the blade of the cooling fan. The electric motor (cooling fan) is controlled by coolant temperature, refrigerant pressure and

vehicle speed. It may sometimes operate even when the vehicle is not running.

Checking the inverter coolant level (HEV)

If frequent coolant additions are required, have the system inspected by an authorized Kia dealer.

The inverter coolant level should be in between MAX and MIN when the engine is cool.

⚠ WARNING

Adding other cooling substances or water might lead to inverter cooling system degradation or failure.



- Turn the vehicle off and wait until it cools.
- Use extreme care when removing the inverter coolant reservoir cap. Wrap a thick towel around it and turn it slowly to the first stop.
- Step back while the pressure is released from the cooling system.
- When all the pressure has been released, press down on the cap, using a thick towel, and continue turning to remove it.
- Check the condition and connections of all cooling system hoses and heater hoses.
- Replace any swollen or deteriorated hoses.
- Check the coolant level. The coolant level should be filled between MAX

and MIN marks on the side of the coolant reservoir when the engine compartment is cool.

- If the coolant level is low, add enough specified coolant to provide protection against freezing and corrosion. Bring the level to MAX, but do not overfill.

⚠ WARNING

Make sure the inverter coolant reservoir cap is properly closed after refill or coolant.

The inverter could overheat while driving.

1. Check if the inverter coolant reservoir cap label is straight in front.



2. Make sure that the tiny protrusions inside the inverter coolant reservoir cap are securely interlocked.



⚠ WARNING**Removing inverter coolant reservoir cap**

Never remove the inverter coolant reservoir cap while the engine and radiator are hot. Hot coolant and steam may blow out under pressure, causing serious injury.

⚠ WARNING**Removing inverter coolant reservoir cap**

Never remove the inverter coolant reservoir cap while the engine and radiator are hot. Hot coolant and steam may blow out under pressure, causing serious injury.

Changing the coolant

We recommend that the coolant be replaced by an authorized Kia dealer according to the Maintenance Schedule at the beginning of this chapter.

Changing the coolant

We recommend that the coolant be replaced by an authorized Kia dealer according to the Maintenance Schedule at the beginning of this chapter.

⚠ WARNING**Cooling fan**

Use caution when working near the blade of the cooling fan. The electric motor (cooling fan) is controlled by coolant temperature, refrigerant pressure and vehicle speed. It may sometimes operate even when the vehicle is not running.

⚠ WARNING**Cooling fan**

Use caution when working near the blade of the cooling fan. The electric motor (cooling fan) is controlled by coolant temperature, refrigerant pressure and vehicle speed. It may sometimes operate even when the vehicle is not running.

Checking the inverter coolant level (PHEV)

If frequent coolant additions are required, have the system inspected by an authorized Kia dealer.

The inverter coolant level should be in between MAX and MIN when the engine is cooled down.

⚠ WARNING

Adding other cooling substances or water might lead to inverter cooling system degradation or even failure.

Hybrid starter & generator (HSG) belt

Checking the HSG belt

Have the HSG belt inspected or replaced according to the Maintenance Schedule in this chapter by an authorized Kia dealer.

CAUTION

When the HSG belt is worn out or damaged, replace the belt. It may cause engine overheating or battery discharge.

WARNING

- Turn the vehicle off while you inspect the engine or HSG belt. It may result in serious injury.
- Keep hands, clothing etc. away from the HSG belt

Brake fluid

Checking the brake fluid level

Check the fluid level in the reservoir periodically. The fluid level should be between MAX and MIN marks on the side of the reservoir.



1. Before removing the reservoir, cap and adding brake fluid, clean the area around the reservoir cap thoroughly to prevent brake fluid contamination.
2. Periodically check that the fluid level in the brake fluid reservoir is between MIN and MAX. The level will fall with accumulated mileage. This is a normal condition associated with the wear of the brake linings.

If the fluid level is excessively low, have the system checked by an authorized Kia dealer.

Use only the specified brake fluid. (Refer to "Recommended lubricants and capacities" on page 10-6.)

Never mix different types of fluid.

WARNING

Loss of brake fluid

In the event the brake system requires frequent additions of fluid, have the system inspected by an authorized Kia dealer.

⚠ WARNING**Brake fluid**

When changing and adding brake fluid, handle it carefully. Do not let it contact your eyes. If brake fluid should contact your eyes, immediately flush them with a large quantity of fresh tap water. Have your eyes examined by a doctor as soon as possible.

⚠ CAUTION**Proper fluid**

Only use brake fluid in the brake system. Even small amounts of improper fluids can cause damage to the brake system.

⚠ CAUTION**Brake fluid**

Do not allow brake fluid to contact the vehicle's body paint, as paint damage will result.

The brake fluid constantly absorbs moisture from the air. This lowers the boiling point of the brake fluid. If the boiling point is too low, vapor pockets may form in the brake system when the brakes are applied hard.

Washer fluid**Checking the washer fluid level**

The reservoir is translucent so that you can check the level with a quick visual inspection.



- Check the fluid level in the washer fluid reservoir and add fluid if necessary. Plain water may be used if washer fluid is not available. Use washer solvent with antifreeze in cold climates to prevent freezing.

⚠ WARNING**Washer fluid**

- Do not use radiator coolant or anti-freeze in the washer fluid reservoir.
- Radiator coolant can severely obscure visibility when sprayed on the windshield and may cause loss of vehicle control or damage to paint and body trim.
- Windshield Washer fluid agents contain alcohol and can be flammable under certain circumstances. Do not allow sparks or flames to contact the washer fluid or the washer fluid reservoir. Damage to the vehicle or occupants could occur.
- Windshield washer fluid is poisonous to humans and animals. Do not drink and avoid contacting windshield washer fluid. Serious injury or death could occur.

Air cleaner filter

A genuine Kia air cleaner filter is recommended when the filter is replaced.

Replacing air cleaner filter

The air cleaner filter must be replaced when necessary and should not be washed.

You can clean the filter when inspecting the air cleaner compartment. Clean the filter by using compressed air.

1. Loosen the air cleaner cover attaching clips and open the cover.



2. Wipe the inside of the air cleaner.



3. Replace the air cleaner filter.
4. Lock the cover with the cover attaching clips. When installing the air cleaner, make sure to insert the hinge part correctly and attach the clip.



Replace the filter according to the Maintenance Schedule.

* NOTICE

If the vehicle is operated in extremely dusty or sandy areas, replace the element more often than the usual recommended intervals. (Refer to "Scheduled maintenance service" on page 9-8.)

⚠ CAUTION

Air filter maintenance

- Do not drive with the air cleaner removed; this will result in excessive engine wear.
- When removing the air cleaner filter, be careful that dust or dirt does not enter the air intake, or damage may result.
- Use a Kia genuine part. Use of a no genuine part could damage the air flow sensor.

Climate control air filter

Filter inspection

The climate control air filter should be replaced according to the maintenance schedule. If the vehicle is operated in severely air polluted cities or on dusty rough roads for a long period, it should be inspected more frequently and replaced earlier. When you replace the climate control air filter, replace it by performing the following procedure, and be careful to avoid damaging other components.

Operation

1. Open the glove box and remove the stopper (1).

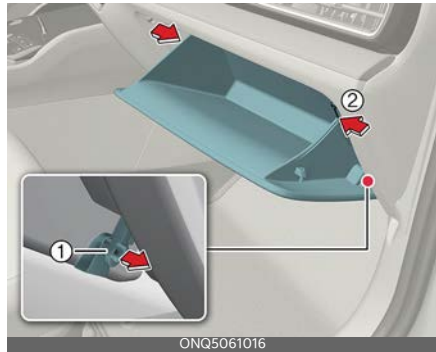

2. With the glove box open, pull the support strap.



- Remove the climate control air filter cover by pulling out both sides of the cover.



- Replace the climate control air filter.
- Assemble in reverse order.

* NOTICE

When replacing the climate control air filter install it properly. Otherwise, the system may produce noise and the effectiveness of the filter may be reduced.

Wiper blades

When the wipers no longer clean adequately, the blades may be worn or cracked, and require replacement.

To prevent damage to the wiper arms or other components, do not attempt to move the wipers manually.

The use of a non specified wiper blade could result in wiper malfunction and failure.

Blade inspection



* NOTICE

Commercial hot waxes applied by automatic car washes have been known to make the windshield difficult to clean.

Contamination of either the windshield or the wiper blades with foreign matter can reduce the effectiveness of the windshield wipers. Common sources of contamination are insects, tree sap and hot wax treatments used by some commercial car washes. If the blades are not wiping properly, clean both the window and the blades with a good cleaner or mild detergent, and rinse thoroughly with clean water.

⚠ CAUTION

To prevent damage to the wiper blades, do not use gasoline, kerosene, paint thinner, or other solvents on or near them.

Blade replacement

When the wipers no longer clean adequately, the blades may be worn or cracked, and require replacement.

⚠ CAUTION

To prevent damage to the wiper arms or other components, do not attempt to move the wipers manually.

⚠ CAUTION

The use of a non-specified wiper blade could result in wiper malfunction and failure.

Front wiper blade replacement



For your convenience and to prevent hood paint damage, you must move the windshield wiper blades to the service position as follows.

After turning off the engine, move the wiper switch to the single wiping (MIST) position within 20 seconds and hold the switch more than 2 seconds until the wiper blade is in the fully up position.

⚠ CAUTION

Wiper arms

- Do not allow the wiper arm to fall against the windshield, since it may chip or crack the windshield.
- Do not pull the wiper arm forward, since it could chip hood paint.

Type A (if equipped)

1. Raise the wiper arm.
2. Lift up the wiper blade clip. Then pull down the blade assembly and remove it.



3. Install the new blade assembly.



4. Make sure that both blade assemblies are installed firmly by trying to pull it slightly.
5. Return the wiper arm onto the windshield.
6. Turn the ignition to the ON position and the wiper arms will return to the normal operating position.

Type B (if equipped)

1. Raise the wiper arm and turn the wiper blade assembly to expose the plastic locking clip.



2. Compress the clip and slide the blade assembly downward.



3. Lift it off the arm.
4. Install the blade assembly in the reverse order of removal.

Rear wiper blade replacement



1. Within 20 seconds after the vehicle ignition is OFF, move the wiper lever to MIST position for over 2 seconds until the wiper moves down to the bottom middle part.
2. Raise the wiper arm and pull out the wiper blade assembly.



3. Lift up the wiper blade and pull the blade to remove it.

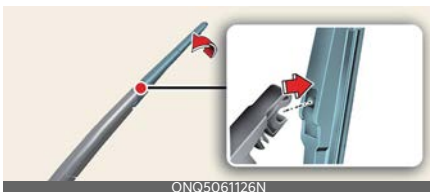

4. Install the new blade assembly by inserting the center part into the slot in the wiper arm until it clicks into place.

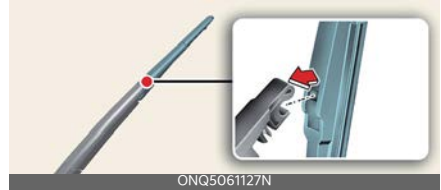

5. Make sure the blade assembly is installed firmly by trying to pull it slightly.

If the replacement is complete, put down the wiper arm to place it on the rear windshield, and turn the vehicle ignition to ON and operate the wipers to check the blade is installed correctly.

To prevent damage to the wiper arms or other components, have the wiper blade replaced by an authorized Kia dealer.

⚠ CAUTION

If the wiper arm receives too much force while pulling the blade, the center part may be damaged.

⚠ CAUTION

- The wiper may not operate for approx. 10 seconds when the wiper is operated without washer fluid, or the blades are frozen. This is not a malfunction, it is a wiper protection system activated by motor overload circuit within the wiper motor.
- The front windshield should be cleaned with water and wiped with a clean towel with wiper blades raised up. The wiper blades should be wiped

clean when the grease or wax is applied to the blades.

Battery

Plug-in hybrid vehicle

For best battery service



- Keep the battery securely mounted.
- Keep the battery top clean and dry.
- Keep the terminals and connections clean, tight, and coated with petroleum jelly or terminal grease.
- Rinse any spilled electrolyte from the battery immediately with a solution of water and baking soda.
- If the vehicle is not going to be used for an extended time, disconnect the battery cables.

* NOTICE

Your vehicle is equipped with a maintenance-free battery. If your vehicle is equipped with the battery marked with LOWER and UPPER on the side, you can check the electrolyte level. The electrolyte level should be between LOWER and UPPER. If the electrolyte level is low, it needs distilled (demineralized) water (never add sulfuric acid or another electrolyte). When refilling, be careful not to splash the battery and adjacent components. Do not overfill the battery cells. It can cause corrosion on other parts. Ensure that the cell caps are tightened. Contact an authorized Kia dealer.

⚠ WARNING**Risk of explosion**

Keep lit cigarettes and all other flames or sparks away from the battery.



The battery contains hydrogen — a highly combustible gas which will explode if it contacts a flame or spark.



Keep batteries out of the reach of children because batteries contain highly corrosive SULFURIC ACID and electrolytes.

Do not allow battery acid to contact your skin, eyes, clothing or paint finish.



Wear eye protection when charging or working near a battery. Always provide ventilation when working in an

enclosed space.



Always read the following instructions carefully when handling a battery.



If any electrolyte gets in your eyes, flush them with clean water for at least 15 minutes and get immediate medical

attention. If electrolyte gets on your skin, thoroughly wash the contacted area. If you feel pain or burning sensation, get medical attention immediately.



An inappropriately disposed battery can be harmful to the environment and human health. Dispose of the battery

according to your local law(s) or regulation.



The battery contains lead. Do not dispose of it after use. Please return the battery to an authorized Kia dealer to be

recycled.

Never attempt to recharge the battery when the battery cables are connected.

⚠ WARNING**Risk of electrocution**

Never touch the electrical ignition system while the vehicle is running. This system works with high voltage, which can cause a shock.

*** NOTICE**

If you connect unauthorized electronic devices to the battery, the battery may be discharged. Never use unauthorized devices.

⚠ WARNING**Recharging battery**

Never attempt to recharge the battery when the battery cables are connected.

⚠ WARNING**Battery lead compound**

Battery posts, terminals, and related accessories contain lead and lead compounds. Wash hands after handling.

⚠ WARNING**California Proposition 65**

Battery posts, terminals, and related accessories contain lead and lead compounds, chemicals known to the State of California to cause cancer, birth defects and reproductive harm.

Batteries also contain other chemicals known to the State of California to cause cancer. Wash hands after handling.

Battery recharging

Should your vehicle's battery become discharged either run the engine for at least 60 minutes driving. Alternately you may connect a fully automatic regulated charger to the motor compartment front jumper posts or battery in the engine room.

When recharging the battery, observe the following precautions:

- The battery must be removed from the vehicle and placed in an area with good ventilation.
- Do not allow cigarettes, sparks, or flames near the battery.
- Watch the battery during charging, and stop or reduce the charging rate in following cases:
 1. the battery cells begin gassing (boiling) violently
 2. the electrolyte temperature of any cell exceeds 120 °F (49 °C).
- Wear eye protection when checking the battery during charging.
- Before performing maintenance or recharging the battery, turn off all accessories and stop the vehicle.
- Disconnect the battery charger in the following order.
 1. Turn off the battery charger main switch.
 2. Unhook the negative clamp from the negative battery terminal.
 3. Unhook the positive clamp from the positive battery terminal.
- The negative battery cable must be removed first and installed last when the battery is disconnected.

⚠ CAUTION

Absorbent Glass Mat (AGM) battery

- AGM batteries are maintenance free. Have the AGM battery serviced by an authorized Kia dealer.
- For charging your AGM battery, use only fully automatic battery chargers that are specially developed for AGM batteries.
- When replacing the AGM battery, only use parts from an authorized Kia dealer.
 - Do not open or remove the cap on top of the battery. This may cause leaks of internal electrolyte that could result in severe injury.

Hybrid vehicle

The 12V auxiliary battery of the vehicle is integrated within the high-voltage battery. The high-voltage battery is located under the 2nd row seat cushion.

For battery related servicing, visit an authorized Kia dealer.

12V auxiliary battery connector



Disconnect the 12V auxiliary battery connector located inside the engine compartment to shut down the power of the 12V auxiliary battery.

Connect the 12V auxiliary battery connector again after the battery related maintenance is finished.

CAUTION

- The efficiency of the battery decreases during low temperatures. If the vehicle is not used for the extended period, park the vehicle indoors if possible.
- Always keep the battery charged to full capacity. The battery case may be damaged due to freezing if the battery capacity is low.
- Do not install unauthorized electrical devices (e.g., lamps, dashcam, etc.) in the vehicle. It may discharge the battery.

Reset items

The following items should be reset after the battery terminal (for plug-in hybrid vehicle), or battery connector (for hybrid vehicle) has been disconnected.

- Auto up/down window (Refer to "Window opening and closing" on page 5-45)
- Climate control system (Refer to "Automatic climate control system" on page 5-117)

- Sunroof (Refer to "Panoramic sunroof (if equipped)" on page 5-55)
- Driver's seat position (Refer to "Integrated memory system (if equipped)" on page 5-32)
- Trip computer information settings (Refer to "LCD display" on page 5-89)
- Radio presets

Tires and wheels

For safety, maintenance and maximum fuel economy, always maintain the recommended tire pressures and stay within the load limits and weight distribution.

Recommended cold tire inflation pressures

All tire pressures should be checked when the tires are cold. "Cold Tires" means the vehicle has not been driven for at least three hours or driven less than 1 mile (1.6 km).

Recommended pressures must be maintained for the best ride, vehicle handling, and minimum tire wear.

For recommended pressure, refer to "Tires and wheels" on page 10-5.

All specifications (sizes and pressures) can be found on a label attached to the driver's side center pillar.



⚠ WARNING

Tire underinflation

Inflate your tires consistent with the instructions provided in this manual. Regularly check the tire inflation pressure, and adjust as needed, at least twice a month and before any long trips on the road. Failure to observe this precaution may result in driving on underinflated tires, which may not only compromise your vehicle's driving stability. It may also lead to tire damage and the risk of an accident. This risk is much higher on hot days and when driving for long periods at high speeds.

Failure to maintain specified pressure may result in excessive wear, poor handling, reduced fuel economy, deformation of tire and/or wheel, harsh ride conditions, the possibility for additional damage from road hazards, or result in tire failure.

Tire pressure

Always observe the following:

- Check tire pressure when the tires are cold. (After vehicle has been parked for at least three hours or hasn't been driven more than 1 mile (1.6 km) since startup.)

- Check the pressure of your spare tire (if equipped) each time you check the pressure of other tires.
- Never overload your vehicle. Be careful not to overload a vehicle luggage rack if your vehicle is equipped with one.
- Warm tires normally exceed recommended cold tire pressures by 4-6 psi (28-41 kPa). Do not release air from warm tires to adjust the pressure or the tires will be underinflated.

WARNING

Tire Inflation

Overinflation or underinflation can reduce tire life, adversely affect vehicle handling, and lead to sudden tire failure. This could result in loss of vehicle control and potential injury.

Checking tire inflation pressure

Check your tires once a month or more.

Use a good quality gauge to check tire pressure. You cannot tell if your tires are properly inflated simply by looking at them. Radial tires may look properly inflated even when they're underinflated.

Check the tire's inflation pressure when the tires are cold. "Cold"

means your vehicle has been sitting or at least three hours or driven no more than 1 mile (1.6 km).

1. Remove the valve cap from the tire valve stem.
2. Press the tire gauge firmly onto the valve to get a pressure measurement. If the cold tire inflation pressure matches the proper pressure on the tire and loading information label, no further adjustment is necessary.
3. If the pressure is low, add air until you reach the recommended amount.
4. If you overfill the tire, release air by pushing on the metal stem in the center of the tire valve.
5. Recheck the tire pressure with the tire gauge.
6. Be sure to put the valve caps back on the valve stems. They help prevent leaks by keeping out dirt and moisture.

Inspect your tires frequently for proper inflation as well as wear and damage. Always use a tire pressure gauge.

Tires with too much or too little pressure wear unevenly. This could result in poor handling, loss of vehicle control, and sudden tire failure leading to acci-

dents, injuries, and even death. The recommended cold tire pressure for your vehicle can be found in this manual and on the tire label located on the driver's side center pillar.

Tire rotation

To equalize tread wear, it is recommended that the tires be rotated every 8,000 miles (13,000 km) or sooner if irregular wear develops.

During rotation, check the tires for correct balance.

When rotating tires, check for uneven wear and damage. Abnormal wear is usually caused by incorrect tire pressure, improper wheel alignment, out of-balance wheels, severe braking or severe cornering. Look for bumps or bulges in the tread or side of tire. Replace the tire if you find either of these conditions. Replace the tire if fabric or cord is visible. After rotation, be sure to bring the front and rear tire pressures to specification and check lug nut tightness. (proper torque is 79-94 lbf·ft [11-13 kgf·m])

Refer to "Tires and wheels" on page 10-5.

Disc brake pads should be inspected for wear whenever tires are rotated.

With a full-size spare tire (if equipped)

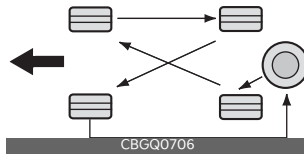

Without a spare tire

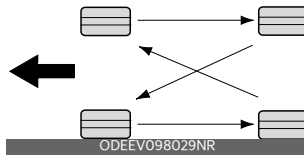

Directional tires (if equipped)

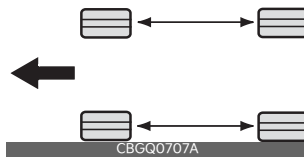

Rotate radial tires that have an asymmetric tread pattern only from front to rear and not from right to left.

⚠ WARNING

Mixing tires

Do not mix bias ply and radial ply tires under any circumstances. This may cause unusual handling characteristics which can lead to loss of control and an accident.

Wheel alignment and tire balance

The wheels on your vehicle were aligned and balanced carefully at the factory to provide the longest tire life and best overall performance.

If you notice unusual tire wear or your vehicle pulling one way or the other, the alignment may need to be reset.

If you notice your vehicle vibrating when driving on a smooth road, your wheels may need to be rebalanced.

CAUTION

Wheel weight

Improper wheel weights can damage your vehicle's aluminum wheels. Use only approved wheel weights.

Wheel and tire installation

When removing and installing wheels and tires, use the tool for removing the hub cap inside the tool case to remove the hub cap. The remover insertion hole is located at the top or edge of the hub cap.

Dedicated remover storage position

With tire mobility kit



ONQ5064005

With Jack and tools

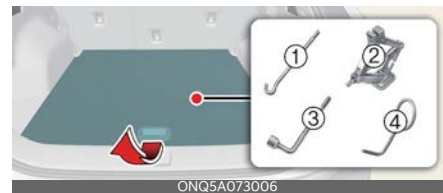

ONQ5A073006

1. Jack handle
2. Jack
3. Wheel lug nut wrench
4. Tool for removing wheel cover (if equipped)

How to remove the hub cap using a dedicated removal tool



ONQ5064007

1. Make sure to place the hubcap into the designated position when replacing the hubcap.
2. The designated position of the hubcap depends on the shape

of the wheel. It must be installed in the same position as before disassembly.

3. Be careful not to install in the wrong location or force it in, as this may damage the parts or cause the wheel cover to come off while driving.

Tire replacement

If the tire is worn evenly, a tread wear indicator will appear as a solid band across the tread.



[A]: Tread wear indicator

This shows there is less than 1/16 in (1.6 mm) of tread left on the tire. Replace the tire when this happens.

Do not wait for the band to appear across the entire tread before replacing the tire.

The ABS works by comparing the speed of the wheels. Tire size affects wheel speed. When replacing tires, all 4 tires must use the same size originally supplied with the vehicle. Using tires of a different size can cause the ABS and ESC to malfunction.

It is best to replace all four tires at the same time. If that is not

possible, replace the two front or two rear tires as a pair. Replacing just one tire can seriously affect your vehicle's handling.

* NOTICE

We recommend that when replacing tires, use the same ones originally supplied with the vehicles. If not, driving performance will be affected.

Wheel replacement

When replacing the metal wheels for any reason, make sure the new wheels are equivalent to the original factory units in diameter, rim width and offset.

A wheel with an incorrect size may adversely affect many things: wheel and bearing life, braking and stopping abilities, handling characteristics, ground clearance, body-to-tire clearance, snow chain clearance, speedometer and odometer calibration, headlamp aiming and bumper height.

⚠ CAUTION

Wheels

Wheels that do not meet Kia specifications may fit poorly and result in damage to the vehicle, unusual handling or poor vehicle control.

Tire traction

Tire traction can be reduced if you drive on worn tires, tires that are improperly inflated, or on slippery road surfaces.

Tires should be replaced when tread wear indicators appear. Slow down whenever there is rain, snow or ice on the road to reduce the possibility of losing control.

Tire maintenance

In addition to proper inflation, correct wheel alignment helps to decrease tire wear.

If you find a tire is worn unevenly, have your authorized Kia dealer check the wheel alignment.

Make sure the newly installed tires are balanced correctly to increase vehicle ride comfort and tire life. Always rebalance the tire when the tire is removed from the wheel.

Tire sidewall labeling

This information identifies and describes the fundamental characteristics of the tire and provides the Tire Identification Number (TIN) for safety standard certification.



The TIN can be used to identify the tire in case of a recall.

1. Manufacturer or brand name

Manufacturer or Brand name is shown.

2. Tire size designation

A tire's sidewall is marked with a tire size designation. You will need this information when selecting replacement tires for your vehicle. The following explains what the letters and numbers in the tire size designation mean.

Example tire size designation:

(These numbers are provided as an example only; your tire size designator could vary depending on your vehicle.)

P235/55R19 105V

- P: Applicable vehicle type (tires marked with the prefix "P" are intended for use on passenger vehicles or light trucks; however, not all tires have this marking).

- 235: Tire width in millimeters.
- 55: Aspect ratio. The tire's section height as a percentage of its width.
- R: Tire construction code (Radial).
- 19: Rim diameter in inches.
- 105: Load Index, a numerical code associated with the maximum load the tire can carry.
- V: Speed Rating Symbol. See the speed rating chart in this section for additional information.

designed maximum safe operating speed.

Speed Rating Symbol	Maximum Speed
S	112 mph (180 km/h)
T	118 mph (190 km/h)
H	130 mph (210 km/h)
V	149 mph (240 km/h)
W	168 mph (270 km/h)
Y	186 mph (300 km/h)

Wheel size designation

Wheels are also marked with important information that you need if you must replace one. The following explains what the letters and numbers in the wheel size designation mean.

Example wheel size designation:

7.5J x 19

- 7.5: Rim width in inches.
- J: Rim contour designation.
- 19: Rim diameter in inches.

Tire speed ratings

The chart below lists many of the different speed ratings currently being used for passenger vehicle tires. The speed rating is part of the tire size designation on the sidewall of the tire. This symbol corresponds to that tire's

3. Checking tire life

Any tires that are over 6 years old, based on the manufacturing date, should be replaced by new ones. You can find the manufacturing date on the tire sidewall (possibly on the inside of the wheel), displaying the DOT code. The DOT code is a series of numbers on a tire consisting of numbers and English letters. The manufacturing date is designated by the last four digits (characters) of the DOT code.

DOT: XXXX XXXX OOOO

The front part of the DOT means a plant code number, tire size and tread pattern and the last four numbers indicate week and year manufactured.

For example:

DOT XXXX XXXX 1625 represents that the tire was produced in the 16th week of 2025.

⚠ CAUTION

Tire age

Replace tires within the recommended time frame. Failure to replace tires as recommended can result in sudden tire failure, which could lead to a loss of control and an accident.

4. Tire ply composition and material

The number of layers or plies of rubber-coated fabric in the tire. Tire manufacturers also must indicate the materials in the tire, which include steel, nylon, polyester, and others. The letter "R" means radial ply construction; the letter "D" means diagonal or bias ply construction; and the letter "B" means belted-bias ply construction.

5. Maximum Inflation Pressure

This number is the greatest amount of air pressure that should be put in the tire. Do not exceed the maximum inflation pressure. Refer to "Certification label" on page 6-69 for recommended inflation pressure.

6. Maximum load rating

This number indicates the maximum load in kilograms and pounds that can be carried by the tire. When replacing the tires on the vehicle, always use tires that have the same load rating as the factory installed tires.

7. Uniform Tire Quality Grading

Quality grades can be found where applicable on the tire sidewall between tread shoulder and maximum section width.

For example:

- Treadwear 200
- Traction AA
- Temperature A

Tires degrade over time, even when they are not being used. Regardless of the remaining tread, we recommend that tires (including the spare tire) be replaced after approximately six (6) years of normal service. Heat caused by hot climate or frequent high loading conditions can accelerate the aging process.

Tread wear

The tread wear grade is a comparative rating based on the wear rate of the tire when tested under controlled conditions on a specified government test

course. For example, a tire graded 150 would wear one-and-a-half times (1½) as well on the government course as a tire graded 100.

The relative performance of tires depends upon the actual conditions of their use. Performance may depart significantly from the norm due to variations in driving habits, service practices and differences in road characteristics and climate.

These grades are molded on the sidewalls of passenger vehicle tires. The tires available as standard or optional equipment on your vehicle may vary with respect to grade.

Traction - AA, A, B, and C

The traction grades, from highest to lowest, are AA, A, B and C.

Those grades represent the tire's ability to stop on wet pavement as measured under controlled conditions on specified government test surfaces of asphalt and concrete. A tire marked C may have poor traction performance.

The traction grade assigned to this tire is based on straight-ahead braking traction tests, and does not include acceleration, cornering, hydroplaning, or peak traction characteristics.

Temperature -A, B, and C

The temperature grades are A (the highest), B and C representing the tire's resistance to the generation of heat and its ability to dissipate heat when tested under controlled conditions on a specified indoor laboratory test wheel.

Sustained high temperature can cause the material of the tire to degenerate and reduce tire life and can lead to sudden tire failure. The grade C corresponds to a level of performance which all passenger vehicle tires must meet under the Federal Motor Vehicle Safety Standard (FMVSS) No. 109. Grades B and A represent higher levels of performance on the laboratory test wheel than the minimum required by law.

Tire terminology and definitions

Refer to the following for detailed definitions of the terms that are found in the tire description.

Air Pressure: The amount of air inside the tire pressing outward on the tire. Air pressure is expressed in pounds per square inch (psi) or kilopascal (kPa).

Accessory Weight: The combined weight of optional accessories. Some examples of

optional accessories are automatic transmission, power seats, and air conditioning.

Aspect Ratio: The relationship of a tire's height to its width.

Belt: A rubber coated layer of cords that is located between the plies and the tread. Cords may be made from steel or other reinforcing materials.

Bead: The tire bead contains steel wires wrapped by steel cords that hold the tire onto the rim.

Bias Ply Tire: A pneumatic tire in which the plies are laid at alternate angles less than 90 degrees to the centerline of the tread.

Cold Tire Pressure: The amount of air pressure in a tire, measured in pounds per square inch (psi) or kilopascals (kPa) before a tire has built up heat from driving.

Curb Weight: The weight of the vehicle with standard and optional equipment (including the maximum capacity of fuel, oil and coolant), but without passengers or cargo.

DOT Markings: A code molded into the sidewall of a tire signifying that the tire is in compliance with the U.S. Department of Transportation motor vehicle safety standards. The DOT code includes the Tire Identification

Number (TIN), an alphanumeric designator which can also identify the tire manufacturer, production plant, brand and date of production.

GVWR: Gross Vehicle Weight Rating

GAWR FRT: Gross Axle Weight Rating for the Front axle.

GAWR RR: Gross Axle Weight Rating for the Rear axle.

Intended Outboard Sidewall:

The side of an asymmetrical tire that must always face outward when mounted on a vehicle.

Kilopascal (kPa): The metric unit for air pressure.

Light truck (LT) tire: A tire designated by its manufacturer as primarily intended for use on lightweight trucks or multipurpose passenger vehicles.

Load ratings: The maximum load that a tire is rated to carry for a given inflation pressure.

Load Index: An assigned number ranging from 1 to 279 that corresponds to the load carrying capacity of a tire.

Maximum Inflation Pressure:

The maximum air pressure to which a cold tire may be inflated. The maximum air pressure is molded onto the sidewall.

Maximum Load Rating: The load rating for a tire at the maxi-

imum inflation pressure for that tire.

Maximum Loaded Vehicle

Weight: The sum of curb weight; accessory weight; vehicle capacity weight; and production options weight.

Normal Occupant Weight: The number of occupants a vehicle is designed to seat multiplied by 150 lbs. (68 kg).

Occupant Distribution: Designated seating positions.

Outward Facing Sidewall: The side of an asymmetrical tire that has a particular side that faces outward when mounted on a vehicle. The outward facing sidewall bears white lettering or bears manufacturer, brand, and/or model name molding that is higher or deeper than the same moldings on the inner facing sidewall.

Passenger (P-Metric) Tire: A tire used on passenger cars and some light duty trucks and multi-purpose vehicles.

Ply: A layer of rubber-coated parallel cords.

Pneumatic tire: A mechanical device made of rubber, chemicals, fabric and steel or other materials, that, when mounted on an automotive wheel, provides traction and contains the

gas or fluid that sustains the load.

Production options weight: The combined weight of installed regular production options weighing over 5 lbs. (2.3 kg) in excess of the standard items which they replace, not previously considered in curb weight or accessory weight. Examples include heavy-duty brakes, ride levelers, roof rack, heavy duty battery, and special trim.

Recommended Inflation Pressure: Vehicle manufacturer's recommended tire inflation pressure and shown on the tire placard.

Radial Ply Tire: A pneumatic tire in which the ply cords that extend to the beads are laid at 90 degrees to the centerline of the tread.

Rim: A metal support for a tire and upon which the tire beads are seated.

Sidewall: The portion of a tire between the tread and the bead.

Speed Rating: An alphanumeric code assigned to a tire indicating the maximum speed at which a tire can operate.

Traction: The friction between the tire and the road surface. The amount of grip provided.

Tread: The portion of a tire that contacts the road.

Treadwear Indicators: Narrow bands, sometimes called "wear bars," that show across the tread of a tire when only 2/32 inch (1.6 mm) of tread remains.

Uniform Tire Quality Grading Standards (UTQGS): A tire information system that provides consumers with ratings for a tire's traction, temperature and treadwear. Ratings are determined by tire manufacturers using government testing procedures. The ratings are molded into the sidewall of the tire.

Vehicle Capacity Weight: The weight of designated seating positions multiplied by 150 lbs. (68 kg) plus the rated cargo and luggage load.

Vehicle Maximum Load: On the Tire Load on an individual tire due to curb and accessory weight plus maximum occupant and cargo weight.

Vehicle Normal Load: On the Tire Load on an individual tire that is determined by distributing to each axle its share of the curb weight, accessory weight, and normal occupant weight and driving by 2.

Vehicle Placard: A label permanently attached to a vehicle showing the original equipment tire size and recommended inflation pressure.

All-season tires

Kia specifies all-season tires on some models to provide good performance for use all year round, including snowy and icy road conditions.

All-season tires are identified by ALL SEASON and/or M+S (Mud and Snow) on the tire sidewall. Snow tires have better snow traction than all-season tires and may be more appropriate in some areas.

Summer tires

Kia specifies summer tires on some models to provide superior performance on dry roads.

Summer tire performance is substantially reduced in snow and ice. Summer tires do not have the tire traction rating M+S (Mud and Snow) on the tire side wall. If you plan to operate your vehicle in snowy or icy conditions, Kia recommends the use of snow tires or all-season tires on all four wheels.

Snow tires

If you equip your vehicle with snow tires, they should be the same size and have the same load capacity as the original tires. Snow tires should be installed on all four wheels; otherwise, poor handling may result.

Snow tires should carry 4 psi (28 kPa) more air pressure than the pressure recommended for standard tires on the tire label on the driver's side of the center pillar, or up to the maximum pressure shown on the sidewall, whichever is less.

Do not drive faster than 75 mph (120 km/h) when your vehicle is equipped with snow tires.

⚠ WARNING

Do not use summer tires at temperatures below 45 °F (7 °C) or when driving on snow or ice. At temperatures below 45 °F (7 °C), summer tires can lose elasticity, traction and braking power.

Change the tires on your vehicle to winter or all weather tires of the same size as the standard tires of the vehicle. Both types of tires are identified by the M+S (Mud and Snow) marking. Using summer tires at very cold temperatures could cause cracks to form and permanently damage the tires.

Tire chains

Tire chains, if necessary, should be installed on the front wheels. Be sure that the chains are installed in accordance with the chain manufacturer's instructions.

To minimize tire and chain wear, do not continue to use tire chains when they are not needed.

- When driving on roads covered with snow or ice, drive at speeds less than 20 mph (30 km/h).
- Use the SAE "S" class or wire chains.
- If you hear noise caused by chains contacting the body, retighten the chain to avoid contact with the vehicle body.
- To prevent vehicle body damage, retighten the chains after driving 0.3-0.6 miles (0.5-1.0 km).
- Do not use tire chains on vehicles equipped with aluminum wheels. In unavoidable circumstances, use a wire type chain.
- Use wire chains less than 0.47 inches (12 mm) to prevent damage to the chain's connection.

Radial-ply tires

Radial-ply tires provide improved tread life, road hazard resistance and a smoother high-speed ride.

The radial-ply tires used on this vehicle are of belted construction and are selected to complement the ride and handling characteristics of your vehicle. Radial-ply tires have the same load carrying capacity, as bias-ply or bias

belted tires of the same size and use the same recommended inflation pressure.

Mixing radial-ply tires with bias-ply or bias belted tires is not recommended. Any combinations of radial-ply and bias-ply or bias belted tires when used on the same vehicle will seriously deteriorate vehicle handling. The best rule to follow is for all four identical radial-ply tires to always be used.

Longer wearing tires can be more susceptible to irregular tread wear. It is very important to follow the tire rotation interval shown in this section to achieve the best tread life. Cuts and punctures in radial-ply tires are repairable only in the tread area because of sidewall flexing. Consult your tire dealer for radial-ply tire repairs.

Fuses

Blade type



Cartridge type



Multi fuse



BFT

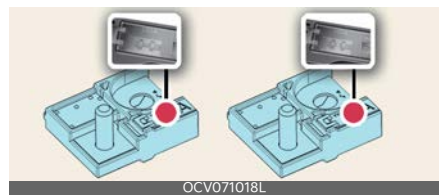

* Left side: Normal, Right side: Blown

* The actual fuse/relay panel label may differ from equipped items.

A vehicle's electrical system is protected from electrical overload damage by fuses.

This vehicle has 2 (or 3) fuse panels, one located in the driver's side panel bolster, the other in the engine compartment near the battery.

If any of your vehicle's lights, accessories or controls do not work, check the appropriate circuit fuse. If a fuse has blown, the element inside the fuse will melt.

If the electrical system does not work, first check the driver's side fuse panel. If the replacement fuse blows, this indicates an electrical problem. Avoid using the system involved and immediately consult an authorized Kia dealer.

Three kinds of fuses are used: blade type for lower amperage rating, car-tridge type, and multi fuse for higher amperage ratings.

WARNING

Fuse replacement

- Never replace a fuse with anything other than a fuse of the same rating.
- A higher capacity fuse could cause damage and possibly a fire.
- Never install wire or aluminum foil instead of the proper fuse - even as a temporary repair. It may cause extensive wiring damage and a possible fire.
- Do not modify or add electric wiring to the vehicle.

CAUTION

Do not use a screwdriver or any other metal object to remove fuses because it may cause a short circuit and damage the system.

* NOTICE

- When replacing a fuse, turn the ignition 'OFF' and turn off switches of all electrical devices. Disconnect the (-) battery terminal (or plug-in hybrid

vehicle) or battery connector (for hybrid vehicle).

- **Window tinting precaution**

Window tint (especially metallic film) might cause poor radio reception and malfunction of the automatic lighting system due to excessive change of illumination inside the vehicle. The solution used might also flow into electronic devices causing failure.

- **Window tinting precaution**

Window tint (especially metallic film) might cause communication disorder or poor radio reception, and malfunction of the automatic lighting system due to excessive change of illumination inside the vehicle. The solution used might also flow into electric, electronic devices causing disorder and failure.

WARNING

Electrical fire

Always ensure replacement fuses and relays are securely fastened when installed. Failure to do so can result in a vehicle fire.

Do not remove fuses, relays and terminals fastened with bolts or nuts. The fuses, relays and terminals may not be fastened securely and may cause a fire. If fuses, relays and terminals fastened with bolts or nuts are blown, consult with an authorized Kia dealer.

CAUTION

When replacing a blown fuse or relay, ensure the new fuse or relay fits tightly into the clips. Failure to tightly install the fuse or relay may cause damage to the wiring and electric systems.

⚠ CAUTION

- Do not put objects except fuses or relays into fuse/relay terminals such as a screwdriver or wiring. It may cause contact failure and system malfunction.
- Do not plug in screwdrivers or after-market wiring into the terminal originally designed for fuse and relays only. The electrical system and wiring of the vehicle interior may be damaged or burned due to contact failure.
- If you directly connect the wire on the taillamp or replace the bulb which is over the regulated capacity to install trailers etc., the inner junction block can get burned.

⚠ WARNING

Electrical wiring repairs

All electrical repairs should be performed by authorized Kia dealerships using approved Kia parts. Using other wiring components, especially when retrofitting multimedia or theft alarm system, car phone or radio may cause damage and increase the risk of a fire.

* NOTICE

Rewiring prohibited

Do not rewire your vehicle in any way as doing so may affect the performance of several safety features in your vehicle. Rewiring your vehicle may also void your warranty and make you responsible for any damage which may result.

Inner panel fuse replacement

1. Turn the ignition switch or ENGINE START/STOP button and all other switches off.
2. Open the fuse panel cover.



3. Pull the suspected fuse straight out. Use the removal tool provided in the main fuse box in the engine compartment.



4. Check the removed fuse; replace it if it is blown.
Spare fuses are provided in the instrument panel fuse panel (or in the engine compartment fuse panel).
5. Push in a new fuse of the same rating and make sure it fits tightly in the clips.

If it fits loosely, consult an authorized Kia dealer.

If you do not have a spare, use a fuse of the same rating from a circuit you may not need for operating the vehicle, such as the cigarette lighter fuse.

If the headlamps or taillamps, stoplights, courtesy lamp or daytime running lights (DRL) do not work and the fuses are OK, consult an authorized Kia dealer.

Engine compartment fuse replacement

1. Turn the ignition and all other switches off.
2. Remove the fuse panel cover by pressing the tab and pulling the cover up.



3. Check the removed fuse; replace it if it is blown. To remove or insert the fuse, use the fuse puller in the engine compartment fuse panel.
4. Push in a new fuse of the same rating, and make sure it fits tightly in the clips. If it fits loosely, consult an authorized Kia dealer.

⚠ CAUTION

After checking the fuse panel in the engine compartment, securely install the fuse panel cover.

Electrical failures may occur from water contact.

*** NOTICE**

If the multi fuse is blown, consult an authorized Kia dealer.

*** NOTICE**

The electronic system may not function correctly even when the engine compartment and internal fuse box's individual fuses are connected. The cause of the problem may be disconnection of the main fuse (BFT type), which is located inside the positive battery termi-

nal (+) cap (for plug-in hybrid vehicle). Since the main fuse is designed more intricately than other parts, visit the nearest authorized Kia dealer.

Main fuse (Multi fuse)



If the main fuse is blown, it must be removed as follows:

1. Turn off the engine.
2. Disconnect the negative battery cable.
3. Remove the nuts shown in the picture above.
4. Replace the fuse with a new one of the same rating.
5. Reinstall in the reverse order of removal.

⚠ CAUTION

Visually inspect the battery cap for secure closing. If the battery cap is not securely latched, the electrical system may be damaged due to influx of moisture into the system.

Fuse/relay panel description

Inside the fuse/relay panel covers, you can find the fuse/relay label describing fuse/relay name and capacity.

*** NOTICE**

Not all fuse panel descriptions in this manual may apply to your vehicle. When you inspect the fuse panel in your vehicle, refer to the fuse panel label.

Driver's side fuse panel

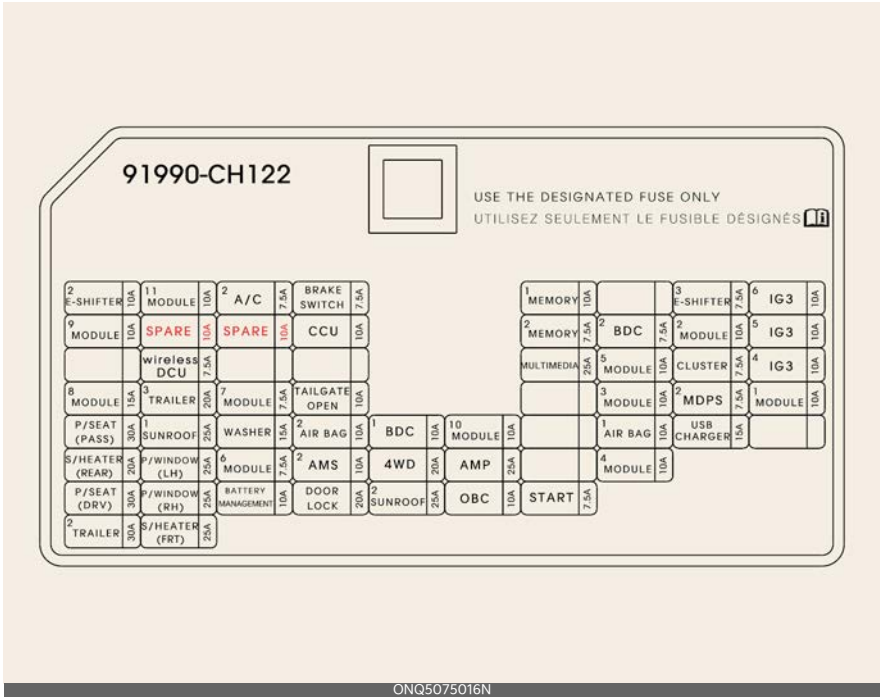

PDC Block

Fuse Name	Fuse Rating	Circuit Protected
DOOR LOCK	20A	Center Door Lock/Unlock Relay
P/WINDOW RH	25A	Power Window Main Switch, Passenger Power Window Switch
P/WINDOW LH	25A	Power Window Main Switch
S/HEATER (REAR)	20A	Rear Seat Warmer Control Module
S/HEATER (DRV/PASS)	25A	Front Air Ventilation Seat Control Module, Front Seat Warmer Control Module
P/SEAT (PASS)	30A	Passenger Power Seat Switch, Passenger Seat Relay Unit
SUNROOF2	25A	Sunroof Controller (Blind Motor)

Fuse Name	Fuse Rating	Circuit Protected
AIRBAG2	10A	SRS (Supplemental Restraint System) Control Module
SUNROOF1	25A	Sunroof Controller (Glass Motor)
P/SEAT DRV	30A	Driver Power Seat Switch, Driver IMS (Integrated memory system) Control Module
MODULE9	10A	Driver IMS (Integrated memory system) Control Module, Driver/Passenger Smart Key Outside Handle, Rain Sensor, Hazard Switch, Data Link Connector, Power Liftgate Unit
AMP (Amplifier)	25A	AMP (Amplifier)
BDC 2	7.5A	BDC (Body Domain Controller), Ignition Switch, Auto Transmission Lever
MEMORY1	10A	Outside Mirror Folding/Unfolding Relay, Driver/Passenger Power Outside Mirror, Instrument Cluster, Air Conditioner Controller (LCD), Air Conditioner Control Module, Mood Lamp Unit, Console Mood Lamp, Mood Lamp (Passenger), Crash Pad Switch, Integrated Parking Assist Unit, Low Voltage DC-DC converter (450W)
TAILGATE OPEN	10A	Tailgate Relay
MODULE7	7.5A	BDC (Body Domain Controller)
BRAKE SWITCH	7.5A	Stop Lamp Switch, BDC (Body Domain Controller)
MULTIMEDIA	25A	Audio (Display), Audio/Video & Navigation Head Unit, Low Voltage DC-DC converter (200W)
WASHER	15A	Multifunction Switch
MODULE8	15A	Front Air Ventilation Seat Control Module, Front/Rear Seat Warmer Control Module, E/R Junction Block (Windshield Heated Relay LH)
AIRBAG1	10A	SRS (Supplemental Restraint System) Control Module
A/C2	7.5A	E/R Junction Block (PTC Heater Relay #1, Blower Relay), Air Conditioner Controller (LCD), Air Conditioner Control Module
MODULE2	10A	Front USB Charger Connector, Driver/Passenger Seat USB Port
MODULE6	7.5A	Console Switch, Drive Mode Switch, Data Link Connector, Auto Transmission Shift Lever Indicator
MODULE1	10A	Intergrated Parking Assist Unit, BDC (Body Domain Controller), Audio Keyboard, Audio/Video & Navigation Keyboard, Power Outside Mirror Switch, AMP (Amplifier), Audio (Display), Audio/Video & Navigation Head Unit, Low Voltage DC-DC converter
BDC (Body Domain Controller)1	10A	BDC (Body Domain Controller)
MODULE5	10A	Driver IMS (Integrated memory system) Control Module, Rear Seat Warmer Control Module, Front Air Ventilation Seat Control Module, AMP (Amplifier), Front Seat Warmer Control Module, Audio (Display), Audio/Video & Navigation Head Unit, Front Wireless Charger, Air Conditioner Controller (LCD), Air Conditioner Control Module, Electronic Chromic Mirror, Low Voltage DC-DC converter
MODULE4	10A	BDC (Body Domain Controller), Multifunction Front View Camera, Crash Pad Switch, Intergrated Parking Assist Unit, Front Corner Radar LH/RH, Clutch Module Cylinder Sensor, AWD (4-Wheel Drive) ECU (Electronic Control Unit), Head Lamp LH/RH, Rear Corner Radar LH/RH
E-SHIFTER3	7.5A	SCU (System Control Unit), Electronic Auto Transmission Shift Lever Switch
CLUSTER	7.5A	Instrument Cluster
MODULE3	10A	Stop Lamp Switch, Overhead Console Lamp
MDPS 2 ¹	7.5A	Motor Driven Power Steering Unit
START	7.5A	Burglar Alarm Horn Relay, Transaxle Range Switch, Power train Control Module, BDC (Body Domain Controller), Ignition Switch, E/R Junction Block (Start Relay)
E-SHIFTER 2	10A	CONSOLE UPPER EXTN(Shift By Wire), SCU
MODULE 9	10A	A/CON UNIT, HAZARD Switch, ICC UNIT

Fuse Name	Fuse Rating	Circuit Protected
MODULE 8	15A	POWER WINDOW MAIN Switch, O/S MIRROR DRV/PASS
TRAILER 2	30A	TRAILER (CTM2)
MODULE 11	10A	Active Air Flap (LOWER), VESS UNIT
wireless DCU	7.5A	DCU
TRAILER 3	20A	TRAILER (E-BRAKE)
MODULE 7	7.5A	P-LBM, Front Heated Relay (Coil)
MODULE 6	7.5A	BDC
BATTERY MANAGE- MENT	10A	BMS(HEV/PHEV)
CCU	10A	CCU
AMS 2	10A	Battery Sensor (PHEV Only)
BDC 1	10A	IGNITION Switch, BDC, BLE UNIT, UWB(FL/FR/RL/RR)
4WD	20A	4WD ECU
MODULE 10	10A	Rain Sensor, KEY Soleniod (non SMK), OBD
OBC	10A	OBC SIG (B+)
MEMORY 2	7.5A	CCNC KEYBOARD, CONSOLE TRAY EXTN(Wireless Charger)
MULTIMEDIA	25A	CCNC
MODULE 3	10A	ICC UNIT, POWER WINDOW MAIN Switch
USB CHARGER	15A	SEAT EXTN DRV/PASS, CONSOLE TRAY EXTN, CONSOLE POWER OUTLET
IG3 4	10A	CCU, Charge Door Module(PHEV only)
IG3 5	10A	CCNC(PHEV), A/CON UNIT(PHEV), HEV COMP SIG
IG3 6	10A	OBC SIG (IG3)

*1: MDPS (Motor Driven Power Steering) is the same as EPS (Electric Power Steering).

Engine compartment fuse panel



* NOTICE

This diagram will provide you with the specific information for your vehicles.

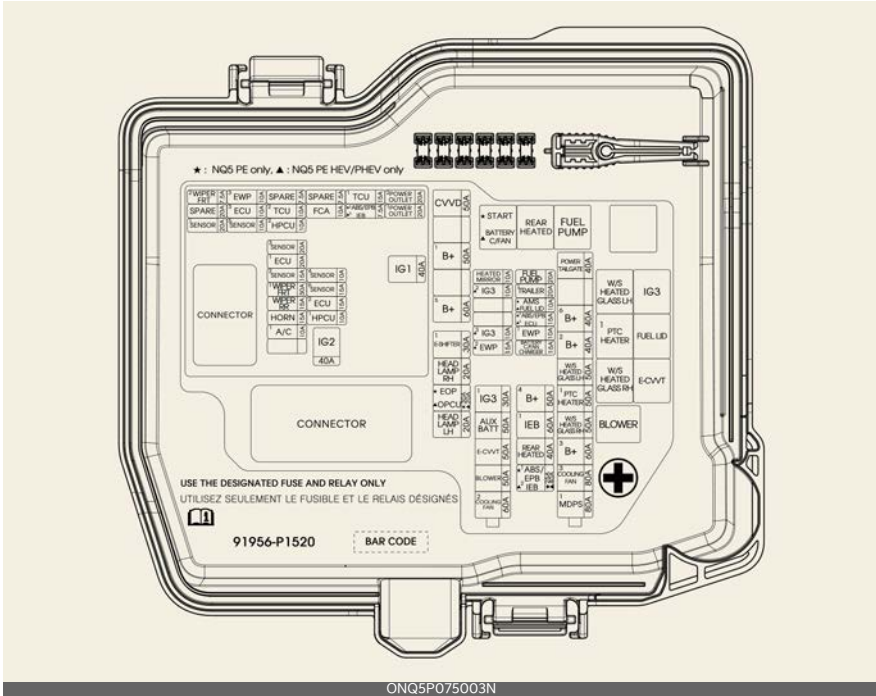

Engine Room Junction Block

	Fuse Name	Fuse Rating	Circuit Protected
MULTI FUSE-1	Motor Driven Power Steering ^{*1}	80A	Motor Driven Power Steering Unit
	B+3	60A	PDC Junction Block (Fuse - E-SHIFTER2, TRAILER2, P/SEAT(DRV), P/SEAT (PASS), S/HEATER FRT, S/HEATER RR, SUNROOF1, MODULE11, P/WINDOW LH, P/WINDOW RH, MODULE8, TRAILER3, WIRELESS DCU, MODULE9)
	W/S HEATED GLASS RH	50A	Windshield Heated Relay RH
	PTC HEATER1	50A	PTC Heater
	W/S HEATED GLASS LH	50A	Windshield Heated Relay LH
	B+2	40A	PDC Junction Block (IPS8/IPS9/IPS10/IPS11/IPS12)
	B+6	40A	PDC Junction Block (Fuse - AMP, MODULE10, AIR-BAG2)
	POWER TAILGATE	40A	Power Tailgate Open
MULTI FUSE-2	COOLING FAN2	60A	Cooling Fan Controller
	BLOWER	50A	Blower Relay
	E-CVVT	50A	E-CVVT Relay (Theta Engine)
	AUX BATT	50A	20AH Lithium Type Battery
FUSE	B+4	50A	PDC Junction Block (Fuse - MULTIMEDIA, MEMORY1, MEMORY2, CCU, BDC1, BRAKE SWITCH, SUNROOF2, 4WD, DOOR LOCK, TAILGATE OPEN)
	REAR HEATED	40A	Rear Heated Relay
	ABS1/EPB1	40A	ESP (Electronic Stability Program Control Module)
	B+1	50A	PDC Junction Block (IPS1/IPS2/IPS3/IPS4/IPS5/IPS6/IPS7)
	B+5	60A	PCB Block (Fuse - A/C1, HORN, IG1, IG2, Relay-MAIN, WIPER)
	E-SHIFTER1	30A	SCU (System Control Unit)
	HEAD LAMP RH	20A	Front Head Lamp RH
	EOP	30A	Electronic Oil Pump
	HEAD LAMP LH	20A	Front Head Lamp LH
	FUEL PUMP	20A	Fuel Pump Relay
	TRAILER1	50A	Trailer CTM2 type (w/ e-brake)
	ABS2/EPB2	15A	ESP (Electronic Stability Program Control Module)
	HEATED MIRROR	60A	ESP (Electronic Stability Program Control Module)

*1: MDPS (Motor Driven Power Steering) is the same as EPS (Electric Power Steering).

PCB Block

Fuse Name	Fuse Rating	Circuit Protected
IG2	40A	IG2 Relay
IG1	40A	IG1 Relay, ACC Relay
FR WIPER2	7.5A	Front Wiper (Low) Relay, BDC (Body Domain Controller)
SENSOR1	20A	Ignition Coil #1-#4
ECU3	10A	Power train Control Module
SENSOR5	10A	Fuel Pump Relay, Oil Level Sensor
TCU2	10A	Not Used
TCU3	10A	Not Used
SENSOR3	20A	Not Used
ECU1	20A	Power train Control Module
SENSOR2	15A	Oxygen Sensor (UP/DOWN)
FR WIPER1	30A	Wiper Main Relay, Front Wiper (Low) Relay
RR WIPER	15A	Wiper Main Relay, ICU Junction Block (Rear Wiper Relay)
HORN	15A	Horn Relay
A/C1	10A	Air Conditioner Comp Relay
FCA	10A	Front Radar
SENSOR4	10A	Oil Control Valve #2 (Exhaust), Purge Control Solenoid Valve, Variable Oil Pump Solenoid, Variable Intake Solenoid Valve, Cooling Fan Controller, Air Conditioner Comp Relay
SENSOR6	15A	Injector #1 ~ #4
ECU2	15A	Power train Control Module
TCU1	15A	Power train Control Module
ABS3/EPB3	7.5A	ESP (Electronic Stability Program (Electronic Stability Program) Control Module
POWER OUTLET2	20A	Front Power Outlet
POWER OUTLET1	20A	Luggage Power Outlet

Relay

Refer to the following table for the relay type.

Relay Name	TYPE
Rear Heated Relay	MICRO
Start Relay	MICRO
Fuel Pump Relay	MICRO
Windshield Heated Relay LH	MICRO
PTC Heater Relay #1	MICRO
Windshield Heated Relay RH	MICRO
E-CVVT Relay (Theta Engine)	MICRO
Blower Relay	MICRO

Engine compartment fuse panel (Battery terminal cover)



Light bulbs

Light bulbs are installed in various parts of the vehicle to provide lighting inside and outside the vehicle and to alert other vehicles.

Bulb replacement precaution

Please keep extra bulbs on hand with appropriate wattage ratings in case of emergencies.

Refer to "Bulb wattage" on page 10-4.

When changing lamps, first turn off the vehicle at a safe place, firmly apply the parking brake and detach the battery's negative (-) terminal.

⚠ WARNING

Working on the lights

Prior to start working on the light system, firmly apply the parking brake, ensure that turn the ENGINE START/STOP button and turn off the lights to avoid sudden movement of the vehicle and burning your fingers or receiving an electric shock.

Use only bulbs of the specified wattage.

⚠ CAUTION

Light replacement

Be sure to replace the burned-out bulb with one of the same wattage rating. It may cause damage to the fuse or electric wiring system.

Fully install light bulbs and any parts used to secure them. Failure to do so may result in heat damage, fire, or water entering the headlamp unit. This may damage the headlamps or cause condensation to build up on the lens. To prevent damage or fire, make sure bulbs are fully seated and locked.

⚠ CAUTION

Headlamp lens

To prevent damage, do not clean the headlamp lens with chemical solvents or strong detergents.

* NOTICE

- If the light bulb or lamp connector is removed while the lamp is still on, the fuse box's electronic system may log it as a malfunction. A lamp malfunction incident may be recorded as a Diagnostic Trouble Code (DTC) in the fuse box.
- It is normal for an operating lamp to flicker momentarily. This is due to a stabilization function of the vehicle's electronic control device. If the lamp lights up normally after momentarily blinking, then it is functioning as normal.

If the lamp continues to flicker several times or turns off completely, there may be an error in the vehicle's electronic control device. Please have the vehicle checked by an authorized Kia dealer immediately.

* NOTICE

Have the headlamp aiming adjusted by an authorized Kia dealer after an accident or after the headlamp assembly is reinstalled.

* NOTICE

You can find moisture inside the lens of lamps after a car wash or driving in the rain. It is a natural event caused by the temperature difference between the inside and the outside of the lamp and does not mean there is a problem with

its functions. The moisture inside the lamp will disappear if you drive the vehicle with the headlamp turned on. The level at which the moisture is removed may differ depending on the size/location/condition of the lamp. If moisture still remains inside the lamp, have the vehicle checked by an authorized Kia dealer.

If you don't have the necessary tools, the correct bulbs or the expertise, consult an authorized Kia dealer. In many cases, it is difficult to replace vehicle light bulbs because other parts of the vehicle must be removed before you can access the bulb. This is especially true if you must remove the headlamp assembly to access the bulb(s).

Removing/installing the headlamp assembly can result in damage to the vehicle. If non-genuine parts or standard bulbs are used, it may lead to blowing a fuse or other wiring damages. Kia Genuine Parts we guarantee for quality and performance.

Do not install extra lamps or LEDs in the vehicle. If additional lights are installed, it may lead to lamp malfunctions and flickering. The fuse box and other wiring may be damaged.

Light bulb position (Front)

Headlamp - Type A



Headlamp - Type B



- 1 Day time running lamp/Position lamp/ Front turn signal lamp/Front side marker lamp (LED type)
- 2 Headlamp (Low) (LED type)
- 3 Headlamp (High) (LED type)
- 4 Headlamp (High/Low) (LED type)
- 5 Front fog lamp (LED type)

Light bulb position (Rear)

Rear combination lamp



- 1 High mounted stop lamp (LED type)
- 2 Tail lamp and Stop lamp (LED type)
- 3 Rear turn signal lamp (LED type)
- 4 Rear side marker lamp (LED type)
- 5 Backup lamp (LED type)
- 6 License plate lamp (Bulb type)

Light bulb position (Side) (if equipped)



1. Side repeater lamp (LED type)

Replacing lights (LED type)

If the LED lamp is not functioning, please have your vehicle inspected by an authorized Kia dealer. The LED lamp cannot be replaced as an individual component since it is an integrated unit. Instead, the entire LED lamp unit must be replaced.

A skilled technician should check or repair the LED lamp, for it may damage related parts of the vehicle.

Replacing high mounted stop lamp (LED type)



If the high-mounted stop lamp (LED) is not functioning, please have your vehicle inspected by an authorized Kia dealer.

The LED lamp cannot be replaced as a single unit because it is an integrated component. Instead, the entire LED lamp unit must be replaced.

It's essential to have a skilled technician check or repair the high-mounted stop

lamp (LED) to prevent any damage to related vehicle parts.

Replacing license plate lamp (Bulb type)



1. Turn off vehicle and disconnect the negative terminal from the battery.
2. Using a flat-blade screwdriver, gently pry the lens cover from lamp housing.
3. Remove the bulb by pulling it straight out.
4. Install a new bulb in the socket.
5. Align the lens cover tabs with the lamp housing notches and snap the lens into place.

Replacing map lamp (Bulb type)



⚠ WARNING

Interior lamps

Prior to working on the Interior lamps, ensure that the "OFF" button is depressed to avoid burning your fingers or receiving an electric shock.

1. Turn off vehicle and disconnect the negative terminal from the battery.
2. Using a flat-blade screwdriver, gently pry the lens cover from lamp housing.

3. Remove the bulb by pulling it straight out.
4. Install a new bulb in the socket.
5. Align the lens cover tabs with the lamp housing notches and snap the lens into place.

⚠ CAUTION

Be careful not to dirty or damage the lens, lens tab, and plastic housings.

Replacing room lamp (Bulb type)



⚠ WARNING

Interior lamps

Prior to working on the Interior lamps, ensure that the "OFF" button is depressed to avoid burning your fingers or receiving an electric shock.

1. Turn off vehicle and disconnect the negative terminal from the battery.
2. Using a flat-blade screwdriver, gently pry the lens cover from lamp housing.
3. Remove the bulb by pulling it straight out.
4. Install a new bulb in the socket.
5. Align the lens cover tabs with the lamp housing notches and snap the lens into place.

⚠ CAUTION

Be careful not to dirty or damage the lens, lens tab, and plastic housings.

Replacing vanity mirror lamp (Bulb type)



⚠ WARNING

Interior lamps

Prior to working on the Interior lamps, ensure that the "OFF" button is depressed to avoid burning your fingers or receiving an electric shock.

1. Turn off vehicle and disconnect the negative terminal from the battery.
2. Using a flat-blade screwdriver, gently pry the lamp assembly from interior.
3. Remove the bulb by pulling it straight out.
4. Install a new bulb in the socket.
5. Install the lamp assembly to interior.

⚠ CAUTION

Be careful not to dirty or damage the lens, lens tab, and plastic housings.

Replacing glove box lamp (Bulb type)



⚠ WARNING

Interior lamps

Prior to working on the Interior lamps, ensure that the "OFF" button is depressed to avoid burning your fingers or receiving an electric shock.

1. Turn off vehicle and disconnect the negative terminal from the battery.
2. Using a flat-blade screwdriver, gently pry the lamp assembly from interior.
3. Remove the cover from the lamp assembly.
4. Remove the bulb by pulling it straight out.
5. Install a new bulb in the socket.
6. Install the cover to the lamp assembly.
7. Install the lamp assembly to interior.

⚠ CAUTION

Be careful not to dirty or damage the lens, lens tab, and plastic housings.

Replacing luggage lamp (Bulb type)



⚠ WARNING

Interior lamps

Prior to working on the Interior lamps, ensure that the "OFF" button is depressed to avoid burning your fingers or receiving an electric shock.

1. Turn off vehicle and disconnect the negative terminal from the battery.
2. Using a flat-blade screwdriver, gently pry the lamp assembly from interior.
3. Remove the cover from the lamp assembly.
4. Remove the bulb by pulling it straight out.
5. Install a new bulb in the socket.
6. Install the cover to the lamp assembly.
7. Install the lamp assembly to interior.

⚠ CAUTION

Be careful not to dirty or damage the lens, lens tab, and plastic housings.

Appearance care

Use the information in the following sections to keep the exterior and interior of your vehicle clean.

Exterior care

Use the information in the following sections to maintain the exterior of your vehicle. Keeping the exterior clean is not only aesthetically pleasing, but also helps to prolong the life of your vehicle.

* NOTICE

If parking the vehicle around a stainless signboard or glass building etc., the plastic exterior trim (bumper, spoiler, garnish, lamp, outside mirror etc.) may be damaged by reflected sunlight from the external structure. To avoid damaging the plastic exterior trim, park the vehicle away from areas where the reflected light may occur or use a vehicle cover. (Depending on the vehicle, the type of exterior trim applied, such as the spoiler, may differ.)

Exterior general caution

It is very important to follow the label directions when using any chemical cleaner or polish. Read all warning and caution statements that appear on the label.

Finish maintenance

Washing

To help protect your vehicle's finish from rust and deterioration, wash it thoroughly and frequently at least once a month with lukewarm or cold water.

If using your vehicle for off-road driving, you should wash it after each off-road

trip. Pay special attention to the removal of any accumulation of salt, dirt, mud, and other foreign materials. Make sure the drain holes in the lower edges of the doors and rocker panels are kept clear and clean.

Insects, tar, tree sap, bird droppings, industrial pollution and similar deposits can damage your vehicle's finish if not removed immediately.

Even prompt washing with plain water may not completely remove all these deposits. A mild soap, safe for use on painted surfaces, may be used.

After washing, rinse the vehicle thoroughly with lukewarm or cold water. Do not allow soap to dry on the finish.

After washing the vehicle, test the brakes while driving slowly to see if they have been affected by water. If braking performance is impaired, dry the brakes by applying them lightly while maintaining a slow forward speed.

⚠ CAUTION

- Do not use strong soap, chemical detergents or hot water, and do not wash the vehicle in direct sunlight or when the body of the vehicle is warm.
- Be careful when washing the side windows of your vehicle, especially with high-pressure water. Water may leak through the windows and wet the interior.
- To prevent damage to plastic parts and lamps, do not clean with chemical solvents or strong detergents.

⚠ WARNING

After washing the vehicle, test the brakes while driving slowly to see if they have been affected by water. If braking performance is impaired, dry the brakes

by applying them lightly while maintaining a slow forward speed.

High-pressure washing

When using high-pressure washers, make sure to maintain sufficient distance from the vehicle.

Insufficient clearance or excessive pressure can lead to component damage or water penetration.

Do not spray the camera, sensors or its surrounding area directly with a high-pressure washer. Shock applied from high pressure water may cause the device to not operate normally.

Do not bring the nozzle tip close to boots (rubber or plastic covers) or connectors as they may be damaged if they contact the high-pressure water.

⚠ WARNING

After washing the vehicle, test the brakes while driving slowly to see if they have been affected by water. If braking performance is impaired, dry the brakes by applying them lightly while maintaining a slow forward speed.

⚠ CAUTION

Wetting engine compartment



- Water washing in the engine compartment including high pressure water washing may cause the failure of electrical circuits located in the engine compartment.

- Never allow water or other liquids to contact electrical/electronic components and air duct inside the vehicle as this may damage them.
- After the vehicle has been washed, brake carefully while paying attention to the traffic conditions until the braking effect has been fully restored.

Waxing

Wax the vehicle when water will no longer bead on the paint.

Always wash and dry the vehicle before waxing. Use a good quality liquid or paste wax and follow the manufacturer's instructions. Wax all metal trim to protect it and to maintain its luster.

Removing oil, tar, and similar materials with a spot remover will usually strip the wax from the finish. Be sure to re-wax these areas even if the rest of the vehicle does not yet need waxing.

Be careful not to touch the lens when waxing the lamps.

⚠ CAUTION

Drying vehicle

- Wiping dust or dirt off the body with a dry cloth will scratch the finish.
- Do not use steel wool, abrasive cleaners, acid detergents or strong detergents containing high alkaline or caustic agents on chrome-plated or anodized aluminum parts. This may result in damage to the protective coating and cause discoloration or paint deterioration.

Finish damage repair

Deep scratches or stone chips in the painted surface must be repaired promptly. Exposed metal will quickly rust and may cause a major repair expense.

* NOTICE

If your vehicle is damaged and requires any metal repair or replacement, be sure the body shop applies anti-corrosion materials to the parts repaired or replaced.

Bright-metal maintenance

To remove road tar and insects, use a tar remover, not a scraper or other sharp object.

To protect the surfaces of bright metal parts from corrosion, apply a coating of wax or chrome preservative and rub to a high luster.

During winter weather or in coastal areas, cover the bright metal parts with a heavier coating of wax or preservative. If necessary, coat the parts with non-corrosive petroleum jelly or another protective compound.

Underbody maintenance

Road salt and other corrosive chemicals are used in cold weather areas to melt snow and prevent ice accumulation. If these chemicals are not regularly removed, they will corrode the vehicle underbody and, over time, damage many parts: the fuel lines, the fuel tank retention system, the vehicle's suspension, the exhaust system, and even the body frame.

The National Highway Traffic Safety Administration has warned all vehicle

owners of all brands of the need to take the following steps:

- Wash the undercarriage of your vehicle regularly during the winter and whenever your vehicle has been exposed to such salts or chemicals.
- Thoroughly wash the undercarriage at the end of the winter.
- Use professional service technicians or governmental inspection stations to annually inspect for corrosion.
- Immediately seek an inspection of your vehicle if you notice corrosion flaking, scaling or changes in vehicle performance, such as soft or spongy brakes, fluids leaking, impairment of directional control, suspension noises or rattling metal straps.

Aluminum wheel maintenance

The aluminum wheels are coated with a clear protective finish.

- Do not use an abrasive cleaner, polishing compound, solvent, or wire brushes on aluminum wheels. They may scratch or damage the finish.
- Clean the wheel when it has cooled.
- Use only a mild soap or neutral detergent, and rinse thoroughly with water. Also, be sure to clean the wheels after driving on salted roads. This helps prevent corrosion.
- Avoid washing the wheels with high-speed vehicle wash brushes.
- Do not use any alkaline or acid detergents. It may damage and corrode the aluminum wheels coated with a clear protective finish.

Corrosion protection

Protecting your vehicle from corrosion

Using the most advanced design and construction to combat corrosion, Kia produces vehicles of the highest quality. This is only part of the job. To achieve long-term corrosion resistance, the owner's assistance is also required.

Common causes of corrosion

The most common causes of corrosion on your vehicle are:

- Road salt, dirt and moisture that is allowed to accumulate underneath the vehicle.
- Removal of paint or protective coatings from stones, gravel, abrasions or minor scrapes and dents can leave unprotected metal exposed to corrosion.

High-corrosion areas

If you live in an area that is regularly exposed to corrosive materials, corrosion protection is particularly important. Some common causes of accelerated corrosion are road salts, dust control chemicals, ocean air and industrial pollution.

Moisture breeds corrosion

Moisture creates the conditions where corrosion is most likely to occur. Corrosion is accelerated by high humidity, particularly when temperatures are just above freezing. The corrosive material is kept in contact with the vehicle's surface by moisture that evaporates slowly.

Mud is particularly corrosive because it dries slowly and holds moisture in the

vehicle. Although the mud appears to be dry, it can still retain moisture and promote corrosion.

High temperatures can also accelerate corrosion of parts that are not properly ventilated so the moisture can be dispersed. It is particularly important to keep your vehicle clean and free of mud or accumulations of other materials. This applies not only to visible surfaces but also to the underside of the vehicle.

To help prevent corrosion

You can help prevent corrosion by observing the following:

Keep your vehicle clean

The best way to prevent corrosion is to keep your vehicle clean and free of corrosive materials. Attention to the underside of the vehicle is particularly important.

If you live in a high-corrosion area where road salts are used, near the ocean, areas with industrial pollution, acid rain, etc.—, you should take extra care to prevent corrosion. In winter, hose off the underside of your vehicle at least once a month and be sure to clean the underside thoroughly when winter is over.

When cleaning underneath the vehicle, pay particular attention to the components under the fenders and other areas that are hidden from view. Do a thorough job. Merely dampening the accumulated mud rather than washing it away will accelerate corrosion rather than prevent it. Water under high pressure and steam are particularly effective in removing accumulated mud and corrosive materials.

When cleaning lower door panels, rocker panels and frame members, be sure that

drain holes are kept open so that moisture can escape and not be trapped inside.

Keep your garage dry

Don't park your vehicle in a damp, poorly ventilated garage. This creates a favorable environment for corrosion. This is particularly true if you wash your vehicle in the garage or drive it into the garage when it is still wet or covered with snow, ice or mud. Even a heated garage can contribute to corrosion unless it is well ventilated.

Keep paint and trim in good condition

Scratches or chips in the finish should be covered with "touch-up" paint as soon as possible to reduce the possibility of corrosion. If bare metal is showing through, the attention of a qualified body and paint shop is recommended.

Bird droppings: Bird droppings are highly corrosive and may damage painted surfaces in just a few hours. Always remove bird droppings as soon as possible.

Don't neglect the interior

Moisture can collect under the floor mats and carpeting and cause corrosion. Check under the mats periodically to be sure the carpet is dry. Take particular care if you carry fertilizers, cleaning materials or chemicals in the vehicle.

These should be carried only in proper containers and any spills or leaks should be cleaned up, flushed with clean water and thoroughly dried.

Interior care

Use the information in the following sections to maintain the interior of your vehicle.

Interior general precautions

Prevent chemicals such as perfume, cosmetic oil, sun cream, hand cleaner, and air freshener from contacting interior parts because they may cause damage or discoloration. If they contact interior parts, wipe them off immediately. If necessary, use a mixture of warm water and mild non-detergent cleaner (test all cleaners on a concealed area before use). Use proper car cleaner to clean interior parts.

CAUTION

Electrical components

Never allow water or other liquids to contact electrical/electronic components inside the vehicle as this may damage them.

CAUTION

Leather

When cleaning leather products (steering wheel, seats etc.), use neutral detergents or low alcohol content solutions. If you use high alcohol content solutions or acid/alkaline detergents, the color of the leather may fade, or the surface may get stripped off.

Taking care of leather seats

- Vacuum the seat periodically to remove dust and sand from the seat. It will prevent abrasion or damage of the leather and maintain its quality.

- Wipe the leather seat cover often with dry or soft cloth.
- Use of a leather protective may prevent abrasion and help maintain the color. Be sure to read the instructions and consult a specialist when using leather coating or protective agents.
- Leather with bright colors (beige, cream) is easily contaminated and clear in appearance. Clean the seats frequently.
- Avoid wiping with wet cloth. It may cause the surface to crack.

Cleaning the leather products

Remove all contaminants instantly. If not, the color of the leather may fade or damage.

Refer to instructions below for removal of each contaminant.

- Cosmetic products (sunscreen, foundation, etc.)
 - Apply cleansing cream or leather cleaner on a cloth and wipe the contaminated point. Wipe off the cream or leather cleaner with a wet cloth and remove the water with a dry cloth.
- Beverages (coffee, soft drink, etc.)
 - Apply a small amount of neutral detergent and wipe until contaminants do not smear.
- Oil, blue jeans/clothes (Color transfer)
 - Remove oil/stain instantly with absorbable cloth and wipe with stain remover for leather only.
- Chewing gum
 - Harden the gum with ice and remove gradually.

Fabric seat cover (if equipped)

Clean the fabric seats regularly with a vacuum cleaner depending on the fabric material. If they are heavily soiled with beverage stains, etc., use a suitable interior cleaner. To prevent damage to seat covers, wipe off the seat covers down to the seams with a large wiping motion and moderate pressure using a soft sponge or microfiber cloth.

Velcro closures on clothing or sharp objects may cause snagging or scratches on the surface of the seats. Make sure not to rub such objects against the surface.

Cleaning the upholstery and interior trim

Car interior surfaces

Remove dust and loose dirt from interior surfaces with a whisk broom or a vacuum cleaner. If necessary, clean interior surfaces with a mixture of warm water and mild non-detergent cleaner (test all cleaners on a concealed area before use).

Fabric

Remove dust and loose dirt from fabric with a whisk broom or vacuum cleaner. Clean with a mild soap solution recommended for upholstery or carpets. Remove fresh spots immediately with a fabric spot cleaner. If fresh spots do not receive immediate attention, the fabric can be stained, and its color can be affected. Its fire-resistant properties can be reduced if the material is not properly maintained.

Using anything but recommended cleaners and procedures may affect the

fabric's appearance and fire-resistant properties.

Cleaning the lap/shoulder belt webbing

Clean the belt webbing with any mild soap solution recommended for cleaning upholstery or carpet. Follow the instructions provided with the soap. Do not bleach or re-dye the webbing because this may weaken it.

Cleaning the interior window glass

If the interior glass surfaces of the vehicle are covered with an oily, greasy or waxy film, they should be cleaned with a glass cleaner. Follow the directions on the glass cleaner container.

▲ CAUTION

Rear window

Do not scrape or scratch the inside of the rear window. This may result in damage to the rear window defroster grid.

Emission control system

The emission control system of your vehicle is covered by a limited warranty. See the warranty information contained in the Warranty & Consumer Information manual in your vehicle.

Your vehicle is equipped with an emission control system to meet all applicable emission regulations. There are three emission control systems, as follows.

1. Crankcase emission control system
2. Evaporative emission control system
3. Exhaust emission control system

To ensure the proper function of the emission control systems, it is recommended that you have your vehicle inspected and maintained by an authorized Kia dealer in accordance with the maintenance schedule in this manual.

Caution for the Inspection and Maintenance Test (With Electronic Stability Control (ESC) system)

- **To prevent the vehicle from misfiring during dynamometer testing, turn the ESC off by pressing the ESC switch.**
- **After dynamometer testing is completed, turn the ESC back on by pressing the ESC switch again.**

1. Crankcase emission control system

The Positive Crankcase Ventilation system prevents air pollution caused by blow-by gases being emitted from the crankcase. This system supplies fresh filtered air to the crankcase through the air intake hose. Inside the crankcase, fresh air mixes with blow-by gases,

which then pass through the Positive Crankcase Ventilation (PCV) valve into the induction system.

2. Evaporative emission control (including Onboard Refueling Vapor Recovery (ORVR)) system

The evaporative emission control system is designed to prevent fuel vapors from escaping into the atmosphere. (The ORVR system is designed to allow the vapors from the fuel tank to be loaded into a canister while refueling at the gas station, preventing the escape of fuel vapors into the atmosphere.)

Canister

Fuel vapors generated inside the fuel tank are absorbed and stored in the onboard canister. When the engine is running, the fuel vapors absorbed in the canister are drawn into the surge tank through the Purge Control Solenoid Valve (PCSV).

PCSV

The PCSV is controlled by the Engine Control Module (ECM) when the engine coolant temperature is low during idling. The PCSV closes so that evaporated fuel is not brought into the engine. After the engine warms up during ordinary driving, the PCSV opens to introduce evaporated fuel to the engine.

3. Exhaust emission control system

The exhaust emission control system is a highly effective system which controls exhaust emissions while maintaining good vehicle performance.

Vehicle modifications

This vehicle should not be modified. Modification of your vehicle could affect its performance, safety or durability and may violate governmental safety and emissions regulations.

* NOTICE

Damage or performance problems resulting from any modification may not be covered under the warranty.

▲ CAUTION

If you use unauthorized electronic devices, it may cause the vehicle to operate abnormally, wire damage, battery discharge and fire. Do not use unauthorized electronic devices.

Engine exhaust gas precautions (carbon monoxide (CO))

- CO can be present with other exhaust fumes. If you smell exhaust fumes inside your vehicle, have it inspected and repaired immediately. If you suspect exhaust fumes entering your vehicle, drive it only with all the windows fully open. Have your vehicle checked and repaired immediately.

▲ WARNING

Exhaust

Engine exhaust gases contain carbon monoxide (CO). Though colorless and odorless, it is dangerous and could be lethal if inhaled. Follow the instructions on this page to avoid CO poisoning.

- Do not operate the engine in confined or closed areas (such as garages) any more than necessary to move the vehicle in or out of the area.

- When the vehicle is stopped in an open area for more than a short time with the engine running, adjust the ventilation system to draw outside air into the vehicle.
- Never sit in a parked or stopped vehicle for an extended time with the engine running.
- When the engine stalls or fails to start, repeated attempts to restart the engine may cause damage to the emission control system.
- Use only UNLEADED FUEL for gasoline engines.
- Do not operate the vehicle when there are signs of engine malfunction, such as misfire or a noticeable loss of performance.
- Do not misuse or abuse the engine. Examples of misuse are coasting with the ignition off or descending steep grades in gear with the ignition off.
- Do not operate the engine at high idle speed for extended periods (5 minutes or more).

WARNING

Catalytic converter

Keep away from the catalytic converter and exhaust system while the vehicle is running or immediately after. The exhaust and catalytic systems are very hot and may burn you.

Operating precautions for catalytic converters

WARNING

Fire

- Do not park, idle or drive the vehicle over or near flammable objects, such as grass, vegetation, paper, leaves, etc. A hot exhaust system can ignite flammable items under your vehicle.
- Do not remove the heat sink around the exhaust system. Do not seal the bottom of the vehicle. Do not coat the vehicle for corrosion control. It may present a fire risk under certain conditions.

Your vehicle is equipped with a catalytic converter emission control device.

The following precautions must be observed:

- Do not modify or tamper with any part of the engine or emission control system. All inspections and adjustments must be made by an authorized Kia dealer.
- Avoid driving with an extremely low fuel level. Running out of fuel could cause the engine to misfire, damaging the catalytic converter.

Failure to observe these precautions could result in damage to the catalytic converter and your vehicle. Such actions could void your warranties.

Procedure for entering forced engine activation mode

If the engine needs to be kept running while the vehicle is stopped to inspect emission gas or perform vehicle maintenance, follow this procedure to enter forced engine activation mode:

1. Place the shift dial in P (Park) position with the vehicle stopped. Engage the parking brake. Then, follow steps (1) to (5).

These steps must be completed within 60 seconds. If not, the process is reset, and you must restart from step (1).

- 1) Turn the ignition switch to the ON position. For vehicles equipped with a smart key, press the ENGINE START/STOP button twice without depressing the brake pedal.
 - 2) Place the shift dial in P (Park) position and depress the accelerator pedal twice.
 - 3) Place the shift dial in N (Neutral) position and depress the accelerator pedal twice.
 - 4) Place the shift dial in P (Park) position and depress the accelerator pedal twice.
 - 5) With the brake pedal depressed, start the engine, and maintain idling state. The engine remains in an idle state and the forced engine activation mode is maintained even when the gear is shifted to a different position.
2. **(READY)** indicator on the instrument cluster blinks when the vehicle is in forced engine activation mode. Check the **(READY)** indicator blinking to ensure that the forced engine activation mode is correctly entered.
- The **(READY)** indicator continues blinking until the forced engine activation mode is canceled. When the mode is canceled the **(READY)** indicator will stop blinking.
3. To cancel the forced engine activation mode, turn the vehicle off.

California perchlorate notice

Perchlorate Material-special handling may apply, See <https://dtsc.ca.gov/perchlorate>

Notice to California Vehicle Dismantlers: Perchlorate containing materials, such as air bag inflators, seatbelt pre-tensioners and keyless remote entry batteries, must be disposed of according to Title 22 California Code of Regulations Section 67384.10 (a).

Specifications, Consumer information and Reporting safety defects

Dimensions	10-2
Engine	10-3
Gross vehicle weight	10-3
Reference weight and distance when towing a trailer	10-3
Luggage volume	10-3
Air conditioning system.....	10-3
Bulb wattage	10-4
Tires and wheels	10-5
Recommended lubricants and capacities	10-6
• Recommended SAE viscosity number.....	10-7
Vehicle Identification Number (VIN).....	10-8
Vehicle certification label.....	10-8
Tire specification and pressure label.....	10-8
Engine number.....	10-9
Air conditioner compressor label	10-9
Refrigerant label.....	10-9
How to check the symbol on the charging label.....	10-10
Consumer Assistance (U.S. only).....	10-11
Electrical Equipment (U.S. only)	10-13
Reporting Safety Defects (U.S. only)	10-14
Online factory authorized manuals (U.S. only)	10-14

Specifications, Consumer information and Reporting safety defects

Dimensions

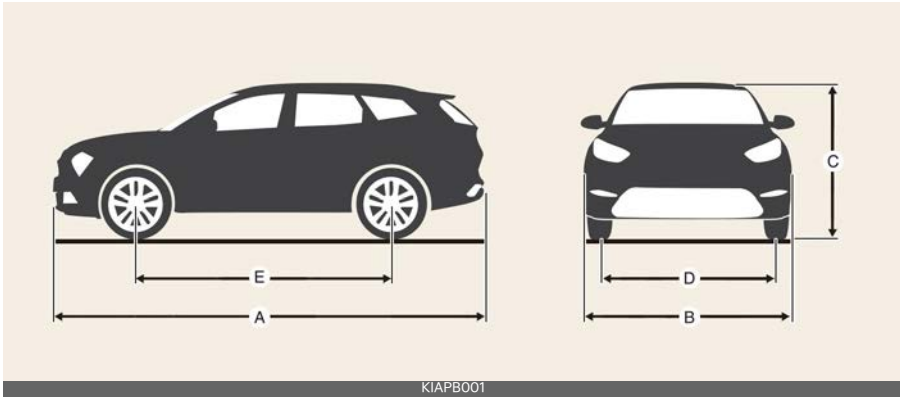

Item		in (mm)		
		FWD	AWD	
A	Overall length	184.4 (4,685)		
B	Overall width	73.4 (1,865)		
C	Overall height	Without Roof rack	65.4 (1,660)	66.1 (1,678)
		With Roof rack	65.6 (1,665)	66.3 (1,683)
		With Roof rack (X-Line)	-	66.9 (1,698)
D	Front	235/65 R17	63.8 (1,620)	
		235/60 R18	63.6 (1,615)	
		235/55 R19		
	Rear	235/65 R17	64.1 (1,627)	
		235/60 R18	63.9 (1,622)	
		235/55 R19		
E	Wheelbase	108.5 (2,755)		

Engine

Item	Smartstream G1.6 T-GDi HEV/PHEV
Displacement [cc (cu in)]	1,598 (97.5)
Bore x Stroke [mm (in)]	75.6 x 89.0 (2.98 x 3.50)
Firing order	1-3-4-2
No. of cylinders	4 (inline)

Gross vehicle weight

Item			Gross vehicle weight [lbs. (kg)]
Smartstream G1.6 T-GDi HEV	2WD	AT	4,982 (2,260)
	AWD		5,092 (2,310)
Smartstream G1.6 T-GDi PHEV	AWD	AT	5,379 (2,440)

Reference weight and distance when towing a trailer

Item		Smartstream G1.6 T-GDi HEV/PHEV
		AT
Maximum trailer weight	With brake system	2,000 lbs. (907 kg)
	Without brake system	1,653 lbs. (750 kg)
Maximum tongue weight		220 lbs. (100 kg)

Luggage volume

- Min: Behind rear seat
- Max: Behind front seat

Item			Smartstream G1.6 T-GDi HEV	Smartstream G1.6 T-GDi PHEV
Luggage volume (SAE) [cu ft (L)]	Dual level luggage floor high	MIN.	34.5 (977)	34.5 (977)
		MAX.	65.4 (1,853)	65.5 (1,854)
	Dual level luggage floor low *only for TMK, temporary tire	MIN.	39.5 (1,119)	-
		MAX.	73.7 (2,088)	

Air conditioning system

Item		Weight of volume (g)	Classification
Refrigerant	HEV	600±25	R-1234yf
	PHEV		
Compressor lubricant		150±10	POE

Please contact a professional workshop for more details.
Contact an authorized Kia dealer.

Bulb wattage

Light bulb		Bulb type	Wattage (Watt)	
Front	High beam	LED	LED	
	Low beam	LED	LED	
	Position and daytime running lamps	LED	LED	
	Front fog lamps*	LED	LED	
	Turn signal lamps	Type A	PY28/8W	28/8
		Type B	LED	LED
Side marker	LED	LED		
Side	Side repeater lamps	LED	LED	
Rear	Stop lamps	Type A	P28/8W	28/8
		Type B	LED	LED
	Tail lamps	LED	LED	
	Turn signal lamps	Type A	PY27W	27
		Type B	LED	LED
	Backup lamps	LED	LED	
	High mounted stop lamp	LED	LED	
	License plate lamps	W5W	5	
Side marker	LED	LED		
Interior	Map lamps	Type A	WEDGE (W10W)	10
		Type B	LED	LED
	Room lamps	FESTOON	10	
	Personal lamps*	LED	LED	
	Vanity mirror lamps*	FESTOON	5	
	Glove box lamp	W5W	5	
	Luggage lamp	Type A	FESTOON	10
Type B		LED	LED	

* : if equipped

Tires and wheels

For hybrid vehicle

Item	Tire size	Wheel size	Load capacity		Speed capacity		Inflation pressure [psi (bar, kPa)]				Wheel lug nut torque lb-ft (kgf·m, N·m)
			L ¹	lbs. (kg)	SS ²	km/h	Normal load		Maximum load		
							Front	Rear	Front	Rear	
Full size tire	235/65 R17	7.0J X 17	104	2,000 (900)	H	130 (210)	35 (2.4, 240)				79-94 (11-13, 107-127)
	235/60 R18	7.5J X 18	103	1,930 (875)							
	235/55 R19	7.5 J x 19	101	1,820 (825)	H	130 (210)					
Compact spare tire (steel wheel) ³	T135/90D17	4B X 17	104	2,000 (900)	M	80 (130)	60 (4.2, 420)				

For plug-in hybrid vehicle

Item	Tire size	Wheel size	Load capacity		Speed capacity		Inflation pressure [psi (bar, kPa)]				Wheel lug nut torque lb-ft (kgf·m, N·m)
			L ¹	lbs. (kg)	SS ²	km/h	Normal load		Maximum load		
							Front	Rear	Front	Rear	
Full size tire	235/55 R19	7.5J X 19	101	1,820 (825)	H	130 (210)	35 (2.4, 240)				79-94 (11-13, 107-127)
					V	150 (240)					
Compact spare tire (steel wheel) ³	T135/90D17	4B X 17	104	2,000 (900)	M	80 (130)	60 (4.2, 420)				

* 1. Load Index

* 2. Speed Symbol

* 3. If equipped

CAUTION

When replacing tires, use the same size originally supplied with the vehicle. Using tires of a different size can damage the related parts or make it work irregularly.

NOTICE

- We recommend that when replacing tires, use the same originally supplied with the vehicles.
If not, that affects driving performance.
- When driving in high altitude grades, it is natural for the atmospheric pressure to decrease.
Therefore, please check the tire pressure and add more air when necessary.
Additionally required tire air pressure per km above sea level: 1.5 psi (10.5 kPa)/km

Recommended lubricants and capacities

To help achieve proper engine and powertrain performance and durability, use only lubricants of the proper quality.

The correct lubricants also help promote engine efficiency that results in improved fuel economy.

These lubricants and fluids are recommended for use in your vehicle.

Lubricant		Volume	Classification
Engine oil (drain and refill) ¹ Recommends Kia  TotalEnergies	Smart stream G1.6 T-GDi HEV/PHEV	5.07 US qt. (4.8 L)	Full synthetic SAE 0W-20, API SN PLUS/SP or ILSAC GF-6
Automatic transmission (AT) fluid ²		6.34 US qt. (6 L)	SK ATF SP4M-1, MICHANG ATF SP4M-1, S-OIL ATF SP4M-1, Kia Genuine ATF SP4M-1
Coolant (Engine) ³		8.56 US qt. (8.1 L)	A Phosphate based ethylene glycol based coolant
Coolant (Inverter) ³	HEV	1.8 US qt. (1.7 L)	A Phosphate based ethylene glycol based coolant
	PHEV	6.76 US qt. (6.4 L)	Contact an authorized Kia dealer
Brake fluid		As required	DOT 4
Transfer case oil (AWD)		0.65-0.71 US qt. (0.62-0.68 L)	HYPOID GEAR OIL API GL-5, SAE 75W/85 (Recommended: SK HCT-5 GEAR OIL 75W/85 or equivalent)
Differential oil (Rear) (AWD)		0.56-0.67 US qt. (0.53-0.63 L)	
Fuel	HEV	13.7 US gal (52 L)	Gasoline
	PHEV	11.1 US gal (42 L)	

*1. Refer to "Recommended SAE viscosity number" on page 10-7.

*2. Use only specified genuine automatic transmission fluid. The use of non-specified (even marked as compatible with genuine) could result in shift quality deterioration and vibrations, eventually, the transmission failure. (Refer to "Explanation of scheduled maintenance items" on page 9-13)

*3. Different type of coolant or water may damage the electrical component.

Recommended SAE viscosity number

⚠ CAUTION

Always be sure to clean the area around any filler plug, drain plug, or dipstick before checking or draining any lubricant. This is especially important in dusty or sandy areas or when the vehicle is used on unpaved roads. Cleaning the plug and dipstick areas will prevent dirt and grit from entering the engine and other mechanisms that could be damaged.

Engine oil viscosity (thickness) influences fuel economy and cold weather operating (engine start and engine oil flow ability). Lower viscosity engine oils can provide better fuel economy and cold weather performance. Higher viscosity engine oils are required for satisfactory lubrication in hot weather.

Using oils of any viscosity other than those recommended could result in engine damage.

* NOTICE

Never add additives to the engine oil. Engine oil additives can change its properties of engine oil and may cause serious engine failure.

When choosing an oil, consider the range of temperatures your vehicle will be operated in before the next oil change. Select the recommended oil viscosity from the chart.

Temperature Range for SAE Viscosity Numbers

A: Smartstream G1.6 T-GDi

TEMP.	°C	-30	-20	-10	0	10	20	30	40	50
	°F	-10	0	20	40	60	80	100	120	
A					0W-20					



An engine oil displaying this American Petroleum Institute (API) Certification Mark conforms to the International Lubricant Specification Advisory Committee (ILSAC). It is recommended to only use engine oils that uphold this API Certification Mark.

Vehicle Identification Number (VIN)

The VIN is the number used in registering your vehicle and in all legal matters pertaining to its ownership, etc.

VIN cover (if equipped)



The number is punched on the floor under the front right side seat. To check the number, open the cover.

VIN label



The VIN is also on a plate attached to the top of the dashboard. The number on the plate can easily be seen through the windshield from outside.

Vehicle certification label



The vehicle certification label attached on the driver's side center pillar shows the VIN.

Tire specification and pressure label



The tires supplied on your new vehicle are chosen to provide the best performance for normal driving.

The tire label located on the driver's side center pillar gives the tire pressures recommended for your vehicle.

Engine number

The engine number is stamped on the engine block as shown in the drawing.



Air conditioner compressor label



A compressor label informs you the type of compressor your vehicle is equipped with such as model, supplier part number, production number, refrigerant (1) and refrigerant oil (2).

Refrigerant label



The refrigerant label is located as shown. The label contains the following information:

- Type of refrigerant
- Amount of refrigerant

* For more details, refer to "Air conditioning refrigerant label" on page 5-115.

How to check the symbol on the charging label (if equipped)

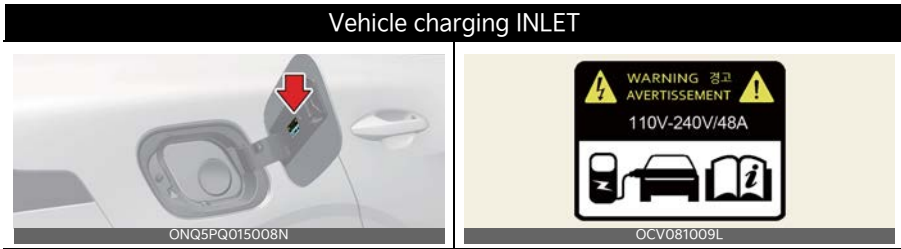

Precautions for charging AC and Portable charger

1. After opening the charging door, check the charging voltage and current at the middle of the warning label.
2. After checking charging voltage and current, proceed the charging step.
3. Risk of failure, fire, injury, etc. expected when using the charging connector with unmatched charging voltage or current.

Electric charging label



The electric charging label is attached on the charging door.

- 1 ~ 2: Warning for high voltage
- 3: Charging voltage and current
- 4: Identifier for charging door.

Consumer Assistance (U.S. only)

Roadside Assistance is provided on all new current model year Kia Vehicles from the date the vehicle is delivered to the first retail buyer or otherwise put into use (inservice date), whichever is earlier, for a period of 60 months or 60,000 miles, whichever is earlier, subject to the terms, conditions and exclusions set forth in the Kia Warranty and Consumer Information Manual applicable to your model year vehicle.

Kia America, Inc. reserves the right to limit or deny services or other benefits to any owner or driver when, in Kia America, Inc.'s judgment, the claims and/or service requests are excessive in frequency or type of occurrence.

Toll free consumer assistance

is available from 5:00 AM to 6:00 PM PST, Monday through Friday and is accessible by dialing 1-800-333-4542. For more information regarding assistance available, please refer to your Kia Warranty & Consumer Information Manual.

Emergency roadside assistance

is available 24 hours a day, 365 days a year and is accessible by dialing 1-800-333-4542 or by pressing the Roadside Assistance (RSA) button (when enrolled into Kia Connect).

Please note that you must provide your VIN to verify coverage at the time of your call. The VIN can be found on the dash of your vehicle on the driver's side, on the door jamb of the driver's door, your vehicle's registration or proof of insurance card.

Kia utilizes a network of over 30,000 RSA providers. Should you accidentally run out of fuel, require a battery jump, or need help changing a tire, a Kia RSA Representative will dispatch someone to deliver a small quantity of gas, change a flat tire with your inflated spare, or arrange a battery jump to allow you to proceed to your destination. We have access to a network of over 10,000 locksmiths should you become locked out of your Kia.

If mechanical difficulty renders your vehicle undriveable due to a warranty-related concern, Kia's RSA Representative will arrange to transport your vehicle to the nearest Kia dealer or to an authorized Kia alternative service location.

Your vehicle must be accessible to our dispatch transport vehicle, as determined by our driver, to receive this service.

* NOTICE

RSA benefits are not available for any Kia vehicle that has ever been or should have been issued a "salvage" title or similar "branded" title under any state's law or has been declared a "total loss" or equivalent by a financial institution or insurance company.

Trip interruption

Trip interruption expense benefits are provided if a warranty-related disablement occurs more than 150 miles from your home and the repairs require more than 24 hours to complete. Reasonable reimbursement is included for meals, lodging or rental vehicle expenses. Trip interruption coverage is limited to \$100 per day subject to a three day maximum limit per incident. You must contact the

Kia RSA Center to obtain pre-authorization of expenses. Once the Kia RSA Center gives authorization for trip interruption benefits, they will assist you in making the necessary arrangements. Insurance deductibles, expenses, and claims paid by your insurance company or other providers are not eligible for reimbursement.

Fleet vehicles are excluded from reimbursement under Kia's Trip Interruption Policy.

Registering your vehicle in a foreign country

If you plan to register your vehicle in a foreign country, you should confirm that it conforms to the regulations in that country. Even if you successfully register the vehicle in a foreign country, you may experience the following problems and should therefore consider the possibility of having to deal with them:

1. The fuel specified for your vehicle may be unavailable. If other than the specified fuel is used, it could cause damage to the engine, the fuel injection system, and other fuel-related parts which may not be covered under your New Vehicle Emissions Limited Warranty.
2. When you leave the country in which you purchased your new Kia and register it in another country, problems arising from the use of fuel other than the specified fuel are not covered by your warranty. Because vehicles like yours may not be marketed in the country of registration, parts, servicing techniques and tools necessary to maintain and repair your vehicle may be unavailable.

Even if vehicles like yours are sold there, mechanical specifications required by the government may vary enough from the country of purchase to cause additional problems.

3. There may not be an Authorized Kia Dealer in the country in which you plan to register your vehicle. You may experience difficulty in obtaining services in a foreign country for any number of reasons.

We cannot assume any responsibility for problems that result from unsatisfactory service or lack of service outside of the United States.

Electrical Equipment (U.S. only)

The electrical system of your vehicle is designed to perform under all reasonably expected operating conditions.

Before any additional electrical equipment is installed in your vehicle, consult an Authorized Kia Dealer so that you do not void your warranty.

Certain electrical equipment, or the way in which it is installed, may adversely affect the operation of your vehicle, including such systems as the engine control system, the audio system and the electrical charging system. This could void all or part of your warranty.

We assume no responsibility for any expense you may incur or for any malfunction of your vehicle or any of its components or systems that may result from the installation of additional electrical equipment that is not supplied, or recommended for installation by, Kia.

Installation of a mobile two-way radio system

If a mobile two-way radio system is installed improperly, or if an excessively powerful type of system is used, other electronic systems may be adversely affected. To avoid damage to your vehicle, consult an Authorized Kia Dealer concerning proper equipment and installation.

Kia vehicles are designed and manufactured to meet or exceed all applicable FMVSS.

We strongly urge you to read and follow all directions in this Owner's Manual, particularly the information under the headings "NOTICE", "CAUTION" and "WARNING".

If, after reading this manual, you have any questions regarding the operation of your vehicle, safety issues or defects, please contact your Kia's toll-free Consumer Assistance hot line as below:

National Consumer Affairs Manager

Kia America, Inc.

P.O. Box 52410

Irvine, CA 92619-2410

1-800-333-4542

Reporting Safety Defects (U.S. only)

If you believe that your vehicle has a defect which could cause a crash or could cause injury or death, you should immediately inform the National Highway Traffic Safety Administration (NHTSA) in addition to notifying Kia America, Inc.

If NHTSA receives similar complaints, it may open an investigation, and if it finds that a safety defect exists in a group of vehicles, it may order a recall and remedy campaign. However, NHTSA cannot become involved in individual problems between you, your dealer, or Kia America, Inc.

To contact NHTSA, you may call the Vehicle Safety Hotline toll-free at 1-888-327-4236 (TTY: 1-888-275-9171); go to <http://www.NHTSA.gov>; download the SaferCar mobile application; or write to: Administrator, NHTSA, 1200 New Jersey Ave, SE., West Building, Washington, DC 20590. You can also obtain other information about motor vehicle safety from <http://www.NHTSA.gov>.

Online factory authorized manuals (U.S. only)

The following publications are available on www.KiaTechinfo.com.

Service manual

This manual covers maintenance and recommended procedures for repair to engine and chassis components. It is written for the Journeyman mechanic, but is simple enough for most mechanically inclined owners to understand.

Electrical troubleshooting manual

This manual complements the Service Manual by providing in-depth troubleshooting information for each electrical circuit in your vehicle.

Owner's manual

This manual describes the overall features and operating procedures for the vehicle.

Abbreviation **A**

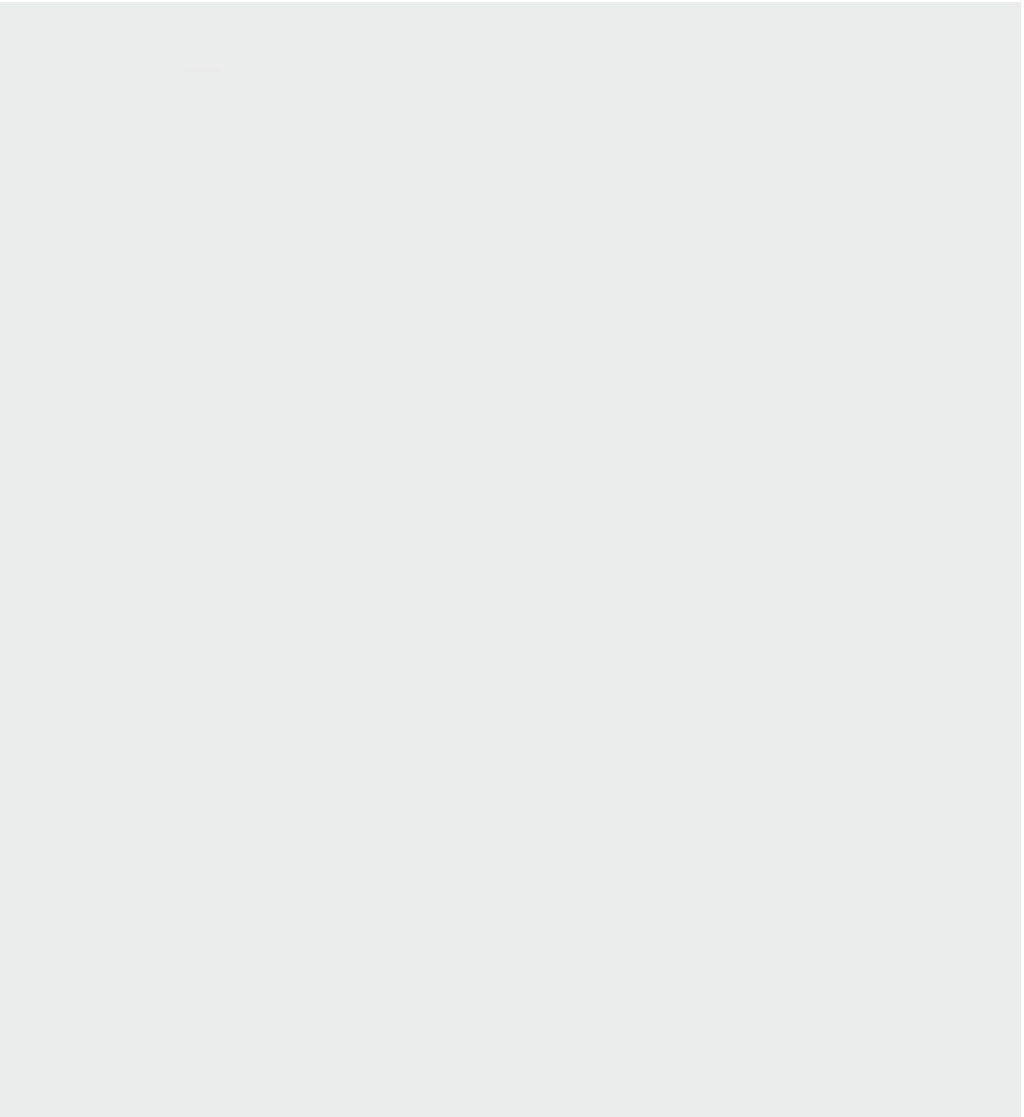

Abbreviation

ABS

Anti-lock Brake System

ACC

Accessory

ACU

Air bag Control Unit

ALR

Automatic Locking Retractor

BAS

Brake Assistant System

BCA

Blind-Spot Collision-Avoidance Assist

BCW

Blind-Spot Collision Warning

BVM

Blind-Spot View Monitor

CC

Cruise Control

CD

Charge Depleting

CRS

Child Restraint System

CS

Charge Sustaining

CSC

Crosswind Stability Control

DAW

Driver Attention Warning

DBC

Downhill Brake Control

DCM

Digital Center Mirror

DCT

Dual Clutch Transmission

DPF

Diesel Particulate Filter

DRL

Daytime Running Light

DRVM

Driving Rear View Monitor

EBD

Electronic Brake force Distribution

ECM

Electronic Chromic Mirror

ELR

Emergency Locking Retractor

EPB

Electronic Parking Brake

ESC

Electronic Stability Control

ESS

Emergency Stop Signal

ETCS

Electronic Toll Collection System

FAW

Forward Attention Warning

FCA

Forward Collision-Avoidance Assist

Abbreviation

HAC

Hill-start Assist Control

HBA

High Beam Assist

HDA

Highway Driving Assist

HID

High-Intensity Discharge

HMSL

High Mounted Stop Lamp

HUD

Head-Up Display

IC/JC

Interchange/Junction

ICCB

In-Cable Control Box

ISG

Idle Stop and Go

ISLA

Intelligent Speed Limit Assist

LATCH

Lower Anchors and Tether for Children

LFA

Lane Following Assist

LKA

Lane Keeping Assist

MCB

Multi-Collision Brake

MDPS

Motor Driven Power Steering

MIL

Malfunction Indicator Lamp

MSLA

Manual Speed Limit Assist

NFC

Near Field Communication

NSCC

Navigation-based Smart Cruise Control

ODS

Occupant Detection System

PCA-R

Reverse Parking Collision-Avoidance Assist

PCA-F/R

Forward/Reverse Parking Collision-Avoidance Assist

PCA-F/S/R

Forward/Side/Reverse Parking Collision-Avoidance Assist

PDW-R

Reverse Parking Distance Warning

PDW-F/R

Forward/Reverse Parking Distance Warning

PDW-F/S/R

Forward/Side/Reverse Parking Distance Warning

Abbreviation

RCCA

Rear Cross-Traffic Collision-Avoidance Assist

RCCW

Rear Cross-Traffic Collision Warning

RSPA

Remote Smart Parking Assist

RVM

Rear View Monitor

SBW

Shift-by-wire

SCC

Smart Cruise Control

SCR

Selective Catalytic Reduction

SEA

Safe Exit Assist

SEW

Safe Exit Warning

SRS

Supplemental Restraint System

SRSCM

SRS Control Module

SVM

Surround View Monitor

TBT

Turn By Turn

TCI

Turbo Charger Intercooler

TCS

Traction Control System

TIN

Tire Identification Number

T-GDI

Turbocharger Gasoline Direct Injection

TMK

Tire Mobility Kit

TPMS

Tire Pressure Monitoring System

TSA

Trailer Stability Assist

UWB

Ultra Wide Band

VIN

Vehicle Identification Number

VESS

Virtual Engine Sound System

VOCs

Volatile Organic Compounds

VSM

Vehicle Stability Management

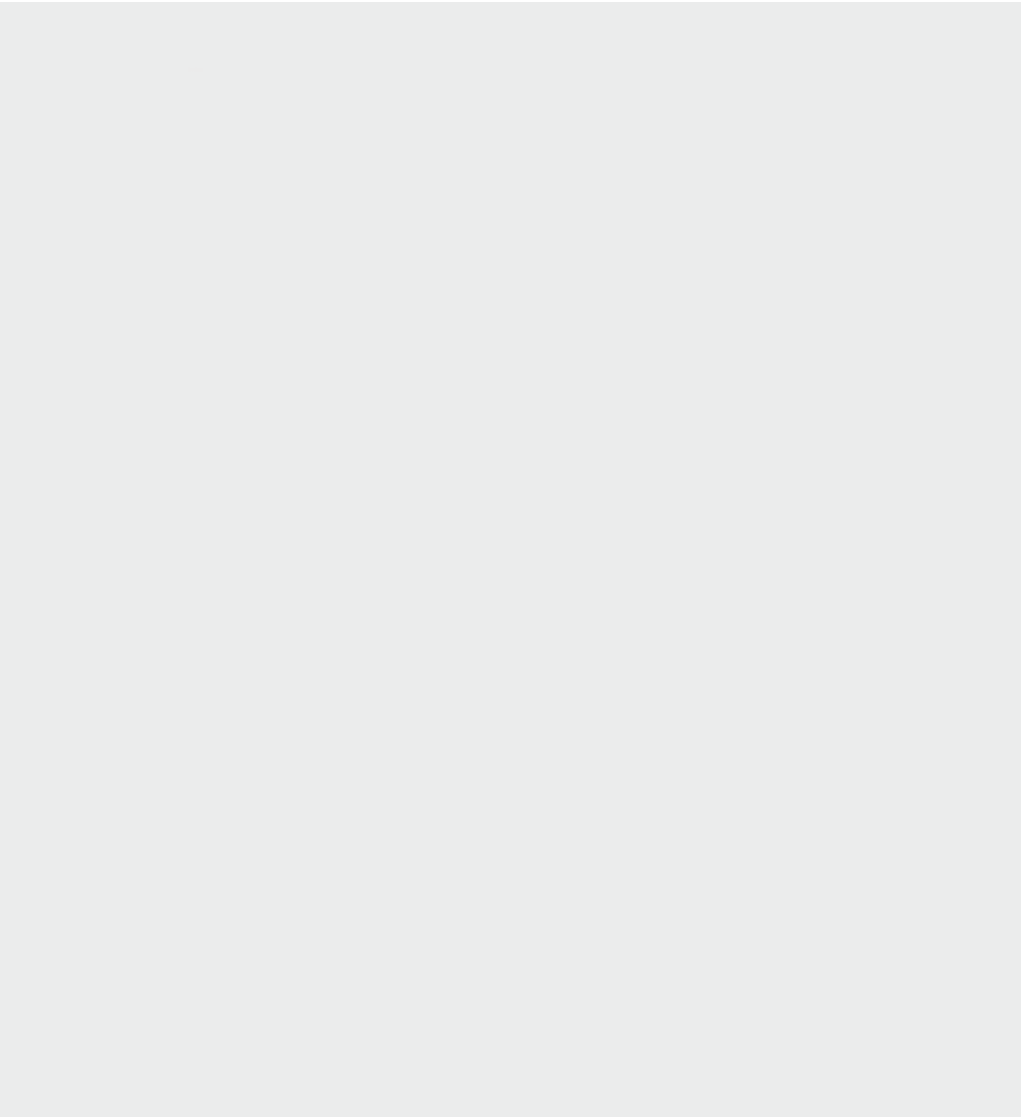

Index

A

AC charge	1-10
AC charging connector lock	1-7
accumulated driving information mode	5-91
active air flap	6-49
malfunction	6-49
air bag	
adding equipment to or modifying your air bag-equipped vehicle	4-55
additional safety precautions	4-54
air bag collision sensors	4-50
air bag warning labels	4-55
inflation conditions	4-51
non-inflation conditions	4-52
supplemental restraint system (SRS)	4-53
air bags	4-35
curtain air bag	4-49
driver's and passenger's front air bag	4-46
occupant detection system (ODS)	4-40
operation of the system	4-36
side air bag	4-47
SRS components and functions	4-38
warning light	4-38
air cleaner filter	9-23
air ventilation seat	5-131
all wheel drive (AWD) system	6-22
ambient light	5-129
appearance care	9-61
exterior care	9-61
interior care	9-65
armrest	4-14
audio system	5-145
radio	5-146
USB port	5-145
automatic climate control system	5-117
air conditioning	5-123
controlling air intake	5-122
controlling fan speed	5-123
heating and air conditioning automatically	5-118

heating and air conditioning manually	5-120
mode selection	5-121
temperature control	5-121
turning off the front air climate control	5-124
using the infotainment/climate switchable controller	5-118
automatic transmission	
LCD display messages	6-11
automatic transmission (dial SBW)	6-9
operation	6-9
AWD	
AWD mode	6-22
safe operation	6-25

B

battery	9-28
battery saver function	5-100
before driving	6-4
blind-spot collision-avoidance assist (BCA)	7-33
malfunction and limitations	7-38
operation	7-36
settings	7-34
brake fluid	9-21
brake system	6-30
anti-lock brake system (ABS)	6-38
auto hold	6-36
downhill brake control (DBC)	6-41
electronic parking brake (EPB)	6-32
electronic stability control (ESC)	
system	6-39
good braking practices	6-46
hill-start assist control (HAC)	6-44
power brakes	6-30
trailer stability assist (TSA)	6-46
vehicle stability management (VSM)	
system	6-45
bulb replacement precaution	9-56

C

california perchlorate notice	9-70
care of seat belts	4-26
center console storage	5-128

changing plug-in hybrid mode (plug-in hybrid vehicle)	1-25	consumer assistance	10-11
charging information	1-4	coolant	9-17
charging precautions	1-8	cup holder	5-129
charging status	1-6	curtain air bag	4-49
charging the plug-in hybrid vehicle	1-4		
AC charge	1-10		
AC charging connector lock	1-7		
charging information	1-4		
charging precautions	1-8		
charging status	1-6		
charging time	1-4		
charging type	1-5		
how to disconnect charging connector in emergency	1-24		
scheduled charging	1-7		
trickle charger (portable charging cable)	1-12, 1-17		
charging time	1-4		
charging type	1-5		
child restraint system (CRS)	4-27		
children always in the rear	4-27		
installing a CRS	4-30		
selecting a CRS	4-28		
types	4-29		
climate control air filter	9-24		
climate control system	5-113		
air conditioning	5-113		
air conditioning refrigerant label	5-115		
checking the amount of air conditioner refrigerant	5-115		
checking the amount of compressor lubricant	5-115		
climate control air filter	5-114		
heating	5-113		
system operation	5-113		
ventilation	5-113		
closing the hood	5-49		
coat hook	5-136		
components of the hybrid vehicle			
service interlock connector	1-43		
components of the hybrid/plug-in hybrid vehicle	1-39		
hybrid vehicle components	1-41		
if an accident occurs	1-44		
when the hybrid vehicle shuts off	1-44		
		D	
		day/night rear view mirror	5-62
		daytime running light (DRL)	5-101
		declaration of conformity	5-149
		defogging (windshield)	5-124
		defrosting (windshield)	5-124
		digital key 2	5-14
		card key	5-19
		personalized profile and vehicle settings	5-22
		smart phone	5-14
		used vehicle/digital key 2 maintenance	5-25
		door locks	5-26
		child-protector rear door lock	5-30
		door lock/unlock features	5-29
		from inside the vehicle	5-28
		rear occupant alert (ROA) system	5-31
		with the mechanical key	5-26
		with the smart key	5-26
		drive info display	5-90
		drive mode	6-48
		drive mode integrated control system	6-48
		drive mode	6-48
		driver attention warning (DAW)	7-53
		malfunction and limitations	7-55
		operation	7-54
		settings	7-53
		driver's and passenger's front air bag	4-46
		driving assist mode	5-90
		driving the hybrid/plug-in hybrid vehicle	1-24
		energy flow	1-35
		hybrid system gauge	1-27
		LCD display messages	1-28
		special features	1-25
		starting the vehicle	1-24
		warning and indicator lights	1-28

driving the plug-in hybrid vehicle
changing plug-in hybrid mode (plug-in hybrid vehicle) 1-25

E

economical operation 6-51
electrical equipment 10-13
electronic stability control (ESC) system 6-39
emergency 8-3
emergency while driving 8-3
engine doesn't turn over 8-4
engine stalls at a crossroad or crossing 8-3
engine will not start 8-4
flat tire while driving 8-3
flat tire (with spare tire) 8-13
flat tire (with tire mobility kit) 8-21
hazard warning flasher not start 8-4
road warning 8-3
turns over slowly 8-4
vehicle stalls while driving 8-3
emission control system 9-67
engine overheats 8-7
engine start/stop button 6-6
ENGINE START/STOP button position 6-6
Illuminated ENGINE START/STOP button 6-6
starting the engine 6-7
EV/HEV button 1-25
exterior features 5-139
roof rack 5-139

F

flat tire
removing and storing the spare tire 8-14
using of compact spare tire 8-18
flat tire (with spare tire) 8-13
flat tire (with tire mobility kit) 8-21
floor mat anchor(s) 5-137
forward collision-avoidance assist (FCA) - sensor fusion type 7-5
malfunction and limitations 7-20
operation 7-10

settings 7-8
forward/reverse parking distance warning (PDW) 7-115
malfunction and precautions 7-118
operation 7-116
settings 7-115
front glass heater 5-128
front seat adjustment for power seat 4-9
front seat headrest 4-11
fuel economy 5-92
fuel filler door 5-50
closing the fuel filler door 5-52
opening the fuel filler door 5-50
fuel gauge 5-77
fuel requirements 2-2
fuses 9-45
driver's side fuse panel 9-49
engine compartment fuse replacement 9-48
inner panel fuse replacement 9-47

G

gauges 5-75
distance to empty 5-78
fuel gauge 5-77
odometer 5-77
outside temperature gauge 5-78
power gauge 5-75
SOC gauge 5-76
speedometer 5-75
glove box 5-129
green zone drive mode 6-50

H

headrest 4-11
front seat headrest 4-11
rear seat headrest 4-13
head-up display (HUD) 5-99
heated steering wheel 5-60
HEV (hybrid electric vehicle) system 1-3
hev powertrain 2-7
high beam assist (HBA) 5-103
highway driving assist (HDA) 7-88

malfunction and limitations	7-95	seat warmer	5-130
operation	7-90	sun visor	5-132
settings	7-89	USB charger	5-132
HomeLink® system	5-63	wireless smart phone charging system	5-134
hood	5-48	interior light	5-110
closing the hood	5-49	automatic turn off function	5-110
hood open warning	5-49	glove box lamp	5-112
opening the hood	5-48	luggage room lamp	5-112
hood open warning	5-49	map lamp	5-111
hybrid starter & generator (hsg) belt	9-21	room lamp	5-111
hybrid system overview	1-2	vanity mirror lamp	5-112
hybrid vehicle components	1-41		

I

immobilizer system	5-10
indicator lights	5-85
infotainment system	5-142
audio system	5-145
using the infotainment/climate switchable controller	5-144
inside rear view mirror	5-62
day/night rear view mirror	5-62
HomeLink® system	5-63
instrument cluster	5-74
adjusting instrument cluster illumination	5-75
gauges	5-75
transmission shift indicator	5-79
integrated memory system	5-32
recalling memory positions	5-32
Resetting the System	5-33
Seat easy access	5-33
storing memory positions	5-32
intelligent speed limit assist (ISLA)	7-48
malfunction and limitations	7-51
operation	7-49
settings	7-48
interior features	5-129
air ventilation seat	5-131
ambient light	5-129
coat hook	5-136
cup holder	5-129
floor mat anchor(s)	5-137
power outlet	5-133

K

keys	5-6
battery replacement	5-6
smart key	5-7

L

lane following assist (LFA)	7-84
malfunction and limitations	7-87
operation	7-85
settings	7-85
lane keeping assist (LKA)	7-27
malfunction and limitations	7-31
operation	7-29
settings	7-28
LCD display	5-89
LCD display modes	5-89
LCD display messages	5-93
LCD display modes	5-93
driver assistance settings (infotainment system)	5-98
LCD displays	
LCD display messages	5-93
service mode	5-92
liftgate	5-34
closing the liftgate	5-35
opening the liftgate	5-34
power liftgate	5-36
light bulbs	9-56
bulb replacement precaution	9-56
light bulb position (front)	9-57
light bulb position (rear)	9-57
light bulb position (side)	9-58
lighting	5-100

battery saver function	5-100
daytime running light (DRL)	5-101
front fog light	5-103
headlamp delay function	5-100
high beam assist (HBA)	5-103
lighting control	5-101
one-touch lane change	5-103
operating high beam	5-102
operating turn signals	5-103
lighting control	
auto light	5-102
head light (low beam)	5-102
position and tail lamp	5-101
luggage board	5-137
luggage net holder	5-138

M

maintenance	
battery	9-28
climate control air filter	9-24
fuses	9-45
lights bulbs	9-56
maintenance services	9-5
owner maintenance	9-6
washer fluid	9-22
wiper blades	9-25
manual speed limit assist (MSLA)	7-46
operation	7-46
master warning mode	5-93
mirrors	5-62
inside rear view mirror	5-62
outside rear view mirror	5-71

N

navigation-based smart cruise control (NSCC)	7-79
limitations	7-81
operation	7-80
settings	7-80

O

occupant detection system (ODS)	4-40
odometer	5-77

one-touch lane change	5-103
online factory authorized manuals	10-14
open source software notice	2-6
opening the hood	5-48
outside rear view mirror	5-71
adjusting the outside rear view mirror	5-71
folding the outside rear view mirror	5-72
outside temperature gauge	5-78
overloading	6-71

P

paddle shifter	6-15
panoramic sunroof	5-55
automatic reversal	5-57
power sunshade	5-56
resetting the sunroof	5-58
slide open/close	5-56
sunroof open warning	5-58
tilt open/close	5-56
PHEV (plug-in hybrid electric vehicle) system	1-2
portable charge	
charging status indicator lamp for portable charger	1-14, 1-17
how to connect	1-12, 1-20
power gauge	5-75
power liftgate	5-36
power outlet	5-133
power window lock button	5-47
pre-tensioner seat belt	4-23

R

rear cross-traffic collision-avoidance assist (RCCA)	7-107
malfunction and limitations	7-111
operation	7-108
settings	7-107
rear seat headrest	4-13
rear view monitor (RVM)	7-97
malfunction and limitations	7-100
operation	7-98
settings	7-97

regenerative braking system		seat	4-5
adjusting with paddle shifter	6-15	armrest	4-14
remote smart parking assist (RSPA)		folding the rear seat	4-14
malfunction and limitations	7-132	front seat adjustment for manual seat	4-8
operation	7-139	front seat adjustment for power seat	4-9
settings	7-134	infotainment system	4-8
reporting safety defects	10-14	seat leather	4-7
reverse parking collision-avoidance assist (PCA)		seatback pocket	4-13
malfunction and limitations	7-126	seat belts	4-17
operation	7-128	3-point system with emergency locking	
settings	7-127	retractor	4-20
risk of burns when parking or stopping vehicle	2-5	care of seat belts	4-26
roof rack	5-139	precautions	4-25
		pre-tensioner seat belt	4-23

S

safe exit warning (SEW)		seat leather	4-7, 4-8
malfunction and limitations	7-42	seat warmer	5-130
operation	7-44	seatback pocket	4-13
settings	7-43	service interlock connector	1-43
safety precautions	4-3	service mode	5-92
scheduled charging	1-7	side air bag	4-47
scheduled maintenance items		smart cruise control (SCC)	7-62
air cleaner filter	9-13	display and control	7-67
air conditioning refrigerant	9-14, 9-15	malfunction and limitations	7-72
automatic transmission fluid	9-14	operation	7-64
brake discs, pads and calipers	9-14	settings	7-63
brake fluid	9-14	smart key	5-7
brake hoses and lines	9-14	mechanical key	5-9
coolant	9-14	operation	5-7
cooling system	9-14	smart liftgate with auto open	5-41
drive shafts and boots	9-14	detecting area	5-43
Exhaust pipe and muffler	9-14	how to deactivate	5-42
fluid levels	9-15	how to use	5-41
fuel lines, fuel hoses and connections	9-13	smart regeneration system	6-16
spark plugs	9-13	activation	6-17
steering gear box, linkage & boots/ lower arm ball joint	9-14	basic setting of smart regeneration	
suspension mounting bolts	9-14	system	6-18
vacuum crankcase ventilation hoses	9-13	limitation	6-19
vapor hose and fuel filler cap	9-13	malfunction	6-19
scheduled maintenance service	9-8	resuming	6-18
scheduled maintenance service precaution	9-8	setting	6-16
		SOC gauge	5-76
		special driving conditions	6-53
		specifications	10-2
		air conditioner compressor label	10-9
		air conditioning system	10-3
		bulb wattage	10-4
		dimensions	10-2
		engine	10-3

engine number	10-9	snow tires	9-43
gross vehicle weight	10-3	summer tires	9-43
lubricants and capacities	10-6	tire chains	9-44
luggage volume	10-3	tire maintenance	9-37
reference weight and distance when towing a trailer	10-3	tire replacement	9-36
refrigerant label	10-9	tire rotation	9-34
tire specification and pressure label	10-8	tire sidewall labeling	9-37
tires and wheels	10-5	tire terminology and definitions	9-40
vehicle certification label	10-8	tire traction	9-37
vehicle identification number (VIN)	10-8	wheel alignment and tire balance	9-35
speedometer	5-75	wheel replacement	9-36
starting the engine		towing	8-26
starting the engine	6-8	without wheel dollies	8-27
starting the engine with smart key	6-7	trailer towing	6-60
starting the gasoline engine		driving with a trailer	6-62
starting the gasoline engine	6-8	hitches	6-61
steering wheel	5-59	maintenance	6-64
electric power steering (EPS)	5-59	pull a trailer	6-65
heated steering wheel	5-60	safety chains	6-61
horn	5-61	trailer brakes	6-62
tilt & telescopic steering wheel	5-60	transmission shift indicator	5-79
storage compartment	5-128	trickle charger (portable charging cable)	1-12, 1-17
center console storage	5-128	trip information (Trip computer)	
glove box	5-129	energy flow	5-92
luggage board	5-137	trip information (trip computer)	
luggage net holder	5-138	accumulated driving information	
sun visor	5-132	mode	5-91
surround view monitor (SVM)	7-101	drive info display	5-90
malfunction and limitations	7-106	fuel economy	5-92
operation	7-103	turn by turn (TBT) mode	5-90
settings	7-101		
<hr/>			
T		U	
theft-alarm system	5-11	USB charger	5-132
armed stage	5-12	using the infotainment/climate switchable controller	5-144
disarmed stage	5-12		
theft-alarm stage	5-12	<hr/>	
tire pressure monitoring system (TPMS)	8-8	V	
effective use of the TPMS	8-9	vehicle auto shut-off system	6-47
tire replacement with TPMS	8-11	vehicle break-in process	2-5
tires and wheels	9-32	vehicle data collection and event data recorders	2-6
all season tires	9-43	vehicle handling instructions	2-5
checking tire inflation pressure	9-33	vehicle identification number (VIN)	10-8
radial-ply tires	9-44		

vehicle load limit	6-66
vehicle modifications	2-4
vehicle weight	6-70

W

warning and indicator lights	5-79
indicator lights	5-85
warning lights	5-79
warning lights	5-79
washer fluid	9-22
welcome system	5-109
window opening and closing	5-45
windows	5-44
power window lock button	5-47
window opening and closing	5-45
windshield defrosting and defogging	5-124
defogging logic	5-127
defroster	5-126
front glass heater	5-128
winter driving	6-56
wiper blades	9-25
wipers and washers	5-106
wireless smart phone charging system	5-134

2025 KIA AMERICA, INC.



"Printed with soy-based ink on recycled paper. We support a healthy planet and better tomorrow."



Movement that inspires