

## California Proposition 65 Warning

**WARNING:** This product contains or emits chemicals known to the state of California to cause cancer and birth defects or other reproductive harm.

### Event Data Recorders

**This vehicle is equipped with an event data recorder (EDR).**

The main purpose of an EDR is to record, in certain crash or near crash-like situations, such as an air bag deployment or hitting a road obstacle, data that will assist in understanding how a vehicle's systems performed. **The EDR is designed to record data related to vehicle dynamics and safety systems for a short period of time, typically 30 seconds or less. The EDR in this vehicle is designed to record such data as:**

- **How various systems in your vehicle were operating;**
- **Whether or not the driver and passenger safety belts were buckled/fastened;**
- **How far (if at all) the driver was depressing the accelerator and/or brake pedal; and,**
- **How fast the vehicle was traveling.**

These data can help provide a better understanding of the circumstances in which crashes and injuries occur. NOTE: EDR data are recorded by your vehicle only if a non-trivial crash situation occurs; no data are recorded by the EDR under normal driving conditions and no personal data (e.g., name, gender, age, and crash location) are recorded. However, other parties, such as law enforcement, could combine the EDR data with the type of personally identifying data routinely acquired during a crash investigation.

To read data recorded by an EDR, special equipment is required, and access to the vehicle or the EDR is needed. In addition to the vehicle manufacturer, other parties, such as law enforcement, that have the special equipment, can read the information if they have access to the vehicle or the EDR.

The data belongs to the vehicle owner and may not be accessed by anyone else except as legally required or with the permission of the vehicle owner.

### Service Diagnostic Recorders

This vehicle is equipped with service-related devices that record information about powertrain performance. The data can be used to verify emissions law requirements and/or help technicians diagnose and solve service problems. It may also be combined with data from other sources for research purposes, but it remains confidential. Some diagnostic and maintenance information is uploaded to Honda upon vehicle start up.

### California Perchlorate Contamination Prevention Act

The airbags, seat belt tensioners, and CR type batteries in this vehicle may contain perchlorate materials - special handling may apply. See [www.dtsc.ca.gov/hazardouswaste/perchlorate/](http://www.dtsc.ca.gov/hazardouswaste/perchlorate/)

As you read this manual, you will find information that is preceded by a **NOTICE** symbol. This information is intended to help you avoid damage to your vehicle, other property, or the environment.

## A Few Words About Safety

---

Your safety, and the safety of others, is very important. And operating this vehicle safely is an important responsibility.

To help you make informed decisions about safety, we have provided operating procedures and other information on labels and in this manual. This information alerts you to potential hazards that could hurt you or others.

Of course, it is not practical or possible to warn you about all the hazards associated with operating or maintaining your vehicle. You must use your own good judgment.

You will find this important safety information in a variety of forms, including:

- **Safety Labels** - on the vehicle.
- **Safety Messages** - preceded by a safety alert symbol  and one of three signal words: **DANGER**, **WARNING**, or **CAUTION**. These signal words mean:

 **DANGER**

You **WILL** be **KILLED** or **SERIOUSLY HURT** if you don't follow instructions.

 **WARNING**

You **CAN** be **KILLED** or **SERIOUSLY HURT** if you don't follow instructions.

 **CAUTION**

You **CAN** be **HURT** if you don't follow instructions.

- **Safety Headings** - such as Important Safety Precautions.
- **Safety Section** - such as Safe Driving.
- **Instructions** - how to use this vehicle correctly and safely.

This entire book is filled with important safety information - please read it carefully.

This owner's manual should be considered a permanent part of the vehicle and should remain with the vehicle when it is sold.

This owner's manual covers all models of your vehicle. You may find descriptions of equipment and features that are not on your particular model.

Images throughout this owner's manual (including the front cover) represent features and equipment that are available on some, but not all, models. Your particular model may not have some of these features.

This owner's manual is for vehicles sold in the United States and Canada.

The information and specifications included in this publication were in effect at the time of approval for printing. Honda Motor Co., Ltd. reserves the right, however, to discontinue or change specifications or design at any time without notice and without incurring any obligation.

## ➤ Safe Driving P. 31

For Safe Driving P. 32      Seat Belts P. 37      Airbags P. 45

## ➤ Instrument Panel P. 77

Indicators P. 78      Gauges and Multi-Information Display (MID) P. 113

## ➤ Controls P. 119

Clock P. 120      Locking and Unlocking the Doors P. 121  
Moonroof\* P. 148      Panoramic Roof\* P. 149  
Adjusting the Seats P. 174      Interior Lights/Interior Convenience Items P. 188

## ➤ Features P. 217

Audio System P. 218  
General Information on the Audio System P. 314  
HomeLink® Universal Transceiver\* P. 387      Bluetooth® HandsFreeLink® P. 390

## ➤ Driving P. 451

Before Driving P. 452      Towing a Trailer P. 458  
Parking Your Vehicle P. 552      Multi-view rear camera\* P. 561

## ➤ Maintenance P. 567

Before Performing Maintenance P. 568      Maintenance Minder™ P. 571  
Checking and Maintaining Wiper Blades P. 593  
Remote Control and Wireless Headphone Care\* P. 609  
Accessories and Modifications P. 618

## ➤ Handling the Unexpected P. 619

Tools P. 620      If a Tire Goes Flat P. 621  
Overheating P. 636      Indicator, Coming On/Blinking P. 638  
When You Cannot Unlock the Fuel Fill Door P. 648

## ➤ Information P. 651

Specifications P. 652      Identification Numbers P. 654  
Emissions Testing P. 657      Warranty Coverages P. 659

# Contents

Child Safety P. 58

Exhaust Gas Hazard P. 74

Safety Labels P. 75

Opening and Closing the Tailgate P. 135

Operating the Switches Around the Steering Wheel P. 152

Heating and Cooling\* P. 205

Security System P. 143

Climate Control System\* P. 210

Opening and Closing the Windows P. 146

Adjusting the Mirrors P. 172

Audio System Basic Operation P. 224, 242

Blu-ray/DVD Rear Entertainment System\* P. 322

Bluetooth® HandsFreeLink® P. 415

Audio Error Messages P. 310

Customized Features P. 351

Compass\* P. 448

Off-Highway Driving Guidelines P. 469

Refueling P. 562

When Driving P. 471

Fuel Economy and CO<sub>2</sub> Emissions P. 565

Braking P. 539

Maintenance Under the Hood P. 575

Checking and Maintaining Tires P. 597

Heating and Cooling System\*/Climate Control System\* Maintenance P. 611

Replacing Light Bulbs P. 587

Battery P. 606

Remote Transmitter Care P. 608

Cleaning P. 613

Engine Does Not Start P. 629

Fuses P. 642

When You Cannot Open the Tailgate P. 650

Shift Lever Does Not Move\* P. 632

Emergency Towing P. 647

Refueling P. 649

Jump Starting P. 633

Devices that Emit Radio Waves P. 655

Authorized Manuals P. 661

Reporting Safety Defects P. 656

Customer Service Information P. 662

Quick Reference Guide P. 4

Safe Driving P. 31

Instrument Panel P. 77

Controls P. 119

Features P. 217

Driving P. 451

Maintenance P. 567

Handling the Unexpected P. 619

Information P. 651

Index P. 663

# Visual Index

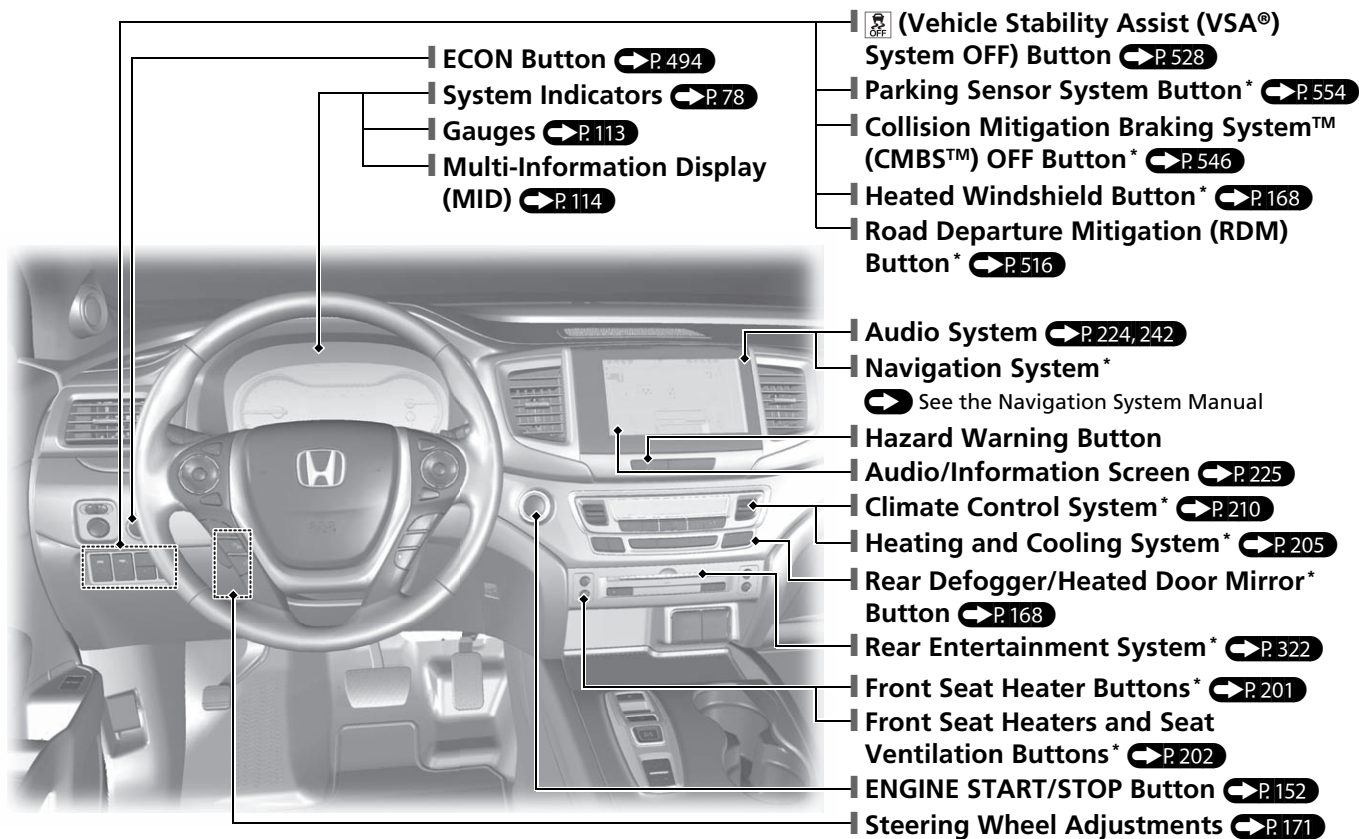

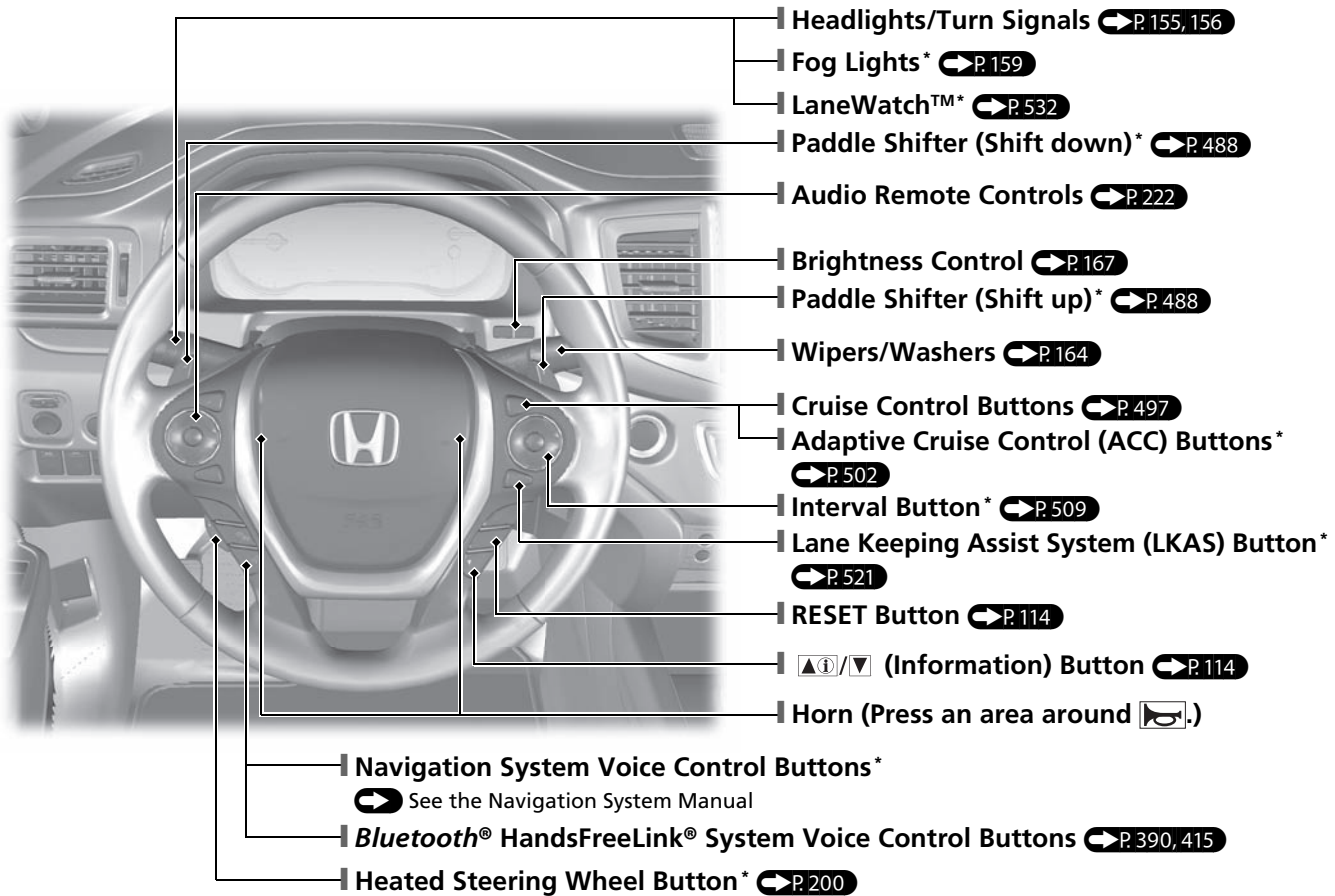

# Visual Index

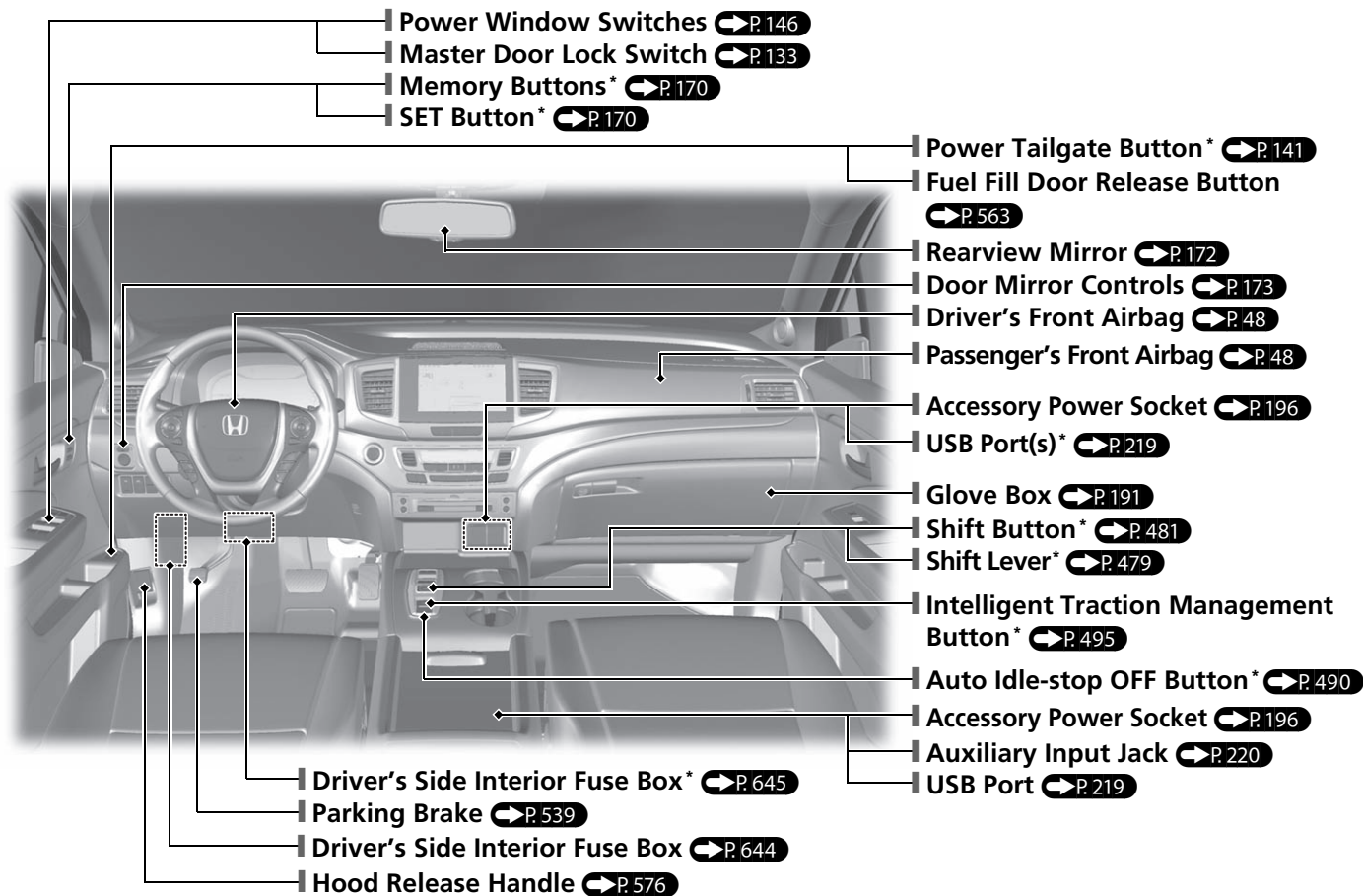

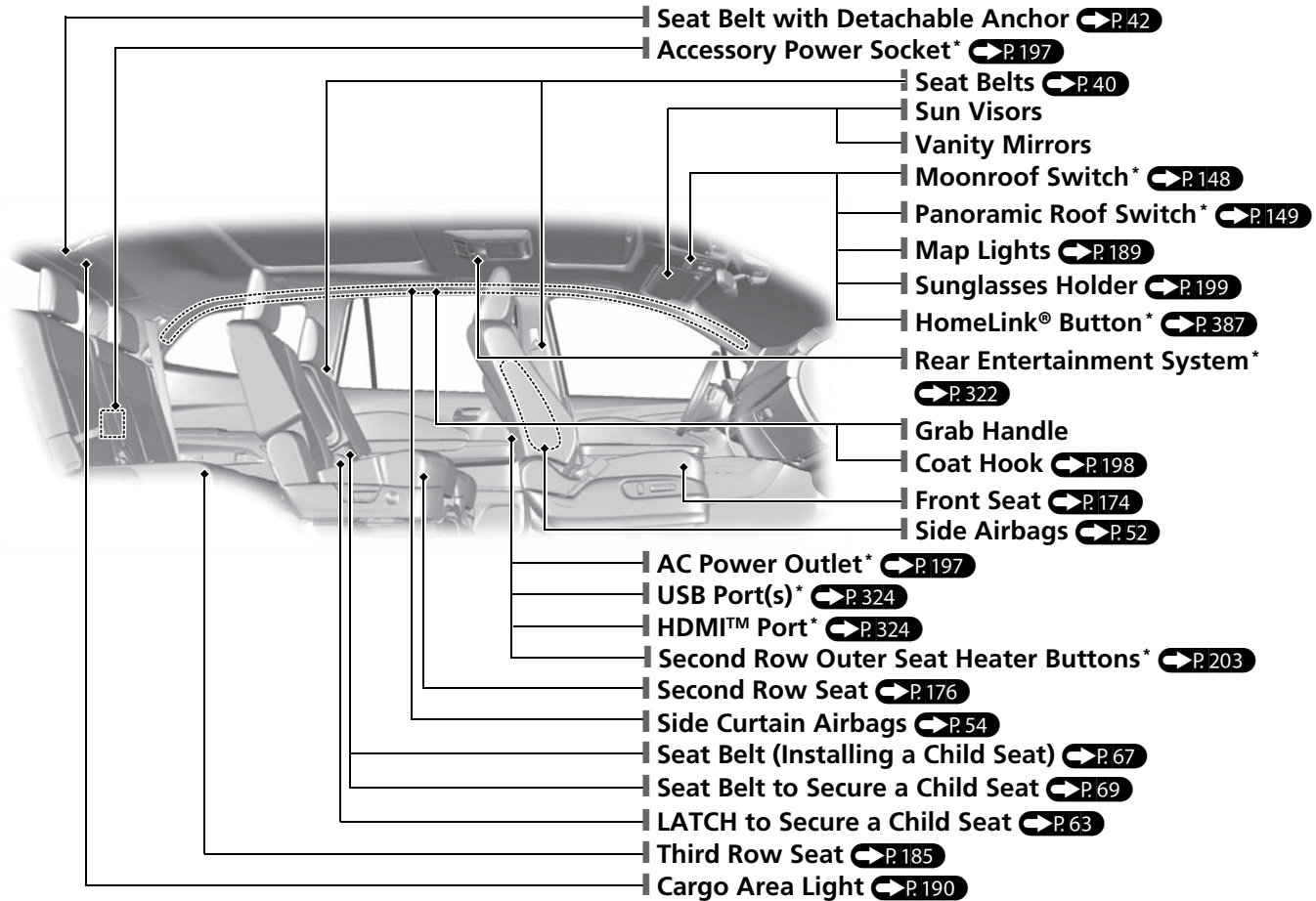





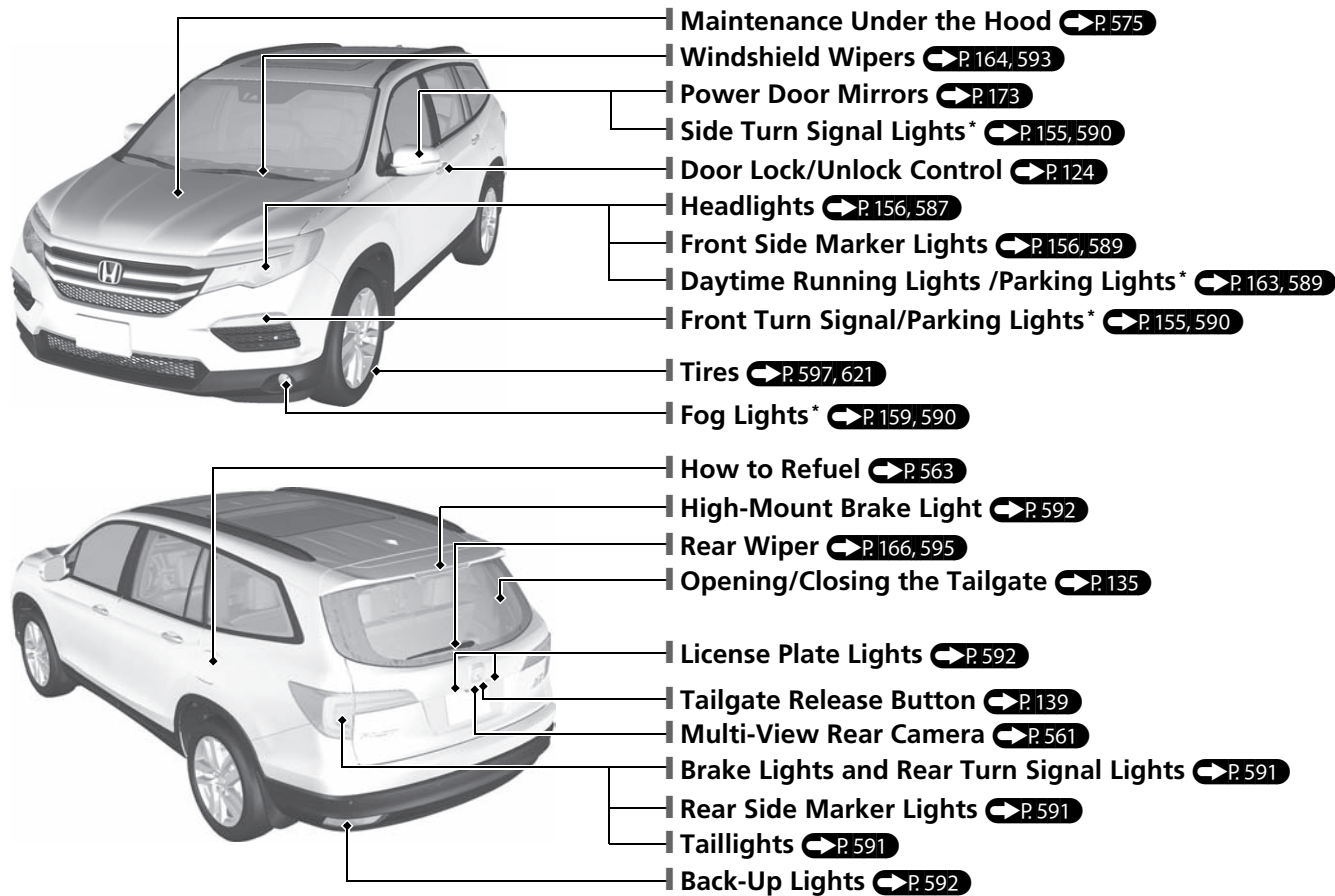

# Visual Index

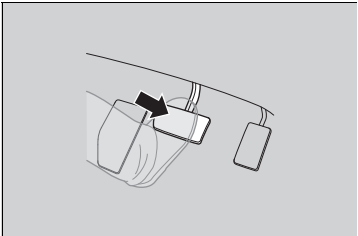
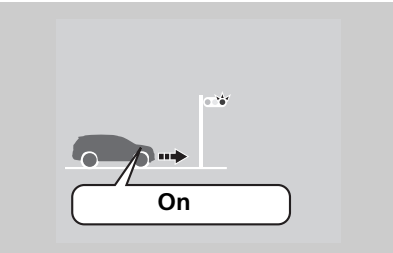

# Auto Idle-stop Function \*

To improve fuel economy, the engine stops and then restarts as detailed below. When Auto Idle-stop is on, the Auto Idle-stop indicator (green) comes on.  P. 489

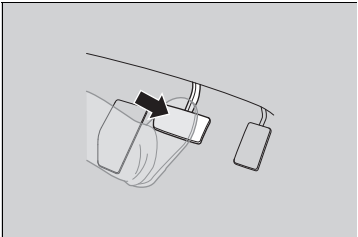
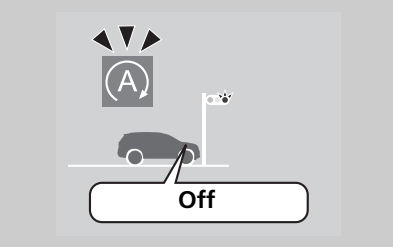
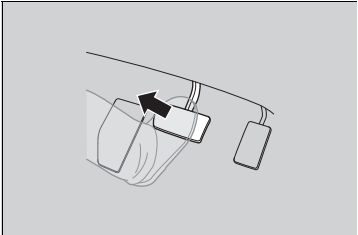
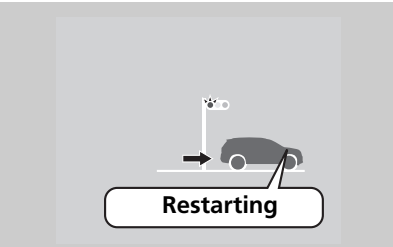
At	Automatic transmission	Engine status
Deceleration 	 <p>Stop the vehicle and depress the brake pedal.</p>	 <p>On</p>
Stop 	 <p>Keep the brake pedal depressed.</p>	 <p>Off</p>
Start-up	 <p>Release the brake pedal.</p>	 <p>Restarting</p>

\* Not available on all models

# Eco Assist® System

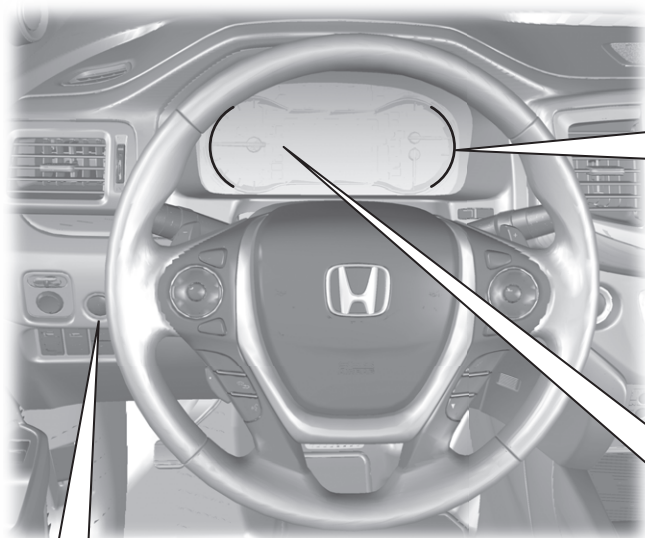

## Ambient Meter

- Changes color to reflect your driving style.
  - Green:** Fuel efficient driving
  - Light green:** Moderate acceleration/deceleration
  - White:** Aggressive acceleration/deceleration
- The ambient meter color changes in accordance with your brake or accelerator pedal operation.



**ECON Button** → P. 494  
Helps maximize fuel economy.



## ECON Mode Indicator

→ P. 94

Comes on when the **ECON** button is pressed.

# Safe Driving P.31

## Airbags P.45

- Your vehicle is fitted with airbags to help protect you and your passengers during a moderate-to-severe collision.

## Child Safety P.58

- All children 12 and younger should be seated in the rear seat.
- Smaller children should be properly restrained in a forward-facing child seat.
- Infants must be properly restrained in a rear-facing child seat.

## Exhaust Gas Hazard P.74

- Your vehicle emits dangerous exhaust gases that contain carbon monoxide. Do not run the engine in confined spaces where carbon monoxide gas can accumulate.

## Seat Belts P.37

- Fasten your seat belt and sit upright well back in the seat.
- Check that your passengers are wearing their seat belts correctly.

## Before Driving Checklist P.36

- Before driving, check that the front seats, head restraints, steering wheel, and mirrors have been properly adjusted.

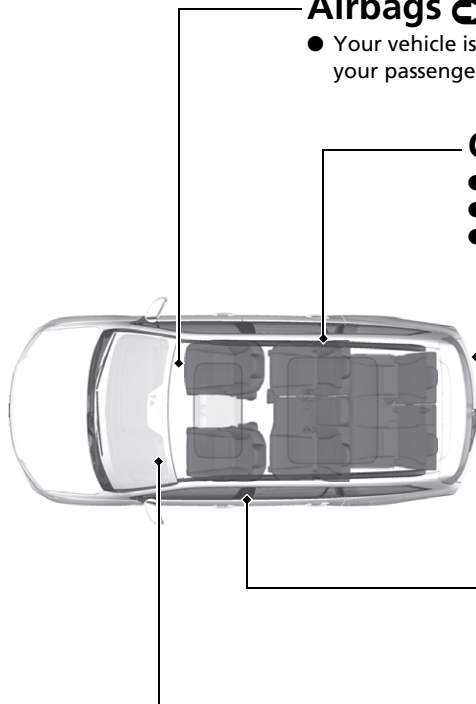















Fasten your lap belt as low as possible.

# Instrument Panel

## Gauges /Multi-Information Display (MID) /System Indicators

### System Indicators







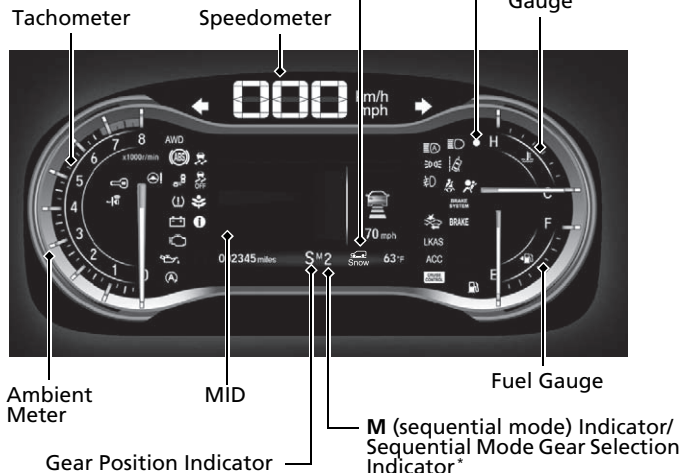









-  Blind spot information (BSI) Indicator\*
-  Electric Power Steering (EPS) System Indicator
-  Malfunction Indicator Lamp
-  Low Oil Pressure Indicator
-  AWD All-wheel drive system (AWD) Indicator\*
-  Vehicle Stability Assist (VSA®) System Indicator
-  VSA® OFF Indicator
-  Immobilizer System Indicator
-  Smart Entry System Indicator\*
-  Charging System Indicator
-  Low Tire Pressure/TPMS Indicator
-  System Message Indicator
-  ECON Mode Indicator
-  Auto high-beam system Indicator\*
-  LKAS Lane Keeping Assist System (LKAS) Indicator\*

### Intelligent Traction Management Indicator



### Security System Alarm Indicator





### System Indicators

-  **ACC** Adaptive Cruise Control (ACC) Indicator\*
-  **CRUISE MAIN** Indicator\*
-  **CRUISE CONTROL** Indicator\*
-  **(A)** Auto Idle-stop System Indicator (Amber)\*
-  **(A)** Auto Idle-stop System Indicator (Green)\*
-  Turn Signal and Hazard Warning Indicators
-  Supplemental Restraint System Indicator
-  **(ABS)** Anti-lock Brake System (ABS) Indicator
-  **BRAKE** U.S. Parking Brake and Brake System Indicator (Red)
-  **(!)** Canada Brake System Indicator (Amber)
-  **BRAKE SYSTEM** U.S. Brake System Indicator (Amber)
-  **(!)** Canada Brake System Indicator (Amber)
-   Low Fuel Indicator
-   Seat Belt Reminder Indicator

### System Indicators

-  Collision Mitigation Braking System™ (CMBS™) Indicator\*
-  Road Departure Mitigation (RDM) Indicator\*

### Lights Indicators





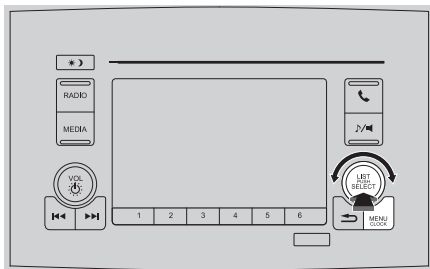

-  Lights On Indicator
-  High Beam Indicator
-  Fog Light Indicator\*

# Controls P.119

## Clock P.120



Models with color audio system



- 1 Press and hold the **MENU/CLOCK** button for two seconds.
- 2 Select **Adjust Clock**, then press .
- 3 Rotate  to adjust the hours.
- 4 Press  to switch to minute adjustment.
- 5 Rotate  to adjust the minutes.
- 6 Press  to switch to **Set**.
- 7 Press  to complete clock adjustment.

Models with Display Audio



- 1 Select , then select **Settings**.
- 2 Select **Clock/Info**, then **Clock Adjustment**.
- 3 Adjust the dates, hours and minutes by selecting /.
- 4 Select **OK** to set the time.

## ENGINE START/STOP Button P.152

Press the button to change the vehicle's power mode.



## Turn Signals P.155

Turn Signal Control Lever

Right

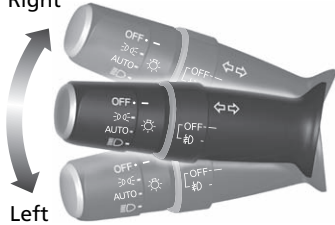

Left

## Lights P.156

Light Control Switches

High Beam

Low Beam

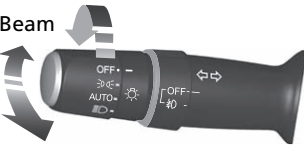

Flashing

## Wipers and Washers

 P.164

Wiper/Washer Control Lever

**MIST**

**OFF**

**AUTO\***: Wiper speed varies automatically

**INT**<sup>2</sup>: Low speed with intermittent

**LO**: Low speed wipe

**HI**: High speed wipe

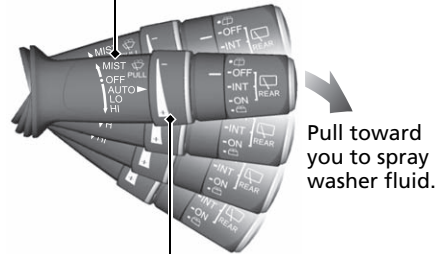

Pull toward you to spray washer fluid.

Adjustment Ring

-: Low Sensitivity<sup>\*1</sup>

: Lower speed, fewer sweeps<sup>\*2</sup>

+: High Sensitivity<sup>\*1</sup>

: Higher speed, more sweeps<sup>\*2</sup>

\*1: Models with automatic intermittent wipers

\*2: Models without automatic intermittent wipers

Models with automatic intermittent wipers

**AUTO** should always be turned **OFF** before the following situation:

- Cleaning the windshield
- Driving through a car wash
- Driving when it not rain

## Steering Wheel P.171

- To adjust, push the adjustment lever down, adjust to the desired position, then pull up the lever back in place.

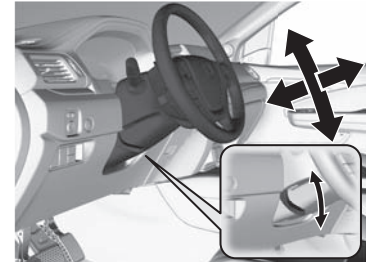

## Unlocking the Front Doors from the Inside

➔ P.132

- Pull either front door inner handle to unlock and open it at the same time.



## Tailgate ➔ P.138

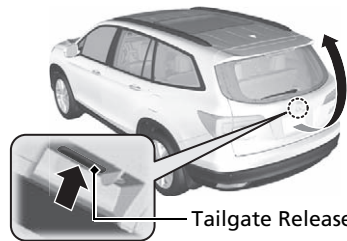

Tailgate Release Button

### Models with smart entry remote

- Press the tailgate release button to unlock and open the tailgate when you carry the smart entry remote.

### Models with power tailgate

- Press the power tailgate button on the driver's door or the remote transmitter to open and close the power tailgate.

## Power Door Mirrors

➔ P.173

- With the power mode in ON, move the selector switch to L or R.
- Push the appropriate edge of the adjustment switch to adjust the mirror.
- Press the folding button\* to fold in and out the door mirrors.

Folding Button\*      Selector Switch

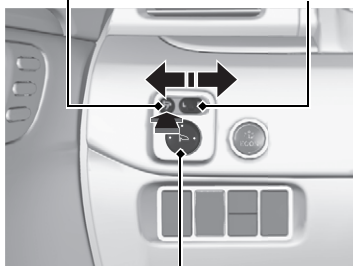

Adjustment Switch

## Power Windows ➔ P.146

- With the power mode in ON, open and close the power windows.
- If the power window lock button is in the off position, each passenger's window can be opened and closed with its own switch.
- If the power window lock button is in the on position (indicator is on), each passenger's window switch is disabled.

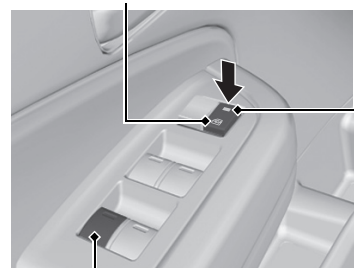

Power Window Lock Button      Indicator



Window Switch



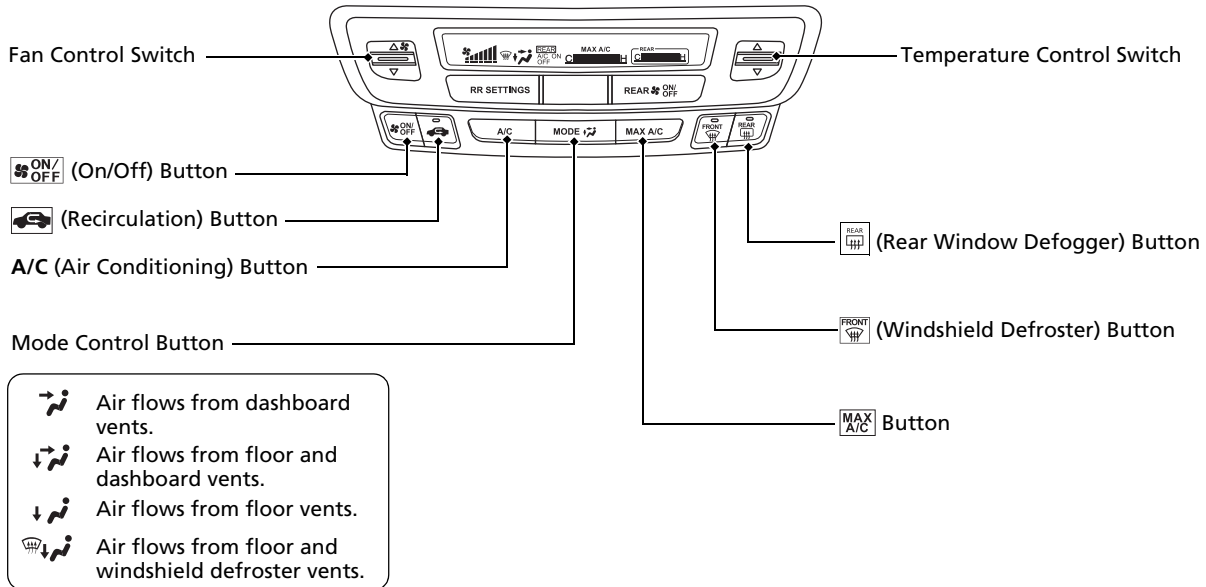

## Heating and Cooling System\*

- Toggle up and down the fan control switch to adjust the fan speed.
- Press the Mode button to select from which vents air flows.
- Toggle up and down the temperature control switch to adjust the temperature.
- Use the  button for maximum cool setting.
- Press the  button to turn the system on or off.
- Press the  button to defrost the windshield.



# Climate Control System\* P. 210

- Press the **AUTO** button to activate the climate control system.
- Press the  button to turn the system on or off.
- Press the  button to defrost the windshield.

## Models with Display Audio

The climate control system is voice operable.  P. 263

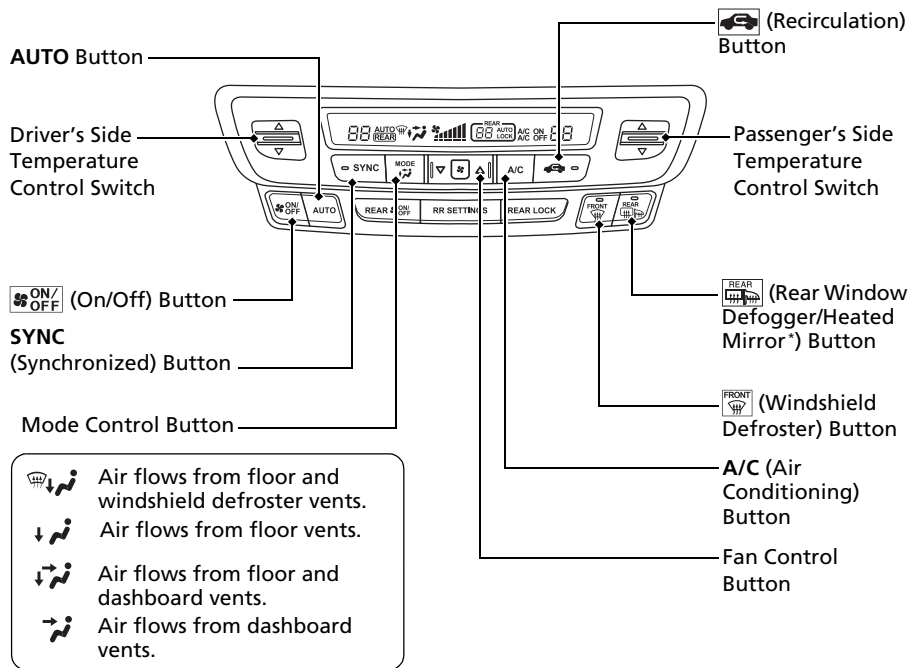

# Rear Climate Control P. 215

- Press the **AUTO** button to activate the rear climate control system.
- Press the  button to turn the system on or off.

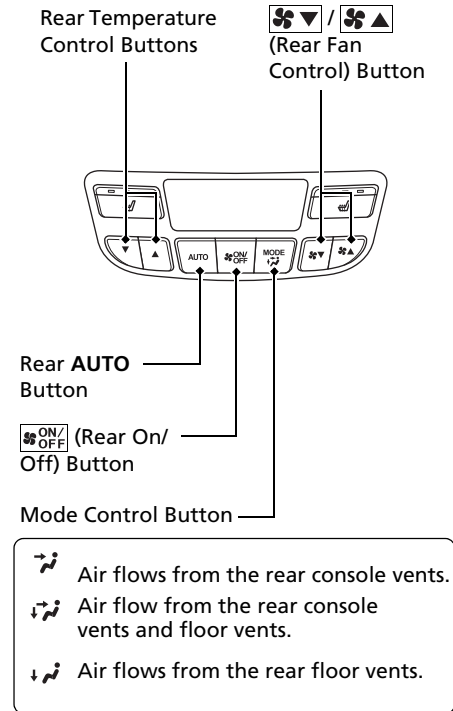

\* Not available on all models

# Features P.217

## Audio system P.218

Models with color audio system

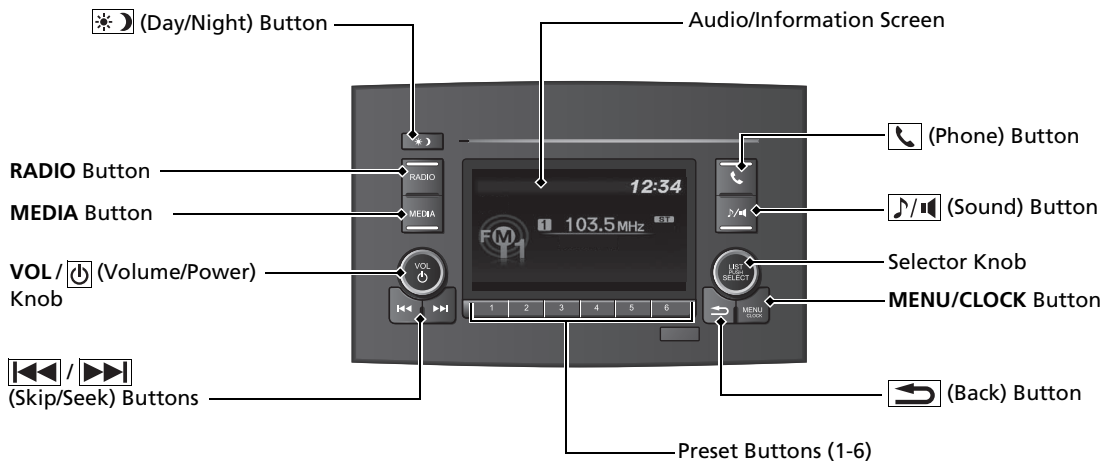

Models with Display Audio

For navigation system operation  See the Navigation System Manual

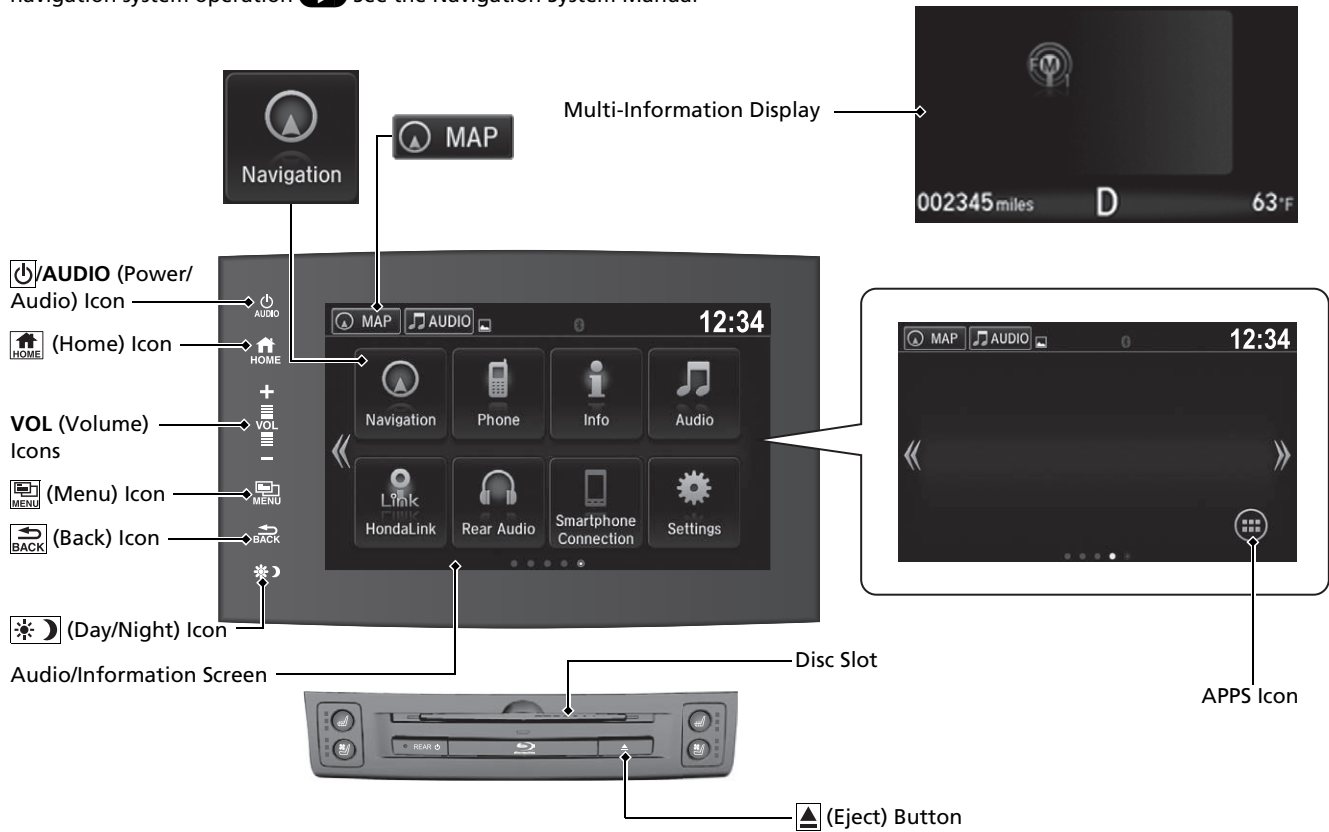

## Audio Remote Controls

➔ P. 222

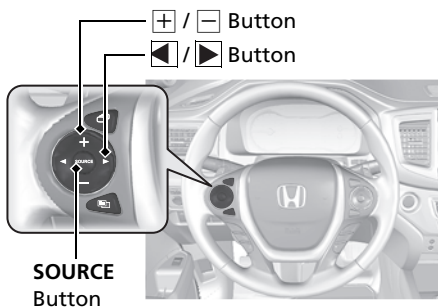

- **+ / - Button**  
Press to adjust the volume up/down.
- **SOURCE Button**

### Models with color audio system

Press to change the audio mode:

FM1/FM2/AM/USB/iPod/  
*Bluetooth*® Audio/AUX

### Models with Display Audio

Press to change the audio mode:

FM/AM/SiriusXM®/CD\*/USB/iPod/  
Pandora®\*/Apple CarPlay™/Android  
Auto™/*Bluetooth*® Audio/AUX/REAR  
VIDEO\*/REAR HDMI\*/Audio Apps

- **◀ / ▶ Button**

Radio: Press to change the preset station.  
Press and hold to select the next or  
previous strong station.

CD\*/USB device:

Press to skip to the beginning of  
the next song or return to the  
beginning of the current song.  
Press and hold to change a folder.

# Driving P.451

Automatic transmission models with electronic gear selector

## Automatic Transmission P.481

- Always depress the brake pedal before selecting **P** or changing the gear position from **P**.
- Select **P** and depress the brake pedal when starting the engine.
- Gear selection

### Gear Position Indicator

The gear position indicator and the shift button indicator indicate the current gear selection.

**S<sup>M</sup>2**

Gear Position Indicator

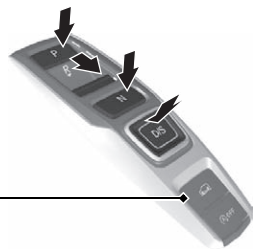
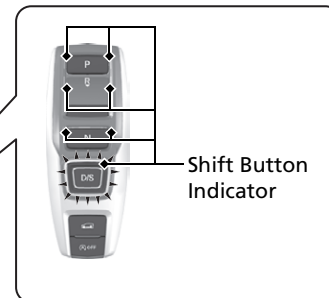
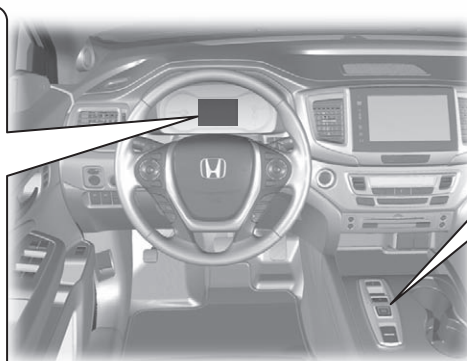

Intelligent Traction Management Button

**P** **Park**  
Press the **P** button.  
Used when parking or before  
turn off or start the engine.  
Transmission is locked.

**R** **Reverse**  
Pull back the **R** button.  
Used when reversing.

**N** **Neutral**  
Press the **N** button.  
Transmission is not locked.

**D** **Drive**  
Press the **D/S** button.  
Used for normal driving.  
Sequential mode can be used.

**S** **S Position**  
Press the **D/S** button twice.  
Sequential mode can be used.

## Paddle Shifters P. 488

- Paddle shifters allow you to shift gears much like a manual transmission (1st through 9th). This is useful for engine braking.

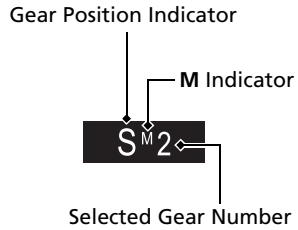

- Sequential mode: The transmission will shift back to automatic mode once the system detects that the vehicle is cruising.
- Sequential mode gear selection: Holds the selected gear, and the **M** (sequential mode) indicator comes on.
- The sequential mode gear selection is shown in the instrument panel.

Shift Down   
Paddle Shifter



Shift Up   
Paddle Shifter



# Automatic Transmission ➔ P. 479

- Shift to **P** and depress the brake pedal when starting the engine.

## ● Shifting

**P** **Park**  
Turn off or start the engine.  
Transmission is locked.

**R** **Reverse**  
Used when reversing.

**N** **Neutral**  
Transmission is not locked.

**D** **Drive**  
Normal driving.

**L** **Low**

- Used to further increase engine braking.
- Used when going up or down hills.

**D4** **Drive (D4)**  
Press the **D4** button while the shift lever is in **D**.

Used when:

- Going up or down hills.
- Towing a trailer in hilly terrain.

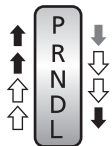
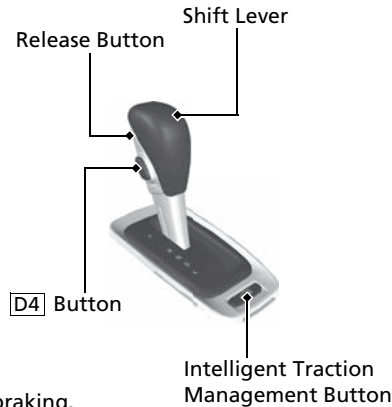

- ↓ Depress the brake pedal and press the release button to move out of **P**.
- ↑ Press the release button to move the shift lever.
- ↕ Move the shift lever without pressing the release button.



## VSA® On and Off P.528

- The vehicle stability assist (VSA®) system helps stabilize the vehicle during cornering, and helps maintain traction while accelerating on loose or slippery road surfaces.
- VSA® comes on automatically every time you start the engine.
- To partially disable or fully restore VSA® function, press and hold the button until you hear a beep.

## Cruise Control P.497

- Cruise control allows you to maintain a set speed without keeping your foot on the accelerator pedal.
- To use cruise control, press the **CRUISE** button, then press the **-/SET** button once you have achieved the desired speed (above 25 mph or 40 km/h).

## Collision Mitigation Braking System™ (CMBS™) OFF Button \*

 P.546

- When a possible collision is likely unavoidable, the CMBS™ can help you to reduce the vehicle speed and the severity of the collision.
- To turn the CMBS™ on or off, press and hold the button until you hear a beep.

## Tire Pressure Monitoring System (TPMS) with Tire Fill Assist P.535, 641

- The TPMS monitors tire pressure.
- TPMS is turned on automatically every time you start the engine.
- TPMS fill assist provides audible and visual guidance during tire pressure adjustment.

## Refueling P.562

**Fuel recommendation: Unleaded gasoline, pump octane number 87 or higher**

**Fuel tank capacity: 19.5 US gal (73.8 ℓ)**

- 1 Press the fuel fill door release button.



- 2 After refueling, wait for about five seconds before removing the filler nozzle.

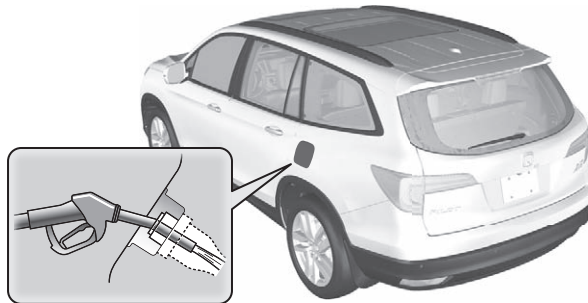

# Honda Sensing™\*

Honda Sensing™ is a driver support system which employs the use of two distinctly different kinds of sensors, a radar sensor located in the front grille and a front sensor camera mounted to the interior side of the windshield, behind the rear view mirror.

The camera is located behind the rearview mirror.

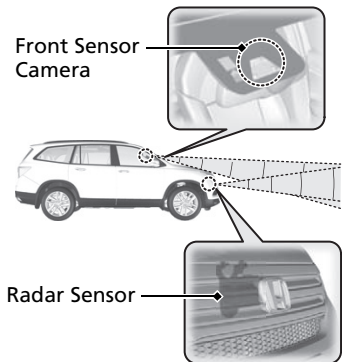

Front Sensor Camera

Radar Sensor

The radar sensor is inside the front grille.

## Adaptive Cruise Control (ACC)\* P.502

Helps maintain a constant vehicle speed and a set following interval behind a vehicle detected ahead of yours, without you having to keep your foot on the brake or the accelerator.

## Road Departure Mitigation (RDM) System\* P.514

Alerts and helps to assist you when the system detects a possibility of your vehicle unintentionally crossing over detected lane markings.

## Lane Keeping Assist System (LKAS)\* P.519

Provides steering input to help keep the vehicle in the middle of a detected lane and provides tactile and visual alerts if the vehicle is detected drifting out of its lane.

## Collision Mitigation Braking System™ (CMBS™)\* P.543

Can assist you when there is a possibility of your vehicle colliding with a vehicle or a pedestrian detected in front of yours. The CMBS™ is designed to alert you when a potential collision is determined, as well as to reduce your vehicle speed to help minimize collision severity when a collision is deemed unavoidable.

# Maintenance P.567

## Under the Hood P.575

- Check engine oil, engine coolant, and windshield washer fluid. Add when necessary.
- Check brake fluid.
- Check the battery condition monthly.

- 1 Pull the hood release handle under the corner of the dashboard.



- 2 Locate the hood latch lever, pull it up, and then raise the hood. Once you have raised the hood slightly, you can release the lever.

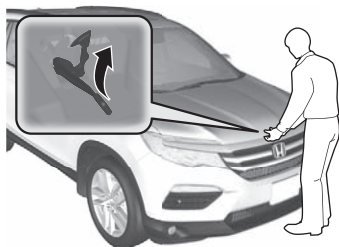

- 3 When finished, close the hood and make sure it is firmly locked in place.

## Wiper Blades P.593

- Replace blades if they leave streaks across the windshield.



## Tires P.597

- Inspect tires and wheels regularly.
- Check tire pressures regularly.
- Install snow tires for winter driving.

## Lights P.587

- Inspect all lights regularly.

# Handling the Unexpected P.619

## Flat Tire P.621

- Park in a safe location and replace the flat tire with the compact spare tire located under the cargo area.



## Engine Won't Start P.629

- If the battery is dead, jump start using a booster battery.

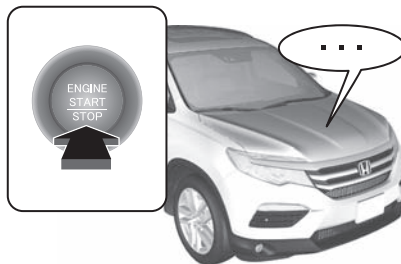

## Overheating P.636

- Park in a safe location. If you do not see steam under the hood, open the hood, and let the engine cool down.



## Indicators Come On P.638

- Identify the indicator and consult the owner's manual.

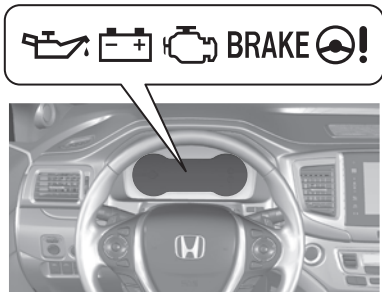

## Blown Fuse P.642

- Check for a blown fuse if an electrical device does not operate.

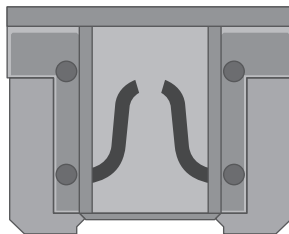

## Emergency Towing P.647

- Call a professional towing service if you need to tow your vehicle.



# What to Do If

**Q** **Canadian models**  
The power mode does not change from **VEHICLE OFF (LOCK)** to **ACCESSORY**. Why?

**A**

- The steering wheel may be locked.
- Move the steering wheel left and right while pressing the **ENGINE START/STOP** button.



**Q** **Models with shift lever**  
The power mode does not change from **ON** to **VEHICLE OFF (LOCK)**. Why?

**A** The shift lever should be moved to **P**.



**Q** Why does the brake pedal pulsate slightly when applying the brakes?

**A** This can occur when the ABS activates and does not indicate a problem. Apply firm, steady pressure on the brake pedal. Never pump the brake pedal.

---

**Q** The rear door cannot be opened from inside the vehicle. Why?

**A** Check if the childproof lock is in the lock position. If so, open the rear door with the outside door handle. To cancel this function, push the lever to the unlock position.

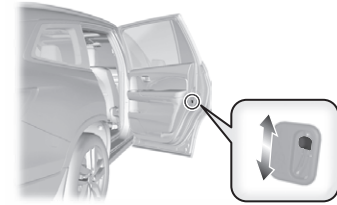

---

**Q** Why do the doors lock after I unlocked the doors using a remote transmitter?

**A** If you do not open the doors within 30 seconds, the doors are relocked automatically for security.

---

**Q** Why does the beeper sound when I open the driver's door?

**A** The beeper sounds when:

- The exterior lights are left on.
- The power mode is in ACCESSORY.
- Auto Idle-stop\* is in operation.

---

**Q** Why does the beeper sound when I start driving?

**A** The beeper sounds when:

- Driver and/or front passenger are not wearing their seat belts.
- The parking brake pedal is not fully released.

---

---

**Q** Why do I hear a screeching sound when I apply the brake pedal?

**A** The brake pads may need to be replaced. Have your vehicle inspected by a dealer.

---

**Q** **Models with electronic gear selector**  
Why does the gear position automatically change to **P** when I open the driver's door to check for parking space lines when reversing?

**A**

- Fasten the driver's seat belt.
- Close the driver's door and manually change the gear position.

▶ When opening the driver's door **➔ P.484**

---

**Q** I'm seeing an amber indicator of a tire with an exclamation point. What is that?

**A** The Tire Pressure Monitoring System (TPMS) needs attention. If you recently inflated or changed a tire, you have to recalibrate the system.

▶ Tire Pressure Monitoring System (TPMS) with Tire Fill Assist **➔ P.535**

---

# Safe Driving

You can find many safety recommendations throughout this chapter, and throughout this manual.

## For Safe Driving

Important Safety Precautions.....	32
Important Handling Information* .....	34
Your Vehicle's Safety Features.....	35

## Seat Belts

About Your Seat Belts.....	37
Fastening a Seat Belt.....	40
Seat Belt Inspection.....	44

## Airbags

Airbag System Components.....	45
Types of Airbags .....	48
Front Airbags (SRS) .....	48
Side Airbags.....	52
Side Curtain Airbags .....	54
Airbag System Indicators.....	55
Airbag Care .....	57

## Child Safety

Protecting Child Passengers .....	58
Safety of Infants and Small Children ..	60
Safety of Larger Children .....	72

## Exhaust Gas Hazard

Carbon Monoxide Gas.....	74
--------------------------	----

## Safety Labels

Label Locations .....	75
-----------------------	----



The following pages explain your vehicle's safety features and how to use them properly. The safety precautions below are ones that we consider to be among the most important.

## Important Safety Precautions

### ■ Always wear your seat belt

A seat belt is your best protection in all types of collisions. Airbags are designed to supplement seat belts, not replace them. So even though your vehicle is equipped with airbags, make sure you and your passengers always wear your seat belts, and wear them properly.

### ■ Restrain all children

Children ages 12 and under should ride properly restrained in a back seat, not the front seat. Infants and small children should be restrained in a child seat. Larger children should use a booster seat and a lap/shoulder seat belt until they can use the belt properly without a booster seat.

### ■ Be aware of airbag hazards

While airbags can save lives, they can cause serious or fatal injuries to occupants who sit too close to them, or are not properly restrained. Infants, young children, and short adults are at the greatest risk. Be sure to follow all instructions and warnings in this manual.

### ■ Don't drink and drive

Alcohol and driving don't mix. Even one drink can reduce your ability to respond to changing conditions, and your reaction time gets worse with every additional drink. So don't drink and drive, and don't let your friends drink and drive, either.

### ▣ Important Safety Precautions

Some states, provinces and territories prohibit the use of cell phones other than hands-free devices by the driver while driving.

■ **Pay appropriate attention to the task of driving safely**

Engaging in cell phone conversation or other activities that keep you from paying close attention to the road, other vehicles, and pedestrians could lead to a crash. Remember, situations can change quickly, and only you can decide when it is safe to divert some attention away from driving.

■ **Control your speed**

Excessive speed is a major factor in crash injuries and deaths. Generally, the higher the speed, the greater the risk, but serious injuries can also occur at lower speeds. Never drive faster than is safe for current conditions, regardless of the maximum speed posted.

■ **Keep your vehicle in safe condition**

Having a tire blowout or a mechanical failure can be extremely hazardous. To reduce the possibility of such problems, check your tire pressures and condition frequently, and perform all regularly scheduled maintenance.

## Important Handling Information \*

Your vehicle has higher ground clearance than a passenger vehicle designed for use only on pavement. Higher ground clearance has many advantages for off-highway driving. It allows you to travel over bumps, obstacles, and rough terrain. It also provides good visibility so you can anticipate problems earlier.

These advantages come at some cost. Because your vehicle is taller and rides higher off the ground, it has a higher center gravity making it more susceptible to tripping or roll over if you make abrupt turns. Utility vehicles have a significantly higher rollover rate than other types of vehicles. In a rollover crash, an unbelted person is significantly more likely to die than a person wearing a seat belt. As a reminder, make sure you and your passengers always wear seat belts.

### ▶ Important Handling Information \*

For information on how to reduce the risk of rollover, read:

▶ **Driving Guidelines for Your Utility Vehicle**  
P. 477

▶ **Off-Highway Driving Guidelines** P. 469

Failure to operate your vehicle correctly might result in a crash or a rollover.

## Your Vehicle's Safety Features

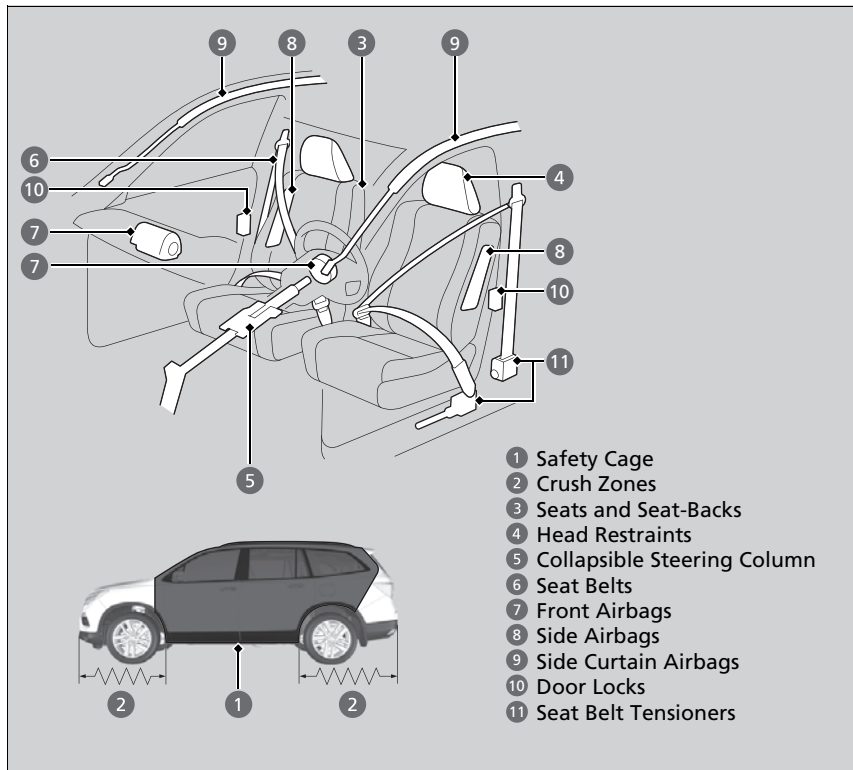

The following checklist will help you take an active role in protecting yourself and your passengers.

### ▣ Your Vehicle's Safety Features

Your vehicle is equipped with many features that work together to help protect you and your passengers during a crash.

Some features do not require any action on your part. These include a strong steel framework that forms a safety cage around the passenger compartment, front and rear crush zones, a collapsible steering column, and tensioners that tighten the front seat belts in a sufficient crash.

However, you and your passengers cannot take full advantage of these features unless you remain seated in the correct position and always wear your seat belts. In fact, some safety features can contribute to injuries if they are not used properly.

## ■ Safety Checklist

For the safety of you and your passengers, make a habit of checking these items each time before you drive.

- After everyone has entered the vehicle, be sure all doors and the tailgate are closed and locked. Locking the doors and the tailgate helps prevent an occupant from being ejected and an outsider from unexpectedly opening a door or the tailgate.

🔧 **Locking/Unlocking the Doors from the Inside** P. 131

- Adjust your seat to a position suitable for driving. Be sure the front seats are adjusted as far to the rear as possible while allowing the driver to control the vehicle. Sitting too close to a front airbag can result in serious or fatal injury in a crash.

🔧 **Adjusting the Seats** P. 174

- Adjust head restraints to the proper position. Head restraints are most effective when the center of the head restraint aligns with the center of your head. Taller persons should adjust their head restraint to the highest position.

🔧 **Adjusting the Head Restraints** P. 179

- Always wear your seat belt, and make sure you wear it properly. Confirm that any passengers are properly belted as well.

🔧 **Fastening a Seat Belt** P. 40

- Protect children by using seat belts or child seats according to a child's age, height and weight.

🔧 **Child Safety** P. 58

## 🔧 Safety Checklist

If the door and/or tailgate open message appears on the multi-information display (MID), a door and/or the tailgate is not completely closed. Close all doors and the tailgate tightly until the message disappears.



## About Your Seat Belts

Seat belts are the single most effective safety device because they keep you connected to the vehicle so that you can take advantage of many built-in safety features. They also help keep you from being thrown against the inside of the vehicle, against other passengers, or out of the vehicle. When worn properly, seat belts also keep your body properly positioned in a crash so that you can take full advantage of the additional protection provided by the airbags.

In addition, seat belts help protect you in almost every type of crash, including:

- frontal impacts
- side impacts
- rear impacts
- rollovers

### ■ Lap/shoulder seat belts

All seven or eight seating positions are equipped with lap/shoulder seat belts with emergency locking retractors. In normal driving the retractor lets you move freely while keeping some tension on the belt. During a collision or sudden stop the retractor locks to restrain your body. The front passenger's, second row and third row seat belts also have a lockable retractor for use with child seats.

🔗 **Installing a Child Seat with a Lap/Shoulder Seat Belt** P. 67

### 🔗 About Your Seat Belts

## ⚠️ WARNING

**Not wearing a seat belt properly increases the chance of serious injury or death in a crash, even though your vehicle has airbags.**

**Be sure you and your passengers always wear seat belts and wear them properly.**

Seat belts cannot completely protect you in every crash. But in most cases, seat belts can reduce your risk of serious injury.

Most states and all Canadian provinces and territories require you to wear seat belts.

The emergency locking retractor may lock if you lean forward too quickly. Slower movements will allow the belt to extend fully without locking.

### ■ Proper use of seat belts

Follow these guidelines for proper use:

- All occupants should sit upright, well back in the seat, and remain in that position for the duration of the trip. Slouching and leaning reduce the effectiveness of the belt and can increase the chance of serious injury in a crash.
- Never place the shoulder part of a lap/shoulder seat belt under your arm or behind your back. This could cause very serious injuries in a crash.
- Two people should never use the same seat belt. If they do, they could be very seriously injured in a crash.
- Do not put any accessories on the seat belts. Devices intended to improve comfort or reposition the shoulder part of a seat belt can reduce the protective capability and increase the chance of serious injury in a crash.

### ■ Seat Belt Reminder



Your vehicle monitors front seat belt use. If the power mode is set to ON before the driver's seat belt is fastened, the beeper will sound and the indicator will blink. If the driver does not fasten the belt before the beeper stops, the indicator will remain on. The beeper will also periodically sound and the indicator will blink while driving until the driver's and front passenger's seat belts are fastened.

### ▶▶ About Your Seat Belts

If a rear seat passenger moves around and extends the seat belt, the lockable retractor may activate. If this happens, release the retractor by unfastening the seat belt and allow the belt to retract completely. Then refasten the belt.

### ▶▶ Seat Belt Reminder

The indicator will also come on if a front passenger does not fasten their seat belt within six seconds after the power mode is set to ON.

When no one is sitting in the front passenger's seat, the indicator will not come on and the beeper will not sound.

This is because the weight sensors in the seat cannot detect their presence.

▶▶ **Protecting Child Passengers** P. 58

## Automatic Seat Belt Tensioners

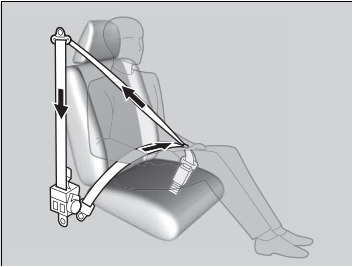

The front seats are equipped with automatic seat belt tensioners to enhance safety.

The tensioners automatically tighten the front seat belts during a moderate-to-severe frontal collision, sometimes even if the collision is not severe enough to inflate the front airbags.

### Automatic Seat Belt Tensioners

The seat belt tensioners can only operate once. If a tensioner is activated, the SRS indicator will come on. Have a dealer replace the tensioner and thoroughly inspect the seat belt system as it may not offer protection in a subsequent crash.

During a moderate-to-severe side impact, the tensioner on that side of the vehicle also activates.



## Fastening a Seat Belt

After adjusting a front seat to the proper position, and while sitting upright and well back in the seat:

▶ **Adjusting the Seats** P. 174

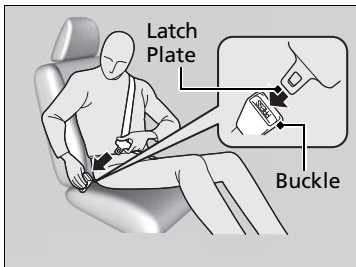
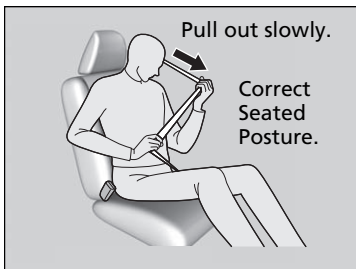

1. Pull the seat belt out slowly.

2. Insert the latch plate into the buckle, then tug on the belt to make sure the buckle is secure.

▶ Make sure that the belt is not twisted or caught on anything.

### Fastening a Seat Belt

No one should sit in a seat with an inoperative seat belt or one that does not appear to be working correctly. Using a seat belt that is not working properly may not protect the occupant in a crash. Have a dealer check the belt as soon as possible.

Never insert any foreign objects into the buckle or retractor mechanism.



3. Position the lap part of the belt as low as possible across your hips, then pull up on the shoulder part of the belt so the lap part fits snugly. This lets your strong pelvic bones take the force of a crash and reduces the chance of internal injuries.
4. If necessary, pull up on the belt again to remove any slack, then check that the belt rests across the center of your chest and over your shoulder. This spreads the forces of a crash over the strongest bones in your upper body.

### ■ Adjusting the Shoulder Anchor

The front seats have adjustable shoulder anchors to accommodate taller and shorter occupants.

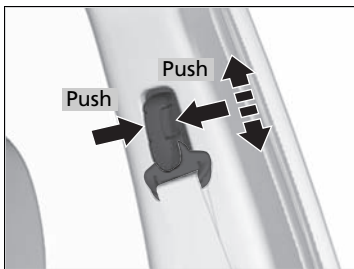

1. Move the anchor up and down while holding the release button.
2. Position the anchor so that the belt rests across the center of your chest and over your shoulder.

### ⌘ Fastening a Seat Belt

## ⚠ WARNING

Improperly positioning the seat belts can cause serious injury or death in a crash.

**Make sure all seat belts are properly positioned before driving.**

To release the belt, push the red **PRESS** button then guide the belt by hand until it has retracted completely.

When exiting the vehicle, be sure the belt is out of the way and will not get caught by closing the door.

### ⌘ Adjusting the Shoulder Anchor

The shoulder anchor height can be adjusted to four levels. If the belt contacts your neck, lower the height one level at a time.

After an adjustment, make sure that the shoulder anchor position is secure.

## ■ Seat Belt with Detachable Anchor

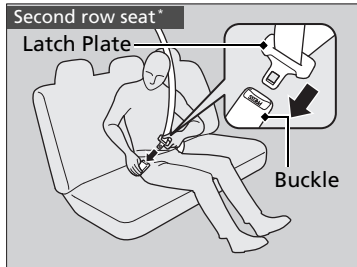
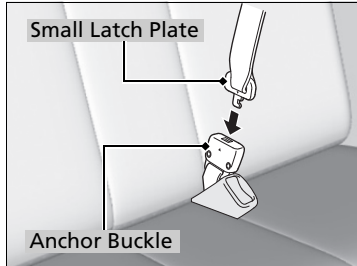
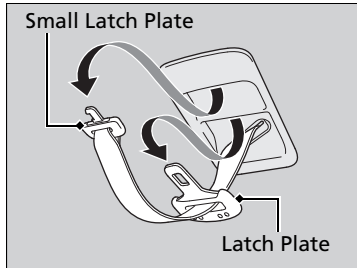

1. Pull out the seat belt's small latch plate and the latch plate from each holding slot in the ceiling.

2. Line up the triangle marks on the small latch plate and anchor buckle. Make sure the seat belt is not twisted. Attach the belt to the anchor buckle.

3. Insert the latch plate into the buckle. Properly fasten the seat belt the same way you fasten the lap/shoulder seat belt.

## ▶▶ Seat Belt with Detachable Anchor

### ⚠ WARNING

Using the seat belt with the detachable anchor unlatched increases the chance of serious injury or death in a crash.

Before using the seat belt, make sure the detachable anchor is correctly latched.

To unlatch the detachable anchor, insert the latch plate into the slot on the side of the anchor buckle.

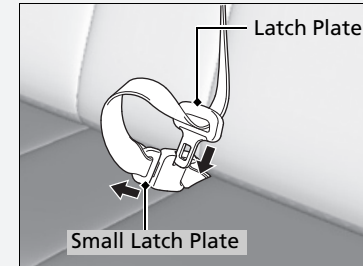

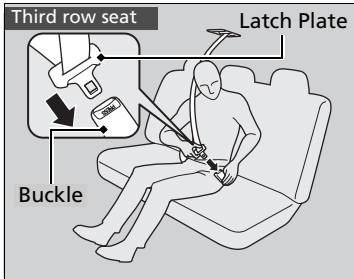

## Advice for Pregnant Women

If you are pregnant, the best way to protect yourself and your unborn child when driving or riding in a vehicle is to always wear a seat belt and keep the lap part of the belt as low as possible across the hips.

Wear the shoulder belt across the chest avoiding the abdomen.



Wear the lap part of the belt as low as possible across the hips.

## Advice for Pregnant Women

Each time you have a checkup, ask your doctor if it is okay for you to drive.

To reduce the risk of injuries to both you and your unborn child that can be caused by an inflating front airbag:

- When driving, sit upright and adjust the seat as far back as possible while allowing full control of the vehicle.
- When sitting in the front passenger's seat, adjust the seat as far back as possible.

## Seat Belt Inspection

Regularly check the condition of your seat belts as follows:

- Pull each belt out fully, and look for frays, cuts, burns, and wear.
- Check that the latch plates and buckles work smoothly and the belts retract easily.
  - ▶ If a belt does not retract easily, cleaning the belt may correct the problem. Only use a mild soap and warm water. Do not use bleach or cleaning solvents. Make sure the belt is completely dry before allowing it to retract.

Any belt that is not in good condition or working properly will not provide proper protection and should be replaced as soon as possible.

A belt that has been worn during a crash may not provide the same level of protection in a subsequent crash. Have your seat belts inspected by a dealer after any collision.

### ▶▶ Seat Belt Inspection

#### **WARNING**

Not checking or maintaining seat belts can result in serious injury or death if the seat belts do not work properly when needed.

Check your seat belts regularly and have any problem corrected as soon as possible.

## Airbag System Components

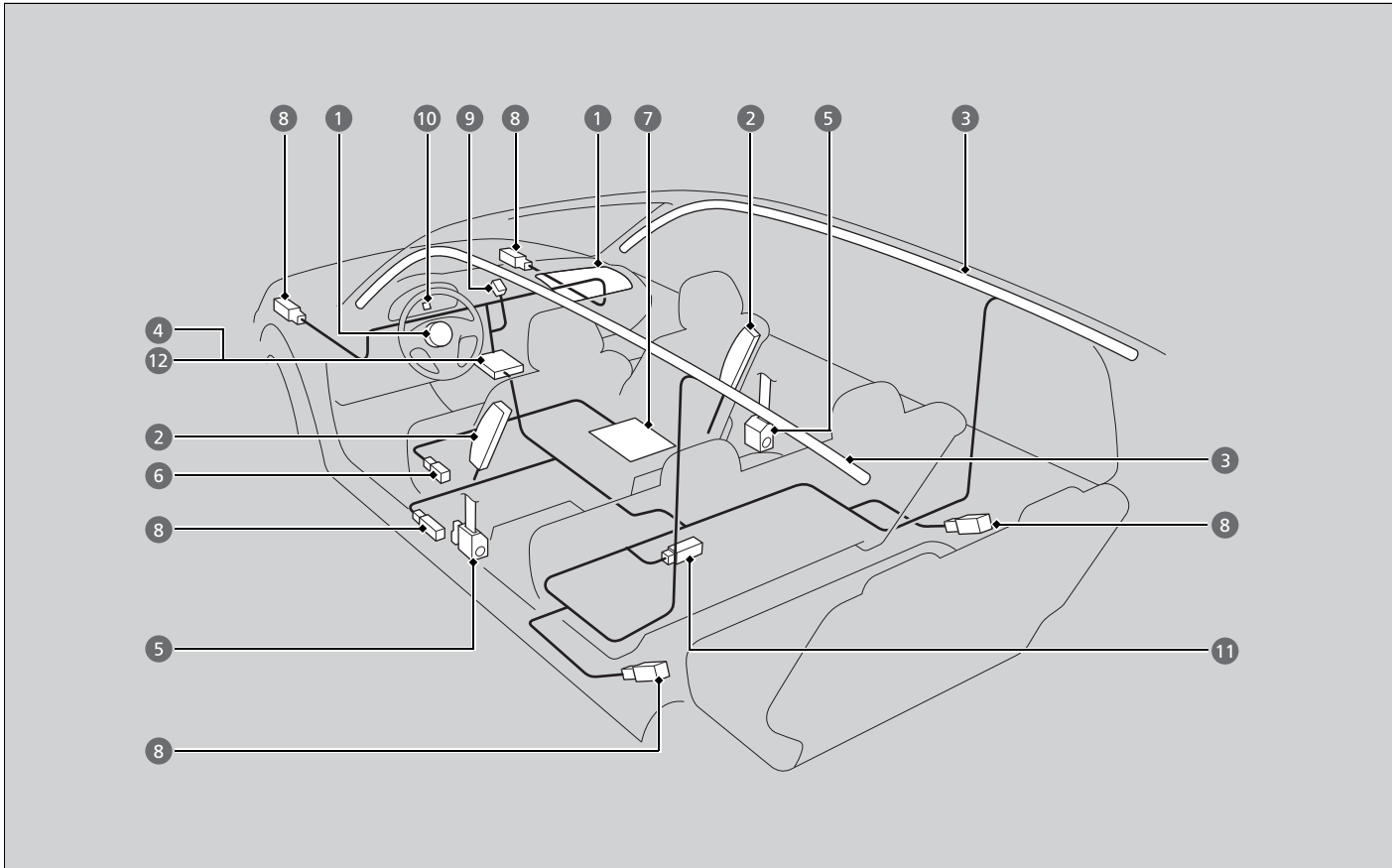

The front, front side, and side curtain airbags are deployed according to the direction and severity of impact. Both side curtain airbags are deployed in a rollover. The airbag system includes:

- 1 Two SRS (Supplemental Restraint System) front airbags. The driver's airbag is stored in the center of the steering wheel; the front passenger's airbag is stored in the dashboard. Both are marked **SRS AIRBAG**.
- 2 Two side airbags, one for the driver and one for a front passenger. The airbags are stored in the outer edges of the seat-backs. Both are marked **SIDE AIRBAG**.
- 3 Two side curtain airbags, one for each side of the vehicle. The airbags are stored in the ceiling, above the side windows. The front and rear pillars are marked **SIDE CURTAIN AIRBAG**.
- 4 An electronic control unit that, when the vehicle is on, continually monitors information about the sensors, the airbag activators, the seat belt tensioners, and driver and front passenger seat belt. During a crash event the unit can record such information.
- 5 Automatic front seat belt tensioners. The driver's and front passenger's seat belts incorporate sensors that detect whether or not they are fastened.
- 6 A driver's seat position sensor. If the seat is too far forward, the airbag will inflate with less force.
- 7 Weight sensors in the front passenger's seat. The front passenger's airbag will be turned off if the weight on the seat is 65 lbs (29 kg) or less (the weight of an infant or small child).
- 8 Impact sensors that can detect a moderate to severe front impact, side impact, or if your vehicle is about to rollover.
- 9 An indicator on the dashboard that alerts you that the front passenger's front airbag has been turned off.
- 10 An indicator on the instrument panel that alerts you to a possible problem with your airbag system or seat belt tensioners.
- 11 Safing Sensor
- 12 A rollover sensor that can detect if your vehicle is about to roll over and signal the control unit to deploy both side curtain airbag.

## Important Facts About Your Airbags

Airbags can pose serious hazards. To do their job, airbags must inflate with tremendous force. So, while airbags help save lives, they can cause burns, bruises, and other minor injuries, sometimes even fatal ones if occupants are not wearing their seat belts properly and sitting correctly.

**What you should do:** Always wear your seat belt properly, and sit upright and as far back from the steering wheel as possible while allowing full control of the vehicle. A front passenger should move their seat as far back from the dashboard as possible.

Remember, however, that no safety system can prevent all injuries or deaths that can occur in a severe crash, even when seat belts are properly worn and the airbags deploy.

**Do not place hard or sharp objects between yourself and a front airbag.**

Carrying hard or sharp objects on your lap, or driving with a pipe or other sharp object in your mouth, can result in injuries if your front airbag inflates.

**Do not attach or place objects on the front airbag covers.** Objects on the covers marked **SRS AIRBAG** could interfere with the proper operation of the airbags or be propelled inside the vehicle and hurt someone if the airbags inflate.

### Important Facts About Your Airbags

Do not attempt to deactivate your airbags. Together, airbags and seat belts provide the best protection.

When driving, keep hands and arms out of the deployment path of the front airbag by holding each side of the steering wheel. Do not cross an arm over the airbag cover.



## Types of Airbags

Your vehicle is equipped with three types of airbags:

- **Front airbags:** Airbags in front of the driver's and front passenger's seats.
- **Side airbags:** Airbags in the driver's and front passenger's seat-backs.
- **Side curtain airbags:** Airbags above the side windows.

Each is discussed in the following pages.

## Front Airbags (SRS)

The front SRS airbags inflate in a moderate-to-severe frontal collision to help protect the head and chest of the driver and/or front passenger.

**SRS** (Supplemental Restraint System) indicates that the airbags are designed to supplement seat belts, not replace them. Seat belts are the occupant's primary restraint system.

### Housing Locations

The front airbags are housed in the center of the steering wheel for the driver, and in the dashboard for the front passenger. Both airbags are marked **SRS AIRBAG**.

### Types of Airbags

The airbags can inflate whenever the power mode is in ON.

After an airbag inflates in a crash, you may see a small amount of smoke. This is from the combustion process of the inflator material and is not harmful. People with respiratory problems may experience some temporary discomfort. If this occurs, get out of the vehicle as soon as it is safe to do so.

### Front Airbags (SRS)

During a frontal crash severe enough to cause one or both front airbags to deploy, the airbags can inflate at different rates, depending on the severity of the crash, whether or not the seat belts are latched, and/or other factors. Frontal airbags are designed to supplement the seat belts to help reduce the likelihood of head and chest injuries in frontal crashes.

## ■ Operation

Front airbags are designed to inflate during moderate-to-severe frontal collisions. When the vehicle decelerates suddenly, the sensors send information to the control unit which signals one or both front airbags to inflate.

A frontal collision can be either head-on or angled between two vehicles, or when a vehicle crashes into a stationary object, such as a concrete wall.

## ■ How the Front Airbags Work

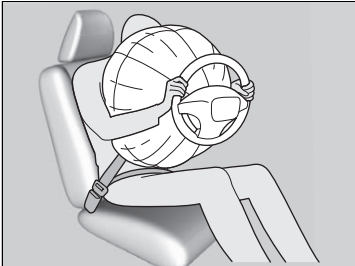

While your seat belt restrains your torso, the front airbag provides supplemental protection for your head and chest.

The front airbags deflate immediately so that they won't interfere with the driver's visibility or the ability to steer or operate other controls.

The total time for inflation and deflation is so fast that most occupants are not aware that the airbags deployed until they see them lying in front of them.

### ✘ How the Front Airbags Work

Although the driver's and front passenger's airbags normally inflate within a split second of each other, it is possible for only one airbag to deploy. This can happen if the severity of a collision is at the margin, or threshold that determines whether or not the airbags will deploy. In such cases, the seat belt will provide sufficient protection, and the supplemental protection offered by the airbag would be minimal.

### ■ When front airbags should not deploy

**Minor frontal crashes:** Front airbags were designed to supplement seat belts and help save lives, not to prevent minor scrapes, or even broken bones that might occur during a less than moderate-to-severe frontal crash.

**Side impacts:** Front airbags can provide protection when a sudden deceleration causes a driver or front passenger to move toward the front of the vehicle. Side airbags and side curtain airbags have been specifically designed to help reduce the severity of injuries that can occur during a moderate-to-severe side impact which can cause the driver or passenger to move toward the side of the vehicle.

**Rear impacts:** Head restraints and seat belts are your best protection during a rear impact. Front airbags cannot provide any significant protection and are not designed to deploy in such collisions.

**Rollovers:** In a rollover, your best form of protection is a seat belt or, if your vehicle is equipped with a rollover sensor, both a seat belt and a side curtain airbag. Front airbags, however, are not designed to deploy in a rollover as they would provide little if any protection.

### ■ When front airbags deploy with little or no visible damage

Because the airbag system senses sudden deceleration, a strong impact to the vehicle framework or suspension might cause one or more of the airbags to deploy. Examples include running into a curb, the edge of a hole, or other low fixed object that causes a sudden deceleration in the vehicle chassis. Since the impact is underneath the vehicle, damage may not be readily apparent.

### ■ When front airbags may not deploy, even though exterior damage appears severe

Since crushable body parts absorb crash energy during an impact, the amount of visible damage does not always indicate proper airbag operation. In fact, some collisions can result in severe damage but no airbag deployment because the airbags would not have been needed or would not have provided protection even if they had deployed.

## Advanced Airbags

The airbags have advanced features to help reduce the likelihood of airbag related injuries to smaller occupants.

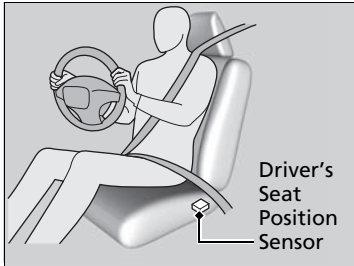

The driver's advanced airbag system includes a seat position sensor.

Based on information from this sensor and the severity of the impact, the advanced airbag system determines the optimal deployment of the driver's airbag.

The front passenger's advanced airbag system has weight sensors.

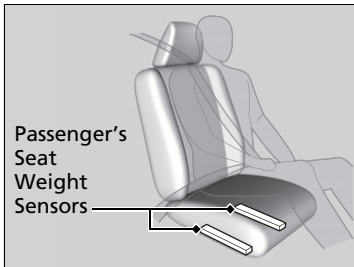

We advise against allowing a child under the age of 12 to ride in the front passenger's seat. However, **if you do allow a child under 12 to ride in the front passenger's seat**, note that the system will automatically turn off the front passenger's airbag if the sensors detect that the child is approximately 65 lbs (29 kg) or less.

### Advanced Airbags

If there is a problem with the driver's seat position sensor, the SRS indicator will come on and the airbag will inflate with full (normal) force, regardless of the driver's seating position.

For the advanced airbags to work properly:

- Do not spill any liquid on or under the seats.
- Do not put any object under the passenger's seat.
- Make sure any objects are positioned properly on the floor. Improperly positioned objects can interfere with the advanced airbag sensors.
- All occupants should sit upright and wear their seat belts properly.
- Do not cover the passenger's side dashboard with a cloth, towel, cover, etc.

Make sure the floor mat behind the front passenger's seat is hooked to the floor mat anchor. An improperly placed mat can interfere with the advanced airbag sensors.

▣ **Floor Mats** P. 614

## Side Airbags

The side airbags help protect the torso and pelvis of the driver or a front passenger during a moderate-to-severe side impact.

### Housing Locations

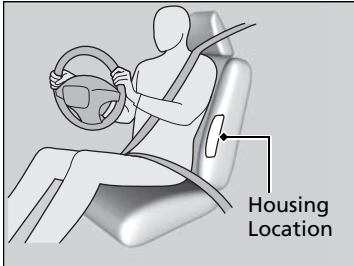

The side airbags are housed in the outside edge of the driver's and passenger's seat-backs.

Both are marked **SIDE AIRBAG**.

### Operation

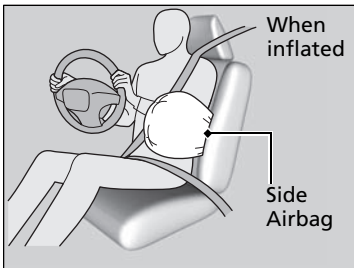

When the sensors detect a moderate-to-severe side impact, the control unit signals the side airbag on the impact side to immediately inflate.

### Side Airbags

Make sure you and your front seat passenger always sit upright. Leaning into the path of a side airbag can prevent the airbag from deploying properly and increases your risk of serious injury.

Do not attach accessories on or near the side airbags. They can interfere with the proper operation of the airbags, or hurt someone if an airbag inflates.

Do not cover or replace the front seat-back covers without consulting a dealer. Improperly replacing or covering front seat-back covers can prevent your side airbags from properly deploying during a side impact.

**■ When a side airbag deploys with little or no visible damage**

Because the airbag system senses sudden acceleration, a strong impact to the side of the vehicle's framework can cause a side airbag to deploy. In such cases, there may be little or no damage, but the side impact sensors detected a severe enough impact to deploy the airbag.

**■ When a side airbag may not deploy, even though visible damage appears severe**

It is possible for a side airbag to not deploy during an impact that results in apparently severe damage. This can occur when the point of impact was toward the far front or rear of the vehicle, or when the vehicle's crushable body parts absorbed most of the crash energy. In either case, the side airbag would not have been needed nor provided protection even if it had deployed.

## Side Curtain Airbags

Side curtain airbags help protect the heads of the driver and passengers in the outer seating positions during a moderate-to-severe side impact. The side curtain airbags equipped in this vehicle are also designed to help reduce the likelihood of partial and complete ejection of vehicle occupants through side windows in crashes, particularly rollover crashes.

### Housing Locations

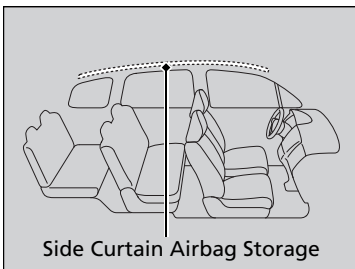

The side curtain airbags are located in the ceiling above the side windows on both sides of the vehicle.

### Operation

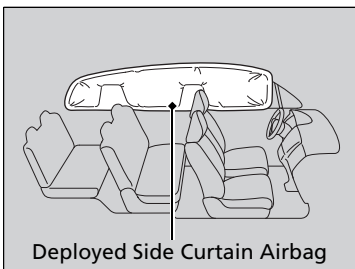

The side curtain airbag is designed to deploy in a rollover or a moderate-to-severe side impact.

### Side Curtain Airbags

If the SRS control unit senses that your vehicle is about to rollover, it immediately deploys both side curtain airbags and activates both front seat belt tensioners.

The airbag on the passenger's side will deploy, even if there are no passengers on that side of the vehicle.

To get the best protection from the side curtain airbags, occupants should wear their seat belts properly and sit upright and well back in their seats.

Do not attach any objects to the side windows or roof pillars as they can interfere with the proper operation of the side curtain airbags.

### ■ When side curtain airbags deploy in a frontal collision

One or both side curtain airbags may also inflate in a moderate-to-severe angled frontal collision.

## Airbag System Indicators

If a problem occurs in the airbag system, the SRS indicator will come on and a message appears on the multi-information display.

### ■ Supplemental Restraint System (SRS) Indicator

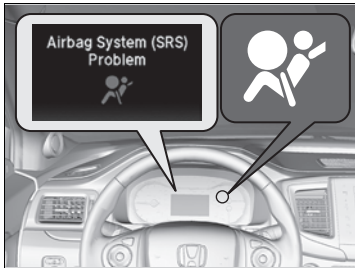

### ■ When the power mode is set to ON

The indicator comes on for a few seconds, then goes off. This tells you the system is working properly.

If the indicator comes on at any other time, or does not come on at all, have the system checked by a dealer as soon as possible. If you don't, your airbags and seat belt tensioners may not work properly when they are needed.

⊠ Supplemental Restraint System (SRS) Indicator

## ⚠ WARNING

Ignoring the SRS indicator can result in serious injury or death if the airbag systems or tensioners do not work properly.

Have your vehicle checked by a dealer as soon as possible if the SRS indicator alerts you to a possible problem.

*Continued*



## ■ Passenger Airbag Off Indicator

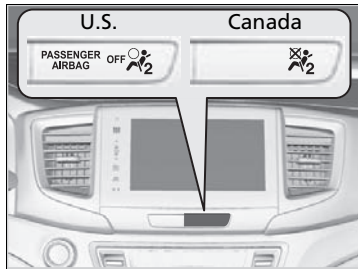

### ■ When the passenger airbag off indicator comes on

The indicator comes on to alert you that the passenger's front airbag has been turned off. This occurs when the front passenger's weight sensors detect 65 lbs (29 kg) or less, the weight of an infant or small child, on the seat.

Infants and small children should always ride properly restrained in a back seat.

📄 **Child Safety** P. 58

Objects placed on the seat can also cause the indicator to come on.

If the front passenger seat is empty, the passenger's front airbag will not deploy and the indicator will not come on.

## 📄 Passenger Airbag Off Indicator

If the indicator comes on with no front passenger and no objects on the passenger's seat, or with an adult riding there, something may be interfering with the weight sensors, such as:

- An object hanging on the seat or in the seat-back pocket.
- A child seat or other object pressing against the rear of the seat-back.
- A rear passenger pushing or pulling on the back of the front passenger's seat.
- The front seat or seat-back is forced back against an object on the seat or floor behind it.
- An object placed under the front passenger's seat.

If none of these conditions exist, have your vehicle checked by a dealer as soon as possible.

The passenger airbag off indicator may come on and go off repeatedly if the total weight on the seat is near the airbag cutoff threshold.

## Airbag Care

You do not need to, and should not, perform any maintenance on or replace any airbag system components yourself. However, you should have your vehicle inspected by a dealer in the following situations:

### ■ When the airbags have deployed

If an airbag has inflated, the control unit and other related parts must be replaced. Similarly, once an automatic seat belt tensioner has been activated, it must be replaced.

### ■ When the vehicle has been in a moderate-to-severe collision

Even if the airbags did not inflate, have your dealer inspect the following: the driver's seat position sensor, weight sensors in the passenger's seat, front seat belt tensioners, and each seat belt that was worn during the crash.

### ■ Do not remove or modify a front seat without consulting a dealer

This would likely disable or affect the proper operation of the driver's seat position sensor or the weight sensors in the passenger's seat. If it is necessary to remove or modify a front seat to accommodate a person with disabilities, contact a Honda dealer, or for U.S. vehicles, American Honda Automobile Customer Service at 1-800-999-1009 and for Canadian vehicles, Honda Canada Customer Relations at 1-888-9-HONDA-9.

#### ✘ Airbag Care

We recommend against the use of salvaged airbag system components, including the airbag, tensioners, sensors, and control unit.

## Protecting Child Passengers

Each year, many children are injured or killed in vehicle crashes because they are either unrestrained or not properly restrained. In fact, vehicle accidents are the number one cause of death of children ages 12 and under.

To reduce the number of child deaths and injuries, every state, Canadian province and territory requires that infants and children be properly restrained when they ride in a vehicle.

**Children should sit properly restrained in a rear seat.** This is because:

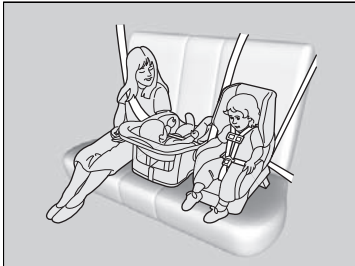

- An inflating front or side airbag can injure or kill a child sitting in the front seat.
- A child in the front seat is more likely to interfere with the driver's ability to safely control the vehicle.
- Statistics show that children of all sizes and ages are safer when they are properly restrained in a rear seat.

### Protecting Child Passengers

#### **WARNING**

**Children who are unrestrained or improperly restrained can be seriously injured or killed in a crash.**

**Any child too small for a seat belt should be properly restrained in a child seat. A larger child should be properly restrained with a seat belt, using a booster seat if necessary.**

The National Highway Traffic Safety Administration and Transport Canada recommend that all children ages 12 and under be properly restrained in a rear seat. Some states or provinces/territories have laws restricting where children may ride.

- Any child who is too small to wear a seat belt correctly must be restrained in an approved child seat that is properly secured to the vehicle using either the seat belt or the lower anchors of the LATCH system.
- Never hold a child on your lap because it is impossible to protect them in the event of a collision.
- Never put a seat belt over yourself and a child. During a crash, the belt would likely press deep into the child and cause serious or fatal injuries.
- Never let two children use the same seat belt. Both children could be very seriously injured in a crash.
- Do not allow children to operate the doors, windows or seat adjustments.
- Do not leave children in the vehicle unattended, especially in hot weather when the inside of the vehicle can get hot enough to kill them. They could also activate vehicle controls causing it to move unexpectedly.

## ▶▶ Protecting Child Passengers

**⚠ WARNING**

Allowing a child to play with a seat belt or wrap one around their neck can result in serious injury or death.

**Instruct children not to play with any seat belt and make sure any unused seat belt a child can reach is buckled, fully retracted, and locked.**

To deactivate a lockable retractor, release the buckle and allow the seat belt to wind up all the way.

To remind you of the passenger's front airbag hazards and child safety, your vehicle warning came with a label on the dashboard (U.S. models) and has labels on the front visors. Please read and follow the instructions on these labels.

▶▶ **Safety Labels** P. 75

## Safety of Infants and Small Children

### ■ Protecting Infants

An infant must be properly restrained in a rear-facing, reclining child seat until the infant reaches the seat manufacturer's weight or height limit for the seat, and the infant is at least one year old.

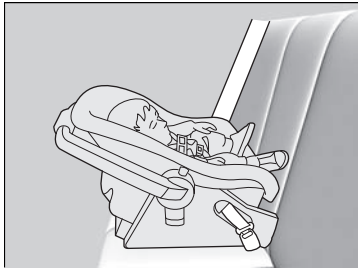

### ■ Positioning a rear-facing child seat

Child seats must be placed and secured in a rear seating position.

When properly installed, a rear-facing child seat may prevent the driver or a front passenger from moving their seat all the way back, or from locking their seat-back in the desired position.

It can also interfere with proper operation of the passenger's advanced front airbag system.

➤ **Airbags** P. 45

If this occurs, we recommend that you install the child seat directly behind the front passenger's seat, move the seat as far forward as needed, and leave it unoccupied. Or, you may wish to get a smaller rear-facing child seat.

### ⊠ Protecting Infants

## ⚠ WARNING

Placing a rear-facing child seat in the front seat can result in serious injury or death during a crash.

Always place a rear-facing child seat in the rear seat, not the front.

Rear-facing child seats should never be installed in a forward facing position.

Always refer to the child seat manufacturer's instructions before installation.

## Protecting Smaller Children

If a child is at least one year old and within the weight range indicated by the child seat manufacturer, the child should be properly restrained in a firmly secured forward-facing child seat.

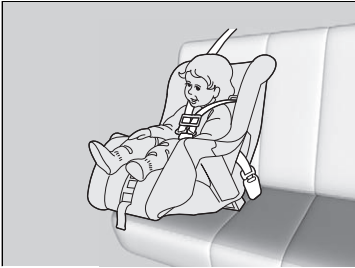

### Forward-facing child seat placement

We strongly recommend placing a forward-facing child seat in a rear seating position.

Placing a forward-facing child seat in the front seat can be hazardous, even with advanced front airbags that automatically turn the passenger's front airbag off. A rear seat is the safest place for a child.

## Protecting Smaller Children

### WARNING

Placing a forward-facing child seat in the front seat can result in serious injury or death if the front airbag inflates.

If you must place a forward-facing child seat in front, move the vehicle seat as far back as possible, and properly restrain the child.

Educate yourself about the laws and regulations regarding child seat use where you are driving, and follow the child seat manufacturer's instructions.

Many experts recommend use of a rear-facing seat for a child up to two years old if the child's height and weight are appropriate for a rear-facing seat.

## ■ Selecting a Child Seat

Most child seats are LATCH-compatible (Lower Anchors and Tethers for Children). Some have a rigid-type connector while others have a flexible-type connector. Both are equally easy to use. Some existing and previously owned child seats can only be installed using the seat belt. Whichever type you choose, follow the child seat manufacturer's use and care instructions as well as the instructions in this manual. Proper installation is key to maximizing your child's safety.

In seating positions and vehicles not equipped with LATCH, a LATCH compatible child seat can be installed using the seat belt and a top tether for added security. This is because all child seats are required to be designed so that they can be secured with a lap belt or the lap part of a lap/shoulder belt. In addition, the child seat manufacturer may advise that a seat belt be used to attach a LATCH-compatible seat once a child reaches a specified weight. Please read the child seat owner's manual for proper installation instructions.

### ■ Important consideration when selecting a child seat

Make sure the child seat meets the following three requirements:

- The child seat is the correct type and size for the child.
- The child seat is the correct type for the seating position.
- The child seat is compliant with Federal Motor Vehicle Safety Standard 213 or Canadian Motor Vehicle Safety Standard 213.

## ▶▶ Selecting a Child Seat

Installation of a LATCH-compatible child seat is simple.

LATCH-compatible child seats have been developed to simplify the installation process and reduce the likelihood of injuries caused by incorrect installation.

## ■ Installing a LATCH-Compatible Child Seat

A LATCH-compatible child seat can be installed in the second and third row seats. A child seat is attached to the lower anchors with either the rigid or flexible type of connectors.

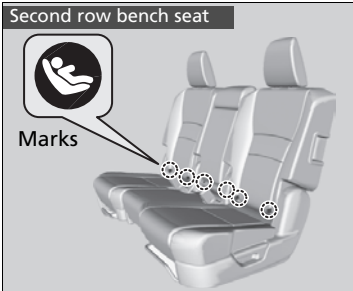

1. Locate the lower anchors under the marks.

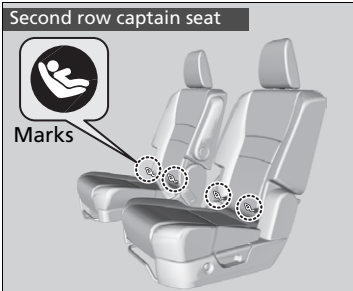



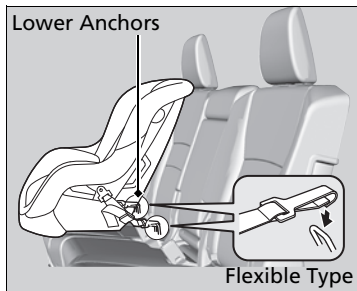
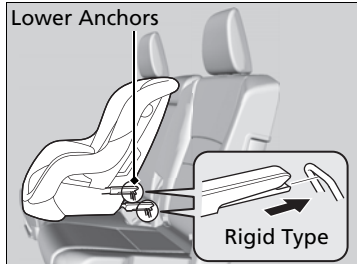
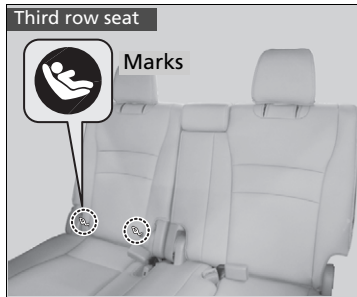

2. Place the child seat on the vehicle seat, then attach the child seat to the lower anchors according to the instructions that came with the child seat.
  - ▶ When installing the child seat, make sure that the lower anchors are not obstructed by the seat belt or any other object.

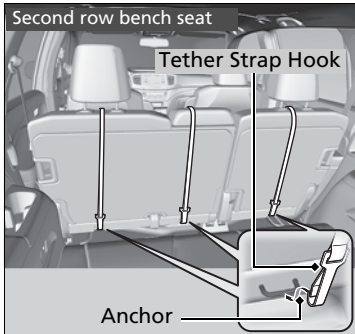

**Second row seat outer positions**

3. Put the outer head restraint to its uppermost position, then route the tether strap between the head restraint legs, and secure the tether strap hook onto the anchor. Make sure the strap is not twisted.

**Third row seat outer positions**

3. Route the tether strap hook between the head restraint legs, and secure the tether strap hook onto the anchor. Make sure the strap is not twisted.

**Center position**

3. Put the center head restraint to its lowest position, then route the tether strap over the top of the head restraint and secure the tether strap hook onto the anchor. Make sure the strap is not twisted.

▶▶ Installing a LATCH-Compatible Child Seat

For your child's safety, when using a child seat installed using the LATCH system, make sure that the child seat is properly secured to the vehicle. A child seat that is not properly secured will not adequately protect a child in a crash and may cause injury to the child or other vehicle occupants.

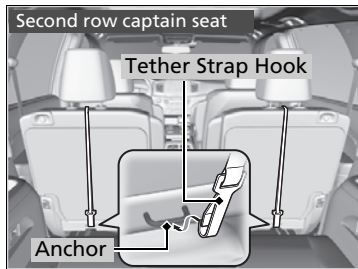

All positions

4. Tighten the tether strap as instructed by the child seat manufacturer.
5. Make sure the child seat is firmly secured by rocking it forward and back and side to side; little movement should be felt.
6. Make sure any unused seat belt that a child can reach is buckled, the lockable retractor is activated, and the belt is fully retracted and locked.

➤ **Protecting Child Passengers** P. 58

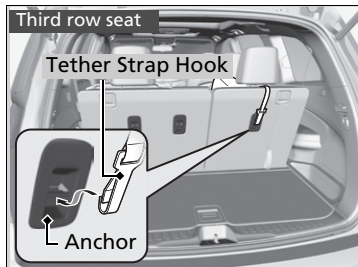

## Installing a Child Seat with a Lap/Shoulder Seat Belt



1. Place the child seat on the vehicle seat.
2. Route the seat belt through the child seat according to the seat manufacturer's instructions, and insert the latch plate into the buckle.
  - ▶ Insert the latch plate fully until it clicks.

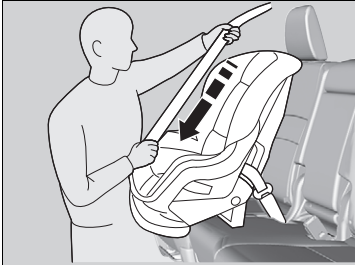

3. Slowly pull the shoulder part of the belt all the way out until it stops. This activates the lockable retractor.
4. Let the seat belt retract if it is completely retracted it unlocks wind up into the retractor, then try to pull it out to make sure the retractor is locked.
  - ▶ If you are able to pull the shoulder belt out, the lockable retractor is not activated. Pull the seat belt all the way out, and repeat steps 3 – 4.

### Installing a Child Seat with a Lap/Shoulder Seat Belt

A child seat that is not properly secured will not adequately protect a child in a crash and may cause injury to the child or other vehicle occupants.

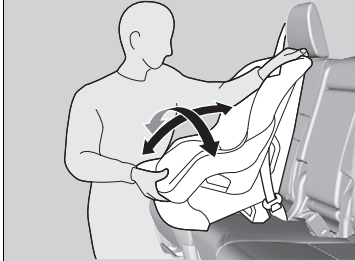
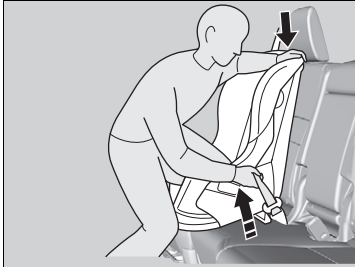

5. Grab the shoulder part of the seat belt near the buckle, and pull up to remove any slack from the lap part of the belt.

▶ When doing this, place your weight on the child seat and push it into the vehicle seat.

6. Make sure the child seat is firmly secured by rocking it forward and back and side to side; little movement should be felt.

7. Make sure any unused seat belt that a child can reach is buckled, the lockable retractor is activated, and the belt is fully retracted and locked.

▶ **Protecting Child Passengers** P. 58

▶▶ Installing a Child Seat with a Lap/Shoulder Seat Belt

To deactivate a lockable retractor, release the buckle and allow the seat belt to wind up all the way.

## Adding Security with a Tether

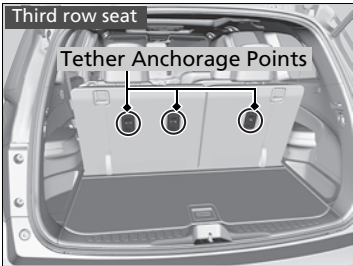
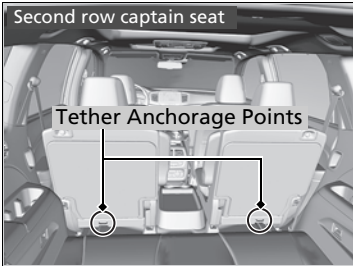
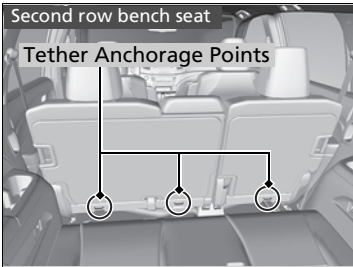

A tether anchorage point is provided behind each second and third row seating position. If you have a child seat that comes with a tether but can be installed with a seat belt, the tether may be used for additional security.

### Adding Security with a Tether

Since a tether can provide additional security to the lap/shoulder seat belt installation, we recommend using a tether whenever one is available.

Continued

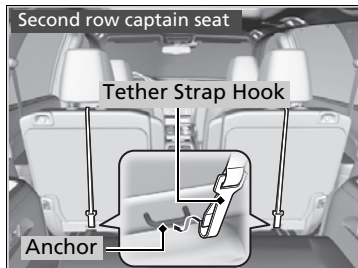
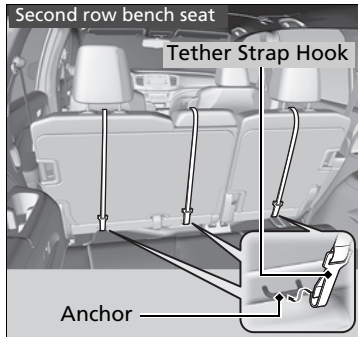

### ■ Using a second row anchor

#### Outer positions

1. Put the outer head restraint to its uppermost position, then route the tether strap between the head restraint legs, and secure the tether strap hook onto the anchor. Make sure the strap is not twisted.

#### Center position

1. Put the center head restraint to its lowest position, then route the tether strap over the top of the head restraint and secure the tether strap hook onto the anchor. Make sure the strap is not twisted.

#### All positions

2. Tighten the tether strap as instructed by the child seat manufacturer.

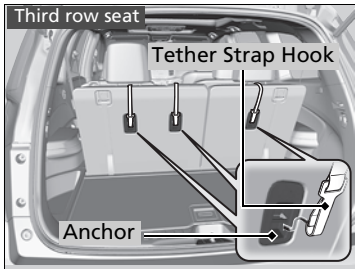

### ■ Using a third row anchor

1. Route the tether strap hook between the head restraint legs, and secure the tether strap hook onto the anchor. Make sure the strap is not twisted.
2. Open the anchor cover.
3. Secure the tether strap hook onto the anchor.
4. Tighten the tether strap as instructed by the child seat manufacturer.



## Safety of Larger Children

### ■ Protecting Larger Children

The following pages give instructions on how to check proper seat belt fit, what kind of booster seat to use if one is needed, and important precautions for a child who must sit in front.

### ■ Checking Seat Belt Fit

When a child is too big for a child seat, secure the child in a rear seat using the lap/shoulder seat belt. Have the child sit upright and all the way back, then answer the following questions.



#### ■ Checklist

- Do the child's knees bend comfortably over the edge of the seat?
- Does the shoulder belt cross between the child's neck and arm?
- Is the lap part of the seat belt as low as possible, touching the child's thighs?
- Will the child be able to stay seated like this for the whole trip?

If you answer yes to all these questions, the child is ready to wear the lap/shoulder seat belt correctly. If you answer no to any question, the child needs to ride on a booster seat until the seat belt fits properly without a booster seat.

### ▶ Safety of Larger Children

## ⚠ WARNING

Allowing a child age 12 or under to sit in front can result in injury or death if the passenger's front airbag inflates.

If a larger child must ride in front, move the vehicle seat as far to the rear as possible, have the child sit up properly and wear the seat belt properly, using a booster seat if needed.

## Booster Seats



If a lap/shoulder seat belt cannot be used properly, position the child in a booster seat in a rear seating position. For the child's safety, check that the child meets the booster seat manufacturer's recommendations.

## Protecting Larger Children-Final Checks

Your vehicle has a rear seat where children can be properly restrained. If you ever have to carry a group of children, and a child must ride in front:

- Make sure you read and fully understand the instructions and safety information in this manual.
- Move the front passenger seat as far back as possible.
- Have the child sit upright and well back in the seat.
- Check that the seat belt is properly positioned so that the child is secure in the seat.

## Monitoring child passengers

We strongly recommend that you keep an eye on child passengers. Even older, more mature children sometimes need to be reminded to fasten their seat belts and sit up properly.

## Booster Seats

When installing a booster seat, make sure to read the instructions that came with it, and install the seat accordingly.

There are high- and low-type booster seats. Choose a booster seat that allows the child to wear the seat belt correctly.

Some U.S. states, and Canadian provinces and territories require children to use a booster seat until they reach a given age or weight (e.g. six years or 60 lbs). Be sure to check current laws in the state or province, or territory where you intend to drive.

## Carbon Monoxide Gas

The engine exhaust from this vehicle contains carbon monoxide, a colorless, odorless, and highly toxic gas. As long as you properly maintain your vehicle, carbon monoxide gas will not get into the interior.

### ■ Have the exhaust system inspected for leaks whenever

- The exhaust system is making an unusual noise.
- The exhaust system may have been damaged.
- The vehicle is raised for an oil change.

When you operate a vehicle with the tailgate open, airflow can pull exhaust gas into the interior and create a hazardous condition. If you must drive with the tailgate open, open all the windows and set the climate control system as shown below.

1. Select the fresh air mode.
2. Select the  mode.
3. Set the fan speed to high.
4. Set the temperature control to a comfortable setting.

Adjust the climate control system in the same manner if you sit in your parked vehicle with the engine running.

### Carbon Monoxide Gas

## WARNING

Carbon monoxide gas is toxic. Breathing it can cause unconsciousness and even kill you.

Avoid any enclosed areas or activities that expose you to carbon monoxide.

An enclosed area such as a garage can quickly fill up with carbon monoxide gas. Do not run the engine with the garage door closed. Even when the garage door is open, drive out of the garage immediately after starting the engine.

## Label Locations

These labels are in the locations shown. They warn you of potential hazards that can cause serious injury or death. Read these labels carefully.

If a label comes off or becomes hard to read (except for the U.S. dashboard label which may be removed by the owner), contact a dealer for a replacement.

**Sun Visor**  
U.S. models

**▲ WARNING**

**EVEN WITH ADVANCED AIR BAGS**

- Children can be killed or seriously injured by the air bag.
- The back seat is the safest place for children.
- Never put a rear-facing child seat in the front.
- Always use seat belts and child restraints.
- See owner's manual for more information about air bags.

**Canadian models**

**CAUTION**  
TO AVOID SERIOUS INJURY:  
• FOR MAXIMUM SAFETY PROTECTION IN ALL TYPES OF CRASHES, YOU MUST ALWAYS WEAR YOUR SAFETY BELT.  
• DO NOT INSTALL REARWARD-FACING CHILD SEATS IN ANY FRONT PASSENGER SEAT POSITION.  
• DO NOT SIT OR LEAN UNNECESSARILY CLOSE TO THE AIR BAG.  
• DO NOT PLACE ANY OBJECTS OVER THE AIR BAG OR BETWEEN THE AIR BAG AND YOURSELF.  
• SEE THE OWNER'S MANUAL FOR FURTHER INFORMATION AND EXPLANATIONS.

**PRECAUTIONS:**  
POUR EVITER DES BLESSURES GRAVES:  
• POUR PROFITER D'UNE PROTECTION MAXIMALE LORS D'UNE COLLISION BOUCLEZ TOUJOURS VOTRE CEINTURE DE SECURITE.  
• N'INSTALLEZ JAMAIS UN SIEGE POUR ENFANTS FAISANT FACE A L'ARRIERE SUR LE SIEGE DU PASSAGER AVANT.  
• NE VOUS APPUYEZ PAS ET NE VOUS ASSOYEZ PAS PRES DU COUSSIN GONFLABLE.  
• NE DEPOSEZ AUCUN OBJET SUR LE COUSSIN GONFLABLE OU ENTRE LE COUSSIN GONFLABLE ET VOUS.  
• LISEZ LE GUIDE UTILISATEUR POUR DE PLUS AMPLES RENSEIGNEMENTS.

**Sun Visor**  
U.S. models only

**▲ WARNING: HIGHER ROLLOVER RISK**

Avoid Abrupt Maneuvers and Excessive Speed.  
Always Buckle Up.  
See Owner's Manual For Further Information.

**Doorjamb**

**SIDE AIRBAG**

- This car is equipped with side airbags in the front seats and side curtain airbags.
- Do not lean against the door.
- See owner's manual for more information.

**Dashboard**  
U.S. models only

This Vehicle is Equipped with Advanced Air Bags

Even with Advanced Air Bags  
Children can be killed or seriously injured by the air bag. The back seat is the safest place for children. Never put a rear-facing child seat in the front. Always use seat belts and child restraints. See owner's manual for more information about air bags.  
to be mounted in front only

**SIDE AIRBAG**

- This car is equipped with side airbags in the front seats and side curtain airbags.
- Do not lean against the door.
- See owner's manual for more information.

**COUSSIN GONFLABLE LATÉRAL**

- Cette automobile est équipée de coussins gonflables latéraux dans les sièges avant ainsi que de coussins gonflables latéraux de type rideau.
- Né vous appuyez pas sur la porte.
- Consultez le Manuel du propriétaire pour en savoir plus.

**Radiator Cap**

**DANGER WARNING**  
危険 警告  
NEVER OPEN WHEN HOT  
Hot coolant will scald you.  
NE VOUS OUVREZ PAS QUAND CHAUD.  
NE PAS OUVRIRE LE MOTEUR CHAUD.  
熱い冷却液がやけどをします。  
エンジンが熱いときは開かない。  
1.1

**Air Conditioner System**  
U.S. models

**▲ WARNING**  
Flammable Refrigerant  
CAUTION: SYSTEM CONTAINS REFRIGERANT (R-1234yf) UNDER HIGH PRESSURE. TO BE SERVICED ONLY BY QUALIFIED PERSONNEL. (See instructions in the service manual.)  
**AIR CONDITIONER SYSTEM**  
REFRIGERANT - R-1234yf (SAE J2810/J2842/J2843)  
REC. CHARGE - MAX 0.725kg MIN 0.675kg  
OIL TYPE - R136SHW OIL (POE)  
TGT Honda Motor Co., Ltd.

**Canadian models**

**▲ WARNING**

**R-1234yf**



# Instrument Panel

This chapter describes the buttons, indicators, and gauges that are used while driving.









## **Indicators**





Multi-Information Display (MID) Warning and Information Messages ..... 97

## **Gauges and Multi-Information Display (MID)**

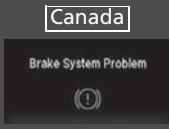

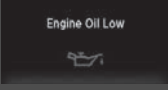

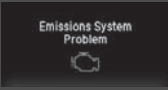

Gauges ..... 113





MID ..... 114

Indicator	Name	On/Blinking	Explanation	Message
 <p>U.S. <b>BRAKE</b> Canada (Red)</p>	Parking Brake and Brake System Indicator (Red)	<ul style="list-style-type: none"> <li>• Comes on for a few seconds when you set the power mode to ON, then goes off if the parking brake has been released.</li> <li>• Comes on when the parking brake is applied, and goes off when it is released.</li> <li>• Comes on when the brake fluid level is low.</li> <li>• Comes on if there is a problem with the brake system.</li> <li>• The beeper sounds and the indicator comes on if you drive with the parking brake not fully released.</li> </ul>	<ul style="list-style-type: none"> <li>• <b>Comes on while driving</b> - Make sure the parking brake is released. Check the brake fluid level.                             <ul style="list-style-type: none"> <li>➤ <b>What to do when the indicator comes on while driving</b> P. 640</li> </ul> </li> <li>• <b>Comes on along with the ABS indicator</b> - Have your vehicle checked by a dealer.                             <ul style="list-style-type: none"> <li>➤ <b>If the Brake System Indicator (Red) Comes On</b> P. 640</li> </ul> </li> </ul>	 <p>Release Parking Brake</p>  <p>WARNING: Brake Fluid Low</p>  <p>Brake System Problem</p>
 <p>U.S. <b>BRAKE SYSTEM</b> Canada (Amber)</p>	Brake System Indicator (Amber)	<ul style="list-style-type: none"> <li>• Comes on for a few seconds when you set the power mode to ON, then goes off.</li> <li>• Comes on if there is a problem with a system related to braking other than the conventional brake system.</li> </ul>	<ul style="list-style-type: none"> <li>• <b>Comes on while driving</b> - Have your vehicle checked by a dealer.</li> <li>• With this indicator on, your vehicle still has normal braking ability.</li> </ul>	 <p>U.S. Brake System Problem</p>  <p>Canada Brake System Problem</p>

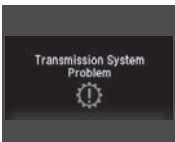





Indicator	Name	On/Blinking	Explanation	Message
	Low Oil Pressure Indicator	<ul style="list-style-type: none"> <li>• Comes on when you set the power mode to ON, and goes off when the engine starts.</li> <li>• Comes on when the engine oil pressure is low.</li> </ul>	<ul style="list-style-type: none"> <li>• <b>Comes on while driving</b> - Immediately stop in a safe place.                             <ul style="list-style-type: none"> <li>▶ <b>If the Low Oil Pressure Indicator Comes On</b> P. 638</li> </ul> </li> </ul>	
	Malfunction Indicator Lamp	<ul style="list-style-type: none"> <li>• Comes on when you set the power mode to ON, and goes off either when the engine starts or after several seconds if the engine did not start. If "readiness codes" have not been set, it blinks five times before it goes off.</li> <li>• Comes on if there is a problem with the emissions control systems.</li> <li>• Blinks when a misfire in the engine's cylinders is detected.</li> </ul>	<ul style="list-style-type: none"> <li>• Readiness codes are part of the on board diagnostics for the emissions control systems.                             <ul style="list-style-type: none"> <li>▶ <b>Testing of Readiness Codes</b> P. 657</li> </ul> </li> <li>• <b>Comes on while driving</b> - Have your vehicle checked by a dealer.</li> <li>• <b>Blinks while driving</b> - Stop in a safe place where there are no flammable objects. Stop the engine for 10 minutes or more, and wait for it to cool down. Then, take your vehicle to a dealer.                             <ul style="list-style-type: none"> <li>▶ <b>If the Malfunction Indicator Lamp Comes On or Blinks</b> P. 639</li> </ul> </li> </ul>	
	Charging System Indicator	<ul style="list-style-type: none"> <li>• Comes on when you set the power mode to ON, and goes off when the engine starts.</li> <li>• Comes on when the battery is not charging.</li> </ul>	<ul style="list-style-type: none"> <li>• <b>Comes on while driving</b> - Turn off the climate control system and rear defogger in order to reduce electricity consumption.                             <ul style="list-style-type: none"> <li>▶ <b>If the Charging System Indicator Comes On</b> P. 638</li> </ul> </li> </ul>	







Indicator	Name	On/Blinking	Explanation	Message
	Gear Position Indicator	<ul style="list-style-type: none"> <li>Indicates the current gear selection.</li> </ul>	 <b>Shifting</b> P. 479, 481	
	M (sequential mode) Indicator/ Sequential Mode Gear Selection Indicator*	<ul style="list-style-type: none"> <li>Comes on when the manual sequential shift mode is applied.</li> </ul>	 <b>Sequential Mode</b> P. 487	
	Transmission Indicator	<p>Automatic transmission models with shift lever</p> <ul style="list-style-type: none"> <li>Blinks if the transmission system has a problem.</li> </ul>	<ul style="list-style-type: none"> <li><b>Blinks while driving</b> - Avoid sudden starts and acceleration and have the vehicle checked by a dealer immediately.</li> </ul>	





Indicator	Name	On/Blinking	Explanation	Message
	Transmission Indicator	<p>Automatic transmission models with electronic gear selector</p> <ul style="list-style-type: none"> <li>The indicated current gear selection blinks if there is a problem with the transmission system.</li> </ul>	<ul style="list-style-type: none"> <li>Avoid sudden start and acceleration, and stop in a safe place immediately. Have your vehicle checked by a dealer.</li> </ul>	
		<p>Automatic transmission models with electronic gear selector</p> <ul style="list-style-type: none"> <li>All the gear positions may light for several seconds, and go off.</li> </ul>	<ul style="list-style-type: none"> <li>When all the gear positions light, immediately stop your vehicle in a safe place.</li> <li>Indicators go off if there is no problem. However, even if they go off, take your vehicle to a dealer for inspection.</li> </ul>	
		<p>Automatic transmission models with electronic gear selector</p> <ul style="list-style-type: none"> <li>The indicated current gear selection or all the gear positions blink if there is a problem with the transmission system, and the vehicle no longer moves.</li> </ul>	<ul style="list-style-type: none"> <li>Immediately stop in a safe place.                             <ul style="list-style-type: none"> <li>➤ <b>Emergency Towing</b> P. 647</li> </ul> </li> <li>Have your vehicle checked by a dealer.</li> </ul>	
		<p>Automatic transmission models with electronic gear selector</p> <ul style="list-style-type: none"> <li>The indicated current gear selection or all the gear positions blink if you cannot select <b>P</b> due to the transmission system failure.</li> </ul>	<ul style="list-style-type: none"> <li>The engine can be activated as a temporary measure.                             <ul style="list-style-type: none"> <li>➤ <b>If the Transmission Indicator Blinks along with the Warning Message*</b> P. 641</li> </ul> </li> <li>Set the parking brake when parking.</li> <li>Have your vehicle checked by a dealer immediately.</li> </ul>	

\* Not available on all models

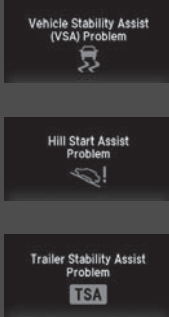
Indicator	Name	On/Blinking	Explanation	Message
	Seat Belt Reminder Indicator	<ul style="list-style-type: none"> <li>• Comes on and the beeper sounds if you are not wearing a seat belt when you set the power mode to ON.</li> <li>• If the front passenger is not wearing a seat belt, the indicator comes on about a few seconds later.</li> <li>• Blinks while driving if either you or the front passenger has not fastened a seat belt. The beeper sounds and the indicator blinks at regular intervals.</li> </ul>	<ul style="list-style-type: none"> <li>• The beeper stops and the indicator goes off when you and the front passenger fasten their seat belts.</li> <li>• <b>Stays on after you or the front passenger has fastened the seat belt</b> - A detection error may have occurred in the sensor. Have your vehicle checked by a dealer.                         <ul style="list-style-type: none"> <li>▣ <b>Seat Belt Reminder</b> P. 38</li> </ul> </li> </ul>	 
	Low Fuel Indicator	<ul style="list-style-type: none"> <li>• Comes on when the fuel reserve is running low (approximately 2.5 U.S. gal./9.5 Liter left).</li> <li>• Blinks if there is a problem with the fuel gauge.</li> </ul>	<ul style="list-style-type: none"> <li>• <b>Comes on</b> - Refuel your vehicle as soon as possible.</li> <li>• <b>Blinks</b> - Have your vehicle checked by a dealer.</li> </ul>	 









Indicator	Name	On/Blinking	Explanation	Message
	Anti-lock Brake System (ABS) Indicator	<ul style="list-style-type: none"> <li>• Comes on for a few seconds when you set the power mode to ON, then goes off.</li> <li>• If it comes on at any other time, there is a problem with the ABS.</li> </ul>	<ul style="list-style-type: none"> <li>• <b>Stays on constantly</b> - Have your vehicle checked by a dealer. With this indicator on, your vehicle still has normal braking ability but no anti-lock function.  <span style="font-size: small;">📖 <b>Anti-lock Brake System (ABS)</b> P. 541</span> </li> </ul>	
	Supplemental Restraint System Indicator	<ul style="list-style-type: none"> <li>• Comes on for a few seconds when you set the power mode to ON, then goes off.</li> <li>• Comes on if a problem with any of the following is detected:                             <ul style="list-style-type: none"> <li>- Supplemental restraint system</li> <li>- Side airbag system</li> <li>- Side curtain airbag system</li> <li>- Seat belt tensioner</li> </ul> </li> </ul>	<ul style="list-style-type: none"> <li>• <b>Stays on constantly or does not come on at all</b> - Have your vehicle checked by a dealer.</li> </ul>	

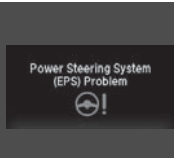

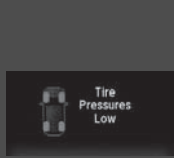

Indicator	Name	On/Blinking	Explanation	Message
	Vehicle Stability Assist (VSA®) System Indicator	<ul style="list-style-type: none"> <li>• Comes on for a few seconds when you set the power mode to ON, then goes off.</li> <li>• Blinks when VSA®, or trailer stability assist is active.</li> <li>• Comes on if there is a problem with the VSA®, hill start assist, trailer stability assist or brake lighting system.</li> </ul>	<ul style="list-style-type: none"> <li>• <b>Stays on constantly</b> - Have your vehicle checked by a dealer.                             <ul style="list-style-type: none"> <li>➤ <b>Vehicle Stability Assist (VSA®), aka Electronic Stability Control (ESC), System</b> P. 527</li> <li>➤ <b>Trailer Stability Assist</b> P. 466</li> <li>➤ <b>Hill start assist system</b> P. 476</li> </ul> </li> <li>• When <b>Trailer Stability Assist Problem</b> is displayed on the MID, the VSA® does not activate.</li> </ul>	

Indicator	Name	On/Blinking	Explanation	Message
	Vehicle Stability Assist (VSA®) OFF Indicator	<ul style="list-style-type: none"> <li>• Comes on for a few seconds when you set the power mode to ON, then goes off.</li> </ul>	—	—
		<ul style="list-style-type: none"> <li>• Comes on when VSA® OFF switch is pressed.</li> </ul>	<ul style="list-style-type: none"> <li>• Appears when Normal or Snow Mode is selected.                      ▶ <b>VSA® On and Off</b> P. 528</li> </ul>	
		<p><b>AWD models</b></p> <ul style="list-style-type: none"> <li>• Comes on when Mud/Sand mode is selected by pressing Intelligent Traction Management System switch.</li> </ul>	<ul style="list-style-type: none"> <li>• Appears when Mud Mode is selected.                      ▶ <b>Intelligent Traction Management*</b> P. 495</li> </ul>	
			<ul style="list-style-type: none"> <li>• Appears when Sand Mode is selected.                      ▶ <b>Intelligent Traction Management*</b> P. 495</li> </ul>	
		<p><b>AWD models</b></p> <ul style="list-style-type: none"> <li>• Comes on when VSA® OFF switch is pressed.</li> </ul>	<ul style="list-style-type: none"> <li>• Appears when Mud or Sand Mode is selected.                      ▶ <b>VSA® On and Off</b> P. 528</li> </ul>	

Instrument Panel







\* Not available on all models





Indicator	Name	On/Blinking	Explanation	Message
	Electric Power Steering (EPS) System Indicator	<ul style="list-style-type: none"> <li>Comes on when you set the power mode to ON, and goes off when the engine starts.</li> <li>Comes on if there is a problem with the EPS system.</li> </ul>	<ul style="list-style-type: none"> <li><b>Stays on constantly or does not come on at all</b> - Have your vehicle checked by a dealer.                             <ul style="list-style-type: none"> <li>✉ <b>If the Electric Power Steering (EPS) System Indicator Comes On</b> P. 640</li> </ul> </li> </ul>	
	Low Tire Pressure/TPMS Indicator	<ul style="list-style-type: none"> <li>Comes on for a few seconds when you set the power mode to ON, then goes off.</li> <li>Comes on if the tire pressure of any of the tires becomes significantly low.</li> <li>Blinks for about one minute, and then stays on if there is a problem with the TPMS with Tire Fill Assist, or when a compact spare tire* is temporarily installed.</li> </ul>	<ul style="list-style-type: none"> <li><b>Comes on while driving</b> - Stop in a safe place, check tire pressures, and inflate the tire(s) if necessary.</li> <li><b>Blinks and remains on</b> - Have your vehicle checked by a dealer. If the vehicle is fitted with a compact spare, get your regular tire repaired or replaced and put back on your vehicle as soon as you can.</li> </ul>	 
	Turn Signal and Hazard Warning Indicators	<ul style="list-style-type: none"> <li>Blinks when you operate the turn signal lever.</li> <li>Blinks along with all turn signals if you press the hazard warning button.</li> </ul>	<ul style="list-style-type: none"> <li><b>Does not blink or blinks rapidly</b> - A turn signal light bulb has blown. Change the bulb immediately.                             <ul style="list-style-type: none"> <li>✉ <b>Front Turn Signal/Parking* and Fog* Light Bulbs</b> P. 590</li> </ul> </li> </ul>	
	High Beam Indicator	<ul style="list-style-type: none"> <li>Comes on when the high beam headlights are on.</li> </ul>	—	

Indicator	Name	On/Blinking	Explanation	Message
	Lights On Indicator	<ul style="list-style-type: none"> <li>Comes on whenever the light switch is on, or in <b>AUTO</b> when the exterior lights are on.</li> </ul>	<ul style="list-style-type: none"> <li>If you set the power mode to ACCESSORY or VEHICLE OFF (LOCK) while the lights are on, a chime sounds when the driver's door is opened.</li> </ul>	—
	Auto high-beam system Indicator*	<ul style="list-style-type: none"> <li>Comes on when all the operating conditions of the Auto high-beam system are met.</li> </ul>	 <b>Auto High-Beam System</b> * P. 160	—
	Fog Light Indicator*	<ul style="list-style-type: none"> <li>Comes on when the fog lights are on.</li> </ul>	—	—
	Immobilizer System Indicator	<ul style="list-style-type: none"> <li>Comes on briefly when you set the power mode to ON, then goes off.</li> <li>Comes on if the immobilizer system cannot recognize the key information.</li> </ul>	<ul style="list-style-type: none"> <li><b>Blinks</b> - You cannot start the engine. Set the power mode to VEHICLE OFF (LOCK), then select the ON mode again.</li> <li><b>Repeatedly blinks</b> - The system may be malfunctioning. Have your vehicle checked by a dealer.</li> <li>Do not attempt to alter this system or add other devices to it. Electrical problems can occur.</li> </ul>	—



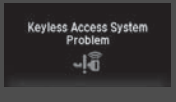
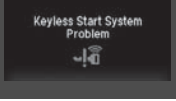

\* Not available on all models









Indicator	Name	On/Blinking	Explanation	Message
	Security System Alarm Indicator	<ul style="list-style-type: none"> <li>Blinks when the security system alarm has been set.</li> </ul>	 <b>Security System Alarm</b> P. 143	—
	System Message Indicator	<ul style="list-style-type: none"> <li>Comes on for a few seconds when you set the power mode to ON, then goes off.</li> <li>Comes on along with a beep when a problem is detected. A system message on the MID appears at the same time.</li> </ul>	<ul style="list-style-type: none"> <li>While the indicator is on, roll the multi-function steering wheel control to see the message again.</li> <li>Refer to the Indicators information in this chapter when a system message appears on the MID. Take the appropriate action for the message.</li> <li>The MID does not return to the normal screen unless the warning is canceled, or the multi-function steering-wheel controls is rolled.</li> </ul>	—
	<b>CRUISE MAIN</b> Indicator*	<ul style="list-style-type: none"> <li>Comes on when you press the <b>CRUISE</b> button.</li> </ul>	 <b>Cruise Control</b> * P. 497	—
	<b>CRUISE CONTROL</b> Indicator*	<ul style="list-style-type: none"> <li>Comes on when you have set a speed for cruise control.</li> </ul>	 <b>Cruise Control</b> * P. 497	—

Indicator	Name	On/Blinking	Explanation	Message
	Smart Entry System Indicator*	<ul style="list-style-type: none"> <li>Comes on for a few seconds when you set the power mode to ON, then goes off.</li> <li>Comes on as soon as a problem is detected in the smart entry system or keyless starting system.</li> </ul>	<ul style="list-style-type: none"> <li>Have your vehicle checked by a dealer.</li> </ul>	 
	All-wheel drive (AWD) Indicator*	<ul style="list-style-type: none"> <li>Comes on for a few seconds when you set the power mode to ON, then goes off.</li> <li>Comes on if there is a problem with the AWD system.</li> <li>Blinks when the differential temperature is too high.</li> </ul>	<ul style="list-style-type: none"> <li><b>Stays on constantly</b> - The engine drives the front wheels only in this state. Have your vehicle checked by a dealer.</li> <li><b>Blinks while driving</b> - Stop in a safe place, change to <b>P</b>, and idle the engine until the indicator goes off. If the indicator does not stop blinking, take your vehicle to a dealer.   <b>Intelligent VTM4 (i-VTM4)*</b> P. 534</li> </ul>	 





\* Not available on all models

Indicator	Name	On/Blinking	Explanation	Message
	Auto Idle-stop Indicator (Green)*	<ul style="list-style-type: none"> <li>Comes on when Auto Idle-stop is in operation. The engine automatically shuts off.</li> </ul>	 <b>Auto Idle-stop*</b> P. 489	—
	Auto Idle-stop System Indicator (Amber)*	<ul style="list-style-type: none"> <li>Comes on for a few seconds when you set the power mode to ON, then goes off.</li> <li>Blinks if there is a problem with the Auto Idle-stop System.</li> <li>Comes on when Auto Idle-stop System has been turned off by Auto Idle-stop <b>OFF</b> Button.</li> </ul>	<ul style="list-style-type: none"> <li><b>Blinks</b> - Have your vehicle checked by a dealer.</li> </ul>	

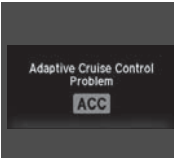
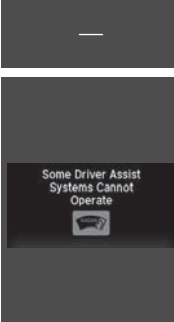

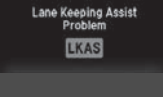

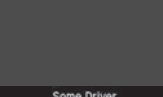

Indicator	Name	On/Blinking	Explanation	Message
	Road Departure Mitigation (RDM) Indicator*	<ul style="list-style-type: none"> <li>• Comes on for a few seconds when you change the power mode to ON, then goes off.</li> <li>• Comes on if there is a problem with the RDM system.</li> </ul>	<ul style="list-style-type: none"> <li>• <b>Stays on constantly</b> - Have your vehicle checked by a dealer.</li> </ul>	
		<ul style="list-style-type: none"> <li>• Comes on when the RDM system shuts itself off.</li> </ul>	<ul style="list-style-type: none"> <li>• <b>Stays on</b> - The temperature inside the camera is too high. Use the climate control system to cool down the camera. The system activates when the temperature inside the camera cools down.   <b>Front Sensor Camera</b>* P. 500</li> </ul>	
			<ul style="list-style-type: none"> <li>• <b>Stays on</b> - The area around the camera is blocked by dirt, mud, etc. Stop your vehicle in a safe place, and wipe it off with a soft cloth.</li> <li>• Have your vehicle checked by a dealer if the indicator and message come back on after you cleaned the area around the camera.   <b>Front Sensor Camera</b>* P. 500</li> </ul>	

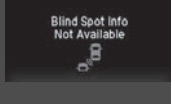
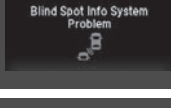

\* Not available on all models

Indicator	Name	On/Blinking	Explanation	Message
<b>ACC</b>	Adaptive Cruise Control (ACC) Indicator (Amber)*	<ul style="list-style-type: none"> <li>Comes on for a few seconds when you set the power mode to ON, then goes off.</li> <li>Comes on if there is a problem with ACC.</li> </ul>	<ul style="list-style-type: none"> <li><b>Comes on while driving</b> - Have your vehicle checked by a dealer.</li> </ul>	
<b>ACC</b>	Adaptive Cruise Control (ACC) Indicator (Green)*	<ul style="list-style-type: none"> <li>Comes on when you press the <b>MAIN</b> button.</li> <li>Comes on if anything covers the radar sensor cover and prevents the sensor from detecting a vehicle in front.</li> <li>May come on when driving in bad weather (rain, snow, fog, etc.)</li> <li>ACC has been automatically canceled.</li> </ul>	<p>➤ <b>Adaptive Cruise Control (ACC)*</b> P. 502</p> <ul style="list-style-type: none"> <li>When the radar sensor gets dirty, stop your vehicle in a safe place, and wipe off dirt using a soft cloth.</li> <li>Have your vehicle checked by a dealer if the message does not disappear even after you clean the sensor cover.</li> </ul>	

Indicator	Name	On/Blinking	Explanation	Message
<b>LKAS</b>	Lane Keeping Assist System (LKAS) Indicator (Amber)*	<ul style="list-style-type: none"> <li>• Comes on for a few seconds when you set the power mode to ON, then goes off.</li> <li>• Comes on if there is a problem with the LKAS.</li> </ul>	<ul style="list-style-type: none"> <li>• <b>Stays on constantly</b> - Have your vehicle checked by a dealer.</li> </ul>	
<b>LKAS</b>	Lane Keeping Assist System (LKAS) Indicator (Green)*	<ul style="list-style-type: none"> <li>• Comes on when you press the <b>MAIN</b> button.</li> <li>• Comes on when the LKAS is in operation, or the LKAS button is pressed, but the temperature inside the front sensor camera is too high. The LKAS cancels automatically. The beeper sounds simultaneously.</li> <li>• Comes on when the area around the camera is blocked by dirt, mud, etc. Stop your vehicle in a safe place, and wipe it off with a soft cloth.</li> <li>• May come on when driving in bad weather (rain, snow, fog, etc.)</li> </ul>	<ul style="list-style-type: none"> <li>•  <b>Lane Keeping Assist System (LKAS)*</b> P. 519</li> <li>• Use the climate control system to cool down the camera.</li> <li>• <b>Goes off</b> - The camera has been cooled down and the system activates normally.  <b>Front Sensor Camera*</b> P. 500</li> <li>• Have your vehicle checked by a dealer if the indicator and message come back on after you cleaned the area around the camera.</li> </ul>	 





\* Not available on all models

Indicator	Name	On/Blinking	Explanation	Message
	Blind spot information (BSI) Indicator*	<ul style="list-style-type: none"> <li>Comes on for a few seconds when you set the power mode to ON, then goes off.</li> <li>Stays on while BSI is turned off.</li> </ul>	—	
		<ul style="list-style-type: none"> <li>Comes on when mud, snow, or ice accumulates in the vicinity of sensor.</li> </ul>	<ul style="list-style-type: none"> <li><b>Comes on while driving</b> - Remove the obstacle in the vicinity of sensor.   <b>Blind spot information (BSI) System*</b>                      P. 530</li> </ul>	
		<ul style="list-style-type: none"> <li>Comes on if there is a problem with the system.</li> </ul>	<ul style="list-style-type: none"> <li><b>Comes on while driving</b> - Have your vehicle checked by a dealer.</li> </ul>	
	ECON Mode Indicator	<ul style="list-style-type: none"> <li>Comes on for a few seconds when you set the power mode to ON, then goes off.</li> <li>Comes on when you press the ECON button.</li> </ul>	 <b>ECON Button</b> P. 494	

Indicator	Name	On/Blinking	Explanation	Message
	Collision Mitigation Braking System™ (CMBS™) Indicator*	<ul style="list-style-type: none"> <li>• Comes on for a few seconds when you change the power mode to ON, then goes off.</li> <li>• Comes on when you deactivate the CMBS™. A multi-information display message appears for five seconds.</li> <li>• Comes on if there is a problem with the CMBS™.</li> </ul>	<ul style="list-style-type: none"> <li>• <b>Stays on constantly without the CMBS™ off</b> - Have your vehicle checked by a dealer.                             <ul style="list-style-type: none"> <li>▶ <b>Collision Mitigation Braking System™ (CMBS™)*</b> P. 543</li> </ul> </li> </ul>	

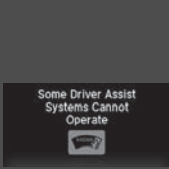

\* Not available on all models







Indicator	Name	On/Blinking	Explanation	Message
	Collision Mitigation Braking System™ (CMBS™) Indicator*	<ul style="list-style-type: none"> <li>• Comes on when the CMBS™ system shuts itself off.</li> </ul>	<ul style="list-style-type: none"> <li>• <b>Stays on</b> - The area around the camera is blocked by dirt, mud, etc. Stop your vehicle in a safe place, and wipe it off with a soft cloth.                             <ul style="list-style-type: none"> <li>➤ <b>Front Sensor Camera*</b> P. 500</li> </ul> </li> <li>• When the radar sensor gets dirty, stop your vehicle in a safe place, and wipe off dirt using a soft cloth.</li> <li>• Have your vehicle checked by a dealer if the message does not disappear even after you clean the sensor cover.                             <ul style="list-style-type: none"> <li>➤ <b>Collision Mitigation Braking System™ (CMBS™)*</b> P. 543</li> </ul> </li> <li>• <b>Stays on</b> - The temperature inside the camera is too high. Use the climate control system to cool down the camera. The system activates when the temperature inside the camera cools down.                             <ul style="list-style-type: none"> <li>➤ <b>Front Sensor Camera*</b> P. 500</li> </ul> </li> </ul>	  

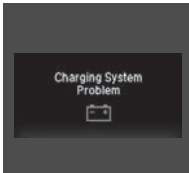
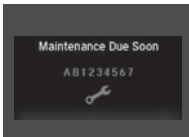
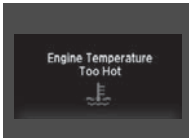

## Multi-Information Display (MID) Warning and Information Messages





The following messages appear only on the MID. Press the  (information) button to see the message again with the system message indicator on.

Message	Condition	Explanation
  	<ul style="list-style-type: none"> <li>• Appears if any door or the tailgate is not completely closed.</li> </ul>	<ul style="list-style-type: none"> <li>• Goes off when all doors and the tailgate are closed.</li> </ul>

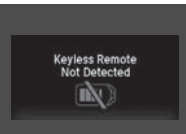
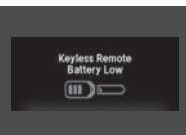
Message	Condition	Explanation
 <p>Washer Fluid Low</p>	<ul style="list-style-type: none"> <li>• Appears when the washer fluid is low. *</li> </ul>	<ul style="list-style-type: none"> <li>• Refill washer fluid.                             <ul style="list-style-type: none"> <li>➤ <b>Refilling Window Washer Fluid</b> P. 586</li> </ul> </li> </ul>
 <p>Charging System Problem</p>	<ul style="list-style-type: none"> <li>• Appears when there is a problem with the sensor on the battery.</li> <li>• Appears along with the battery charging system indicator when the battery is not charging.</li> </ul>	<ul style="list-style-type: none"> <li>• Have your vehicle checked by a dealer.                             <ul style="list-style-type: none"> <li>➤ <b>Checking the Battery</b> P. 606</li> </ul> </li> <li>• Turn off the climate control system and rear defogger to reduce electricity consumption.                             <ul style="list-style-type: none"> <li>➤ <b>If the Charging System Indicator Comes On</b> P. 638</li> </ul> </li> </ul>
 <p>Maintenance Due Soon</p> <p>AB1234567</p>	<ul style="list-style-type: none"> <li>• Appears when the scheduled maintenance is due soon.</li> <li>• Consequently, <b>Maintenance Due Now</b> and <b>Maintenance Past Due</b> follow.</li> </ul>	<ul style="list-style-type: none"> <li>➤ <b>Maintenance Minder Messages on the Multi-Information Display (MID)</b> P. 572</li> </ul>
 <p>Engine Temperature Too Hot</p>	<ul style="list-style-type: none"> <li>• Appears when the engine coolant temperature gets abnormally high.</li> </ul>	<ul style="list-style-type: none"> <li>➤ <b>Overheating</b> P. 636</li> </ul>

Message	Condition	Explanation
<div style="background-color: #333; color: white; padding: 5px; margin-bottom: 5px;"> <span style="border: 1px solid white; padding: 2px;">U.S.</span>                      Power Tailgate Problem   </div> <div style="background-color: #333; color: white; padding: 5px;"> <span style="border: 1px solid white; padding: 2px;">Canada</span>                      Power Tailgate Problem   </div>	<ul style="list-style-type: none"> <li>• Appears when there is a problem with the power tailgate system.</li> </ul>	<ul style="list-style-type: none"> <li>• Manually open or close the power tailgate.</li> <li>• Have your vehicle checked by a dealer.</li> </ul>
<div style="background-color: #333; color: white; padding: 5px; margin-bottom: 5px;"> <span style="border: 1px solid white; padding: 2px;">U.S.</span>                      Starter System Problem   </div> <div style="background-color: #333; color: white; padding: 5px;"> <span style="border: 1px solid white; padding: 2px;">Canada</span>                      Starter System Problem   </div>	<ul style="list-style-type: none"> <li>• Appears if there is a problem with the starter system.</li> </ul>	<ul style="list-style-type: none"> <li>• Hold the <b>ENGINE START/STOP</b> button up to 15 seconds to start the engine.  <span style="font-size: 0.8em;">▶ <b>Starting the Engine</b> P. 471</span>                      Have your vehicle checked by a dealer.</li> </ul>

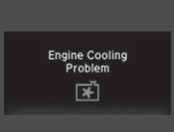
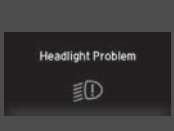
Message	Condition	Explanation
	<ul style="list-style-type: none"> <li>Appears when the steering wheel is locked.</li> </ul>	<ul style="list-style-type: none"> <li>Move the steering wheel left and right while pressing the <b>ENGINE START/STOP</b> button.</li> </ul>
	<ul style="list-style-type: none"> <li>Appears when the power mode is in ACCESSORY.</li> </ul>	—
	<ul style="list-style-type: none"> <li>Appears after the driver's door is opened when the power mode is in ACCESSORY.</li> </ul>	<ul style="list-style-type: none"> <li>Press the <b>ENGINE START/STOP</b> button twice with your foot off the brake pedal to change the power mode to VEHICLE OFF (LOCK).</li> </ul>
	<ul style="list-style-type: none"> <li>Appears when you close the door with the power mode is in ON without the smart entry remote inside the vehicle.</li> </ul>	<ul style="list-style-type: none"> <li>Disappears when you bring the smart entry remote back inside the vehicle and close the door.                             <ul style="list-style-type: none"> <li>➤ <b>Smart Entry Remote Reminder</b> P. 154</li> </ul> </li> </ul>
	<ul style="list-style-type: none"> <li>Appears when the smart entry remote battery becomes weak.</li> </ul>	<ul style="list-style-type: none"> <li>Replace the battery as soon as possible.                             <ul style="list-style-type: none"> <li>➤ <b>Replacing the Button Battery</b> P. 608</li> </ul> </li> </ul>

Message	Condition	Explanation
	<ul style="list-style-type: none"> <li>Appears if the smart entry remote battery is too weak to start the engine or the key is not within operating range to start the engine. The beeper sounds six times.</li> </ul>	<ul style="list-style-type: none"> <li>Bring the smart entry remote in front of the <b>ENGINE START/STOP</b> button.                             <ul style="list-style-type: none"> <li>➤ <b>If the Smart Entry Remote Battery is Weak</b> P. 630</li> </ul> </li> </ul>
	<ul style="list-style-type: none"> <li>Appears three seconds after the <b>To Start, Hold Remote Near Start Button</b>, then <b>To Start Engine</b> messages appeared sequentially.</li> </ul>	<ul style="list-style-type: none"> <li>Unless you bring the smart entry remote in front of the <b>ENGINE START/STOP</b> button, this message does not appear.                             <ul style="list-style-type: none"> <li>➤ <b>If the Smart Entry Remote Battery is Weak</b> P. 630</li> </ul> </li> </ul>
	<ul style="list-style-type: none"> <li>Appears if there is a problem with the cooling system.</li> </ul>	<ul style="list-style-type: none"> <li>Drive slowly to prevent overheating and have your vehicle checked by a dealer as soon as possible.</li> </ul>
	<ul style="list-style-type: none"> <li>Appears when there is a problem with the headlights*.</li> </ul>	<ul style="list-style-type: none"> <li><b>Appears while driving</b> - The low beam headlights may not be on. When conditions allow you to drive safely, have your vehicle checked by a dealer as soon as possible.</li> </ul>
	<ul style="list-style-type: none"> <li>Appears if there is a problem with the parking sensor system*.</li> </ul>	<ul style="list-style-type: none"> <li>Check if the area around the sensor(s) is covered with mud, ice, snow, etc. If the indicator(s) stays on or the beeper does not stop even after you clean the area, have the system checked by a dealer.</li> </ul>

\* Not available on all models

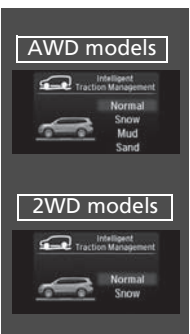
Message	Condition	Explanation
	<ul style="list-style-type: none"> <li>• Appears when pressing the Intelligent Traction Management button.</li> </ul>	<p>➤ <b>Intelligent Traction Management*</b> P. 495</p>

Models with CMBS or ACC

Message	Condition	Explanation
	<ul style="list-style-type: none"> <li>Flashes when the system senses a likely collision with a vehicle in front of you.</li> </ul>	<ul style="list-style-type: none"> <li>Take the appropriate means to prevent a collision (apply the brakes, change lanes, etc.)                             <ul style="list-style-type: none"> <li>➤ <b>Collision Mitigation Braking System™ (CMBS™)*</b> P. 543</li> <li>➤ <b>Adaptive Cruise Control (ACC)*</b> P. 502</li> </ul> </li> </ul>

Models with ACC

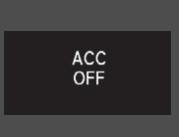

Message	Condition	Explanation
	<ul style="list-style-type: none"> <li>Appears when ACC has been automatically canceled.</li> </ul>	<ul style="list-style-type: none"> <li>You can resume the set speed after the condition that caused ACC to cancel improves. Press the <b>RES/+SET/-</b> button.                             <ul style="list-style-type: none"> <li>➤ <b>Adaptive Cruise Control (ACC)*</b> P. 502</li> </ul> </li> </ul>

\* Not available on all models







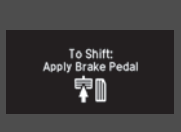

Automatic transmission models with electronic gear selector

Message	Condition	Explanation
	<ul style="list-style-type: none"> <li>• Appears when you change to <b>N</b>, then press and hold <b>N</b> again for two seconds.</li> </ul>	<ul style="list-style-type: none"> <li>• The gear position remains in <b>N</b> for 15 minutes, then automatically switches to <b>P</b>. <ul style="list-style-type: none"> <li>➤ <b>If you want to keep the transmission in <b>N</b> position [car wash mode]</b> P. 485</li> </ul> </li> </ul>
	<ul style="list-style-type: none"> <li>• Appears when the vehicle is stopped with the driver's seat belt unfastened and there is a chance that the vehicle may roll unintentionally.</li> <li>• Appears when the engine stops without the transmission in <b>P</b>, and does not restart automatically.</li> <li>• Appears if you open the hood while Auto Idle-stop activates.</li> </ul>	<ul style="list-style-type: none"> <li>• Press the <b>P</b> button before release the brake pedal when idling, parking or exiting the vehicle. <ul style="list-style-type: none"> <li>➤ <b>Shift Operation</b> P. 483</li> </ul> </li> <li>• If you want to set the power mode to ON, change the gear position to <b>P</b>.</li> <li>• If you want to start the engine, follow the normal procedure. <ul style="list-style-type: none"> <li>➤ <b>Starting the Engine</b> P. 471</li> </ul> </li> </ul>

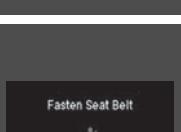

Automatic transmission models with electronic gear selector

Message	Condition	Explanation
	<ul style="list-style-type: none"> <li>Appears when you try to change the gear position without depressing the brake pedal.</li> </ul>	<ul style="list-style-type: none"> <li>Depress the brake pedal, then select a shift button.</li> </ul>
	<ul style="list-style-type: none"> <li>Appears when you try to change the gear position without releasing your foot off the accelerator pedal.</li> </ul>	<ul style="list-style-type: none"> <li>Release your foot off the accelerator pedal, then select a shift button.</li> </ul>
	<ul style="list-style-type: none"> <li>Appears when the <b>P</b> button is pressed while the vehicle is moving.</li> <li>Appears if you change the gear position to <b>R</b> while the vehicle is moving forward, or to <b>D</b> while the vehicle is reversing.</li> </ul>	<ul style="list-style-type: none"> <li>Make sure that the vehicle comes to a stop before operating the select button.</li> </ul>
	<ul style="list-style-type: none"> <li>Appears when you set the power mode to ON without fastening the driver's seat belt.</li> <li>Appears when you change the gear position after <b>P</b> has been automatically selected with the driver's door open, the driver's seat belt unfastened, then the brake pedal is released.</li> </ul>	<ul style="list-style-type: none"> <li>Fasten the seat belt properly before you start to drive. <b>➤ Shift Operation P. 483</b></li> </ul>
	<ul style="list-style-type: none"> <li>Appears when you press the <b>P</b> button but it is not engaged due to low ATF temperature.</li> </ul>	<ul style="list-style-type: none"> <li>Depress the brake pedal until this message disappears.</li> </ul>



Message	Condition	Explanation
 <p>The first screenshot shows the text "To Start Driving: Brake + Push" with icons for a brake pedal, a push button, and a power button. The second screenshot shows the text "To Enter Accessory Mode: Push" with icons for a push button and a power button.</p>	<ul style="list-style-type: none"> <li>• Appears when you unlock and open the driver's door while the engine is running by the smart entry remote.</li> </ul>	<p>➤ <b>Remote Engine Start*</b> P. 473</p>

\* Not available on all models

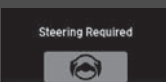
Models with LKAS

Message	Condition	Explanation
	<p><b>Lane Keeping Assist System (LKAS)</b></p> <ul style="list-style-type: none"> <li>• Appears when the vehicle is driving out of a detected lane. Rapid vibrations on the steering wheel.</li> </ul> <p><b>Road Departure Mitigation (RDM) System</b></p> <ul style="list-style-type: none"> <li>• Appears when the vehicle is driving out of a detected lane.</li> </ul>	<ul style="list-style-type: none"> <li>• Keep the vehicle within the lane you are driving.</li> <li>• The color of either line changes from white to amber as the vehicle gets closer to that side of the lane line.                             <ul style="list-style-type: none"> <li>➔ <b>Lane Keeping Assist System (LKAS)</b>* P. 519</li> </ul> </li> </ul>
	<p><b>When you selected Warning Only</b></p> <ul style="list-style-type: none"> <li>• Rapid vibrations on the steering wheel when the vehicle is drifting out of a detected lane.</li> </ul> <p><b>When you selected Normal or Wide</b></p> <ul style="list-style-type: none"> <li>• Rapid vibrations on the steering wheel with steering assist when the vehicle is drifting out of a detected lane.</li> </ul>	<ul style="list-style-type: none"> <li>• Keep the vehicle within the lane you are driving.</li> <li>• The color of either line changes from white to amber as the vehicle gets closer to that side of the lane line.                             <ul style="list-style-type: none"> <li>➔ <b>Road Departure Mitigation (RDM) System</b>* P. 514</li> </ul> </li> </ul>
	<ul style="list-style-type: none"> <li>• Blinks when you fail to steer the vehicle. The beeper sounds simultaneously if selected by customization.</li> </ul>	<ul style="list-style-type: none"> <li>• Operate the steering wheel to resume the LKAS.</li> </ul>

Models with LKAS



Message	Condition	Explanation
	<ul style="list-style-type: none"> <li>• Appears when the LKAS is in operation, or the LKAS button is pressed, but there is a problem with a system related to the LKAS. The LKAS cancels automatically. The beeper sounds simultaneously if selected by customization.</li> </ul>	<ul style="list-style-type: none"> <li>• If any other system indicators come on, such as the VSA®, ABS and brake system, take appropriate action. <b>► Indicators P. 78</b></li> </ul>
	<ul style="list-style-type: none"> <li>• Appears when the LKAS is in operation, or the LKAS button is pressed, but there the temperature inside the LKAS camera is too high. The LKAS cancels automatically. The beeper sounds simultaneously if selected by customization.</li> </ul>	<ul style="list-style-type: none"> <li>• Use the climate control system to cool down the camera.</li> <li>• <b>Goes off</b> - The camera has been cooled down. Pressing the LKAS button can resume the system. <b>► Front Sensor Camera* P. 500</b></li> </ul>
	<ul style="list-style-type: none"> <li>• Appears when the area around the camera is blocked by dirt, mud, etc. Stop your vehicle in a safe place, and wipe it off with a soft cloth.</li> <li>• May appear when driving in bad weather (rain, snow, fog, etc.)</li> </ul>	<ul style="list-style-type: none"> <li>• Have your vehicle checked by a dealer if the indicator and message come back on after you cleaned the area around the camera.</li> </ul>

\* Not available on all models

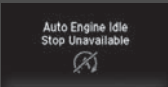
Models with Auto Idle-stop

Message	Condition	Explanation
 	<ul style="list-style-type: none"> <li>• Appears when <b>Auto Engine Idle-stop Guidance Screens ON</b> has been selected from the customization menu.</li> <li>• Appears when Auto Idle-stop does not activate for some reason.</li> <li>• Appears when the engine restarts automatically.</li> <li>• Appears when the battery temperature is around 14°F (–10°C) or lower.</li> <li>• Appears when Auto Idle-stop does not activate because the climate control system is in use, and the difference between the set temperature and actual interior temperature becomes significant.</li> <li>• Appears when Auto Idle-stop does not activate because the engine coolant temperature is low or high.</li> <li>• Appears when Auto Idle-stop does not activate because the battery charge level is low.</li> </ul>	<p>➤ <b>Auto Idle-stop*</b> P. 489</p> <ul style="list-style-type: none"> <li>• <b>Appears even though the battery is fully charged-</b> The system may not read the battery amount correctly. Drive for a few minutes.</li> <li>• <b>Appears after charging the battery or jump starting</b> - Disconnect the negative ⊖ cable once and reconnect it again to the battery. Drive a few minutes.</li> </ul>

Models with Auto Idle-stop

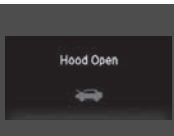
Message	Condition	Explanation
	<ul style="list-style-type: none"> <li>• Appears when Auto Idle-stop does not activate because the pressure to the brake pedal is not enough.</li> </ul>	<ul style="list-style-type: none"> <li>• Depress the brake pedal firmly.</li> </ul>
	<ul style="list-style-type: none"> <li>• Appears when <b>Auto Engine Idle-stop Guidance Screens ON</b> has been selected from the customization menu.</li> <li>• Appears when the system is under the following conditions while Auto Idle-stop activates:                             <ul style="list-style-type: none"> <li>• The battery charge level is low.</li> <li>• The battery temperature is around 14°F (–10°C) or lower.</li> <li>• The climate control system is in use, and the difference between the set temperature and actual interior temperature becomes significant.</li> <li>• The humidity in the interior is high.</li> </ul> </li> </ul>	<ul style="list-style-type: none"> <li>• The engine restarts automatically in a few seconds.                             <ul style="list-style-type: none"> <li>► <b>Starting the Engine</b> P. 471</li> </ul> </li> </ul>
	<ul style="list-style-type: none"> <li>• Appears when the hood is opened.</li> </ul>	<ul style="list-style-type: none"> <li>• Close the hood.</li> </ul>

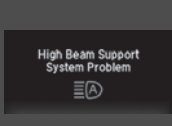
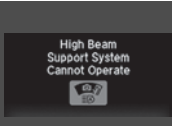

Models with Auto high-beam system

Message	Condition	Explanation
 <p>High Beam Support System Problem</p>	<ul style="list-style-type: none"> <li>• Appears if there is a problem with the Auto high-beam system.</li> </ul>	<ul style="list-style-type: none"> <li>• Manually operate the headlight switch.</li> <li>• If you are driving with the high-beam headlights when this happens, the headlights are changed to low beams.</li> </ul>
 <p>High Beam Support System Cannot Operate</p>	<ul style="list-style-type: none"> <li>• Appears when the area around the camera on the windshield is blocked by dirt, mud, etc.</li> </ul>	<ul style="list-style-type: none"> <li>• Stop your vehicle in a safe place, and wipe it off with a soft cloth.</li> <li>• If the message does not disappear after cleaning the lens, have your vehicle checked by a dealer.</li> </ul>

## Gauges

Gauges include the speedometer, tachometer, fuel gauge, and related indicators. They are displayed when the power mode is in ON.

### ■ Speedometer

Displays your driving speed in mph (U.S.) or km/h (Canada).

### ■ Tachometer

Shows the number of engine revolutions per minute.

### ■ Fuel Gauge

Displays the amount of fuel left in the fuel tank.

### ■ Temperature Gauge

Displays the temperature of the engine coolant.

#### » Fuel Gauge

##### NOTICE

You should refuel when the reading approaches **E**. Running out of fuel can cause the engine to misfire, damaging the catalytic converter.

The actual amount of remaining fuel may differ from the fuel gauge reading.

#### » Temperature Gauge

##### NOTICE

Driving with the temperature gauge pointer in the upper zone can cause serious engine damage. Pull safely to the side of the road and allow engine temperature to return to normal.

» **Overheating** P. 636

# MID

The MID shows the odometer, trip meter, outside temperature indicator, and other gauges. It also displays important messages such as warnings and other helpful information.

## Switching the Display

Press the  (information) or **RESET** button.

Instrument Panel

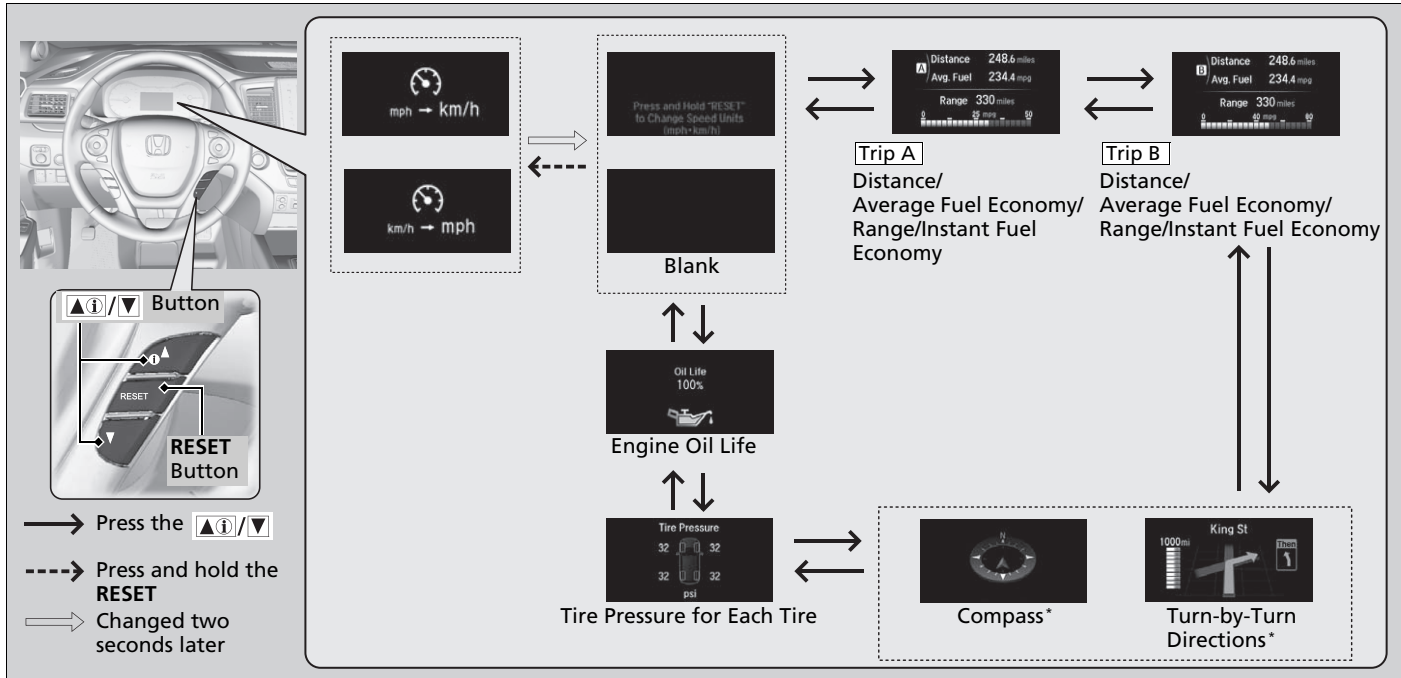

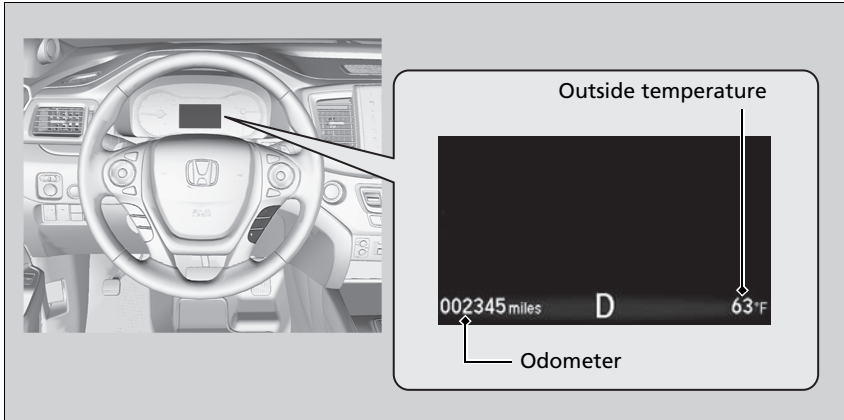

## ■ Odometer

Shows the total number of miles (U.S.) or kilometers (Canada) that your vehicle has accumulated.

## ■ Outside Temperature\*

Shows the outside temperature in Fahrenheit (U.S.) or Celsius (Canada).

### ■ Adjusting the outside temperature display

Adjust the temperature reading up to  $\pm 5^{\circ}\text{F}$  or  $\pm 3^{\circ}\text{C}$  if the temperature reading seems incorrect.

## ■ Trip Meter

Shows the total number of miles (U.S.) or kilometers (Canada) driven since the last reset. Meters A and B can be used to measure two separate trips.

### ■ Resetting a trip meter

To reset a trip meter, display it, then press and hold the **RESET** button until the trip meter is reset to **0.0**.

## ■ Average Fuel Economy

Shows the estimated average fuel economy of each trip meter in mpg (U.S.) or l/100 km (Canada). The display is updated at set intervals. When a trip meter is reset, the average fuel economy is also reset.

### » Outside Temperature\*

The temperature sensor is located in the front bumper.

Road heat and exhaust from another vehicle can affect the temperature reading when your vehicle speed is less than 19 mph (30 km/h).

It may take several minutes for the display to be updated after the temperature reading has stabilized.

Use the audio/information screen's customized features to correct the temperature.

▶ **Customized Features** P. 351

### » Trip Meter

Switch between trip meter A and trip meter B by pressing the /▼ button.

### » Average Fuel Economy

You can change when to reset the average fuel economy.

▶ **Customized Features** P. 351

## Range

Shows the estimated distance you can travel on the remaining fuel. This distance is estimated from the fuel economy of your previous trips.

## Instant Fuel Economy

Shows the instant fuel economy as a bar graph in mpg (U.S.) or l/100 km (Canada).

## Turn-by-Turn Directions

### Models with navigation system

Shows you turn-by-turn driving directions to your destination linked with the navigation system.

➤ **Refer to the Navigation System Manual**

## Tire Pressure Monitor

Shows each tire's pressure.

➤ **Tire Pressure Monitoring System (TPMS) with Tire Fill Assist** P. 535

## Engine Oil Life and Maintenance Items

Shows the remaining oil life and Maintenance Minder™.

➤ **Maintenance Minder™** P. 571

### ☒ Turn-by-Turn Directions

The multi-information display shows a compass when the route guidance is not used.

You can select whether the turn-by-turn display comes on or not during the route guidance.

➤ **Customized Features** P. 351



# Controls

This chapter explains how to operate the various controls necessary for driving.



<b>Clock</b> .....	120
<b>Locking and Unlocking the Doors</b>	
Key Types and Functions .....	121
Locking/Unlocking the Doors from the Outside .....	124
Low Smart Entry Remote Signal Strength .....	123
Locking/Unlocking the Doors from the Inside .....	131
Childproof Door Locks .....	133
Auto Door Locking/Unlocking .....	134
<b>Opening and Closing the Tailgate</b> .....	135
<b>Security System</b>	
Immobilizer System .....	143
Security System Alarm .....	143
<b>Opening and Closing the Windows</b> .....	146

<b>Moonroof*</b> .....	148
<b>Panoramic Roof*</b> .....	149
<b>Operating the Switches Around the Steering Wheel</b>	
ENGINE START/STOP Button .....	152
Turn Signals .....	155
Light Switches .....	156
Fog Lights* .....	159
Auto High-Beam System* .....	160
Daytime Running Lights .....	163
Wipers and Washers .....	164
Brightness Control .....	167
Defogger/Heated Door Mirror* .....	168
Driving Position Memory System* .....	169
Adjusting the Steering Wheel .....	171

<b>Adjusting the Mirrors</b>	
Interior Rearview Mirror .....	172
Power Door Mirrors .....	173
<b>Adjusting the Seats</b>	
Adjusting the Seat Positions .....	174
Rear Seats .....	183
Armrest .....	186
<b>Interior Lights/Interior Convenience Items</b>	
Interior Lights .....	188
Interior Convenience Items .....	191
<b>Heating and Cooling*</b> .....	205
<b>Climate Control System*</b> .....	210

\* Not available on all models







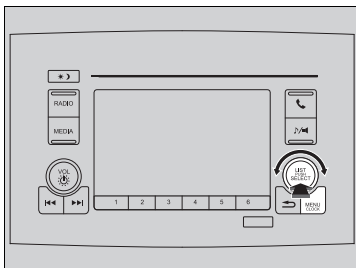

## Adjusting the Clock

You can adjust the time manually in the audio/information screen, with the power mode in ON.



### Adjusting the Time



#### Models with color audio system

1. Press and hold the **MENU/CLOCK** button for two seconds.
2. Select **Adjust Clock**, then press .
3. Rotate  to adjust the hours.
4. Press  to switch to minute adjustment.
5. Rotate  to adjust the minutes.
6. Press  to switch to **Set**.
7. Press  to complete clock adjustment.

#### Models with Display Audio

1. Select , then select **Settings**.
2. Select **Clock/Info**, then **Clock Adjustment**.
3. Adjust the dates, hours and minutes by selecting /.
4. Select **OK** to set the time.

### »»Clock

#### Models with color audio system







These indications are used to show how to operate the selector knob.

Rotate  to select.

Press  to enter.

#### Models with color audio system

To change the setting between **12h** and **24h**:

1. Press the **MENU/CLOCK** button.
2. Rotate  to select **Settings**, then press .
3. Rotate  to select **Clock Format**, then press .
4. Rotate  to select **12h** or **24h**, then press .

#### Models with color audio system

You can also access to the clock adjustment mode by pressing and holding the **MENU/CLOCK** button.

#### Models with Navigation System

The clock is automatically updated through the navigation system, so the time does not need to be adjusted.

You can customize the clock display to show the 12 hour clock or 24 hour clock.

 **Customized Features** P. 351

## Key Types and Functions

This vehicle comes with the following keys:

### Keys

#### Models without remote engine start



#### Models with remote engine start



Use the smart entry remote to start and stop the engine, and to lock and unlock all the doors and tailgate. You can also use the smart entry system to lock and unlock the doors and tailgate.

#### Key Types and Functions

All the keys have an immobilizer system. The immobilizer system helps to protect against vehicle theft.

➤ **Immobilizer System** P. 143

The keys contain precision electronics. Adhere to the following advice to prevent damage to the electronics:

- Do not leave the keys in direct sunlight, or in locations with high temperature or high humidity.
- Do not drop the keys or set heavy objects on them.
- Keep the keys away from liquids.
- Do not take the keys apart except for replacing the battery.

If the circuits in the keys are damaged, the engine may not start, and the smart entry system may not work.

If the keys do not work properly, have them inspected by a dealer.

#### Models with remote engine start

You can remotely start the engine using the smart entry remote.

➤ **Remote Engine Start\*** P. 473

\* Not available on all models

### ■ Smart entry remote

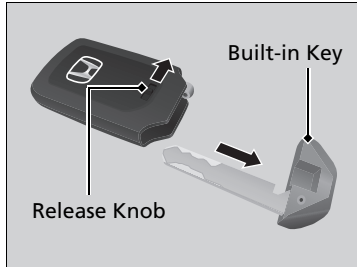

The built-in key can be used to lock/unlock the doors when the smart entry remote battery becomes weak or the power door lock/unlock operation is disabled.

To remove the built-in key, pull it out while sliding the release knob. To reinstall the built-in key, push the built-in key into the smart entry remote until it clicks.

### ■ Key Number Tag

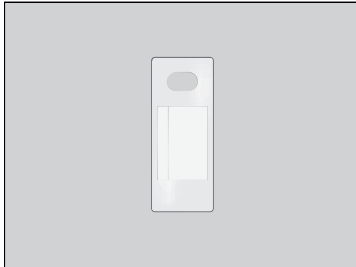

Contains a number that you will need if you purchase a replacement key.

### ⊠ Key Number Tag

Keep the key number tag separate from the key in a safe place outside of your vehicle. If you wish to purchase an additional key, contact a dealer.

If you lose your key and you cannot start the engine, contact a dealer.

## Low Smart Entry Remote Signal Strength

The vehicle transmits radio waves to locate the smart entry remote when locking/unlocking the doors and tailgate, or to start the engine.

In the following cases, locking/unlocking the doors and tailgate, or starting the engine may be inhibited or operation may be unstable:

- Strong radio waves are being transmitted by nearby equipment.
- You are carrying the smart entry remote together with telecommunications equipment, laptop computers, cell phones, or wireless devices.
- A metallic object is touching or covering the smart entry remote.

### Low Smart Entry Remote Signal Strength

Communication between the smart entry remote and the vehicle consumes the smart entry remote's battery.

The smart entry remote battery lasts about two years. This changes by how often you use the remote. The battery is consumed whenever the smart entry remote is receiving strong radio waves. Avoid placing it near electrical appliances such as televisions and personal computers.

## Locking/Unlocking the Doors from the Outside

Except U.S. LX models

### ■ Using the Smart Entry with Push Button Start System

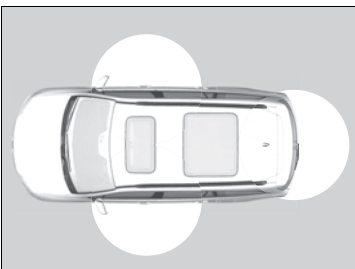

When you carry the smart entry remote, you can lock/unlock the doors and the tailgate.

You can lock/unlock the doors within a radius of about 32 inches (80 cm) of the outside door handle. You can open the tailgate within about 32 inches (80 cm) radius from the tailgate release button.

### ▣ Locking/Unlocking the Doors from the Outside

You can lock or unlock doors using the remote transmitter or smart entry system only when the power mode is in VEHICLE OFF.

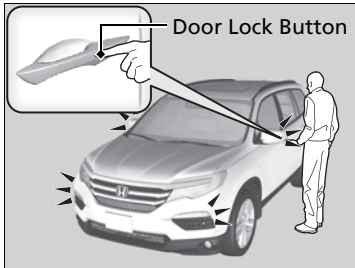

### ■ Locking the doors and tailgate

Press the door lock button on a front door or the tailgate.

- ▶ Some exterior lights flash; the beeper sounds; all the doors and tailgate lock; and the security system sets.

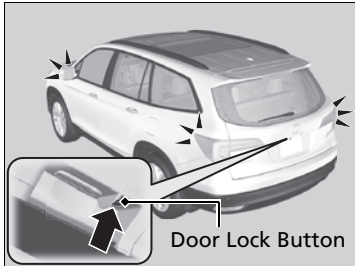

### ⊗ Using the Smart Entry with Push Button Start System

- Do not leave the smart entry remote in the vehicle when you get out. Carry it with you.
- Even if you are not carrying the smart entry remote, you can lock/unlock the doors and unlock the tailgate while someone else with the remote is within range.
- The door may be unlocked if the door handle is covered with water in heavy rain or in a car wash if the smart entry remote is within range.
- If you grip a door handle wearing gloves, the door sensor may be slow to respond or may not respond by unlocking the doors.
- After locking the door, you have up to 2 seconds during which you can pull the door handle to confirm whether the door is locked. If you need to unlock the door immediately after locking it, wait at least 2 seconds before gripping the handle, otherwise the door will not unlock.
- The door may not open if you pull it immediately after gripping the door handle. Grip the handle again and confirm that the door is unlocked before pulling the handle.
- Even within the 32 inches (80 cm) radius, you may not be able to lock/unlock the doors with the smart entry remote if it is above or below the outside handle.
- The smart entry remote may not operate if it is too close to the door and door glass.

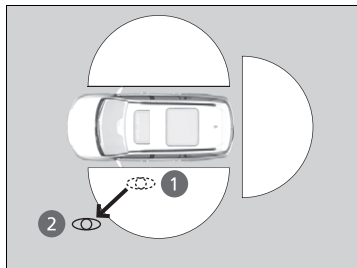
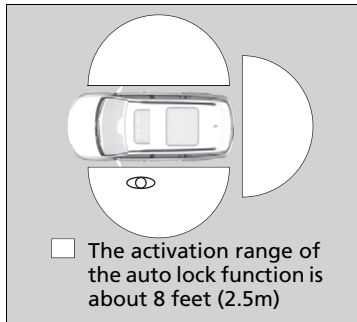

### ■ Locking the doors and tailgate (Walk away auto lock)

When you walk away from the vehicle while carrying the smart entry remote, the doors will automatically lock.

The auto lock function activates when all doors and tailgate are closed, and the smart entry remote is within about 8 feet (2.5m) radius of the outside door handle.

Exit vehicle while carrying smart entry remote and close door(s).

1. While within about 8 feet (2.5m) radius of the vehicle.
  - ▶ The beeper sounds; the auto lock function will be activated.
2. Carry the smart entry remote beyond about 5 feet (1.5m) from the vehicle and remain outside this range for 2 or more seconds.
  - ▶ Some exterior lights flash; the beeper sounds; all doors and tailgate will then lock.

### ▶▶ Locking the doors and tailgate (Walk away auto lock)

The auto lock function is set to OFF as the factory default setting. The auto lock function can be set to ON using the audio/information screen. Turning ON auto lock function using the audio/information screen, shall only activate the function in remote transmitter that was used to unlock the driver's door.

#### ▶▶ Customized Features P. 351

After the auto lock function has been activated, when you stay within the locking/unlocking operation range, the indicator on the smart entry remote will continue to flash until the doors are locked.

When you stay beside the vehicle within the operation range, the doors will automatically lock approximately 30 seconds after the auto lock function activating beeper sounds.

When you open a door after the auto lock function activating beeper sounds, the auto lock function will be delayed until all doors and tailgate are closed.

When all doors and tailgate have been closed and the smart entry remote is inside the vehicle, or if the smart entry remote is not detected within about 8 feet (2.5m) of the vehicle, auto lock function will not be activated.

If equipped, the user must wait until the power tailgate fully closes before the auto lock function will be activated.

To temporarily deactivate the function:

1. Set the power mode to OFF.
2. Open the driver's door.
3. Using the master door lock switch, operate the lock as follows:  
Lock → Unlock → Lock → Unlock.  
▶ The beeper sounds and the function is deactivated.

To restore the function:

- Set the power mode to ON.
- Lock the vehicle without using the auto lock function
- Walk away at least more than about 8 feet (2.5m) away from the vehicle while carrying the smart entry remote.

⊗ Locking the doors and tailgate (Walk away auto lock)

The auto lock function does not operate when any of the following conditions are met.

- The smart entry remote is inside the vehicle.
- A door or the hood is not closed.
- The power mode is set to any mode other than OFF.
- The smart entry remote is not located within a radius of about 8 feet (2.5m) from the vehicle when you get out of the vehicle and close the doors.

**Auto lock function operation stop beeper**

After the auto lock function has been activated, the auto lock operation stop beeper sounds for approximately two seconds in the following cases.

- The smart entry remote is put inside the vehicle through a window.
- You are located too close to the vehicle.
- The smart entry remote is put inside the tailgate.

If the warning beeper sounds, check that you are carrying the smart entry remote. Then, open/close a door and confirm the auto lock activation beeper sounds once.



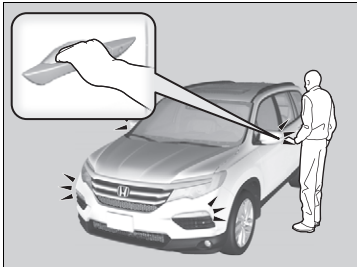

### ■ Unlocking the doors and tailgate

Grab the driver's door handle:

- ▶ The driver's door unlocks.
- ▶ Some exterior lights flash twice and the beeper sounds once.

Grab the front passenger's door handle:

- ▶ All doors unlock.
- ▶ Some exterior lights flash twice and the beeper sounds once.

Press the tailgate release button:

- ▶ The tailgate unlocks and opens\*.
- ▶ Some exterior lights flash twice and the beeper sounds once.

▶ **Using the Tailgate Outer Handle** P. 139

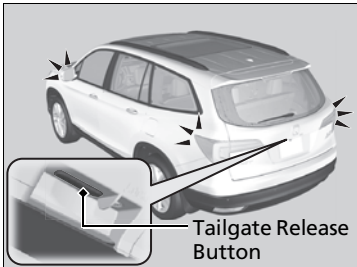

### ▶▶ Using the Smart Entry with Push Button Start System

If you do not open a door within 30 seconds of unlocking the vehicle, the doors will automatically relock.

You can change the relock timer setting.

▶ **Customized Features** P. 351

The light flash, beeper, and unlock settings can be customized using the audio/information screen.

▶ **Customized Features** P. 351

You can also unlock and open with the power tailgate\*.

▶ **Using the Tailgate Outer Handle** P. 139

## ■ Using the Remote Transmitter

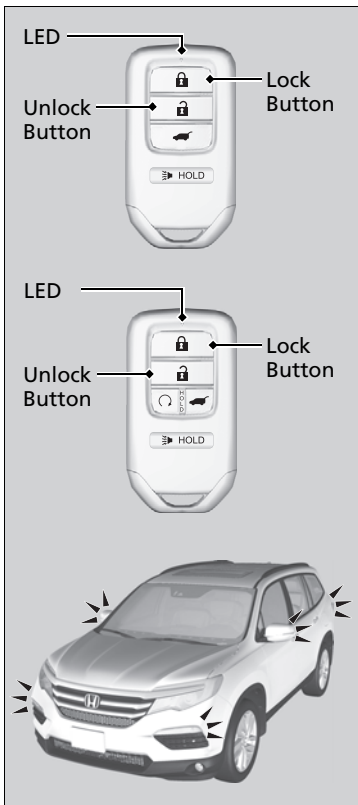

### ■ Locking the doors

Press the lock button.

#### Once:

- ▶ Some exterior lights flash, all the doors and tailgate lock, and the security system sets.

#### Twice (within five seconds after the first push):

- ▶ The beeper sounds and verifies the security system is set.

### ■ Unlocking the doors

Press the unlock button.

#### Once:

- ▶ Some exterior lights flash twice, and the driver's door unlocks.

#### Twice:

- ▶ The remaining doors and tailgate unlock.

## ✕ Using the Remote Transmitter

If you do not open a door within 30 seconds of unlocking the vehicle with the remote transmitter, the doors will automatically relock. You can change the relock timer setting.

✕ **Customized Features** P. 351

If the interior light switch is in the door activated position, the interior lights come on when you press the unlock button.

No doors opened: The lights fade out after 30 seconds.

Doors relocked with the remote: The lights go off immediately.

✕ **Interior Lights** P. 188

The remote transmitter uses low-power signals, so the operating range may vary depending on the surroundings.

The remote will not lock the vehicle when a door or the tailgate is open.

If the distance at which the remote transmitter works varies, the battery is probably low.

If the LED does not come on when you press a button, the battery is dead.

✕ **Replacing the Button Battery** P. 608

You can customize the door lock mode and keyless lock acknowledgement setting.

✕ **Customized Features** P. 351

### ■ Locking/Unlocking the Doors Using a Key

If the smart entry remote battery or the vehicle battery is dead, use the key instead of the smart entry remote.

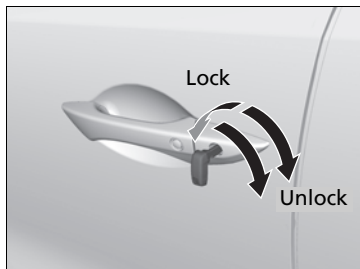

Fully insert the key and turn it.

### ■ Locking a Door Without Using a Key

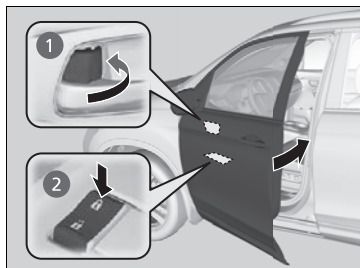

#### ■ Locking the front doors

Push the lock tab forward ① or push the master door lock switch in the lock direction ②, and close the door.

#### ■ Locking the rear doors

Push the lock tab forward and close the door.

#### ■ Lockout prevention system

The doors and tailgate cannot be locked when the smart entry remote is inside the vehicle.

### ▶ Locking/Unlocking the Doors Using a Key

When you lock the driver's door with a key, all the other doors and tailgate lock at the same time. When unlocking, the driver's door unlocks first. Turn the key a second time within a few seconds to unlock the remaining doors and the tailgate.

You can customize the door unlock mode setting.

▶ **Customized Features** P. 351

### ▶ Locking a Door Without Using a Key

When you lock the driver's door, all the other doors and tailgate lock at the same time.

Make sure you have the key in your hand before locking the door to prevent it from being locked in the vehicle.

## Locking/Unlocking the Doors from the Inside

### ■ Using the Lock Tab

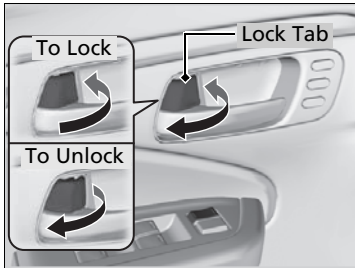

#### ■ Locking a door

Push the lock tab forward.

#### ■ Unlocking a door

Pull the lock tab rearward.

### ☒ Using the Lock Tab

When you lock the door using the lock tab on the driver's door, all the other doors and tailgate lock at the same time.

When you unlock the door using the lock tab on the driver's door, only the driver's door will unlock.

## ■ Unlocking Using the Front Door Inner Handle

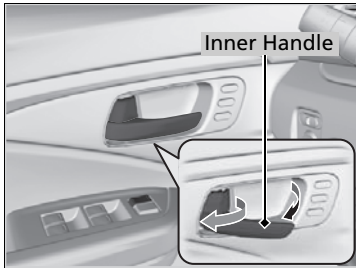

Pull the front door inner handle.

- ▶ The door unlocks and opens in one motion.

Unlocking and opening the driver's door from the inner handle unlocks all the other doors.

To avoid all the doors to be unlocked, use the lock tab on the driver's door to unlock, then lock again before opening the door.

- ▶ This setting works for one time only. If you do not want all the doors to be unlocked all the time, customize the **Auto Door Unlock** setting to **Off** using the audio/information screen.

## ⊗ Unlocking Using the Front Door Inner Handle

The front door inner handles are designed to allow front seat occupants to open the door in one motion. However this feature requires that front seat occupants never pull a front door inner handle while the vehicle is in motion.

Children should always ride in a rear seat where childproof door locks are provided.

➤ **Childproof Door Locks** P. 133

## ■ Using the Master Door Lock Switch

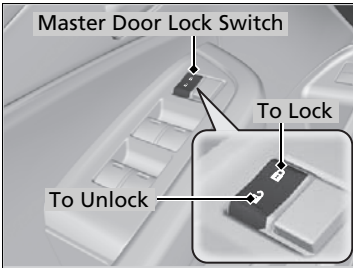

Press the master door lock switch in as shown to lock or unlock all doors and the tailgate.

### ⌘ Using the Master Door Lock Switch

When you lock/unlock either front door using the master door lock switch, all the other doors and tailgate lock/unlock at the same time.

## Childproof Door Locks

The childproof door locks prevent the rear doors from being opened from the inside regardless of the position of the lock tab.

### ⌘ Childproof Door Locks

To open the door from the inside when the childproof door lock is on, put the lock tab in the unlock position, lower the rear window, put your hand out of the window, and pull the outside door handle.

## ■ Setting the Childproof Door Locks

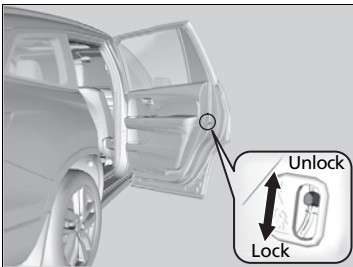

Slide the lever in the rear door to the lock position, and close the door.

### ■ When opening the door

Open the door using the outside door handle.

## Auto Door Locking/Unlocking

Your vehicle locks all doors and unlocks all doors or the driver's door automatically when a certain condition is met.

### ■ Auto Door Locking

#### ■ Drive lock mode

All doors and tailgate lock when the vehicle's speed reaches about 10 mph (15 km/h).

### ■ Auto Door Unlocking

#### ■ Driver's door open mode

All doors unlock when the driver's door is opened.

### ▶▶ Auto Door Locking/Unlocking

#### Models with Display Audio

You can turn off or change to another auto door locking/unlocking setting using the audio/information screen.

▶ **Customized Features** P. 351

## Precautions for Opening/Closing the Tailgate

Always make sure individuals and objects are clear of the tailgate before opening or closing it.

### ■ Opening the tailgate

- Open the tailgate all the way.
  - ▶ If it is not fully opened, the tailgate may come down accidentally by its own weight.
- Be careful when it is windy. The wind may cause the tailgate to close.

### ■ Closing the tailgate

Keep the tailgate closed while driving to:

- ▶ Avoid possible damage.
- ▶ Prevent exhaust gas from leaking into the vehicle.
- ▶ **Carbon Monoxide Gas** P. 74

### ⚠ Precautions for Opening/Closing the Tailgate

## ⚠ WARNING

Anyone caught in the path of a tailgate that is being opened or closed can be seriously injured.

**Make sure that all people are clear of the tailgate before opening or closing it.**

Be careful not to hit your head on the tailgate or to put your hands between the tailgate and the cargo area when closing the tailgate.

When you are storing or picking up luggage from the cargo area while the engine is idling, do not stand in front of the exhaust pipe. You may get burned.

Do not allow any passenger in the cargo space. They may get hurt during hard braking, a sudden acceleration, or a crash.



## Opening/Closing the Tailgate Using the Tailgate Outer Handle

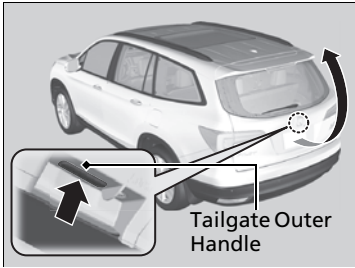

When all the doors are unlocked, the tailgate is unlocked.

### Models without power tailgate

Press the tailgate outer handle and lift open the tailgate.

### Models with power tailgate

Press the tailgate release button for more than one second, and lift open the tailgate.

If you are carrying the smart entry remote, you do not have to unlock the tailgate before opening it.



To close the tailgate, grab the inner handle, pull the tailgate down, and push it closed from outside.

### Opening/Closing the Tailgate Using the Tailgate Outer Handle

Do not leave the smart entry remote inside the cargo area and close the tailgate. The beeper sounds repeatedly. You can open the tailgate and retrieve the key.

Even if you are not carrying the smart entry remote, you can lock/unlock the doors while someone else with the remote is within range.

### ■ Using the Remote Transmitter\*

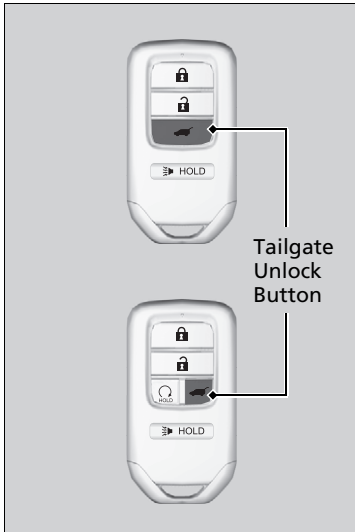

Press the tailgate unlock button to unlock the tailgate.

- ▶ Some exterior lights flash twice, and the tailgate unlocks.

### ▣ Using the Remote Transmitter\*

If you have unlocked and opened the tailgate using the remote transmitter, or smart entry remote, when closing, the tailgate locks automatically.

\* Not available on all models

## Opening/Closing the Power Tailgate\*

The power tailgate can be operated by pressing the power tailgate button on the remote transmitter or driver's door, or pressing the button on the tailgate.

### ■ The power tailgate can be opened when:

- The tailgate is fully closed.
- The transmission is in **P**.
- Press and hold the tailgate button on the remote transmitter for about one second when the power mode is in VEHICLE OFF (LOCK).
  - ▶ If you have changed the **Keyless Open Mode** setting to **When Unlocked**, you need to unlock the tailgate before you press the tailgate button to open it.
    - 📖 **Customized Features** P. 351

### ■ The power tailgate can be closed when:

- The tailgate is fully open.
- Press and hold the tailgate button on the remote transmitter for about one second when the power mode is in VEHICLE OFF (LOCK).

### ▶▶ Opening/Closing the Power Tailgate\*

#### NOTICE

Do not push or pull on the power tailgate when it is being automatically opened or closed. Forcibly opening or closing the power tailgate while in operation can deform the tailgate frame.

When operating the power tailgate, make sure there is enough space around your vehicle. People near the tailgate may be seriously hurt if the tailgate hits or closes on their heads. Be especially cautious if children are around.

The power tailgate may not open or close under the following conditions:

- The vehicle is parked on a steep hill.
- The vehicle is swayed in a strong wind.
- The tailgate or the roof is covered with snow or ice.

If you close the power tailgate when all the doors are locked, the power tailgate locks automatically.

If you replace the battery or the power tailgate fuse while the tailgate is open, the power tailgate may be disabled. The power tailgate resumes once you manually close the tailgate and wait for about five minutes.

Installing aftermarket components other than Honda genuine accessories on the power tailgate may prevent it from fully opening or closing.

Make sure the power tailgate is fully open before you get your luggage in and out.

Make sure the power tailgate is fully closed before you start the vehicle.

## ■ Using the Tailgate Outer Handle

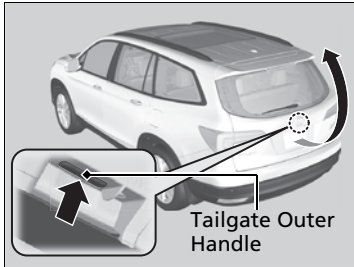

Press the tailgate outer handle within one second when the tailgate is unlocked, open the tailgate automatically.

- ▶ Releasing the outer handle more than one second, and wait until you hear two beeps before you lift open the tailgate.

### ▣ Opening and Closing the Tailgate

P. 135

If you are carrying the keyless remote, you do not have to unlock the tailgate before opening it.

## ▣ Using the Tailgate Outer Handle

- Do not leave the smart entry remote in the vehicle when you get out. Carry it with you.
- Even if you are not carrying the smart entry remote, you can unlock the tailgate while someone else with the remote is within range.

## Remote Transmitter

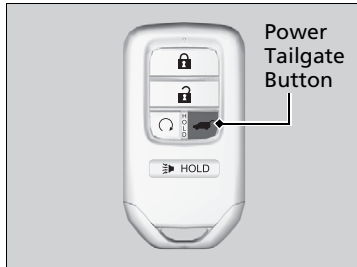

Press the power tailgate button for more than one second to operate when the power mode is in VEHICLE OFF (LOCK).

### Opening the tailgate

Press the power tailgate button for one second, some exterior lights flash four times, and starts to open the tailgate.

- ▶ When all the doors are locked, some exterior lights flash twice, the tailgate unlocks, and starts to open the tailgate.

### Closing the tailgate

Press the power tailgate button for one second, some exterior lights flash four times, and starts to close the tailgate.

- ▶ When the tailgate is fully close and all the doors are locked, some exterior lights flash twice, the tailgate locks, and security system sets.

To reverse direction while the power tailgate is in operation, press the button again. The beeper sounds three times and the tailgate reverses direction.

## Opening/Closing the Power Tailgate\*

If the power tailgate meets resistance while opening or closing, the auto reverse feature reverses the direction. The beeper sounds three times.

The auto reverse function stops sensing when the tailgate is almost closed to make sure that it fully closes.

Do not touch the sensors located on both sides of the tailgate. The power tailgate does not close if you touch either sensor when you are trying to close the tailgate.

Be careful not to scratch the sensors with a sharp object. If scratched, they can be damaged, and the power tailgate closing feature malfunctions.

### ■ Customizing when to open the tailgate

**Anytime:** The power tailgate unlocks and opens at the same time. This is the default setting.

**When Unlocked:** The tailgate opens when all doors are unlocked.

🔧 **Customized Features** P. 351

### ■ Power Tailgate Button

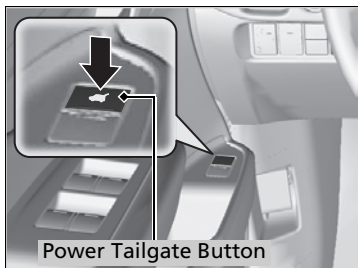

To open or close the power tailgate, press the power tailgate button for about one second. The beeper sounds and some exterior lights flash.

To reverse direction while the power tailgate is in operation, press the button again. The beeper sounds three times and the tailgate reverses direction.

### ■ Power Tailgate Close Button



Press the button on the tailgate to close the power tailgate. If you press the button again while the power tailgate is closing, it reverses direction.

### ⊠ Power Tailgate Close Button

If you press the power tailgate close button while the tailgate is automatically opening, the power tailgate operation reverses direction.

## ■ Auto-Closer

If you manually close the power tailgate, it latches automatically.

## ■ Power Tailgate Fall Detection

Automatically lowers the power tailgate when there is a possibility that the fully opened power tailgate can fall down by its own weight (for example, by snow on the tailgate). The beeper sounds while the power tailgate lowers.

### » Auto-Closer

The auto-closer feature does not activate if you press the tailgate release button while the power tailgate is closing.

Do not put any force on the tailgate while the power tailgate is latching.

Keep your hands away from the tailgate when you manually close the tailgate and let it latch automatically. It is dangerous to put your hands around the tailgate as it starts to latch itself.

### » Power Tailgate Fall Detection

If you try to manually close the power tailgate immediately after it fully opens, the power tailgate fall detection may activate.

Once the power tailgate fall detection activates, wait until the power tailgate fully closes. Keep away from the power tailgate when it is in motion. After the power tailgate is fully closed, wait for about five minutes. Manual operation is permitted.

If the power tailgate fall detection constantly activates, consult at a dealer.

## Immobilizer System

The immobilizer system prevents a key that has not been pre-registered from starting the engine. Each key contains electronic transmitters that use electronic signals to verify the key.

Pay attention to the following when pressing the **ENGINE START/STOP** button:

- Do not allow objects that emit strong radio waves near the **ENGINE START/STOP** button.
- Make sure the key is not covered by or touching a metal object.
- Do not bring a key from another vehicle's immobilizer system with the smart entry remote.

## Security System Alarm

The security system alarm activates when the tailgate, hood or doors are forcibly opened. The alarm does not go off if the tailgate or doors are opened with the key, remote transmitter or smart entry system.

### Except automatic transmission models with shift lever

However, the alarm goes off when a door is opened with the key, then the hood is opened before the power mode is set to ON.

### Automatic transmission models with shift lever

However, the alarm goes off when a door is opened with the key, then the hood is opened or gear position is changed from out of **P** before the power mode is set to ON.

### ■ When the security system alarm activates

The horn sounds intermittently, some exterior lights flash.

### Immobilizer System

#### NOTICE

Leaving the smart entry remote in the vehicle can result in theft or accidental movement of the vehicle. Always take the key with you whenever you leave the vehicle unattended.

Do not alter the system or add other devices to it. Doing so may damage the system and make your vehicle inoperable.

### Security System Alarm

The security alarm continues for a maximum of two minutes until the security system alarm deactivates.



### ■ To deactivate the security system alarm

Unlock the vehicle using the key, remote transmitter, or smart entry system. The system, along with the horn and flashing lights, is deactivated.

### ■ Setting the security system alarm

The security system alarm automatically sets when the following conditions have been met:

- The power mode is set to VEHICLE OFF (LOCK).
- The hood is closed.
- All doors and the tailgate are locked from outside with the key, remote transmitter, or smart entry system.

### ■ When the security system alarm sets

The security system alarm indicator in the instrument panel blinks. When the blinking interval changes after about 15 seconds, the security system alarm is set.

### ■ To cancel the security system alarm

The security system alarm is canceled when the vehicle is unlocked using the key, remote transmitter, smart entry system, or the power mode is set to ON. The security system alarm indicator goes off at the same time.

#### » Security System Alarm

Do not set the security system alarm when someone is in the vehicle or a window is open. The system can accidentally activate when:

- Unlocking the door with the lock tab.
- Opening the hood with the hood release.

If the battery goes dead after you have set the security system alarm, the security alarm may go off once the battery is recharged or replaced.

If this occurs, deactivate the security system alarm by unlocking a door using the key, remote transmitter, or smart entry system.

Do not attempt to alter this system or add another device to it.

## ■ Panic Mode

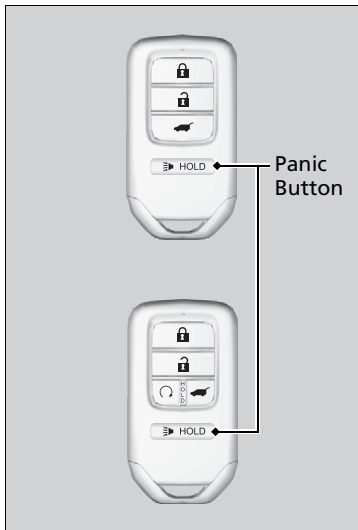

### ■ The panic button on the remote transmitter

If you press the panic button for approximately one second, the following will occur for about 30 seconds:

- The horn sounds.
- Some exterior lights flash.

### ■ Canceling panic mode

Press any button on the remote transmitter, or set the power mode to ON.

## Opening/Closing the Power Windows

The power windows can be opened and closed when the power mode is in ON, using the switches on the doors. The driver's side switches can be used to open and close all of the windows.

The power window lock button on the driver's side must be switched off (not pushed in, indicator off) to open and close the windows from anywhere other than the driver's seat.

When the power window lock button is pushed in, the indicator comes on and you can only operate the driver's window. Turn the power window lock button on when children are in the vehicle.

### Opening/Closing the Power Windows

#### **WARNING**

Closing a power window on someone's hands or fingers can cause serious injury.

Make sure your passengers are away from the windows before closing them.

The power windows can be operated for up to 10 minutes after you set the power mode to VEHICLE OFF (LOCK). Opening either front door cancels this function.

#### **Auto Reverse**

If a power window senses resistance when closing automatically, it stops closing and reverse direction.

The driver's window auto reverse function is disabled when you continuously pull up the switch.

The auto reverse function stops sensing when the window is almost closed to ensure that it fully closes.

### Opening/Closing Windows with Auto-Open/Close Function

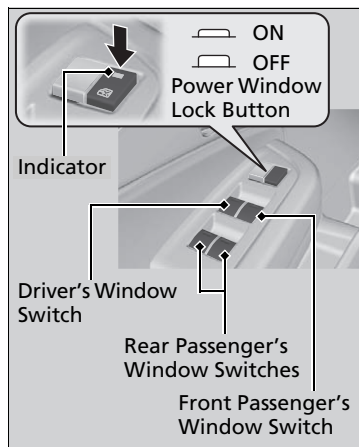

#### **Automatic operation**

**To open:** Push the switch down firmly.

**To close:** Pull the switch up firmly.

The window opens or closes completely. To stop the window at any time, push or pull the switch briefly.

#### **Manual operation**

**To open:** Push the switch down lightly, and hold it until the desired position is reached.

**To close:** Pull the switch up lightly, and hold it until the desired position is reached.

## ■ Opening Windows and the Moonroof\* or Panoramic Roof\* with the Remote



**To open:** Press the unlock button twice within 10 seconds and hold it down the second time. If the windows stop midway, repeat the procedure.

## ■ Opening/Closing Windows and the Moonroof\* or Panoramic Roof\* with the Key

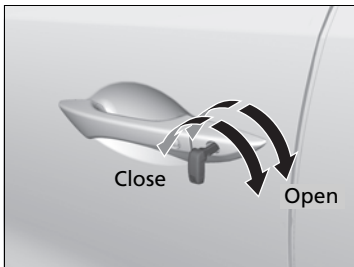

**To open:** Unlock the driver's door with the key. Within 10 seconds of returning the key to the central position, turn the key in the unlock direction and hold it there.

**To close:** Lock the driver's door with the key. Within 10 seconds of returning the key to the central position, turn the key in the lock direction and hold it there.

Release the key to stop the windows/ moonroof\* or panoramic roof\* at the desired position. If you want further adjustment, repeat the same operation.

\* Not available on all models

## Opening and Closing the Moonroof

You can only operate the moonroof when the power mode is in ON. Use the switch in the front of the ceiling to open and close the moonroof.

### Using the Moonroof Switch

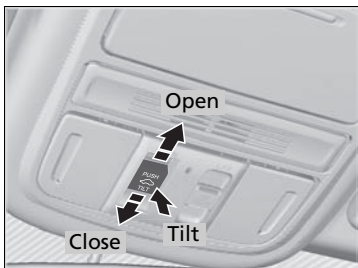

#### Automatic operation

**To open:** Pull the switch back firmly.

**To close:** Push the switch forward firmly.

The moonroof will automatically open or close all the way. To stop the moonroof midway, touch the switch briefly.

#### Manual operation

**To open:** Pull the switch back lightly, and hold it until the desired position is reached.

**To close:** Push the switch forward lightly, and hold it until the desired position is reached.

#### Tilting the moonroof up

**To tilt:** Push on the center of the moonroof switch.

**To close:** Push the switch forward firmly, then release.

### Opening and Closing the Moonroof

## WARNING

Opening or closing the moonroof on someone's hands or fingers can cause serious injury.

Make sure all hands and fingers are clear of the moonroof before opening or closing it.

### NOTICE

Opening the moonroof in below freezing temperature or when it is covered with snow or ice can damage the moonroof panel or motor.

The power moonroof can be operated for up to 10 minutes after you set the power mode to VEHICLE OFF (LOCK).

Opening either front door cancels this function.

When resistance is detected, the auto reverse function causes the moonroof to change directions, then stop. Auto reverse stops sensing when the moonroof is almost closed to ensure that it fully closes.

You can use the remote transmitter or the key to operate the panoramic roof.

➤ **Opening Windows and the Moonroof\* or Panoramic Roof\* with the Remote** P. 147

➤ **Opening/Closing Windows and the Moonroof\* or Panoramic Roof\* with the Key** P. 147

## Opening/Closing the Panoramic Roof

You can only operate the panoramic roof switches when the power mode is in ON. Use the switch in the front of the ceiling to open and close the panoramic roof.

### ☒ Opening/Closing the Panoramic Roof

#### **⚠ WARNING**

Opening or closing the panoramic roof on someone's hands or fingers can cause serious injury.

Make sure all hands and fingers are clear of the panoramic roof before opening or closing it.

#### **NOTICE**

Opening the panoramic roof in below freezing temperature or when it is covered with snow or ice can damage the panoramic roof panel or motor.

The panoramic roof and sunshade can be operated for up to 10 minutes after you set the power mode to VEHICLE OFF (LOCK).

Opening either front door cancels this function.

When resistance is detected, the auto reverse function causes the panoramic roof to change directions, then stop. Auto reverse stops sensing when the panoramic roof is almost closed to ensure that it fully closes. Make sure that all objects, including fingers, are clear of the panoramic roof.

You can use the remote transmitter or the key to operate the panoramic roof.

☒ **Opening Windows and the Moonroof\* or Panoramic Roof\* with the Remote** P. 147

☒ **Opening/Closing Windows and the Moonroof\* or Panoramic Roof\* with the Key** P. 147

\* Not available on all models

## ■ Using the Sunshade Switch

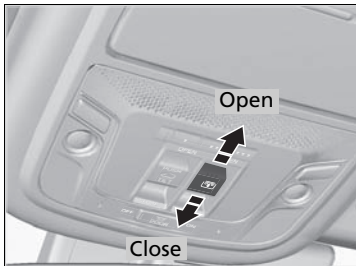

### ■ Automatic operation

**To open:** Pull the switch back firmly.

**To close:** Push the switch forward firmly.

The sunshade automatically opens or closes all the way. To stop the sunshade midway, touch the switch briefly.

### ■ Manual operation

**To open:** Pull the switch back lightly, and hold it until the desired position is reached.

**To close:** Push the switch forward lightly, and hold it until the desired position is reached.

## ☒ Using the Sunshade Switch

The sunshade can be opened or closed to adjust the amount of light that enters the cabin.

When you use the sunshade switch to open the sunshade, the panoramic roof does not move.

The sunshade cannot be fully closed if the panoramic roof is open. When you close the sunshade with the panoramic roof open, the sunshade stops slightly ahead of the panoramic roof glass. When you push the switch forward again, the sunshade and the panoramic roof close together.

## Using the Panoramic Roof Switch

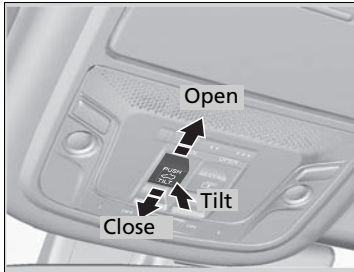

### Automatic operation

**To open:** Pull the switch back firmly.

**To close:** Push the switch forward firmly.

The panoramic roof automatically opens or closes all the way. To stop the panoramic roof midway, touch the switch briefly.

### Manual operation

**To open:** Pull the switch back lightly, and hold it until the desired position is reached.

**To close:** Push the switch forward lightly, and hold it until the desired position is reached.

### Tilting the panoramic roof up

**To tilt:** Push on the center of the panoramic roof switch.

**To close:** Push the switch forward firmly.

## Using the Panoramic Roof Switch

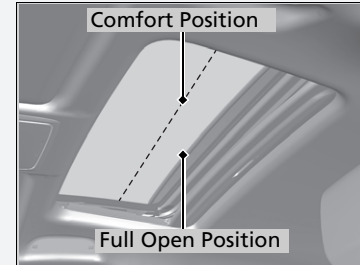

The panoramic roof cannot be fully opened in a single operation. The panoramic roof has a “comfort” position or wind noise reduction position at which the roof first stops. To open fully, pull the switch back again after the roof has stopped at this position.

Whenever the panoramic roof is opening, the sunshade moves along with it. However, when the panoramic roof is closing, the sunshade does not move.

When you tilt open the panoramic roof, the sunshade opens slightly to let in fresh air. When you close the panoramic roof from this position, the sunshade returns to its closed position.



## ENGINE START/STOP Button

### ■ Changing the Power Mode

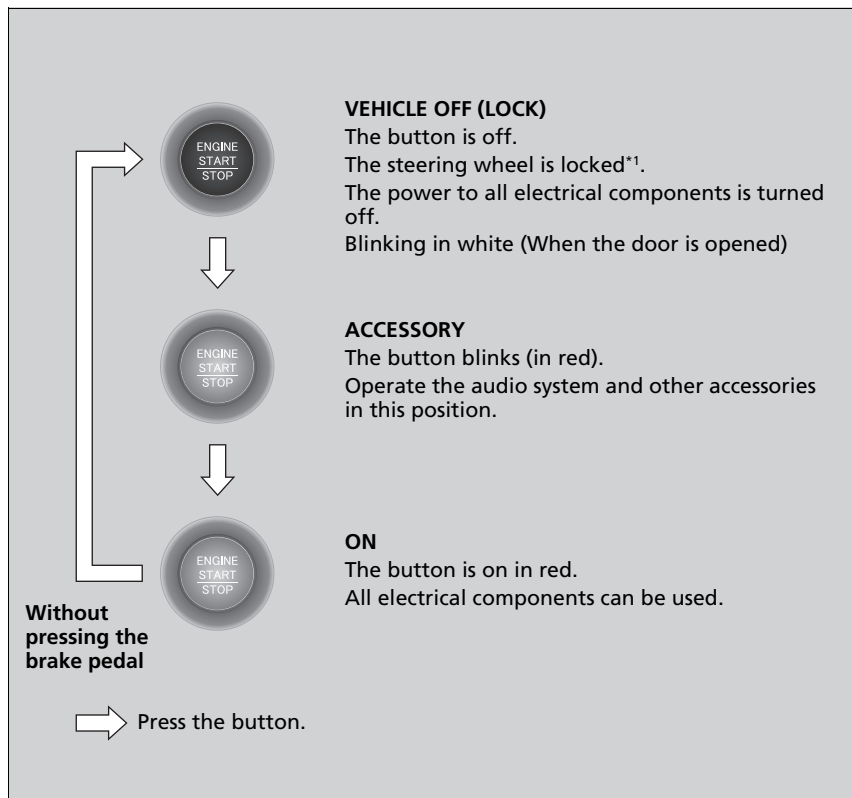

\*1: Canadian models

### ▣ ENGINE START/STOP Button

#### ENGINE START/STOP Button Operating Range

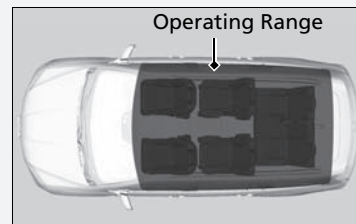

You can start the engine when the smart entry remote is inside the vehicle. The engine may also run if the smart entry remote is close to the door or window, even if it is outside the vehicle.

ON mode:

The **ENGINE START/STOP** button is red when the power mode is set to ON.

If the smart entry remote battery is weak, beeper sounds and the **To Start, Hold Remote Near Start Button** message appears on the MID.

▣ **If the Smart Entry Remote Battery is Weak**  
P. 630

#### Canadian models

If the power mode does not change from VEHICLE OFF to ACCESSORY, press the **ENGINE START/STOP** button while moving the steering wheel left and right. The steering wheel will unlock, allowing the mode to change.

## Automatic Power Off

If you leave the vehicle for 30 to 60 minutes with the transmission in **P** and the power mode in ACCESSORY, the vehicle automatically goes into the mode similar to VEHICLE OFF (LOCK) to avoid the battery drain.

### Canadian models

When in this mode:

The steering wheel does not lock.

You cannot lock or unlock doors with the remote transmitter or the smart entry system.

Press the **ENGINE START/STOP** button to switch the mode to VEHICLE OFF (LOCK).

## Power Mode Reminder

If you open the driver's door when the power mode is set to ACCESSORY, a warning beeper sounds.

## ■ Smart Entry Remote Reminder

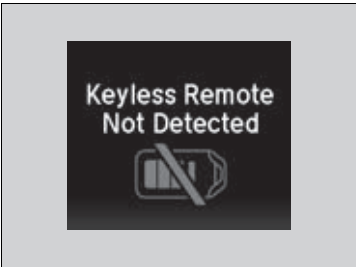

Warning beepers may sound from inside or/ and outside the vehicle to remind you that the smart entry remote is out of the vehicle. If the beeper continues even after the remote is put back inside, place it within its operational range.

### ■ When the power mode is in ON

If the smart entry remote is taken out of the vehicle, and the driver's door is closed, warning beepers sound from both inside and outside the vehicle. A warning message on the MID notifies the driver inside that the remote is outside of the vehicle.

### ■ When the power mode is in ACCESSORY

If the smart entry remote is taken out of the vehicle, and the driver's door is closed, a warning beeper sounds from outside the vehicle.

## ▣ Smart Entry Remote Reminder

When the smart entry remote is within the system's operational range, and the driver's door is closed, the warning function cancels.

If the smart entry remote is taken out of the vehicle after the engine has been started, you can no longer change the **ENGINE START/STOP** button mode or restart the engine. Always make sure if the remote is in your vehicle when you operate the **ENGINE START/STOP** button.

Removing the smart entry remote from the vehicle through a window does not activate the warning beeper.

Do not put the smart entry remote on the dashboard or in the glove box. It may cause the warning beeper to go off. Under some other conditions that can prevent the vehicle from locating the remote, the warning beeper may also go off even if the remote is within the system's operational range.

## Turn Signals

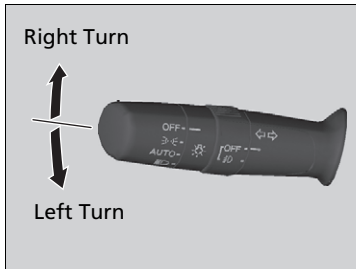

The turn signals can be used when the power mode is in ON.

### ■ One-touch turn signal

When you lightly push up or down and release the turn signal lever, the exterior turn signals and turn signal indicator blink three times. This feature can be used when signaling for a lane change.

## Light Switches

### Manual Operation

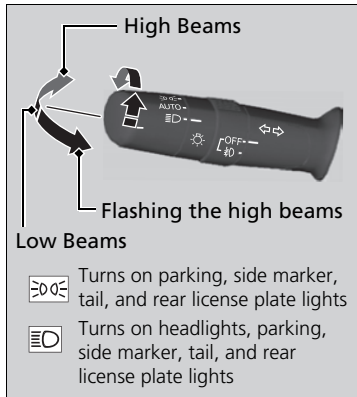

Rotating the light switch turns the lights on and off, regardless of the power mode setting.

#### High beams

Push the lever forward until you hear a click.

#### Low beams

When in high beams, pull the lever back to return to low beams.

#### Flashing the high beams

Pull the lever back, and release it.

#### Lights off

Turn the lever to **OFF** either when:

- The transmission is in **P**.
- The parking brake is applied.

### Light Switches

If you leave the power mode in VEHICLE OFF (LOCK) with the lights on, a light on reminder chime sounds when you open the driver's door.

#### Models with LED headlights

If you sense that the level of the headlights is abnormal, have your vehicle inspected by a dealer.

Do not leave the lights on when the engine is off because it will cause the battery to discharge.

#### Models with automatic headlight adjusting system

Your vehicle is equipped with the automatic headlight adjusting system that automatically adjusts the vertical angle of the high/low beam headlights. If you find a significant change in the vertical angle of the headlights, there may be a problem with the system. Have your vehicle checked by a dealer.

## Automatic Lighting Control



Automatic lighting control can be used when the power mode is in ON.

When the light switch is in **AUTO**, the headlights and other exterior lights will switch on and off automatically depending on the ambient brightness.

- ▶ You can change the auto light sensitivity setting.
- ▶ **Customized Features** P. 351

### Automatic Lighting Control

We recommend that you turn on the lights manually when driving at night, in a dense fog, or in dark areas such as long tunnels or parking facilities.

The light sensor is in the location shown below. Do not cover this light sensor with anything; otherwise, the automatic lighting system may not work properly.

#### Models with automatic intermittent wipers

Light Sensor

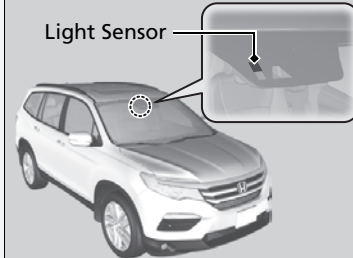

#### Models without automatic intermittent wipers

Light Sensor

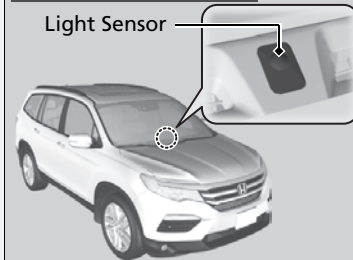

### ■ Headlight Integration with Wiper

The headlights automatically come on when the wipers are used several times within a certain number of intervals with the headlight switch in **AUTO**. The headlights automatically go off a few minutes later if the wipers are stopped.

### ■ Automatic Lighting Off Feature

The headlights, all other exterior lights, and the instrument panel lights turn off 15 seconds after you set the power mode to VEHICLE OFF (LOCK), take the remote with you, and close the driver's door.

If you set the power mode to VEHICLE OFF (LOCK) with the headlight switch on, but do not open the door, the lights turn off after 10 minutes (three minutes, if the switch is in the **AUTO** position).

The lights turn on again when you unlock or open the driver's door. If you unlock the door, but do not open it within 15 seconds, the lights go off. If you open the driver's door, you will hear a lights on reminder chime.

### ▶▶ Automatic Lighting Control

Adjust the auto light sensitivity as follows:

Setting	The exterior lights come on when the ambient light is at
Max	
High	
Mid	
Low	
Min	

### ▶▶ Headlight Integration with Wiper

This feature activates during the headlights are off in **AUTO**. The instrument panel brightness does not change when the headlights come on.

When the ambient light is dark, the automatic lighting control feature overrides, and the headlights come on with or without the wipers sweeping more than several times.

### ▶▶ Automatic Lighting Off Feature

You can change the headlight auto off timer setting. **▶▶ Customized Features P. 351**

## Fog Lights\*

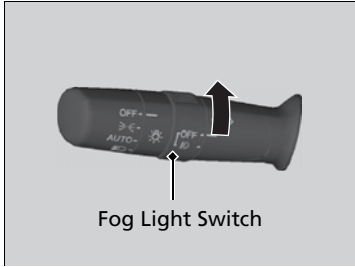

When the parking lights or the headlights are on, turn the fog light switch on to use the fog lights.

### ☒ Fog Lights\*

The fog lights go off when the headlights turn off, or when the daytime running lights are on.

\* Not available on all models



## Auto High-Beam System \*

Uses the camera attached, monitors the space ahead of your vehicle, and automatically changes the low beam headlights to high beam headlights when necessary.

### The system operates when:

- The headlight switch is in **AUTO**.
- The lever is in the low beam position.
- The system recognizes that you are driving at night and the low beam headlights come on.
- The vehicle speed is above 25 mph (40 km/h).

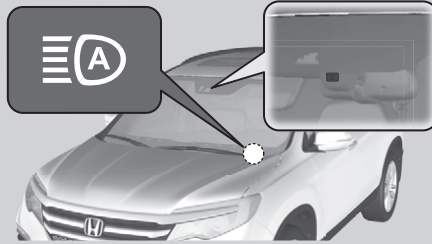

### The system changes between high and low beam headlights when:

The camera is not detecting any lights coming from preceding or oncoming vehicles: The headlights change to high beams.

The camera detects lights coming from a preceding or oncoming vehicle: The headlights are returned to low beams.

The view angle or distance that the camera can detect lights ahead differs depending on conditions, such as the brightness of the lights and the weather.

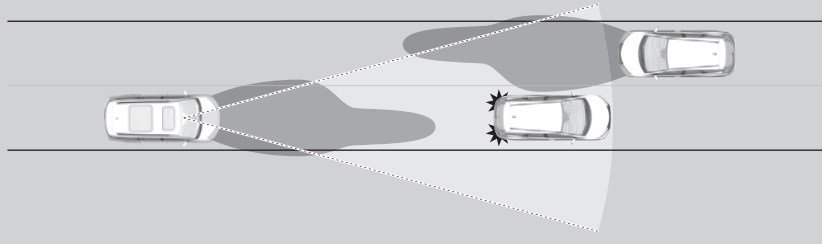

### ⓘ Auto High-Beam System \*

The auto high-beam system determines when to change the headlight beams by responding to the brightness of the lights ahead of your vehicle. In the following cases, the system may not respond to the lights properly:

- The brightness of the lights from the preceding or oncoming vehicle is intense or poor.
- Visibility is poor due to the weather (rain, snow, fog, windshield frost, etc.).
- Other light sources, such as streetlights and electric billboards are illuminating the road ahead.
- The brightness level of the road ahead constantly changes.
- The road is bumpy or with many curves.
- A vehicle cuts in front of you, or a vehicle in front of you is not in the preceding or oncoming direction.
- Your vehicle is tilted with a heavy load in the rear.

If you find the timing of beam changes inconvenient for driving, change the headlight beams manually.

## ■ To Operate the System

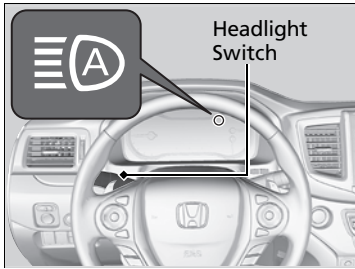

Turn the headlight switch in **AUTO** and pull the headlight lever to low beam.

📖 **Light Switches** P. 156

The auto high-beam system indicator comes on.

## ■ Temporary cancellation

The auto high-beam system operation is temporarily canceled while:

- You are continuously driving at a speed below 15 mph (24 km/h).
- The vehicle speed is below 6 mph (10 km/h).
- The windshield wipers run at high speed for more than a few seconds.

The system operation resumes once the condition that caused it to cancel improves.

## 📖 To Operate the System

For the auto high-beam system to work properly:

- Do not place an object that reflects light on the dashboard.
- Keep the windshield around the camera clean. When cleaning the windshield, be careful not to apply the windshield cleanser to the camera lens.
- Do not attach an object, sticker or film in the area around the camera.
- Do not touch the camera lens.

If the camera receives a strong impact, or repairing of the area near the camera is required, consult a dealer.

To help reduce the likelihood that high interior temperatures will cause the camera system to shut off, when parking, find a shady area or face the front of the vehicle away from the sun.

If you use a reflective sun shade, do not allow it to cover the camera housing. Covering the camera can concentrate heat on the camera.

### ■ To manually cancel the system temporarily

You can cancel the operation when you manually change the headlights to high beams. Push the lever forward until you hear a click, or lightly pull the lever towards you to flash high beams. The auto high-beam system indicator goes off.

If you want the auto high-beam system operation to resume at once, pull the lever towards you.

### ■ To Disable the System

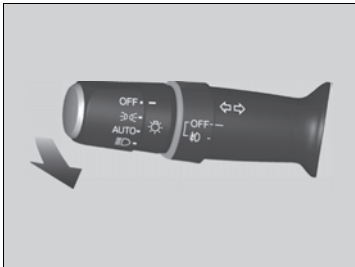

Disable the system when the vehicle is parked with the power mode in ON and the light switch is in the **AUTO** position.

**To disable the system:** Pull the light switch lever towards you and hold it for 40 seconds. The auto high-beam indicator in the meter will blink twice.

**To enable the system:** Pull the light switch lever towards you and hold it for 30 seconds. The auto high-beam indicator in the meter will blink once.

### ▶▶ To Operate the System

If the **Can Not Operate:**  message appears: Park your vehicle in a safe place. Wipe away debris blocking the windshield, then start driving again. If the message remains on even after driving for a while with the clean windshield, have your vehicle checked by a dealer.

### ▶▶ To Disable the System

The auto high-beam system will remain in the selected disabled or enabled setting each time you start the engine.

## Daytime Running Lights

---

The daytime running lights come on when the following conditions have been met:

- The power mode is in ON.
- The headlight switch is off.
- The parking brake is released.

The daytime running lights are off once the headlight switch is turned on, or when the head light switch is in **AUTO** and it is getting darker outside.

## Wipers and Washers

### ■ Windshield Wipers/Washers

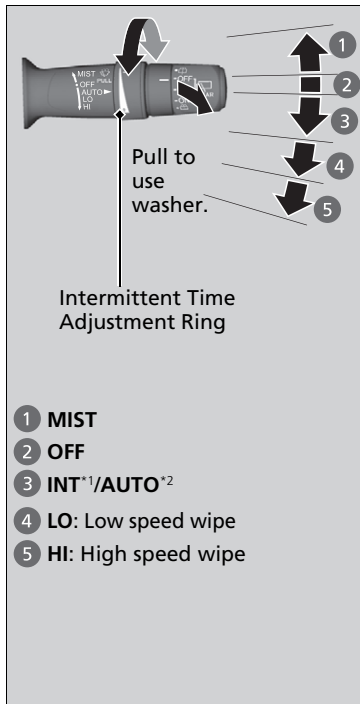

The windshield wipers and washers can be used when the power mode is in ON.

#### ■ MIST

The wipers run at high speed until you release the lever.

#### ■ Wiper switch (OFF, INT<sup>\*</sup>/AUTO<sup>\*2</sup>, LO, HI)

Move the lever up or down to change the wiper settings.

#### ■ Adjusting wiper operation

Turn the adjustment ring to adjust wiper operation.



Lower speed, fewer sweeps

Higher speed, more sweeps

#### ■ Washer

Sprays while you pull the lever toward you. When you release the lever for more than one second, the spray stops, the wipers sweep two or three more times to clear the windshield, then stop.

\*1: Models with manual intermittent operation

\*2: Models with automatic intermittent operation

### ▶ Wipers and Washers

#### NOTICE

Do not use the wipers when the windshield is dry. The windshield will get scratched, or the rubber blades will get damaged.

#### NOTICE

In cold weather, the blades may freeze to the windshield, becoming stuck. Operating the wipers in this condition may damage the wipers. Use the defroster to warm the windshield, then turn the wipers on.

If the vehicle speeds up while the wipers are operating intermittently, the length of the wipe interval shortens.

When the vehicle starts moving, the wipers make a single sweep.

When the vehicle speeds up, the wiper operation's shortest delay setting (+) and the **LO** setting become the same.

Turn the washers off if no washer fluid comes out. The pump may get damaged.

The wiper motor may stop motor operation temporarily to prevent an overload. Wiper operation will return to normal within a few minutes, once the circuit has returned to normal.

## ■ Automatic Intermittent Wipers \*

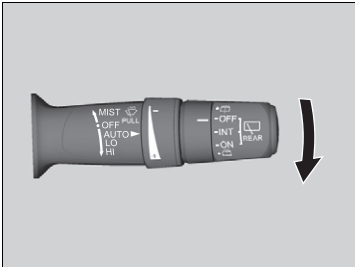

When you push the lever down to **AUTO**, the windshield wipers sweep once, and go into the automatic mode.

The wipers operate intermittently, at low speed, or at high speed and stops in accordance with the amount of rainfall the rainfall sensor detects.

### ■ Auto sensitivity adjustment

When the wiper function is set to **AUTO**, you can adjust the sensitivity of the rain fall sensor (using the adjustment ring) so that wipers will operate in accordance with your preferene.

#### Sensor sensitivity

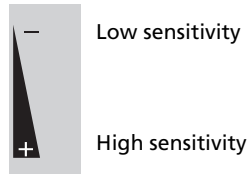

## ⊠ Automatic Intermittent Wipers \*

The rainfall sensor is in the location shown below.

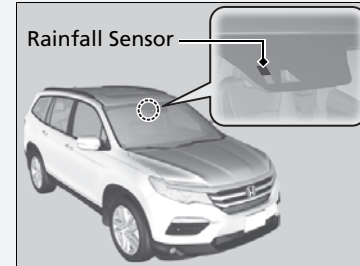

### NOTICE

**AUTO** should always be turned **OFF** before the following situation in order to severe damage to the wiper system:

- Cleaning the windshield
- Driving through a car wash
- Driving when it is not raining.

\* Not available on all models

## ■ Rear Wiper/Washer

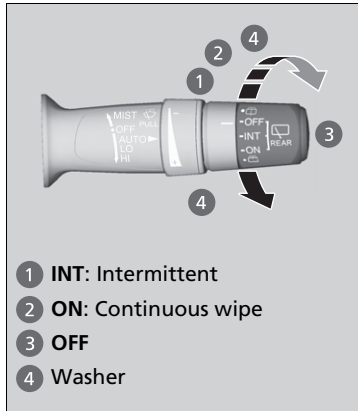

- 1 INT: Intermittent
- 2 ON: Continuous wipe
- 3 OFF
- 4 Washer

The rear wiper and washer can be used when the power mode is in ON.

■ **Wiper switch (OFF, INT, ON)**  
Change the wiper switch setting according to the amount of rain.

■ **Washer (  )**  
Sprays while you rotate the switch to this position. Hold it to activate the wiper and to spray the washer. Once released, it stops operating after a few more sweeps.

### ■ Operating in reverse

When you select the transmission to **R** with the front wiper activated, the rear wiper operates automatically as follows even if its switch is off.

Front Wiper Operation	Rear Wiper Operation
Intermittent	Intermittent
Low speed wipe	Continuous
High speed wipe	

## ▶▶ Wipers and Washers

If the wiper stops operating due to any obstacle such as the build-up of snow, park the vehicle in a safe place.

Rotate the wiper switch to **OFF**, and set the power mode to ACCESSORY or VEHICLE OFF (LOCK), then remove the obstacle.

## Brightness Control

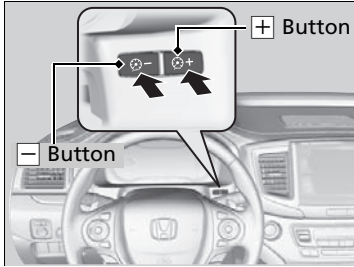

When the power mode is in ON, you can use the **+** or **-** button to adjust instrument panel brightness.

**To brighten:** Press the **+** button.

**To dim:** Press the **-** button.

You will hear a beep when the brightness reaches minimum or maximum. The MID will return to its original state several seconds after adjusting the brightness.

### ■ Brightness level indicator

The brightness level is shown on the MID while you are adjusting it.

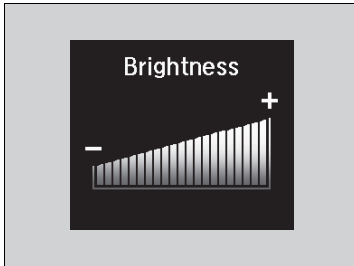

### ☒ Brightness Control

Instrument panel brightness varies, depending on whether the exterior lights are on or off. The instrument panel dims to reduce glare when they are on.

When it is bright outside and the headlight integration with the wiper is activated, the instrument panel brightness does not change.

If you press the **+** button until the brightness display is up to max, the beeper sounds. This cancels the reduced instrument panel brightness when the parking lights are on.

The brightness can be set differently for when the exterior lights are on, and when they are off.



## Defogger/Heated Door Mirror\*

Canadian models

### Heated Windshield Button

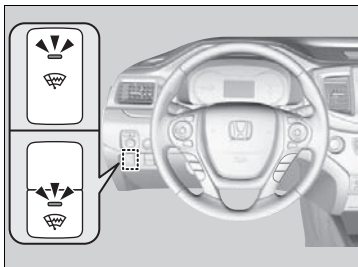

Press the heated windshield button to deice the windshield when the power mode is in ON.

### Defogger/Heated Door Mirror\*

This system consumes a lot of power, so turn it off when the window has been defogged or deiced.

### Heated Windshield Button

This system activates automatically if the temperature is below 4°C, then deactivates after 15 minutes. After that, the heated windshield button must be pressed to activate the system again for another 15 minutes.

### Rear Defogger/Heated Door Mirror\* Button

Press the rear defogger and heated door mirror button\* to defog the rear window and mirrors when the power mode is in ON.

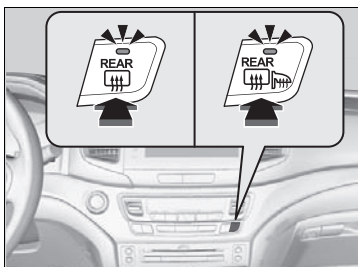

The rear defogger and heated door mirrors\* automatically switch off after 10-30 minutes depending on the outside temperature.

### Rear Defogger/Heated Door Mirror\* Button

#### NOTICE

When cleaning the inside of the rear window, be careful not to damage the heating wires. It is critical to wipe the window from side to side along the defogger heating wires.

## Driving Position Memory System\*

You can store two driver's seat (except for power lumbar) and door mirror positions with the driving position memory system.

When you unlock and open the driver's door with a remote transmitter, or smart entry system, the seat and door mirrors adjust automatically to one of the two preset positions.

The MID shows you which remote transmitter you used to unlock the vehicle when you enter.

- **DRIVER 1** transmitter is linked to memory button 1.
- **DRIVER 2** transmitter is linked to memory button 2.



The driver's seat moves rearward depending on the set seating position once you

- Stop the vehicle.
- Put the transmission in **P**.
- Turn the engine off.
- Then open the driver's door.

Once the power mode is in the ACCESSORY position, the driver's seat moves to the **DRIVER 1** or **2** preset position.

### ⊗ Driving Position Memory System\*

Using the audio/information screen, you can disable the automatic seat and door mirrors adjustment function.

➤ **Customized Features** P. 351

The driver's seat easy exit feature:

- Can be turned ON/OFF.

➤ **Customized Features** P. 351

### System Operation

The system will not operate if:

- The vehicle speed is above 3 mph (5 km/h).
- Either memory position button is pressed while the seat is in motion.
- The seat position is adjusted while in operation.
- The memory 1 or 2 position is set fully to the rear.

## ■ Storing a Position in Memory

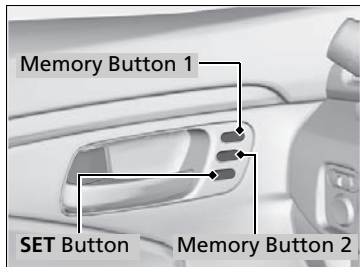

1. Set the power mode to ON. Adjust the driver's seat and the door mirrors to the desired position.
2. Press the **SET** button.
  - ▶ You will hear a beep, and the memory button indicator light will blink.
3. Press memory button **1** or **2** within five seconds of pressing the **SET** button.
  - ▶ Once the seat and the outside mirror positions have been memorized, the indicator light on the button you pressed stays on.

## ■ Recalling the Stored Position

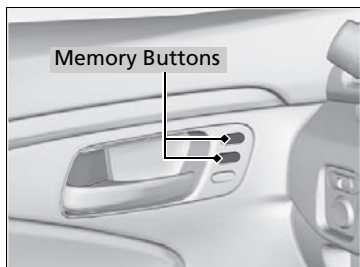

1. Select **P**.
2. Apply the parking brake.
3. Press a memory button (**1** or **2**).
  - ▶ You will hear a beep, and the indicator light will blink.

The seat and the door mirrors will automatically move to the memorized positions. When it has finished moving, you will hear the beep, and the indicator light stays on.

## ☒ Storing a Position in Memory

After you press the **SET** button, the storing operation will be canceled when:

- You do not press the memory button within five seconds.
- You readjust the seat or the outside mirror position before the double-beep.
- You set the power mode to any position except ON.

## ☒ Recalling the Stored Position

The seat will stop moving if you:

- Press the **SET** button, or a memory button (**1** or **2**).
- Adjust the seat or the door mirror position.
- Select into any position except **P**.

## Adjusting the Steering Wheel

The steering wheel height and distance from your body can be adjusted so that you can comfortably grip the steering wheel in an appropriate driving posture.

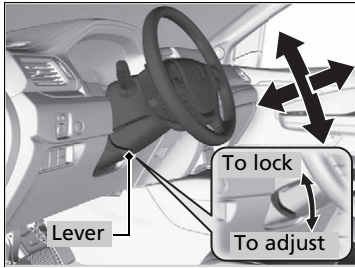

1. Push the steering wheel adjustment lever down.
  - ▶ The steering wheel adjustment lever is under the steering column.
2. Move the steering wheel up or down, and in or out.
  - ▶ Make sure you can see the instrument panel gauges and indicators.
3. Pull the steering wheel adjustment lever up to lock the steering wheel in position.
  - ▶ After adjusting the position, make sure you have securely locked the steering wheel in place by trying to move it up, down, in, and out.

### Adjusting the Steering Wheel

#### **⚠ WARNING**

Adjusting the steering wheel position while driving may cause you to lose control of the vehicle and be seriously injured in a crash.

Adjust the steering wheel only when the vehicle is stopped.

Make any steering wheel adjustments before you start driving.

## Interior Rearview Mirror

Adjust the angle of the rearview mirror when you are sitting in the correct driving position.

### Rearview Mirror with Day and Night Positions\*

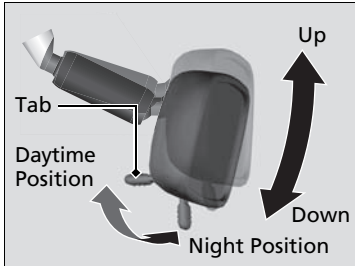

Flip the tab to switch the position. The night position will help to reduce the glare from headlights behind you when driving after dark.

### Automatic Dimming Rearview Mirror\*

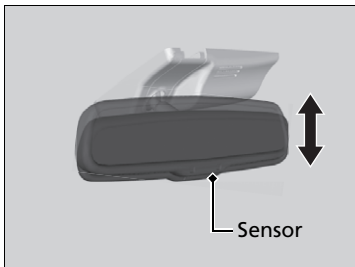

When driving after dark, the automatic dimming rearview mirror reduce the glare from headlights behind you.

### Adjusting the Mirrors

Keep the inside and outside mirrors clean and adjusted for best visibility.

Adjust the mirrors before you start driving.

➤ **Adjusting the Seat Positions** P. 174

### Automatic Dimming Rearview Mirror\*

The auto dimming function cancels when the transmission is in [R].

## Power Door Mirrors

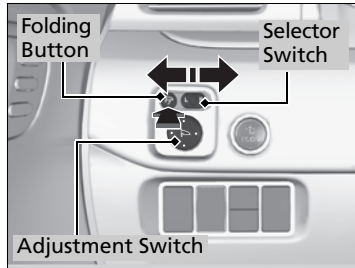

You can adjust the door mirrors when the power mode is in ON.

### ■ Mirror position adjustment

**L/R selector switch:** Select the left or right mirror. After adjusting the mirror, return the switch to the center position.

**Mirror position adjustment switch:** Press the switch left, right, up, or down to move the mirror.

### ■ Folding door mirrors\*

Press the folding button to fold in and out the door mirrors.

### ■ Reverse Tilt Door Mirror\*

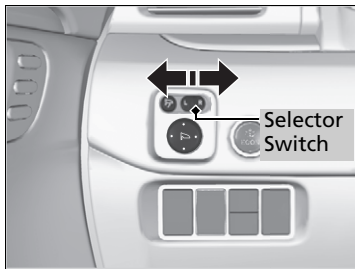

If activated, either side door mirror automatically tilts downward when you select the gear position to **R**; this improves close-in visibility on the selected side of the vehicle when backing up. The mirror automatically returns to its original position when you select out of **R**.

To activate this feature, set the power mode to ON, and slide the selector switch to the left or right side.

\* Not available on all models

## Adjusting the Seat Positions

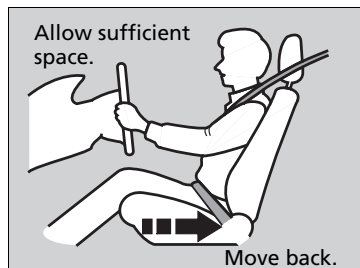

Adjust the driver's seat as far back as possible while allowing you to maintain full control of the vehicle. You should be able to sit upright, well back in the seat and be able to adequately press the pedals without leaning forward, and grip the steering wheel comfortably. The passenger's seat should be adjusted in a similar manner, so that it is as far back from the front airbag in the dashboard as possible.

### ■ Adjusting the front power seats\*

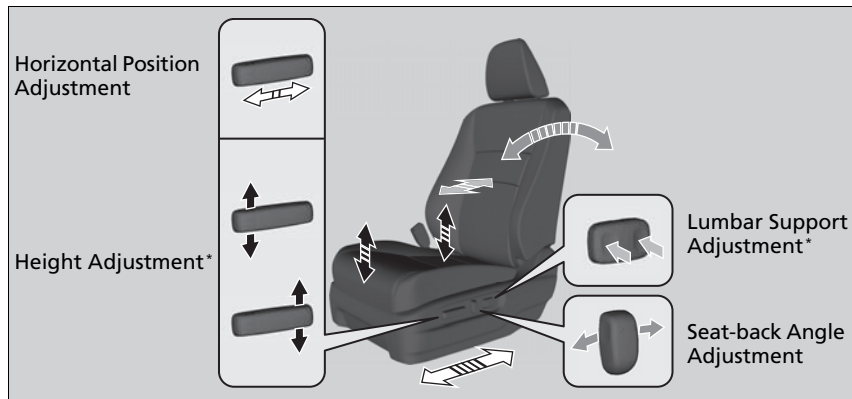

### Adjusting the Seats

## ⚠ WARNING

Sitting too close to a front airbag can result in serious injury or death if the front airbags inflate.

Always sit as far back from the front airbags as possible while maintaining control of the vehicle.

The National Highway Traffic Safety Administration and Transport Canada recommend that drivers allow at least 10 inches (25 cm) between the center of the steering wheel and the chest.

Always make seat adjustments before driving.

## ■ Adjusting the front manual seats\*

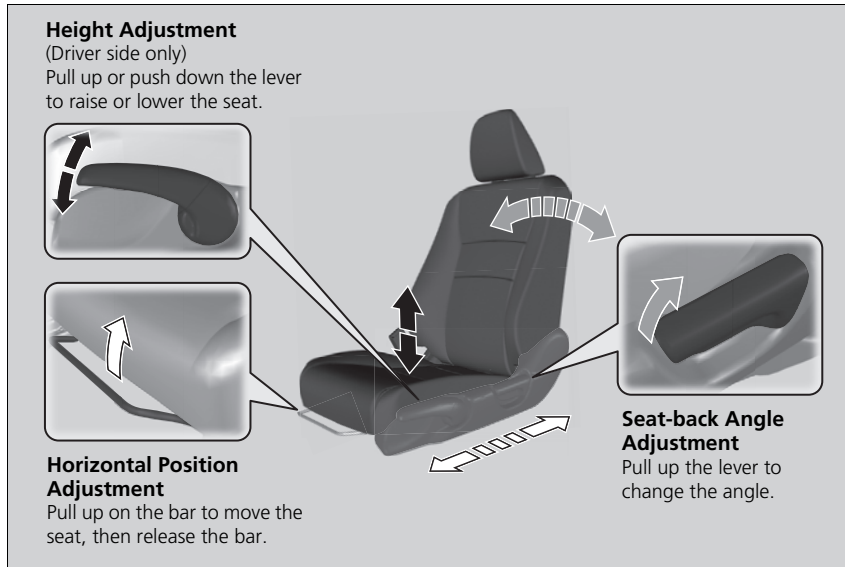

## ▣ Adjusting the front manual seats\*

Once a seat is adjusted correctly, rock it back and forth to make sure it is locked in position.

\* Not available on all models



## ■ Adjusting the second row manual seats

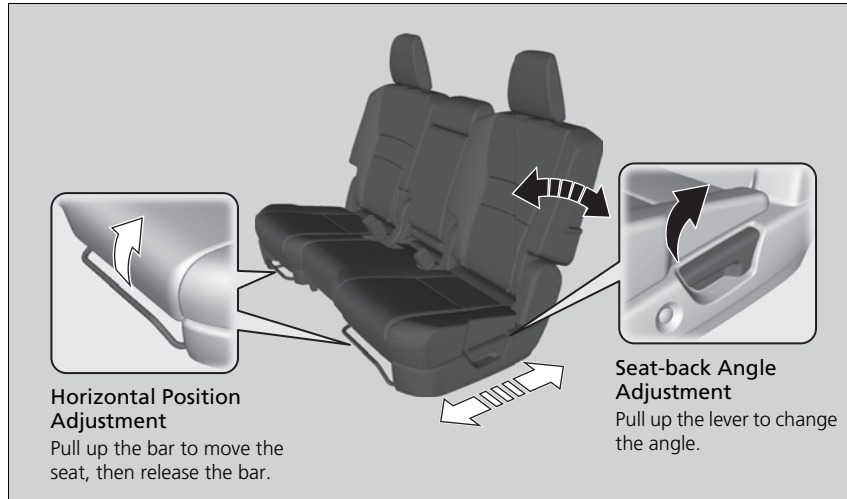

## ▶▶ Adjusting the second row manual seats

Once a seat is adjusted correctly, rock it back and forth to make sure it is locked in position.

## ■ Adjusting the third row manual seats

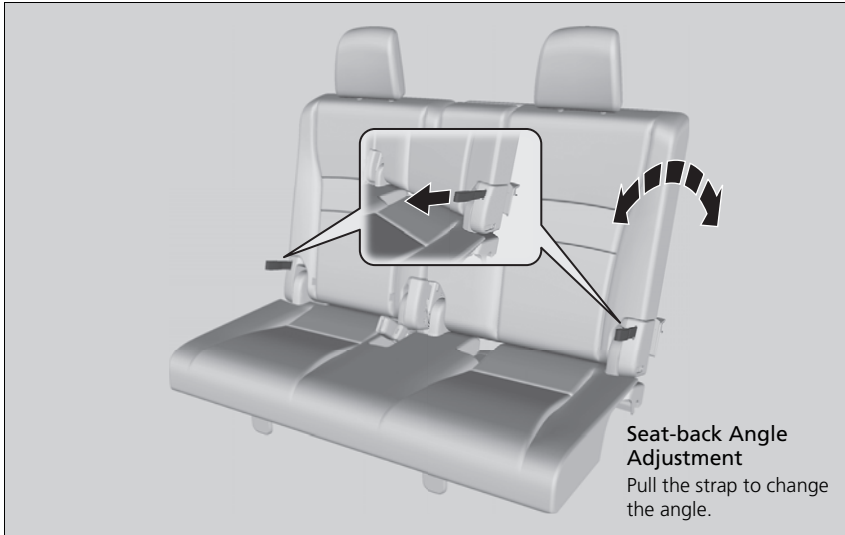

## ▣ Adjusting the third row manual seats

Once a seat is adjusted correctly, rock it back and forth to make sure it is locked in position.

## ■ Adjusting the Seat-Backs

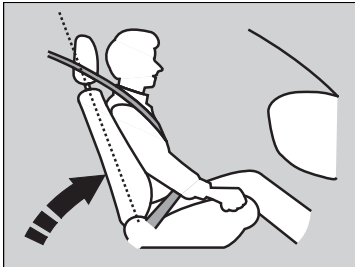

Adjust the driver's seat-back to a comfortable, upright position, leaving ample space between your chest and the airbag cover in the center of the steering wheel.

The front seat passenger should also adjust their seat-back to a comfortable, upright position.

Reclining a seat-back so that the shoulder part of the belt no longer rests against the occupant's chest reduces the protective capability of the belt. It also increases the chance of sliding under the belt in a crash and being seriously injured. The farther a seat-back is reclined, the greater the risk of injury.

## ▶▶ Adjusting the Seat-Backs

### **⚠ WARNING**

**Reclining the seat-back too far can result in serious injury or death in a crash.**

**Adjust the seat-back to an upright position, and sit well back in the seat.**

Do not put a cushion, or other object, between the seat-back and your back. Doing so may interfere with proper seat belt or airbag operation.

If you cannot get far enough away from the steering wheel and still reach the controls, we recommend that you investigate whether some type of adaptive equipment may help.

## ■ Adjusting the Head Restraints

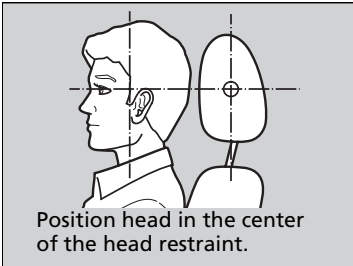

Your vehicle is equipped with head restraints in all seating positions.

Head restraints are most effective for protection against whiplash and other rear-impact crash injuries when the center of the back of the occupant's head rests against the center of the restraint. The tops of the occupant's ears should be level with the center height of the restraint.

## ■ Adjusting the front and second row outer head restraint positions\*

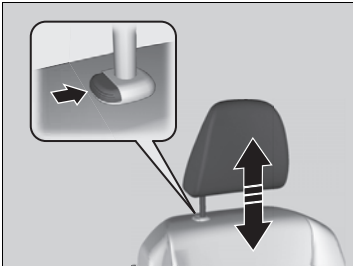

**To raise the head restraint:** Pull it upward.

**To lower the head restraint:** Push it down while pressing the release button.

## ⚠ Adjusting the Head Restraints

### ⚠ WARNING

Improperly positioning head restraints reduces their effectiveness and increases the likelihood of serious injury in a crash.

**Make sure head restraints are in place and positioned properly before driving.**

In order for the head restraint system to work properly:

- Do not hang any items on the head restraints, or from the restraint legs.
- Do not place any objects between an occupant and the seat-back.
- Install each restraint in its proper location.

\* Not available on all models

## ■ Changing the Second and Third Row Center Seat Head Restraint Position \*

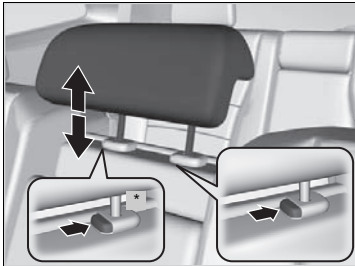

A passenger sitting in the second and third row center seating position should adjust the height of their head restraint to an appropriate position before the vehicle begins moving.

### **To raise the head restraint:**

Pull it upward.

### **To lower the head restraint:**

Push it down while pressing the release button(s).

## ■ Removing and Reinstalling the Head Restraints

Except third row outer seat head restraints

Head restraints can be removed for cleaning or repair.

### **To remove a head restraint:**

Models with a release button

Pull the restraint up as far as it will go. Then push the release button, and pull the restraint up and out.

Models with two release buttons

Pull the restraint up as far as it will go. Then push the release buttons which are located on the both legs at the same time, and pull the restraint up and out.

▶▶ Removing and Reinstalling the Head Restraints

## **⚠ WARNING**

Failure to reinstall, or correctly reinstall, the head restraints can result in severe injury during a crash.

Always replace the head restraints before driving.

**To reinstall a head restraint:**

Insert the legs back in place, then adjust the head restraint to an appropriate height while pressing the release button(s). Pull up on the restraint to make sure it is locked in position.

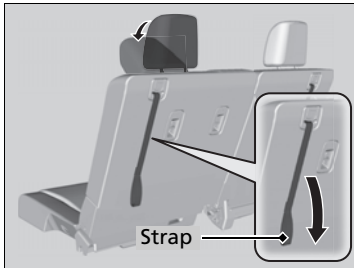
**Folding Down the Third Row Head Restraint**

A passenger in the third row seating position should put the head restraint in the upright position before the vehicle begins moving.

**To fold down the head restraint:**

Pull the strap.

**To put the head restraint back in the upright position:**

Pull up the head restraint and push rearward until it latches.

## ■ Maintain a Proper Sitting Position

After all occupants have adjusted their seats and head restraints, and put on their seat belts, it is very important that they continue to sit upright, well back in their seats, with their feet on the floor until the vehicle is safely parked and the engine is off.

Sitting improperly can increase the chance of injury during a crash. For example, if an occupant slouches, lies down, turns sideways, sits forward, leans forward or sideways, or puts one or both feet up, the chance of injury during a crash is greatly increased.

In addition, an occupant who is out of position in the front seat can be seriously or fatally injured in a crash by striking interior parts of the vehicle or being struck by an inflating front airbag.

### ▶▶ Maintain a Proper Sitting Position

## **WARNING**

**Sitting improperly or out of position can result in serious injury or death in a crash.**

**Always sit upright, well back in the seat, with your feet on the floor.**

## Rear Seats

### Third Row Seat Access

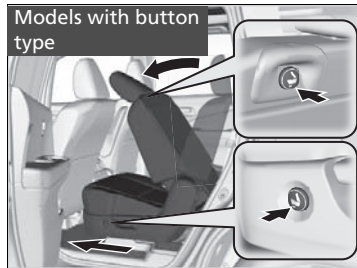

Pressing the button on the seat-back, or seat cushion tilts the second row outer seat's seat-back forward.

- ▶ The whole seat slides forward.

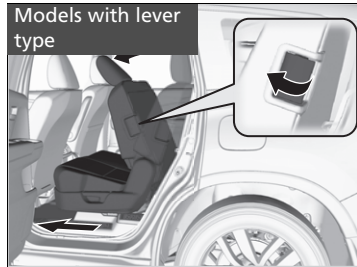

Pulling the lever on the seat side, and the second row outer seat's seat back forward.

- ▶ The whole seat slides forward.

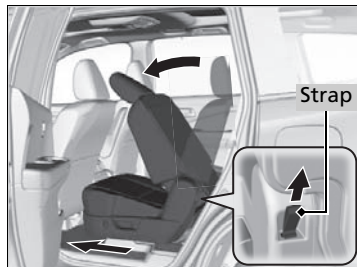

Pulling up on the strap also tilts the seat-back forward.

### Third Row Seat Access

The button is disabled when the vehicle is moving.

When you enter the third row seat, be careful not to trip over the second row seat belt.



## ■ Folding Down the Second Row Seat

Separately fold down the left and right halves of the second row seat to make room for cargo.

1. Store the center seat belt first. Insert the latch plate into the slot on the side of the anchor buckle.  
**➤ Seat Belt with Detachable Anchor P. 42**
3. Lower the center head restraint to its lowest position. Put the armrest back into the seat-back.

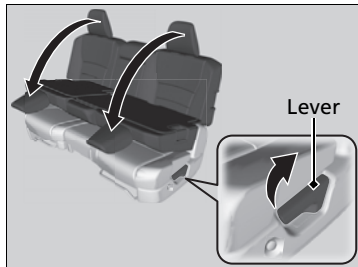

4. Pull up on the seat-back angle adjustment lever.

To return the seat to the original position, pull up the seat-back in the upright position.

## ▣ Folding Down the Second Row Seat

Make sure that the folded seat-back does not press against the front passenger seat, as this can cause the weight sensors in the front passenger seat to work improperly.

**➤ Passenger Airbag Off Indicator P. 56**

The front seats must be far enough forward so they do not interfere with the second row seats as they fold down.

To lock the seat-back upright, push it backwards until it locks.

Make sure the seat-back, head restraints and seat cushion are securely latched back into place before driving. Also, make sure all rear shoulder belts are positioned in front of the seat-back, and the center shoulder belt is re-positioned in the holding slot.

## ■ Folding Down the Third Row Seat

Separately fold down the left and right halves of the third row seat to make room for cargo.

### ■ To fold down the seat

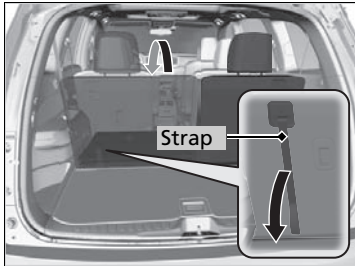

1. Pull the strap on the seat-back fully.
  - ▶ The head restraint tilts downward.
2. Push the seat-back forward while pulling the strap.

### ■ To return the seat to the original position

1. Pull the seat-back up with the strap pulled.
2. Pull the head restraint up to its original position.

## ☒ Folding Down the Third Row Seat

**Make sure all items in the cargo area or items extending to the third row seats are properly secured. Loose items can fly forward if you have to brake hard.**

## ☒ To return the seat to the original position

Make sure the seat-back and head restraints are securely latched back into place before driving.

## Armrest

### ■ Using the Front Seat Armrest



Pull down the armrest.

#### ■ Models with adjustable armrest

Pivot down the armrest all the way, then pull it up to a desired angle.

## Using the Second Row Seat Armrest

Models with captain seat



Pull down the armrest.

Models with bench seat



## Interior Lights

### Interior Light Switches

Models without panoramic roof

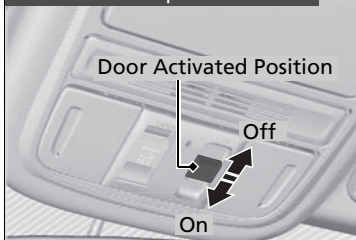

#### ■ ON

The interior lights come on regardless of whether the doors are open or closed.

#### ■ Door activated

The interior lights come on in the following situations:

- When any doors are opened.
- You unlock the driver's door.
- When the power mode is set to VEHICLE OFF (LOCK).

#### ■ OFF

The interior lights remain off regardless of whether the tailgate or the doors are open or closed.

Models with panoramic roof

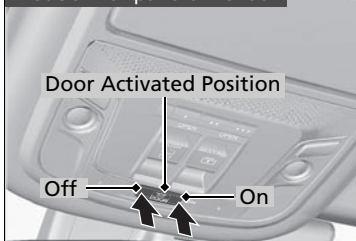

### Interior Light Switches

In the door activated position, the interior lights fade out and go off about 30 seconds after the doors are closed.

The lights go off after 30 seconds in the following situations:

- When you unlock the driver's door but do not open it.
- When you set the power mode to VEHICLE OFF (LOCK) but do not open a door.

You can change the interior lights dimming time.

🔧 **Customized Features** P. 351

The interior lights go off immediately in the following situations:

- When you lock the driver's door.
- When you close the driver's door in ACCESSORY mode.
- When you set the power mode to ON.

If you leave any doors open in VEHICLE OFF (LOCK) mode, the interior lights go off after about 15 minutes.

When the interior light switch is in **ON**, if you close the tailgate and all doors in VEHICLE OFF (LOCK) mode, the interior lights go off after about 30 minutes.

However, when the battery is weakened, the interior lights go off after about 30 minutes if any door is open.

## Map Lights

Models without panoramic roof

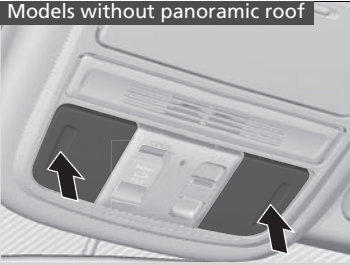

Models with panoramic roof



### ■ Front

The map lights can be turned on and off by pressing the button.

### ☒ Map Lights

#### Models without panoramic roof

When the interior light switch is in the door activated position and any door is open, pressing the button does not turn off the map light.

Models without panoramic roof

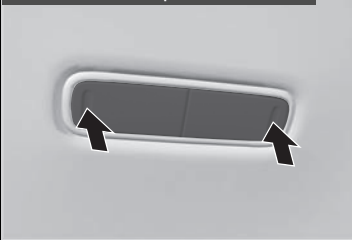

Models with panoramic roof

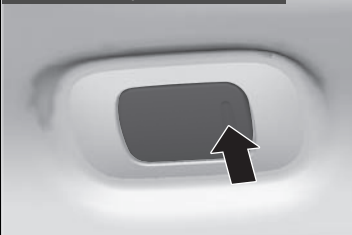

### ■ Second and third row

The map lights can be turned on and off by pressing the button when the front interior light switch is in the door activated position.

### ■ Cargo Area Lights

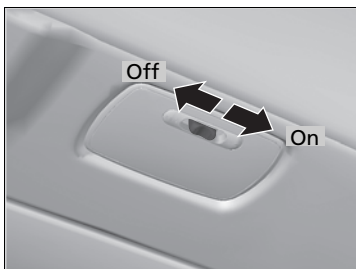

#### ■ ON

The light comes on when you open the tailgate, and goes off when closed.

#### ■ OFF

The light stays off with or without opening the tailgate.

## Interior Convenience Items

### ■ Glove Box

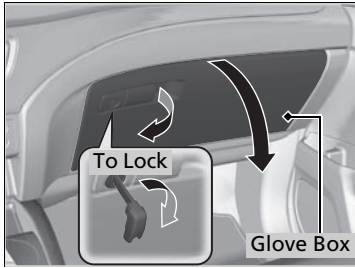

Pull the lever to open the glove box. You can lock the glove box with the built-in key.

### ■ Console Compartment

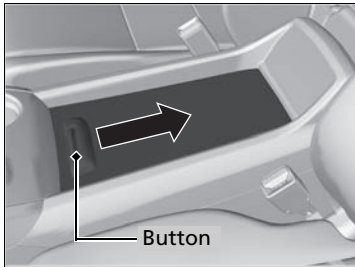

To open the console compartment, press the button to unlock the lid, and then slide it rearward.

### ☒ Glove Box

## ⚠ WARNING

An open glove box can cause serious injury to your passenger in a crash, even if the passenger is wearing the seat belt.

Always keep the glove box closed while driving.



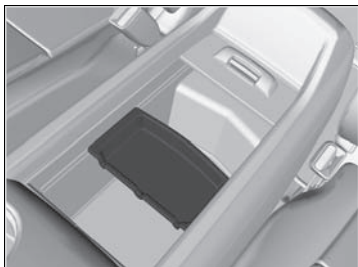

■ **Console Tray**

Slide the tray when you use the console compartment.

■ **Under-floor Storage Area**



Pull the handle to open the cargo floor lid.

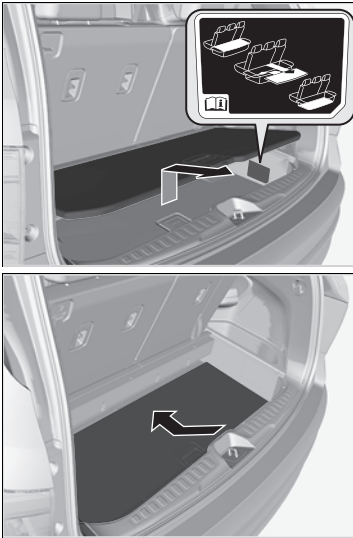

■ **Storing items on the lid at the bottom**

This is convenient when storing a tall item.

1. Pull the handle and open the lid.
2. Pull the lid towards you until it disengages from the support rods.
3. Push the far end of the lid down to the bottom of the under-floor storage area, then lower the other end.

▣ Storing items on the lid at the bottom

The lid can be flipped over and placed in either upper or lower position. This allows for storage of dirty items, or items that may damage the carpet lining of the lid.

## ■ Beverage Holders



### ■ Front seat beverage holders

Are located in the console between the front seats.

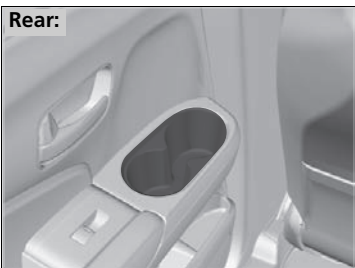

Rear:

### ■ Door side beverage holders

Are located on the both of front and rear door side pockets.

## ▶▶ Beverage Holders

### NOTICE

Spilled liquids damage the upholstery, carpeting, and electrical components in the interior.

Be careful when you are using the beverage holders. Hot liquid can scald you.

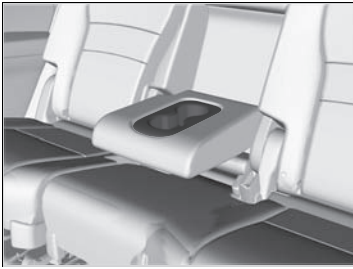

■ **Second row bench seat beverage holders\***

Fold the armrest down to use the rear seat beverage holders.

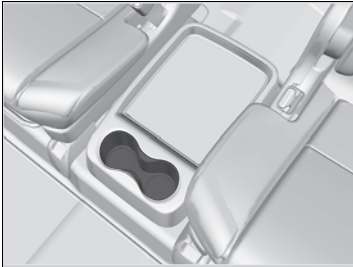

■ **Second row captain seat beverage holders\***



■ **Third row seat beverage holders**

\* Not available on all models

## ■ Accessory Power Sockets

The accessory power sockets can be used when the power mode is in ACCESSORY or ON.

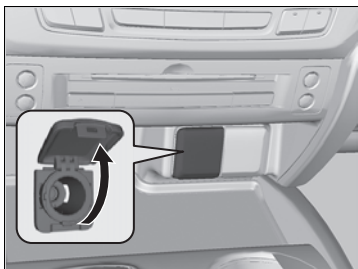

### ■ Accessory power socket (console panel)

Open the lid and the cover to use it.

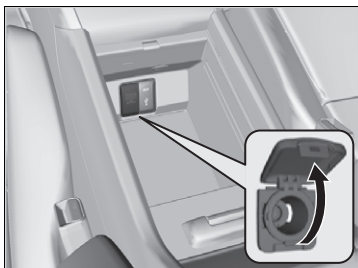

### ■ Accessory power socket (console compartment)

Pull the handle and open the cover to use it.

## ▶▶ Accessory Power Sockets

### NOTICE

Do not insert an automotive type cigarette lighter element.

This can overheat the power socket.

To prevent battery drain, only use the power socket with the engine running.

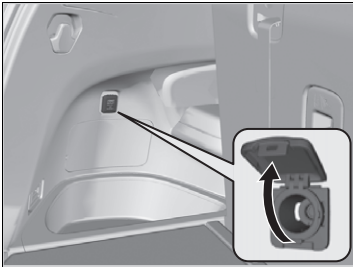

■ **Accessory power socket (cargo area)\***

Open the cover to use it.

■ **AC Power Outlet\***

The AC power outlet can be used when the engine is running.

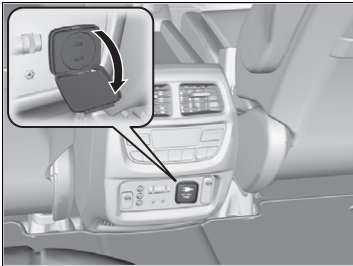

Open the cover to use it. Plug in the appliance slightly, turn it 90° clockwise, then push it all the way.

⌘ AC Power Outlet\*

**NOTICE**

Do not use the AC power outlet for electric appliances that require high initial peak wattage, such as cathode-ray tube type televisions, refrigerators, electric pumps, etc. It is not suitable for devices that process precise data, such as medical equipment, and that require an extremely stable power supply, such as microcomputer-controlled electric blankets, touch sensor lamps, etc.

The AC power outlet is designed to supply power for up to 115 volt appliances that are rated 150 watts or less.

Continued use of any electric appliance/device exceeding these ratings may result in damage to the appliance/device.

\* Not available on all models

## ■ Coat Hooks

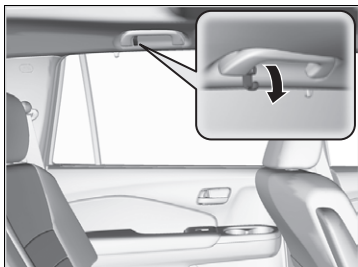

There is a coat hook on the rear grab handle of both sides. Pull it down to use it.

## ▣ Coat Hooks

The coat hooks are not designed for large or heavy items.

## ■ Tie-down Anchors

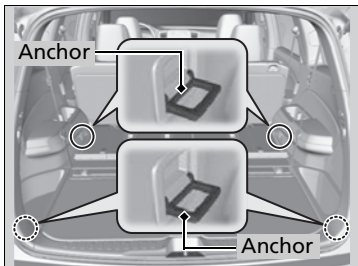

The tie-down anchors on the cargo area floor can be used to install a net for securing items.

## ■ Sunglasses Holder

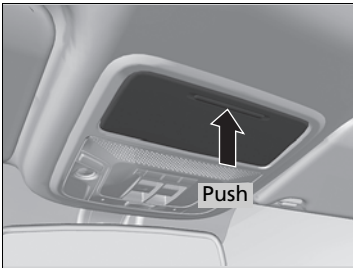

To open the sunglasses holder, push and release the indent. To close, push it again until it latches.

You can store eyeglasses and other small items in this holder.

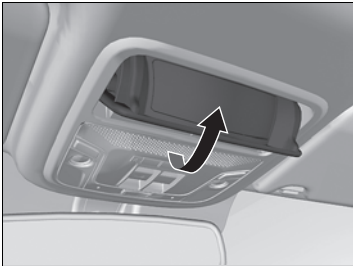

### ■ Conversation mirror\*

The sunglasses holder comes with a mirror. Open the sunglasses holder fully, then push it back to the first detent.

You can use the mirror to view the rear seats.

### ☒ Sunglasses Holder

Keep the holder closed while driving except when accessing stored items.

\* Not available on all models



## ■ Heated Steering Wheel \*

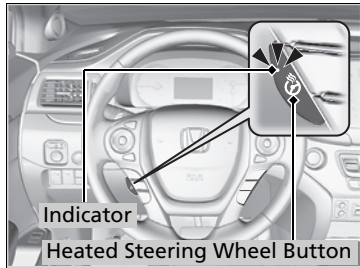

The power mode must be in ON to use the heated steering wheel.

Press the button on the left side of the steering wheel.

When a comfortable temperature is reached, press the button again to turn it off.

The heated steering wheel is turned off every time you start the engine, even if you turned it on the last time you drove the vehicle.

## ▣ Heated Steering Wheel \*

Do not use the heated steering wheel continuously when the engine is off. Under such conditions, the battery may be weakened, making the engine difficult to start.

## ■ Front Seat Heaters\*



The power mode is in ON to use the seat heaters. The **HI** setting heats the seats faster than the **LO** setting.

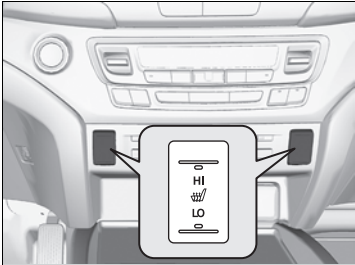

The appropriate indicator will be on while the seat heater is on. Each time you press the switch, the mode changes to **HI**, **LO** and OFF.

## ⊠ Front Seat Heaters\*

### ⚠ WARNING

Heat induced burns are possible when using seat heaters.

Persons with a diminished ability to sense temperature (e.g., persons with diabetes, lower-limb nerve damage, or paralysis) or with sensitive skin should not use seat heaters.

Do not use the seat heaters even in **LO** when the engine is off. Under such conditions, the battery may be weakened, making the engine difficult to start.

In the **LO** setting, the heater runs continuously and does not automatically turn off.

\* Not available on all models

### ■ Front Seat Heaters and Seat Ventilation \*



If the power mode is in ON:

**Seat heater** - The HI setting heats the seats faster than the LO setting.

**Seat ventilation \*** - The HI setting ventilates the seats faster than the LO setting.

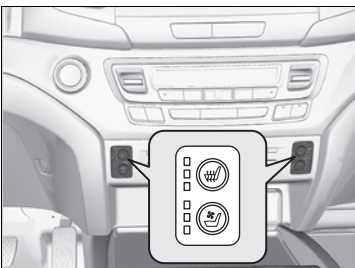

Press the seat heater or the seat ventilation button:

Once - The HI setting (three indicators on)

Twice - The MID setting (two indicators on)

Three times - The LO setting (one indicator on)

Four times - The OFF setting (no indicators on)

When a comfortable temperature is reached while using the seat heaters in HI, select MID or LO to keep the seat warm.

### ▣ Front Seat Heaters and Seat Ventilation \*

## ⚠ WARNING

Heat induced burns are possible when using seat heaters.

Persons with a diminished ability to sense temperature (e.g., persons with diabetes, lower-limb nerve damage, or paralysis) or with sensitive skin should not use seat heaters.

Do not use the seat heaters and the seat ventilation even in LO when the engine is off. Under such conditions, the battery may be weakened, making the engine difficult to start.

## ■ Second Row Outer Seat Heaters\*



The power mode must be in ON to use the seat heaters. The HI setting heats the seats faster than the LO setting.

Press the seat heater button:

- Once - The HI setting (three indicators on)
- Twice - The MID setting (two indicators on)
- Three times - The LO setting (one indicator on)
- Four times - The OFF setting (no indicators on)

## ▣ Second Row Outer Seat Heaters\*

### **⚠ WARNING**

Heat induced burns are possible when using seat heaters.

Persons with a diminished ability to sense temperature (e.g., persons with diabetes, lower-limb nerve damage, or paralysis) or with sensitive skin should not use seat heaters.

Do not use the seat heaters even in LO when the engine is off. Under such conditions, the battery may be weakened, making the engine difficult to start.

\* Not available on all models

### ■ Integrated Sunshades\*

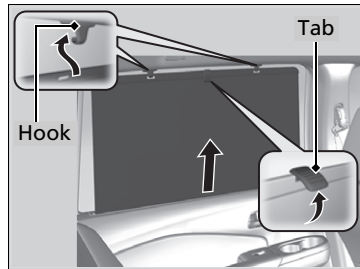

Pull the tab and roll up the sunshade all the way. Use the hooks to hang it.

### ▣ Integrated Sunshades\*

Use the sunshades only when the windows are fully closed. Using the shade while a window is open can unhook and blow off the shade, hitting and hurting anyone sitting near the window.

## Using Vents, Heating and A/C

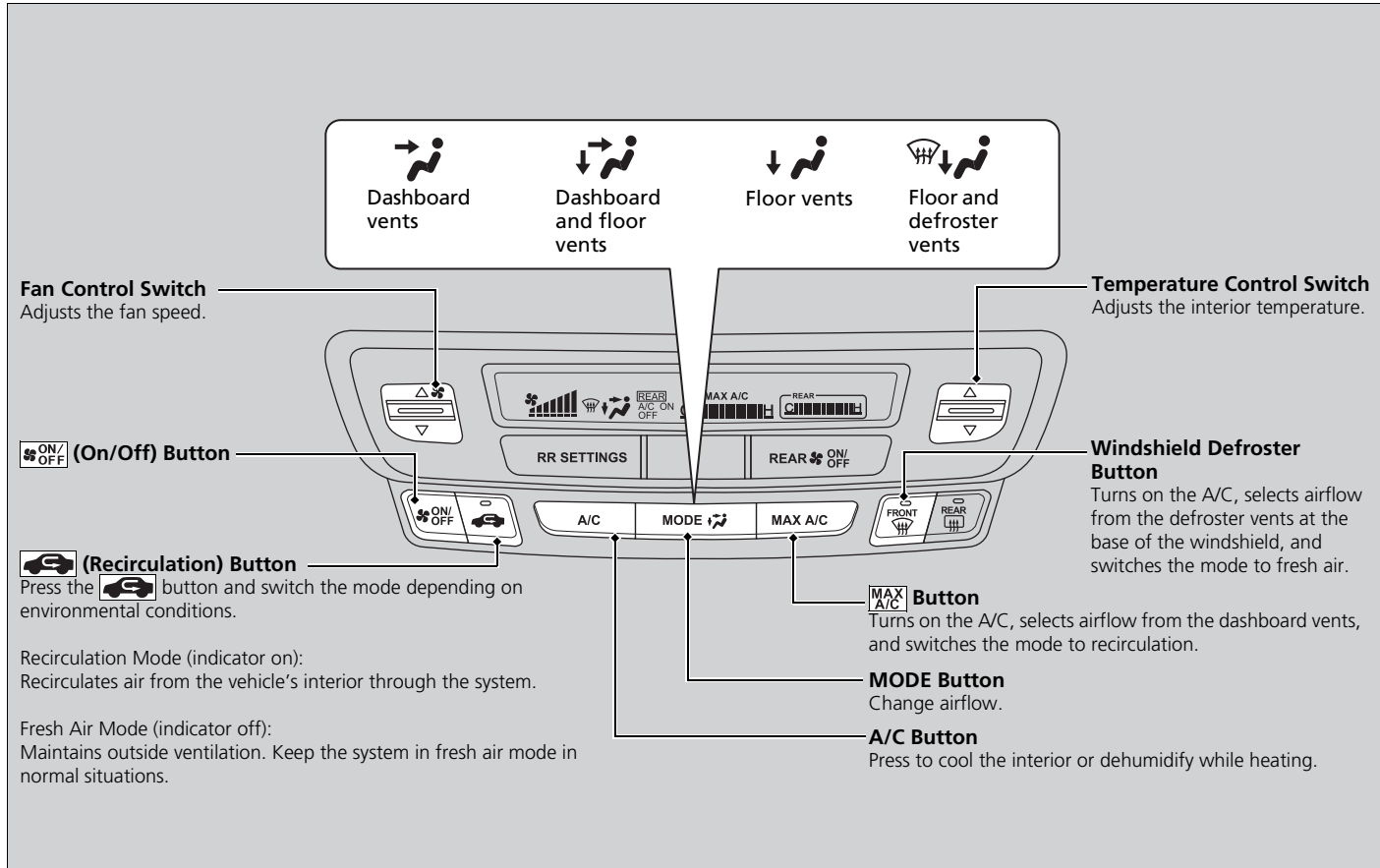

\* Not available on all models

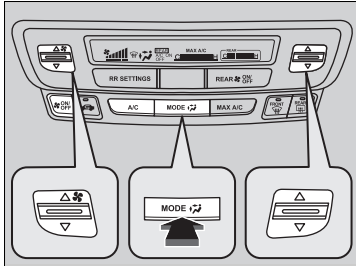

## ■ Heating



The heater uses heat from the engine coolant to warm the air.

1. Adjust the fan speed using the fan control switch.
2. Press the mode button to select .
3. Adjust the temperature using the temperature control switch.

### ■ To rapidly warm up the interior

1. Set the fan to the maximum speed.
2. Select .
3. Set the temperature to maximum heat.
4. Press the  button (indicator on).

### ■ To dehumidify the interior

When used in combination with the heater, the air conditioning system makes the interior warm and dry and can prevent the windows from fogging up.

1. Adjust the fan speed using the fan control switch.
2. Press the **A/C** button to turn on the air conditioning.
3. Select .
4. Adjust the temperature using the temperature control switch.

## ▶▶ Heating

When you select , the mode automatically switches to fresh air.

## ▶▶ To rapidly warm up the interior

Change to fresh air mode as soon as the interior gets warm enough. The windows may fog up if kept in recirculation mode.

## ■ Cooling

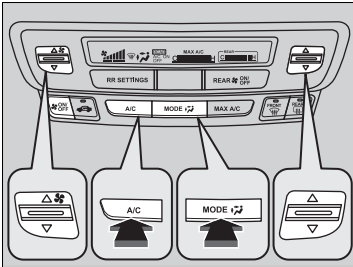

1. Adjust the fan speed using the fan control switch.
2. Press the mode button to select .
3. Adjust the temperature using the temperature control switch.
4. Press the **A/C** button (indicator on).

### ■ To rapidly cool down the interior

1. Set the fan to the maximum speed.
2. Set the temperature to maximum cool.
3. Press the  button (indicator on).

### ☒ To rapidly cool down the interior

If the interior is very warm, you can cool it down more rapidly by partially opening the windows.



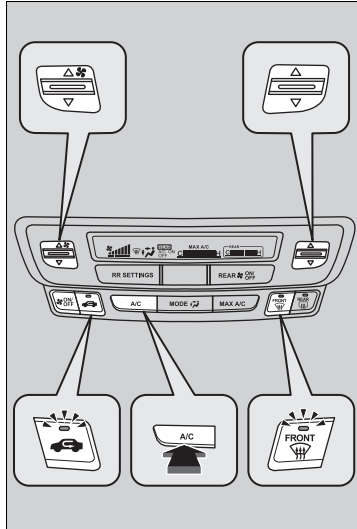

## ■ Defrosting the Windshield and Windows



Pressing the  button turns the air conditioning system on and automatically switches the system to fresh air mode.

### ■ To rapidly defrost the windows

1. Set the fan to the maximum speed.
2. Press the  button.
3. Press the  button.
4. Set the temperature to maximum heat.

## ▶▶ Defrosting the Windshield and Windows

**For your safety, make sure you have a clear view through all the windows before driving.**

Do not set the temperature near the upper or lower limit.

When cold air hits the windshield, the outside of the windshield may fog up.

If the side windows fog up, adjust the vents so that the air hits the side windows.

### ▶▶ To rapidly defrost the windows

After defrosting the windows, switch over to fresh air mode.

If you keep the system in recirculation mode, the windows may fog up from humidity. This impedes visibility.

## ■ Using the Rear Heating and Cooling From the Front Panel

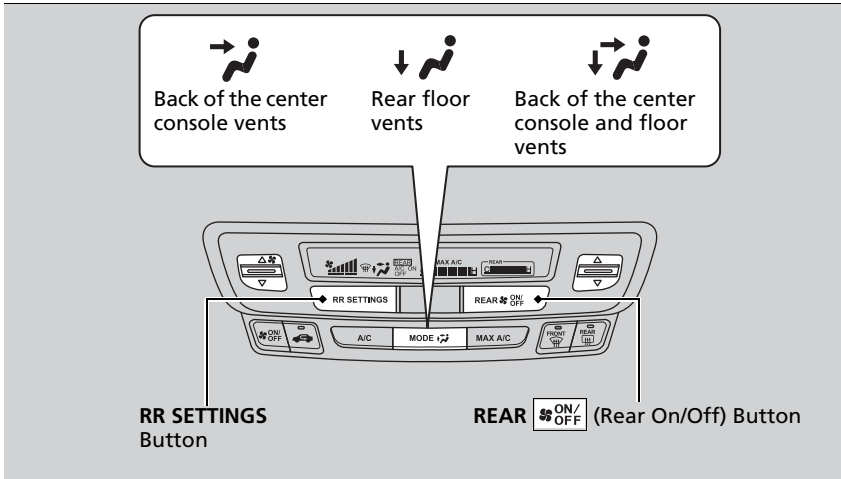

Use the system when the engine is running and the heating and cooling is operating.

1. Press the **REAR** (Rear On/Off) button.
2. Press the **RR SETTINGS** button.
  - The system adjusts the rear heating and cooling system.
3. To turn off the rear heating and cooling system, press the **REAR** (Rear On/Off) button.

## Using Automatic Climate Control

The automatic climate control system maintains the interior temperature you select. The system also selects the proper mix of heated or cooled air that will as quickly as possible, raise or lower the interior temperature to your preference.

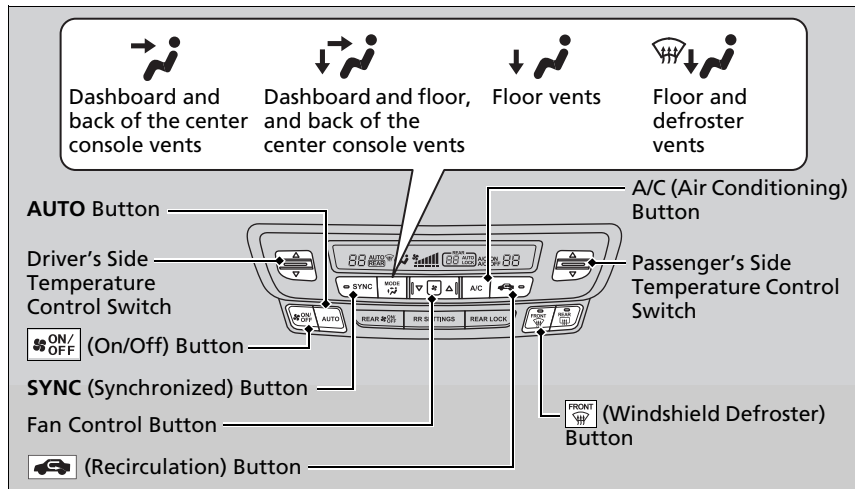

Use the system when the engine is running.

1. Press the **AUTO** button.
2. Adjust the interior temperature using the driver's side or passenger's side temperature control switch.
3. Press the  **ON/OFF** button to cancel.

### Using Automatic Climate Control

If any buttons are pressed while using the climate control system in auto, the function of the button that was pressed will take priority. The **AUTO** indicator will go off, but functions unrelated to the button that was pressed will be controlled automatically.

#### Models with Auto Idle-stop

During the Auto Idle-stop, the air conditioning system will be turned off.

#### All models

To prevent cold air from blowing in from outside, the fan may operate at low speed for a while after the **AUTO** button has been pressed.

Once you have set the desired temperature, do not use the temperature control switches more than necessary. Doing so may delay the time it takes to reach the set temperature.

If the interior is very warm, you can cool it down more rapidly by partially opening the windows, turning the system on auto, and setting the temperature to low. Change the fresh mode to recirculation mode until the temperature cools down.

When you set the temperature to the lower or upper limit, **Lo** or **Hi** is displayed.

Pressing the  **ON/OFF** button switches the climate control system between on and off. When turned on, the system returns to your last selection.

### ■ Switching between the recirculation and fresh air modes

Press the  button and switch the mode depending on environmental conditions. Recirculation Mode (indicator on): Recirculates air from the vehicle's interior through the system.

Fresh Air Mode (indicator off): Maintains outside ventilation. Keep the system in fresh air mode in normal situations.

### ■ Defrosting the Windshield and Windows

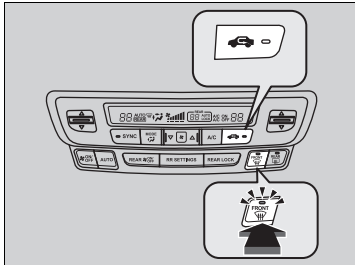

Pressing the  button turns the air conditioner system on and automatically switches the system to fresh air mode.

Press the  button again to turn off, the system returns to the previous settings.

### ☒ Defrosting the Windshield and Windows

**For your safety, make sure you have a clear view through all the windows before driving.**

Do not set the temperature near the upper or lower limit.

When cold air hits the windshield, the outside of the windshield may fog up.

#### Models with Auto Idle-stop

If you press the  button during Auto Idle-stop, the engine restarts automatically.

If the side windows fog up, adjust the vents so that the air hits the side windows.

■ To rapidly defrost the windows

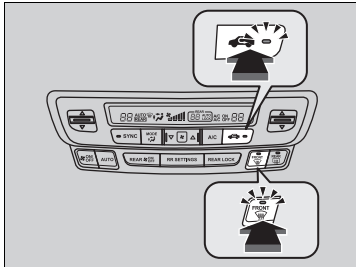

1. Press the  button.
2. Press the  button.

►► To rapidly defrost the windows

After defrosting or defogging the windows, switch over to fresh air mode. If you keep the system in recirculation mode, the windows may fog up from humidity. This impedes visibility.

## Synchronized Mode

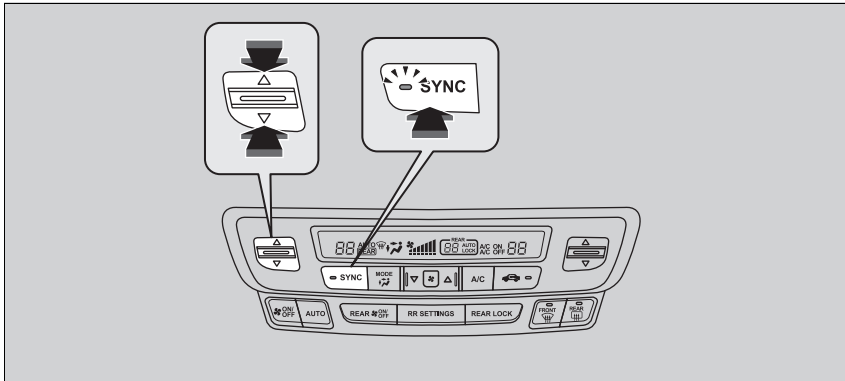

You can set the temperature synchronously for the driver side, front passenger side and rear seats in synchronized mode.

1. Press the **SYNC** button.
  - ▶ The system will switch to synchronized mode.
2. Adjust the temperature using driver's side temperature control switch.

Press the **SYNC** button to return to synchronized mode off.

### ☒ Synchronized Mode

When you press the  button, the system changes to synchronized mode.



When the system is in synchronized mode off, the temperature for the driver, front passenger, and rear seats can be set separately.

## Rear Climate Control System

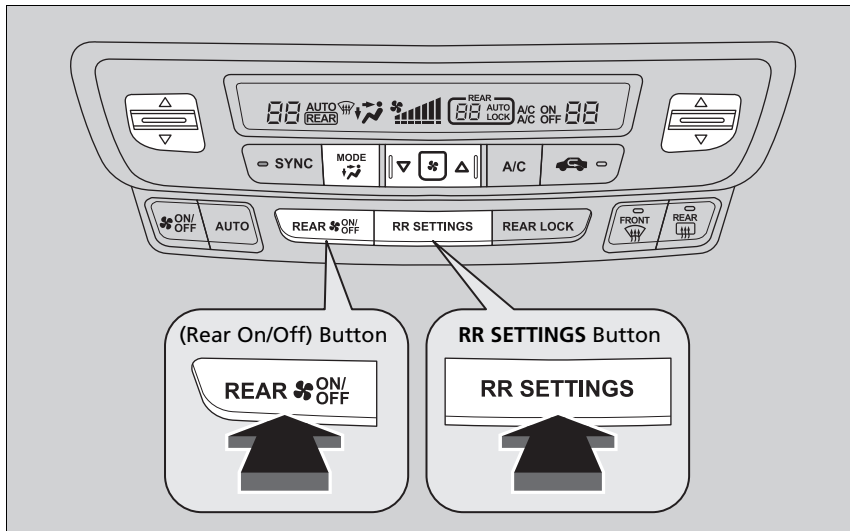
### ■ Using the Rear Climate Control System From the Front Panel



Use the system when the engine is running and the climate control system is operating.

1. Press the **REAR**  (Rear On/Off) button.
2. Press the **RR SETTINGS** button.
  - ▶ The system adjusts the rear climate control system.
3. To turn off the rear climate control system, press the **REAR**  (Rear On/Off) button.

### ▣ Rear Climate Control System

**LOCK** appears on the rear control panel while the rear lock is on.

If the rear lock is on while in SYNC mode, the rear control panel is disabled. **LOCK SYNC** appears on the rear control panel.

### ▣ Using the Rear Climate Control System From the Front Panel

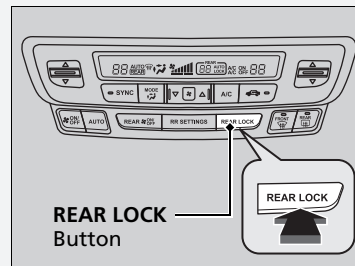

Press the **REAR LOCK** button to turn the rear lock mode on and off.



While the rear lock mode is on, the rear control panel is disabled.

▶ **REAR LOCK** appears on the display.

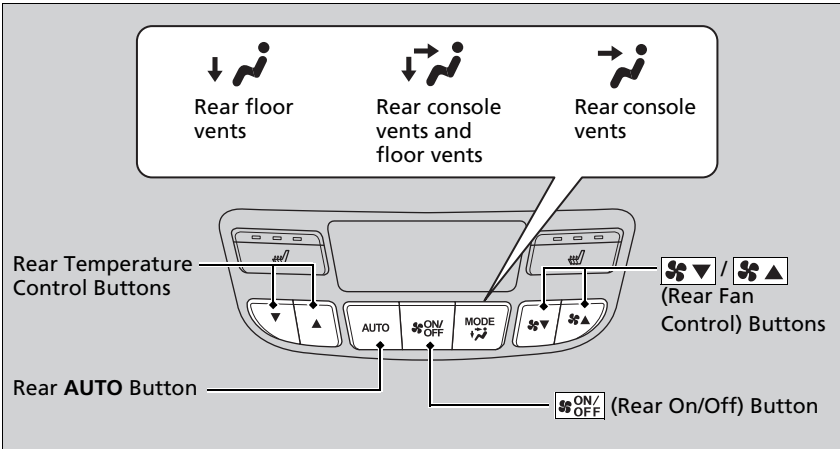
## ■ Using the Rear Climate Control System From the Rear Panel



Use the system when the engine is running and the climate control system is operating.

1. Press the  (Rear On/Off) button.
2. Press the Rear **AUTO** button.
3. Adjust the interior temperature using the rear temperature control button.
4. To turn off the rear climate control system, press the  button.

## ▣ Using the Rear Climate Control System From the Rear Panel

When the **REAR LOCK** button on the front control panel is off, the temperature of the rear passenger compartment can be controlled independently.



## Automatic Climate Control Sensors

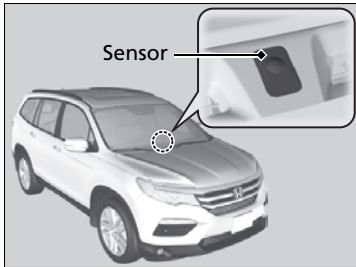

The automatic climate control system is equipped with sensors. Do not cover or spill any liquid on them.

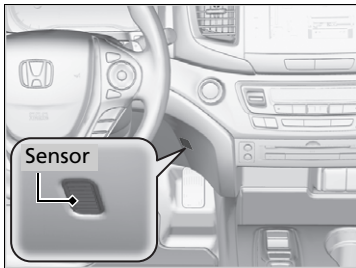

# Features

This chapter describes how to operate technology features.

<b>Audio System</b>	
About Your Audio System .....	218
USB Port(s) .....	219
Auxiliary Input Jack .....	220
Audio System Theft Protection .....	221
Audio Remote Controls .....	222
<b>Models with color audio system</b>	
<b>Audio System Basic Operation</b> .....	224
<b>Models with Display Audio</b>	
<b>Audio System Basic Operation</b> .....	242

<b>Audio Error Messages</b>	
CD Player* .....	310
iPod/USB Flash Drive .....	311
Pandora®* .....	312
Android/Apps* .....	313
<b>General Information on the Audio System</b>	
SiriusXM® Radio Service* .....	314
Recommended CD* .....	315
Compatible iPod, iPhone, and USB Flash Drives .....	317
About Open Source Licenses .....	320

<b>Blu-ray/DVD Rear Entertainment System*</b> .....	322
<b>Customized Features</b> .....	351
<b>HomeLink® Universal Transceiver*</b> ..	387
<b>Models with color audio system</b>	
<b>Bluetooth® HandsFreeLink®</b> .....	390
<b>Models with Display Audio</b>	
<b>Bluetooth® HandsFreeLink®</b> .....	415
<b>Compass*</b>	
Compass Calibration .....	448
Compass Zone Selection .....	449

\* Not available on all models

## About Your Audio System

The audio system features AM/FM radio and SiriusXM® Radio\* service. It can also play audio CDs\*, WMA/MP3/AAC files\*, USB flash drives, and iPod, iPhone and *Bluetooth*® devices.

You can operate the audio system from the buttons and switches on the panel, the remote controls on the steering wheel, or the icons on the touchscreen interface\*.

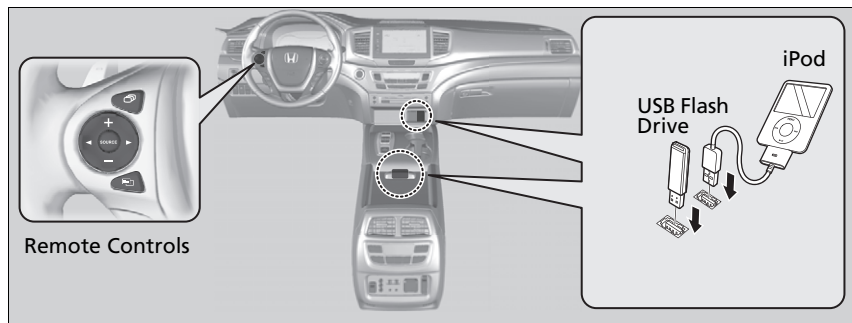

### About Your Audio System

SiriusXM® Radio is available on a subscription basis only. For more information on SiriusXM® Radio, contact a dealer.\*

#### General Information on the Audio System P. 314

SiriusXM® Radio is available in the United States and Canada, except Hawaii, Alaska, and Puerto Rico.\*

SiriusXM® is a registered trademark of SiriusXM Radio, Inc.\*

Video CDs, DVDs\*, and 3-inch (8-cm) mini CDs are not supported.

iPod, iPhone and iTunes are trademarks of Apple Inc.

State or local laws may prohibit the operation of handheld electronic devices while operating a vehicle.

## USB Port(s)

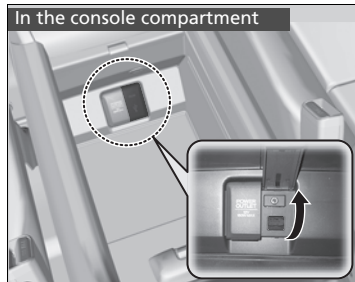
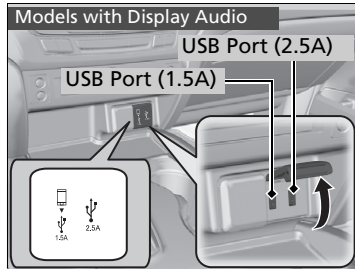

Install the iPod USB connector or the USB flash drive to the USB port.

### ■ On the console panel

- ▶ The USB port (1.5A) is for charging devices, playing audio files and connecting compatible phones with Apple CarPlay™ or Android Auto™.
- ▶ The USB port (2.5A) is for playing audio files on the USB flash drive and charging devices.

### ■ In the console compartment

The USB port is for playing audio files on the USB flash drive and charging devices.

- ▶ 1.5A for models with color audio system
- ▶ 2.5A for models with Display Audio

### ⊞ USB Port(s)

- Do not leave the iPod or USB flash drive in the vehicle. Direct sunlight and high temperatures may damage it.
- We recommend using an extension cable with the USB port.
- Do not connect the iPod or USB flash drive using a hub.
- Do not use a device such as a card reader or hard disk drive, as the device or your files may be damaged.
- We recommend keeping your data backed up before using the device in your vehicle.
- Displayed messages may vary depending on the device model and software version.

If the audio system does not recognize the iPod, try reconnecting it a few times or reboot the device. To reboot, follow the manufacturer's instructions provided with the iPod or visit [www.apple.com/ipod](http://www.apple.com/ipod).

### ■ USB charge

The USB port can supply up to 1.5A/2.5A of power. It does not output 1.5A/2.5A unless the device requests.

For amperage details, read the operating manual of the device that needs to be charged.

Set the power mode to ACCESSORY or ON first.

On the back of the console compartment

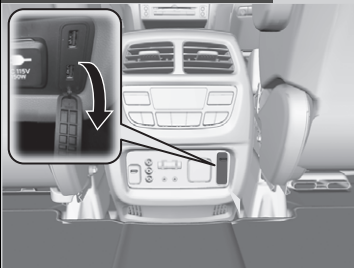

### ■ On the back of the console compartment\*

The USB ports (2.5A) are only for charging devices.

### » USB Port(s)

#### On the back of the console compartment

This port is for battery charge only. You cannot play music even if you have connected a music player to it.

Under certain conditions, a device connected to the port may generate noise in the radio you are listening to.

## Auxiliary Input Jack

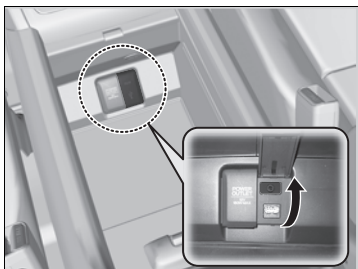

Use the jack to connect devices.

1. Open the cover.
2. Connect a device to the input jack using a 1/8 inch (3.5 mm) stereo miniplug.
  - ▶ The audio system automatically switches to the AUX mode.

### » Auxiliary Input Jack

#### Models with color audio system

You can return to AUX mode by pressing the **MEDIA** button.

#### Models with Display Audio

You can return to AUX mode by selecting **SOURCE** on the audio screen.

You cannot use the auxiliary input jack if you replace the audio system.

## Audio System Theft Protection

The audio system is disabled when it is disconnected from the power source, such as when the battery is disconnected or goes dead. In certain conditions, the system may display a code entry screen. If this occurs, reactivate the audio system.

### ■ Reactivating the audio system

1. Set the power mode to ON.
2. Turn on the audio system.
3. Press and hold the audio system power button for more than two seconds.
  - ▶ The audio system is reactivated when the audio control unit establishes a connection with the vehicle control unit. If the control unit fails to recognize the audio unit, you must go to a dealer and have the audio unit checked.

### ▶▶ Audio System Theft Protection

#### U.S. models

Find the audio system's security code and serial number label in your owner's manual kit.

We recommend that you write down the serial number in this owner's manual.

Do not store the label in your vehicle. If you lose the label, you must first retrieve the serial number, and then obtain the code.

You can find out about your serial number and security code from a dealer.

## Audio Remote Controls

Allow you to operate the audio system while driving.

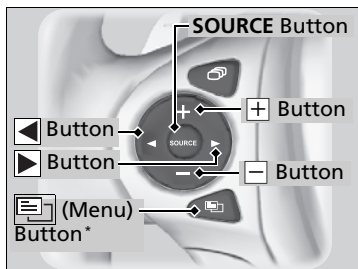

### SOURCE Button

Cycles through the audio modes as follows:

#### Models with color audio system

FM1→FM2→AM→USB/iPod→*Bluetooth*®  
Audio→AUX

#### Models with Display Audio









FM→AM→SiriusXM®→CD\*→USB→iPod→  
Pandora®\*→Apple CarPlay™→Android  
Auto™→*Bluetooth*® Audio→AUX→  
REAR VIDEO\*→REAR HDMI\*→Audio Apps

### + - (Volume) Buttons

**Press** : To increase the volume.

**Press** : To decrease the volume.

### ◀ ▶ Buttons







- When listening to the radio
  - Press** : To select the next preset radio station.
  - Press** : To select the previous preset radio station.
  - Press and hold** : To select the next strong station.
  - Press and hold** : To select the previous strong station.
- When listening to a CD\*, iPod, USB flash drive, or *Bluetooth*® Audio
  - Press** : To skip to the next song.
  - Press** : To go back to the beginning of the current or previous song.
- When listening to a CD (MP3/WMA/AAC)\*, USB flash drive, or *Bluetooth*® Audio
  - Press and hold** : To skip to the next folder.
  - Press and hold** : To go back to the previous folder.

### ▶▶ Audio Remote Controls

Some mode appears only when an appropriate device or medium is used.

Depending on the *Bluetooth*® device you connect, some functions may not be operated.

**Models with Display Audio****Steering Wheel  (Menu) Button**

- When listening to the radio  
**Press :** To display the menu items. You can select **Scan, Save Preset, or Seek.**
- When listening to the HD Radio™\*  
**Press :** To display the menu items. You can select **Scan, Save Preset, or Seek.**
- When listening to the SiriusXM®\*  
**Press :** To display the menu items. You can select **Scan, Save Preset, Channel, or Category.**
- When listening to a CD\* or USB flash drive  
**Press :** To display the menu items. You can select **Scan, Repeat, or Random.**
- When listening to an iPod  
**Press :** To display the menu items. You can select **Repeat or Shuffle.**
- When listening to a *Bluetooth*® Audio  
**Press :** To display the menu items. You can select **Pause or Play.**
- When listening to a Pandora®\*  
**Press :** To display the menu items. You can select **Bookmark, or Play/Pause.**

\* Not available on all models

**▶▶ Audio Remote Controls****Models with Display Audio**

The  button is available only when the audio mode is FM, AM, SiriusXM®\*, CD\*, USB, iPod, Pandora®\*, or *Bluetooth*® Audio.



## Models with color audio system

To use the audio system, the power mode must be in ACCESSORY or ON. Use the selector knob or **MENU/CLOCK** button to access some audio functions.

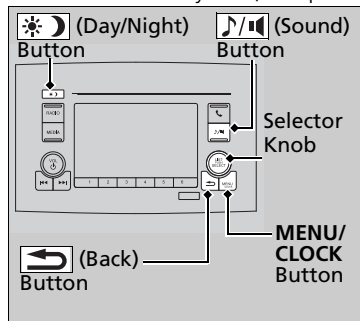

Press  to switch between the normal and extended display for some functions.

**Selector knob:** Rotate left or right to scroll through the available choices. Press  to set your selection.

### MENU/CLOCK button:

Press to select any mode.

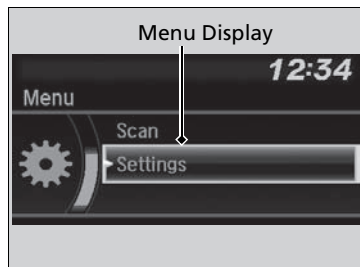

The available mode includes the wallpaper, display, clock, language setup, and play modes. Play modes can be also selected from scan, random, repeat, and so on.



 **(Back) button:** Press to go back to the previous display.

 **(Sound) button:** Press to select the sound setting mode.

 **(Day/Night) button:** Press to change the audio/information screen brightness.

Press the  button, then adjust the brightness using .

- ▶ Each time you press the  button, the mode switches between the daytime mode, nighttime mode and **OFF** mode.

## Audio System Basic Operation

These indications are used to show how to operate the selector knob.

Rotate  to select.

Press  to enter.

### Menu Items

 **Wallpaper Setup** P. 227

 **Display Setup** P. 230

 **Scan** P. 232, 238

 **Play Mode** P. 235, 238

 **RDS Settings** P. 232





One of the operating systems used in this unit is eCos.

For software license terms and condition, visit their website (eCos license URL:

<http://ecos.sourceforge.org/license-overview.html>)

For source code disclosure and other details regarding eCos, visit:

<http://www.hondaopensource2.com>

Press the **SOURCE**, , ,  or  button on the steering wheel to change any audio setting.

 **Audio Remote Controls** P. 222

## Audio/Information Screen

Displays the audio status and wallpaper. From this screen, you can go to various setup options.

### Switching the Display

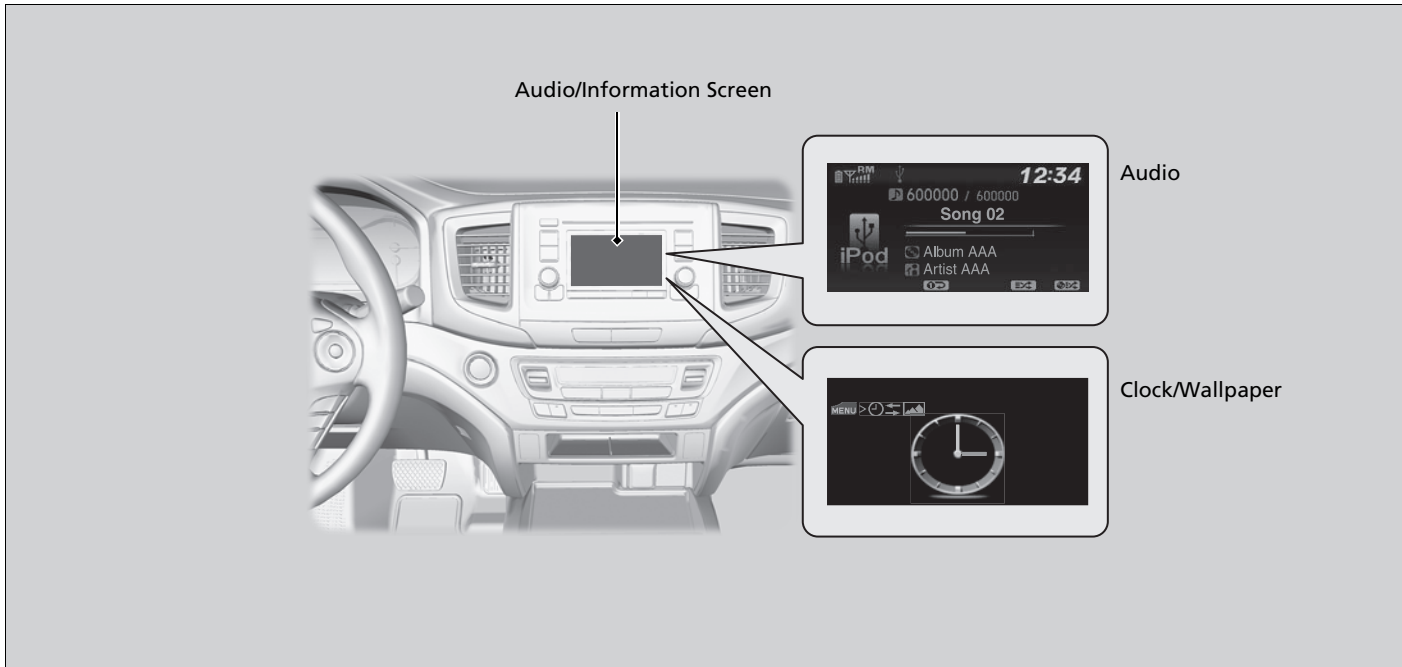







### ■ Audio

Shows the current audio information.

### ■ Clock/Wallpaper

Shows a clock screen or an image you import.

### ■ Change display

1. Press the **MENU/CLOCK** button.
2. Rotate  to select **Settings**, then press .
3. Rotate  to select **Display Change**, then press .
4. Rotate  to select **Wallpaper**, then press .
  - ▶ If you want to return to the audio/information screen, select **Audio**.

## Wallpaper Setup

You can change, store, and delete the wallpaper on the audio/information screen.

### Import wallpaper

You can import up to three images, one at a time, for wallpaper from a USB flash drive.

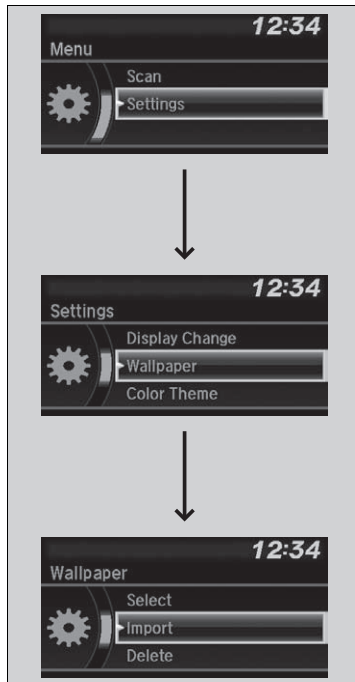









1. Connect the USB flash drive to the USB port.  
▶ **USB Port(s)** P. 219
2. Press the **MENU/CLOCK** button.
3. Rotate to select **Settings**, then press .
4. Rotate to select **Wallpaper**, then press .
5. Rotate to select **Import**, then press .  
▶ The picture name is displayed on the list.
6. Rotate to select a desired picture, then press .  
▶ The selected picture is displayed.
7. Press to save the picture.
8. Press to select **OK**.
9. Rotate to select a location to save the picture, then press .  
▶ The display will return to the wallpaper setting screen.

### Wallpaper Setup









- When importing wallpaper files, the image must be in the USB flash drive's root directory. Images in a folder cannot be imported.
- The file name must be fewer than 64 characters.
- The file format of the image that can be imported is BMP (bmp) or JPEG (jpg).
- The individual file size limit is 2 MB.
- The maximum image size is 1,920 x 936 pixels. If the image size is less than 480 x 234 pixels, the image is displayed in the middle of the screen with the extra area appearing in black.
- Up to 255 files can be selected.
- If the USB flash drive does not have any pictures, the **No files detected** message appears.

Continued











### ■ Select wallpaper

1. Press the **MENU/CLOCK** button.
2. Rotate  to select **Settings**, then press .
3. Rotate  to select **Wallpaper**, then press .
4. Rotate  to select **Select**, then press 
  - ▶ The screen changes to the wallpaper list.
5. Rotate  to select a desired wallpaper, then press .

### ■ To view wallpaper once it is set

1. Press the **MENU/CLOCK** button.
2. Rotate  to select **Settings**, then press .
3. Rotate  to select **Display Change**, then press .
4. Rotate  to select **Wallpaper**, then press 
  - ▶ The screen changes to the wallpaper list.
5. Rotate  to select a wallpaper that you want to set, then press .

### ■ Delete wallpaper

1. Press the **MENU/CLOCK** button.
2. Rotate  to select **Settings**, then press .
3. Rotate  to select **Wallpaper**, then press .
4. Rotate  to select **Delete**, then press 
  - ▶ The screen changes to the wallpaper list.
5. Rotate  to select a wallpaper that you want to delete, then press .
6. Rotate  to select **Yes**, then press 
  - ▶ The display will return to the wallpaper setting screen.



### ▶▶ Wallpaper Setup

To go back to the previous screen, press the  (Back) button.

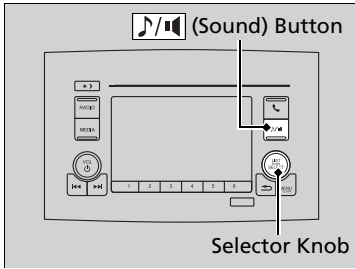

When the file size is large, it takes a while to be previewed.

## Adjusting the Sound

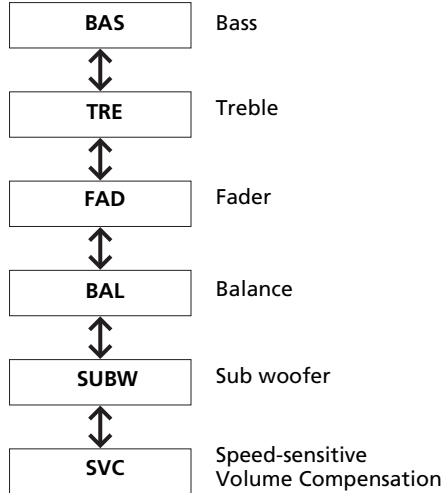
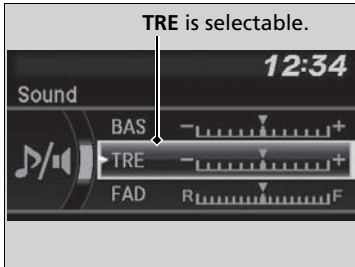

Press the  (sound) button, and rotate  to scroll through the following choices:



Rotate  to adjust the sound setting, then press .

### Adjusting the Sound







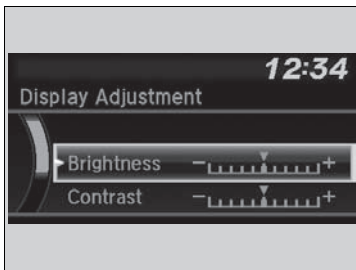

The SVC has four modes: **Off**, **Low**, **Mid**, and **High**. SVC adjusts the volume level based on the vehicle speed. As you go faster, audio volume increases. As you slow down, audio volume decreases.

## Display Setup

You can change the brightness or color theme of the audio/information screen.







### ■ Changing the Screen Brightness

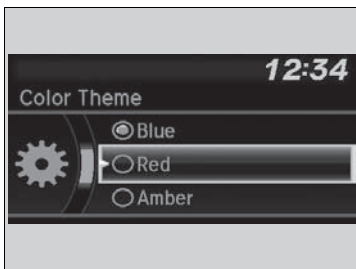

1. Press the **MENU/CLOCK** button.
2. Rotate  to select **Settings**, then press .
3. Rotate  to select **Display Adjustment**, then press .
4. Rotate  to select **Brightness**, then press .
5. Rotate  to adjust the setting, then press .

### ■ Changing the Screen's Color Theme



1. Press the **MENU/CLOCK** button.
2. Rotate  to select **Settings**, then press .
3. Rotate  to select **Color Theme**, then press .
4. Rotate  to select the setting you want, then press .

### ☒ Changing the Screen Brightness

You can change the **Contrast** and **Black Level** settings in the same manner.

## Playing AM/FM Radio

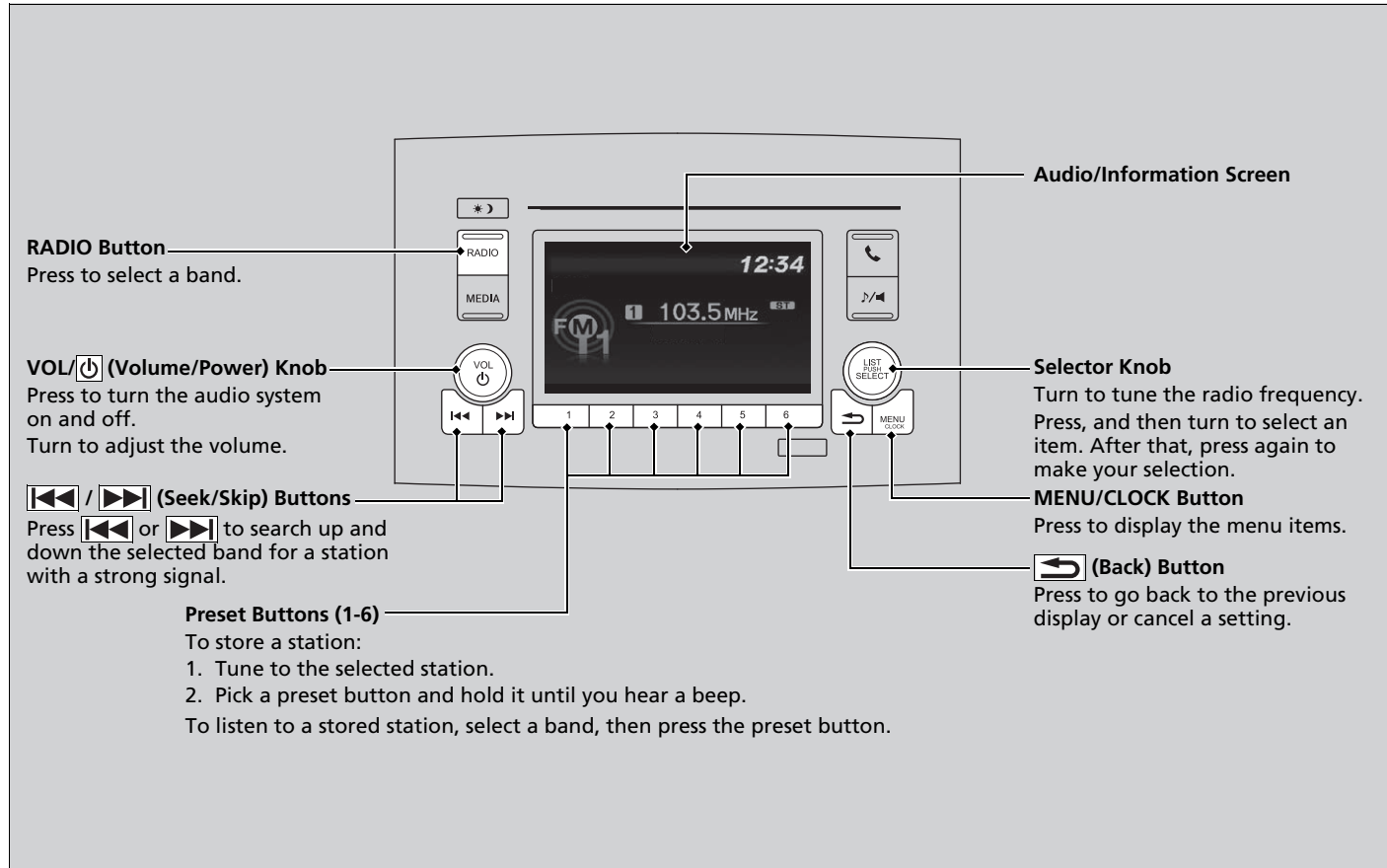





## ■ Radio Data System (RDS)

Provides text data information related to your selected RDS capable FM station.

### ■ To find an RDS station from Station List

1. Press  while listening to an FM station.
2. Rotate  to select the station, then press .

### ■ Update List

Updates your available station list at any time.

1. Press  while listening to an FM station.
2. Rotate  to select **Update List**, then press .

### ■ Radio text

Displays the radio text information of the selected RDS station.

1. Press the **MENU/CLOCK** button.
2. Rotate  to select **Settings**, then press .
3. Rotate  to select **RDS Settings**, then press .
4. Rotate  to select **Radio Text**, then press .

### ■ Scan

Samples each of the strongest stations on the selected band for 10 seconds.

1. Press the **MENU/CLOCK** button.
2. Rotate  to select **Scan**, then press .

To turn off scan, press .

## ▶▶ Playing AM/FM Radio

The **ST** indicator appears on the display indicating stereo FM broadcasts. Stereo reproduction in AM is not available.

You can store 6 AM stations and 12 FM stations into reset button memory. FM1 and FM2 let you store 6 stations each.

Switching the Audio Mode  
Press the **SOURCE** button on the steering wheel.

▶ **Audio Remote Controls** P. 222

## ▶▶ Radio Data System (RDS)

When you select an RDS-capable FM station, the RDS automatically turns on, and the frequency display changes to the station name. However, when the signals of that station become weak, the display changes from the station name to the frequency.

## Playing an iPod

Connect the iPod using your USB connector to the USB port, then press the **MEDIA** button.

➤ **USB Port(s)** P. 219

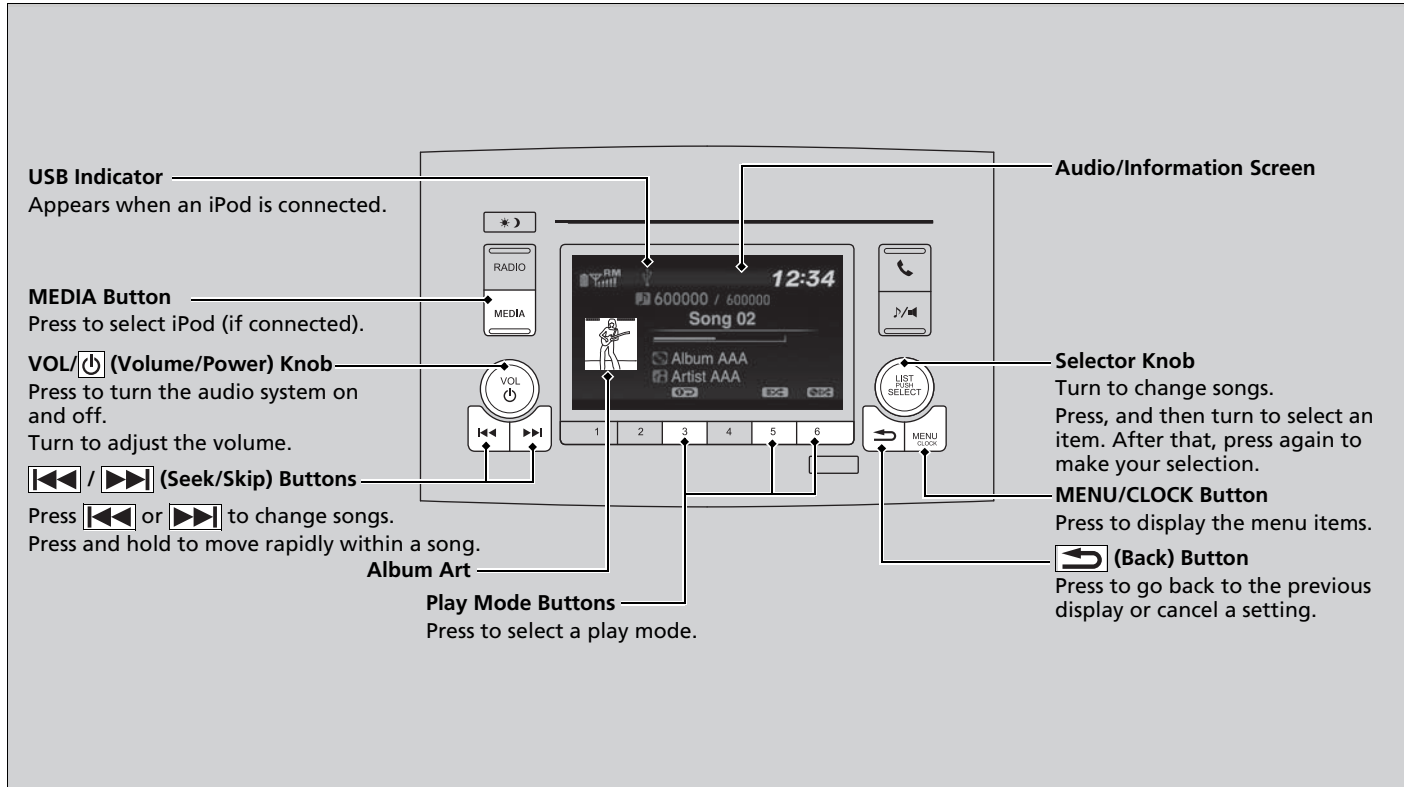

## How to Select a Song from the iPod Music List with the Selector Knob

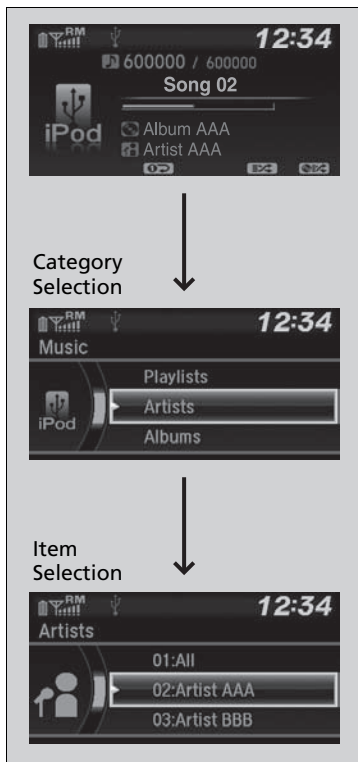

1. Press to display the iPod music list.

2. Rotate to select a category.

3. Press to display a list of items in the category.

4. Rotate to select an item, then press .

- ▶ Press and rotate repeatedly until a desired item you want to listen is displayed.

### ▶▶ Playing an iPod

Available operating functions vary on models or versions. Some functions may not be available on the vehicle's audio system.

If there is a problem, you may see an error message on the audio/information screen.

**iPod/USB Flash Drive** P. 311

## How to Select a Play Mode

You can select repeat and shuffle modes when playing a song.

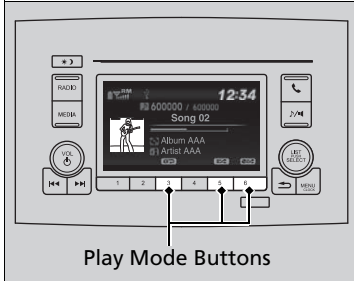

Available mode icons appear above the play mode buttons.

Press the button corresponding to the mode you want to select.

### To turn off a play mode

Press the selected button.

## How to Select a Play Mode

Play Mode Menu Items



 **Shuffle Albums:** Plays all available albums in a selected category (playlists, artists, albums, songs, genres, or composers) in random order.



 **Shuffle:** Plays all available songs in a selected category (playlists, artists, albums, songs, genres, or composers) in random order.

 **Repeat One Track:** Repeats the current song.

You can also select a play mode by pressing the **MENU/CLOCK** button.

Rotate  to select **Play Mode**, then press .

Rotate  to select a mode, then press .

To turn it off, rotate  to select **Normal Play**, then press .

## Playing a USB Flash Drive

Your audio system reads and plays sound files on a USB flash drive in either MP3, WMA or AAC\*1 format.

Connect your USB flash drive to the USB port, then press the **MEDIA** button.

➤ **USB Port(s)** P. 219

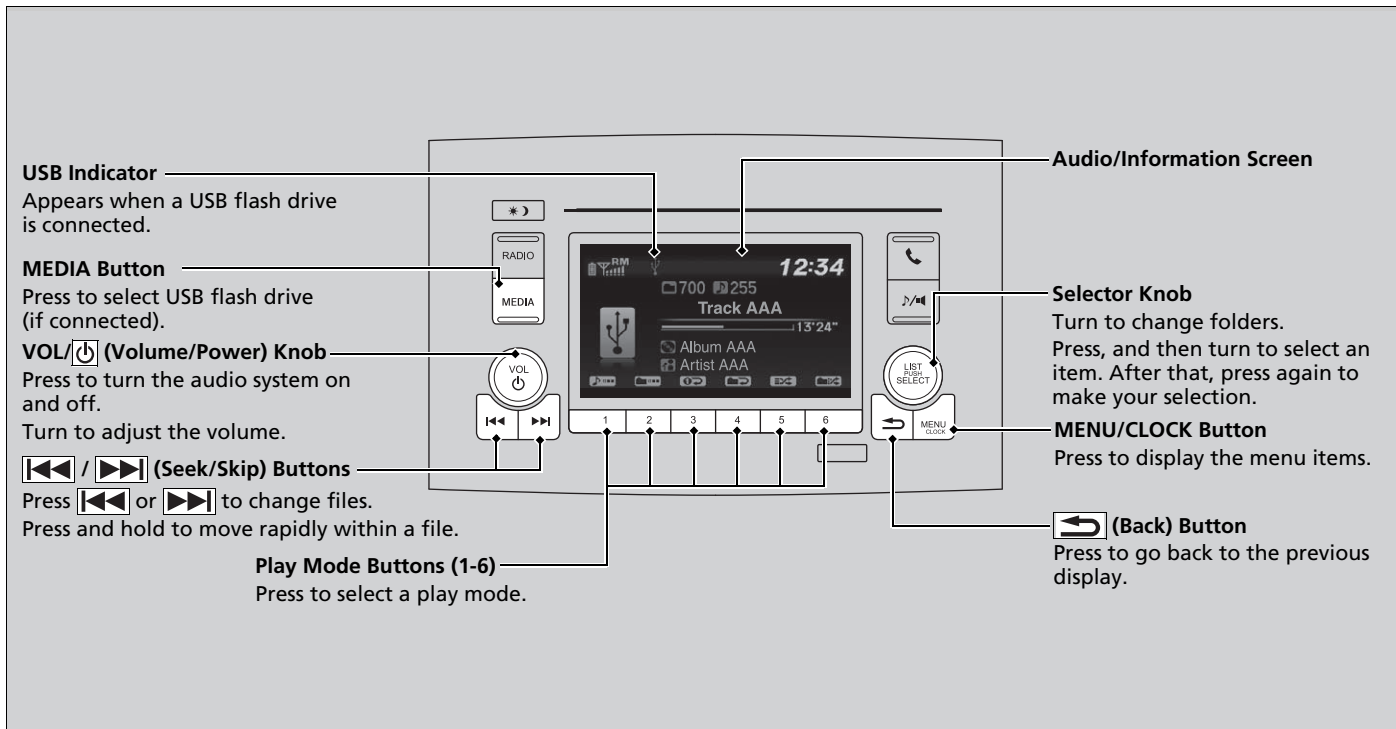

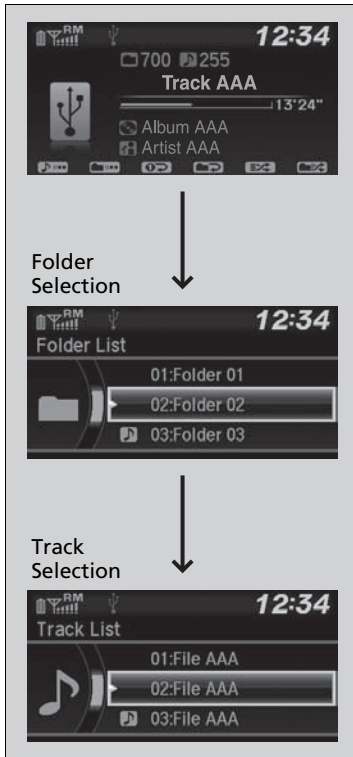

\*1: Only AAC format files recorded with iTunes are playable on this unit.

## How to Select a File from a Folder with the Selector Knob



1. Press  to display a folder list.

2. Rotate  to select a folder.

3. Press  to display a list of files in that folder.

4. Rotate  to select a file, then press .

### ▶▶▶ Playing a USB Flash Drive

Use the recommended USB flash drives.

▶ **General Information on the Audio System**  
P. 314

Files in WMA format protected by digital rights management (DRM) are not played.

The audio system displays **Unplayable File**, and then skips to the next file.

If there is a problem, you may see an error message on the audio/information screen.

▶ **iPod/USB Flash Drive** P. 311

## ■ How to Select a Play Mode

You can select repeat, random, and scan modes when playing a file.

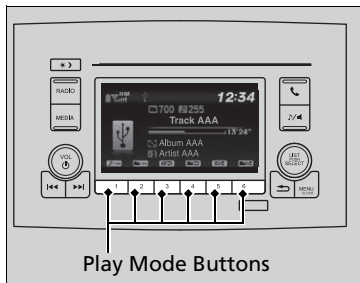

Available mode icons appear above the play mode buttons.

Press the button corresponding to the mode you want to select.

### ■ To turn off a play mode

Press the selected button.

## ▶▶ How to Select a Play Mode

Play Mode Menu Items

### Repeat

 **Repeat One Folder:** Repeats all files in the current folder.

 **Repeat One Track:** Repeats the current file.

### Random

 **Random in Folder:** Plays all files in the current folder in random order.

 **Random All:** Plays all files in random order.



### Scan



 **Scan Folders:** Provides 10-second sampling of the first file in each of the main folders.

 **Scan Tracks:** Provides 10-second sampling of all files in the current folder.

You can also select a play mode by pressing the **MENU/CLOCK** button.

Rotate  to select **Play Mode**, then press .

Rotate  to select a mode, then press .

To turn it off, rotate  to select **Normal Play**, then press .

## Playing *Bluetooth*® Audio

Your audio system allows you to listen to music from your *Bluetooth*-compatible phone.

This function is available when the phone is paired and connected to the vehicle's *Bluetooth*® HandsFreeLink® (HFL) system.

☑ **Phone Setup** P. 396

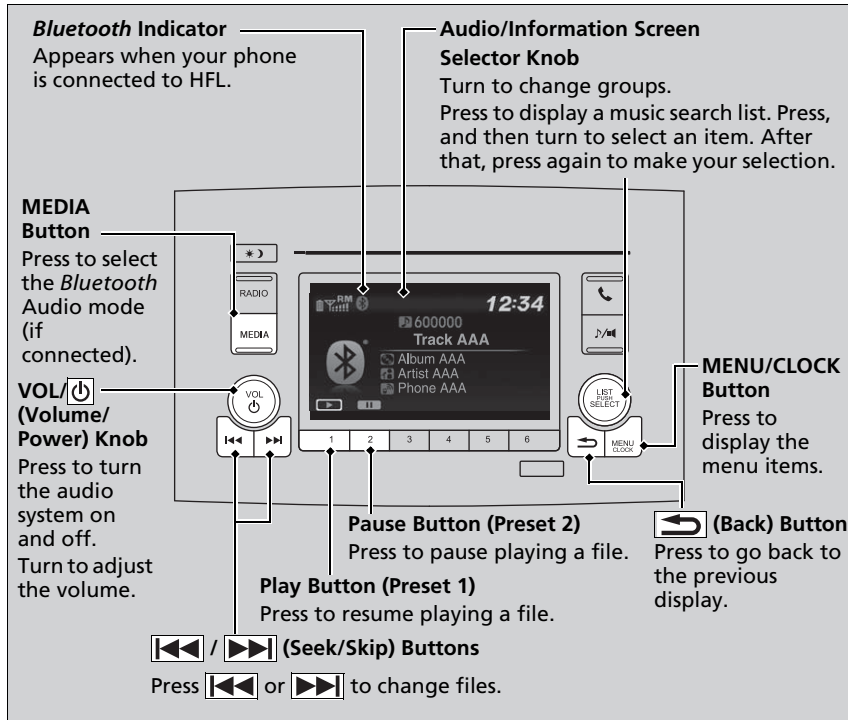

### ▶▶ Playing *Bluetooth*® Audio

Not all *Bluetooth*-enabled phones with streaming audio capabilities are compatible with the system. For a list of compatible phones, visit [www.handsfreelink.honda.com](http://www.handsfreelink.honda.com), or call 1-888-528-7876.

In some states, it may be illegal to perform some data device functions while driving.

Only one phone can be used with HFL at a time. When there are more than two paired phones in the vehicle, the first paired phone the system finds is automatically connected.

If more than one phone is paired to the HFL system, there may be a delay before the system begins to play.

In some cases, the name of the artist, album, or track may not appear correctly.

Some functions may not be available on some devices.

Continued



## ■ To Play *Bluetooth*® Audio Files

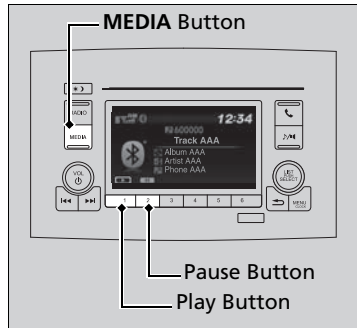

1. Make sure that your phone is paired and connected to HFL.
2. Press the **MEDIA** button until the *Bluetooth*® Audio mode is selected.

If the phone is not recognized, another HFL-compatible phone, which is not compatible for *Bluetooth*® Audio, may already be connected.

## ■ To pause or resume a file

Press a **Play** or **Pause** button to select a mode.

## ▶▶ To Play *Bluetooth*® Audio Files

To play the audio files, you may need to operate your phone. If so, follow the phone maker's operating instructions.

The pause function may not be available on some phones.

If any audio device is connected to the auxiliary input jack or USB port, you may need to press the **MEDIA** button repeatedly to select the *Bluetooth*® Audio system.

Switching to another mode pauses the music playing from your phone.

## How to Select a Song from the Music Search List with the Selector Knob

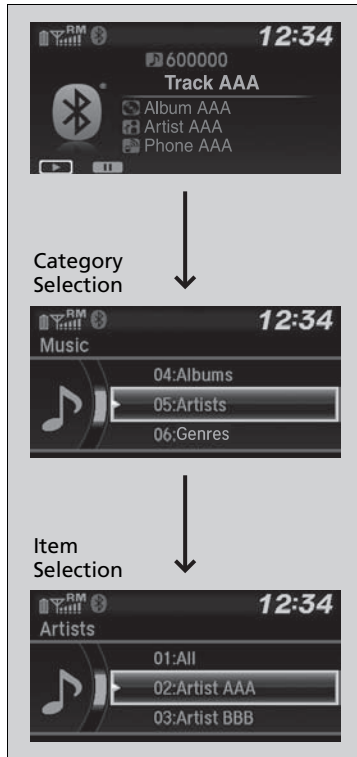

1. Press to display the music search list.
2. Rotate to select a category.
3. Press to display a list of items in the category.
4. Rotate to select an item, then press .
  - ▶ Press and rotate repeatedly until a desired item you want to listen is displayed.

### How to Select a Song from the Music Search List with the Selector Knob

Depending on the *Bluetooth*® device you connect, some or all of the categories may not be displayed.

## Models with Display Audio

To use the audio system function, the power mode must be in ACCESSORY or ON.

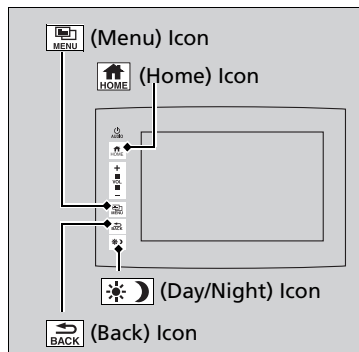



 : Select to go to the home screen.



 **Switching the Display** P. 243

 (Menu): Select to display any mode.

The available mode includes **Sound, View Radio Text, Music Search**, and play modes.

 (Back): Select to go back to the previous display when it is displayed.

 (Day/Night): Select to change the audio/information screen brightness.

Select  once and select  or  to make an adjustment.

- ▶ Each time you select , the mode switches among the daytime mode, nighttime mode and off mode.

## Audio System Basic Operation

### Audio Menu Items

 **Station List** P. 268, 269

 **Music Search List** P. 279, 282, 291

 **Scan** P. 268, 270, 277, 280, 292

 **Play Mode** P. 280, 283, 292

## Audio/Information Screen

Displays the audio status and wallpaper. From this display, you can go to various setup options.

### ■ Switching the Display

#### ■ Using the (display) button

Press the  (display) button to change the display.

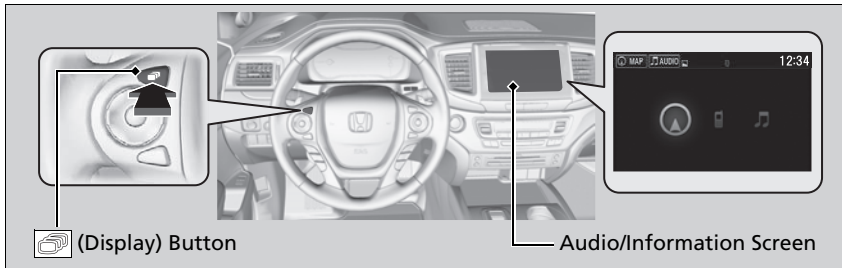

## ■ Using the audio/information screen

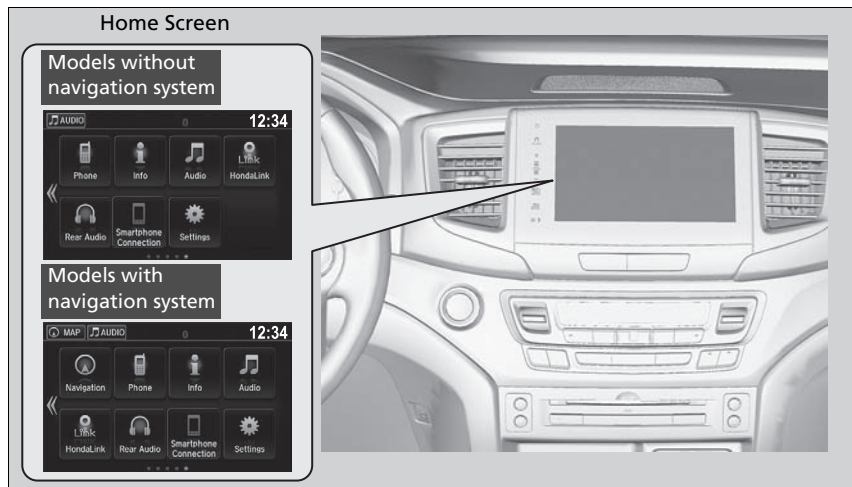

Select  to go to the home screen.

Select **Phone**, **Info**, **Audio**, **Settings**, **Navigation\***, **HondaLink**, **Smartphone Connection** (**Apple CarPlay**, **Android Auto**), or **Rear Audio\***.

### ■ Phone

Displays the HFL information.

➔ **Bluetooth® HandsFreeLink®** P. 415

## ▶▶ Using the audio/information screen

### Touchscreen Operation

- Use simple gestures - including touching, swiping, and scrolling - to operate certain audio functions.
- Some items may be grayed out during driving to reduce the potential for distraction.
- You can select them when the vehicle is stopped or use voice commands.
- Wearing gloves may limit or prevent touchscreen response.
- You can use the microfiber cleaning cloth included in your owner's kit to remove dust or fingerprints from the touchscreen.

You can change the touchscreen sensitivity setting.

➔ **Customized Features** P. 351

## ■ Info

Displays **Trip Computer** or **Clock/Wallpaper**. To see all available information, **Trip Computer**, **Voice Info**, **Clock/Wallpaper**, or **System/Device Information**, select



on the **Info Menu** screen.

### **Trip Computer:**

- **Current Drive** tab: Displays the current trip information.
- **History of Trip A** tab: Displays information for the three previous drives. The information is stored every time you reset Trip A.  
To delete the history manually, select **Delete History** on the **History of Trip A** tab. The confirmation message appears on the screen, then select **Yes**.

**Voice Info:** Displays the All Commands list.

**Clock/Wallpaper:** Displays the clock and wallpaper.

### **System/Device Information:**

- **System Info:** Displays the software version of the audio system.
- **USB Info:** Displays the memory usage of the USB device.

## ■ Audio

Displays the current audio information.

## ■ Settings

Enters the customizing menu screen.

➤ **Customized Features** P. 358

## ■ Navigation\*

Displays the navigation screen.

➤ **Refer to the Navigation System Manual**

\* Not available on all models

## ■ **HondaLink**

Connects with your smartphone\*1 to play personalized music, information, and social media streams.

➤ **HondaLink**® P. 295

## ■ **Smartphone Connection**

Displays **Apple CarPlay** or **Android Auto**.

➤ **Apple CarPlay**™ P. 303

➤ **Android Auto**™ P. 306

## ■ **Rear Audio\***

Displays the rear audio screen.

➤ **Blu-ray/DVD Rear Entertainment System\*** P. 322

\*1: Available on specific phones only. Check [handsfreelink.honda.com](http://handsfreelink.honda.com) for U.S. and [www.handsfreelink.ca](http://www.handsfreelink.ca) for Canada for compatible phones and [hondalink.com](http://hondalink.com) for U.S. and [honda.ca/hondalink](http://honda.ca/hondalink) for Canada for feature details.

\* Not available on all models

## Changing the Home Screen Icon Layout



1. Select .
2. Select and hold an icon.
  - ▶ The screen switches to the customization screen.
3. Drag and drop the icon to where you want it to be.
4. Select **OK**.
  - ▶ The screen will return to the home screen.

## Changing the Home Screen Icon Layout

It is not possible to change the position of the  icon.



## Wallpaper Setup

You can change, store, and delete the wallpaper on the audio/information screen.

### Import wallpaper

You can import up to five images, one at a time, for wallpaper from a USB flash drive.

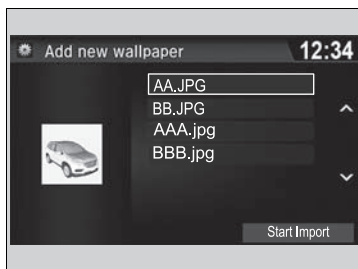
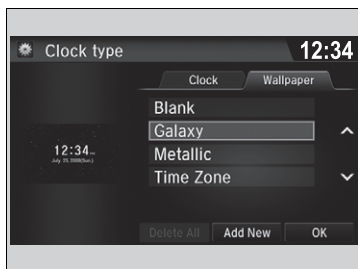

1. Connect the USB flash drive to the USB port.  
 ▶ **USB Port(s)** P. 219
2. Select **Settings**.
3. Select **Clock/Info**.
4. Select **Clock/Wallpaper Type**, then open the **Wallpaper** tab.
5. Select **Add New**.  
 ▶ The picture name is displayed on the list.
6. Select a desired picture.  
 ▶ The preview is displayed on the left side on the screen.
7. Select **Start Import** to save the data.  
 ▶ The display will return to the wallpaper list.

### Wallpaper Setup

The wallpaper you set up on **Clock/Wallpaper Type** cannot be displayed on the multi-information display.

- When importing wallpaper files, the image must be in the USB flash drive's root directory. Images in a folder cannot be imported.
- The file name must be fewer than 64 characters.
- The file format of the image that can be imported is BMP (bmp) or JPEG (jpg).
- The individual file size limit is 5 MB.
- The maximum image size is 4,096 × 4,096 pixels. If the image size is less than 800 × 480 pixels, the image is displayed in the middle of the screen with the extra area appearing in black.
- If the USB flash drive does not have any pictures, the **No files detected** message appears.

## ■ Select wallpaper

1. Select **Settings**.
2. Select **Clock/Info**.
3. Select **Clock/Wallpaper Type**, then open the **Wallpaper** tab.
  - ▶ The screen changes to the wallpaper list.
4. Select a desired wallpaper.
  - ▶ The preview is displayed on the left side on the screen.
  - ▶ The pop-up menu appears on the screen.
5. Select **Set**.
  - ▶ The display will return to the wallpaper list.

## ■ To view wallpaper once it is set

1. Select .
2. Select **Info**.
3. Select .
4. Select **Clock/Wallpaper**.

## ■ Delete wallpaper

1. Select **Settings**.
2. Select **Clock/Info**.
3. Select **Clock/Wallpaper Type**, then open the **Wallpaper** tab.
  - ▶ The screen changes to the wallpaper list.
4. Select a wallpaper that you want to delete.
  - ▶ The preview is displayed on the left side on the screen.
  - ▶ The pop-up menu appears on the screen.
5. Select **Delete**.
  - ▶ A confirmation message appears on the screen.
6. Select **Yes** to delete completely.
  - ▶ The display will return to the wallpaper list.

## Wallpaper Setup

From the pop-up menu, select **Preview** to see a preview at full-size screen.

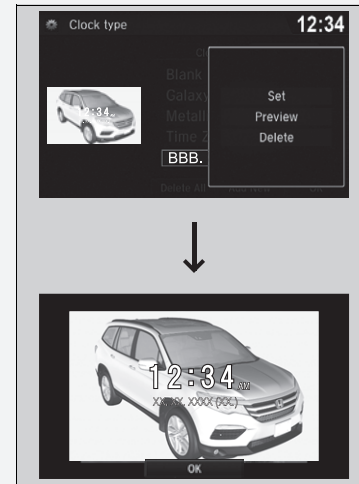

To go back to the previous screen, select **OK**, or select .



When the file size is large, it takes a while to be previewed.

To delete all wallpapers you add, select **Delete All**, then **Yes**.

## ■ Home Screen

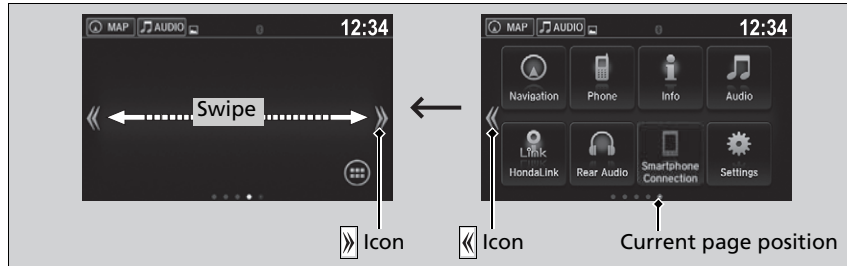
### ■ To change to a next screen







Selecting  or , or swiping the screen left or right changes to the next screen.

## ▶▶ Home Screen

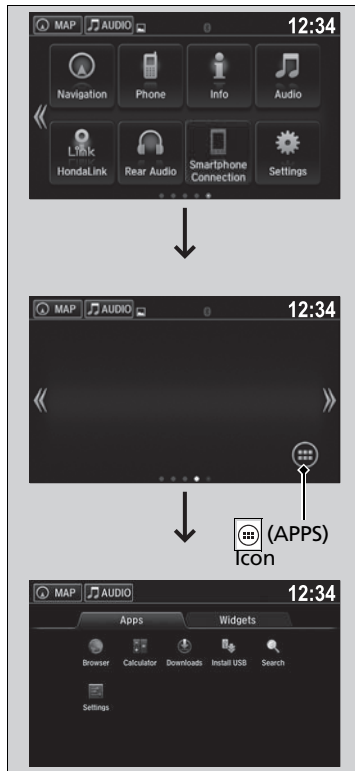
The home screen has 5 pages (fixed). You cannot add any more pages.

## ■ To use apps or widgets



1. Select .
2. Select .
3. Select .
  - ▶ The **APPS** screen appears.
4. Select the app or widget you want to use.

Preinstall app list:

- **Browser:** Displays the web browser utilized by smartphone and Wi-Fi connection.
- **Calculator:** Displays Calculator.
- **Downloads:** Displays the data downloaded from the web browser and so on.
- **Install USB:** Installs and updates app stored in the USB flash drive.
- **Search:** Displays various retrieval screens.
- **Settings:** Displays the Android setting screen.

### ☒ To use apps or widgets

Select and hold a selected app or widget to add that app's or widget's shortcut on the home screen.

Pre-installed apps may not start up normally. If this occurs, you need to reset the system.

☒ **Defaulting All the Settings** P. 386

If you perform **Factory Data Reset**, it may reset all the settings to their factory default.

☒ **Defaulting All the Settings** P. 386

In case those apps still do not startup normally even after **Factory Data Reset**, contact your dealer.

There is a possibility that a browser is shut down in the situation of the use. In that situation, the screen will return to before the browser startup.

You can delete user installed apps by the following procedure.



1. Select .
2. Select **Settings**.
3. Select **System**.
4. Select the **Others** tab.
5. Select **Detail Information**.
6. Select an App that you want to delete.
7. Select **Delete**.

Pre-installed apps cannot be deleted.

### ■ To add app or widget icons on the home screen

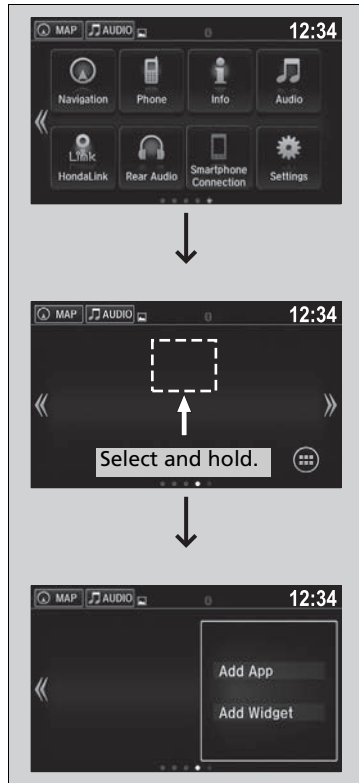
App or widget icons can be added on the home screen.



1. Select .
2. Select .
3. Select and hold empty space on the home screen.
  - ▶ The pop-up menu appears on the screen.
4. Select **Add App** or **Add Widget**.
  - ▶ The apps/widget screen appears.

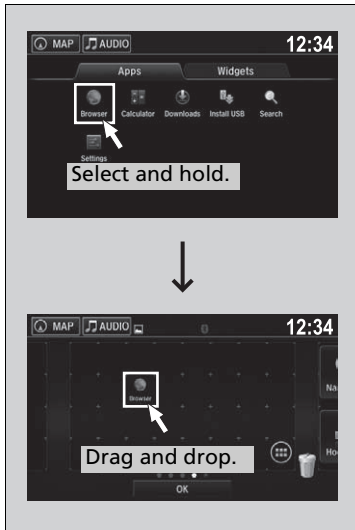

5. Select and hold an app or widget icon you want to add.
  - ▶ The screen switches to the customization screen.
6. Drag and drop the icon to where you want it to be.
7. Select **OK**.
  - ▶ The screen will return to the home screen.

### ■ To move icons on the home screen

You can change location on the home screen.

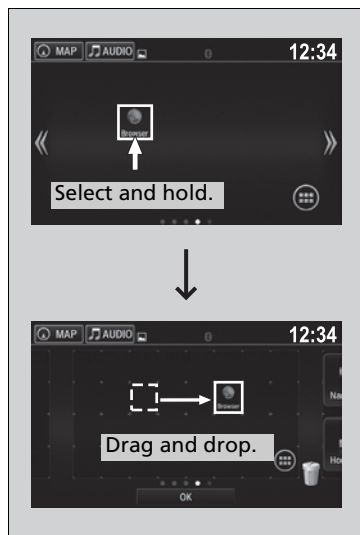

1. Select and hold an icon.
  - ▶ The screen switches to the customization screen.
2. Drag and drop the icon to where you want it to be.
3. Select **OK**.
  - ▶ The screen will return to the home screen.

### ▶▶ To move icons on the home screen

You can also move the **Phone, Info, Audio, Settings, Navigation\***, **HondaLink, Smartphone Connection**, and **Rear Audio\*** icons in the same manner.

## ■ To remove icons on the home screen

You can delete the icons on the home screen.

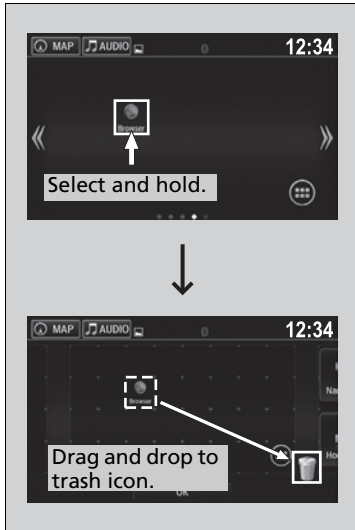

1. Select and hold an icon.
  - ▶ The screen switches to the customization screen.
2. Drag and drop the icon you want to remove to the trash icon.
  - ▶ The icon is removed from the home screen.
3. Select **OK**.
  - ▶ The screen will return to the home screen.

### ☒ To remove icons on the home screen



You cannot delete the **Phone, Info, Audio, Settings, Navigation\***, **HondaLink, Smartphone Connection**, and **Rear Audio\*** icons.

Apps or widgets will not be deleted by deleting the icon on the home screen.

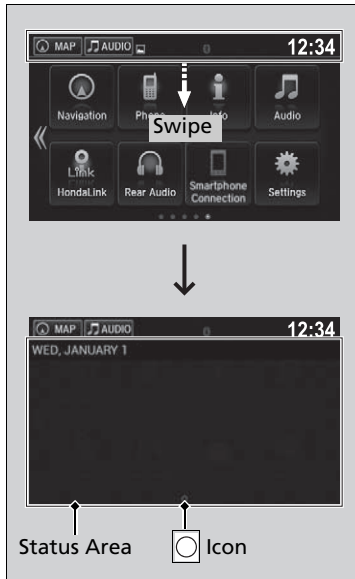

## Status Area



1. Swipe the upper area of the screen.
  - ▶ The status area appears.
2. Select an item to see the details.
3. Select  or swipe up the  icon to close the area.

## Closing Apps

You can close specific apps running in the background on the system.

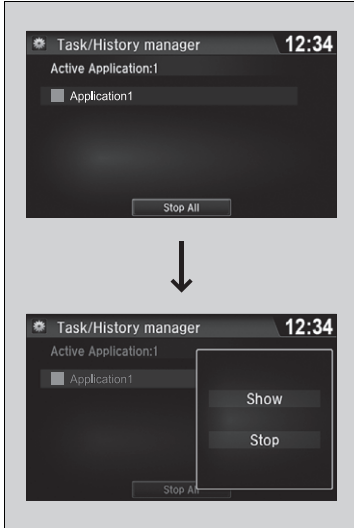

1. Select and hold .
2. Select an app you want to close.
3. Select **Stop**.
  - ▶ The display will return to the app list.

### Closing Apps

If you leave the apps used open in the background, some apps may stop operating properly next time using them.

If this happens close unused apps.

To close all apps on the system, select **Stop All**, then **Yes**.

You cannot close the HondaLink® and Garmin\* apps.

## ■ Updating App

Some of the audio system's apps can be updated wirelessly when connected via Wi-Fi, or *Bluetooth*® in conjunction with the HondaLink® app installed on a compatible iOS or Android device. If an update is available, the audio system beeps and a notification is displayed at the top of the screen with the respective app's update icon.

### ■ To update an app:

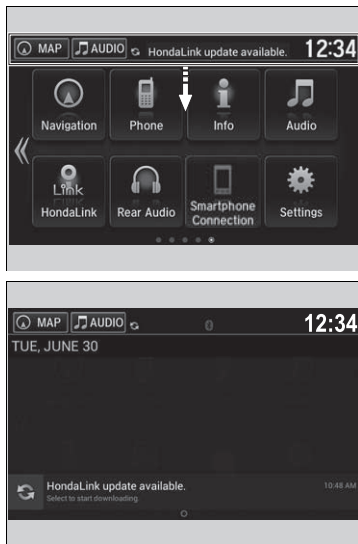

1. From the top of the screen, swipe down to see the messages.

2. Select the software update notification from the list.

### ▶▶ Updating App

The wireless updates are for the apps on the audio system only.

To update compatible apps on your iPhone or Android phone, please visit the App Store or Google Play Store, respectively.

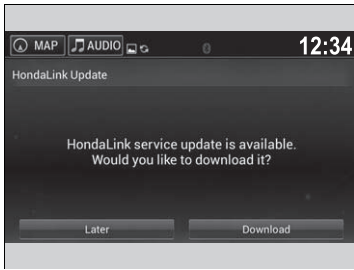

3. Select **Download**.

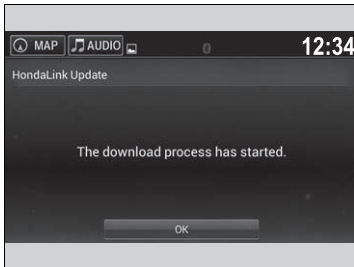

4. Select **OK**.

## Adjusting the Sound

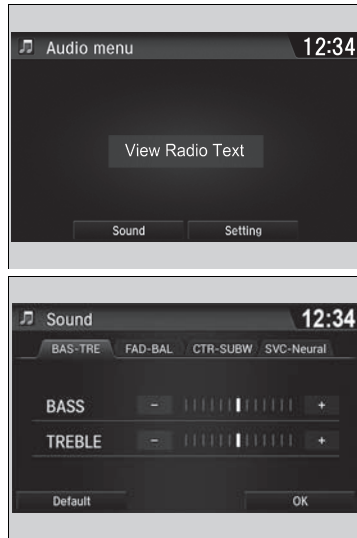

1. Select .
2. Select **Audio**.
3. Select .
4. Select **Sound**.

Select a tab from the following choices:  
**BASS, TREBLE, FADER, BALANCE, Center\***,  
**Subwoofer, Speed Volume Compensation**  
(SVC), **Neural\***

### ▶▶ Adjusting the Sound

The SVC has four modes: **Off, Low, Mid, and High**. SVC adjusts the volume level based on the vehicle speed. As you go faster, audio volume increases. As you slow down, audio volume decreases.

You can also adjust the sound the following procedure.

1. Select .
2. Select **Settings**.
3. Select **Audio**.
4. Select **Sound**.

## Display Setup

You can change the brightness or color theme of the audio/information screen.

### Changing the Screen Brightness

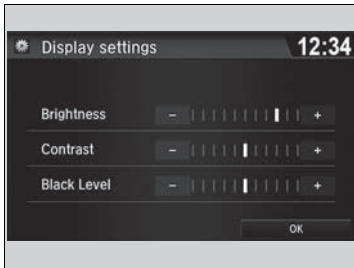

1. Select .
2. Select **Settings**.
3. Select **System**.
4. Select the **Display** tab.
5. Select **Display Settings**.
6. Select the setting you want.
7. Select **OK**.

### Changing the Screen's Color Theme



1. Select .
2. Select **Settings**.
3. Select **System**.
4. Select the **Display** tab.
5. Select **Background Color**.
6. Select the setting you want.
7. Select **OK**.

### Changing the Screen Brightness

You can change the **Contrast** and **Black Level** settings in the same manner.

## ■ Selecting an Audio Source

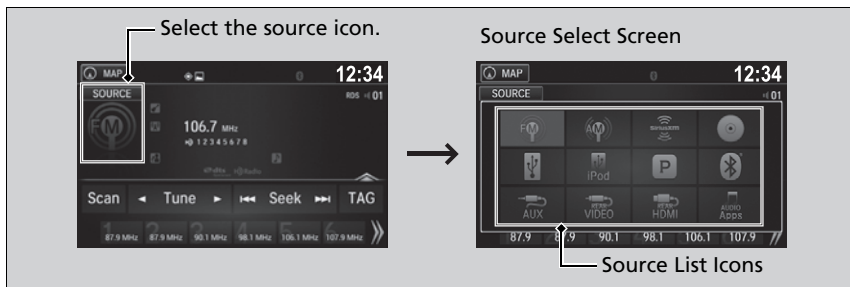

Select the current source icon, then select an icon on the source list to switch the audio source.

## ■ Limitations for Manual Operation

Certain manual functions are disabled or inoperable while the vehicle is in motion. You cannot select a grayed-out option until the vehicle is stopped.

## ▶▶ Selecting an Audio Source



If you startup preinstalled audio apps, **AUDIO Apps** is displayed on the screen.

These preinstalled apps cannot be displayed on the source select screen.

You can startup those audio apps from **AUDIO Apps**.

## Voice Control Operation

Your vehicle has a voice control system that allows hands-free operation.



The voice control system uses the  (Talk) and  (hang-up/back) buttons on the steering wheel and a microphone near the map lights on the ceiling.

### Voice Recognition

To achieve optimum voice recognition when using the voice control system:

- Make sure the correct screen is displayed for the voice command that you are using.
- Close the windows and moonroof\*.
- Adjust the dashboard and side vents so air does not blow onto the microphone on the ceiling.
- Speak clearly in a clear, natural speaking voice without pausing between words.
- Reduce any background noise if possible. The system may misinterpret your command if more than one person is speaking at the same time.

#### Voice Control Operation

When you press the  button, a helpful prompt asks what you would like to do. Press and release the  button again to bypass this prompt and give a command.

#### Voice Recognition

The voice control system can only be used from the driver's seat because the microphone unit removes noises from the front passenger's side.

\* Not available on all models



## Voice Portal Screen

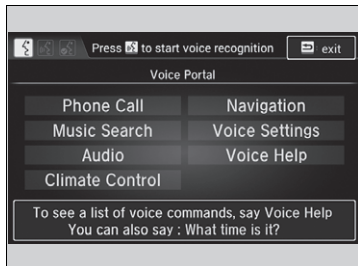

When the  (Talk) button is pressed, available voice commands appear on the screen.

For a complete list of commands, say "Voice Help" after the beep or select **Voice Help**.

You can see the list of commands in **Voice Info** on the **Info menu** screen. Select **Info**, then select .

The system only recognizes the commands on the following pages, at certain screens. Free form voice commands are not recognized.

\*1: Models with navigation system

\* Not available on all models

### Phone Call

This can be only used when the phone is connected. When the system recognizes the *Phone call* command, the screen will change the dedicated screen for the voice recognition of the phone.

- *Dial by number*
- *Call history*
- *Redial*
- *Call <Your Contact Name>*
- *Call <Phone Number>*

Phone Call commands are not available if using Apple CarPlay™.

### Music Search\*1

This can be only used when the iPod or USB device is connected.

### Audio\*1

When the system recognizes the *Audio* command, the screen will change the dedicated screen for the voice recognition of the audio.

- *Audio On*
- *Audio Off*
- *Radio FM*
- *Radio AM*
- *Radio SXM\**
- *DISC\**
- *Pandora\**
- *iPod*
- *USB*
- *Other Sources*

Pandora® cannot be used while Android Auto™ is active.

### Navigation\*1

The screen changes the navigation screen.

 **Refer to the Navigation System Manual**

### Voice Settings

The screen changes the **Voice Recog** tab on the **System settings** screen.

### Voice Help

You can see a list of the available commands on the screen.

- *Useful Commands*
- *Phone Commands*
- *Audio Commands\**
- *On Screen Commands*
- *Music Search Commands\**
- *General Commands*
- *Climate Control Commands\**
- *All Commands*
- *Voice Settings*
- *Getting Started*

## Useful Commands

The system accepts these commands on the voice portal top screen.

- *Call <Phone Number>*
- *Call <Your Contact Name>*
- *What time is it?*
- *What is today's date?*

\*1: Models with navigation system

\* Not available on all models

## Phone Commands

The system accepts these commands on the dedicated screen for the voice recognition of the phone.

- *Call by Number*
- *Call by Name*
- *Call <Phone Number>*
- *Call <Your Contact Name>*

## Audio Commands\*<sup>1</sup>

The system accepts these commands on the dedicated screen for the voice recognition of the audio.

### Radio FM Commands

- *Radio tune to <87.7-107.9> FM*
- *Radio tune to <87.7 -107.9> HD <1-8> FM*
- *Radio FM preset <1-12>*

### Radio AM Commands

- *Radio tune to <530-1710> AM*
- *Radio AM preset <1-6>*

### Radio SXM Commands\*

- *SXM channel <1-999>*
- *SXM channel <station name>*
- *Radio SXM preset <1-12>*

### DISC Commands\*

- *DISC play*
- *DISC play track <1-30>*

### Pandora Commands\*

- *Pandora play*

### iPod Commands

- *iPod play*
- *iPod play track <1-30>*
- *Music Search*
- *What album is this?*
- *What am I listening to?*

### USB Commands

- *USB play*
- *USB play track <1-30>*
- *Music Search*
- *What album is this?*
- *What am I listening to?*

### Bluetooth® audio Commands

- *Bluetooth® audio play*

#### NOTE:

*Bluetooth®* Audio commands may not work on some phones or *Bluetooth®* Audio devices.

## ■ AUX-Audio commands

- *AUX audio play*

## ■ On Screen Commands

When **On Screen Commands** is selected, the explanation screen is displayed.

## ■ Music Search Commands\*<sup>1</sup>

The system accepts these commands on the **Music Search** screen.

### ■ Using Song By Voice

Song By Voice™ is a feature that allows you to select music from your iPod or USB device using Voice Commands. To activate this mode, you must push the talk switch and say: "Music search".

### ■ Song By Voice Commands

- *What am I listening to?*
- *Who am I listening to?*
- *Who is this?*
- *What's playing?*
- *Who's playing?*
- *What album is this?*

\*1: Models with navigation system

## ■ Play Commands

- *Play artist <Name>*
- *Play track/song <Name>*
- *Play album <Name>*
- *Play genre/category <Name>*
- *Play playlist <Name>*
- *Play composer <Name>*

## ■ List Commands

- *List artist <Name>*
- *List album <Name>*
- *List genre/category <Name>*
- *List playlist <Name>*
- *List composer <Name>*

## ■ General Commands

- *What time is it?*
- *What is today's date?*

## ■ Climate Control Commands\*<sup>1</sup>

- *Climate Control on*
- *Climate Control off*
- *Fan Speed <1-7>*
- *Temperature max heat*
- *Temperature max cool*
- *Temperature <57-87> degrees*
- *Defrost on*
- *Defrost off*
- *Air conditioner on*
- *Air conditioner off*
- *More*
- *Climate control automatic*
- *Vent*
- *Dash and floor*
- *Fan speed up*
- *Fan speed down*
- *Floor vents*
- *Floor and defrost*
- *Temperature up*
- *Temperature down*

### NOTE:

These commands toggle the function on and off, so the command may not match your intended action.

## Playing AM/FM Radio

The diagram illustrates the interaction between the vehicle's Multi-Information Display (MID) and the Audio/Information Screen. The MID shows a radio frequency of 90.5 MHz, a signal strength indicator, and a temperature of 63°F. The Audio/Information Screen displays the same frequency, along with a list of preset stations (87.9, 87.9, 90.1, 98.1, 106.1, 107.9) and various control icons for volume, menu, back, scan, tune, and seek.

**Multi-Information Display**

**Audio/Information Screen**

**Power/Audio (Power/Audio) Icon**  
Select to turn the audio system on and off.

**VOL (Volume) Icons**  
Select to adjust the volume.

**(Menu) Icon**  
Select to display the menu items.

**(Back) Icon**  
Select to go back to the previous display.

**Scan Icon**  
Select to scan each station with a strong signal.

**Tune Icons**  
Select or to tune the radio frequency.

**Open/Close Icon\*1**  
Displays/hides the detailed information.

**Seek Icons**  
Select or to search up and down the selected band for a station with a strong signal.

**Preset Icons**  
Tune the radio frequency for preset memory. Select and hold the preset icon to store that station. Select to display preset 7 onwards.

\*1:Some or all of the lists may not be displayed.

## ■ Preset Memory

To store a station:

1. Tune to the selected station.
2. Select and hold the preset number for the station you want to store.

You can also store a preset station by the following procedure.

1. Tune to the selected station.
2. Select the open/close icon to display a list.
3. Select the **Preset** tab.
4. Select and hold the preset number for the station you want to store.

## ■ Station List

Lists the strongest stations on the selected band.

1. Select the open/close icon to display a list.
2. Select the **Station List** tab.
3. Select the station.

## ■ Manual update

Updates your available station list at any time.

1. Select the open/close icon to display a list.
2. Select the **Station List** tab.
3. Select **Refresh**.

## ■ Scan

Samples each of the strongest stations on the selected band for 10 seconds. To turn off scan, select **Cancel** or .

## ▶▶ Playing AM/FM Radio

### ▶▶ Models with HD Radio™

If the audio system has the memory capacity, the tagged song information can be stored in it.

### ▶▶ Preset Memory

The **ST** indicator appears on the display indicating stereo FM broadcasts.

Stereo reproduction in AM is not available.

Switching the Audio Mode

Press the **SOURCE** button on the steering wheel or select **SOURCE** on the screen.

 **Audio Remote Controls** P. 222

You can store 6 AM stations and 12 FM stations into preset memory.

### ▶▶ Models with HD Radio™

HD Radio Technology manufactured under license from iBiquity Digital Corporation. U.S. and Foreign Patents. HD Radio™ and the HD, HD Radio, and "Arc" logos are proprietary trademarks of iBiquity Digital Corp.



## Models with HD Radio™

**HD Subchannel**

Displays the subchannel list when an HD Radio™ station is selected while listening to an FM station.

1. Select .
2. Select **HD Subchannel**.
3. Select the channel number.

**Radio Data System (RDS)**

Provides text data information related to your selected RDS-capable FM station.

**■ To find an RDS station from Station List**

1. Select the open/close icon to display a list while listening to an FM station.
2. Select the **Station List** tab.
3. Select the station.

**■ Manual update**

Updates your available station list at any time.

1. Select the open/close icon to display a list while listening to an FM station.
2. Select the **Station List** tab.
3. Select **Refresh**.

 Radio Data System (RDS)

When you select an RDS-capable FM station, the RDS automatically turns on, and the frequency display changes to the station name. However, when the signals of that station become weak, the display changes from the station name to the frequency.

### ■ Radio text

Displays the radio text information of the selected RDS station.

1. Select .
2. Select **View Radio Text**.

### ■ Scan

Samples each of the strongest stations on the selected band for 10 seconds.

To turn off scan, select **Cancel** or .

## Playing SiriusXM® Radio\*

The diagram shows a multi-tiered display system. At the top is the **Multi-Information Display** showing '002345 miles', a 'D' gear indicator, and '63°F'. Below it is the **Audio/Information Screen**, which is divided into sections: **Album Art** (top left), **Station Art** (top right), and a central channel display. The channel display shows 'CH 002 BBB' and 'DDD Live'. At the bottom of the screen are **Scan**, **Category**, **Channel**, and **Skip** icons, along with a list of preset stations like '80s on 8', 'Venus', 'Classic Vinyl', 'Soul Town', 'CNA', and 'MLB 175'. On the left side, a vertical strip contains **AUDIO**, **HOME**, **VOL**, **MENU**, and **BACK** icons.

**Multi-Information Display**

**Channel Icons**  
 Select **◀◀** or **▶▶** to the previous or next channel.  
 Select and hold to rapidly skip 10 channels at a time.

**Audio/Information Screen**

**Station Art**

**Open/Close Icon<sup>\*1</sup>**  
 Displays/hides the detailed information.

**Preset Icons**  
 Tune the radio frequency for preset memory. Select and hold the preset icon to store that station. Select **>>** to display preset 7 onwards.

**Album Art**

**Audio (Power/Audio) Icon**  
 Press to turn the audio system on and off.

**VOL (Volume) Icons**  
 Select to adjust the volume.

**(Menu) Icon**  
 Select to display the menu items.

**(Back) Icon**  
 Select to go back to the previous display.

**Scan Icon**  
 Select to scan each channel.

**Category Icons**  
 Select **◀** or **▶** to display and select a SiriusXM® Radio category.

**Skip Icons**  
 Select **◀◀** or **▶▶** to change section in the channel. Select and hold to move rapidly within the section.

Features

\*1: Some or all of the lists may not be displayed.

\* Not available on all models



## ■ To Change the Tune Mode

1. Select .
2. Select **Tune Mode**.
3. Select **Channel Mode** or **Category Mode**.

## ▶▶ Playing SiriusXM® Radio\*

In the channel mode, all available channels are selectable. In the category mode, you can select a channel within a category (Jazz, Rock, Classical, etc.).

There may be instances when SiriusXM® Radio does not broadcast all the data fields (artist name, title). This does not indicate a problem with your audio system.

SiriusXM® Radio stations load in ascending order, which can take about a minute. Once they have loaded you will be able to scroll up or down to make your selections.

Switching the Audio Mode

Press the **SOURCE** button on the steering wheel or select **SOURCE** on the screen.

 **Audio Remote Controls** P. 222

**Tune Start:**

When you change to a preset channel, a song being played on that channel restarts from the beginning with this function. This can be turned on or off from the **Audio settings** screen.

 **Customized Features** P. 358

## ■ Preset Memory

To store a channel:

1. Tune to the selected channel.
2. Select to hold the preset number for the station you want to store.
3. Select **Replace**.

You can also store a channel by the following procedure.

1. Tune to the selected channel.
2. Select the open/close icon to display a list.
3. Select the **Preset** tab.
4. Select and hold the preset number for the station you want to store.

## ■ Multi-channel preset (for music channels only)

You can store up to four of your preferred music channels per preset.

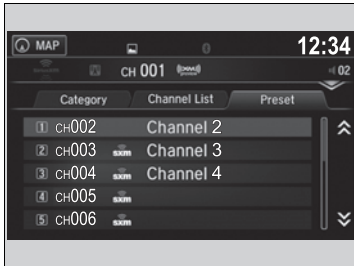

1. Tune a station.
2. Select the open/close icon to display a list.
3. Select the **Preset** tab.
4. Select and hold the preset number you want to add a music channel.
  - ▶ A message appears if there are no available presets.
5. Select **Combine**.

## ▶▶ Playing SiriusXM® Radio\*

You can store 12 SiriusXM® channels into the preset memory.

## ■ Listening to Featured Channels

Suggested channel listing received from SiriusXM® can be displayed and selected.

1. Select the open/close icon to display a channel list.
2. Select the **Channel List** tab.
3. Select the featured channel list title you want to listen to.
  - ▶ The selected channel list of the title is displayed.
4. Select the channel.

## ▶▶ Listening to Featured Channels

Up to three featured channels by SiriusXM® can be displayed.

Featured channel lists are at the top of the channel list.

## Replay Function

The system can record up to the last 60 minutes broadcast of your currently tuned channel as well as the last 30 minutes broadcast of preset channels, starting from the moment you turn the vehicle on. If you tuned to preset channel, the system records up to 60 minutes of a broadcast instead of up to 30 minutes. You can rewind and replay the last 30 or 60 minutes of a broadcast.

1. Select .
2. Select **Playback Position**.
3. Move the gauge to the position you want to replay.

To play or pause on playback mode:

1. Select .
2. Select **Play/Pause**.

## Returning to real-time broadcast

1. Select .
2. Select **Play Live Broadcast**.

## Replay Function

The system starts storing broadcast in memory when the power mode is turned ON. You can go back to the program from that point.

You can no longer replay any program once the power mode is turned off as it erases memory. You can check how long the program has been stored in memory from the audio/information screen.

After 30 or 60 minutes of recording the system will automatically start deleting the oldest data.

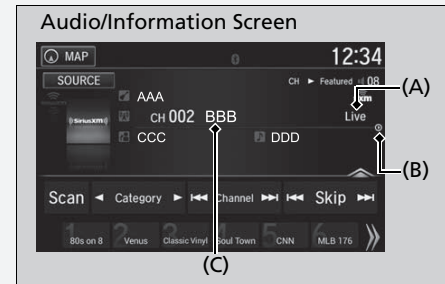

(A): Shows how much time the replayed segment is behind the real-time broadcast

(B): Replayed segment

(C): Length stored in memory

## ■ Live Sports Alert

While listening to other channel, you can receive sports alerts such as scores from your favorite teams.

### ■ To set up a favorite team

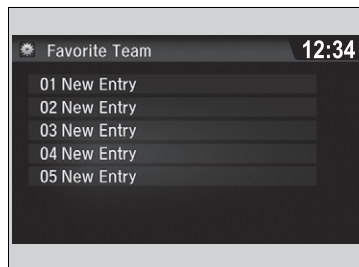

1. Select .
2. Select **Settings**.
3. Select **Audio**.
4. Select the **SXM** tab.
5. Select **SportFlash Setup(Favorite Team)**.
6. Select a team.

### ■ To set up an alert message

1. Select .
2. Select **Settings**.
3. Select **Audio**.
4. Select the **SXM** tab.
5. Select **SportFlash Setup(Interrupt)**.
6. Select **On(one time)** or **On(continue)**.

### ▶▶ Live Sports Alert

The sports alert function at SiriusXM® mode only.

### ▶▶ To set up a favorite team

Sports alerts cut in only when SiriusXM® mode is on. Selecting **On(one time)** from the customize settings disables the alert feature next time you turn the power mode to ON.

 **Customized Features** P. 358

You can also set up a favorite team by the following procedure.

1. Select **Audio**.
2. Select .
3. Select **Settings**.
4. Select the **SXM** tab.

**■ To set up a alert beep**

1. Select .
2. Select **Settings**.
3. Select **Audio**.
4. Select the **SXM** tab.
5. Select **SportFlash Setup(Interrupt Beep)**.
6. Select **On**.

**■ Traffic and Weather Information**

You can receive traffic and weather information.

1. Select .
2. Select **Settings**.
3. Select **Audio**.
4. Select the **SXM** tab.
5. Select **Traffic & Weather Setup**.
6. Select the region.
  - ▶ When you do not want to receive the information, select **Unset**.

**■ Scan**

Sample each channel on the selected mode for 10 seconds.

1. Select **Scan**.
2. Select **Scan Channels**.
  - ▶ You can select the desired channel by songs using **Scan Songs in Presets**.

To turn off scan, select **Cancel**.

**☒ To set up a alert beep**

You can also set up a alert beep by the following procedure.

1. Select **Audio**.
2. Select .
3. Select **Settings**.
4. Select the **SXM** tab.

**☒ Traffic and Weather Information**

The traffic and weather information function at SiriusXM® mode only.

You can also set up the traffic and weather information by the following procedure.

1. Select **Audio**.
2. Select .
3. Select **Settings**.
4. Select the **SXM** tab.

**☒ Scan**

The "Scan Songs in Presets" function is based on TuneScan™ technology of SiriusXM®.

The "Featured Channels" function is based on Featured Favorites™ technology of SiriusXM®.

TuneScan™ and Featured Favorites™ are registered trademarks of SiriusXM® Radio, Inc.

## Playing a CD \*

Your audio system supports audio CDs, CD-Rs, and CD-RWs in either MP3, WMA, or AAC\*1 format. With the CD loaded, select the CD mode.

The diagram illustrates the car's audio system interface and CD slot. It shows a multi-information display at the top, an audio/information screen in the center, and a CD slot at the bottom. A vertical control panel on the left contains several buttons: AUDIO (Power/Audio), VOL (Volume), MENU, BACK, and a set of Folder icons. Callouts provide detailed instructions for each of these elements.

- Multi-Information Display:** Shows a CD icon, 002345 miles, 'D', and 63°F.
- Audio/Information Screen:** Shows a map, time 12:34, and track information: SOURCE, 03 01 AAA, 01 BBB, CCC, DD, and 00:07. It also features Folder and Track navigation buttons.
- CD Slot:** Shows a CD being inserted into the slot.
- (Eject) Button:** A button with an upward-pointing triangle icon used to eject a CD.

**Controls and Functions:**

- AUDIO (Power/Audio) Icon:** Select to turn the audio system on and off.
- VOL (Volume) Icons:** Select to adjust the volume.
- (Menu) Icon:** Select to display the menu items.
- (Back) Icon:** Select to go back to the previous display.
- Folder Icons:** Select to skip to the next folder, and to skip to the beginning of the previous folder in MP3, WMA, or AAC.
- Track Icons:** Select or to change tracks (files in MP3, WMA, or AAC). Select and hold to move rapidly within a track.
- Open/Close Icon\*2:** Displays/hides the detailed information.

\*1: Only AAC format files recorded with iTunes are playable on this unit.

\*2: Some or all of the lists may not be displayed.

## How to Select a File from the Music Search List (MP3/WMA/AAC)

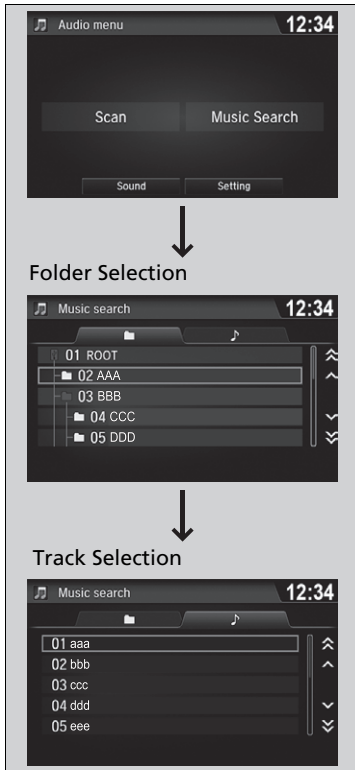

1. Select  and select **Music Search**.

2. Select a folder.

3. Select a track.

### ▶▶▶ Playing a CD\*

#### NOTICE

Do not use CDs with adhesive labels. The label can cause the CD to jam in the unit.

WMA files protected by digital rights management (DRM) cannot be played.

The audio system displays **Unplayable File**, then skips to the next file.

Text data appears on the display under the following circumstances:

- When you select a new folder, file, or track.
- When you change the audio mode to CD.
- When you insert a CD.

If you eject the CD but do not remove it from the slot, the system reloads the CD automatically after several seconds.

\* Not available on all models

Continued



## ■ How to Select a Play Mode

You can select scan, repeat, and random modes when playing a track or file.

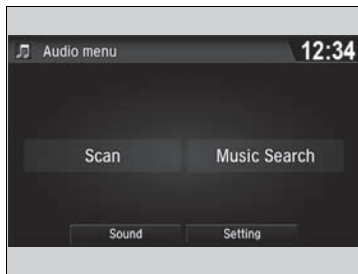

### ■ Scan

1. Select .
2. Select **Scan**.
3. Select a play mode.



### ■ Random/Repeat

Select a play mode.

### ■ To turn off a play mode

Select the mode you want to turn off.

## ▶▶ How to Select a Play Mode

Play Mode Menu Items

### Scan

**Scan Folders** (MP3/WMA/AAC): Provides 10-second sampling of the first file in each of the main folders.

**Scan Tracks**: Provides 10-second sampling of all tracks on the CD (all files in the current folder in MP3, WMA, or AAC).

### Random/Repeat

**Repeat Folder** (MP3/WMA/AAC): Repeats all files in the current folder.

**Repeat/Repeat Track**: Repeats the current track/file.

**Random in Folder** (MP3/WMA/AAC): Plays all files in the current folder in random order.

**Random/Random All Tracks**: Plays all tracks/files in random order.

## Playing an iPod

Connect the iPod using your USB connector to the USB port, then select the iPod mode.

 **USB Port(s)** P. 219

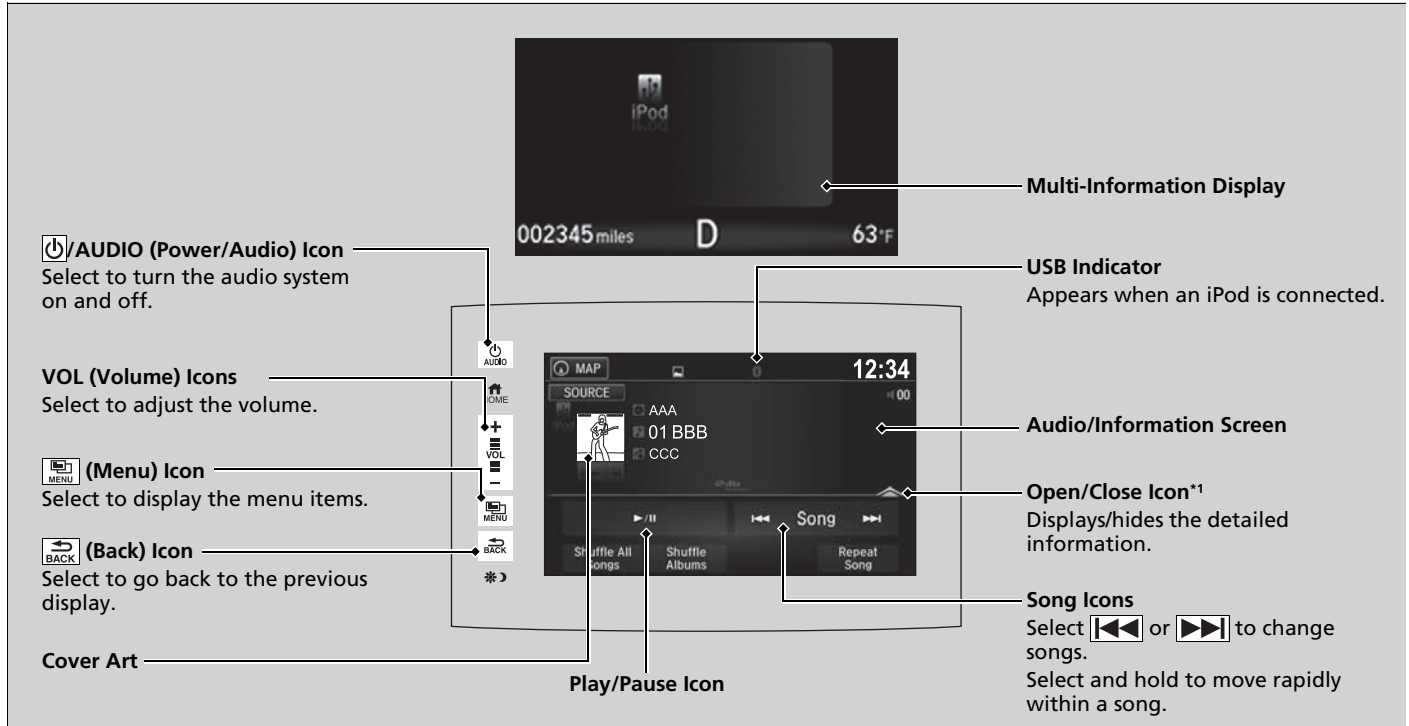

\*1: Some or all of the lists may not be displayed.

## How to Select a Song from the Music Search List

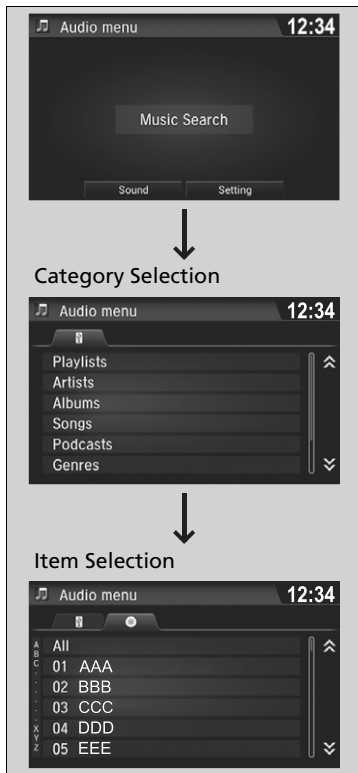

1. Select  and select **Music Search**.

2. Select the items on that menu.

## ▶▶ Playing an iPod

Available operating functions vary on models or versions. Some functions may not be available on the vehicle's audio system.

If there is a problem, you may see an error message on the audio/information screen.

 **iPod/USB Flash Drive** P. 311

If you operate the music app on your iPhone/iPod while the phone is connected to the audio system, you may no longer be able to operate the same app on the audio/information screen. Reconnect the device if necessary.

If an iPhone is connected via Apple CarPlay™, the iPod/USB source is unavailable and audio files on the phone can only be played within Apple CarPlay™.

## How to Select a Play Mode

You can select shuffle and repeat modes when playing a file.  
Select a play mode.

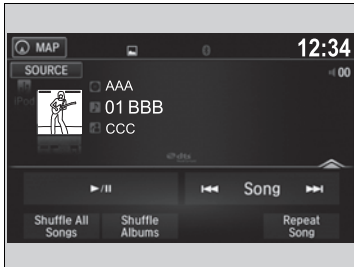

### ■ To turn off a play mode

Select the mode you want to turn off.

## How to Select a Play Mode

Play Mode Menu Items

**Shuffle All Songs:** Plays all available files in a selected list (playlists, artists, albums, songs, podcasts, genres, composers, or audiobooks) in random order.

**Shuffle Albums:** Plays all available albums in a selected list (playlists, artists, albums, songs, podcasts, genres, composers, or audiobooks) in random order.

**Repeat Song:** Repeats the current track.

Models with navigation system

## Song By Voice™ (SBV)

Use SBV to search for and play music from your USB flash drive or iPod using voice commands.

### ■ To enable SBV

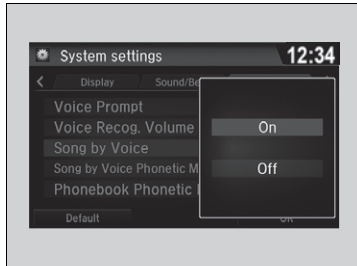

1. Select .
2. Select **Settings**.
3. Select **System**.
4. Select the **Voice Recog** tab.
5. Select the **Song by Voice**.
6. Select **On** or **Off**.



### ⌘ Song By Voice™ (SBV)

Setting options:

- **On** (factory default): Song By Voice™ commands are available.
- **Off**: Disable the feature.

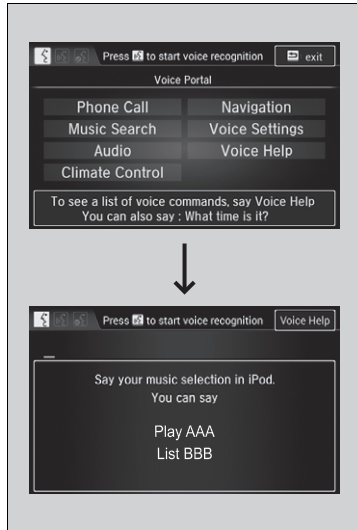
## ■ Searching for music using SBV



1. Set the **Song by Voice** setting to **On**.
2. Press the  (Talk) button and say “*Music Search*” to activate the SBV feature for the USB flash drive and iPod.
3. Press the  button and say a command.
  - ▶ Example 1: Say “*(List) ‘Artist A’*” to view a list of songs by that artist. Select the desired song to start playing.
  - ▶ Example 2: Say “*Play ‘Artist A’*” to start playing songs by that artist.
4. To cancel SBV, press the  (hang-up/back) button on the steering wheel. The selected song continues playing.

Once you have canceled this mode, you need to press the  button and say “*Music Search*” again to re-activate this mode.

### ☒ Searching for music using SBV

Song By Voice™ Commands List

➤ **Song By Voice Commands** P. 266

NOTE:

Song By Voice™ commands are available for tracks stored on the USB flash drive or iPod.

You can add phonetic modifications of difficult words so that it is easier for SBV to recognize artists, songs, albums, and composers in voice commands.

➤ **Phonetic Modification** P. 286

SBV is not available when using Apple CarPlay™. Use Siri® Eyes Free instead.

Continued

## ■ Phonetic Modification

Add phonetic modifications of difficult or foreign words so that it is easier for SBV to recognize artists, songs, albums, and composers in voice commands when searching for music on the USB flash drive or iPod.

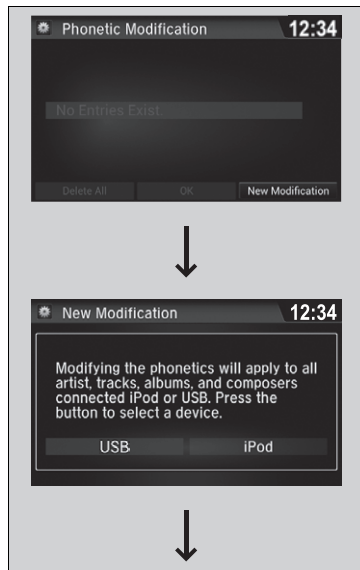



1. Select .
2. Select **Settings**.
3. Select **System**.
4. Select the **Voice Recog** tab.
5. Select **Song by Voice Phonetic Modification**.
6. Select **New Modification**.
7. Select **USB** or **iPod**.

## ▶▶ Phonetic Modification

**Song by Voice Phonetic Modification** is grayed out when **Song By Voice** is set to **Off**.

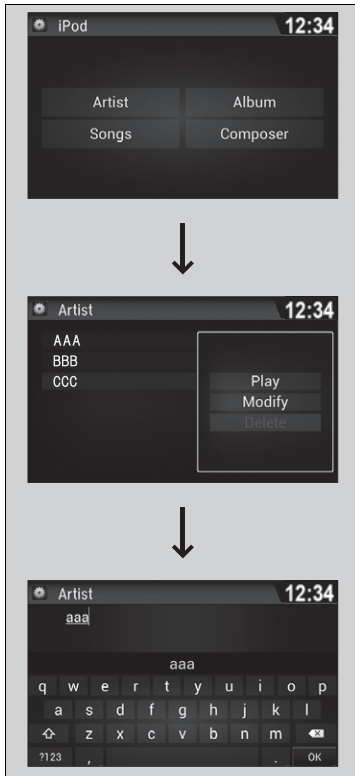
You can store up to 2,000 phonetic modification items.



8. Select the item to modify (e.g., **Artist**).
  - ▶ The list of the selected item appears on the screen.
9. Select an entry to modify.
  - ▶ The pop-up menu appears on the screen.
  - ▶ The listen to the current phonetic modification, select **Play**.
  - ▶ To delete the current phonetic modification, select **Delete**.
10. Select **Modify**.
11. Select the phonetic spelling you want to use (e.g., "Artist A") when prompted.
12. Select **OK**.
  - ▶ The artist "No Name" is phonetically modified to "Artist A." When in the SBV mode, you can press the  (Talk) button and use the voice command "Play 'Artist A'" to play songs by the artist "No Name."



## Playing Pandora®\*

Your audio system allows you to listen to music from the Pandora® app on a compatible smartphone.

This function is available when the phone is paired and connected to the vehicle's *Bluetooth*® HandsFreeLink® (HFL) system, or with an iPhone, you can connect using your USB cable to the USB port.

▶ **Phone Setup** P. 423

▶ **USB Port(s)** P. 219

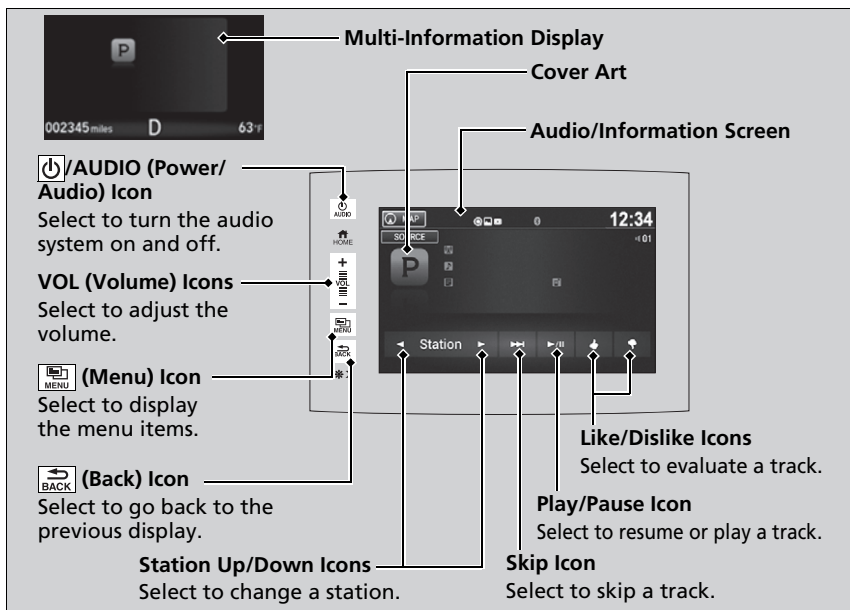

\*1:Some or all of the lists may not be displayed.

### ▶▶ Playing Pandora®\*

Pandora®, the Pandora logo, and the Pandora trade dress are trademarks or registered trademarks of Pandora Media, Inc., used with permission. Pandora is only available in certain countries. Visit the Pandora website for more information.

To find out if your phone is compatible with this feature, visit [www.handsfreelink.honda.com](http://www.handsfreelink.honda.com), or call 1-888-528-7876.

To use this service in your vehicle, the Pandora® app must first be installed on your phone. Visit [www.pandora.com](http://www.pandora.com) for more information.

Pandora® is free, personalized radio that plays music and comedy you'll love. Just start with the name of one of your favorite artists, tracks, comedians or composers and Pandora® will create a custom station that plays similar tracks. Pandora® also features hundreds of genre stations ranging from Dubstep to Smooth Jazz to Power Workout.

If you cannot operate Pandora® through the audio system, it may be streaming through *Bluetooth*® Audio. Make sure Pandora® mode on your audio system is selected.

If your phone is connected to Android Auto™, Pandora® is only available through the Android Auto™ interface. Visit the Android Auto™ website to check compatibility.

## Pandora® Menu

You can operate some of the Pandora® menu items from your vehicle's audio system. The available items are:

- **Bookmark**
- **Station List**
- **New Station**
- **Sound**
- **Setting**

### ■ Operating a menu item

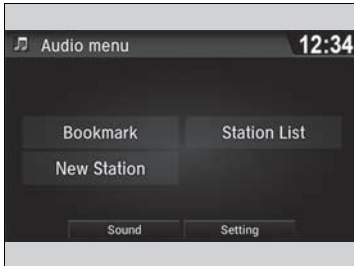

1. Select .
2. Select an item.

### ☒ Pandora® Menu

Available operating functions vary on software versions. Some functions may not be available on the vehicle's audio system.

If there is a problem, you may see an error message on the audio/information screen.

➤ **Pandora®\*** P. 312

Pandora® may limit the total number of skips allowed on the service. If you dislike a track after the skip limit has been reached, your feedback will be saved but the current track will continue to play.

To change stations, activate the Pandora® menu, select **Station List**, and then select a new station. It also changes stations on the main Pandora® screen.

## Playing a USB Flash Drive

Your audio system reads and plays sound files on a USB flash drive in either MP3, WMA, or AAC\*1 format.

Connect your USB flash drive to the USB port, then select the USB mode.

➤ **USB Port(s)** P. 219

The diagram illustrates the car's audio system interface. At the top is the **Multi-Information Display**, which shows a USB icon, '002345 miles', 'D', and '63°F'. Below it is the **Audio/Information Screen**, which displays 'MAP', '12:34', 'SOURCE', '03 01 AAA', '01 BBB', '00:00', '00:07', 'CCC', 'DDD', and playback controls for 'Folder' and 'Track'. A vertical strip of icons is shown on the left side of the screen, including AUDIO, HOME, VOL, MENU, and BACK. Arrows point from these icons to their respective descriptions.

**AUDIO (Power/Audio) Icon**  
Select to turn the audio system on and off.

**VOL (Volume) Icons**  
Select to adjust the volume.

**MENU (Menu) Icon**  
Select to display the menu items.

**BACK (Back) Icon**  
Select to go back to the previous display.

**Folder Icons**  
Select to skip to the next folder, and to skip to the beginning of the previous folder.

**Multi-Information Display**

**USB Indicator**  
Appears when a USB flash drive is connected.

**Audio/Information Screen**

**Open/Close Icon\*2**  
Displays/hides the detailed information.

**Track Icons**  
Select or to change files. Select and hold to move rapidly within a track.

\*1: Only AAC format files recorded with iTunes are playable on this unit.

\*2: Some or all of the lists may not be displayed.

## How to Select a File from the Music Search List

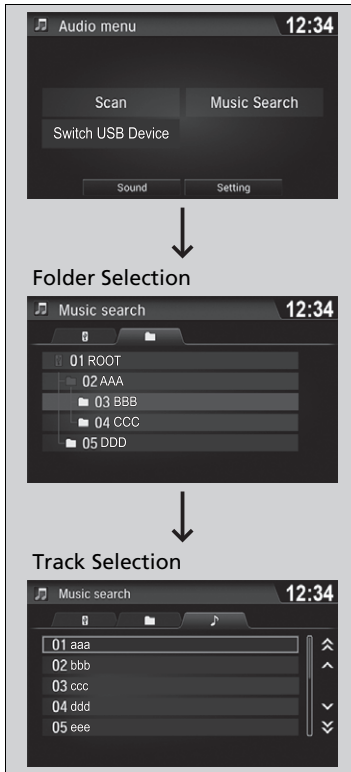

1. Select  and select **Music Search**.
2. Select **Music**.

3. Select a folder.

4. Select a track.

## ▶▶ Playing a USB Flash Drive

Use the recommended USB flash drives.

▶ **General Information on the Audio System**  
P. 314

WMA files protected by digital rights management (DRM) cannot be played.

The audio system displays **Unplayable File**, then skips to the next file.

If there is a problem, you may see an error message on the audio/information screen.

▶ **iPod/USB Flash Drive** P. 311

Select **Switch USB Device** in the **Audio menu** screen to switch to another USB device.

## ■ How to Select a Play Mode

You can select scan, repeat, and random modes when playing a file.

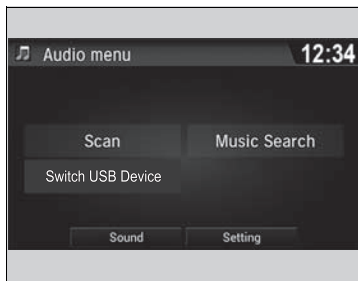

### ■ Scan

1. Select .
2. Select **Scan**.
3. Select a play mode.

### ■ Random/Repeat

Select a play mode.

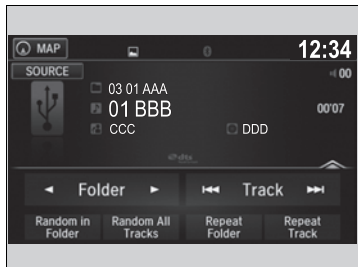

### ■ To turn off a play mode

Select the mode you want to turn off.

## ▶▶ How to Select a Play Mode

Play Mode Menu Items

### Scan

**Scan Folders:** Provides 10-second sampling of the first file in each of the main folders.

**Scan Tracks:** Provides 10-second sampling of all files in the current folder.

### Random/Repeat

**Random in Folder:** Plays all files in the current folder in random order.

**Random All Tracks:** Plays all files in random order.

**Repeat Folder:** Repeats all files in the current folder.

**Repeat Track:** Repeats the current file.

## Playing *Bluetooth*® Audio

Your audio system allows you to listen to music from your *Bluetooth*-compatible phone.

This function is available when the phone is paired and connected to the vehicle's *Bluetooth*® HandsFreeLink® (HFL) system.

📄 **Phone Setup** P. 423

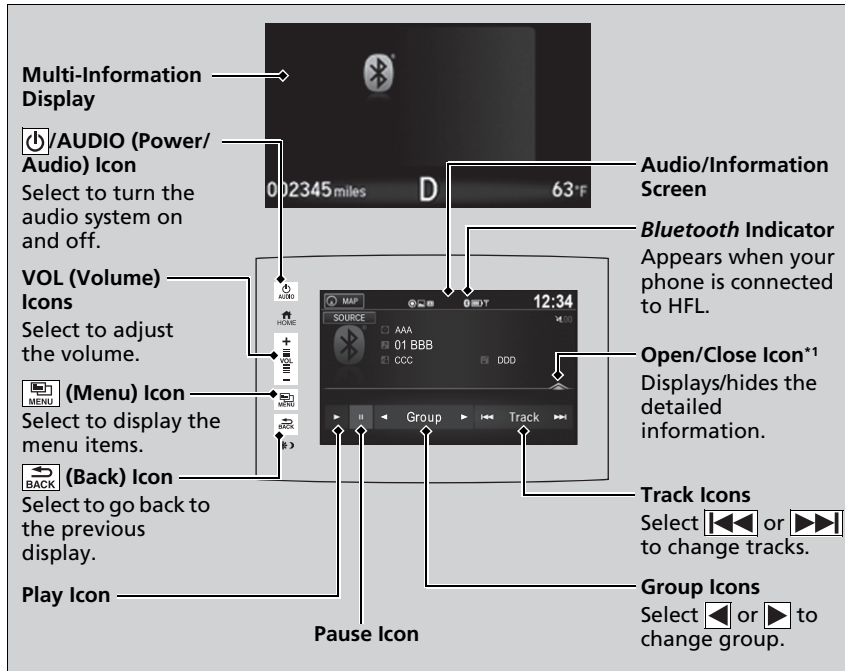

\* 1: Depending on the *Bluetooth*® device you connect, some or all of the lists may not be displayed.

### ▶▶ Playing *Bluetooth*® Audio

Not all *Bluetooth*-enabled phones with streaming audio capabilities are compatible. To check if your phone is compatible, visit <http://www.handsfreelink.com/Honda/>.

It may be illegal to perform some data device functions while driving.

Only one phone can be used with HFL at a time. When there are more than two paired phones in the vehicle, the first paired phone the system finds is automatically connected.

The connected phone for *Bluetooth*® Audio can be different.

If more than one phone is paired to the HFL system, there may be a delay before the system begins to play.

In some cases, the name of the artist, album, or track may not appear correctly.

Some functions may not be available on some devices.

If a phone is currently connected via Apple CarPlay™ or Android Auto™, *Bluetooth*® Audio from that phone is unavailable. However, a second previously paired phone can stream *Bluetooth*® Audio by selecting **Connect** from **Bluetooth Device List**.

📄 **Phone Setup** P. 423

## ■ To Play *Bluetooth*® Audio Files

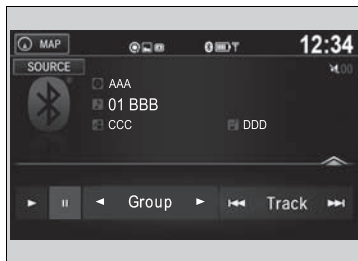

1. Make sure that your phone is paired and connected to the system.

▶ **Phone Setup** P. 423

2. Select the *Bluetooth*® Audio mode.

If the phone is not recognized, another HFL-compatible phone, which is not compatible for *Bluetooth*® Audio, may already be connected.

## ■ To pause or resume a file

Select the play icon or pause icon.

## ■ Searching for Music

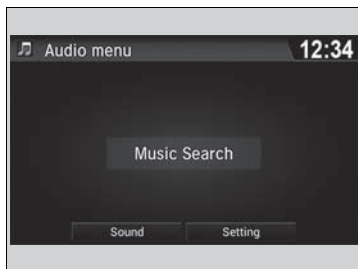

1. Select .
2. Select **Music Search**.
3. Select a search category (e.g., Albums).
4. Select an item.
  - ▶ The selection begins playing.

## ▶▶ To Play *Bluetooth*® Audio Files

To play the audio files, you may need to operate your phone. If so, follow the phone maker's operating instructions.

Switching to another mode pauses the music playing from your phone.

You can change the connected phone in the *Bluetooth*® settings on the **Audio menu** screen by the following procedure.

1. Select .
2. Select **Settings**.

## ▶▶ Searching for Music

Depending on the *Bluetooth*® device you connect, some or all of the lists may not be displayed.

## HondaLink®

HondaLink® connects you to the latest information from Honda. You can connect your phone wirelessly through Wi-Fi or *Bluetooth®*.

➤ **Wi-Fi Connection** P. 300

➤ **Phone Setup** P. 423

### HondaLink® Menu

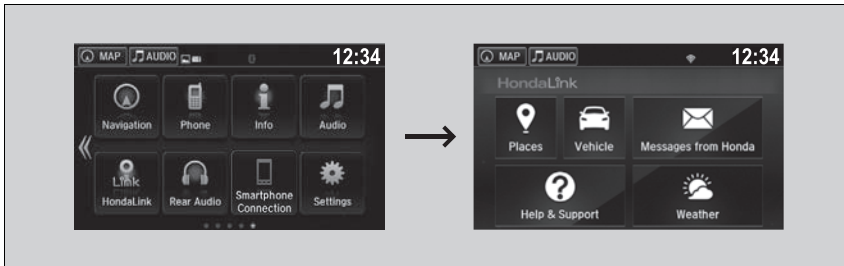

#### ■ Places\*

Displays restaurants, gas stations, Honda dealer, and so on. You can also navigate to the found locations via the navigation.

#### ■ Vehicle

Displays instruction messages when the vehicle needs service.

#### ■ Help & Support

Displays tips for vehicle usage, and get support via road side or customer service center.

#### ✘ HondaLink®

The HondaLink® connect app is compatible with most iPhone and Android phones.

Some cell phone carriers charge for tethering and smartphone data use. Check your phone's data subscription package.

When Apple CarPlay™ or Android Auto™ is connected to the audio system, HondaLink® can be accessed even without a Wi-Fi connection.

\* Not available on all models



## ■ Messages from Honda

Displays helpful and important information from Honda.

## ■ Weather\*

Displays a weekly five-day weather forecast for any location you want. You can change the ZIP Code at any time.

## ■ To Set Up to Connect HondaLink® Service

Use the following procedure to connect to HondaLink® service.

### ■ To enable to the HondaLink® service

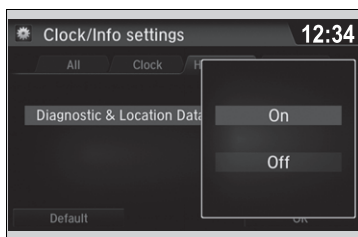

1. Select .
2. Select **Settings**.
3. Select **Clock/Info**.
4. Select the **HondaLink** tab.
5. Select **Diagnostic & Location Data**.
6. Select **On**.

You need to allow the consent of the location service to enable the HondaLink® service.

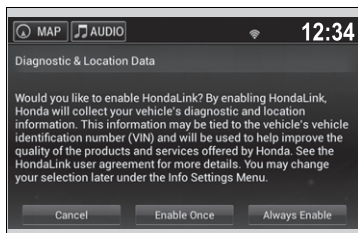

- Enable Once:** Allows only one time. (Shows again next time.)
- Always Enable:** Allows anytime. (Never show again.)
- Cancel:** Does not allow this consent.

## ■ To link with HondaLink®

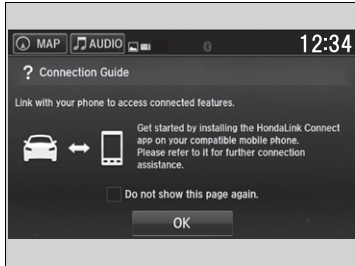

You can see the **Connection Guide** screen after launching HondaLink®. If you do not need this guide, select check-box and select **OK**.

## ■ Vehicle Information and Message from Honda Tips

You can check the messages that are received quickly in the shortcut operation.



1. A message appears and notifies you of a new message on the header area.
  - ▶ When the message is received, a notification ring can be heard.

2. A message icon is continuously displayed in the header area until the new message is read.



3. From the top of the screen, swipe down to see the messages.



4. Select a new message to open.

## Wi-Fi Connection

You can connect the display audio to the Internet using Wi-Fi and browse websites or use online services on the audio/information screen. If your phone has wireless hotspot capabilities, the system can be tethered to the phone. Use the following steps to setup.

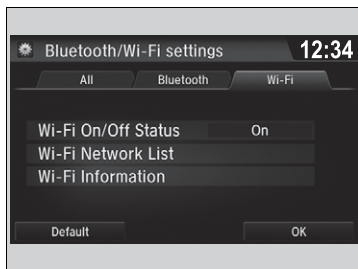
### Wi-Fi mode (setting for the first time)



1. Select .
2. Select **Settings**.
3. Select **Bluetooth/Wi-Fi**.
4. Select the **Wi-Fi** tab.
5. Select **Wi-Fi On/Off Status**, then **On**.
6. Select **Wi-Fi Network List**.
  - ▶ Make sure your phone's Wi-Fi setting is in access point (tethering) mode.
  - ▶ Select the phone you want to connect to the system.
  - ▶ If you do not find the phone you want to connect in the list, select **Scan**.
7. Select **Connect**.
  - ▶ Enter a password for your phone, and select **OK**.
  - ▶ When the connection is successful, the  icon is displayed on the list.
8. Select  to go back to the home screen.

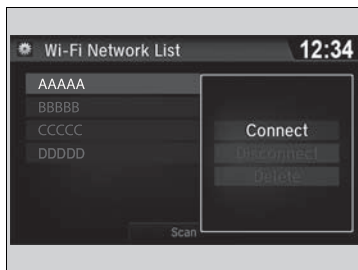

### Wi-Fi mode (setting for the first time)

You cannot go through the setting procedure while a vehicle is moving. Park in a safe place to set the audio system in Wi-Fi mode.

Some cell phone carriers charge for tethering and smartphone data use. Check your phone's data subscription package.

Check your phone manual to find out if the phone has Wi-Fi connectivity.

You can confirm whether Wi-Fi connection is on or off with the  icon on **Wi-Fi Network List**. Transmission speed and others will not be displayed on this screen.

## ■ Wi-Fi mode (after the initial setting has been made)

Make sure your phone's Wi-Fi setting is in access point (tethering) mode.

### ☒ Wi-Fi mode (after the initial setting has been made)

#### iPhone users

You may need to go through an initial setup for Wi-Fi connection again after you boot your phone.

## Siri® Eyes Free

You can talk to Siri using the  (Talk) button on the steering wheel when your iPhone is paired to the *Bluetooth*® HandsFreeLink® (HFL) system.

➤ **Phone Setup** P. 423

### ■ Using Siri® Eyes Free

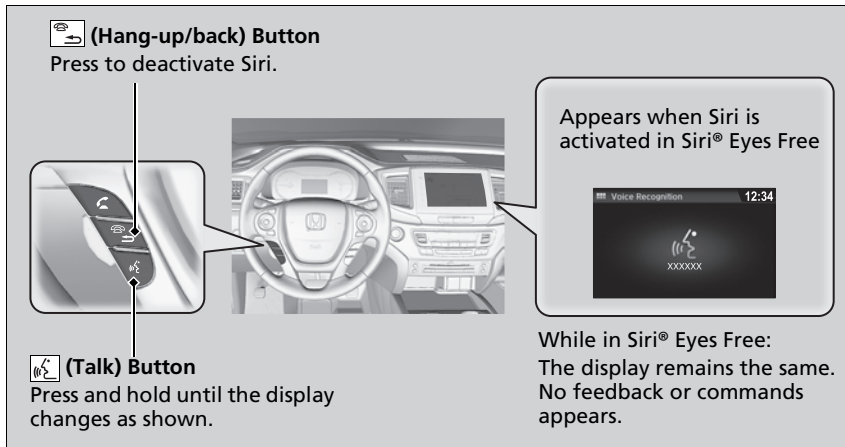

 **(Hang-up/back) Button**  
Press to deactivate Siri.

 **(Talk) Button**  
Press and hold until the display changes as shown.

**Appears when Siri is activated in Siri® Eyes Free**

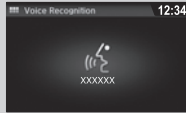

**While in Siri® Eyes Free:**  
The display remains the same.  
No feedback or commands appears.

### ▶▶ Siri® Eyes Free

Siri is a trademark of Apple Inc.

Check Apple Inc. website for features available for Siri.

We recommend against using Siri other than in Siri® Eyes Free while operating a vehicle.

### ▶▶ Using Siri® Eyes Free

Some commands work only on specific phone features or apps.

## Apple CarPlay™

If you connect an Apple CarPlay™-compatible iPhone to the system via the 1.5A USB port, you can use the audio/information screen, instead of the iPhone display, to make a phone call, listen to music, view maps (navigation), and access messages.

📄 **USB Port(s)** P. 219

### Apple CarPlay™ Menu

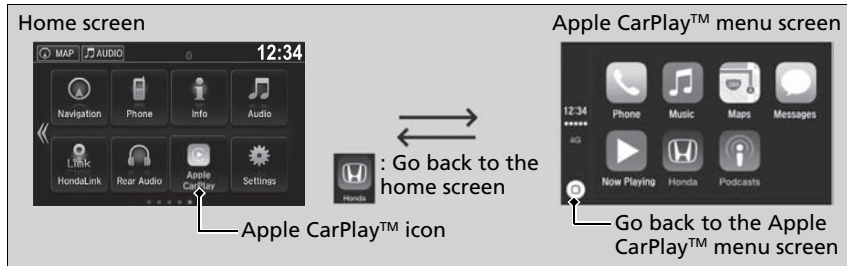

#### ■ Phone

Access the contact list, make phone calls, or listen to voice mail.

#### ■ Messages

Check and reply to text messages, or have messages read to you.

#### ■ Music

Play music stored on your iPhone.

#### 📄 Apple CarPlay™

Only iPhone 5 or newer versions with iOS 8.4 or later are compatible with Apple CarPlay™.

Park in a safe place before connecting your iPhone to Apple CarPlay™ and when launching any compatible apps.

To use Apple CarPlay™, connect the USB cable to the 1.5A USB port. The USB port located on the back of the console compartment will not enable Apple CarPlay™ operation.

📄 **USB Port(s)** P. 219

To directly access the Apple CarPlay™ phone function, select **Phone** on the home screen. While connected to Apple CarPlay™, calls are only made through Apple CarPlay™. If you want to make a call with *Bluetooth®* HandsFreeLink®, turn Apple CarPlay™ OFF or detach the USB cable from your iPhone.

📄 **Setting Up Apple CarPlay™** P. 304

When your iPhone is connected to Apple CarPlay™, it is not possible to use the *Bluetooth®* Audio or *Bluetooth®* HandsFreeLink®. However, other previously paired phones can stream audio via *Bluetooth®* while Apple CarPlay™ is connected.

📄 **Phone Setup** P. 423

For details on countries and regions where Apple CarPlay™ is available, as well as information pertaining to function, refer to the Apple homepage.

Continued



## ■ Maps

Display Apple CarPlay™ map and use the navigation function just as you would on your iPhone.

### Models with navigation system

Only one navigation system (pre-installed navigation or Apple CarPlay™ map) can give directions at a time. When you are using one system, directions to any prior destination set on the other system will be canceled, and the system you are currently using will direct you to your destination.

## ■ Setting Up Apple CarPlay™

After you have connected your iPhone to the system via the 1.5A USB port, use the following procedure to set up Apple CarPlay™. Use of Apple CarPlay™ will result in the transmission of certain user and vehicle information (such as vehicle location, speed, and status) to your iPhone to enhance the Apple CarPlay™ experience. You will need to consent to the sharing of this information on the audio/information screen.

## ■ Enabling Apple CarPlay™

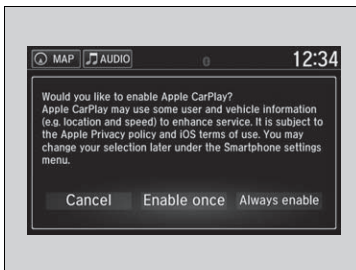

**Enable once:** Allows only once. (Prompt shows again next time.)

**Always enable:** Allows anytime. (Prompt does not show again.)

**Cancel:** Does not allow this consent.

You may change the consent settings under the **Smartphone** settings menu.

## ▶▶ Apple CarPlay™

### Apple CarPlay™ Operating Requirements & Limitations

Apple CarPlay™ requires a compatible iPhone with an active cellular connection and data plan. Your carrier's rate plans will apply.

Changes in operating systems, hardware, software, and other technology integral to providing Apple CarPlay™ functionality, as well as new or revised governmental regulations, may result in a decrease or cessation of Apple CarPlay™ functionality and services. Honda cannot and does not provide any warranty or guarantee of future Apple CarPlay™ performance or functionality.

It is possible to use 3rd party apps if they are compatible with Apple CarPlay™. Refer to the Apple homepage for information on compatible apps.

### ▶▶ Setting Up Apple CarPlay™

You can also use the method below to set up Apple CarPlay™:  
Select HOME→Settings→Smartphone→Apple CarPlay

### Use of user and vehicle information

The use and handling of user and vehicle information transmitted to/from your iPhone by Apple CarPlay™ is governed by the Apple iOS terms and conditions and Apple's Privacy Policy.

## ■ Operating Apple CarPlay™ with Siri® Eyes Free

Press and hold the  (Talk) button to activate Siri® Eyes Free.



## ▣ Operating Apple CarPlay™ with Siri® Eyes Free

Below are examples of questions and commands for Siri® Eyes Free.

- What movies are playing today?
- Call dad at work.
- What song is this?
- How's the weather tomorrow?
- Read my latest email.
- Find a table for four tonight in Chicago.

For more information, please visit [www.apple.com/ios/siri](http://www.apple.com/ios/siri).

## Android Auto™

When you connect an Android phone to the Display Audio system via the 1.5A USB port, Android Auto™ is automatically initiated. When connected via Android Auto™, you can use the audio/information screen to access the Phone, Google Maps (Navigation), Google Play Music, and Google Now functions. When you first use Android Auto™, a tutorial will appear on the screen.

We recommend that you complete this tutorial while safely parked before using Android Auto™.

📄 **USB Port(s)** P. 219

📄 **Auto Pairing Connection** P. 308

### NOTE:

Android Auto™ may not be available in your country or region. For details about Android Auto™, please refer to the Google support site.

### 📄 Android Auto™

To use Android Auto™, you need to download the Android Auto™ app from Google Play to your smartphone.

Only Android 5.0 (Lollipop) or later versions are compatible with Android Auto™. Bluetooth A2DP cannot be used with Android Auto™ phone.

Park in a safe place before connecting your Android phone to Android Auto™ and when launching any compatible apps.

To use Android Auto™, connect the USB cable to the 1.5A USB port. The USB port on the back of the console compartment will not enable Android Auto™ operation.

📄 **USB Port(s)** P. 219

When your Android phone is connected to Android Auto™, it is not possible to use the *Bluetooth*® Audio. However, other previously paired phones can stream audio via *Bluetooth*® while Android Auto™ is connected.

📄 **Phone Setup** P. 423

## Android Auto™ Menu

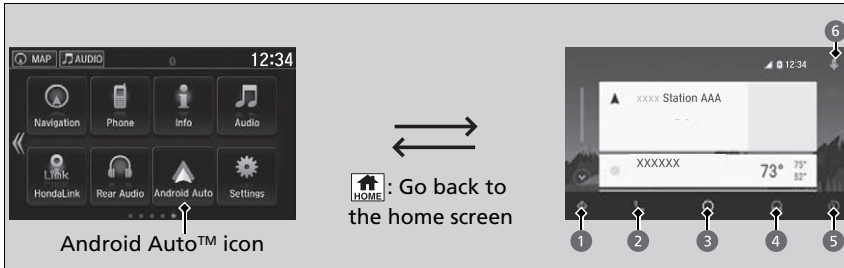

### 1 Maps (Navigation)

Display Google Maps and use the navigation function just as you would with your Android phone. When the vehicle is in motion, it is not possible to make keyboard entries. Stop the vehicle in a safe location to undertake a search or provide other inputs.

#### Models with navigation system

Only one navigation system (pre-installed navigation or Android Auto™) can give directions at a time. When you are using one system, directions to any prior destination set on the other system will be canceled, and the system you are currently using will direct you to your destination. The audio/information screen shows you turn-by-turn driving directions to your destination.

### 2 Phone (Communication)

Make and receive phone calls as well as listen to voicemail.

### 3 Google Now (Home screen)

Display useful information organized by Android Auto™ into simple cards that appear just when they're needed.

## Android Auto™

For details on countries and regions where Android Auto™ is available, as well as information pertaining to function, refer to the Android Auto™ homepage.

### Android Auto™ Operating Requirements & Limitations

Android Auto™ requires a compatible Android phone with an active cellular connection and data plan. Your carrier's rate plans will apply.

Changes in operating systems, hardware, software, and other technology integral to providing Android Auto™ functionality, as well as new or revised governmental regulations, may result in a decrease or cessation of Android Auto™ functionality and services. Honda cannot and does not provide any warranty or guarantee of future Android Auto™ performance or functionality.

It is possible to use 3rd party apps if they are compatible with Android Auto™. Refer to the Android Auto™ homepage for information on compatible apps.

#### 4 Music and audio

Play Google Play Music and music apps that are compatible with Android Auto™. To switch between music apps, press this icon.

#### 5 Go back to the Home Screen.

#### 6 Voice

Operate Android Auto™ with your voice.

### Auto Pairing Connection

When you connect an Android phone to the unit via the 1.5A USB port, Android Auto™ is automatically initiated.

#### Enabling Android Auto™

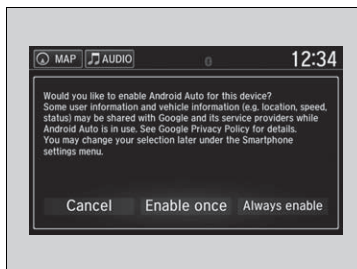

**Enable once:** Allows only once. (Prompt shows again next time.)

**Always enable:** Allows anytime. (Prompt does not show again.)

**Cancel:** Does not allow this consent.

You may change the consent settings under the **Smartphone** settings menu.

#### Enabling Android Auto™

Only initialize Android Auto™ when you safely parked. When Android Auto™ first detects your phone, you will need to set up your phone so that auto pairing is possible. Refer to the instruction manual that came with your phone.

You can use the method below to change Android Auto™ settings after you have completed the initial setup:  
Select HOME→Settings→Smartphone→Android Auto

#### Use of user and vehicle information

The use and handling of user and vehicle information transmitted to/from your phone by Android Auto™ is governed by the Google's Privacy Policy.

## ■ Operating Android Auto™ with Voice Recognition

Press and hold the  (Talk) button to operate Android Auto™ with your voice.

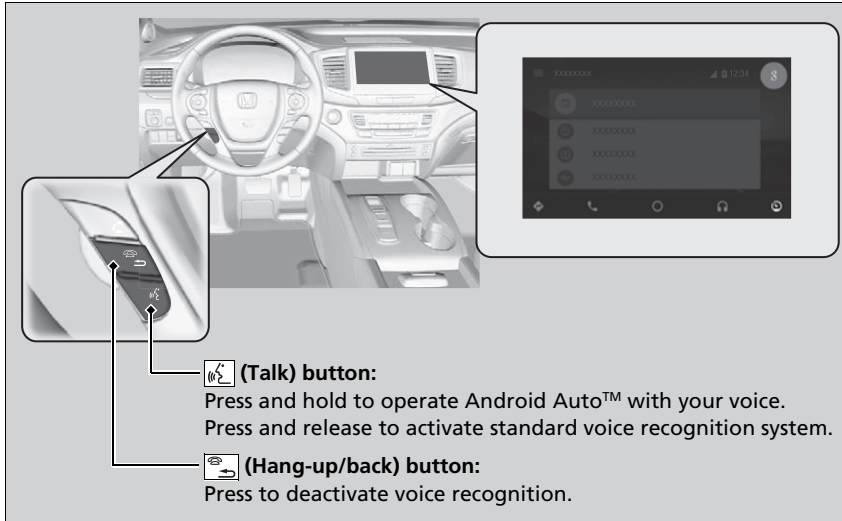

## ☒ Operating Android Auto™ with Voice Recognition

Below are examples of commands you can give with voice recognition:



- Reply to text.
- Call my wife.
- Navigate to Honda.
- Play my music.
- Send a text message to my wife.
- Call flower shop.

For more information, please refer to the Android Auto™ homepage.

You can also activate the voice recognition function by pressing the  icon in the upper-right corner of the screen.

## CD Player\*

If a disc error occurs, you may see the following error messages.

Error Message	Cause	Solution
<b>Unplayable File</b>	Track/file format not supported	<ul style="list-style-type: none"> <li>• Current track/file will be skipped. The next supported track/file plays automatically.</li> </ul>
<b>Bad Disc Please check Owner's Manual Please push eject button</b>	Mechanical error	<ul style="list-style-type: none"> <li>• Press the  (eject) button and remove the disc, and check that the error message is cleared.</li> <li>• Check that the disc is not damaged or deformed, and insert the disc again.</li> </ul>
<b>Mecha Error</b>		<ul style="list-style-type: none"> <li>•  <b>Protecting CDs</b> P. 316</li> </ul>
<b>Bad Disc Please Check Owner's Manual</b>	Servo error	<ul style="list-style-type: none"> <li>• If the error message reappears, press the  button, and pull out the disc.</li> <li>• Insert a different disc. If the new disc plays, there is a problem with the first disc.</li> <li>• If the error message repeats, or the disc cannot be removed, contact a dealer. Do not try to force the disc out of the player.</li> </ul>
<b>Check Disc</b>		Disc error
<b>Heat Error</b>	High temperature	<ul style="list-style-type: none"> <li>• Turn the audio system off and allow the player to cool down until the error message is cleared.</li> </ul>

## iPod/USB Flash Drive

If an error occurs while playing an iPod or USB flash drive, you may see the following error messages. If you cannot clear the error message, contact a dealer.

Error Message	Solution
<b>USB Error</b>	Appears when there is a problem with the audio system. Check if the device is compatible with the audio system.
<b>Bad USB Device</b> <sup>*1</sup> <b>The connected USB device has a problem.</b> <b>See Owner's Manual</b> <sup>*2</sup>	Appears when an incompatible device is connected. Disconnect the device. Then turn the audio system off, and turn it on again. Do not reconnect the device that caused the error.
<b>Unsupported Ver</b> <sup>*1</sup> <b>Unsupported Version</b> <sup>*2</sup>	Appears when an unsupported iPod is connected. If it appears when a supported iPod is connected, update the iPod software to the newer version.
<b>Connect Retry</b> <sup>*2</sup>	Appears when the system does not acknowledge the iPod. Reconnect the iPod.
<b>Unplayable File</b>	Appears when the files in the USB flash drive are DRM or an unsupported format. This error message appears for about three seconds, then plays the next song.
<b>No Data</b>	<b>iPod</b> Appears when the iPod is empty.
	<b>USB flash drive</b> Appears when the USB flash drive is empty or there are no MP3, WMA, or AAC files in the USB flash drive.
	<b>iPod and USB flash drive</b> Check that compatible files are stored on the device.
<b>Unsupported Ver</b> <sup>*1</sup> <b>Unsupported</b> <sup>*2</sup>	Appears when an unsupported device is connected. If it appears when a supported device is connected, reconnect the device.

\*1:Models with color audio system

\*2:Models with Display Audio



## Pandora®\*

If an error occurs while playing Pandora®, you may see the following error messages. If you cannot clear the error message, contact a dealer.

Error Message	Solution
<b>To begin listening, select a station from the Stations list.</b>	Appears when there is no station list on the device. Use the device to create a station.
<b>Unable to rate track. Please try again. Skip limit reached.</b>	Appears when you try to skip a song or select <b>Like/Dislike</b> over the predetermined number of times in an hour.
<b>Unable to play Pandora. Please try again later. Unable to retrieve a track explanation. Please try again later. Unable to create bookmark. Please try again later.</b>	Appears when the commanded operation is failed. Try again later.
<b>No Data</b>	Appears when no data is available with Pandora® activated. Reboot the app and reconnect the device.
<b>Pandora App version is not supported</b>	Appears when Pandora® version is not supported. Update Pandora® to the latest version.
<b>Unable to complete the operation. Please try again later.</b>	Appears when the Pandora® server is in maintenance. Try again later.
<b>Unable to connect Pandora. When stopped, check your mobile phone</b>	Appears when Pandora® is unable to play music. Check your device.
<b>Unable to connect Pandora. When stopped, check your mobile phone</b>	Appears when Pandora® app is not installed on your device. Install Pandora® app to the your device.

## Android/Apps\*

If an error occurs while using the audio system or apps, you may see the following error messages. If you cannot clear the error message, contact a dealer.

Error Message	Solution
Unfortunately, **** has stopped.	Error has occurred within app, select <b>OK</b> on the screen to close the app.
**** is not responding. Would you like to close it?	App is not responding. Select <b>Wait</b> if you can wait for a response from app a little longer. If it does not respond even if you keep waiting, select <b>OK</b> to close the app and start it up. If the error message continues, perform <b>Factory Data Reset</b> . ➤ <b>Defaulting All the Settings</b> P. 386

\*1:\*\*\*\*part is variable characters, and will change depending upon where an error occurs.

## SiriusXM® Radio Service\*

### ■ Subscribing to SiriusXM® Radio

1. You need your radio ID ready before registering for subscription. To see the ID in the screen, select **Channel** to 0.
2. Have your radio ID ready, and either call or visit the SiriusXM® website to subscribe.

### ■ Receiving SiriusXM® Radio

Switch to the SiriusXM® mode by using the **SOURCE** button on the steering wheel, or through the audio/information screen, and stay in this mode for about 30 minutes until the service is activated. Make sure your vehicle is in an open area with good reception.

### ■ SiriusXM® Radio Display Messages

#### **Channel Not Subscribed:**

You are not subscribed to the channel selected.

#### **Subscription Update:**

SiriusXM® radio is receiving information update from the network.

#### **Channel Not Available:**

No such channel exists, or the artist or title information is unavailable.

#### **No Signal:**

The signal is too weak in the current location.

#### **Antenna Disconnected:**

The SiriusXM® antenna is disconnected. Contact a dealer.

### ☒ Subscribing to SiriusXM® Radio

Contact Information for SiriusXM® Radio:

- US: SiriusXM® Radio at [www.siriusxm.com](http://www.siriusxm.com) or 1-800-852-9696
- Canada: SiriusXM® Canada at [www.siriusxm.ca](http://www.siriusxm.ca), or 1-877-209-0079

### ☒ Receiving SiriusXM® Radio

The SiriusXM® satellites are in orbit over the equator; therefore, objects south of the vehicle may cause satellite reception interruptions. Satellite signals are more likely to be blocked by tall buildings and mountains the farther north you travel from the equator.

You may experience reception problems under the following circumstances:

- In a location with an obstruction to the south of your vehicle.
- In tunnels
- On the lower level of a multi-tiered road
- Large items carried on the roof rack

## Recommended CD\*

- Use only high-quality CD-R or CD-RW discs labeled for audio use.
- Use only CD-R or CD-RW discs on which the recordings are closed.
- Play only standard round-shaped CDs.

The CD packages or jackets should have one of these marks.



### CDs with MP3, WMA or AAC files

- Some software files may not allow for audio play or text data display.
- Some versions of MP3, WMA or AAC formats may be unsupported.

### Recommended CD\*

A Dual-disc cannot play on this audio unit. If recorded under certain conditions, a CD-R or CD-RW may not play either.

\* Not available on all models

*Continued*

## ■ Protecting CDs

Follow these precautions when handling or storing CDs:

- Store a CD in its case when it is not being played.
- When wiping a CD, use a soft clean cloth from the center to the outside edge.
- Handle a CD by its edge. Never touch either surface.
- Never insert foreign objects into the CD player.
- Keep CDs out of direct sunlight and extreme heat.
- Do not place stabilizer rings or labels on the CD.
- Avoid fingerprints, liquids, and felt-tip pens on the CD.

## ▶▶ Protecting CDs

### NOTICE

Do not insert a damaged CD. It may be stuck inside and damage the audio unit.

#### Examples:

- Bubbled, wrinkled, labeled, and excessively thick CDs



Bubbled/  
Wrinkled



With Label/  
Sticker



Using  
Printer Label  
Kit



Sealed



With Plastic Ring

- Damaged CDs



Chipped/  
Cracked

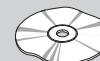

Warped

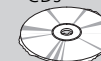

Burrs

- Poor quality CDs

- Small CDs



3-inch  
(8-cm)  
CD

## Compatible iPod, iPhone, and USB Flash Drives

### ■ iPod and iPhone Model Compatibility

Model
iPod (5th generation)
iPod classic 80GB/160GB (launch in 2007)
iPod classic 120GB (launch in 2008)
iPod classic 160GB (launch in 2009)
iPod nano (1st to 7th generation) launch in 2010
iPod touch (1st to 4th generation) launch in 2010
iPhone 3G/iPhone 3GS/iPhone 4/iPhone 4s/iPhone 5/iPhone 5c* <sup>1</sup> /iPhone 5s* <sup>1</sup> / iPhone 6* <sup>1</sup> /iPhone 6 Plus* <sup>1</sup> /iPhone 6s* <sup>1</sup> /iPhone 6s Plus* <sup>1</sup>

\*1: Models with Display Audio

### ■ USB Flash Drives

- A USB flash drive of 256 MB or higher is recommended.
- Some digital audio players may not be compatible.
- Some USB flash drives (e.g., a device with security lockout) may not work.
- Some software files may not allow for audio play or text data display.
- Some versions of MP3, WMA, or AAC formats may be unsupported.

#### ☒ iPod and iPhone Model Compatibility

This system may not work with all software versions of these devices.

#### ☒ USB Flash Drives

Files on the USB flash drive are played in their stored order. This order may be different from the order displayed on your PC or device.

Models with Display Audio

## Legal Information on Apple CarPlay™/Android Auto™

---

### OWNER'S MANUAL LICENSE/LIABILITY STATEMENTS

USE OF APPLE CARPLAY IS SUBJECT TO YOUR AGREEMENT TO THE CARPLAY TERMS OF USE, WHICH ARE INCLUDED AS PART OF THE APPLE iOS TERMS OF USE. IN SUMMARY, THE CARPLAY TERMS OF USE DISCLAIM APPLE AND ITS SERVICE PROVIDERS' LIABILITY IF THE SERVICES FAIL TO PERFORM CORRECTLY OR ARE DISCONTINUED, STRICTLY LIMIT APPLE AND ITS SERVICE PROVIDERS' OTHER LIABILITIES, DESCRIBE THE KINDS OF USER INFORMATION (INCLUDING, FOR EXAMPLE, VEHICLE LOCATION, VEHICLE SPEED, AND VEHICLE STATUS) BEING GATHERED AND STORED BY APPLE AND ITS SERVICE PROVIDERS, AND DISCLOSE CERTAIN POSSIBLE RISKS ASSOCIATED WITH THE USE OF CARPLAY, INCLUDING THE POTENTIAL FOR DRIVER DISTRACTION. SEE APPLE'S PRIVACY POLICY FOR DETAILS REGARDING APPLE'S USE AND HANDLING OF DATA UPLOADED BY CARPLAY.

USE OF ANDROID AUTO IS SUBJECT TO YOUR AGREEMENT TO THE ANDROID AUTO TERMS OF USE WHICH MUST BE AGREED TO WHEN THE ANDROID AUTO APPLICATION IS DOWNLOADED TO YOUR ANDROID PHONE. IN SUMMARY, THE ANDROID AUTO TERMS OF USE DISCLAIM GOOGLE AND ITS SERVICE PROVIDERS' LIABILITY IF THE SERVICES FAIL TO PERFORM CORRECTLY OR ARE DISCONTINUED, STRICTLY LIMIT GOOGLE AND ITS SERVICE PROVIDERS' OTHER LIABILITIES, DESCRIBE THE KINDS OF USER INFORMATION (INCLUDING, FOR EXAMPLE, VEHICLE LOCATION, VEHICLE SPEED, AND VEHICLE STATUS) BEING GATHERED AND STORED BY GOOGLE AND ITS SERVICE PROVIDERS, AND DISCLOSE CERTAIN POSSIBLE RISKS ASSOCIATED WITH THE USE OF ANDROID AUTO, INCLUDING THE POTENTIAL FOR DRIVER DISTRACTION. SEE GOOGLE'S PRIVACY POLICY FOR DETAILS REGARDING GOOGLE'S USE AND HANDLING OF DATA UPLOADED BY ANDROID AUTO.

## DISCLAIMER OF WARRANTIES; LIMITATION ON LIABILITY

YOU EXPRESSLY ACKNOWLEDGE AND AGREE THAT USE OF APPLE CARPLAY OR ANDROID AUTO (“THE APPLICATIONS”) IS AT YOUR SOLE RISK AND THAT THE ENTIRE RISK AS TO SATISFACTORY QUALITY, PERFORMANCE, ACCURACY AND EFFORT IS WITH YOU TO THE MAXIMUM EXTENT PERMITTED BY APPLICABLE LAW, AND THAT THE APPLICATIONS AND INFORMATION ON THE APPLICATIONS IS PROVIDED “AS IS” AND “AS AVAILABLE,” WITH ALL FAULTS AND WITHOUT WARRANTY OF ANY KIND, AND HONDA HEREBY DISCLAIMS ALL WARRANTIES AND CONDITIONS WITH RESPECT TO THE APPLICATIONS AND INFORMATION ON THE APPLICATIONS, EITHER EXPRESS, IMPLIED OR STATUTORY, INCLUDING, BUT NOT LIMITED TO, THE IMPLIED WARRANTIES AND/OR CONDITIONS OF MERCHANTABILITY, SATISFACTORY QUALITY, FITNESS FOR A PARTICULAR PURPOSE, ACCURACY, QUIET ENJOYMENT, AND NON-INFRINGEMENT OF THIRD PARTY RIGHTS. NO ORAL OR WRITTEN INFORMATION OR ADVICE GIVEN BY HONDA OR AN AUTHORIZED REPRESENTATIVE SHALL CREATE A WARRANTY. AS EXAMPLES, AND WITHOUT LIMITATION, HONDA DISCLAIMS ANY WARRANTY REGARDING THE ACCURACY OF DATA PROVIDED BY THE APPLICATIONS, SUCH AS THE ACCURACY OF DIRECTIONS, ESTIMATED TRAVEL TIME, SPEED LIMITS, ROAD CONDITIONS, NEWS, WEATHER, TRAFFIC, OR OTHER CONTENT PROVIDED BY APPLE, GOOGLE, THEIR AFFILIATES, OR THIRD PARTY PROVIDERS; HONDA DOES NOT GUARANTEE AGAINST LOSS OF APPLICATION DATA, WHICH MAY BE LOST AT ANY TIME; HONDA DOES NOT GUARANTEE THAT THE APPLICATIONS OR ANY SERVICES PROVIDED THROUGH THEM WILL BE PROVIDED AT ALL TIMES OR THAT ANY OR ALL SERVICES WILL BE AVAILABLE AT ANY PARTICULAR TIME OR LOCATION. FOR EXAMPLE, SERVICES MAY BE SUSPENDED OR INTERRUPTED WITHOUT NOTICE FOR REPAIR, MAINTENANCE, SECURITY FIXES, UPDATES, ETC., SERVICES MAY BE UNAVAILABLE IN YOUR AREA OR LOCATION, ETC. IN ADDITION, YOU UNDERSTAND THAT CHANGES IN THIRD PARTY TECHNOLOGY OR GOVERNMENT REGULATION MAY RENDER THE SERVICES AND/OR APPLICATIONS OBSOLETE AND/OR UNUSABLE.

TO THE EXTENT NOT PROHIBITED BY LAW, IN NO EVENT SHALL HONDA OR ITS AFFILIATES BE LIABLE FOR PERSONAL INJURY, OR ANY INCIDENTAL, SPECIAL, INDIRECT OR CONSEQUENTIAL DAMAGES WHATSOEVER, INCLUDING, WITHOUT LIMITATION, DAMAGES FOR LOSS OF PROFITS, CORRUPTION OR LOSS OF DATA, FAILURE TO TRANSMIT OR RECEIVE ANY DATA, BUSINESS INTERRUPTION OR ANY OTHER COMMERCIAL DAMAGES OR LOSSES, ARISING OUT OF OR RELATED TO THE APPLICATIONS OR YOUR USE OF OR INABILITY TO USE THE APPLICATIONS OR INFORMATION ON THE APPLICATIONS, HOWEVER CAUSED, REGARDLESS OF THE THEORY OF LIABILITY (CONTRACT, TORT OR OTHERWISE) AND EVEN IF HONDA WERE ADVISED OF THE POSSIBILITY OF SUCH DAMAGES. SOME STATES AND JURISDICTIONS DISALLOW THE EXCLUSION OR LIMITATION OF LIABILITY FOR DAMAGES, SO THESE LIMITATIONS AND EXCLUSIONS MAY NOT APPLY TO YOU. IN NO EVENT SHALL HONDA’S TOTAL LIABILITY TO YOU FOR ALL DAMAGES (OTHER THAN AS MAY BE REQUIRED BY APPLICABLE LAW IN CASES INVOLVING PERSONAL INJURY) EXCEED THE AMOUNT OF FIVE DOLLARS (\$5.00). THE FOREGOING LIMITATIONS WILL APPLY EVEN IF THE ABOVE STATED REMEDY FAILS OF ITS ESSENTIAL PURPOSE.



Models with Display Audio

## About Open Source Licenses

---

To see the open source license information, follow these steps.

1. Select .
2. Select **Settings**.
3. Select **System**, then open the **Others** tab.
4. Select **Detail Information**.
5. Select **About device**.
6. Select **Legal information**.
7. Select **Open source licenses**.

## License Information\*

### DOLBY DIGITAL

Manufactured under license from Dolby Laboratories. Dolby and the double-D symbol are registered trademarks of Dolby Laboratories.



### DTS

For DTS patents, see <http://patents.dts.com>. Manufactured under license from DTS Licensing Limited. DTS, the Symbol, & DTS and the Symbol together are registered trademarks, and DTS Digital Surround and Neural Surround are trademarks of DTS, Inc. © DTS, Inc. All Rights Reserved.



Rear seat passengers can enjoy a completely separate entertainment source than front passengers, including movies, games, and other audio choices.

## Wireless Headphones

The rear seat passengers can listen to audio from the Blu-ray/DVD rear entertainment system by a wireless headphone that comes with your vehicle.

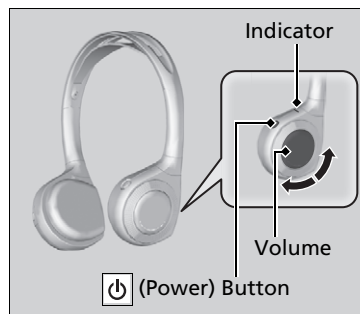

**To turn on the switch:** Press the  (Power) button at the right earpiece. The indicator comes on.

**To adjust the volume:** Turn the dial at the right earpiece.

### Blu-ray/DVD Rear Entertainment System\*

Blu-ray Disc™, Blu-ray™, AVCREC™, and the logos are trademarks of the Blu-ray Disc Association.

### Wireless Headphones

Your vehicle comes with two wireless headphones.

Wear the headphone correctly with the earpiece marked with L goes to your left ear and R goes to your right ear. Wearing the headphone backward may affect the audio reception.

## Auxiliary Console Panel

Auxiliary input jacks and headphone connectors for the Blu-ray/DVD rear entertainment system are on the back of the center console compartment.



V = Video jack

L = Left audio jack

R = Right audio jack

### ■ Auxiliary Input Jacks

The system will accept auxiliary inputs from standard video games and video equipment. Some video game power supplies may cause poor picture quality.

### ■ Headphone Connector

The headphones can also be used by connecting to the auxiliary console panel. There are two headphone connectors for the rear passengers. Each connector has its own volume control.

## USB Ports\*



There are two USB ports on the back of the center console compartment. The system will charge a device.

### ▶▶ USB Ports\*

The USB port can supply up to 2.5A of power. It does not output 2.5A unless the device requests. For amperage details, read the operating manual of the device that needs to be charged. The rear USB ports are for charging only.

## HDMI™ Port

There is an HDMI™ port on the back of the center console compartment. The Blu-ray/DVD rear entertainment system will accept HDMI™ port from video games and video equipment which are equipped with an HDMI™ port.



Open the outlet cover and insert the cable.

### ▶▶ HDMI™ Port

The terms HDMI and HDMI High-Definition Multimedia Interface, and the HDMI Logo are trademarks or registered trademarks of HDMI Licensing LLC in the United States and other countries.

The HDMI port is for use with the Blu-ray/DVD rear entertainment system only.

## Overhead Screen

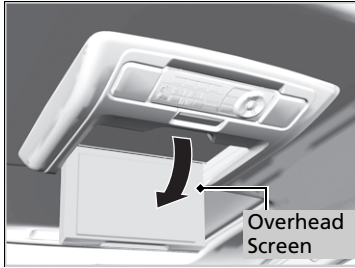

Pull down the screen to the first or second detent until it latches.

## Operating the System

To operate the system, set the power mode to ON or ACCESSORY. Press the **REAR**  (power) button to turn on the system. This also turns the audio ON in the front screen.

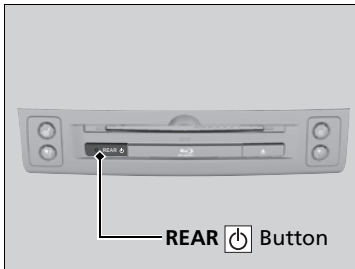

### Overhead Screen

You can use the rear control panel as a remote. Press the lock tab to detach it.

## Playing a DVD/Blu-ray™\*

To play a DVD or Blu-ray™\*, insert a DVD or Blu-ray™\* into the lower slot of the front audio system, and press the **REAR**  button.

- ▶ The system automatically starts the DVD or Blu-ray™\*. DVD or Blu-ray™\* is available for the rear seat passenger only.

### System Controls

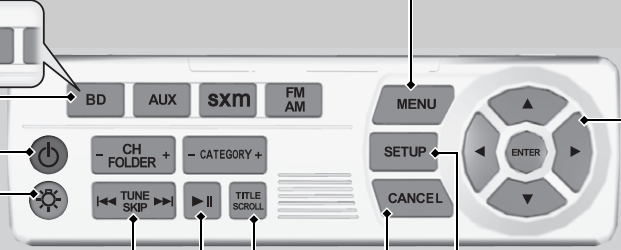



**(Power) Button**  
Press to turn on or off the rear display.

**DVD\* or BD\* Button**  
Press to watch a DVD or Blu-ray™\*.

**MENU Button**  
Press to display the menu items.

**(Light) Button**  
Press to illuminate the buttons and bars for a few seconds.

**TUNE/SKIP Bar**  
Press  or  to change chapters.

**(Play/Pause) Button**  
Press to pause or play a DVD or Blu-ray™\*.

**▲, ▼, ►, ◀ and ENTER Buttons**  
Use ▲, ▼, ►, or ◀ to highlight a menu item, and press the **ENTER** button to make a selection.

**SETUP Button**  
Press to display the setup items.

**CANCEL Button**  
Press to go back to the previous display or operation.

**TITLE/SCROLL Button**  
Press to display the status of the DVD or Blu-ray™\* that is currently playing.

**BD** **AUX** **SXM** **FM AM**

**CH FOLDER +** **- CATEGORY +**

**TUNE SKIP** **||** **TITLE SCROLL**

**MENU** **ENTER** **SETUP** **CANCEL**

## Rear DVD or Blu-ray™\* Menu

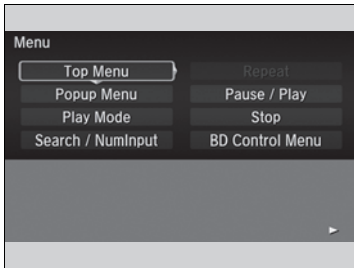

1. Press the **MENU** button on the remote to display the **Menu** screen.
2. Select an item and then press the **ENTER** button on the remote.

The following items are available:

- **Top Menu:** Displays the top menu of the DVD or Blu-ray™\*.
- **Popup Menu:** Displays the menu of the Blu-ray™\*.
- **Play Mode:** Displays while a DVD or Blu-ray™\* is playing and changes the DVD or Blu-ray™\* preferences.
  - ▶ **Setting the Play Mode** P. 328
- **Search / NumInput:** Skips to a title or chapter by entering the number.
  - ▶ **Searching a Title/Chapter** P. 329
- **Repeat:**
  - TITLE REPEAT: Repeats the current title.
  - CHAPTER REPEAT: Repeats the current chapter.
- **Menu** (When playing a DVD): Displays the menu.
- **Pause / Play:** Pauses or resumes the playback.
- **Stop:** Stops the playback.
- **Return** (When playing a DVD): Returns to the previous screen.
- **BD Control Menu** (When playing a Blu-ray™): Displays the Blu-ray™ control menu.

\* Not available on all models

*Continued*

### ▶▶ Rear DVD or Blu-ray™\* Menu

During Blu-ray™ operation, when the source is changed or the vehicle is turned off, Blu-ray™ operation stops. For certain Blu-ray™ discs, it can only be restarted from the RES.



If you press the **MENU** button on the remote while the DVD or Blu-ray™\* is not playing, the option **Play Mode** changes to **Initial Settings**.

➤ **Initial Settings** P. 334

## ■ Setting the Play Mode

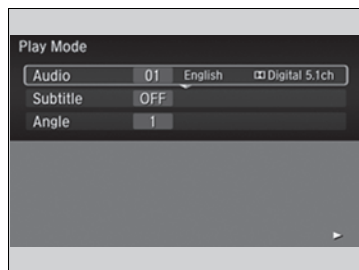

1. Press the **MENU** button on the remote to display the **Menu** screen.
2. Select **Play Mode**.
3. Select an item and then press the **ENTER** button on the remote.

The following items are available:

- **Audio**: Selects the language of the DVD audio.
- **Subtitle**: Selects the language of the DVD subtitle.
- **Angle**: Selects the angle of the scene shot with multiple cameras.

## ■ Searching a Title/Chapter

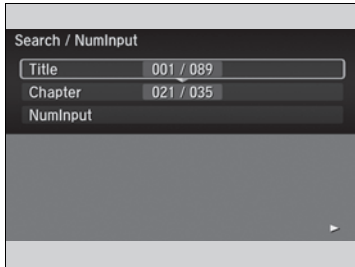

1. Press the **MENU** button on the remote to display the **Menu** screen.
2. Select **Search / Numinput**.
3. Select an item and then press the **ENTER** button on the remote.

The following items are available:

- **Title:** Skips to a title you specify.
- **Chapter:** Skips to a chapter you specify.
- **NumInput:** Enters a number of a title or chapter to skip.

## ■ Screen and Surround Settings

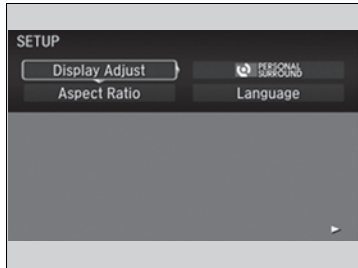

1. Press the **SETUP** button on the remote to display the **SETUP** screen.
2. Select an item and then press the **ENTER** button on the remote.

The following items are available:

- **Display Adjust:** Adjusts the screen's preferences.
  - ▶ **Adjusting the Screen** P. 331
- **Aspect Ratio:** Selects an aspect ratio of the image.
  - ▶ **Setting the Aspect Ratio** P. 332
- **PERSONAL SURROUND:** Sets the surround of the wireless headphones.
  - ▶ **Setting the Personal Surround** P. 332
- **Language:** Sets the system language used on all screens.
  - ▶ **Setting the Language** P. 333

After you make all the adjustments, the screen goes back to the top SETUP screen, or press the **CANCEL** button to return.

## ■ Adjusting the Screen



1. Press the **SETUP** button on the remote to display the **SETUP** screen.
2. Select **Display Adjust** and then press the **ENTER** button on the remote.
3. Select the setting you want.

The following items are available:

- **Brightness:** Adjusts the screen's brightness.
- **Contrast:** Adjusts the screen's contrast.
- **Black Level:** Adjusts the screen's black level.
- **Color:** Adjusts the screen's color strength.
- **Tint:** Adjusts the screen's hue.
- **Reset:** Resets all the settings to their factory default.

## ■ Setting the Aspect Ratio

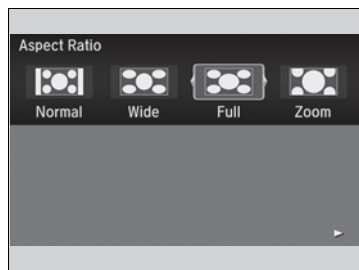

1. Press the **SETUP** button on the remote to display the **SETUP** screen.
2. Select **Aspect Ratio** and then press the **ENTER** button on the remote.
3. Select the setting you want.
  - ▶ You can select the four options; **Normal**, **Wide**, **Full**, or **Zoom**.

## ■ Setting the Personal Surround

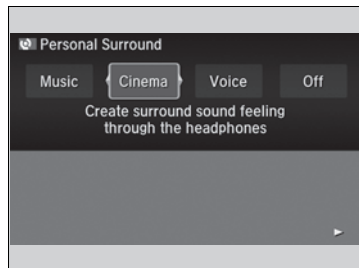

1. Press the **SETUP** button on the remote to display the **SETUP** screen.
2. Select **PERSONAL SURROUND** and then press the **ENTER** button on the remote.
3. Select the setting you want.
  - ▶ You can select the options from **Music**, **Cinema**, or **Voice**. Select **Off** to disable the feature.

## ■ Setting the Language

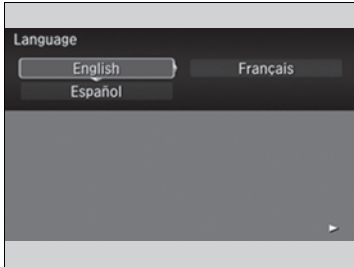

1. Press the **SETUP** button on the remote to display the **SETUP** screen.
2. Select **Language** and then press the **ENTER** button on the remote.
3. Select the setting you want.
  - ▶ You can select the language from **English**, **French**, or **Spanish**.

## ■ Initial Settings

You can configure the initial Language, Dynamic Range, and Angle Mark settings before playing a DVD or Blu-ray™\*.

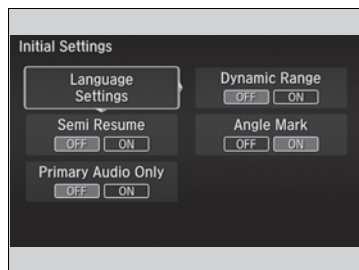

1. Press the **MENU** button on the remote to display the **Menu** screen.
2. Select **Initial Settings** and then press the **ENTER** button on the remote.

The following items are available:

- **Language Settings:** Selects the language for the DVD's or Blu-ray™\*'s displayed menus (Menu Language), the DVD's or Blu-ray™\*'s audio (Audio Language), and the DVD's or Blu-ray™\*'s subtitle (Subtitle Language).  
 **Language Settings** P. 335
- **Dynamic Range:** The feature reduces the difference between the loud and quiet sound levels. Select **ON** or **OFF**.
- **Angle Mark:** You can select whether to display the angle mark appearing in the upper right corner of the screen when you change the view angle while the DVD or Blu-ray™\* is playing. Select **ON** or **OFF**.

## ■ Language Settings

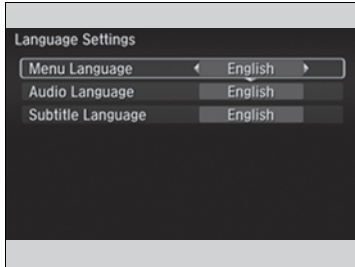

1. Press the **MENU** button on the remote to display the **Menu** screen.
2. Select **Initial Settings** and then press the **ENTER** button on the remote.
3. Select an item and then press the **ENTER** button on the remote.
4. Select a language and then press the **ENTER** button on the remote.

Language Settings from other:

If you select **other**, you need to enter the four digit language code number to configure the language that is not listed.

1. Select **Yes** to go to the number input screen.
  - ▶ To return to the language setting screen, select **No**.
2. Press the **ENTER** button on the remote each time you input digit.
  - ▶ If you want to delete a number, select **DEL**.
3. The cursor automatically goes to **ENT** after you input four digits. Press the **ENTER** button on the remote to command.

### ☒ Language Settings

The prior language varies by disc. You may not be able to configure your selected language setting.

You can select the language from **English, French, Spanish, Arabic, German, Italian, Dutch, Russian, Chinese, Korean, Thai, Japanese**, and **other**.





## Front Control Panel Operation

You can operate the Blu-ray/DVD Rear Entertainment System (RES) from the front control panel.

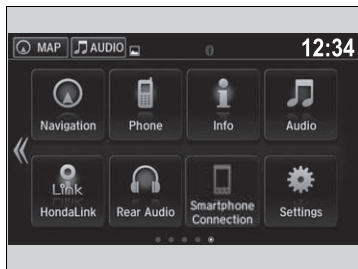
### Selecting the Audio Source using Front Control Panel



1. Press the **REAR**  button on the front panel if the power is off.
  - ▶ If you press this button while the system is operating, the system is turned off.
2. Select .
3. Select **Rear Audio**.

### Operating the Blu-ray/DVD rear entertainment system



When the Blu-ray/DVD rear entertainment system is operating, the screen on the front control panel will turn gray.

### Selecting the Audio Source using Front Control Panel

The **REAR**  button is located next to the DVD or Blu-ray™\* drive.

## Rear System Setup

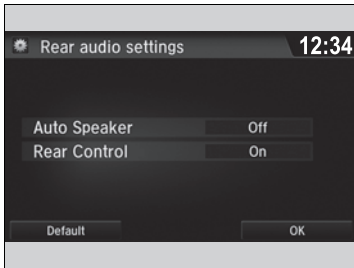

### ■ Auto speaker setting

Mutes the sounds from the rear speakers.

1. Select .
2. Select **Settings**.
3. Select **Rear Audio**.
4. Select **Auto Speaker**.
5. Select **On** or **Off**.

### ■ Rear control setting

Disables controls from the remote.

1. Select .
2. Select **Settings**.
3. Select **Rear Audio**.
4. Select **Rear Control**.
5. Select **On** or **Off**.

## ⊞ Rear System Setup

This function mutes the sound to the rear speakers when the Rear Audio system is operating. If the rear system is off the speakers work as normal.

## ■ Setting the DVD or Blu-ray™\* Menu

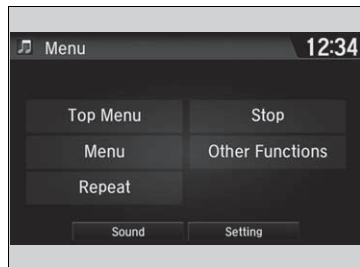

Select  while a DVD or Blu-ray™\* is playing.

- ▶ Select **Other Functions** to display additional menu entries.

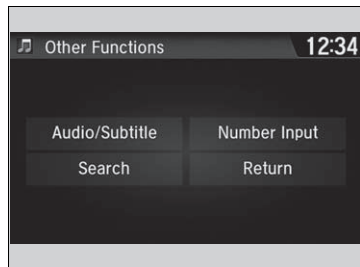

The following items are available on the front screen:

- **Top Menu:** Displays the top menu.
- **Menu:** Displays the menu.
- **Popup Menu** (only for Blu-ray™): Displays the menu of the Blu-ray™.
- **Stop:** Stop the playback.
- **Repeat:** Repeats the current title/chapter.
- **Audio/Subtitle:** Selects the language of the DVD audio and DVD subtitle.
- **Number Input** (only for DVD-V): Enters a number of a title or chapter to skip.
- **Search:** Skips to a title or chapter on the screen.
- **Return** (only for DVD-V): Hides the DVD menu.
- **Change Order** (only for DVD-VR and AVCREC): Changes the order of the program or playlist.
- **Audio Channel:** Changes the audio channel.
- **Angle Mark:** Changes the angle.

## Playing Audio

You can play a USB, iPod, auxiliary video (rear), or auxiliary audio (front) from the rear seats.

### System Controls

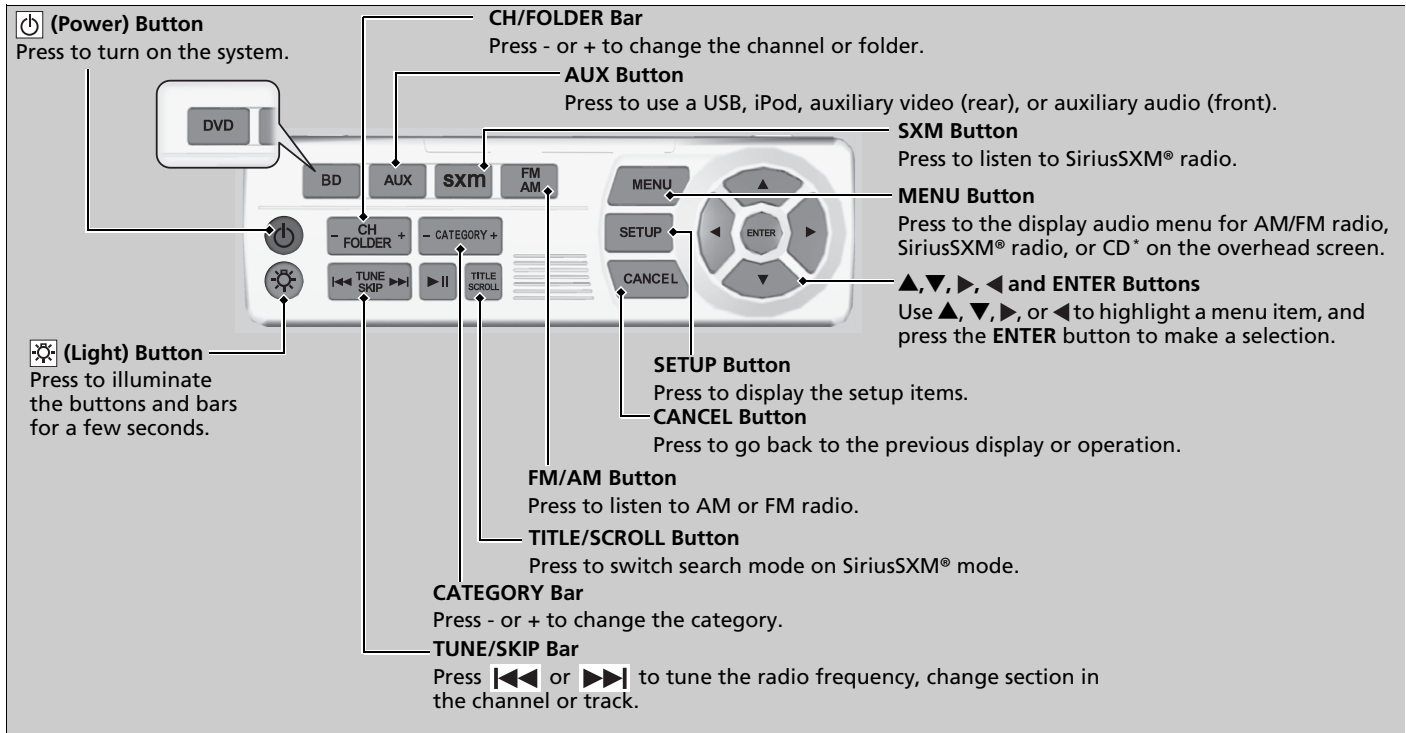

## ■ Playing AM/FM Radio in the Rear

To play the AM/FM radio, press the **AM/FM** button on the remote.

When you press the **MENU** button on the remote while the radio is playing, the audio menu appears on the overhead screen.

The available functions are the same as those of the front audio system. The **TUNE/SKIP** bar on the remote works the same as the Skip/Seek icons (<</>>) on the front touch screen for AM/FM radio operation.

📺 **Playing AM/FM Radio** P. 267

## ■ Playing SiriusXM® Radio in the Rear\*

To play the SiriusXM® radio, press the **SXM** button on the remote.

When you press the **MENU** button on the remote while the radio is playing, the audio menu appears on the overhead screen.

The available functions are the same as those of the front audio system. The **TUNE/SKIP** bar on the remote works the same as the Skip/Seek icons (<</>>) on the front touch screen for SiriusXM® radio operation.

📺 **Playing SiriusXM® Radio\*** P. 271

To change the mode between category and channel, press the **TITLE/SCROLL** button on the remote for five seconds.

### 📺 System Controls

You can operate the Blu-ray/DVD rear entertainment system on the front display.

## ■ Playing a Disc in the Rear

To play a disc, press the **DVD\*** or **BD\*** button on the remote.

When you press the **MENU** button on the remote while the radio is playing, the audio menu appears on the overhead screen.

The available options appear on the overhead screen are Repeat, Random, and Scan. These functions are the same as those of the front audio system.

➤ **Playing a CD\*** P. 278

To scroll you audio data title, press the **TITLE/SCROLL** button on the remote for five seconds.

## ■ Playing an iPod and a USB Flash Drive in the Rear

To play an iPod and a USB flash drive, press the **AUX** button on the remote.

When you press the **MENU** button on the remote while the iPod or USB flash drive is playing, the audio menu appears on the overhead screen.

The available options appear on the overhead screen are Repeat, Random, and Scan. These functions are the same as those of the front audio system.

➤ **Playing an iPod** P. 281

➤ **Playing a USB Flash Drive** P. 290

To scroll you audio data title, press the **TITLE/SCROLL** button on the remote for five seconds.

## Audio Sources for Front and Rear Seats

The table shows the possible audio source combinations of the front audio system and Blu-ray/DVD rear entertainment system's simultaneous use.

Front Rear	AM/FM Radio	SiriusXM® Radio*	CD	DVD* <sup>1</sup> Blu-ray™*,* <sup>1</sup>	USB iPod	Pandora®*
AM/FM Radio	Yes	Yes	Yes	Yes	Yes	Yes
SiriusXM® Radio	Yes	Yes	Yes	Yes	Yes	No
CD	Yes	Yes	Yes	Yes	Yes	Yes
DVD Blu-ray™*,* <sup>1</sup>	Yes	Yes	Yes	Yes	Yes	Yes
USB iPod	Yes	Yes	Yes	Yes	Yes	Yes

\*1: The front seat passengers are only able to hear the DVD's sound from the front speakers.

### Audio Sources for Front and Rear Seats

Yes: These audio sources are simultaneously playable. When listening to same source in both the front and rear, the playing channel or track will also be the same for each.

No: These audio sources are not simultaneously playable.

\* Not available on all models



## Playable Discs

The discs that come with these labels can be played in your vehicle's Blu-ray/DVD rear entertainment system.

Also look for the region code of 1, ALL,  or  on the package or jacket on the disc.

DVD-ROMs and Blu-ray™ ROMs (BD ROM)\* are not playable in this unit.

The disc packages or jackets should have one of these marks.



Also includes:



### ▶▶ Playable Discs

This product incorporates copyright protection technology that is protected by U.S. patents and other intellectual property rights.

Use of this copyright protection technology must be authorized by Rovi Corporation, and is intended for home and other limited viewing uses only unless otherwise authorized by Rovi Corporation. Reverse engineering and disassembly are prohibited.

For DTS patents, see <http://patents.dts.com>. Manufactured under license from DTS Licensing Limited. DTS, the Symbol, & DTS and the Symbol together are registered trademarks, and DTS Digital Surround is trademarks of DTS, Inc. © DTS, Inc. All Rights Reserved.

Manufactured under license from Dolby Laboratories. Dolby and the double-D symbol are trademarks of Dolby Laboratories.

"Blu-ray Disc™", "Blu-ray™", "AVCREC™", and the logos are trademarks of the Blu-ray Disc Association.

**■ Java**

Java is a registered trademark of Oracle and/or its affiliates.

**■ HDMI**

HDMI, the HDMI Logo, and High-Definition Multimedia Interface are trademarks or registered trademarks of HDMI Licensing LLC in the United States and other countries.

**■ Cinavia**

This product uses Cinavia technology to limit the use of unauthorized copies of some commercially-produced film and videos and their soundtracks. When a prohibited use of an unauthorized copy is detected, a message will be displayed and playback or copying will be interrupted.

More information about Cinavia technology is provided at Cinavia Online Consumer Information Center at <http://www.cinavia.com>. To request additional information about Cinavia by mail, send a postcard with your mailing address to: Cinavia Consumer Information Center, P.O. Box 86851, San Diego, CA, 92138, USA.

This product incorporates proprietary technology under license from Verance Corporation and is protected by U.S. Patent 7,369,677 and other U.S. and worldwide patents issued and pending as well as copyright and trade secret protection for certain aspects of such technology. Cinavia is a trademark of Verance Corporation. Copyright 2004-2012 Verance Corporation. All rights reserved by Verance. Reverse engineering or disassembly is prohibited.

■ **MPEG**

THIS PRODUCT IS LICENSED UNDER THE AVC PATENT PORTFOLIO LICENSE FOR THE PERSONAL AND NON-COMMERCIAL USE OF A CONSUMER TO (i) ENCODE VIDEO IN COMPLIANCE WITH THE AVC STANDARD (“AVC VIDEO”) AND/OR (ii) DECODE AVC VIDEO THAT WAS ENCODED BY A CONSUMER ENGAGED IN A PERSONAL AND NON-COMMERCIAL ACTIVITY AND/OR WAS OBTAINED FROM A VIDEO PROVIDER LICENSED TO PROVIDE AVC VIDEO. NO LICENSE IS GRANTED OR SHALL BE IMPLIED FOR ANY OTHER USE. ADDITIONAL INFORMATION MAY BE OBTAINED FROM MPEG LA, L.L.C. SEE [HTTP://WWW.MPEGLA.COM](http://www.mpegla.com)

THIS PRODUCT IS LICENSED UNDER THE VC-1 PATENT PORTFOLIO LICENSE FOR THE PERSONAL AND NON-COMMERCIAL USE OF A CONSUMER TO (i) ENCODE VIDEO IN COMPLIANCE WITH THE VC-1 STANDARD (“VC-1 VIDEO”) AND/OR (ii) DECODE VC-1 VIDEO THAT WAS ENCODED BY A CONSUMER ENGAGED IN A PERSONAL AND NON-COMMERCIAL ACTIVITY AND/OR WAS OBTAINED FROM A VIDEO PROVIDER LICENSED TO PROVIDE VC-1 VIDEO. NO LICENSE IS GRANTED OR SHALL BE IMPLIED FOR ANY OTHER USE. ADDITIONAL INFORMATION MAY BE OBTAINED FROM MPEG LA, L.L.C. SEE [HTTP://WWW.MPEGLA.COM](http://www.mpegla.com)

**■ OSS**

This product contains software licensed under GNU General Public License (GPL) or GNU Lesser General Public License (LGPL), etc.

You have the right of acquisition, modification, and distribution of the source code of the GPL/LGPL software. You may download Source Code from the following website at no charge.

URL: [http://www.embedded-carmultimedia.jp/linux/oss/download/MP\\_632\\_34W913](http://www.embedded-carmultimedia.jp/linux/oss/download/MP_632_34W913)

The website provides the Source Code "As Is" and without warranty of any kind. By downloading Source Code, you expressly assume all risk and liability associated with downloading and using the Source Code and complying with the user agreements that accompany each Source Code.

Please note that we cannot respond to any inquiries regarding the source code.

## Software List

kernel2.6.16.29/	FreeType2 2.2.1	gcc sh4eb-3.4.5	glibc-2.3.5	boot_loader sh-ipl+g
libgcc_s-3.4.5	bash-3.0-31	busybox-1.00	v2lin 0.1	module-init-tools-3.1.0
libtermcap-2.0.8	mtd-utils-20050619	initscripts-8.11.1-1	libstdc++-3.4.5-10	libiconv-1.11
coreutils-6.9	dosfstools-2.10-3	directfb 1.0.0-rc1	kxml 1.21	binutils-sh4eb-2.16.91.0.2



**■ FDA**

-Caution-



Use of controls or adjustments or performance of procedures other than those specified herein may result in hazardous radiation exposure.

## ■ Playable Disc Types

This unit is compatible with NTSC and PAL color TV systems. Use discs that are labeled as NTSC or PAL. Capability of this unit to play discs other than NTSC or PAL TV system (SECAM) is not guaranteed.

Type and symbol of playable disc	Size/Playable Side	Max. play time
	12 cm/single-sided	Single layer 133 min.
	12 cm/Double-sided	Dual layer 242 min.
	12 cm/Double-sided	Single layer 266 min.
	12 cm/single-sided	Dual layer 484 min.
		<MPEG 2 standard> at 27 Mbps 123 min. 246 min.

## ■ Playable Disc Region Codes









Some DVD/Blu-ray™\* discs have a region code such as , ,  and this number shows the region the disc can be played in. Playable disc regions are restricted depending on the map coverage areas. If you play other discs, **Check Disc** message is displayed. In addition, some discs that do not have a region code number may still have a region restriction and may not be played on this unit.

## ▶▶ Playable Disc Types

Some discs may not function as expected. Also read the instruction book which comes with the disc.

### Disc Symbols

The following symbols appear on DVD/Blu-ray™\* discs or packing.

Symbol	Description
	Number of available soundtracks
	Number of available subtitles
	Number of angles
	Selectable screen aspect ratios (TV screen's horizontal to vertical ratio)
	16:9: Widescreen 4:3: Normal screen
	Selectable region codes
	ALL: Region free
	A number (ex. 1): Particular region code
	

For Dual Disc (double sided disc with both a DVD layer and a non-DVD layer), the DVD layer can be played as a Video DVD if the disc has the mark displayed on the right. Discs without the mark and the non-DVD layer are not supported, and operation cannot be guaranteed. In addition, the discs may be scratched when they are inserted or ejected.



## Recommended Discs

Compression video not supported, Compression audio specification are following.

<b>Media</b>	CD-R/CD-RW DVD-R/DVD-RW DVD+R/DVD+RW		
<b>Disc format</b>	CD-ROM Mode1 CD-ROM Mode2 Form1 DVD-ROM		
<b>File format</b>	ISO9660 Level 1 & 2 Romeo, Joliet		
<b>Audio format</b>	MP3	WMA	AAC
<b>Audio format specification</b>	MPEG-1 AUDIO LAYER3 MPEG-2 AUDIO LAYER3 MPEG-2.5 AUDIO LAYER3	Microsoft Windows Media Audio Ver7,8,9	MPEG4-AAC m4a files created by iTunes (Apple)
<b>Sampling frequency [kHz]</b>	MPEG-1: 32/44.1/48 MPEG-2: 16/22.05/24 MPEG-2.5: 8/11.025/12	8/11.025/12/16/22.05/24/ 32/44.1/48  Exceptions not supported by DVD Player:12/24	8/11.025/12/16/22.05/24/ 32/44.1/48
<b>Bit rate [kbps]</b>	MPEG1: 32/40/48/56/64/ 80/96/112/128/160/192/ 224/256/320 MPEG2: 8/16/24/32/40/48/ 56/64/80/96/112/128/144/ 160 MPEG2.5: 8/16/24/32/40/ 48/56/64/80/96/112/128/ 144/160	5/8/16/24/32/40/48/64/80/ 96/128/160/192/224/256/ 320/384  Exceptions not supported by DVD Player: 24/224/384	8/16/20/24/28/32/40/48/56/ 64/80/96/112/128/160/192/ 224/256/320/384/448/512/ 576  Exceptions not supported by DVD Player: 384/448/512/ 576
<b>File extension</b>	.mp3/.MP3	.wma/.WMA	.m4a/.M4A

## Recommended Discs



Large files may take longer to change audio or fast-forward/fast-rewind.

Some CD-R/CD-RW/DVD-R/DVD-RW may not be read due to the discs' encoding properties. Use discs recorded with disc-at-once or track-at-once for this unit.

"AVCHD" and the "AVCHD" logo are trademarks of Panasonic Corporation and Sony Corporation.

## DVD or Blu-ray™\* Player Error Messages

If a disc error occurs, you may see the following error messages.

Error Message	Cause	Solution	
<b>Unsupported DISC ERROR</b>	Track/file format not supported	<ul style="list-style-type: none"> <li>• Current track/file will be skipped. The next supported track/file plays automatically.</li> </ul>	
<b>DRM file access ERROR file access</b>			
<b>Cinavia ERROR (Blu-ray™ only)</b>			
<b>MECHA ERROR</b>			Mechanical error <ul style="list-style-type: none"> <li>• Press the  (eject) button and remove the disc, and check that the error message is cleared.</li> <li>• Check that the disc is not damaged or deformed, and insert the disc again.                             <ul style="list-style-type: none"> <li>▶ <b>Protecting CDs</b> P. 316</li> </ul> </li> <li>• If the error message reappears, press the  button, and pull out the disc.</li> <li>• Insert a different disc. If the new disc plays, there is a problem with the first disc.</li> <li>• If the error message repeats, or the disc cannot be removed, contact a dealer. Do not try to force the disc out of the player.</li> </ul>
<b>EJECT RETRY ERROR</b>	Disc error	<ul style="list-style-type: none"> <li>• Check that the disc is not damaged or deformed.                             <ul style="list-style-type: none"> <li>▶ <b>Protecting CDs</b> P. 316</li> </ul> </li> </ul>	
<b>FOCUS ERROR</b>			
<b>HEAT ERROR</b>	High temperature	<ul style="list-style-type: none"> <li>• Turn the audio system off and allow the player to cool down until the error message is cleared.</li> </ul>	

# Customized Features

Use the audio/information screen to customize certain features.

Models with color audio system

## How to customize

While the vehicle is at a complete stop with the power ON, press the **MENU/CLOCK** button, then select **Settings**. To customize the phone settings, press the  button, then select **Phone Setup**.

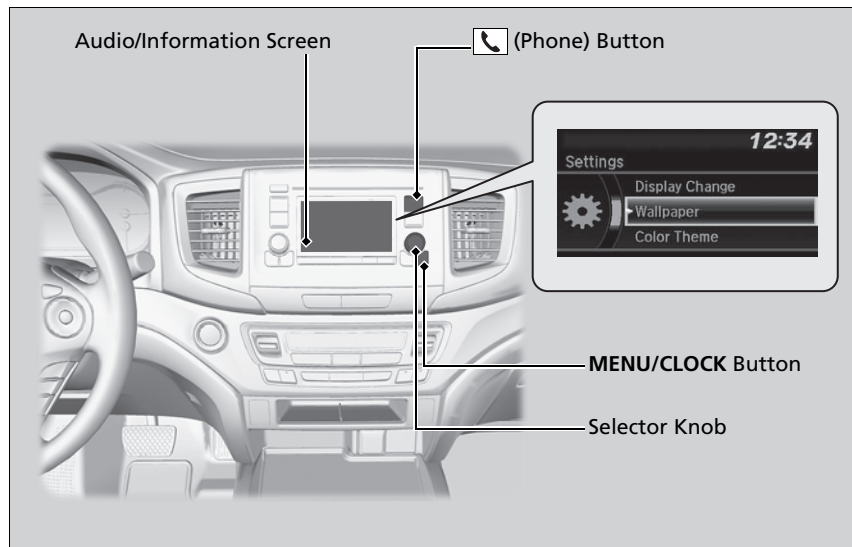

## Customized Features



When you customize settings, make sure that the vehicle is at a complete stop and shift to **P**.

## How to customize

These indications are used to show how to operate the selector knob.

Rotate  to select.

Press  to enter.

To customize other features, select **Settings**, rotate , then press .

 **List of customizable options** P. 355



### ■ Customization Flow

Press the MENU/CLOCK button.

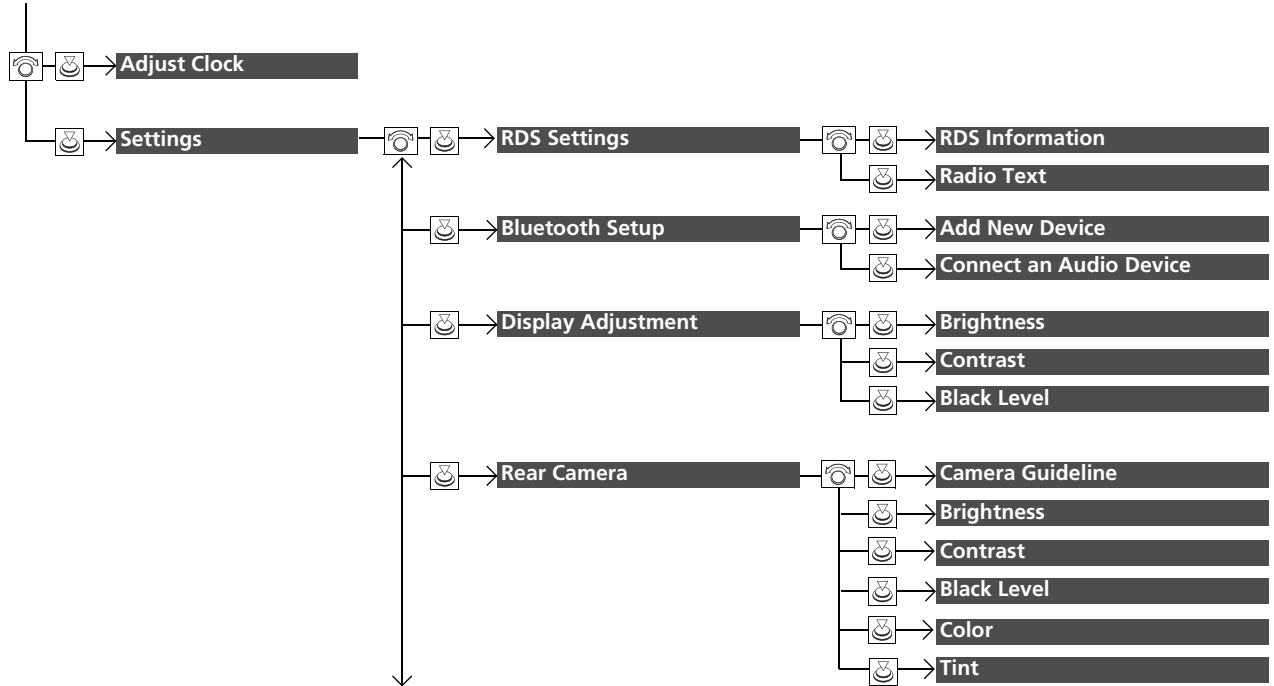

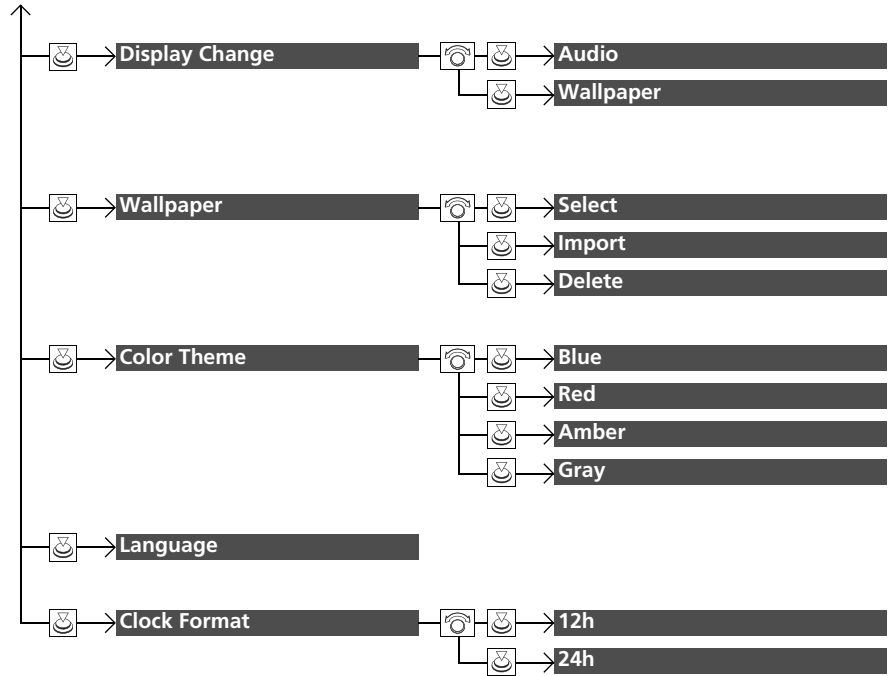

Press the  button and rotate  to select **Phone Setup**, then press .

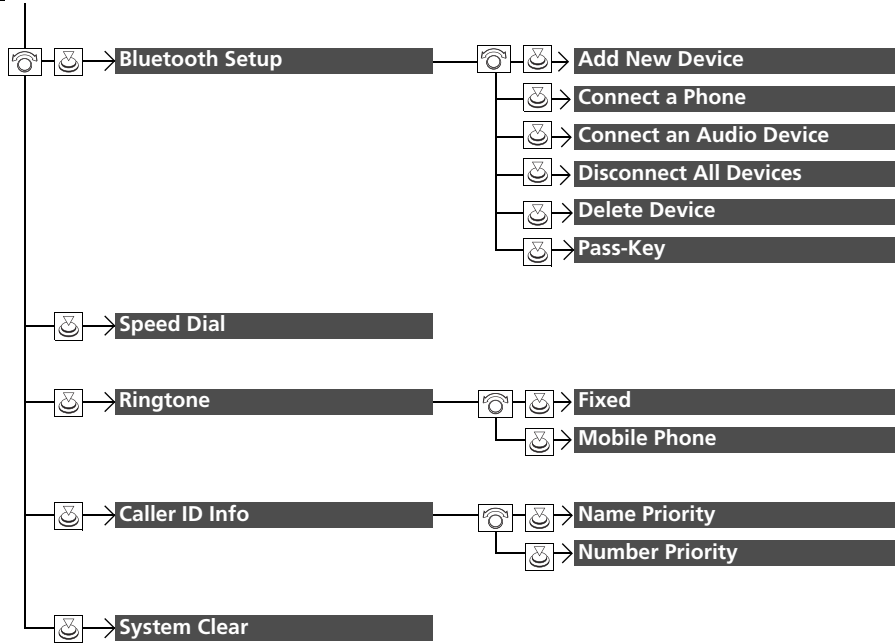

■ List of customizable options

Setup Group	Customizable Features	Description	Selectable Settings	
Settings	<b>Adjust Clock</b>	Adjusts clock. ▶ <b>Clock</b> P. 120	—	
	<b>RDS Settings</b>	<b>RDS Information</b>	Selects whether the RDS information comes on.	<b>On*1/Off</b>
		<b>Radio Text</b>	Displays the radio text information of the selected RDS station.	—
	<b>Bluetooth Setup</b>	<b>Add New Device</b>	See <b>Bluetooth Setup</b> on P. 357	
		<b>Connect an Audio Device</b>		
	<b>Display Adjustment</b>	<b>Brightness</b>	Changes the brightness of the audio/information screen.	—
		<b>Contrast</b>	Changes the contrast of the audio/information screen.	—
		<b>Black Level</b>	Changes the black level of the audio/information screen.	—
	<b>Rear Camera</b>	<b>Camera Guideline</b>	Selects whether the guidelines come on the audio/information screen.	<b>On*1/Off</b>
		<b>Brightness</b>	See <b>Display Adjustment</b> on P. 355	
		<b>Contrast</b>		
		<b>Black Level</b>		
		<b>Color</b>	Changes the color of the audio/information screen.	—
	<b>Tint</b>	Changes the tint of the audio/information screen.	—	

\*1:Default Setting

Setup Group	Customizable Features	Description	Selectable Settings	
Settings	<b>Display Change</b>	Changes the display type.	<b>Audio<sup>*1</sup>/Wallpaper</b>	
	<b>Wallpaper</b>	<b>Select</b>	Changes the wallpaper type.	<b>Clock<sup>*1</sup>/Image1/Image2/Image3</b>
		<b>Import</b>	Imports an image file for a new wallpaper.  <b>Wallpaper Setup</b> P. 227	—
		<b>Delete</b>	Deletes an image file for a wallpaper.	<b>Image1<sup>*1</sup>/Image2/Image3</b>
	<b>Color Theme</b>	Changes the background color of the audio/information screen.	<b>Blue<sup>*1</sup>/Red/Amber/Gray</b>	
	<b>Language</b>	Changes the display language.	<b>English<sup>*1</sup>/French/Spanish</b>	
	<b>Clock Format</b>	Selects the digital clock display from 12h to 24h.	<b>12h<sup>*1</sup>/24h</b>	

\*1: Default Setting

Setup Group	Customizable Features	Description	Selectable Settings
Phone Setup	<b>Add New Device</b>	Pairs a new phone to HFL. ▶ <b>Phone Setup</b> P. 396	—
	<b>Connect a Phone</b>	Pairs a new phone or connects a paired phone to HFL. ▶ <b>Phone Setup</b> P. 396	—
	<b>Bluetooth Setup</b>		
	<b>Connect an Audio Device</b>	Connects a <i>Bluetooth</i> ® Audio device to HFL.	—
	<b>Disconnect All Devices</b>	Disconnects a paired phone from HFL.	—
	<b>Delete Device</b>	Deletes a paired phone.	—
	<b>Pass-Key</b>	Changes a pairing code.	—
	<b>Speed Dial</b>	Edits, adds or deletes a speed dial entry. ▶ <b>Speed Dial</b> P. 405	—
	<b>Ringtone</b>	Selects the ring tone.	<b>Fixed</b> *1/ <b>Mobile Phone</b>
	<b>Caller ID Info</b>	Prioritizes the caller's name or phone number as the caller ID.	<b>Name Priority</b> *1/ <b>Number Priority</b>
<b>System Clear</b>	Cancels/Resets all customized items in the <b>Phone Setup</b> group as default.	—	

\*1:Default Setting

Models with Display Audio

■ **How to customize**

With the power mode in ON, select **Settings**, then select a setting item.

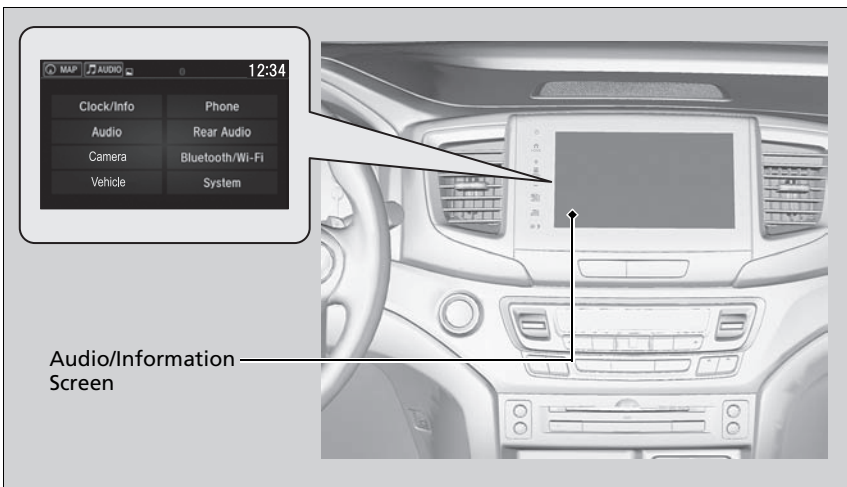

▶▶ Customized Features

When you customize settings, make sure that the vehicle is at a complete stop and shift to **P**.

To customize other features, select **Settings**.

▶ **List of customizable options** P. 368

■ Customization flow

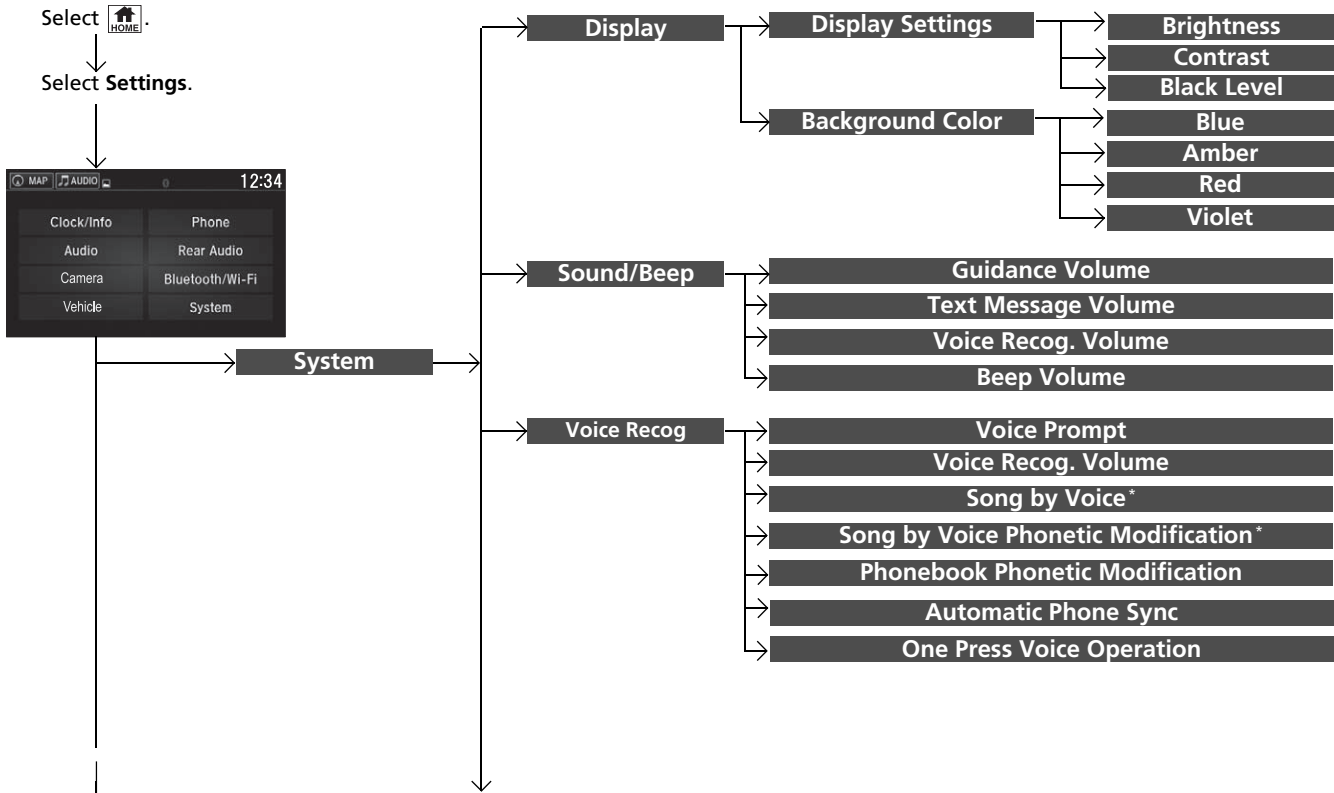

Features

\* Not available on all models



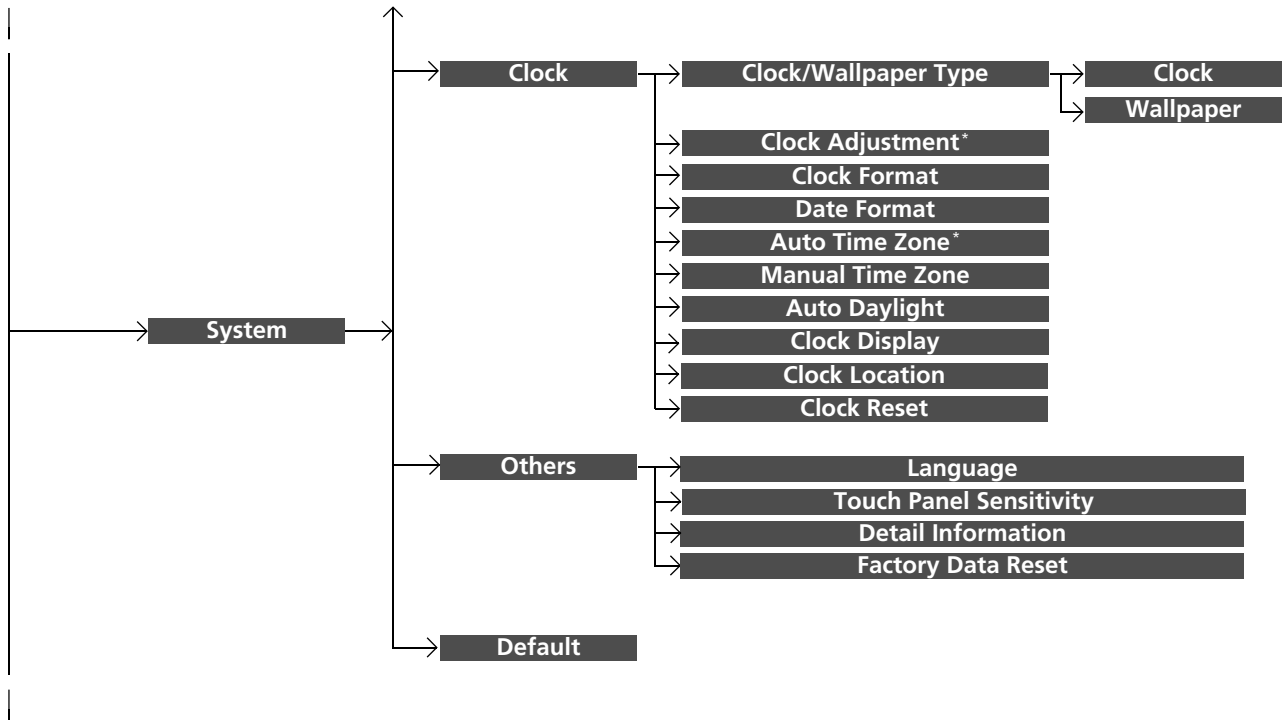

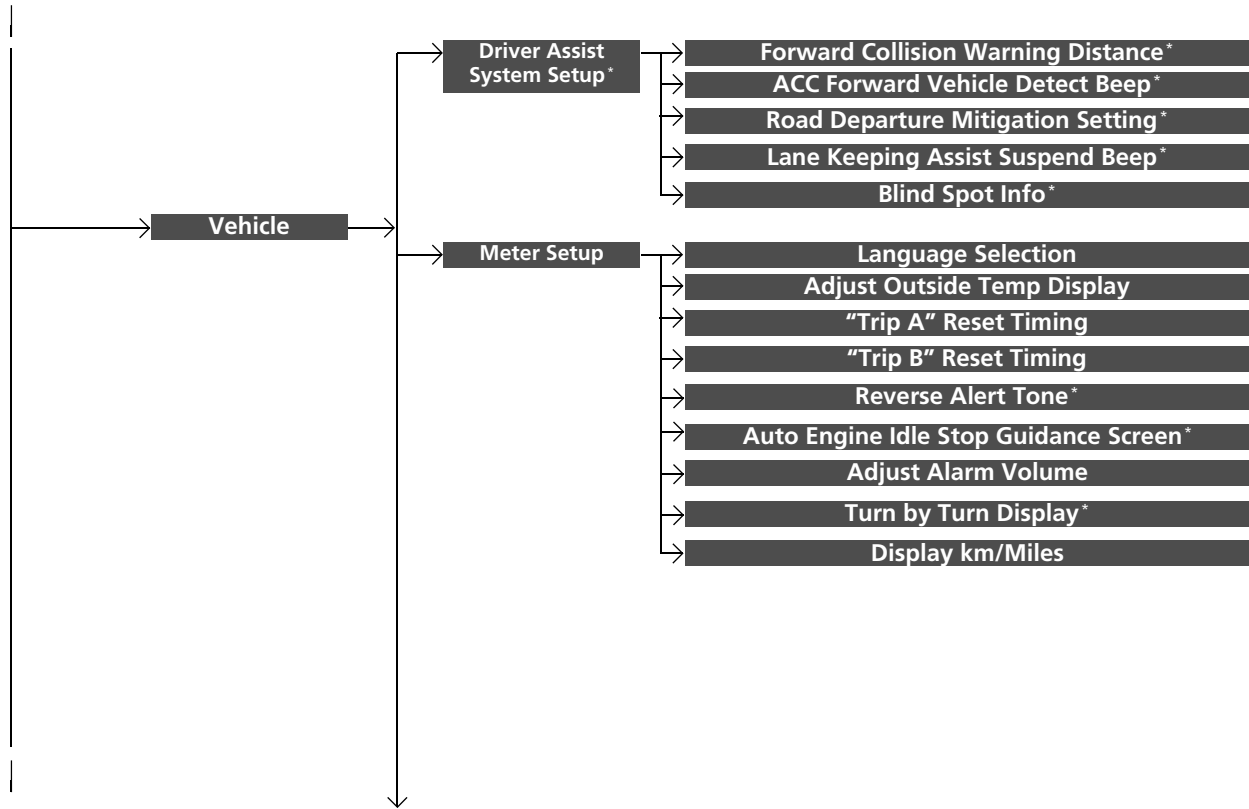

\* Not available on all models

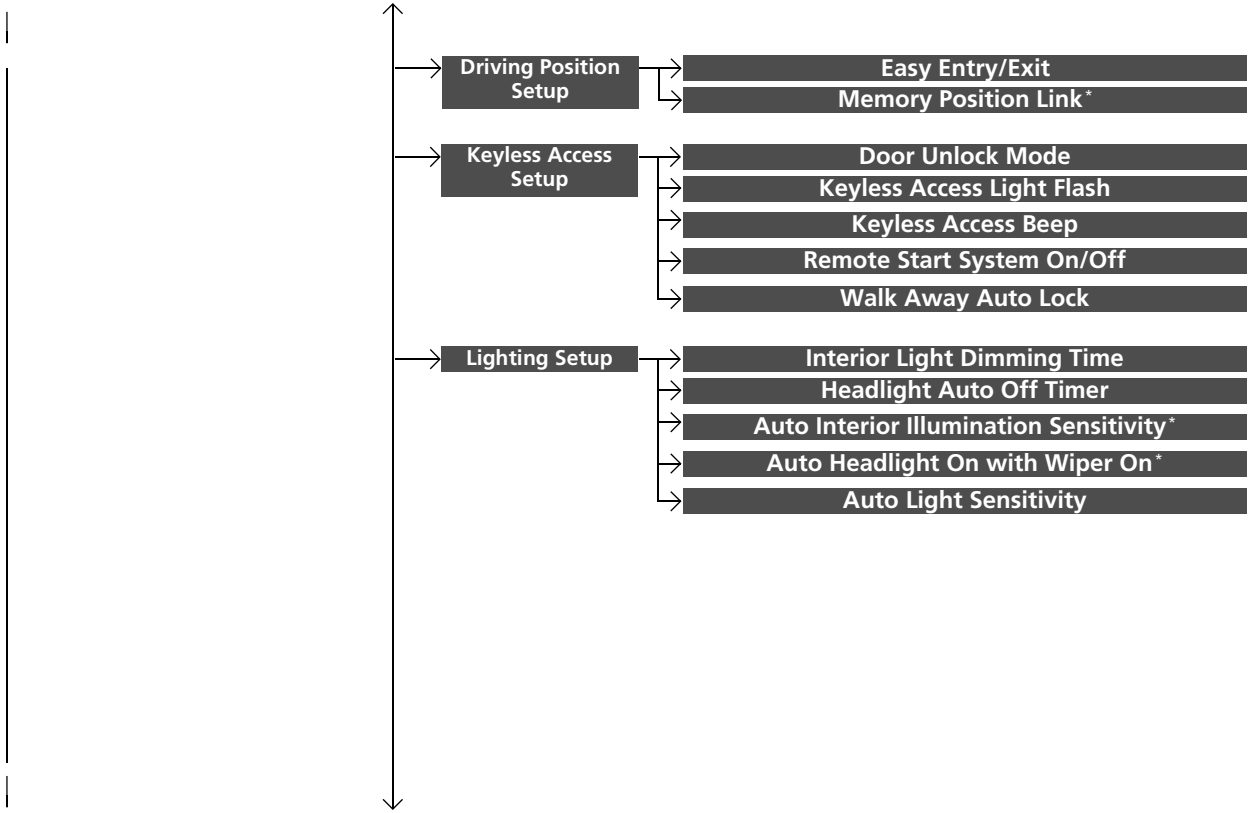

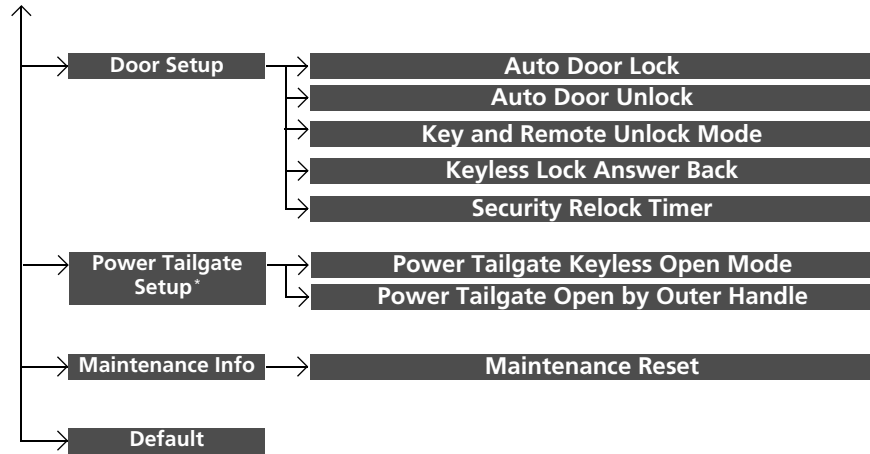

\* Not available on all models

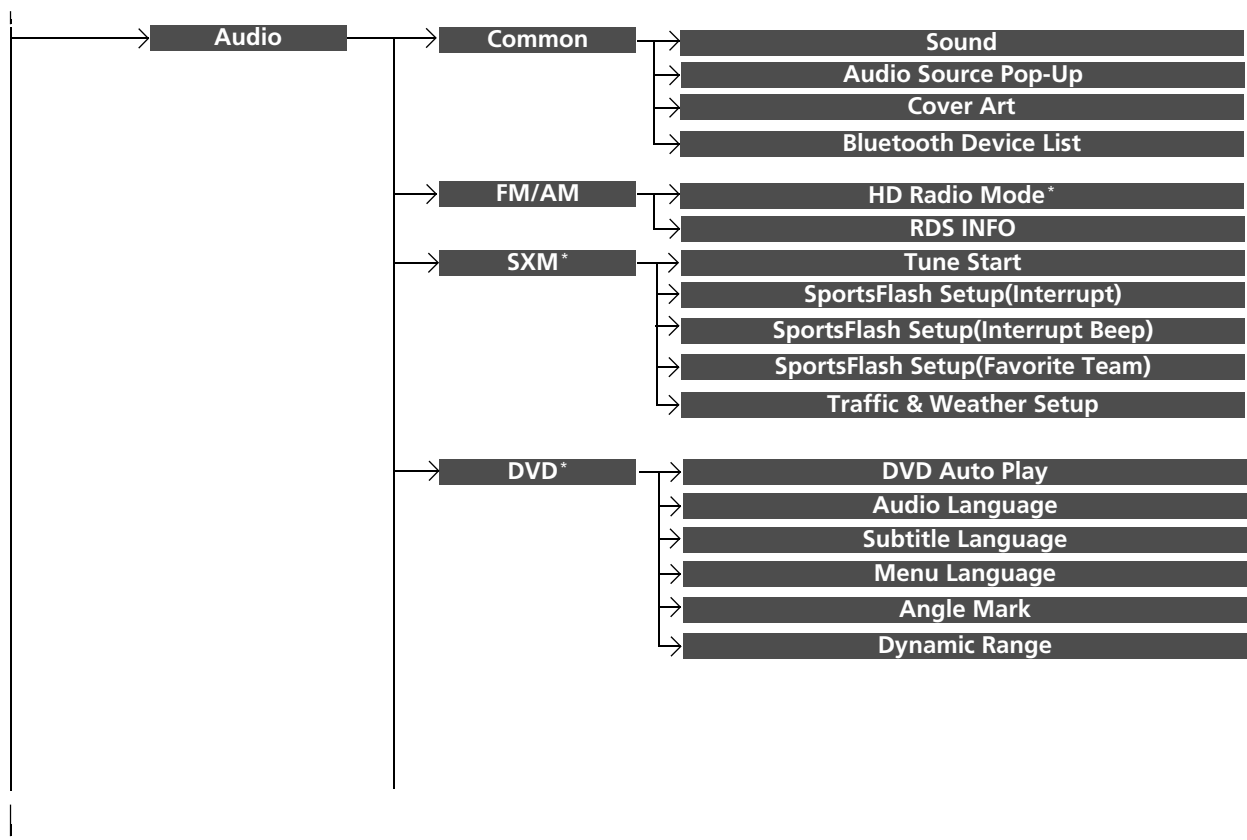

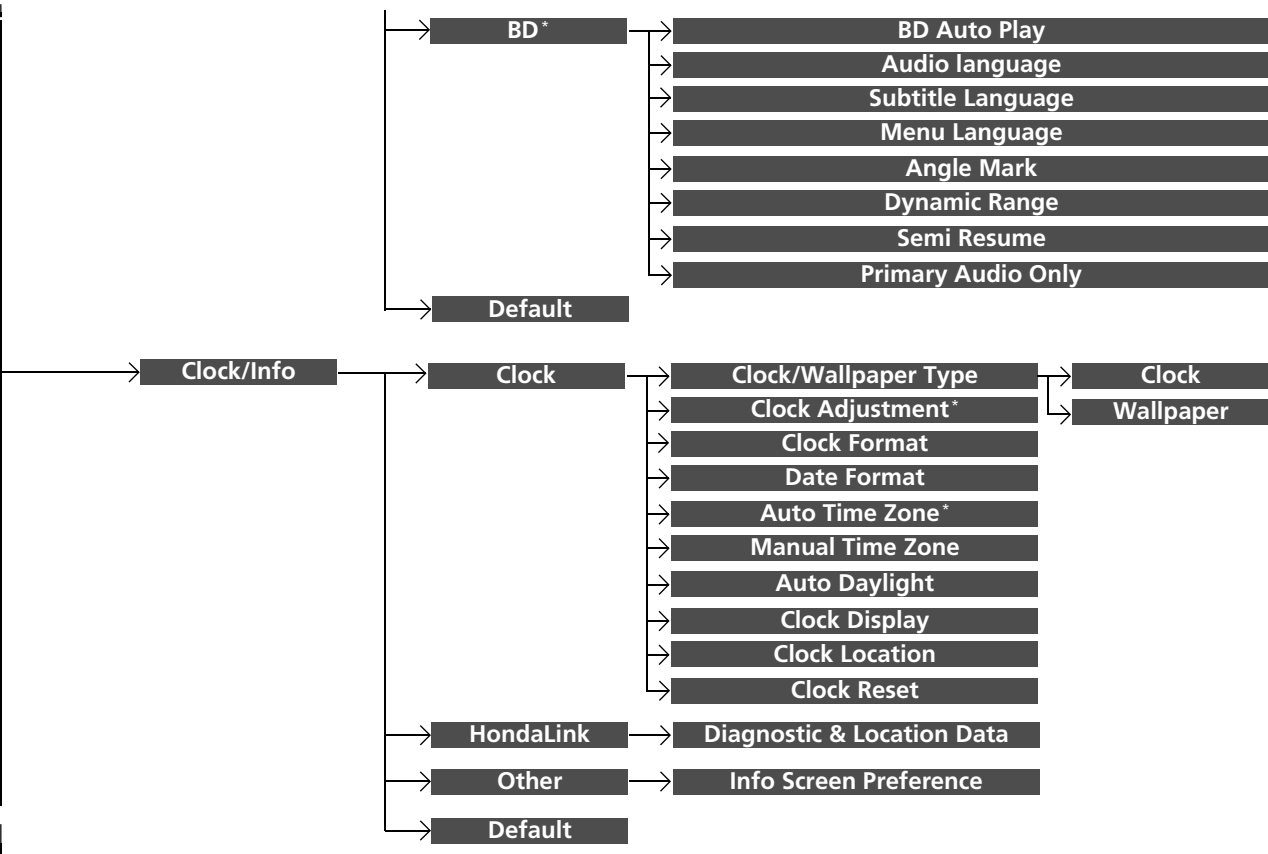

\* Not available on all models

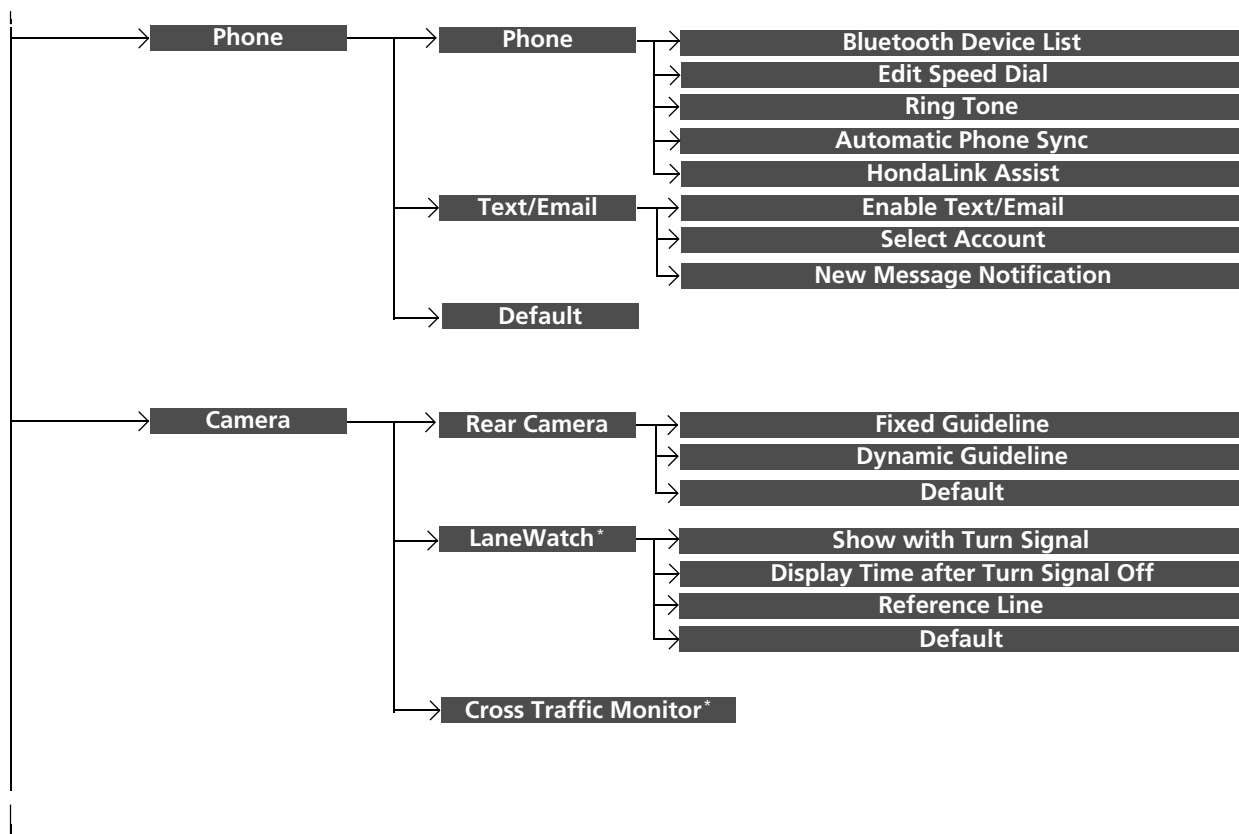

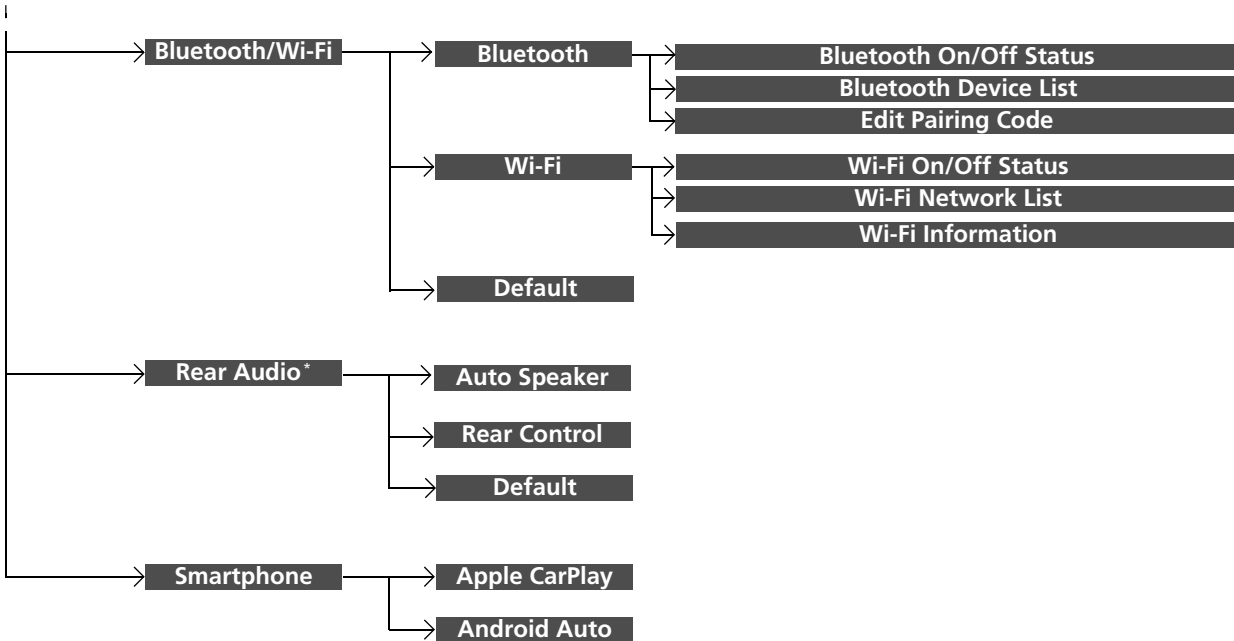

\* Not available on all models



■ List of customizable options

Setup Group	Customizable Features	Description	Selectable Settings	
System	Display Settings	<b>Brightness</b>	Changes the brightness of the audio/information screen.	—
		<b>Contrast</b>	Changes the contrast of the audio/information screen.	—
		<b>Black Level</b>	Changes the black level of the audio/information screen.	—
	<b>Background Color</b>	Changes the background color of the audio/information screen.	<b>Blue<sup>*1</sup>/Amber/Red/Violet</b>	
	Sound/Beep	<b>Guidance Volume</b>	Changes the sound volume. Adjusts the guidance volume of the navigation system.	<b>1~6<sup>*1</sup>~11</b>
		<b>Text Message Volume</b>	Changes the text/e-mail message reading volume.	<b>1~6<sup>*1</sup>~11</b>
		<b>Voice Recog. Volume</b>	Changes the volume of the voice prompt.	<b>1~6<sup>*1</sup>~11</b>
<b>Beep Volume</b>		Changes the beep volume.	<b>Off<sup>*1</sup>/1/2/3</b>	

\*1:Default Setting

Setup Group	Customizable Features	Description	Selectable Settings	
System	Voice Recog	<b>Voice Prompt</b>	Turns the voice prompt on and off.	<b>On<sup>*1</sup>/Off</b>
		<b>Voice Recog. Volume</b>	Changes the volume of the voice prompt.	<b>1~6<sup>*1</sup>~11</b>
		<b>Song by Voice<sup>*</sup></b>	Turns the Song By Voice™ on and off.	<b>On<sup>*1</sup>/Off</b>
		<b>Song by Voice Phonetic Modification<sup>*</sup></b>	Modifies a voice command for music stored in the system or an iPod/iPhone. ▶ <b>Phonetic Modification</b> P. 286	—
		<b>Phonebook Phonetic Modification</b>	Modifies a voice command for the phonebook. ▶ <b>Phonebook Phonetic Modification</b> P. 432	—
		<b>Automatic Phone Sync</b>	Sets phonebook and call history data to be automatically imported when a phone is paired to HFL.	<b>On<sup>*1</sup>/Off</b>
		<b>One Press Voice Operation</b>	Changes the setting of the touch screen operation when using the voice operation.	<b>On/Off<sup>*1</sup></b>

\*1:Default Setting

Setup Group	Customizable Features	Description	Selectable Settings	
<b>System</b>	<b>Clock/ Wallpaper Type</b>	<b>Clock</b>	Changes the clock display type.	<b>Analog/Digital*<sup>1</sup>/Small Digital/Off</b>
		<b>Wallpaper</b>	<ul style="list-style-type: none"> <li>• Changes the wallpaper type.</li> <li>• Imports an image file for a new wallpaper.</li> <li>• Deletes an image file for a wallpaper.</li> </ul>	<b>Time Zone */Galaxy*<sup>1</sup>/Metallic/Blank</b>
		<b>Clock Adjustment *</b>	Adjusts clock.	—
		<b>Clock Format</b>	Selects the digital clock display from 12H to 24H.	<b>12H*<sup>1</sup>/24H</b>
		<b>Date Format</b>	Sets the date format.	<b>YYYY/MM/DD/MM/DD/ YYYY*<sup>1</sup>/DD/MM/YYYY</b>
	<b>Clock</b>	<b>Auto Time Zone *</b>	Sets the navigation system to automatically adjust the clock when driving through different time zones.	<b>On*<sup>1</sup>/Off</b>
		<b>Manual Time Zone</b>	Changes the time zone manually.	—
		<b>Auto Daylight</b>	Select <b>On</b> to have the GPS automatically adjust the clock to daylight savings time. Select <b>Off</b> to cancel this function.	<b>On*<sup>1</sup>/Off</b>
		<b>Clock Display</b>	Selects whether the clock display comes on.	<b>On*<sup>1</sup>/Off</b>
		<b>Clock Location</b>	Changes the clock display layout.	<b>Upper Right*<sup>1</sup>/Upper Left/ Lower Right/Lower Left</b>

\*1:Default Setting

\* Not available on all models

Setup Group	Customizable Features	Description	Selectable Settings	
<b>System</b>	<b>Clock</b>	<b>Clock Reset</b>	Resets the clock settings to the factory default.	<b>Yes/No</b>
	<b>Others</b>	<b>Language</b>	Changes the display language.	<b>English<sup>*1</sup>/French/ Spanish</b>
		<b>Touch Panel Sensitivity</b>	Sets the sensitivity of the touch panel screen.	<b>High/Low<sup>*1</sup></b>
		<b>Detail Information</b>	Displays the Android setting items.	—
		<b>Factory Data Reset</b>	Resets all the settings to their factory default. <input checked="" type="checkbox"/> <b>Defaulting All the Settings</b> P. 386	<b>Yes/No</b>
	<b>Default</b>	Cancels/Resets all customized items in the <b>System</b> settings group as default.		<b>Yes/No</b>

\* 1:Default Setting

Setup Group	Customizable Features	Description	Selectable Settings	
Vehicle	Driver Assist System Setup*	<b>Forward Collision Warning Distance*</b>	Changes distance CMBS™ alerts.	<b>Long/Normal*<sup>1</sup>/Short</b>
		<b>ACC Forward Vehicle Detect Beep*</b>	Causes the system to beep when the system detects a vehicle, or when the vehicle goes out of the ACC range.	<b>On/Off*<sup>1</sup></b>
		<b>Road Departure Mitigation Setting*</b>	Changes the setting for the road departure mitigation system.	<b>Normal*<sup>1</sup>/Wide/Warning Only</b>
		<b>Lane Keeping Assist Suspend Beep*</b>	Causes the system to beep when the LKAS is suspended.	<b>On/Off*<sup>1</sup></b>
		<b>Blind Spot Info*</b>	Changes the setting for the blind spot information.	<b>Audible And Visual Alert*<sup>1</sup>/Visual Alert/Off</b>

\*1:Default Setting

Setup Group	Customizable Features	Description	Selectable Settings
Vehicle Meter Setup	<b>Language Selection</b>	Changes the displayed language on the multi-information display.	<b>English<sup>*1</sup>/French/ Spanish</b>
	<b>Adjust Outside Temp. Display</b>	Adjusts the temperature reading by a few degrees.	<b>-5°F ~ ±0°F<sup>*1</sup> ~ +5°F</b> (U.S.) <b>-3°C ~ ±0°C<sup>*1</sup> ~ +3°C</b> (Canada)
	<b>"Trip A" Reset Timing</b>	Changes the setting of how to reset trip meter A and average fuel economy A.	<b>With Refueled/IGN Off/ Manually Reset<sup>*1</sup></b>
	<b>"Trip B" Reset Timing</b>	Changes the setting of how to reset trip meter B and average fuel economy B.	<b>With Refueled/IGN Off/ Manually Reset<sup>*1</sup></b>
	<b>Reverse Alert Tone<sup>*</sup></b>	Turns the audible notification on and off when you set the gear position to <b>R</b> .	<b>On/Off<sup>*1</sup></b>
	<b>Auto Engine Idle Stop Guidance Screen<sup>*</sup></b>	Turns the engine idle-stop guidance displayed in the meter display on and off during the auto engine idle-stop system is in operation.	<b>On/Off<sup>*1</sup></b>
	<b>Adjust Alarm Volume</b>	Changes the alarm volume, such as the buzzers, warnings, turn signal sound, and so on.	<b>High/Mid<sup>*1</sup>/Low</b>
	<b>Turn by Turn Display<sup>*</sup></b>	Selects whether the turn-by-turn display comes on during the route guidance.	<b>On<sup>*1</sup>/Off</b>

\*1:Default Setting

\* Not available on all models

Setup Group	Customizable Features	Description	Selectable Settings	
Vehicle	<b>Meter Setup</b>	<b>Display km/Miles</b>	Selects the trip computer units.	<b>Auto/km/Miles<sup>*1</sup></b> (U.S.) <b>Auto/km<sup>*1</sup>/Miles</b> (Canada)
	<b>Driving Position Setup</b>	<b>Easy Entry/Exit</b>	Moves the seat rearward when you get in/get out of the vehicle. Changes the setting for this feature.	<b>On<sup>*1</sup>/Off</b>
		<b>Memory Position Link<sup>*</sup></b>	Turns the driving position memory system on and off.	<b>On<sup>*1</sup>/Off</b>
	<b>Keyless Access Setup</b>	<b>Door Unlock Mode</b>	Changes which doors unlock when you grab the driver's door handle.	<b>Driver Door Only<sup>*1</sup>/ All Doors</b>
		<b>Keyless Access Light Flash</b>	Causes some exterior lights to flash when you unlock/lock the doors.	<b>On<sup>*1</sup>/Off</b>
		<b>Keyless Access Beep</b>	Causes the beeper to sound when you unlock/lock the doors.	<b>On<sup>*1</sup>/Off</b>
		<b>Remote Start System On/Off</b>	Turns the remote engine start feature on and off.	<b>On<sup>*1</sup>/Off</b>

\*1:Default Setting

Setup Group	Customizable Features	Description	Selectable Settings
Vehicle	<b>Keyless Access Setup</b> <b>Walk Away Auto Lock</b>	Changes the settings for the automatic locking the doors when you walk away from the vehicle while carrying the smart entry remote.	<b>Enable/Disable*<sup>1</sup></b>
	<b>Interior Light Dimming Time</b>	Changes the length of time the interior lights stay on after you close the doors.	<b>60 sec/30 sec*<sup>1</sup>/15 sec</b>
	<b>Headlight Auto Off Timer</b>	Changes the length of time the exterior lights stay on after you close the driver's door.	<b>60 sec/30 sec/ 15 sec*<sup>1</sup>/0 sec</b>
	<b>Lighting Setup</b> <b>Auto Interior Illumination Sensitivity*</b>	Changes the sensitivity of the brightness of the instrument panel when the headlight switch is in the <b>AUTO</b> position.	<b>Min/Low/Mid*<sup>1</sup>/ High/Max</b>
	<b>Auto Headlight On with Wiper On*</b>	Changes the settings for the wiper operation when the headlights automatically come on while the headlight switch is in the <b>AUTO</b> position.	<b>On*<sup>1</sup>/Off</b>
	<b>Auto Light Sensitivity</b>	Changes the timing for the headlights to come on.	<b>Max/High/Mid*<sup>1</sup>/ Low/Min</b>

\* 1:Default Setting



Setup Group	Customizable Features	Description	Selectable Settings
Vehicle Door Setup	<b>Auto Door Lock</b>	Changes the setting for the automatic locking feature.	<b>With Vehicle Speed<sup>*1</sup>/Shift from P/Off</b>
	<b>Auto Door Unlock</b>	Changes the setting for when the doors unlock automatically.	<b>All Doors When Driver's Door Opens<sup>*1</sup>/All Doors When Shift to P/All Doors with IGN Off/Off</b>
	<b>Key And Remote Unlock Mode</b>	Sets up either the driver's door or all doors to unlock on the first push of the remote or built-in key.	<b>Driver Door<sup>*1</sup>/All Doors</b>
	<b>Keyless Lock Answer Back</b>	LOCK/UNLOCK- The exterior lights flash. LOCK (2nd push)- The beeper sounds.	<b>On<sup>*1</sup>/Off</b>
	<b>Security Relock Timer</b>	Changes the time it takes for the doors to relock and the security system to set after you unlock the vehicle without opening any door.	<b>90 sec/60 sec/30 sec<sup>*1</sup></b>

\*1:Default Setting

Setup Group	Customizable Features	Description	Selectable Settings	
<b>Vehicle</b>	<b>Power Tailgate Setup*</b>	<b>Power Tailgate Keyless Open Mode</b>	Changes the keyless setting for when the power tailgate opens.	<b>Anytime*<sup>1</sup>/When Unlocked</b>
		<b>Power Tailgate Open by Outer Handle</b>	Changes the setting to open power tailgate by tailgate outer handle.	<b>On*<sup>1</sup>/Off</b>
	<b>Maintenance Info.</b>	<b>Maintenance Reset</b>	Resets the engine oil life display when you have performed the maintenance service.	—
	<b>Default</b>		Cancels/Resets all customized items in the <b>Vehicle</b> group as default.	<b>Yes/No</b>

\*1:Default Setting

Setup Group	Customizable Features	Description	Selectable Settings
Audio	Common <b>Sound</b>	Adjusts the settings of the audio speakers' sound. ➤ <b>Adjusting the Sound</b> P. 260	<b>-6 ~ 0*1 ~ +6 (BASS and TREBLE), RR9~0*1 ~ FR9 (FADER), L9~*1 0~R9 (BALANCE), -6 ~ 0*1 ~ +6 (Center and Subwoofer)*, Off/Low/Mid*1/High (Speed Volume Compensation), On*1/Off (Neural)</b>
	<b>Audio Source Pop-Up</b>	Selects whether the list of selectable audio source comes on when <b>Audio</b> is selected on the home screen.	<b>On/Off*1</b>
	iPod or USB mode [Your selected media] <b>Cover Art</b>	Turns the cover art display on and off.	<b>On*1/Off</b>
	<b>Bluetooth Device List</b>	Pairs a new phone to HFL, edits or deletes a paired phone. ➤ <b>Phone Setup</b> P. 423	—
	FM/AM mode <b>FM/AM</b>	<b>HD Radio Mode*</b>	Selects whether the audio system automatically switches to the digital radio waves or receives the analogue waves only.
	<b>RDS INFO</b>	Turns on and off the RDS information.	<b>On*1/Off</b>

\*1:Default Setting

Setup Group	Customizable Features	Description	Selectable Settings
Audio	<b>Tune Start</b>	Turns on and off, starts the song from the beginning as you change preset stations.	On <sup>*1</sup> /Off
	<b>SportsFlash Setup(Interrupt)</b>	Turns on and off the sports alert function.	Off <sup>*1</sup> /On(one time)/ On(continue)
	<b>SportsFlash Setup(Interrupt Beep)</b>	Causes the system to beep when the sports alert is notified.	On <sup>*1</sup> /Off
	<b>SportsFlash Setup(Favorite Team)</b>	Selects your favorite sports teams. 📺 <b>Live Sports Alert</b> P. 276	—
	<b>Traffic &amp; Weather Setup</b>	Selects the region you want to receive the information.	—

\*1:Default Setting

Setup Group	Customizable Features	Description	Selectable Settings
<b>Audio DVD*</b>	<b>DVD Auto Play</b>	Turns on and off to automatically to play a DVD disc.	<b>On/Off</b>
	<b>Audio Language</b>	Changes the language of a DVD disc.	<b>English<sup>*1</sup>, French, Spanish, Arabic, German, Italian, Dutch, Russian, Chinese, Korean, Thai, Japanese, and Other.</b>
	<b>Subtitle Language</b>	Changes the subtitle language of a DVD disc.	<b>English<sup>*1</sup>, French, Spanish, Arabic, German, Italian, Dutch, Russian, Chinese, Korean, Thai, Japanese, and Other.</b>
	<b>Menu Language</b>	Changes the menu language of a DVD disc.	<b>English<sup>*1</sup>, French, Spanish, Arabic, German, Italian, Dutch, Russian, Chinese, Korean, Thai, Japanese, and Other.</b>
	<b>Angle Mark</b>	Turns on and off the angle setting.	<b>On/Off*</b>
	<b>Dynamic Range</b>	Turns on and off the dynamic range function only while playing the Dolby Digital audio.	<b>On*/Off</b>

\*1:Default Setting

Setup Group	Customizable Features	Description	Selectable Settings
Audio	<b>BD Auto Play</b>	Turns on and off to automatically to play a Blu-ray™ disc.	<b>On/Off</b>
	<b>Audio Language</b>	Changes the language of a Blu-ray™ disc.	<b>English*<sup>1</sup>, French, Spanish, Arabic, German, Italian, Dutch, Russian, Chinese, Korean, Thai, Japanese, and Other.</b>
	<b>Subtitle Language</b>	Changes the subtitle language of a Blu-ray™ disc.	<b>English*<sup>1</sup>, French, Spanish, Arabic, German, Italian, Dutch, Russian, Chinese, Korean, Thai, Japanese, and Other.</b>
	<b>BD*</b> <b>Menu Language</b>	Changes the menu language of a Blu-ray™ disc.	<b>English*<sup>1</sup>, French, Spanish, Arabic, German, Italian, Dutch, Russian, Chinese, Korean, Thai, Japanese, and Other.</b>
	<b>Angle Mark</b>	Turns on and off the angle setting.	<b>On/Off*</b>
	<b>Dynamic Range</b>	Turns on and off the dynamic range function only while playing the Dolby Digital audio.	<b>On/Off*</b>
	<b>Semi Resume</b>	Turns on and off the semi resume function.	<b>On/Off*</b>
	<b>Primary Audio Only</b>	Turns on and off the primary audio only function.	<b>On/Off*</b>
<b>Default</b>	Cancels/Resets all customized items in the <b>Audio</b> settings group as default.	<b>Yes/No</b>	

\*1:Default Setting

\* Not available on all models

Setup Group	Customizable Features	Description	Selectable Settings
<b>Clock/ Info</b>	<b>Clock/Wallpaper Type</b>	<b>Clock</b> <b>Wallpaper</b>	
	<b>Clock Adjustment*</b>		
	<b>Clock Format</b>		
	<b>Date Format</b>		
	<b>Auto Time Zone*</b>	See <b>System</b> on P. 368	
	<b>Manual Time Zone</b>		
	<b>Auto Daylight</b>		
	<b>Clock Display</b>		
	<b>Clock Location</b>		
	<b>Clock Reset</b>		
<b>HondaLink</b>	<b>Diagnostic &amp; Location Data</b>	Turns HondaLink® on and off.	<b>On/Off</b>
<b>Other</b>	<b>Info Screen Preference</b>	Changes the information screen type.	<b>Info Top/Info Menu/Off*<sup>1</sup></b>
<b>Default</b>		Cancels/Resets all customized items in the <b>Clock/Info</b> settings group as default.	<b>Yes/No</b>

\*1:Default Setting

\* Not available on all models

Setup Group	Customizable Features	Description	Selectable Settings	
Phone	<b>Bluetooth Device List</b>	Pairs a new phone to HFL, connects or disconnects a paired phone. ▶ <b>Phone Setup</b> P. 423	—	
	<b>Edit Speed Dial</b>	Edits, adds or deletes a speed dial entry. ▶ <b>Speed Dial</b> P. 429	—	
	<b>Ring Tone</b>	Selects the ring tone.	<b>Fixed/Mobile Phone</b> *1	
	<b>Automatic Phone Sync</b>	Sets phonebook and call history data to be automatically imported when a phone is paired to HFL.	<b>On</b> *1/ <b>Off</b>	
	<b>HondaLink Assist</b>	Turns HondaLink® Assist on and off.	<b>On/Off</b> *1	
	<b>Text/Email</b>	<b>Enable Text/Email</b>	Turns the text/e-mail message function on and off.	<b>On</b> *1/ <b>Off</b>
		<b>Select Account</b>	Selects a text or e-mail message account.	—
		<b>New Message Notification</b>	Selects whether a pop-up alert comes on the screen when HFL receives a new text/e-mail messages.	<b>On</b> *1/ <b>Off</b>
<b>Default</b>	Cancels/Resets all customized items in the <b>Phone</b> settings group as default.	<b>Yes/No</b>		

\*1:Default Setting



Setup Group	Customizable Features	Description	Selectable Settings	
Camera	Rear Camera	<b>Fixed Guideline</b> Selects whether the fixed guidelines come on the rear camera monitor. <input checked="" type="checkbox"/> <b>Multi-view rear camera</b> * P. 561	On <sup>*1</sup> /Off	
		<b>Dynamic Guideline</b> Selects whether the dynamic guidelines come on the rear camera monitor. <input checked="" type="checkbox"/> <b>Multi-view rear camera</b> * P. 561	On <sup>*1</sup> /Off	
	<b>Default</b>	Cancels/Resets all customized items in the <b>Rear Camera</b> setting group as default.	Yes/No	
	LaneWatch*	<b>Show with Turn Signal</b>	Selects whether the LaneWatch display comes on when you move the turn signal lever to indicate a right turn.	On <sup>*1</sup> /Off
		<b>Display Time after Turn Signal Off</b>	Changes the length of time the LaneWatch display stays on after the turn signal lever returns to the center.	0 second <sup>*1</sup> /2 seconds
		<b>Reference Line</b>	Selects whether the reference lines come on the LaneWatch monitor.	On <sup>*1</sup> /Off
		<b>Default</b>	Cancels/Resets all customized items in the <b>LaneWatch</b> group as default.	Yes/No
	<b>Cross Traffic Monitor*</b>		Turns on and off the cross traffic monitor.	On/Off

\*1:Default Setting

Setup Group	Customizable Features	Description	Selectable Settings
Bluetooth/ Wi-Fi	<b>Bluetooth On/Off Status</b>	Selects to display the <i>Bluetooth</i> ® status.	<b>On<sup>*1</sup>/Off</b>
	<b>Bluetooth</b>	<b>Bluetooth Device List</b> Pairs a new phone to HFL, edits or deletes a paired phone, or creates a security PIN. ☑ <b>Phone Setup</b> P. 423	—
		<b>Edit Pairing Code</b> Edits a pairing code. ☑ <b>To change the pairing code setting</b> P. 424	<b>Random/Fixed<sup>*1</sup></b>
		<b>Wi-Fi On/Off Status</b> Changes the Wi-Fi mode.	<b>On/Off<sup>*1</sup></b>
	<b>Wi-Fi</b>	<b>Wi-Fi Network List</b> Connects, disconnects, or deletes the Wi-Fi device.	—
		<b>Wi-Fi Information</b> Shows the Wi-Fi information of the device.	—
	<b>Default</b>	Cancels/Resets all customized items in the <b>Bluetooth/Wi-Fi</b> group as default.	<b>Yes/No</b>
Rear Audio <sup>*</sup>	<b>Auto Speaker</b>	Turns the rear speakers on and off.	<b>On/Off<sup>*1</sup></b>
	<b>Rear Control</b>	Turns the rear remote control function on and off.	<b>On/Off<sup>*1</sup></b>
	<b>Default</b>	Cancels/Resets all customized items in the <b>Rear Audio</b> group as default.	<b>Yes/No</b>
Smartphone	<b>Apple CarPlay</b>	Sets up the Apple CarPlay™ connection.	—
	<b>Android Auto</b>	Sets up the Android Auto™ connection.	—

\*1:Default Setting

\* Not available on all models

Models with Display Audio

## Defaulting All the Settings

Reset all the menu and customized settings as the factory defaults.

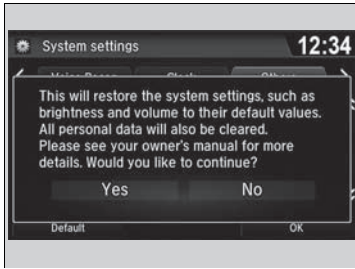

1. Select .
2. Select **Settings**.
3. Select **System**.
4. Select the **Others** tab.
5. Select **Factory Data Reset**.
  - A confirmation message appears on the screen.
6. Select **Yes** to reset the settings.
7. Select **Yes** again to reset the settings.
  - A confirmation message appears on the screen. Select **OK**.
  - After selecting **OK**, the system will reboot.

### ►► Defaulting All the Settings

When you transfer the vehicle to a third party, reset all settings to default and delete all personal data.

If you perform **Factory Data Reset**, it will reset the preinstalled apps to their factory default.

If you perform **Factory Data Reset**, you cannot use the HondaLink® because it becomes off line.

► **HondaLink®** P. 295

The HomeLink® Universal Transceiver can be programmed to operate up to three remote controlled devices around your home, such as garage doors, lighting, or home security systems.

## ■ Important Safety Precautions

Refer to the safety information that came with your garage door opener to test that the safety features are functioning properly. If you do not have the safety information, contact the manufacturer.

Before programming HomeLink, make sure that people and objects are out of the way of the garage or gate to prevent potential injury or damage.

When programming a garage door opener, park just outside the garage door's path.

### ⌘ HomeLink® Universal Transceiver\*

Before programming HomeLink to operate a garage door opener, confirm that the opener has an external entrapment protection system, such as an "electronic eye," or other safety and reverse stop features. If it does not, HomeLink may not be able to operate it.

\* Not available on all models

## Training HomeLink

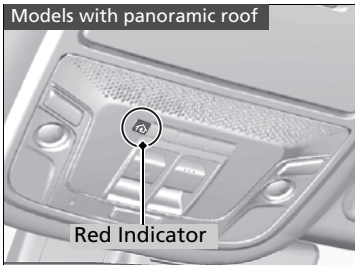
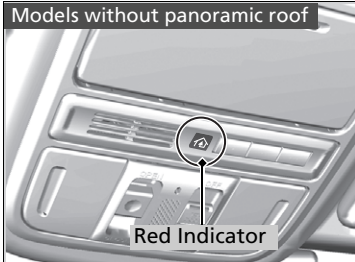

If it is necessary to erase a previously entered learned code:

- Press and hold the two outside buttons for about 20 seconds, until the red indicator blinks. Release the buttons, and proceed to step 1.
- If you are training the second or third button, go directly to step 1.

The instructions on the next page should work for most gate or garage openers, but may not work for all. For detailed instructions about your specific remote opener, visit <http://www.homelink.com> or call (800)355-3515.

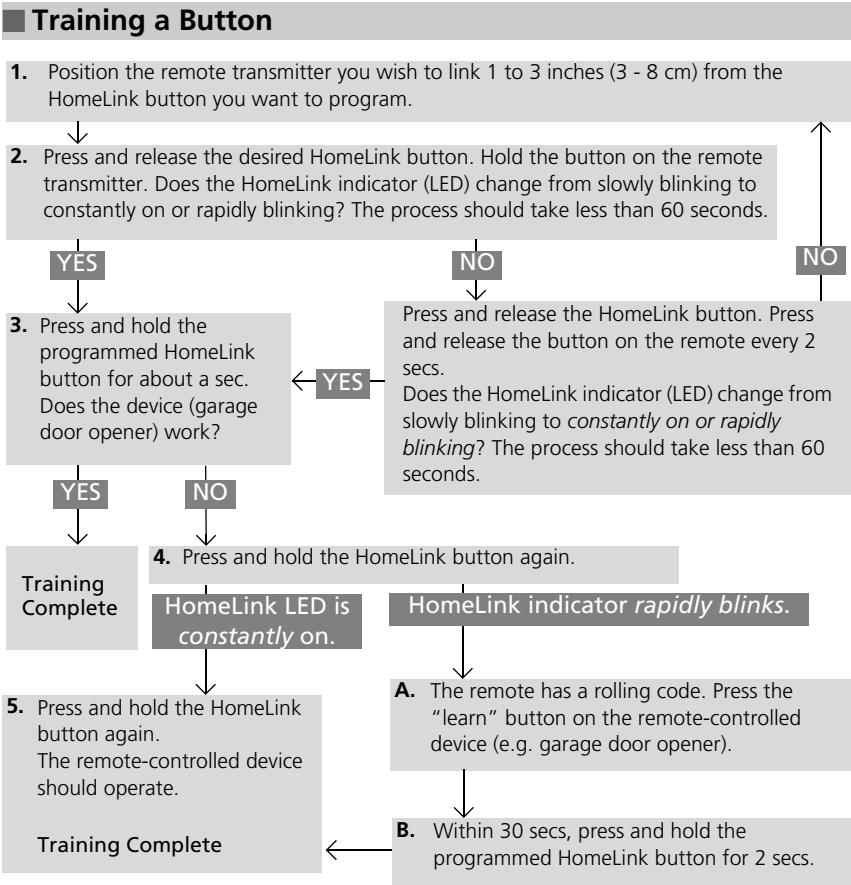

### Training HomeLink

#### Retraining a Button

If you want to retrain a programmed button for a new device, you do not have to erase all button memory. You can replace the existing memory code using this procedure:

- Press and hold the desired HomeLink button until the HomeLink indicator begins to blink.
 

<b>Standard transmitter</b> Indicator remains on for about 25 secs.	<b>Rolling code transmitter</b> Indicator remains on for about 25 secs.
--	--
- Quickly release the HomeLink button and follow steps 1 - 3 under "Training a Button." You do not need to press and release the HomeLink button again in step 2.

#### Erasing Codes

To erase all the codes, press and hold the two outside buttons until the HomeLink indicator begins to blink (about 10 to 20 secs). You should erase all codes before selling the vehicle.

If you have any problems, see the device's instructions, visit [www.homelink.com](http://www.homelink.com), or call HomeLink at (800) 355-3515.

HomeLink® is a registered trademark of Gentex Corporation.

Features

Bluetooth® HandsFreeLink® (HFL) allows you to place and receive phone calls using your vehicle's audio system, without handling your cell phone.

Models with color audio system

## Using HFL

### HFL Buttons

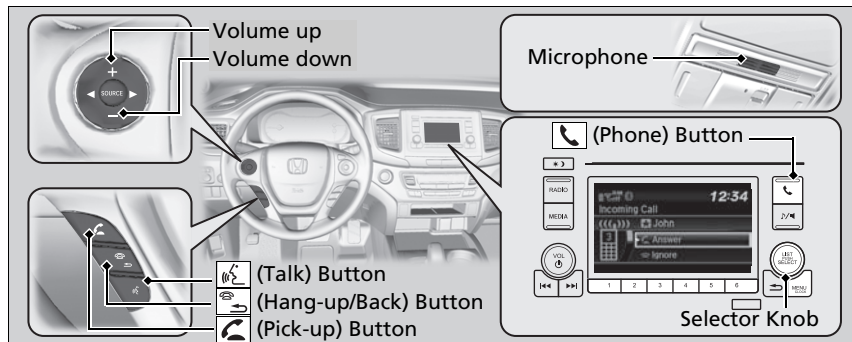

**(Pick-up) button:** Press to go directly to the phone screen or to answer an incoming call.

**(Hang-up/Back) button:** Press to end a call or to cancel a command.

**(Talk) button:** Press to call a number with a stored voice tag.

**(Phone) button:** Press to go directly to the phone screen.

**Selector knob:** Rotate to select an item on the screen, then press .

### Using HFL

Place your phone where you can get good reception.

To use HFL, you need a *Bluetooth*-compatible cell phone. For a list of compatible phones, pairing procedures, and special feature capabilities, visit [www.handsfreelink.honda.com](http://www.handsfreelink.honda.com), or call 1-888-528-7876.

#### Voice control tips

- Aim the vents away from the ceiling and close the windows, as noise coming from them may interfere with the microphone.
- Press and release the button when you want to call a number using a stored voice tag. Speak clearly and naturally after a beep.
- If the microphone picks up voices other than yours, the command may be misinterpreted.
- To change the volume level, use the audio system's volume knob or the remote audio controls on the steering wheel.

State or local laws may prohibit the operation of handheld electronic devices while operating a vehicle.

If you receive a call while using the audio system, the system resumes its operation after ending the call.

Up to 20 speed dial entries can be stored. If there is no entry in the system, Speed Dial is disabled.

**Speed Dial** P. 405

Up to 20 call histories can be stored. If there is no call history, Call History is disabled.

## HFL Status Display

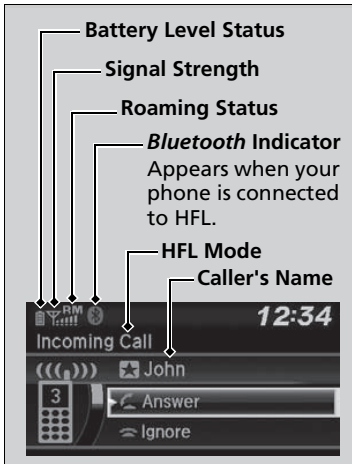

The audio/information screen notifies you when there is an incoming call.

## Limitations for Manual Operation

Certain manual functions are disabled or inoperable while the vehicle is in motion. You cannot select a grayed-out option until the vehicle is stopped.

Only previously stored speed dial entries can be called using voice commands while the vehicle is in motion.

▶ **Speed Dial** P. 405

## Using HFL

### Bluetooth® Wireless Technology

The *Bluetooth*® word mark and logos are registered trademarks owned by *Bluetooth* SIG, Inc., and any use of such marks by Honda Motor Co., Ltd., is under license. Other trademarks and trade names are those of their respective owners.

### HFL Limitations

An incoming call on HFL will interrupt the audio system when it is playing. It will resume when the call is ended.

## HFL Status Display

The information that appears on the audio/information screen varies between phone models.

You can change the system language.

▶ **Customized Features** P. 351





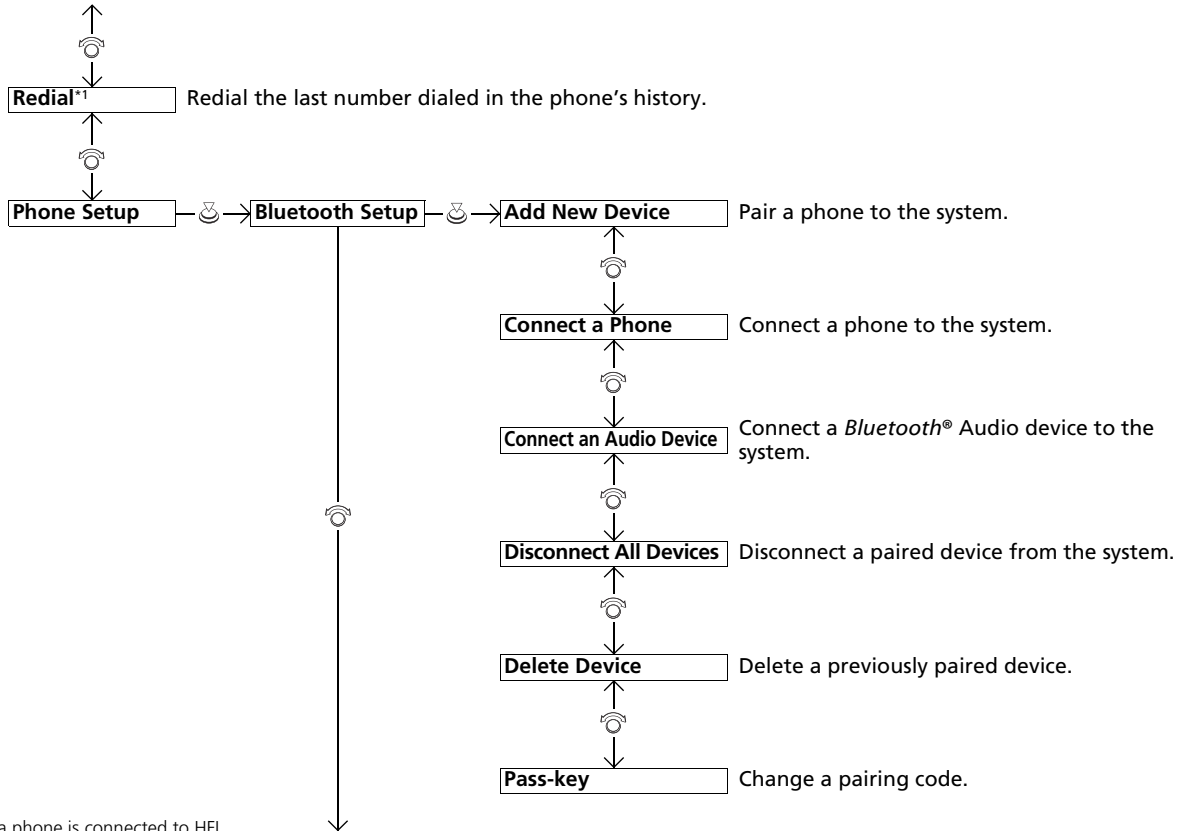

\*1: Appears only when a phone is connected to HFL.

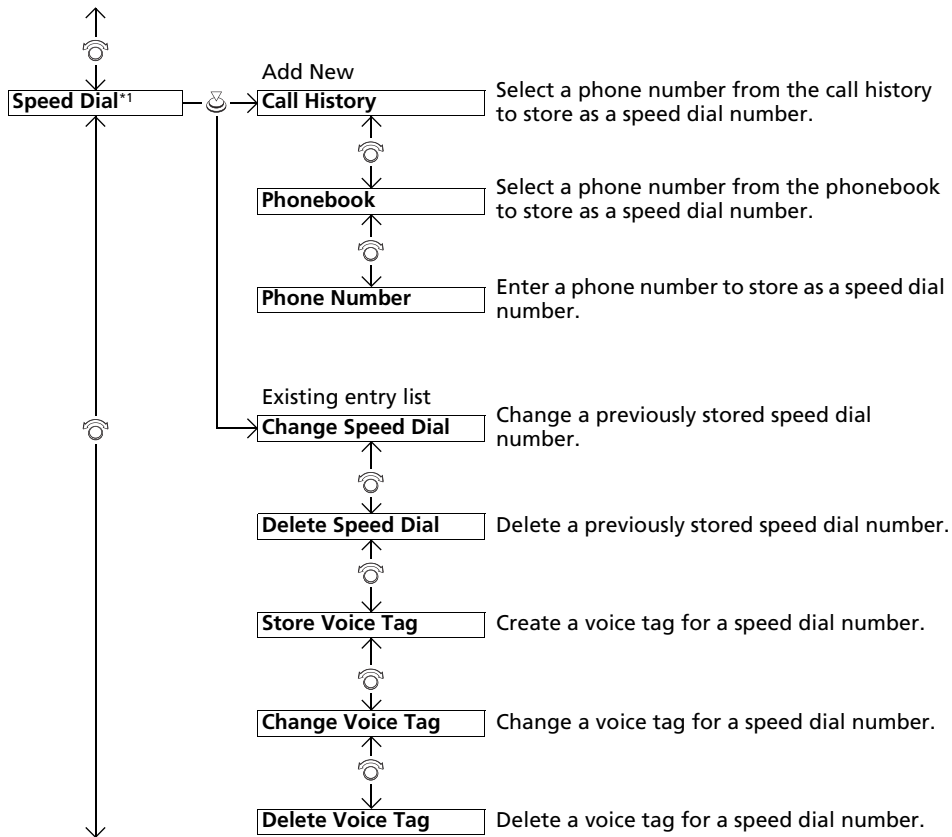

\*1: Appears only when a phone is connected to HFL.

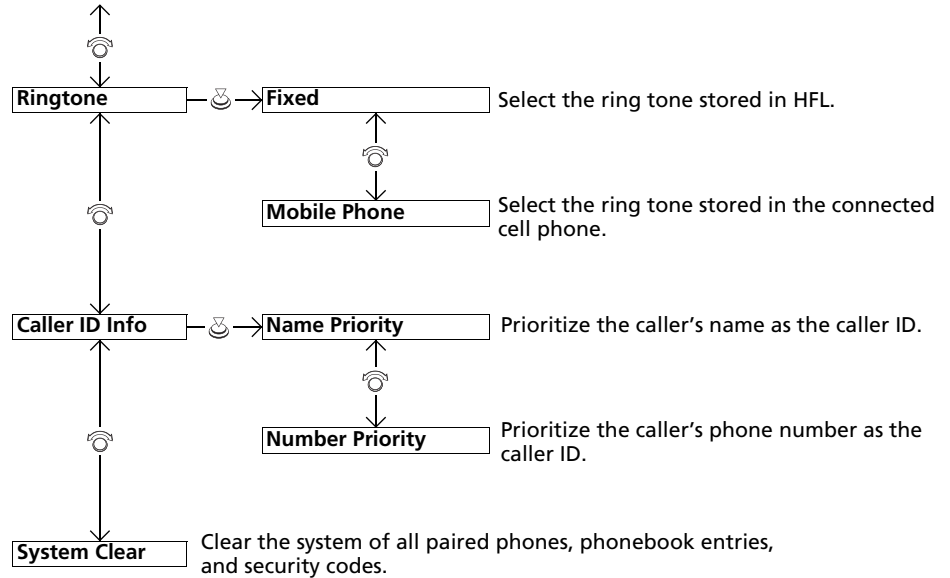

## Phone Setup

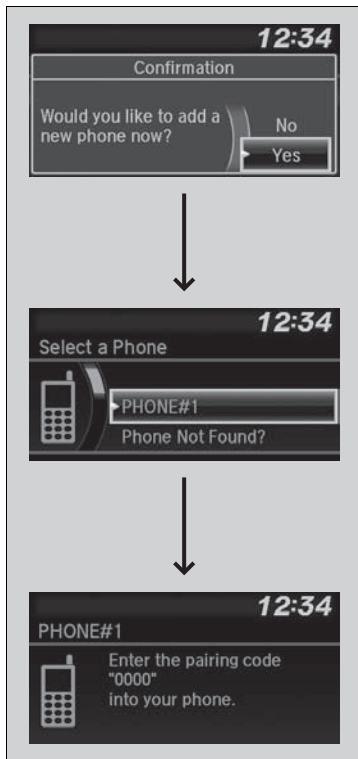

### ■ To pair a cell phone (when there is no phone paired to the system)

1. Press the button or the button.
2. Rotate to select **Yes**, then press .
3. Make sure your phone is in search or discoverable mode, then press .
  - ▶ HFL automatically searches for a *Bluetooth*® device.
4. When your phone appears on the list, select it by pressing .
  - ▶ If your phone does not appear, select **Phone Not Found?** and search for *Bluetooth*® devices using your phone. From your phone, select **HandsFreeLink**.
5. The system gives you a pairing code on the audio/information screen.
  - ▶ Confirm if the pairing code on the screen and your phone match. This may vary by phone.
6. A notification appears on the screen if pairing is successful.

## ☞ Phone Setup

Your *Bluetooth*-compatible phone must be paired to HFL before you can make and receive hands-free calls.

### Phone Pairing Tips:

- You cannot pair your phone while the vehicle is moving.
- Up to six phones can be paired.
- Your phone's battery may drain faster when it is connected to HFL.
- If your phone is not ready for pairing or not found by the system within three minutes, the system will time out and return to idle.







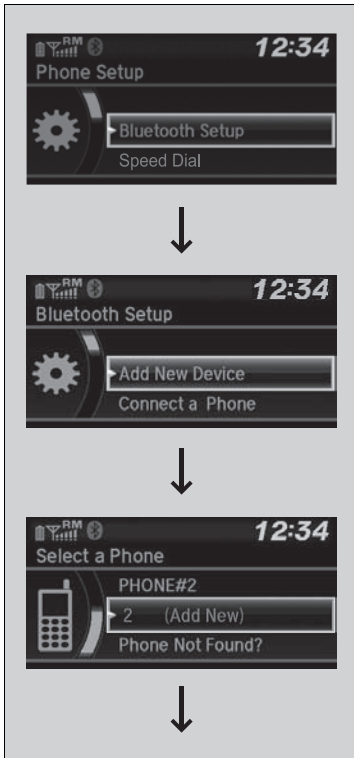



Once you have paired a phone, you can see it displayed on the screen with one or two icons on the right side.

These icons indicate the following:

- : The phone can be used with HFL.
- : The phone is compatible with *Bluetooth*® Audio.



■ **To pair a cell phone (when a phone has already been paired to the system)**

1. Press the  button or the  button.
  - ▶ If a prompt appears asking to connect to a phone, select **No** and proceed with step 2.
2. Rotate  to select **Phone Setup**, then press .
3. Rotate  to select **Bluetooth Setup**, then press .
4. Rotate  to select **Add New Device**, then press .
  - ▶ The screen changes to device list.
5. Rotate  to select **Add New**, then press .

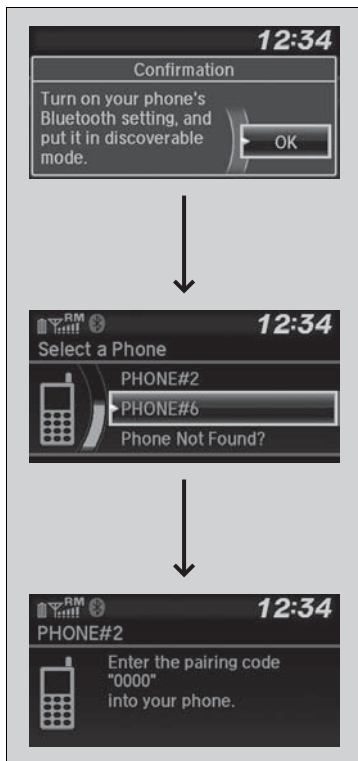

6. Make sure your phone is in search or discoverable mode, then press .
  - ▶ HFL automatically searches for a *Bluetooth*® device.
  
7. When your phone appears on the list, select it by pressing .
  - ▶ If your phone does not appear, select **Phone Not Found?** and search for *Bluetooth*® devices using your phone. From your phone, select **HandsFreeLink**.
  
8. The system gives you a pairing code on the audio/information screen.
  - ▶ Confirm if the pairing code on the screen and your phone match. This may vary by a phone.

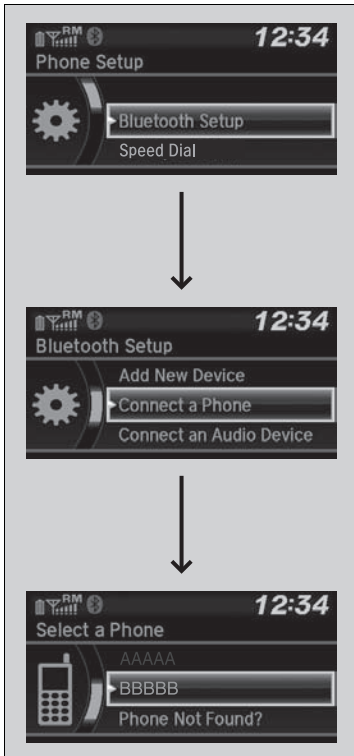

■ **To change the currently paired phone**

1. Press the button or the button.
2. Rotate to select **Phone Setup**, then press .
3. Rotate to select **Bluetooth Setup**, then press .
4. Rotate to select **Connect a Phone**, then press .
  - ▶ The screen changes to a device list.
5. Rotate to select a desired device name, then press .
  - ▶ HFL disconnects the connected phone and starts searching for another paired phone.



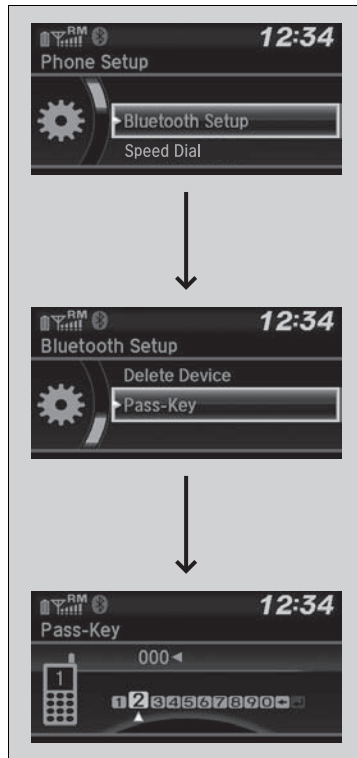

■ **To change the pairing code setting**

1. Press the button or the button.
2. Rotate to select **Phone Setup**, then press .
3. Rotate to select **Bluetooth Setup**, then press .
4. Rotate to select **Pass-Key**, then press .
5. Input a new pairing code, then press .

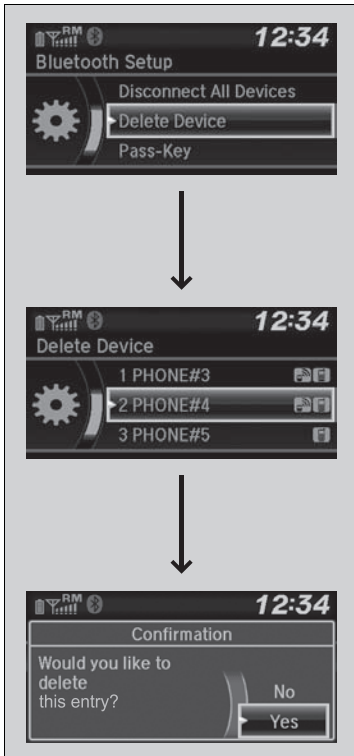

■ **To delete a paired phone**

1. Press the button or the button.
2. Rotate to select **Phone Setup**, then press .
3. Rotate to select **Bluetooth Setup**, then press .
4. Rotate to select **Delete Device**, then press .
  - ▶ The screen changes to a device list.
5. Rotate to select a phone you want to delete, then press .
6. A confirmation message appears on the screen. Rotate to select **Yes**, then press .

## ■ Ring Tone

You can change the ring tone setting.

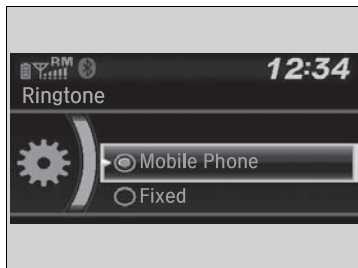

1. Press the button or the button.
2. Rotate to select **Phone Setup**, then press .
3. Rotate to select **Ringtone**, then press .
4. Rotate to select **Mobile Phone** or **Fixed**, then press .

## ■ Caller's ID Information

You can select a caller's information to be displayed when you have an incoming call.

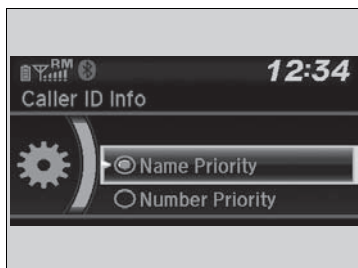

1. Press the button or the button.
2. Rotate to select **Phone Setup**, then press .
3. Rotate to select **Caller ID Info**, then press .
4. Rotate to select a mode you want, then press .

## » Ring Tone

**Fixed:** The fixed ring tone sounds from the speakers.

**Mobile Phone:** Depending on the make and model of the cell phone, the ring tone stored in the phone will sound if the phone is connected.

## » Caller's ID Information

**Name Priority:** A caller's name is displayed if it is stored in the phonebook.

**Number Priority:** A caller's phone number is displayed.

## To Clear the System

All speed dial entries, all imported phonebook data, all call history data, paired phones, pairing codes, caller's ID settings, and volume settings are reset as default.

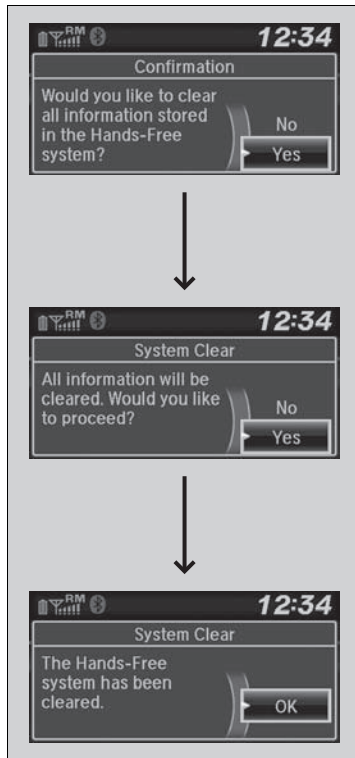

1. Press the button or the button.
2. Rotate to select **Phone Setup**, then press .
3. Rotate to select **System Clear**, then press .
4. Rotate to select **Yes**, then press .
5. A confirmation message appears on the screen. Rotate to select **Yes**, then press .
6. A notification appears on the screen. Press .

Continued

## ■ Automatic Import of Cellular Phonebook and Call History

When your phone is paired, the contents of its phonebook and call history are automatically imported to HFL.



## ▶▶ Automatic Import of Cellular Phonebook and Call History

When you select a name from the list in the cellular phonebook, you can see up to three category icons. The icons indicate what types of numbers are stored for that name.

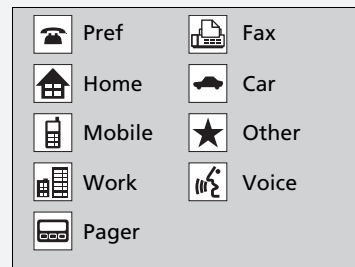

If a name has four or more numbers, ... appears instead of category icons.

On some phones, it may not be possible to import the category icons to HFL.

The phonebook is updated after every connection. Call history is updated after every connection or call.

## Speed Dial

Up to 20 speed dial numbers can be stored per phone.

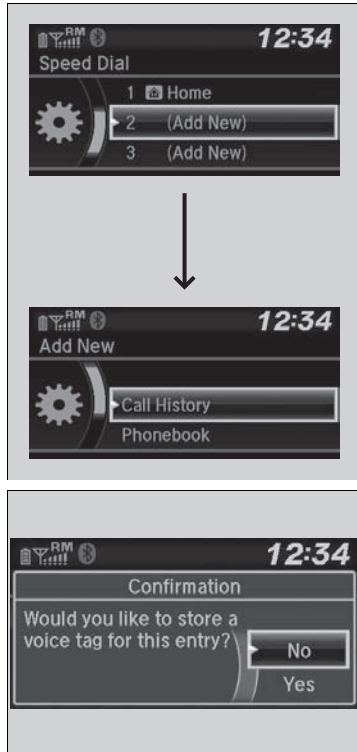

To store a speed dial number:







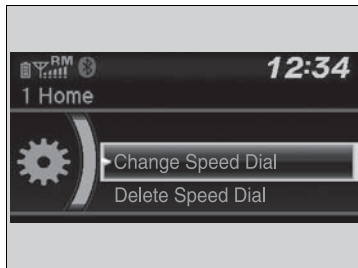

1. Press the button or the button.
2. Rotate to select **Speed Dial**, then press .
3. Rotate to select **Add New**, then press .
4. Rotate to select a place to choose a number from, then press .
  - From **Call History**:
    - ▶ Select a number from the call history.
  - From **Phonebook**:
    - ▶ Select a number from the connected cell phone's imported phonebook.
  - From **Phone Number**:
    - ▶ Input the number manually.
5. When the speed dial is successfully stored, you are asked to create a voice tag for the number. Rotate to select **Yes** or **No**, then press .
6. Using the button, follow the prompts to say the name for the speed dial entry.

### Speed Dial

When a voice tag is stored, you can press the button and call the number using voice commands.



### ■ To edit a speed dial

1. Press the  button or the  button.
2. Rotate  to select **Phone Setup**, then press .
3. Rotate  to select **Speed Dial**, then press .
4. Select an existing speed dial entry.
5. Rotate  to select **Change Speed Dial**, then press .
6. Select a new speed dial number, then press .



■ **To add a voice tag to a stored speed dial number**

1. Press the button or the button.
2. Rotate to select **Phone Setup**, then press .
3. Rotate to select **Speed Dial**, then press .
4. Select an existing speed dial entry.
5. Rotate to select **Store Voice Tag**, then press .
6. Using the button, follow the prompts to complete the voice tag.



■ **To change a voice tag**

1. Press the button or the button.
2. Rotate to select **Phone Setup**, then press .
3. Rotate to select **Speed Dial**, then press .
4. Select an existing speed dial entry.
5. Rotate to select **Change Voice Tag**, then press .
6. Using the button, follow the prompts to complete the voice tag.







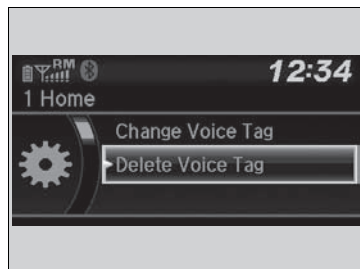



⊗ Speed Dial

Avoid using duplicate voice tags.  
 Avoid using "home" as a voice tag.  
 It is easier for HFL to recognize a longer name. For example, use "John Smith" instead of "John."









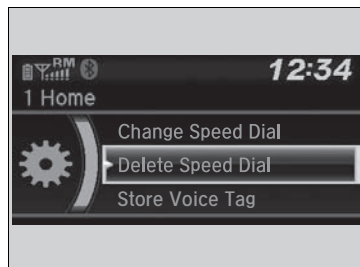





■ **To delete a voice tag**

1. Press the  button or the  button.
2. Rotate  to select **Phone Setup**, then press .
3. Rotate  to select **Speed Dial**, then press .
4. Select an existing speed dial entry.
5. Rotate  to select **Delete Voice Tag**, then press .
  - ▶ A confirmation message appears on the screen. Rotate  to select **Yes**, then press .



■ **To delete a speed dial number**

1. Press the  button or the  button.
2. Rotate  to select **Phone Setup**, then press .
3. Rotate  to select **Speed Dial**, then press .
4. Select an existing speed dial entry.
5. Rotate  to select **Delete Speed Dial**, then press .
  - ▶ A confirmation message appears on the screen. Rotate  to select **Yes**, then press .

## ■ Making a Call

You can make calls by inputting any phone number, or by using the imported phonebook, call history, speed dial entries, or redial.

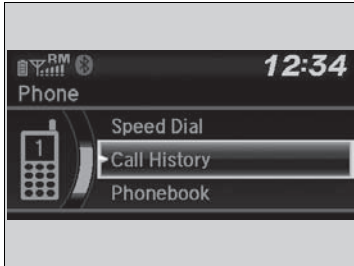

### ☒ Making a Call

Any voice-tagged speed dial entry can be dialed by voice from any screen.

Press the  button and follow the prompts.

Once a call is connected, you can hear the voice of the person you are calling through the audio speakers.

*Continued*

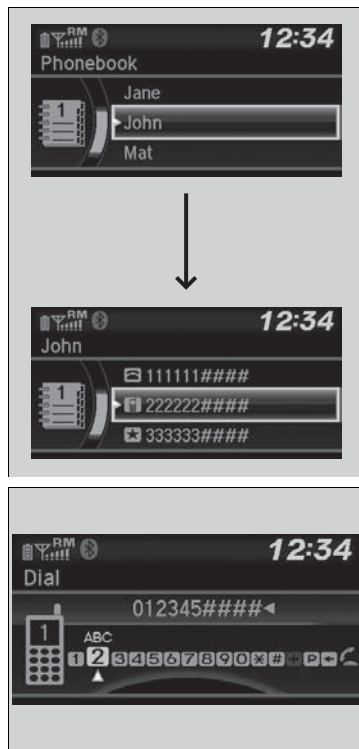

### ■ To make a call using the imported phonebook

When your phone is paired, the contents of its phonebook are automatically imported to HFL.

1. Press the button or the button.
  2. Rotate to select **Phonebook**, then press .
  3. The phonebook is stored alphabetically. Rotate to select the initial, then press .
  4. Rotate to select a name, then press .
  5. Rotate to select a number, then press .
- ▶ Dialing starts automatically.

### ■ To make a call using a phone number

1. Press the button or the button.
  2. Rotate to select **Dial**, then press .
  3. Rotate to select a number, then press .
  4. Rotate to select , then press .
- ▶ Dialing starts automatically.

### ▶▶ To make a call using the imported phonebook

This function is disabled while the vehicle is moving. However, you can call a stored voice-tagged speed dial number using voice commands.

- ▶ **Limitations for Manual Operation** P. 391
- ▶ **Speed Dial** P. 405

### ▶▶ To make a call using a phone number

This function is disabled while the vehicle is moving. However, you can call a stored voice-tagged speed dial number using voice commands.

- ▶ **Limitations for Manual Operation** P. 391
- ▶ **Speed Dial** P. 405



■ **To make a call using redial**

1. Press the button or the button.
2. Rotate to select **Redial**, then press .
  - ▶ Dialing starts automatically.

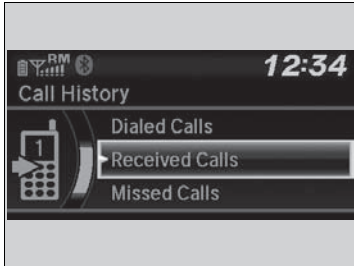

■ **To make a call using the call history**  
Call history is stored by **Dialed Calls**, **Received Calls**, and **Missed Calls**.

1. Press the button or the button.
2. Rotate to select **Call History**, then press .
3. Rotate to select **Dialed Calls**, **Received Calls**, or **Missed Calls**, then press .
4. Rotate to select a number, then press .
  - ▶ Dialing starts automatically.

☒ To make a call using redial

Press and hold the button to redial the last number dialed in your phone's call history.

☒ To make a call using the call history

The call history appears only when a phone is connected to HFL, and displays the last 20 dialed, received, or missed calls. (Appears only when a phone is connected to the system.)

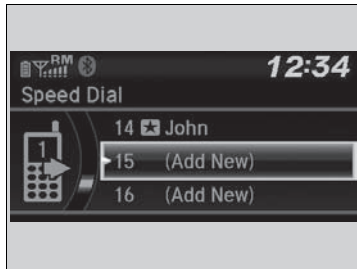

■ **To make a call using a speed dial entry**

1. Press the button or the button.
2. Rotate to select **Speed Dial**, then press .
3. Rotate to select a number, then press .
  - ▶ Dialing starts automatically.

▶▶ To make a call using a speed dial entry

When a voice tag is stored, press the button and call the number using voice commands.

▶ **Speed Dial** P. 405

Any voice-tagged speed dial entry can be dialed by voice from any screen. Press the button and follow the prompts.

## Receiving a Call

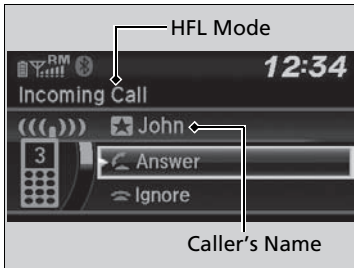

When there is an incoming call, an audible notification sounds and the **Incoming Call** screen appears.

Press the  button to answer the call.

Press the  button to decline or end the call.

### Receiving a Call





Call Waiting

Press the  button to put the current call on hold to answer the incoming call.

Press the  button again to return to the current call.

Select **Ignore** to ignore the incoming call if you do not want to answer it.

Press the  button if you want to hang up the current call.

You can select the icons on the audio/information screen instead of the  and  buttons. Rotate  to select the icon, then press .

## ■ Options During a Call

The following options are available during a call.



**Swap Call:** Put the current call on hold to answer the incoming call.

**Mute:** Mute your voice.

**Transfer Call:** Transfer a call from HFL to your phone.

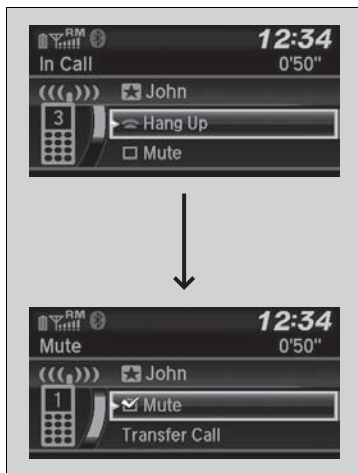
**Dial Tones:** Send numbers during a call. This is useful when you call a menu-driven phone system.



1. To view the available options, press the  button.
2. Rotate  to select the option, then press .
  - ▶ The check box is checked when **Mute** is selected. Select **Mute** again to turn it off.

## ☞ Options During a Call

**Dial Tones:** Available on some phones.

## Models with Display Audio

Bluetooth® HandsFreeLink® (HFL) allows you to place and receive phone calls using your vehicle's audio system, without handling your cell phone.

## Using HFL

### HFL Buttons

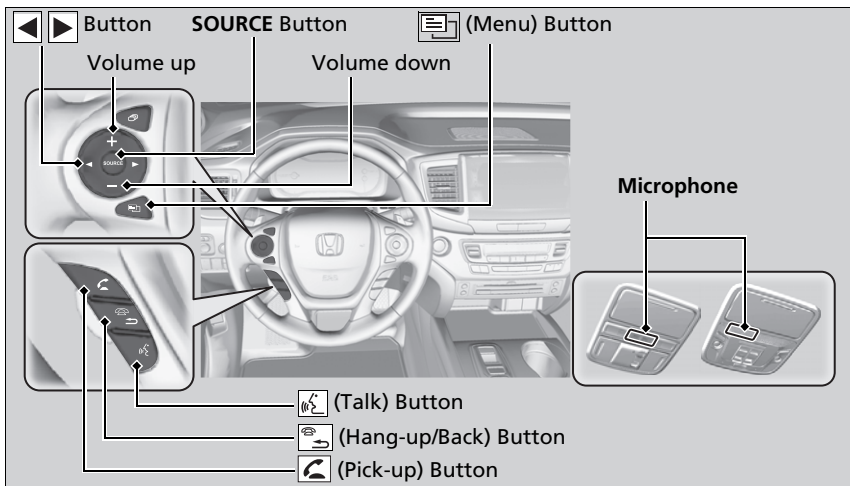

## Bluetooth® HandsFreeLink®

Place your phone where you can get good reception.

To use HFL, you need a *Bluetooth*-compatible cell phone. For a list of compatible phones, pairing procedures, and special feature capabilities, ask a dealer or your local Honda.

To use the system, the **Bluetooth On/Off Status** setting must be **On**. If there is an active connection to Apple CarPlay™ or Android Auto™, HFL is unavailable.

➤ **How to customize** P. 358

### Voice control tips

- Aim the vents away from the ceiling and close the windows, as noise coming from them may interfere with the microphones.
- Press the  button when you want to call a number using a stored voice tag. Speak clearly and naturally after a beep.
- If the microphones pick up voices other than yours, the command may be misinterpreted.
- To change the volume level, select the audio system's **VOL** (Volume) or use the remote audio controls on the steering wheel.

Up to five speed dial entries can be displayed among a total of 20 that can be entered. If there is no entry in the system, Speed Dial is disabled.

➤ **Speed Dial** P. 429

Up to five call histories can be displayed among a total of 20 that can be entered. If there is no call history, Call History is disabled.



 **(Pick-up) button:** Press to go directly to the phone screen, or to answer an incoming call.

 **(Hang-up/back) button:** Press to end a call, go back to the previous command, or cancel a command.



 **(Talk) button:** Press to call a number with a stored voice tag.

 **(Menu) button:** Press to display **Speed Dial**, **Call History**, or **Redial** on the phone screen.

 **button:** Press to select an item displayed on the phone screen.

**SOURCE button:** Press to call a number listed in the selected item on the phone screen.

To go to the **Phone menu** screen:

1. Select .
2. Select **Phone** to switch the display to the phone screen.
3. Select .

#### ▶▶ Bluetooth® HandsFreeLink®

##### *Bluetooth®* Wireless Technology

The *Bluetooth®* word mark and logos are registered trademarks owned by *Bluetooth* SIG, Inc., and any use of such marks by Honda Motor Co., Ltd., is under license. Other trademarks and trade names are those of their respective owners.

##### HFL Limitations

An incoming call on HFL will interrupt the audio system when it is playing. It will resume when the call is ended.

## HFL Status Display

The audio/information screen notifies you when there is an incoming call.

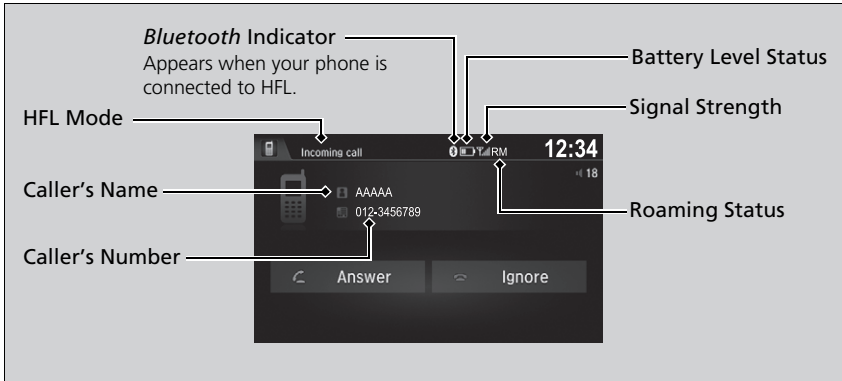

## Limitations for Manual Operation

Certain manual functions are disabled or inoperable while the vehicle is in motion. You cannot select a grayed-out option until the vehicle is stopped.

Only previously stored speed dial entries with voice tags, phonebook names, or numbers can be called using voice commands while the vehicle is in motion.

▶ **Speed Dial** P. 429

## HFL Status Display

The information that appears on the audio/information screen varies between phone models.

You can change the system language.

▶ **How to customize** P. 358

## HFL Menu

The power mode must be in ACCESSORY or ON to use the system.

### ■ Phone settings screen

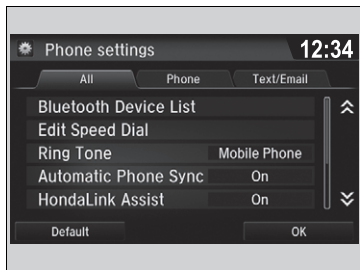

1. Select .
2. Select **Settings**.
3. Select **Phone**.

### ▶▶ HFL Menu

To use HFL, you must first pair your *Bluetooth*-compatible cell phone to the system while the vehicle is parked.

Some functions are limited while driving.

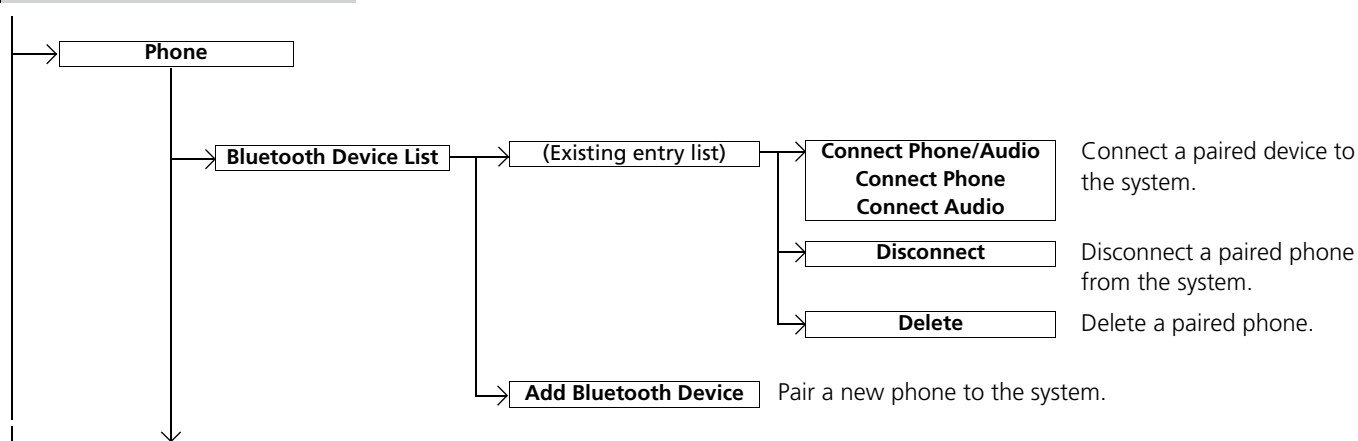

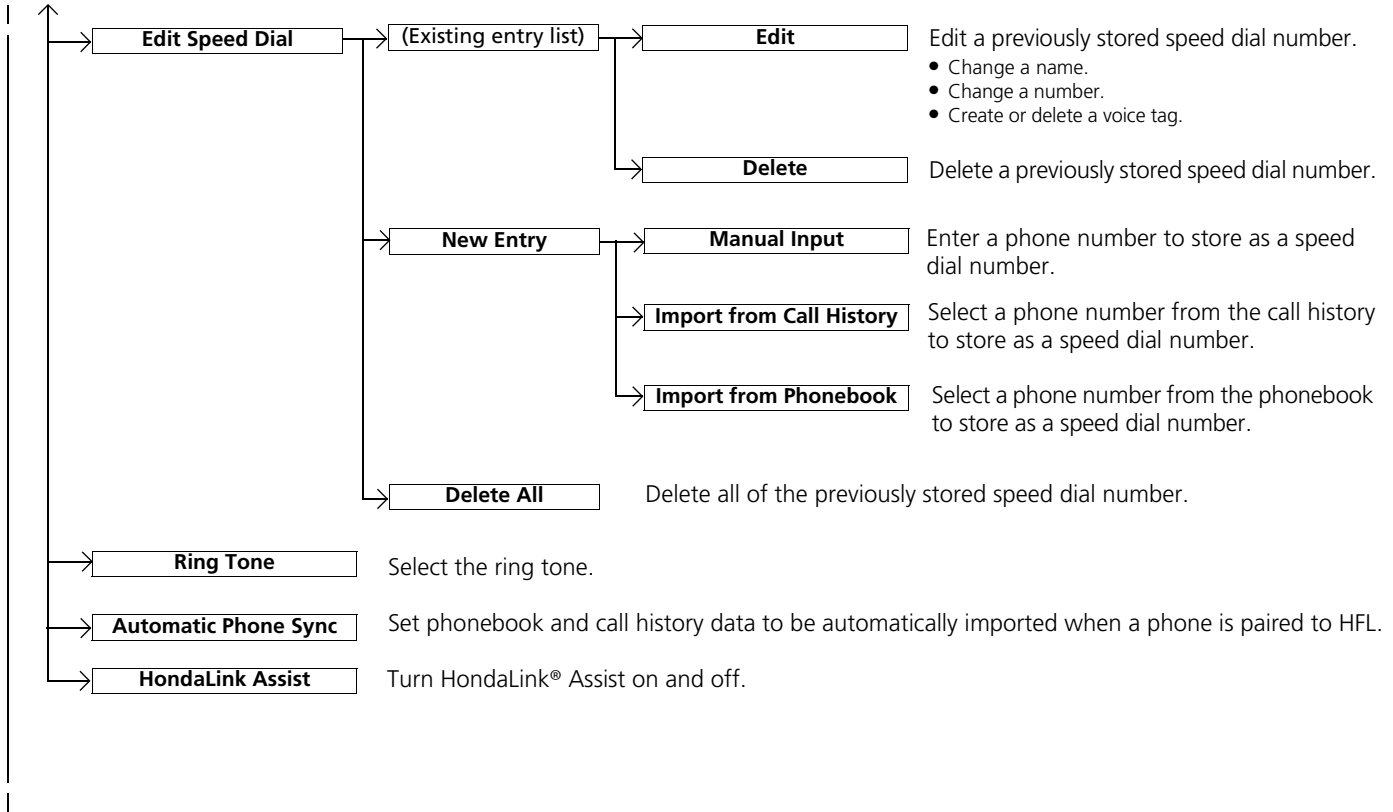

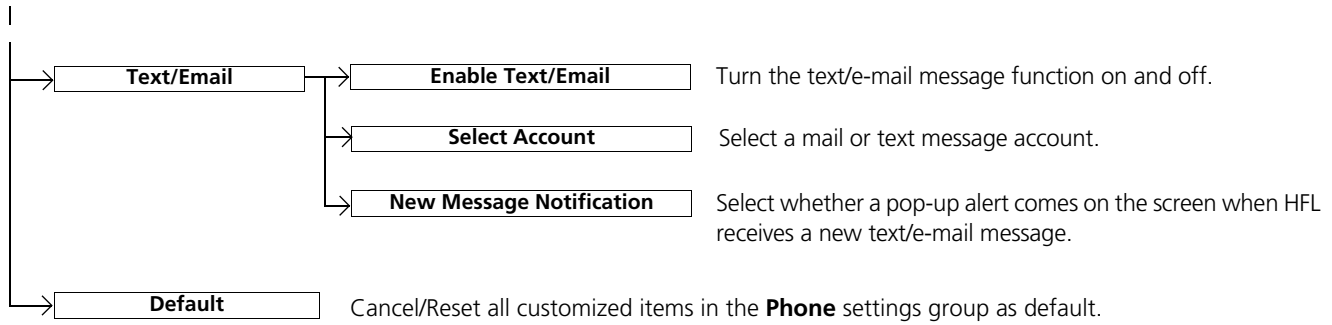

## ■ Phone menu screen

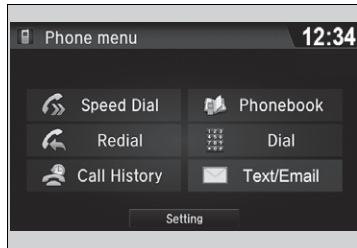

1. Select .
2. Select **Phone**.
3. Select .

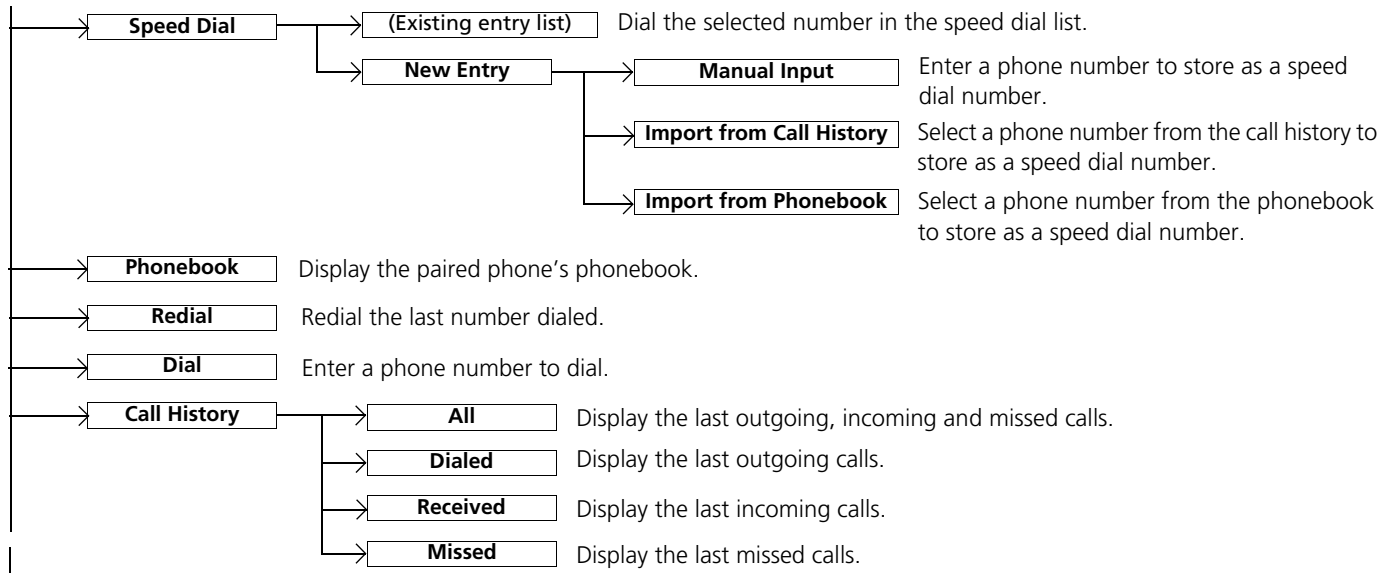

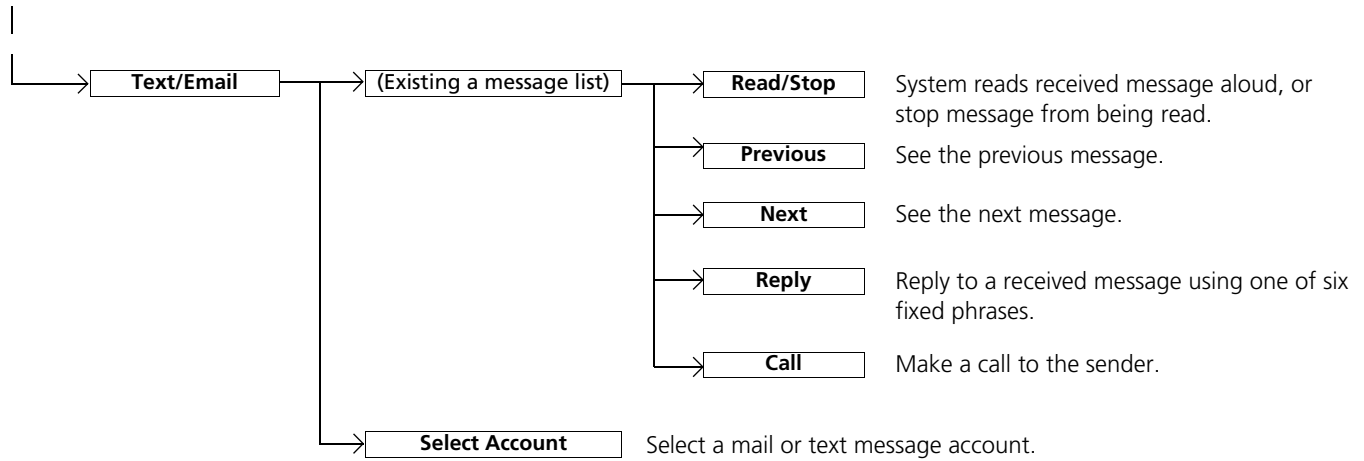

## Phone Setup

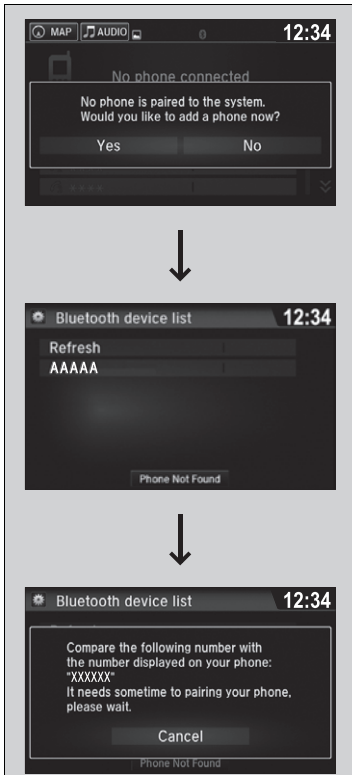

### ■ To pair a cell phone (when there is no phone paired to the system)

1. Select **Phone**.
2. Select **Yes**.
3. Make sure your phone is search or discoverable mode, then select **Continue**.
  - ▶ HFL automatically searches for a *Bluetooth*® device.
4. Select your phone when it appears on the list.
  - ▶ If your phone does not appear, you can select **Refresh** to search again.
  - ▶ If your phone still does not appear, select **Phone Not Found** and search for *Bluetooth*® devices using your phone. From your phone, search for **HandsFreeLink**.
5. The system gives you a pairing code on the audio/information screen.
  - ▶ Confirm if the pairing code on the screen and your phone match. This may vary by phone.

## ☒ Phone Setup

Your *Bluetooth*-compatible phone must be paired to the system before you can make and receive hands-free calls.

### Phone Pairing Tips:

- You cannot pair your phone while the vehicle is moving.
- Up to six phones can be paired.
- Your phone's battery may drain faster when it is paired to the system.
- If your phone is not ready for pairing or not found by the system within three minutes, the system will time out and return to idle.

Once you have paired a phone, you can see it displayed on the screen with one or two icons on the right side.

These icons indicate the following:

- : The phone can be used with HFL.
- : The phone is compatible with *Bluetooth*® Audio.

If there is an active connection to Apple CarPlay™, pairing of additional *Bluetooth*-compatible devices is unavailable and **Add Bluetooth Device** is grayed out from the **Bluetooth Device List** screen.



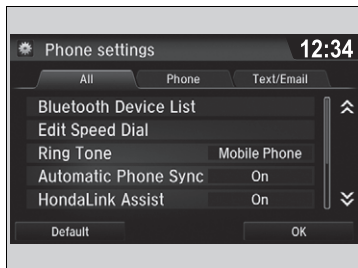

■ **To change the currently paired phone**

1. Go to the phone settings screen.
  - ▶ **Phone settings screen** P. 418
2. Select **Bluetooth Device List**.
3. Select a phone to connect.
  - ▶ HFL disconnects the connected phone and starts searching for another paired phone.
4. Select **Connect Phone/Audio**, **Connect Phone**, or **Connect Audio**.

▶▶ To change the currently paired phone

If no other phones are found or paired when trying to switch to another phone, HFL will inform you that the original phone is connected again.

To pair other phones, select **Add Bluetooth Device** from the **Bluetooth device list** screen.

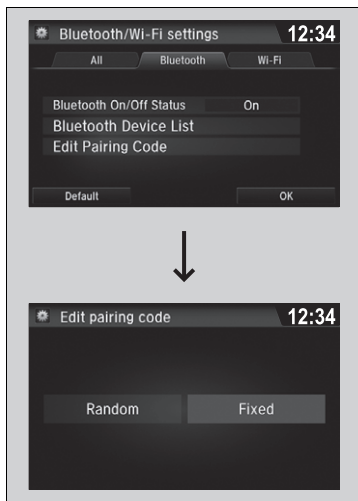

■ **To change the pairing code setting**

1. Select .
  2. Select **Settings**.
  3. Select **Bluetooth/Wi-Fi**.
  4. Select the **Bluetooth** tab.
  5. Select **Edit Pairing Code**.
- 
6. Select **Random** or **Fixed**.

▶▶ To change the pairing code setting

The default pairing code is **0000** until you change the setting.

To create your own, select **Fixed**, and delete the current code, then enter a new one.

For a randomly generated pairing code each time you pair a phone, select **Random**.

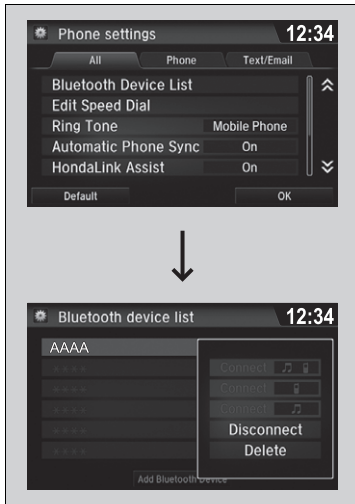

### ■ To delete a paired phone

1. Go to the phone settings screen.
  - **Phone settings screen** P. 418
2. Select **Bluetooth Device List**.
3. Select a phone you want to delete.
4. Select **Delete**.
5. A confirmation message appears on the screen. Select **Yes**.

## ■ To Set Up a Text Message/E-mail Options

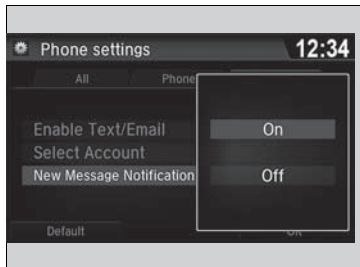
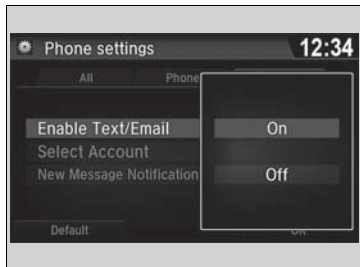

### ■ To turn on or off the text/e-mail function

1. Go to the **Phone settings** screen.
  - ▶ **Phone settings screen** P. 418
2. Select the **Text/Email** tab, then **Enable Text/Email**.
  - ▶ A pop-up menu appears on the screen.
3. Select **On** or **Off**.

### ■ To turn on or off the text/e-mail notice

1. Go to the **Phone settings** screen.
  - ▶ **Phone settings screen** P. 418
2. Select the **Text/Email** tab, then **New Message Notification**.
  - ▶ A pop-up menu appears on the screen.
3. Select **On** or **Off**.

## ▶▶ To Set Up a Text Message/E-mail Options

To use the text message/e-mail function, it may be necessary to set up on your phone.

### ▶▶ To turn on or off the text/e-mail notice

- On:** A pop-up notification comes on every time you receive a new message.
- Off:** The message you receive is stored in the system without notification.

## Ring Tone

You can change the ring tone setting.



1. Go to the phone settings screen.  
 ➤ **Phone settings screen** P. 418
2. Select **Ring Tone**.
3. Select **Fixed** or **Mobile Phone**.

### Ring Tone

**Fixed:** The fixed ring tone sounds from the speakers.  
**Mobile Phone:** For certain connected phones, the ring tone stored in the phone sounds from the speakers.

## ■ Automatic Import of Cellular Phonebook and Call History

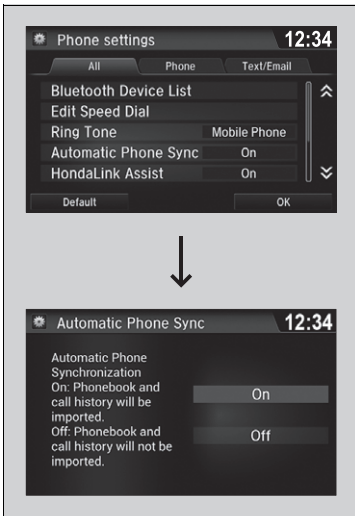
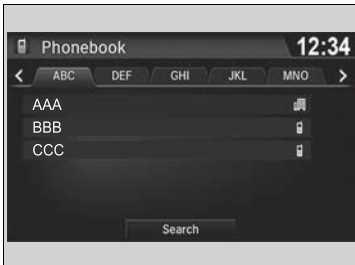

### ■ When Automatic Phone Sync is set to On:

When your phone is paired, the contents of its phonebook and call history are automatically imported to the system.

### ■ Changing the Automatic Phone Sync setting

1. Go to the phone settings screen.
  - ▶ Phone settings screen P. 418
2. Select **Automatic Phone Sync**.
  
3. Select **On** or **Off**.

## ▶▶ Automatic Import of Cellular Phonebook and Call History

When you select a name from the list in the cellular phonebook, you can see up to three category icons. The icons indicate what types of numbers are stored for that name.

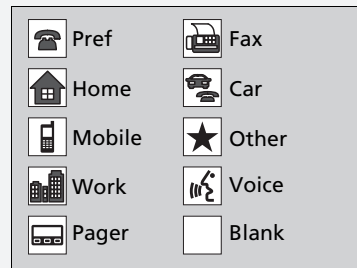

On some phones, it may not be possible to import the category icons to the system.

The phonebook is updated after every connection. Call history is updated after every connection or call.

## Speed Dial

Up to 20 speed dial numbers can be stored per phone.

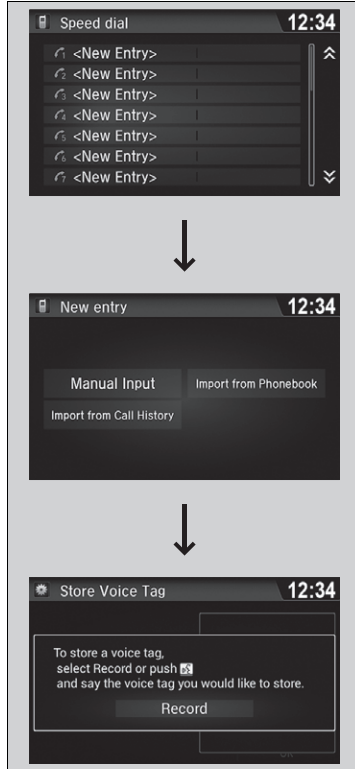

To store a speed dial number:

1. Go to the **Phone menu** screen.

▶ **Phone menu screen** P. 421

2. Select **Speed Dial**.

3. Select **New Entry**.

4. Select a place to choose a number.

From **Import from Call History**:

- ▶ Select a number from the call history.

From **Manual Input**:

- ▶ Input the number manually.

From **Import from Phonebook**:

- ▶ Select a number from the connected cell phone's imported phonebook.

5. When the speed dial is successfully stored, you are asked to create a voice tag for the number. Select **Yes** or **No**.

6. Select **Record** to store a voice tag for the speed dial entry.

- ▶ Using the [RECORD] button, follow the prompts to store a voice tag for the speed dial entry.

## Speed Dial

When a voice tag is stored, press the [RECORD] button to call the number using the voice tag. Say the voice tag name.

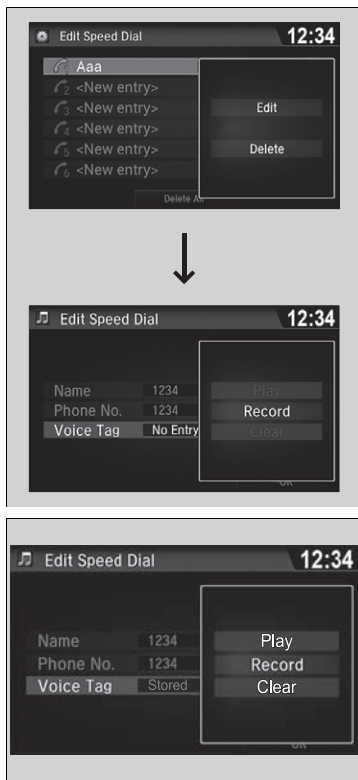

■ **To add a voice tag to a stored speed dial number**

1. Go to the phone settings screen.
  - ▶ **Phone settings screen** P. 418
2. Select **Edit Speed Dial**.
3. Select an existing speed dial entry.
  - ▶ From the pop-up menu, select **Edit**.
4. Select **Voice Tag**.
  - ▶ From the pop-up menu, select **Record**.
5. Select **Record**, or use the  button and follow the prompts to complete the voice tag.

■ **To delete a voice tag**

1. Go to the phone settings screen.
  - ▶ **Phone settings screen** P. 418
2. Select **Edit Speed Dial**.
3. Select an existing speed dial entry.
  - ▶ From the pop-up menu, select **Edit**.
4. Select **Voice Tag**.
  - ▶ From the pop-up menu, select **Clear**.
5. A confirmation message appears on the screen. Select **Yes**.

▶▶ Speed Dial

Avoid using duplicate voice tags.  
 Avoid using "home" as a voice tag.  
 It is easier for the system to recognize a longer name.  
 For example, use "John Smith" instead of "John."

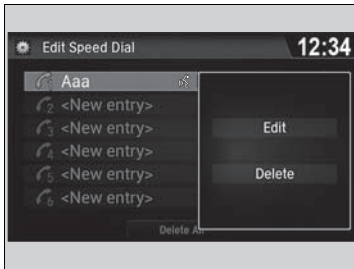

### ■ To edit a speed dial

1. Go to the phone settings screen.
  - ▶ **Phone settings screen** P. 418
2. Select **Edit Speed Dial**.
3. Select an existing speed dial entry.
  - ▶ From the pop-up menu, select **Edit**.
4. Select a setting you want.

### ■ To delete a speed dial

1. Go to the phone settings screen.
  - ▶ **Phone settings screen** P. 418
2. Select **Edit Speed Dial**.
3. Select an existing speed dial entry.
  - ▶ From the pop-up menu, select **Delete**.
4. A confirmation message appears on the screen. Select **Yes**.



## ■ Phonebook Phonetic Modification

Add phonetic modifications or a new voice tag to the phone's contact name so that it is easier for HFL to recognize voice commands.

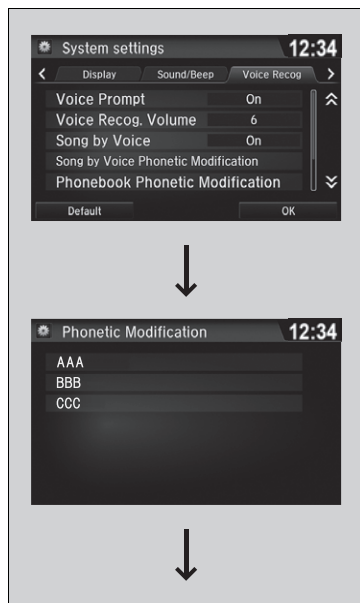

### ■ To add a new voice tag

1. Select .
2. Select **Settings**.
3. Select **System**.
4. Select the **Voice Recog** tab.
5. Select **Phonebook Phonetic Modification**.
6. Select the phone you want to add phonetic modification to.

### ☞ Phonebook Phonetic Modification



You can store up to 20 phonetic modification items.



7. Select **New Voice Tag**.
8. Select a contact name you want to add to.
  - ▶ The pop-up menu appears on the screen.
9. Select **Modify**.
10. Using **Record** or the  button, follow the prompts to complete the voice tag.
11. You will receive a confirmation message on the screen, then select **OK**.



### ■ To modify a voice tag

1. Select .
2. Select **Settings**.
3. Select **System**.
4. Select the **Voice Recog** tab.
5. Select **Phonebook Phonetic Modification**.
6. Select the phone you want to modify phonetic modification.
7. Select a contact name you want to modify.
  - ▶ The pop-up menu appears on the screen.
8. Select **Modify**.
9. Using **Record** or the  button, follow the prompts to complete the voice tag.
10. You will receive a confirmation message on the screen, then select **OK**.

### ▶▶ Phonebook Phonetic Modification

You can only modify or delete contact names for the currently connected phone.



■ **To delete a modified voice tag**

1. Select .
2. Select **Settings**.
3. Select **System**.
4. Select the **Voice Recog** tab.
5. Select **Phonebook Phonetic Modification**.
6. Select the phone you want to delete phonetic modification.
7. Select a contact name you want to delete.
  - ▶ The pop-up menu appears on the screen.
8. Select **Delete**.
  - ▶ The selected contact name has been selected.
9. Select **OK**.



### ■ To delete all modified voice tags

1. Select .
2. Select **Settings**.
3. Select **System**.
4. Select the **Voice Recog** tab.
5. Select **Phonebook Phonetic Modification**.
6. Select the phone you want to delete phonetic modification.
  - ▶ The contact name list appears.
7. Select **Delete All**.
8. You will receive a confirmation message on the screen, then select **Yes**.

## ■ Making a Call

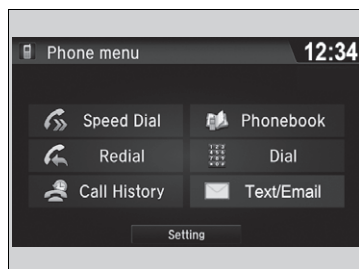

You can make calls by inputting any phone number, or by using the imported phonebook, call history, speed dial entries, or redial.

### ▶▶ Making a Call

Any voice-tagged speed dial entry can be dialed by voice from most screens.

Press the  button and say the voice tag name.

Once a call is connected, you can hear the voice of the person you are calling through the audio speakers.

While there is an active connection with Apple CarPlay™, phone calls cannot be made with HandsFreeLink® and are only made from Apple CarPlay™.



■ **To make a call using the imported phonebook**

1. Go to the **Phone menu** screen.
  - ▶ **Phone menu screen** P. 421
2. Select **Phonebook**.
3. Select a name.
  - ▶ You can also search by letter. Select **Search**.
  - ▶ Use the keyboard on the touch screen for entering name, if multiple numbers exist select a number.
4. Select a number.
  - ▶ Dialing starts automatically.

■ **To make a call using a phone number**

1. Go to the **Phone menu** screen.
  - ▶ **Phone menu screen** P. 421
2. Select **Dial**.
3. Select a number.
  - ▶ Use the keyboard on the touch screen for entering numbers.
4. Select **Dial**.
  - ▶ Dialing starts automatically.

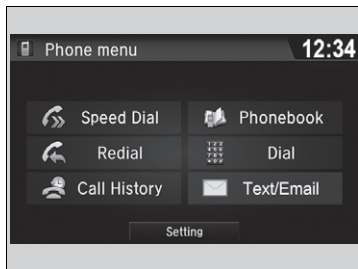

■ **To make a call using redial**

1. Go to the **Phone menu** screen.
  - ▶ **Phone menu screen** P. 421
2. Select **Redial**.
  - ▶ Dialing starts automatically.

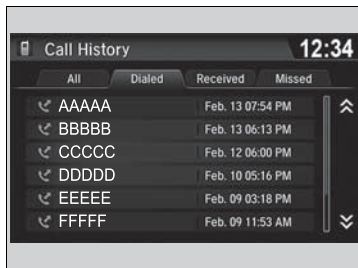

■ **To make a call using the Call History**

Call history is stored by **All, Dialed, Received, and Missed**.

1. Go to the **Phone menu** screen.
  - ▶ **Phone menu screen** P. 421
2. Select **Call History**.
3. Select **All, Dialed, Received, or Missed**.
4. Select a number.
  - ▶ Dialing starts automatically.

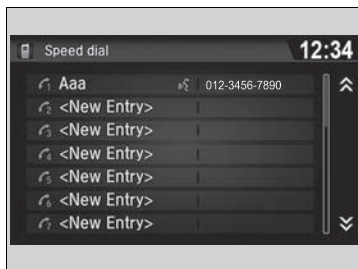

■ **To make a call using a Speed Dial entry**

1. Go to the **Phone menu** screen.
  - ▶ **Phone menu screen** P. 421
2. Select **Speed Dial**.
3. Select a number.
  - ▶ Dialing starts automatically.

▶▶ To make a call using redial

Press and hold the button to redial the last number dialed.

▶▶ To make a call using the Call History

The call history displays the last 20 all, dialed, received, or missed calls. (Appears only when a phone is connected to the system.)

▶▶ To make a call using a Speed Dial entry

When a voice tag is stored, press the button to call the number using the voice tag.



▶ **Speed Dial** P. 429

Any voice-tagged speed dial entry can be dialed by voice from any screen. Press the button and follow the prompts.

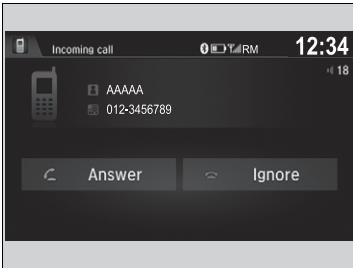
## Receiving a Call



When there is an incoming call, an audible notification sounds (if activated) and the **Incoming call** screen appears.

Press the  button to answer the call.  
Press the  button to decline or end the call.

## Options During a Call

The following options are available during a call.

**Mute:** Mute your voice.

**Transfer:** Transfer a call from the system to your phone.

**Touch Tones:** Send numbers during a call. This is useful when you call a menu-driven phone system.

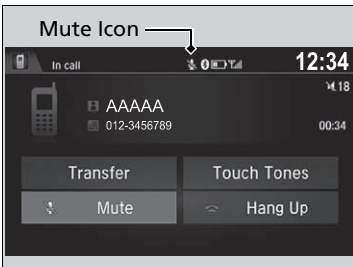

The available options are shown on the lower half of the screen.

Select the option.

- ▶ The mute icon appears when **Mute** is selected. Select **Mute** again to turn it off.

## Receiving a Call



Call Waiting

Press the  button to put the current call on hold to answer the incoming call.

Press the  button again to return to the current call.

Select **Ignore** to ignore the incoming call if you do not want to answer it.

Press the  button if you want to hang up the current call.

You can select the icons on the audio/information screen instead of the  and  buttons.

## Options During a Call

**Touch Tones:** Available on some phones.

You can select the icons on the audio/information screen.



## ■ Receiving a Text Message/E-mail

HFL can display newly received text or e-mail messages as well as 20 of the most recently received messages on a linked cell phone. Each received message can be read aloud and replied to using a fixed common phrase.



1. A pop-up appears and notifies you of a new text message or e-mail.
2. Select **Read** to listen to the message.
  - ▶ The text message or e-mail is displayed. The system automatically starts reading out the message.
3. To discontinue the message read-out, select **Stop**.

## ▣ Receiving a Text Message/E-mail

The system does not display any received messages while you are driving. You can only hear them read aloud.

The system can only receive messages that are sent a text (SMS) messages. The message sent using the data services will not be displayed in the list.

With some phones, you may be able to display up to 20 most recent text messages and e-mails.

State or local laws may limit your use of the HFL text message/e-mail feature. Only use the text message/e-mail feature when conditions allow you to do so safely.

When you receive a text message or e-mail for the first time since the phone is paired to HFL, you are asked to turn the **New Message Notification** setting to **On**.

▶ **To turn on or off the text/e-mail notice**  
P. 426

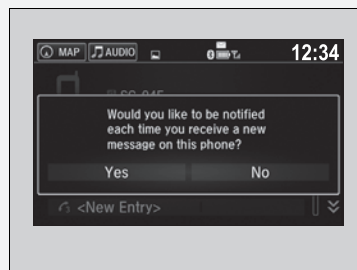

## Selecting a Mail Account

If a paired phone has text message or mail accounts, you can select one of them to be active and receive notifications.

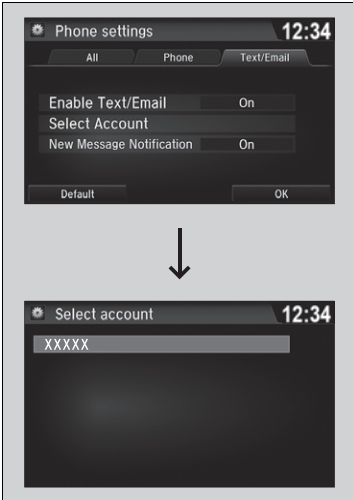

1. Go to the **Phone settings** screen.  
 ▶ **Phone settings screen** P. 418
2. Select the **Text/Email** tab, then **Select Account**.  
 ▶ A pop-up menu appears on the screen.
3. Select **Text Messages** or an e-mail account you want.

## Selecting a Mail Account

You can also select a mail account from the folder list screen or the message list screen.

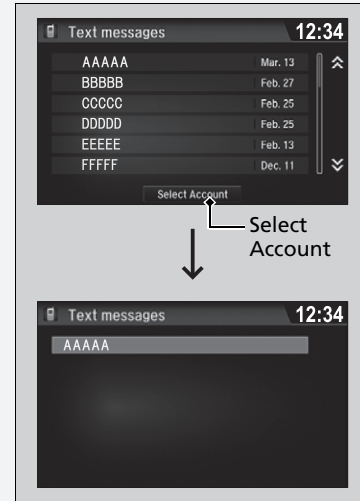

You can only receive notifications from one text message or mail account at a time.

## ■ Displaying Messages

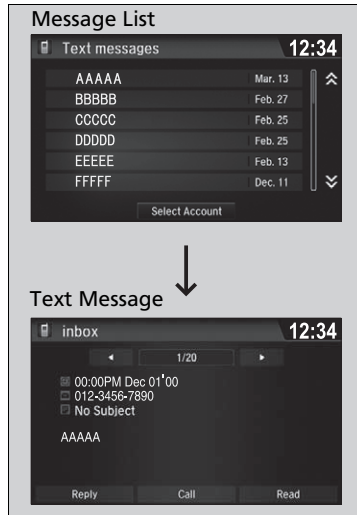



### ■ Displaying text messages

1. Go to the **Phone menu** screen.
  - ▶ **Phone menu screen** P. 421
2. Select **Text/Email**.
  - ▶ Select account if necessary.
3. Select a message.
  - ▶ The text message is displayed. The system automatically starts reading the message aloud.

### »» Displaying Messages

The  icon appears next to an unread message.

If you delete a message on the phone, the message is also deleted in the system. If you send a message from the system, the message goes to your phone's mailbox.

To see the previous or next message, select  (previous) or  (next) on the message screen.

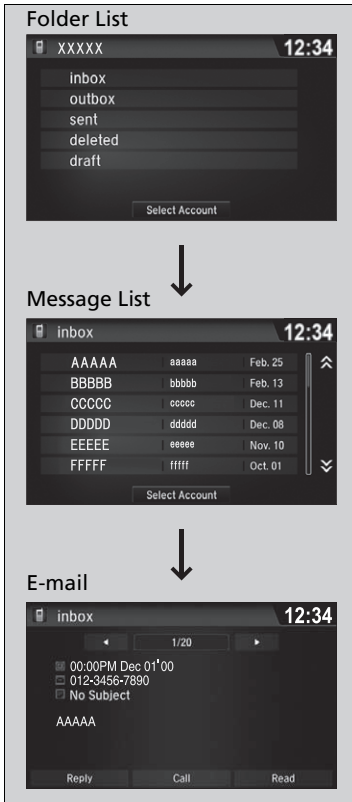

### ■ Displaying e-mails

1. Go to the **Phone menu** screen.
  - ▶ **Phone menu screen** P. 421
2. Select **Text/Email**.
  - ▶ Select **Select Account** if necessary.
3. Select a folder.
4. Select a message.
  - ▶ The e-mail is displayed. The system automatically starts reading the message aloud.

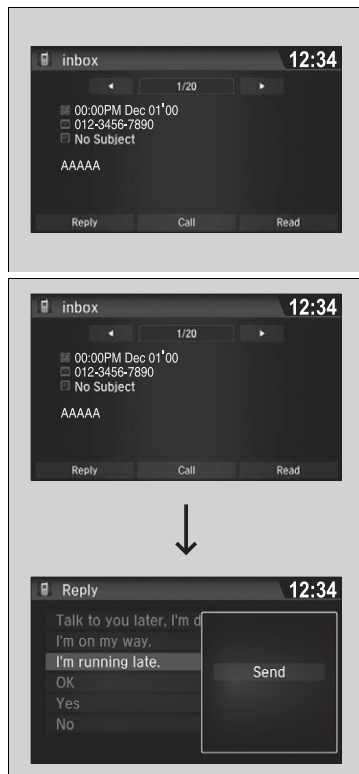

### ■ Read or Stop reading a message

1. Go to the text or e-mail message screen.
  - ▶ The system automatically starts reading the message aloud.
  - ☑ **Displaying Messages** P. 442
2. Select **Stop** to stop reading. Select **Read** again to start reading the message from the beginning.

### ■ Reply to a message

1. Go to the text or e-mail message screen.
  - ▶ The system automatically starts reading the message aloud.
  - ☑ **Displaying Messages** P. 442
2. Select **Reply**.
3. Select the reply message.
  - ▶ The pop-up menu appears on the screen.
4. Select **Send** to send the message.
  - ▶ **Complete** appears on the screen when the reply message was successfully sent.

### ☑ Reply to a message

The available fixed reply messages are as follows:

- **Talk to you later, I'm driving.**
- **I'm on my way.**
- **I'm running late.**
- **OK**
- **Yes**
- **No**

You cannot add, edit, or delete reply messages.

Only certain phones receive and send messages when paired and connected. For a list of compatible phones:

- U.S.: Visit [www.handsfreelink.honda.com](http://www.handsfreelink.honda.com), or call 1-888-528-7876.
- Canada: Visit [www.handsfreelink.ca](http://www.handsfreelink.ca), or call 1-888-528-7876.

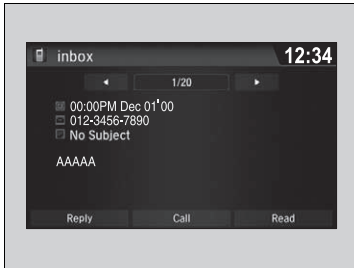

### ■ Making a call to a sender

1. Go to the text message screen.
2. Select **Call**.

## ■ In Case of Emergency

### ■ Automatic collision notification

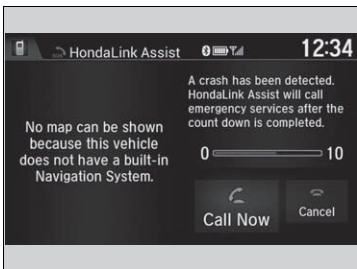

If your vehicle's airbags deploy or if the unit detects that the vehicle is severely impacted, your vehicle automatically will attempt to connect to the HondaLink® operator. If connected, information about your vehicle, its location, and its condition can be sent to the operator\*1; you also can speak to the operator when connected.

**IMPORTANT:** For vehicles equipped with HondaLink® Assist, owner activation constitutes authorization for Honda to collect information from your vehicle needed to provide the service, and agreement to the Terms of Use at [www.hondalink.com/TermsAndConditions](http://www.hondalink.com/TermsAndConditions). In a crash, HondaLink® Assist will attempt to notify emergency services but NEITHER HONDA NOR ITS SERVICE PROVIDERS GUARANTEE THAT SUCH NOTIFICATION WILL OCCUR.

Honda reserves the right to terminate HondaLink® Assist services at any time or for any reason, and in the future may not be able to provide services due to changes in, or obsolescence of, technology integral to the service or changes in governmental regulation.

\*1: Depending on your phone and adequate cellular coverage, your vehicle's location may not be sent to the operator.

## ☒ In Case of Emergency

Your vehicle may not be able to connect to the operator if the battery level is low, the line is disconnected, or you do not have adequate cellular coverage.

You cannot use this emergency service when:

- You travel outside the HondaLink® service coverage areas.
- There is a problem with the connecting devices, such as the microphones, speakers, or the unit itself.

You cannot operate other phone-related functions using the screen while talking to the operator. Select **Hang Up** to terminate the connection to your vehicle.

## ☒ Automatic collision notification

If the unit fails to connect to the operator, it repeatedly tries until it succeeds.

## ■ To enable notification

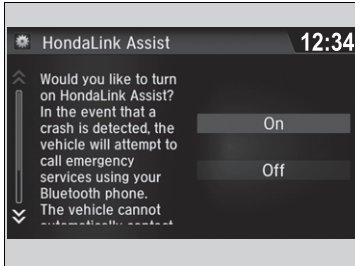

1. Go to the **Phone settings** screen.  
 ▶ **Phone settings screen** P. 418
2. Select the **Phone** tab, then **HondaLink Assist**.  
 ▶ A pop-up menu appears on the screen.
3. Select **On** or **Off**.

## ☒ To enable notification

Setting options:

- **On:** Notification is available.
- **Off:** Disable the feature.





When you set the power mode to ON, the compass self-calibrates, and the compass display appears.

#### Models without navigation system

## Compass Calibration

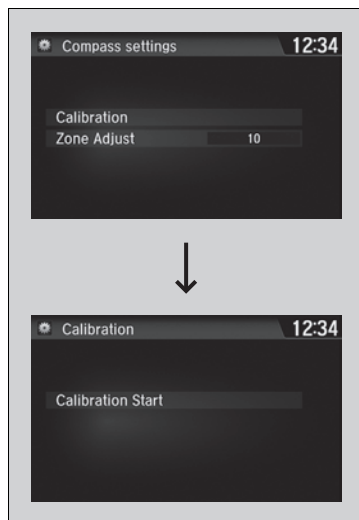
If the compass indicates the wrong direction, or the **CAL** indicator blinks, you need to manually calibrate the system.



1. Set the power mode to ON.
2. On the top screen of any audio source, press and hold  for five seconds.
  - ▶ The display switches to the **Compass settings** screen.
3. Select **Calibration**.
4. Select **Calibration Start**.
5. Drive the vehicle slowly in two circles.
  - ▶ The compass starts to show a direction after the calibration. The **CAL** indicator goes off.

#### Compass\*

Compass operation can be affected under the following conditions:

- Driving near power lines or stations
- Crossing a bridge
- Passing a large vehicle, or driving near a large object that can cause a magnetic disturbance
- When accessories such as antennas and roof racks are mounted by magnets

#### Compass Calibration

Calibrate the compass in an open area.

While setting the compass, select  to cancel the setting mode and return to the previous screen.

#### Models with navigation system

Models with navigation self-calibrate using GPS. The compass in the MID and the direction arrow on the map screen (when **Track Up** view selected) may not be in sync when first starting the vehicle, but should correct themselves as you drive.

If the compass in the MID continues to indicate an incorrect direction, please see your Honda dealer.

## Compass Zone Selection

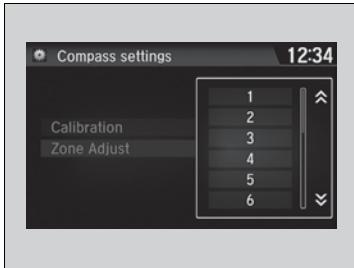

1. Set the power mode to ON.
2. On the top screen of any audio source, press and hold  for five seconds.
  - ▶ The display switches to the **Compass settings** screen.
3. Select **Zone Adjust**.
  - ▶ The display shows the current zone number the system is set to.
4. Select the zone number of your area (See Zone Map).

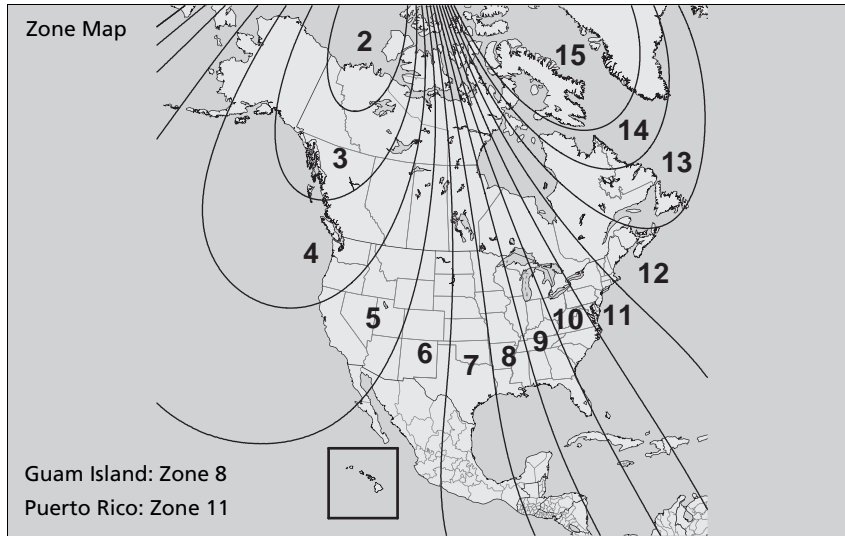

### ☒ Compass Zone Selection

The zone selection is done to compensate the variation between magnetic north and true north.

If the calibration starts while the audio system is in use, the display returns to normal after the calibration is completed.



# Driving



This chapter discusses driving, refueling, and information on items such as accessories.

<b>Before Driving</b> .....	452
<b>Towing a Trailer</b> .....	458
<b>Off-Highway Driving Guidelines</b> .....	469
<b>When Driving</b>	
Starting the Engine .....	471
Automatic Transmission .....	478
Shifting .....	479
Auto Idle-stop * .....	489
Intelligent Traction Management* .....	495
Cruise Control* .....	497
Front Sensor Camera* .....	500
Adaptive Cruise Control (ACC)* .....	502
Road Departure Mitigation (RDM) System* .....	514
Lane Keeping Assist System (LKAS)* ..	519

Vehicle Stability Assist (VSA®), aka Electronic Stability Control (ESC), System .....	527
Agile Handling Assist .....	529
Blind spot information (BSI) System* .....	530
LaneWatch™* .....	532
Intelligent VT4 (i-VTM4)* .....	534
Tire Pressure Monitoring System (TPMS) with Tire Fill Assist .....	535
Tire Pressure Monitoring System (TPMS) - Required Federal Explanation .....	537
<b>Braking</b>	
Brake System .....	539
Anti-lock Brake System (ABS) .....	541
Brake Assist System .....	542

Collision Mitigation Braking System™ (CMBS™)* .....	543
<b>Parking Your Vehicle</b>	
When Stopped .....	552
Parking Sensor System* .....	553
Cross Traffic Monitor* .....	557
<b>Multi-view rear camera*</b> .....	561
<b>Refueling</b>	
Fuel Information .....	562
How to Refuel .....	563
<b>Fuel Economy and CO<sub>2</sub> Emissions</b>	
Improving Fuel Economy and Reducing CO <sub>2</sub> Emissions .....	565

\* Not available on all models

## Driving Preparation

Check the following items before you start driving.

### Exterior Checks

- Make sure there are no obstructions on the windows, door mirrors, exterior lights, or other parts of the vehicle.
  - ▶ Remove any frost, snow, or ice.
  - ▶ Remove any snow on the roof, as this can slip down and obstruct your field of vision while driving. If frozen solid, remove ice once it has softened.
  - ▶ When removing ice from around the wheels, be sure not to damage the wheel or wheel components.
- Make sure the hood is securely closed.
  - ▶ If the hood opens while driving, your front view will be blocked.
- Make sure the tires are in good condition.
  - ▶ Check air pressure, check for damage and excessive wear.
    - 🔍 **Checking and Maintaining Tires** P. 597
- Make sure there are no people or objects behind or around the vehicle.
  - ▶ There are blind spots from the inside.

### Exterior Checks

#### NOTICE

When doors are frozen shut, use warm water around the door edges to melt any ice. Do not try to force them open, as this can damage the rubber trim around the doors. When done, wipe dry to avoid further freezing.

Do not pour warm water into the key cylinder. You will be unable to insert the key if the water freezes in the hole.

Heat from the engine and exhaust can ignite flammable materials left under the hood, causing a fire. If you've parked your vehicle for an extended period, inspect and remove any debris that may have collected, such as dried grass and leaves that have fallen or have been carried in for use as a nest by a small animal. Also check under the hood for leftover flammable materials after you or someone else has performed maintenance on your vehicle.

## Interior Checks

- Store or secure all items on board properly.
  - ▶ Carrying too much cargo, or improperly storing it, can affect your vehicle's handling, stability, stopping distance, and tires, and make it unsafe.
    - ✦ **Maximum Load Limit** P. 455
- Do not pile items higher than the seat height.
  - ▶ They can block your view and may be thrown forward in the event of sudden braking.
- Do not place anything in the front seat footwells. Make sure to secure the floor mat.
  - ▶ An object or unsecured floor mat can interfere with your brake and accelerator pedal operation while driving.
- If you have any animals on board, do not let them move around in the vehicle.
  - ▶ They may interfere with driving and a crash could occur.
- Securely close and lock all doors and the tailgate.
  - ✦ **Locking/Unlocking the Doors from the Inside** P. 131
- Adjust your seating position properly.
  - ▶ Adjust the head restraint, too.
    - ✦ **Adjusting the Seats** P. 174
    - ✦ **Adjusting the Head Restraints** P. 179
- Adjust the mirrors and steering wheel properly for your driving.
  - ▶ Adjust them while sitting in the proper driving position.
    - ✦ **Adjusting the Steering Wheel** P. 171
    - ✦ **Adjusting the Mirrors** P. 172

## Interior Checks

The headlight aim is set by the factory, and does not need to be adjusted. However, if you regularly carry heavy items in the cargo area or tow a trailer, have the aiming readjusted at a dealer or by a qualified technician.

- Be sure items placed on the floor behind the front seats cannot roll under the seats.
  - ▶ They can interfere with the driver's ability to operate the pedals, the operation of the seats, or the operation of the sensors under the seats.
- Everyone in the vehicle must fasten their seat belt.
  - 📄 **Fastening a Seat Belt** P. 40
- Make sure that the indicators in the instrument panel come on when you start the vehicle, and go off soon after.
  - ▶ Always have a dealer check the vehicle if a problem is indicated.
    - 📄 **Indicators** P. 78

## Maximum Load Limit

### ELITE and TRG grade with AWD models

The maximum load for your vehicle is 1,173 lbs (532 kg).

### Except ELITE and TRG grade with AWD models

The maximum load for your vehicle is 1,340 lbs (608 kg).

### All models

See the Tire and Loading Information label attached to the driver's doorjamb.

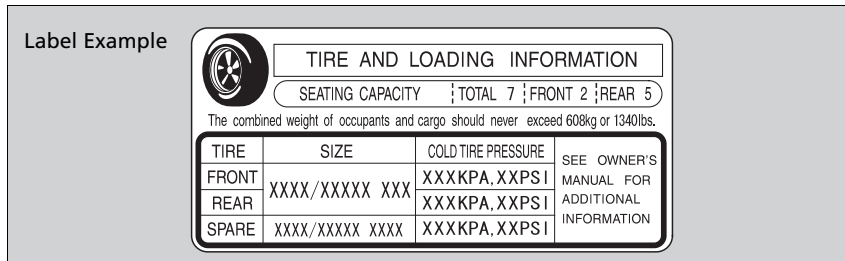

This figure includes the total weight of all occupants, cargo, and accessories, and the tongue load if you are towing a trailer.

Steps for Determining Correct Load Limit -

- (1) Locate the statement "The combined weight of occupants and cargo should never exceed XXX kg or XXX lbs." on your vehicle's placard.
- (2) Determine the combined weight of the driver and passengers that will be riding in your vehicle.
- (3) Subtract the combined weight of the driver and passengers from XXX kg or XXX lbs.

Continued

### Maximum Load Limit

## ⚠ WARNING

Overloading or improper loading can affect handling and stability and cause a crash in which you can be hurt or killed.

Follow all load limits and other loading guidelines in this manual.

Gross Vehicle Weight Rating (GVWR):

The maximum allowable weight of the vehicle, all occupants, all accessories, all cargo, and the tongue load.

➤ Specifications P. 652

Gross Axle Weight Rating (GAWR):

The maximum allowable weight of the vehicle axle.







➤ Specifications P. 652



- (4)** The resulting figure equals the available amount of cargo and luggage load capacity. For example, if the “XXX” amount equals 1,400 lbs. and there will be five 150 lb. passengers in your vehicle, the amount of available cargo and luggage load capacity is 650 lbs.  
(1,400 - 750 (5 x 150) = 650 lbs.)
- (5)** Determine the combined weight of luggage and cargo being loaded on the vehicle. That weight may not safely exceed the available cargo and luggage load capacity calculated in step 4.
- (6)** If your vehicle will be towing a trailer, load from your trailer will be transferred to your vehicle. Consult this manual to determine how this reduces the available cargo and luggage load capacity of your vehicle.

In addition, the total weight of the vehicle, all occupants, accessories, cargo, and trailer tongue load must not exceed the Gross Vehicle Weight Rating (GVWR) or the Gross Axle Weight Rating (GAWR). Both are on a label on the driver's doorjamb.

**Load Limits Example**

Example1		$\leq$		+	
	<p>Max Load 1,173 lbs (532 kg)</p>		<p>Passenger Weight 150 lbs x 2 = 300 lbs (68 kg x 2 = 136 kg)</p>		<p>Cargo Weight 873 lbs (396 kg)</p>
Example2		$\leq$		+	
	<p>Max Load 1,173 lbs (532 kg)</p>		<p>Passenger Weight 150 lbs x 5 = 750 lbs (68 kg x 5 = 340 kg)</p>		<p>Cargo Weight 423 lbs (192 kg)</p>

## Towing Preparation

### Towing Load Limits

Your vehicle can tow a trailer if you carefully observe the load limits, use the proper equipment, and follow the towing guidelines. Check the load limits before driving.

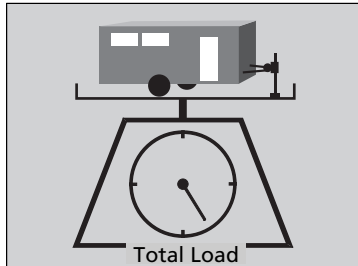

#### ■ Total trailer weight

Do not exceed the maximum allowable weight of the trailer, cargo, and everything in or on it shown in the table.

Towing loads in excess of this can seriously affect vehicle handling and performance and can damage the engine and drivetrain.

Number of occupants	AWD models with ATF cooler	AWD models without ATF cooler	2WD models
2	5,000 lbs (2,268 kg)	3,500 lbs (1,588 kg)	3,500 lbs (1,588 kg)
3	4,750 lbs (2,155 kg)	3,250 lbs (1,474 kg)	3,250 lbs (1,474 kg)
4	4,500 lbs (2,041 kg)	3,000 lbs (1,361 kg)	3,000 lbs (1,361 kg)
5	4,250 lbs (1,928 kg)	2,750 lbs (1,247 kg)	2,750 lbs (1,247 kg)
6	4,000 lbs (1,814 kg)	2,500 lbs (1,134 kg)	2,500 lbs (1,134 kg)
7	2,500 lbs (1,134 kg)	2,250 lbs (1,021 kg)	2,250 lbs (1,021 kg)
8	Towing not recommended		

Each weight limit is calculated based on the following conditions:

- Occupants fill seats from the front of the vehicle to the back
  - Each occupant weights 150 lbs (68 kg)
  - Each occupant has 15 lbs (7 kg) of cargo in the cargo area
- Any additional weight, cargo or accessories reduce the maximum trailer weight and maximum tongue load.

### Towing Load Limits

## ⚠ WARNING

Exceeding any load limit or improperly loading your vehicle and trailer can cause a crash in which you can be seriously hurt or killed.

Check the loading of your vehicle and trailer carefully before starting to drive.

Check if all loads are within limits at a public scale. If a public scale is not available, add the estimated weight of your cargo load to the weight of your trailer (as quoted by the manufacturer), and then measure the tongue load with an appropriate scale or tongue gauge or estimate it based on cargo distribution.

Refer to the trailer owner's manual for additional information.

#### Break-in Period

Avoid towing a trailer during your vehicle's first 600 miles (1,000 km).

Never exceed the gross weight ratings.  
Gross weight information

➤ **Vehicle Specifications** P. 652

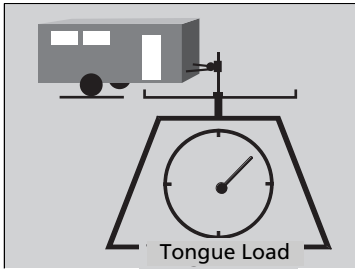

■ **Tongue load**

The weight of the tongue with a fully loaded trailer on the hitch should be approximately:

Boat trailers: 5 – 15% of the total trailer weight

Other trailers: 10 – 15% of total trailer weight

Number of occupants	AWD models with or without ATF cooler	2WD models
2	500 lbs (227 kg)	350 lbs (159 kg)
3	475 lbs (215 kg)	325 lbs (147 kg)
4	450 lbs (204 kg)	300 lbs (136 kg)
5	375 lbs (170 kg)	275 lbs (125 kg)
6	250 lbs (113 kg)	240 lbs (109 kg)
7	125 lbs (57 kg)	115 lbs (52 kg)
8	Towing not recommended	

■ **To estimate the tongue load**

Excessive tongue load reduces front tire traction and steering control. Too little tongue load can make the trailer unstable and cause it to sway.

You can estimate the tongue load by measuring the trailer hitch height from the ground in the following steps:

1. Park the vehicle on level ground.
2. Measure the distance between the ground and the bottom of the trailer hitch.
3. Connect the fully loaded trailer to the hitch.
4. Measure the distance between the ground and the bottom of the trailer hitch again.
5. Subtract the second measurement from the first measurement, then refer to the following table.

If the difference is	AWD models	2WD models
1 inches (2.5 cm)	150 lbs (68 kg)	
1 1/2 inches (3.8 cm)	250 lbs (114 kg)	
2 inches (5.1 cm)	350 lbs (159 kg)	
2 3/8 inches (6.0 cm)	450 lbs (205 kg)	—
2 5/8 inches (6.7 cm)	500 lbs (227 kg)	—

If the difference becomes more than indicated in the table, distribute the load or remove cargo as needed.

### ■ How to weigh the trailer loads using the public scale

Check each weight in the order indicated as shown.

Refer to the table on the right for each weight's limit except for the tongue load.

#### 🔍 Tongue load P. 459

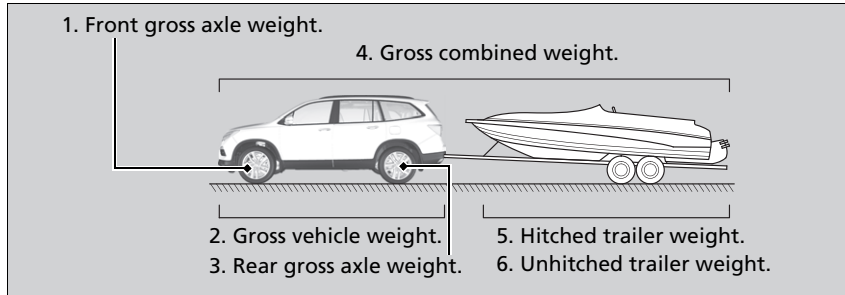

- If you cannot weigh the rear axle, subtract 1 from 2.
- The maximum gross combined weight (4) decreases by 2% for every 1,000 feet (305 meters) of elevation.
- To calculate the tongue load, subtract 5 from 6.
- Refer to the trailer owner's manual for additional information.

### 🔍 How to weigh the trailer loads using the public scale

Fully load the vehicle and trailer. An attendant who watches the scale is needed as all occupants should stay in the vehicle.

Weight limit for	2WD models	AWD models
Front gross axle	2,734 lbs (1,240 kg)	2,855 lbs (1,295 kg)
Gross vehicle	5,545 lbs (2,515 kg)	5,842 lbs (2,650 kg)
Rear gross axle	2,921 lbs (1,325 kg)	3,097 lbs (1,405 kg)
Gross combined	8,025 lbs (3,640 kg)	9,755 lbs (4,425 kg)

If a public scale is not available, add the estimated weight of your cargo load to the weight of your trailer (as quoted by the manufacturer), and then measure the tongue load with an appropriate scale or tongue gauge or estimate it based on cargo distribution.

## ■ Towing Equipment and Accessories

Towing generally requires a variety of supplemental equipment. To ensure the best quality, we recommend that you purchase Honda equipment whenever possible.

### ■ Trailer brakes

Recommended for any trailer with a total weight of 1,000 lbs (450 kg) or more: There are two common types of trailer brakes: surge and electric. Surge brakes are common for boat trailers, since the brakes will get wet. If you choose electric brakes, be sure they are electronically actuated. Do not attempt to attach trailer brakes to your vehicle's hydraulic system, as it will lower braking effectiveness and create a potential hazard.

The 4-pin gray connector installed in your vehicle has all of the circuits required to install most electric trailer brake controllers.

#### Trailer brake controller connector's terminals:

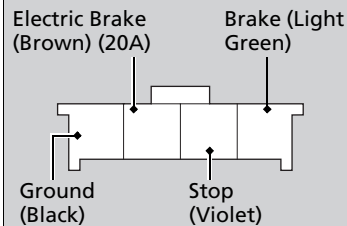

Have a qualified mechanic install your trailer brake controller following the trailer brake controller manufacturer's instructions. Failure to properly install the trailer brake controller may increase the distance it takes for you to stop your vehicle when towing a trailer.

## ▶▶ Towing Equipment and Accessories

Make sure that all equipment is properly installed and maintained, and that it meets federal, state, province/territory, and local regulations.

Consult your trailer maker for proper installation and setup of the equipment. Improper installation and setup can affect the handling, stability, and braking performance of your vehicle.

Consult your trailer sales or rental agency if any other items are recommended or required for your towing situation.

The lighting and wiring of trailers can vary by type and brand. If a connector is required, it should only be installed by a qualified technician.

Trailer packages and products:

- Ball mount, hitch plug, hitch pin etc.
- Wiring harness kit
- Trailer hitch kit (jumper harness included)

#### ▶▶ Trailer brakes P. 462

- Automatic transmission cooler
- Are available at a dealer.

## ▶▶ Trailer brakes

The 4-pin gray connector is located under the instrument panel near the top of the parking brake pedal.

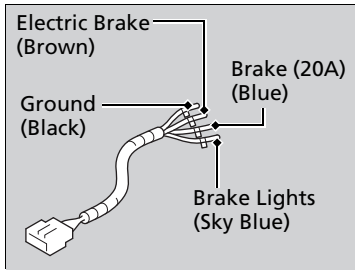

The trailer hitch harness is used to install the controller for the electric trailer brakes. Insert the trailer brake fuse into the engine compartment sub fuse box.

➤ **Engine Compartment Fuse Box Type B**

P. 643



### ■ Trailer light

Trailer lights and equipment must comply with federal, state, province/territory, and local regulations. Check with your local trailer sales or rental agency for the requirements in the area where you plan to tow.

### ▶▶ Trailer light

The trailer lighting connector is located behind the left side panel in the cargo area. Even if you are planning to use the non-Honda trailer lighting harness and converter, ask a dealer for the correct connector and pins.

#### Pins' wiring color codes and their purposes:

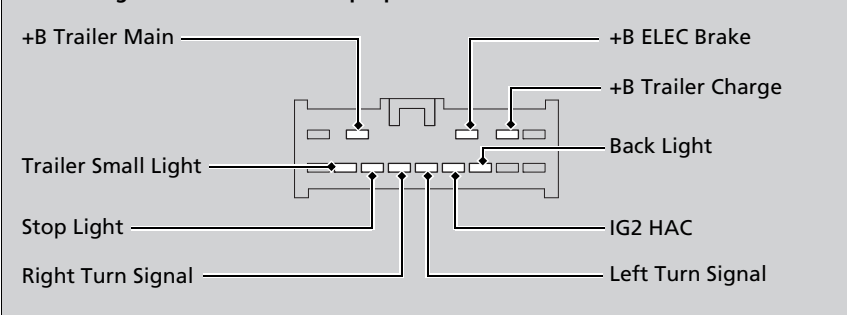

We recommend that you have a dealer install a Honda wiring harness and converter. They are designed for your vehicle.

### ■ Hitches

Read the trailer manufacturer's instructions, and select the appropriate draw bar for the height of the trailer you will be towing.

### ■ Weight distribution hitches

Your vehicle is designed to tow without the need for a load distributing hitch. If you wish to use one, please consult your trailer maker for proper installation and set-up. Improper set-up could degrade the handling, stability, and braking performance of your vehicle.

### ■ Safety chains

Always use safety chains when you tow a trailer. Leave enough slack to allow the trailer to turn corners easily, but do not allow the chains to drag on the ground.

### ■ Sway control

This device can be used if your trailer tends to sway. Your trailer maker can tell you what kind of sway control you need and how to install it. Improper installation could degrade the handling and stability of your vehicle.

### ■ Trailer mirrors

Many states, provinces and territories require special exterior mirrors when towing a trailer. Install special mirrors whenever you cannot clearly see behind you, or if the trailer creates a blind spot.

### ■ Automatic transmission cooler

#### AWD models

An additional ATF (automatic transmission fluid) cooler is required to keep the transmission from overheating when towing more than 3,500 lbs (1,588 kg). You can get the additional ATF cooler at a dealer.

## Trailer Stability Assist

Helps to stabilize the vehicle and trailer when the trailer severely sways.

### ■ How trailer stability assist works

When the vehicle and trailer become unstable while driving, trailer stability assist determines the cause. If the trailer oscillation is detected as the cause, and the swaying increases, the system applies the brakes or controls engine output to reduce vehicle speed.

Both the vehicle and trailer brake lights come on automatically if you brake to reduce vehicle speed.

### ⓘ Trailer Stability Assist

Trailer stability assist is not a function that prevents the vehicle and trailer from swaying. Avoid high speeds, abrupt steering, improper trailer load, and sudden braking to keep the trailer from swaying. When swayed too severely, the system becomes ineffective, and you may lose control of your vehicle, causing the trailer to roll over or get damaged.

➤ **Driving Safely with a Trailer** P. 467

Trailer towing sway is caused by:

- Crosswinds
- Improper towbar down load
- Excessive Speed

The VSA® system indicator blinks during the trailer stability assist operation.

➤ **VSA® Operation** P. 527

## Driving Safely with a Trailer

### ■ Things You Need To Know Before Towing a Trailer

- Have the trailer properly serviced and keep it in good condition.
- Make sure that all the weights and load in the vehicle and trailer are within limits.
  - ▶ **Towing Load Limits** P. 458
- When towing more than 3,500 lbs (1,590 kg), use of gasoline with a pump octane number of 87 or higher is recommended.
  - ▶ Towing performance can be affected by high altitude, high temperature, or steep uphill.
- Securely attach the hitch, safety chains, and other necessary parts to the trailer.
- Securely store all the items in and on the trailer so that they do not shift while driving.
- Check if the lights and brakes on the trailer are working properly.
- Check the pressures of the trailer tires, including the spare.

### ■ Towing Speeds and Gears

- Drive slower than normal.
- Obey posted speed limits for vehicles with trailers.
- Use the **[D]** position when towing a trailer on level roads.

### ■ Turning and Braking

- Turn more slowly and with a wider turning arc than normal.
- Allow more time and distance for braking.
- Do not brake or turn suddenly.

#### ▣ Driving Safely with a Trailer

Operating speed when towing a trailer is restricted up to 62 mph (100 km/h).

#### Parking

In addition to the normal precautions, place wheel chocks at each of the trailer's tires.

#### ▣ Towing Speeds and Gears

When towing a fixed-sided trailer (e.g., camper), do not exceed 55 mph (88 km/h).  
At higher speeds, the trailer may sway or affect vehicle handling.

## ■ Driving in Hilly Terrain

- Monitor your temperature gauge. If it nears the red (Hot) mark, turn off the climate control system and reduce speed. Pull to the side of the road safely to cool down the engine if necessary.

### Automatic transmission models with shift lever

- Shift to the **[D4]** position if the transmission shifts frequently.

### Automatic transmission models with electronic gear selector

- Change the gear position to **[S]** position if the transmission shifts frequently.

## ■ Retrieving a Boat

### Automatic transmission models with shift lever

If the vehicle tires slip when retrieving a boat from the water, keep the transmission in **[D]**. This prevents damage to the transmission.

### Automatic transmission models with electronic gear selector

If the vehicle tires slip when retrieving a boat from the water, keep the transmission in **[D]** and do not use the sequential shift mode in **[S]**. This prevents damage to the transmission.

## Towing Your Vehicle

---

Your vehicle is not designed to be towed behind a motor home. If your vehicle needs to be towed in an emergency, refer to the emergency towing information.

➤ **Emergency Towing** P. 647

## General Information

Your vehicle has been designed primarily for use on pavement, however, its higher ground clearance allows you to occasionally travel on unpaved roads. It is not designed for trail-blazing, or other challenging off-road activities.

If you decide to drive on unpaved roads, you will find that it requires somewhat different driving skills and that your vehicle will handle somewhat differently than it does on pavement. Pay attention to the precautions and tips in this section, and get acquainted with your vehicle before leaving the pavement.

## Important Safety Precautions

To avoid loss of control or rollover, be sure to follow all precautions and recommendations:

- Be sure to store cargo properly and do not exceed your cargo load limits.
  - **Maximum Load Limit** P. 455
- Whenever you drive, make sure you and your passengers always wear seat belts.
- Keep your speed low, and never go faster than the conditions allow.
- It's up to you to continually assess the situation and drive within the limits.

\* Not available on all models

### Off-Highway Driving Guidelines

## **⚠ WARNING**

Improperly operating this vehicle on or off pavement can cause a crash or rollover in which you and your passengers can be seriously injured or killed.

- Follow all instructions and guidelines in this owner's manual.
- Keep your speed low, and don't drive faster than conditions permit.

Failure to operate your vehicle correctly might result in a crash or a rollover.

- **Important Handling Information** \* P. 34
- **Precautions While Driving** P. 477

Spinning the tires excessively can also damage the Intelligent VT M4 (i-VT M4) system.

## Avoiding Trouble

---

- **Check Out Your Vehicle** before you leave the pavement and make sure that all scheduled maintenance has been completed. Pay special attention to the condition of the tires, and check the tire pressures.
- **Remember** the route you choose presents limits (too steep or bumpy), you have limits (driving skill and comfort), and your vehicle has limits (traction, stability, and power). Failing to recognize these limits will likely put you and your passengers in a hazardous situation.
- **Accelerating and Braking** should be done slowly and gradually. Trying to start or stop too fast can cause a loss of traction and you could lose control.
- **Avoiding Obstacles and Debris** in the road reduces the likelihood of a rollover or damage to your suspension or other components.
- **Driving on Slopes** increases your risk of a rollover, particularly if you attempt to drive across a slope that is too steep. Going straight up or down a slope is usually the safest. If you can't clearly see all conditions or obstacles on a slope, walk it before you drive it. If there is any doubt whether you can safely pass, don't try it. Find another route. If you get stuck when climbing, do not try to turn around. Back down slowly following the same route you took up the hill.
- **Crossing a Stream** - Avoid driving through deep water. If you encounter water in your route (a small stream or large puddle, for example), evaluate it carefully before going ahead. Make sure it is shallow, flowing slowly, and has firm ground underneath. If you are not sure of the depth or the ground, turn around and find another route. Driving through deep water can also damage your vehicle. The water can get into the transmission and differential, diluting the lubricant and causing an eventual failure. It can also wash the grease out of the wheel bearings.
- **If You Get Stuck**, carefully go in the direction that you think will get you unstuck. Do not spin the tires as this will only make things worse and could damage the transmission. If you are unable to free yourself, your vehicle will need to be towed. Front and rear tow hooks are provided for this purpose.

## Starting the Engine

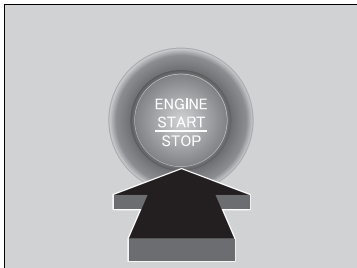
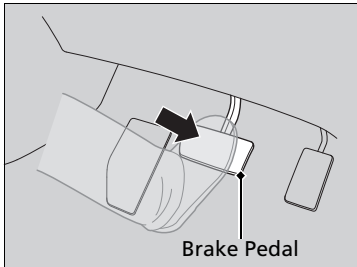

### Models with electronic gear selector

1. Depress the brake pedal.
  - ▶ Make sure the transmission is in **P**.

### Models without electronic gear selector

1. Check that the shift lever is in **P**, then depress the brake pedal.
  - ▶ Although it is possible to start the vehicle in **N**, it is safer to start it in **P**.

### All models

2. Press the **ENGINE START/STOP** button without depressing the accelerator pedal. The engine will crank until it starts.

### Starting the Engine

Keep your foot firmly on the brake pedal when starting the engine.

The engine is harder to start in cold weather and in thinner air found at altitudes above 8,000 feet (2,400 meters).

When starting the engine in cold weather, turn off all electrical accessories such as the lights, climate control system, and rear defogger in order to reduce battery drain.

If you live in a region where winter is extremely cold, an engine block heater will improve starting and warming of the engine. Consult a dealer for details.

If the exhaust system sounds abnormal or you can smell exhaust gas inside the vehicle, have your vehicle checked by a dealer. There may be a problem with the engine or exhaust system.

Bring the smart entry remote close to the **ENGINE START/STOP** button if the battery in the smart entry remote is weak.

#### ▶ If the Smart Entry Remote Battery is Weak P. 630

The engine may not start if the smart entry remote is subjected to strong radio waves.

Do not hold the **ENGINE START/STOP** button to start the engine.

If the engine does not start, wait at least 30 seconds before trying again.



## ■ Stopping the Engine

You can turn the engine off when the vehicle is completely stopped.

1. Change the gear position to **P**.
2. Press the **ENGINE START/STOP** button with your foot on the brake pedal.

## ▶▶ Starting the Engine

The immobilizer system protects your vehicle from theft.

If an improperly coded device is used, the engine's fuel system is disabled.



▶ **Immobilizer System** P. 143

## Remote Engine Start\*

You can remotely start the engine using the smart entry remote.

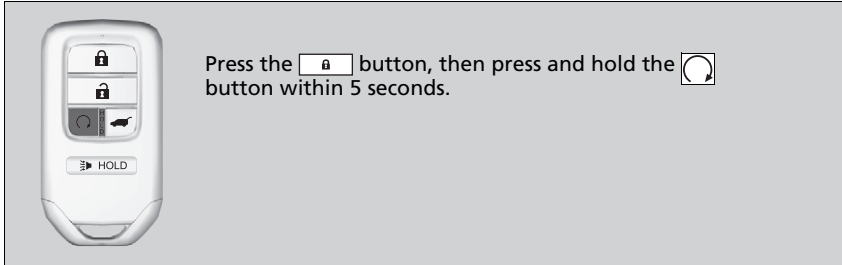
### To start the engine



The engine runs for up to 10 minutes without you starting the vehicle. To extend the run time for another 10 minutes during the first run, press the  button, then press and hold the  button.

- ▶ The turn signal lights come back on three times, twice, if a 10-minute extension request was transmitted successfully.

### Remote Engine Start\*

## ⚠ WARNING

Engine exhaust contains toxic carbon monoxide.

Breathing carbon monoxide can kill you or cause unconsciousness.



Never use the remote engine starter when the vehicle is parked in a garage or other area with limited ventilation.

### Remote Engine Start run timer extension

The engine runs for another 10 minutes from the time of extension request. The max engine run time is 20 minutes, if the extension request is made after 10 minutes of first engine run.

If there are buildings and obstacles between your vehicle and the remote, the range will be reduced. This distance may vary by external electrical interference.

The engine may not start by the remote engine start if:

- You have disabled a remote engine start setting using the multi-information display (MID).
- You do not press and hold the  button within 5 seconds after the  button is pressed.
- The power mode is not in VEHICLE OFF (LOCK).
- The gear is in a position other than .

## ■ To stop the engine

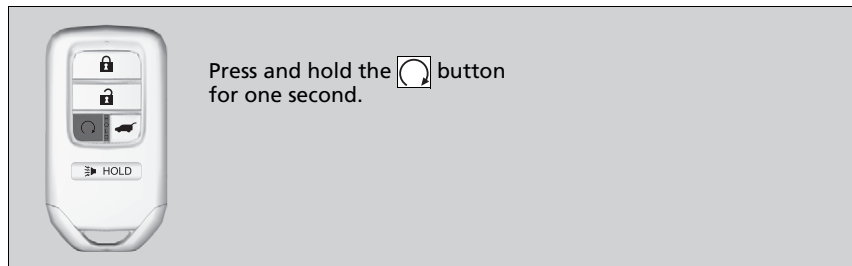

### ⊗ Remote Engine Start\*

- The hood is open, or any door or the tailgate is unlocked.
- You have already used the remote twice to start the engine.
- Another registered smart entry remote is in the vehicle.
- There is any antenna failure.
- Door is unlocked with the built-in key.
- The engine oil pressure is low.
- The engine coolant temperature is extremely high.
- The telematics unit malfunctions.
- The security system alarm is not set.

The engine may stop while it is running if:

- You do not start the vehicle within 10 minutes of starting the engine with the smart entry remote.
- The engine is stopped by using the smart entry remote.
- There is any antenna failure.
- The security system alarm is not set.
- Door is unlocked with the built-in key.
- The hood is open, or any door, or the tailgate is unlocked.
- Any door is open.
- The gear is in a position other than **P**.
- The telematics unit malfunction.
- The engine coolant temperature is extremely high.
- The battery is low.
- The engine oil pressure is low.
- The Malfunction Indicator Lamp (MIL) comes on if there is a problem with the emissions control systems.

## ▶▶ Remote Engine Start\*

While the engine is running, the vehicle will automatically precondition inside the vehicle.

When it is warm outside:

- The climate control system is activated in recirculation mode.
- The seat ventilation is activated\*.

When it is cold outside:

- The defroster is activated at a moderately warm temperature.
- The rear defogger and door mirror heaters are activated\*.
- The seat heaters and heated steering wheel are activated\*.

▶▶ **Heated Steering Wheel\*** P. 200

▶▶ **Front Seat Heaters and Seat Ventilation\*** P. 202, 203

\* Not available on all models

## Starting to Drive

When the engine was started using the smart entry remote\*

1. Depress the brake pedal and press the **ENGINE START/STOP** button simultaneously.

When the engine was started in any case

2. Keeping your right foot on the brake pedal, release the parking brake. Check that the parking brake indicator has gone off.  
➔ **Parking Brake** P. 539
3. Change the gear position to **[D]**. Select **[R]** when reversing.
4. Gradually release the brake pedal and gently depress the accelerator pedal to pull away.

### Hill start assist system

Hill start assist keeps the brake engaged briefly to help prevent the vehicle from rolling on inclines as you move your foot from the brake pedal to the accelerator.

Change the gear position to **[D]**, **[D4]\***, **[S]\***, or **[L]\*** when facing uphill, or **[R]** when facing downhill, then release the brake pedal.

The brakes remain engaged briefly as you release the brake pedal.

## Starting to Drive

When the engine was started using the smart entry remote\*

The engine stops when the gear position is changed from **[P]** before the **ENGINE START/STOP** button is pressed. Follow the step 1 when starting to drive.

### Hill start assist system

Hill start assist may not prevent the vehicle from rolling downhill on a very steep or slippery slope, and will not operate on small inclines.

Hill start assist is not a replacement for the parking brake.

## Precautions While Driving

### Driving Guidelines for Your Utility Vehicle

Utility vehicles have a significantly higher rollover rate than other types of vehicles. To prevent rollovers or loss of control:

- Take corners at slower speeds than you would with a passenger vehicle.
- Avoid sharp turns and abrupt maneuvers whenever possible.
- Do not modify your vehicle in any way that you would raise the center of gravity.
- Do not carry heavy cargo on the roof.

Never carry more than 165 lbs (75 kg) of cargo on the roof rack (Honda accessory).

### In Rain

Avoid driving in deep water and on flooded roads. This can damage the engine, driveline, or cause electrical component failure.

### Other Precautions

If there is a strong impact with something under the vehicle, stop in a safe location. Check the underside of the vehicle for damage or any fluid leaks.

### Precautions While Driving

#### NOTICE

Do not change the gear position while pressing the accelerator pedal. You could damage the transmission.

#### NOTICE

If you repeatedly turn the steering wheel at an extremely low speed, or hold the steering wheel on the full left or right position for a while, the electric power steering (EPS) system heats up. The system goes into a protective mode, and limits its performance. The steering wheel becomes harder and harder to operate. Once the system cools down, the EPS system is restored. Repeated operation under these conditions can eventually damage the system.

If the power mode is set to ACCESSORY while driving, the engine will shut down and all steering and brake power assist functions will stop, making it difficult to control the vehicle.

Do not change the gear position to **[N]**, as you will lose engine braking (and acceleration) performance.

During the first 600 miles (1,000 km) of operation, avoid sudden acceleration or full throttle operation so as not to damage the engine or powertrain.

Avoid hard braking for the first 200 miles (300 km). You should also follow this when the brake pads are replaced.

## Automatic Transmission

### ■ Creeping

The engine runs at a higher idle speed and creeping increases. Keep the brake pedal firmly depressed when stopped.

### ■ Kickdown

Quickly depressing the accelerator pedal while driving uphill may cause the transmission to drop to a lower gear, unexpectedly increasing vehicle speed. Depress the accelerator pedal carefully, especially on slippery roads and curves.

### » Driving Guidelines for Your Utility Vehicle

Failure to operate your vehicle correctly might result in a crash or a rollover.

- ▶ **Important Handling Information**\* P. 34
- ▶ **Precautions While Driving** P. 477

Automatic transmission models with shift lever

# Shifting

Change the shift position in accordance with your driving needs.

## ■ Shift lever positions



The diagram shows a silver automatic transmission shift lever. A 'Release Button' is located on the top of the lever, and a 'D4 Button' is located on the base of the lever. The base of the lever is marked with the letters P, R, N, D, L, and D4.

- P** **Park**  
Used when parking or starting the engine
- R** **Reverse**  
Used when reversing
- N** **Neutral**  
Used when idling
- D** **Drive**  
Used:
  - For normal driving (gears change between 1st and 6th automatically)
- L** **Low**
  - Strong engine power when climbing and strong engine braking when going down steep hills.
- D4** **Drive (D4)**  
Press the **D4** button while the shift lever is in **D**.  
Used when:
  - Going up or down hills
  - Towing a trailer in hilly terrain

Continued

## ☒ Shifting

You cannot change the power mode from ON to VEHICLE OFF (LOCK) unless the shift lever is in **P**.

The vehicle may move forward very slightly even in **N** while the engine is cold. Depress the brake pedal firmly and, when necessary, apply the parking brake.

When shifting gears in extremely low temperatures (-22°F/-30°C), there may be a short delay before the shift indicated in the display. Always confirm you are in the correct gear before driving.



## ■ Shift Lever Operation

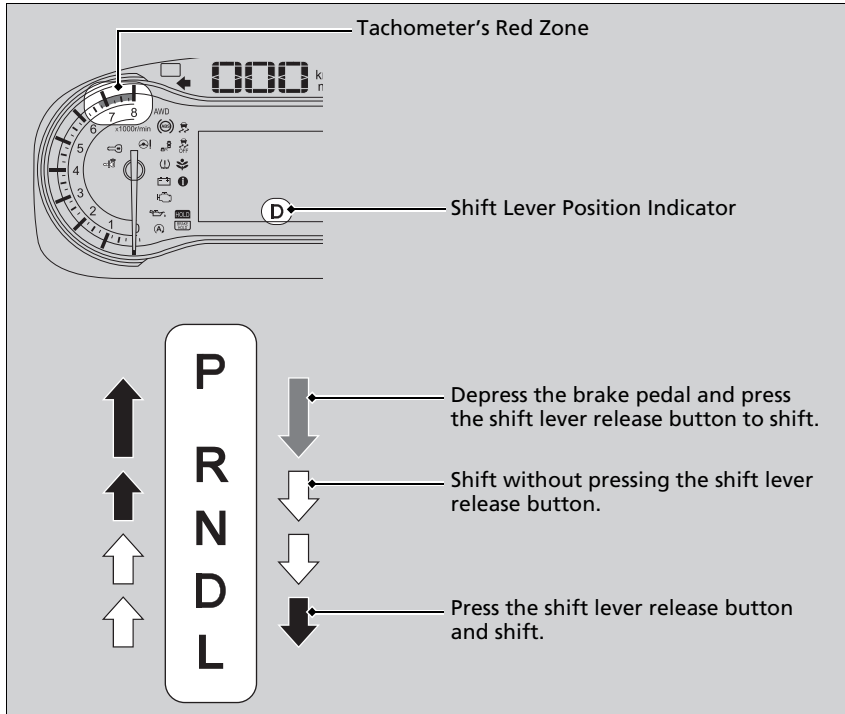

## ▶▶ Shift Lever Operation

### NOTICE

When you change the shift lever from **D** to **R** and vice versa, come to a complete stop and keep the brake pedal depressed. Operating the shift lever before the vehicle has come to a complete standstill can damage the transmission.

Use the shift lever position indicator to check the lever position before pulling away.

Whichever position the shift lever is in when driving, a blinking transmission indicator indicates a transmission problem. Avoid sudden acceleration and have the transmission checked by a dealer as soon as possible.

The fuel supply may be cut off if you drive at engine speeds in or over the tachometer's red zone (engine speed limit). If this happens, you may experience a slight jolt.

It may not be possible to operate the shift lever if the brake pedal is applied while the shift lever release button is held down. Depress the brake pedal first.

Automatic transmission models with electronic gear selector

## Shifting

Change the gear position in accordance with your driving needs.

### ■ Shift button positions



- P** **Park**  
Used when parking or starting the engine
- R** **Reverse**  
Used when reversing
- N** **Neutral**  
Used when idling
- D** **Drive**  
Used for:
- Normal driving (gears change between 1st and 9th automatically)
  - Temporarily driving in the sequential mode
- S** **Drive (S)**  
Used for:
- Automatically changing gears between 1st and 8th (8th gear is used only at high speed)
  - Driving in the sequential mode

### ☒ Shifting

To prevent malfunction and unintended engagement:

- Do not spill any liquids on or around shift buttons.
- Do not place or drop any objects on or around shift buttons.
- Do not let passengers or children operate the shift buttons.

### **⚠ WARNING**

The vehicle can roll away if left unattended without confirming that Park is engaged.

Always keep your foot on the brake pedal until you have confirmed that **P** is shown on the gear position Indicator.

The beeper sounds when you depress the accelerator pedal with the gear position in **N**. Change the gear position to **D** or **R** with the brake pedal depressed.

When shifting gears in extremely low temperatures (–22°F/–30°C), there may be a short delay before the shift is indicated in the display. Always confirm you are in the correct gear before driving.

■ **P (park) button**

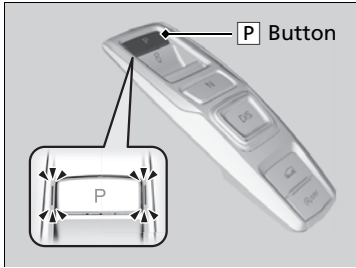

Park your vehicle in a safe place with the power mode in ON, then apply the brakes and press the **P** button to put the transmission in Park.

The indicators on the sides of the **P** button come on.

## Shift Operation

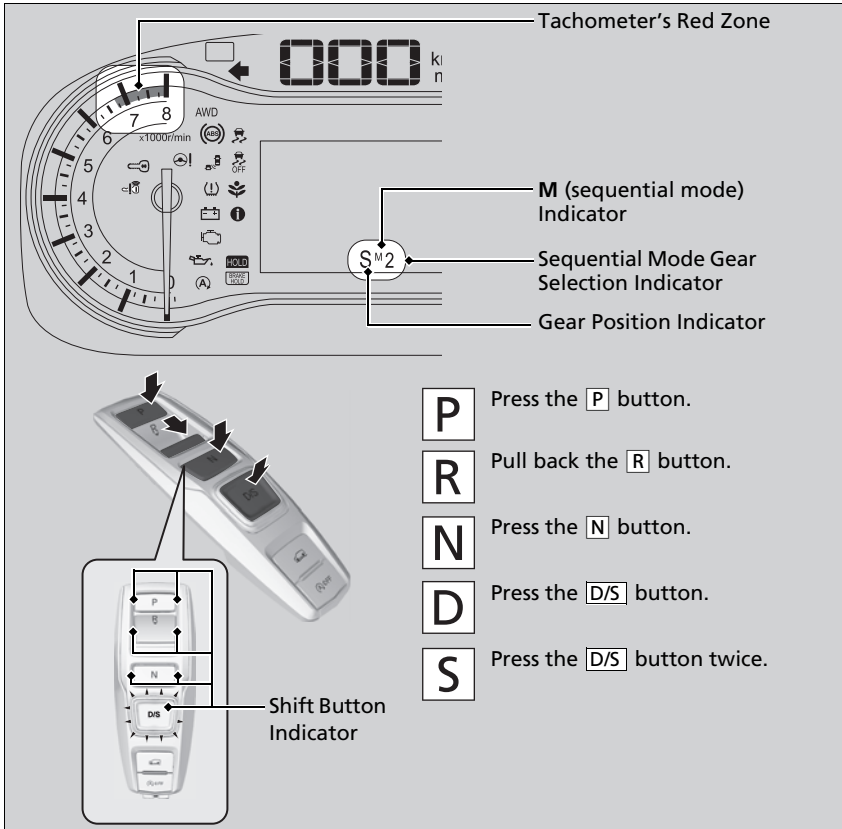

Continued

## Shift Operation

### NOTICE

When you change **D** to **R** and visa versa, depress the brake pedal to come to a complete stop, then select the intended gear position while maintaining brake pressure.

Use the gear position indicator and the shift button indicator to check the gear position before selecting a shift button.

If the indicator of the currently selected gear position, or all the gear position indicators are blinking simultaneously, there is a problem with the transmission.

Avoid sudden acceleration and have the transmission checked by a dealer as soon as possible.

The fuel supply may be cut off if you drive at engine speeds in or over the tachometer's red zone (engine speed limit). If this happens, you may experience a slight jolt.

When the engine speed is increased while the transmission is in **N**, **P** or **R**, the fuel supply may be cut off even without the engine speed entering the tachometer's red zone.

From the MID, you can choose to have the system activate a beeper when you change to **R**.

▶ **Customized Features P. 351**

In freezing or sub-freezing conditions, the electronic gear selector response may be slow.

Always depress the brake pedal before changing the gear position to **P**, and confirm that **P** is shown on the gear position indicator before releasing the brake.

### ■ When opening the driver's door

If you open the driver's door under the following conditions, the gear position automatically changes to **P**.

- The vehicle is stationary with the engine running, or moving at 1 mph (2 km/h) or slower.
- The transmission is in other than **P**.
- You have unfastened the driver side seat belt.

- ▶ If you manually change the gear position from **P** with the brake pedal depressed, the gear position will automatically return to **P** once you release the brake pedal.

### ■ When turning off the power mode

If you turn the engine off while the vehicle is stationary, and the transmission is in other than **P**, the gear position automatically changes to **P**.

### ⚠ When opening the driver's door

You should always select **P** before opening the driver's door.

Make sure to park the vehicle in a safe place.

➡ **When Stopped** P. 552

If you want to drive the vehicle after the gear position has automatically changed to **P** under the described conditions, close the door, fasten the seat belt, depress the brake pedal, then change the gear position.

If you leave the vehicle, turn off the engine and lock the doors.

■ If you want to keep the transmission in **[N]** position [car wash mode]

With the engine running:

1. Press and hold the brake pedal.
2. Select **[N]**, then release the button to display (Neutral) **[N]** hold mode on the MID.
3. Press and hold **[N]** again for two seconds.
  - ▶ This puts the vehicle in car wash mode which must be used when your vehicle is pulled through a conveyor type automatic car wash where you or an attendant do not remain in the vehicle.

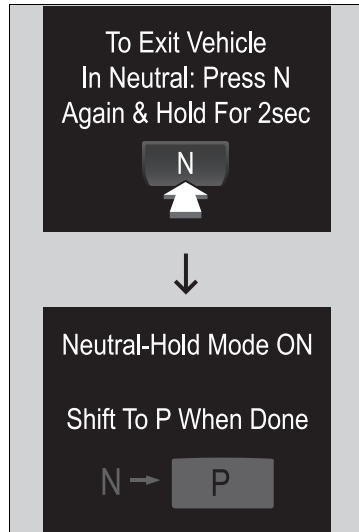

If the **ENGINE STOP/START** button is pressed after car wash mode has been activated, the power mode will change to ACCESSORY and a message will be displayed on the MID.

- ▶ For 15 minutes the gear position remains in **[N]** with the power mode in ACCESSORY. After that, the position automatically changes to **[P]** and the power mode changes to OFF.
- ▶ Manually changing to **[P]** cancels ACCESSORY mode. The **[P]** indicator comes on and the power mode changes to OFF. You must always shift to **[P]** when car wash mode is no longer needed.

⊗ If you want to keep the transmission in **[N]** position [car wash mode]

The transmission may not stay in **[N]** position while the following indicator is on:

- Transmission system indicator

**■ Restriction on selecting a gear position**

You cannot select a gear position under certain circumstances that may lead to unexpected crashes or damage.

When the transmission is in:	1. Under the circumstances of that:	2. You cannot select:	3. The gear position remains in/changes to:	How to change the gear position
<b>P</b>	The brake pedal is not depressed.	Other gear position	<b>P</b>	Release the accelerator pedal and depress the brake pedal.
	The accelerator pedal is depressed.			
<b>N</b>	The vehicle is moving at low speed without the brake pedal depressed.		<b>N</b>	
	The vehicle is moving at low speed with the accelerator pedal depressed.			
<b>N, D or S</b>	The vehicle is moving forward.		<b>R</b>	
<b>R or N</b>	The vehicle is moving backward.	<b>D, S</b>		
<b>R, N, D or S</b>	The vehicle is moving.	<b>P</b>	Stop your vehicle in a safe place, keep the brake pedal pressed, and select the appropriate gear position.	

## Sequential Mode

Use the paddle shifters to change between 1st and 9th gears without removing your hands from the steering wheel. The transmission will switch to the sequential mode.

### ■ When the transmission is in **D**:

The vehicle will go into the sequential mode momentarily, and the sequential mode gear selection indicator will come on.

Once you start traveling at a constant speed, the sequential mode will automatically switch off, and the sequential mode gear selection indicator will go off.

Hold the **+** paddle shifter for two seconds or push **D/S** button to return to normal drive.

### ■ When the transmission is in **S**:

The vehicle will go into the sequential mode, and the **M** (sequential mode) indicator and sequential mode gear selection indicator will come on.

If the vehicle speed increases and the engine speed reaches near the tachometer's red zone, the transmission automatically shifts up to the next gear.

You can cancel this mode by holding the **+** paddle shifter for two seconds or push **D/S** button. When the sequential mode is canceled, the sequential mode indicator and sequential mode gear selection indicator go off.



## ■ Sequential Mode Operation



## ▶ Sequential Mode Operation

Each paddle shift operation makes a single gear change.  
To change gears continuously, release the paddle shifter before pulling it again for the next gear.

### Recommended Shift Points

Use this table as a guideline for efficient fuel economy and effective emission control.

Shift Up	Normal Acceleration
1st to 2nd	15 mph (24 km/h)
2nd to 3rd	25 mph (40 km/h)
3rd to 4th	40 mph (64 km/h)
4th to 5th	47 mph (76 km/h)
5th to 6th	52 mph (84 km/h)
6th to 7th	57 mph (92 km/h)
7th to 8th	62 mph (100 km/h)
8th to 9th	67 mph (108 km/h)

If the sequential mode gear selection indicator blinks when you try to shift up or down, this means your vehicle speed is not in its allowable gear range. Slightly accelerate to shift up and decelerate to shift down while the indicator is blinking.

## Auto Idle-stop\*

To help maximize fuel economy, the engine automatically stops when the vehicle comes to a stop, depending on environmental and vehicle operating conditions. The indicator comes on.

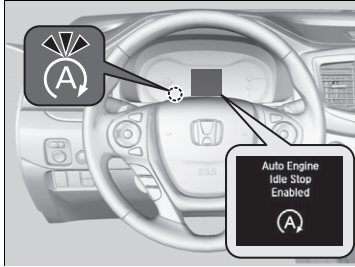

The engine then restarts once the vehicle is about to move again, or depending on environmental and vehicle operating conditions, and the indicator goes off.

➤ **The Engine Automatically Restarts When**  
P. 493

A message associated with Auto Idle-stop appears on the MID.

➤ **Indicators** P. 90

➤ **Customized Features** P. 351

If the driver's door is opened while the indicator is on, a buzzer sounds to notify you that the Auto Idle-stop function is in operation.

### Auto Idle-stop\*

The 12-volt battery installed in this vehicle is specifically designed for a model with Auto Idle-stop. Using a 12-volt battery other than this specified type may shorten the battery life, and prevent Auto Idle-stop from activating. If you need to replace the battery, make sure to select the specified type. Ask a dealer for more details.

The duration of the Auto Idle-stop operation:

- **Increases** in the ECON mode, compared to when the ECON mode is off, with climate control in use.

Auto Idle-stop may activate less frequently in such conditions as a traffic jam.

## ■ Auto Idle-stop System ON/OFF



To turn the Auto Idle-stop system off, press this button. The Auto Idle-stop system stops.

- ▶ The Auto Idle-stop system will stop and the indicator (Amber) in meter will come on.

The Auto Idle Stop system is turned on every time you start the engine, even if you turned it off the last time you drove the vehicle.

## ■ Auto Idle-stop Activates When:

The vehicle stops with the gear position in **[D]** and the brake pedal depressed.

### ■ Auto Idle-stop does not activate when:

- The driver's seat belt is not fastened.
- The engine coolant temperature is low or high.
- The transmission fluid temperature is low or high.
- The vehicle comes to a stop again before the vehicle speed reaches 3 mph (5 km/h) after the engine starts.
- Stopped on a steep incline.
- A gear position other than **[D]**.
- The engine is started with the hood open.
  - ▶ Turn off the engine. Close the hood before you restart the engine to activate Auto Idle-stop.
- The battery charge is low.
- The internal temperature of the battery is 14°F (–10°C). or less.

## ▶▶ Auto Idle-stop System ON/OFF

Press the Auto Idle-stop **OFF** button to restart the engine from the idling stop.

## ▶▶ Auto Idle-stop Activates When:

Do not open the hood while the Auto Idle-stop function is activated. If the hood is opened, the engine will not restart automatically.

In this case, restart the engine with the **ENGINE START/STOP** button.

▶▶ **Starting the Engine** P. 471

Pressing the **ENGINE START/STOP** button changes the power mode to ACCESSORY even while Auto Idle-stop is in operation. Once in ACCESSORY, the engine no longer restarts automatically. Follow the standard procedure to start the engine.

▶▶ **Starting the Engine** P. 471

- The climate control system is in use, and the outside temperature is below  $-4^{\circ}\text{F}$  ( $-20^{\circ}\text{C}$ ) or over  $104^{\circ}\text{F}$  ( $40^{\circ}\text{C}$ ).
- The climate control system temperature is set to the **Hi** or **Lo**.
-  is ON (indicator on).
- When the rear fan is set to maximum speed.
  - ▶ Auto Idle-stop may not activate under other conditions when the rear climate control system is in use.
- When the Intelligent Traction Management is set to Snow, Mud\*, or Sand\*.

■ **Auto Idle-stop may not activate when:**

- The vehicle is stopped by braking suddenly.
- The steering wheel is operated.
- The fan speed is high.
- Altitude is high.
- The vehicle is repeatedly accelerated and decelerated at a low speed.
- The climate control system is in use, and there is a significant difference between the set temperature and the actual interior temperature.
- Humidity in the interior is high.

## ■ The Engine Automatically Restarts When

The brake pedal is released.

### ■ The engine restarts even if the brake pedal is depressed when

- The Auto Idle-stop **OFF** button is pressed.
- When a steering wheel is operated.
- The gear position is in a position other than **D**.
- The pressure on the brake pedal is reduced and the vehicle starts moving while stopped on an incline.
- The pressure on the brake pedal is repeatedly applied and released slightly during a stop.
- The battery charge becomes low.
- The accelerator pedal is depressed.
- The driver's seat belt is unlatched.
-  is ON (indicator on).
- The climate control system is in use, and the difference between the set temperature and actual interior temperature becomes significant.
- The climate control system is being used to dehumidify the interior.

## ■ Starting Assist Brake Function

Briefly keeps the brakes applied after releasing the brake pedal to restart the engine. This can keep your vehicle from unexpectedly moving while on an incline.

### ☒ The Engine Automatically Restarts When

- If you are using an electronic device during Auto Idle-stop, the device may temporarily be turned off when the engine restarts.

## ECON Button

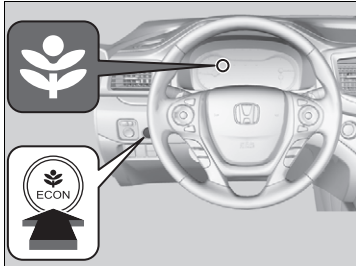

The **ECON** button turns the ECON mode on and off.

The ECON mode helps you improve your fuel economy by adjusting the performance of the engine, air conditioning system, and cruise control.

## Intelligent Traction Management\*

The Intelligent Traction Management optimizes vehicle performance to help you drive on various surfaces. The system has available modes to select from: Normal, Snow, Mud\*, and Sand\*.

Press the mode button to select the appropriate mode. The mode you select appears on the MID. When the vehicle is turned off and restarted, Intelligent Traction Management mode will revert to Normal.

**AWD models**

**Normal**  
Provides balanced driving performance on most road surfaces.

**Snow**  
Use when driving on snowy road surfaces.

**Mud**  
Use when driving on muddy road or off-road surfaces.

**Sand**  
Use when driving on soft, sandy road or off-road surfaces.

Mode Button

### Intelligent Traction Management\*

Refer to the Off-Highway Driving section for driving tips and safety precautions.

➤ **Off-Highway Driving Guidelines** P. 469

\* Not available on all models



2WD models

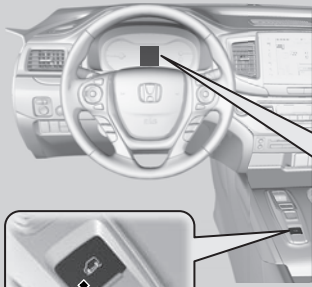

Snow Button



**Normal**  
Provides balanced driving performance on most road surfaces.

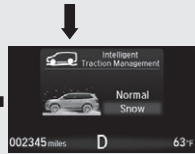

**Snow**  
Use when driving on snowy road surfaces.

# Cruise Control\*

Maintains a constant vehicle speed without having to keep your foot on the accelerator. Use cruise control on freeways or open roads where you can travel at a constant speed with little acceleration or deceleration.

### When to use

■ Vehicle speed for cruise control:  
Desired speed in a range above roughly 25 mph (40 km/h) ~

Always keep sufficient distance between you and the vehicle in front of you.

■ Gear positions for cruise control:  
In **D**



### How to use

■ Press the **CRUISE** button on the steering wheel.

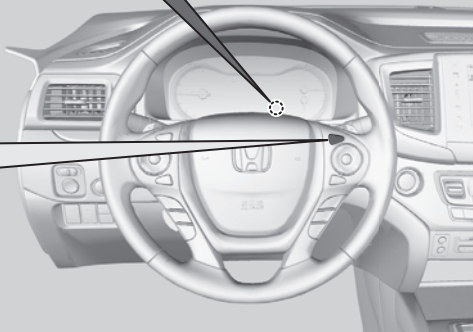

**CRUISE MAIN** is on in the instrument panel. Cruise control is ready to use.

### ⚠ Cruise Control\*

## ⚠ WARNING

Improper use of the cruise control can lead to a crash.

Use the cruise control only when traveling on open highways in good weather.

It may not be possible to maintain a constant speed when driving uphill or downhill.

When not using cruise control:  
Turn off cruise control by pressing the **CRUISE** button.

While in the ECON mode, it may take relatively more time to accelerate to maintain the set speed.

Cruise control is not available when the Intelligent Traction Management Snow, Mud\* or Sand\* modes are in operation.

\* Not available on all models

## ■ To Set the Vehicle Speed

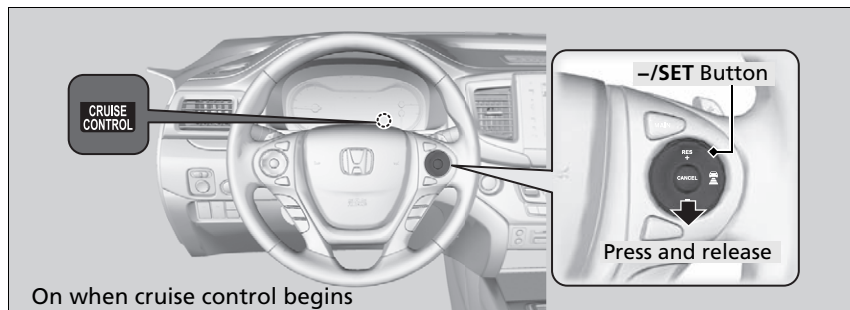

Take your foot off the pedal and press the **-/SET** button when you reach the desired speed.

The moment you release the **-/SET** button, the set speed is fixed, and cruise control begins. The **CRUISE CONTROL** indicator comes on.

### ■ To Adjust the Vehicle Speed

Increase or decrease the vehicle speed using the **RES/+** or **-/SET** buttons on the steering wheel.

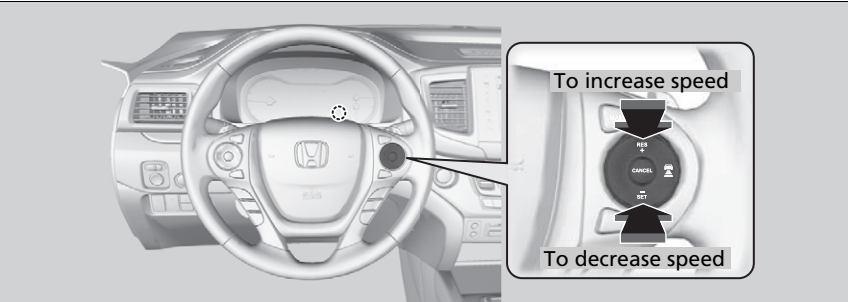

- Each time you press the button, the vehicle speed is increased or decreased by about 1 mph (1.6 km/h).
- If you keep the button pressed, the vehicle speed increases or decreases until you release it. This speed is then set.

### ■ To Cancel

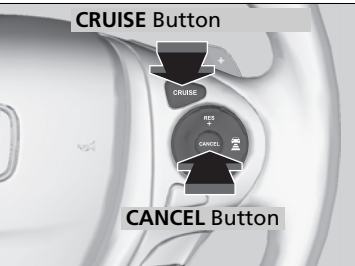

To cancel cruise control, do any of the following:

- Press the **CRUISE** button.
- Press the **CANCEL** button.
- Depress the brake pedal.

The **CRUISE CONTROL** indicator goes off.

### ☒ To Adjust the Vehicle Speed

You can set the vehicle speed using the **-/SET** button on the steering wheel when adjusting the speed with the accelerator and brake pedals.

### ☒ To Cancel

Resuming the prior set speed: After cruise control has been canceled, you can still resume the prior set speed by pressing the **RES/+** button while driving at a speed of at least 25 mph (40 km/h) or more.

- You cannot set or resume in the following situations:
- When vehicle speed is less than 25 mph (40 km/h)
  - When the **CRUISE** button is turned off

At vehicle speeds of 22 mph (35 km/h) or less, cruise control is canceled automatically.

## Front Sensor Camera\*

The camera, used in systems such as LKAS, RDM, ACC, and CMBS™, is designed to detect an object that triggers any of the systems to operate its functions.

### ■ Camera Location and Handling Tips

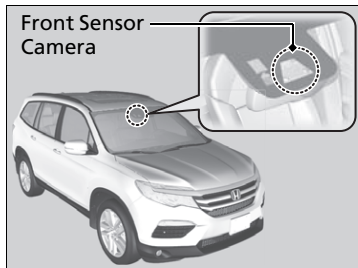

This camera is located behind the rearview mirror.

To help reduce the likelihood that high interior temperatures will cause the camera's sensing system to shut off, when parking, find a shady area or face the front of the vehicle away from the sun. If you use a reflective sun shade, do not allow it to cover the camera housing.

Covering the camera can concentrate heat on it.

### ▣ Front Sensor Camera\*

Never apply a film or attach any objects to windshield, the hood, or the front grill that could obstruct the camera's field of vision and cause the system to operate abnormally.

Scratches, nicks, and other damage to the windshield within the camera's field of vision can cause the system to operate abnormally. If this occurs, we recommend that you replace the windshield with a genuine Honda replacement windshield. Making even minor repairs within the camera's field of vision or installing an aftermarket replacement windshield may also cause the system to operate abnormally. After replacing the windshield, have a dealer recalibrate the camera. Proper calibration of the camera is necessary for the system to operate properly.

Do not place an object on the top of the instrument panel. It may reflect onto the windshield and prevent the system from detecting lane lines properly.

## Front Sensor Camera\*

If the **Some Driver Assist Systems Cannot**

**Operate:**  message appears:

- Use the climate control system to cool down the interior and, if necessary, also use defroster mode with the air flow directed toward the camera.
- Start driving the vehicle to lower the windshield temperature, which cools down the area around the camera.

If the **Some Driver Assist Systems Cannot**

**Operate:**  message appears:

- Park your vehicle in a safe place, and clean the windshield. If the message does not disappear after you have cleaned the windshield and driven for a while, have your vehicle checked by a dealer.

## Adaptive Cruise Control (ACC)\*

Helps maintain a constant vehicle speed and a set following-interval behind a vehicle detected ahead of yours, without you having to keep your foot on the brake or the accelerator.

**When to use**

The camera is located behind the rearview mirror.

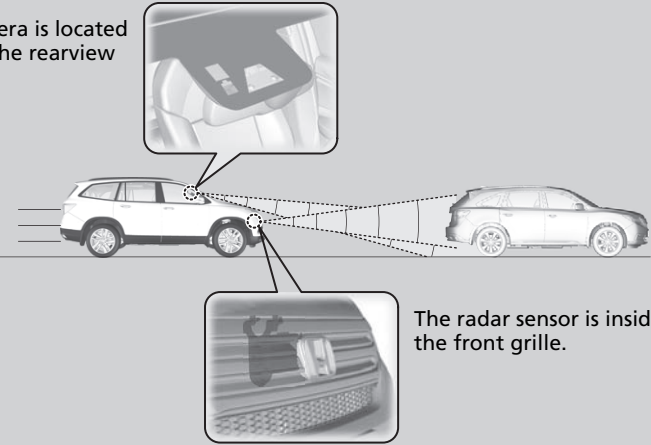

The radar sensor is inside the front grille.

- Vehicle speed for adaptive cruise control: Desired speed in a range above roughly 25 mph (40 km/h) ~
- Gear positions for adaptive cruise control: In **D** or **S**\*

### ▶ Adaptive Cruise Control (ACC)\*

#### **⚠ WARNING**

Improper use of ACC can lead to a crash.

Use ACC only when traveling on open highways in good weather.

#### **⚠ WARNING**

ACC has limited braking capability.

When your vehicle speed drops below 22 mph, ACC will automatically cancel and no longer will apply your vehicle's brakes.

Always be prepared to apply the brake pedal when conditions require.

ACC can not be activated if Intelligent Traction Management setting is snow, sand or mud.

**How to use**

**ACC is on in the multi-information display.**  
Adaptive cruise control is ready to use.

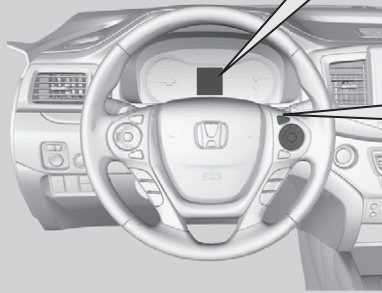
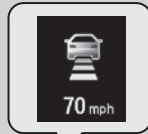

■ Press the **MAIN** button on the steering wheel.

⚠ Adaptive Cruise Control (ACC)\*

**Important Reminder**

As with any system, there are limits to ACC. Use the brake pedal whenever necessary, and always keep a safe distance between your vehicle and other vehicles.

\* Not available on all models

*Continued*



## ■ To Set the Vehicle Speed

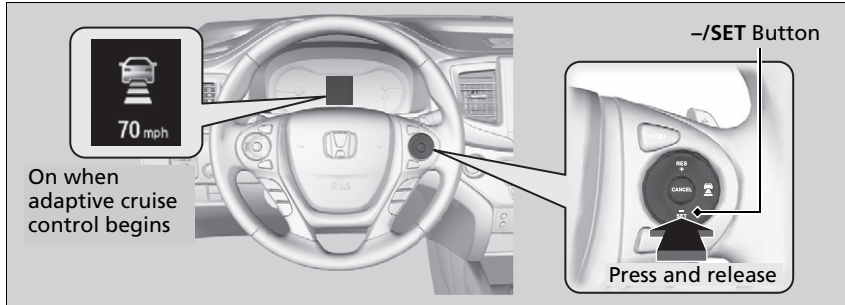

Take your foot off the pedal and press the **-/SET** button when you reach the desired speed.

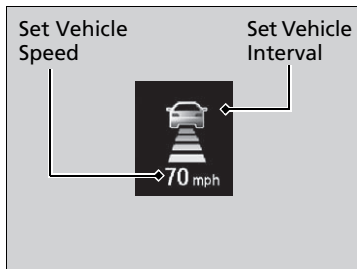

The moment you release the **-/SET** button, the set speed is fixed, and adaptive cruise control begins.

- ▶ A vehicle icon and distance bars appear on the multi-information display.

## ▶ Adaptive Cruise Control (ACC)\*

ACC may not work properly under certain conditions.

▶ **ACC Conditions and Limitations** P. 507

When not using adaptive cruise control: Turn off adaptive cruise by pressing the **MAIN** button.

## ■ When in Operation

### ■ There is a vehicle ahead

ACC monitors if a vehicle ahead of you enters the ACC range. If a vehicle is detected doing so, the ACC system maintains or decelerates your vehicle's set speed in order to keep the vehicle's set following-interval from the vehicle ahead.

🔧 **To Change Following-interval** P. 509

■ When ACC detects a vehicle within ACC range:

The vehicle icon appears on the multi-information display.

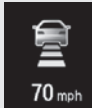

➔

■ When the vehicle goes out of ACC range:

The vehicle icon on the multi-information display becomes a dotted-line contour.



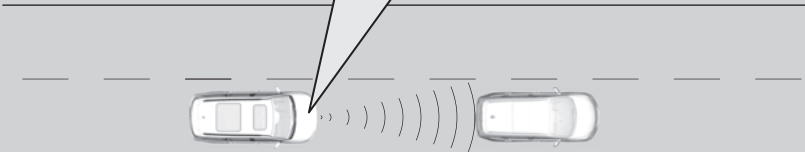

ACC Range: 394 ft. (120 m)

## 🔧 When in Operation

If the vehicle detected ahead of you slows down abruptly, or if another vehicle is detected cutting in front of you, the beeper sounds and a message appears on the multi-information display to alert you to brake.

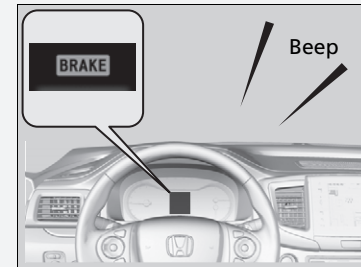

Depress the brake pedal, and keep an appropriate distance from the vehicle ahead.

Even if the distance between your vehicle and the vehicle detected ahead is short, ACC may start accelerating your vehicle under the following circumstances:

- The vehicle detected ahead of you is going at almost the same speed as, or faster than your vehicle.
- A vehicle that cuts in front of you is going faster than your vehicle, gradually distancing itself from you.

■ **There is no vehicle ahead**

Your vehicle cruises at the set speed.

■ **A vehicle ahead is within ACC range and going slower than the set speed**

Your vehicle slows down, and maintains the same speed as the speed of the vehicle ahead to maintain the set following distance.

■ **A vehicle ahead is within ACC range and going at a steady speed**

Your vehicle follows the vehicle ahead of it, keeping a constant distance, without going beyond the set speed.

■ **A vehicle ahead goes out of range**

ACC accelerates your vehicle to the set speed, and then maintains it.

■ **When you depress the accelerator pedal**

You can temporarily increase the vehicle speed. In this case, there is no audible or visual alerts even if a vehicle is in ACC range. ACC stays on unless you cancel it. Once you release the accelerator pedal, the system resumes the set speed.

⌘ When in Operation

You can also set the system to beep when a vehicle detected in front of you comes in and goes out of the ACC detecting range. Change the ACC FORWARD VEHICLE DETECT BEEP\* setting.

➤ **Customized Features** P. 351

**Limitations**

You may need to use the brake to maintain a safe distance when using ACC. Additionally, ACC may not work properly under certain conditions.

➤ **ACC Conditions and Limitations** P. 507

## ■ ACC Conditions and Limitations

The system may automatically shut off and the **ACC** indicator will come on under certain conditions. Some examples of these conditions are listed below. Other conditions may reduce some of the ACC functions.

📷 **Front Sensor Camera**\* P. 500

### ■ Environmental conditions

Driving in bad weather (rain, fog, snow, etc.).

### ■ Roadway conditions

Driving on a snowy or wet roadway (obscured lane marking, vehicle tracks, reflected lights, road spray, high contrast).

### ■ Vehicle conditions

- The outside of the windshield is blocked by dirt, mud, leaves, wet snow, etc.
- An abnormal tire or wheel condition (wrong sized, varied size or construction, improperly inflated, compact spare tire, etc.).
- The camera temperature gets too hot.
- The parking brake is applied.
- When the front grille is dirty.
- The vehicle is tilted due to a heavy load or suspension modifications.
- When tire chains are installed.

■ **Detection limitations**

- A vehicle suddenly crosses in front of you.
- The distance between your vehicle and the vehicle ahead of you is too short.
- A vehicle cuts in front of you at a slow speed, and it brakes suddenly.
- When you accelerate rapidly and approach the vehicle ahead of you at high speed.
- The vehicle ahead of you is a motorcycle, bicycle, mobility scooter, or other small vehicle.
- When there are animals in front of your vehicle.
- When you drive on a curved or winding or undulating road that makes it difficult for the sensor to properly detect a vehicle in front of you.
- The speed difference between your vehicle and a vehicle in front of you is significantly large.
- An oncoming vehicle suddenly comes in front of you.
- Your vehicle abruptly crosses over in front of an oncoming vehicle.
- When driving through a narrow iron bridge.
- When the vehicle ahead of you brakes suddenly.
- When the vehicle ahead of you has a unique shape.
- When your vehicle or the vehicle ahead of you is driving on one edge of the lane.

## ■ To Adjust the Vehicle Speed

Increase or decrease the vehicle speed using the **RES/+** or **-/SET** buttons on the steering wheel.

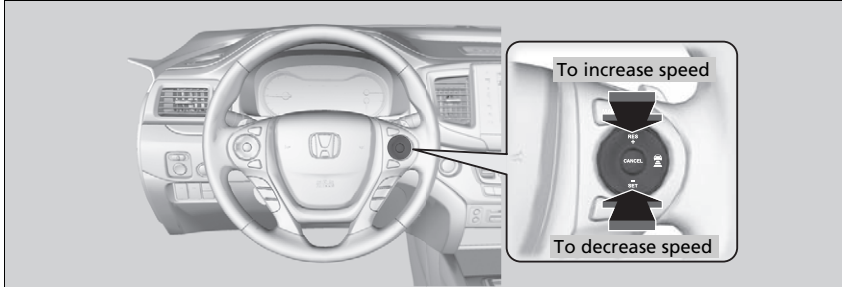

- Each time you press the button, the vehicle speed is increased or decreased by about 1 mph or 1 km/h accordingly.
- If you keep the button pressed, the vehicle speed increases or decreases by about 5 mph or 5 km/h accordingly.

## ■ To Change Following-interval

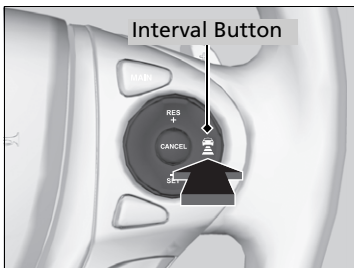

Press the  (Interval) button to change the ACC following-interval.

Each time you press the button, the following-interval (the interval behind a vehicle detected ahead of you) setting cycles through extra long, long, middle, and short following-interval.





## ☒ To Adjust the Vehicle Speed

If a vehicle detected ahead is going at a speed slower than your increased set speed, ACC may not accelerate your vehicle. This is to maintain the set following distance between your vehicle and the vehicle ahead.

You can set the vehicle speed using the **-/SET** button on the steering wheel when adjusting the speed with the accelerator and brake pedals.

Determine the most appropriate following-interval setting based on your specific driving conditions. Be sure to adhere to any following-interval requirements set by local regulation.

The higher your selected set speed is, the greater the short, middle, long or extra long following-interval becomes. See the following examples for your reference.

Vehicle Distance		When the Set Speed is:	
		50 mph (80 km/h)	65 mph (104 km/h)
Short		83 feet 25 meters 1.1 sec	100 feet 31 meters 1.1 sec
Middle		110 feet 33 meters 1.5 sec	137 feet 42 meters 1.5 sec
Long		154 feet 47 meters 2.1 sec	200 feet 61 meters 2.1 sec
Extra Long		204 feet 62 meters 2.8 sec	265 feet 81 meters 2.8 sec

## ■ To Cancel

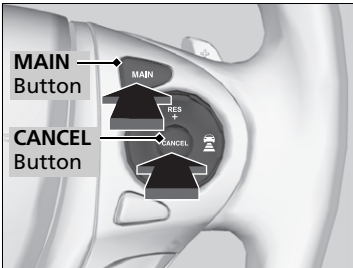

To cancel adaptive cruise control, do any of the following:

- Press the **CANCEL** button.
- Press the **MAIN** button.
- Depress the brake pedal.

## ■ Automatic cancellation

The beeper sounds and a message appears on the multi-information display when ACC is automatically canceled. Any of these conditions may cause the ACC cancellation:

- Your vehicle speed slows down to 22 mph (35 km/h) and below.
- Bad weather (rain, fog, snow, etc.).
- When the radar sensor inside the front grille gets dirty.
- The vehicle ahead of you cannot be detected.
- An abnormal tire condition is detected, or the tires are skidding.
- Driving on a mountainous road, or driving off road for extended periods.
- Abrupt steering wheel movement.
- When the ABS or VSA® is activated.
- When the ABS or VSA® system indicator comes on.

## ⊗ To Cancel

Resuming the prior set speed: After you have canceled adaptive cruise control, you can resume the prior set speed while it is still displayed. Press the **RES/+** button when driving at a speed of at least 25 mph (40 km/h) or more.

You cannot set or resume in the following situations:

- When vehicle speed is less than 25 mph (40 km/h).
- When the **MAIN** button is turned off.

## ⊗ Automatic cancellation





Even though adaptive cruise control has been automatically canceled, you can still resume the prior set speed. Wait until the condition that caused ACC to cancel improves, then press the **RES/+** button.

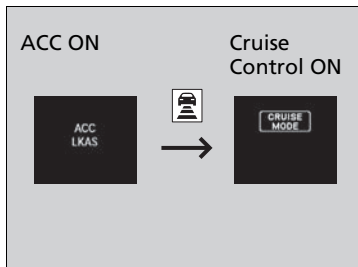

## ■ To Switch ACC to Cruise Control



Press and hold the  (interval) button for one second. **Cruise Mode Selected** appears on the multi-information display for two seconds, and then the mode switches to Cruise.

To switch back to ACC, press and hold the  button again for one second.

### ■ When to use

Desired speed in a range above roughly 25 mph (40 km/h) ~.

## ■ To Set the Vehicle Speed

Take your foot off the pedal and press the **-/SET** button when you reach the desired speed.

The moment you release the **-/SET** button, the set speed is fixed, and cruise control begins. The **CRUISE CONTROL** indicator comes on.

## ■ To Adjust the Vehicle Speed

Each time you press the **RES/+** or **-/SET** button, the vehicle speed is increased or decreased by about 1 mph (1.6 km/h).

If you keep the **RES/+** or **-/SET** button pressed, the vehicle speed increases or decreases until you release it. This speed is then set.

## ▶▶ To Switch ACC to Cruise Control

Always be aware which mode you are in. When you are driving in Cruise mode, the system will not assist you to maintain a following-interval from a vehicle ahead of you.

You can switch the displayed set speed measurements on the audio/information screen\* between mph and km/h.

 **Customized Features** P. 351

## ■ To Cancel

To cancel cruise control, do any of the following:

- Press the **CANCEL** button.
- Press the **MAIN** button.
- Depress the brake pedal.

The **CRUISE CONTROL** indicator goes off.

## ☒ To Cancel

Resuming the prior set speed:

After cruise control has been canceled, you can still resume the prior set speed by pressing the **RES/+** button while driving at a speed of at least 25 mph (40 km/h) or more.

You cannot set or resume in the following situations:

- When vehicle speed is less than 25 mph (40 km/h).
- When the **MAIN** button is turned off.

At vehicle speeds of 22 mph (35 km/h) or less, cruise control canceled automatically.

## Road Departure Mitigation (RDM) System\*

Alerts and helps to assist you when the system determines a possibility of your vehicle unintentionally crossing over detected lane markings.

### How the System Works

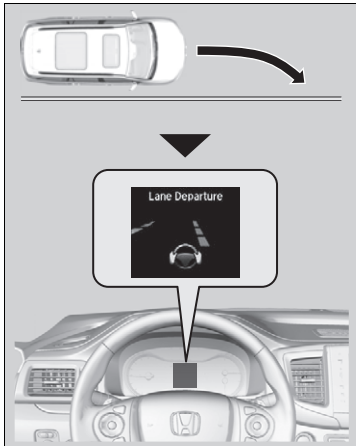

The front camera behind the rearview mirror monitors left and right lane markings (in white or yellow). If your vehicle is getting too close to detected lane markings without a turn signal activated, the system, in addition to a visual alert, applies steering torque and alerts you with rapid vibrations on the steering wheel, to help you remain within the detected lane.

As a visual alert, the **Lane Departure** message appears on the MID.

If the system determines that its steering input is insufficient to keep your vehicle on the roadway, it may apply braking.

▶ Braking is applied only when the lane markings are solid continuous lines.

The system cancels assisting operations when you turn the steering wheel to avoid crossing over detected lane markings.

If the system operates several times without detecting driver response, the system beeps to alert you.

### ⌘ Road Departure Mitigation (RDM) System\*

#### Important Safety Reminder

Like all assistance systems, the RDM system has limitations.

Over-reliance on the RDM system may result in a collision. It is always your responsibility to keep the vehicle within your driving lane.

The RDM system only alerts you when lane drift is detected without a turn signal in use. The RDM system may not detect all lane markings or lane or roadway departures; accuracy will vary based on weather, speed and lane marker condition. It is always your responsibility to safely operate the vehicle and avoid collisions.

You can read about handling information for the camera equipped with this system.

▶ **Front Sensor Camera\*** P. 500

The RDM system may not work properly or may work improperly under the certain conditions:

▶ **RDM Conditions and Limitations** P. 517

There are times when you may not notice RDM functions due to your operation of the vehicle, or road surface conditions. If the **Lane Departure** message displays repeatedly and you do not apply responsive actions, the system beeps and cancels RDM functions.

## How the System Activates

The system becomes ready to start searching for lane markings when all the following conditions are met:

- The vehicle is traveling between about 45 and 90 mph (72 and 145 km/h).
- The vehicle is on a straight or slightly curved road.
- The turn signals are off.
- The brake pedal is not depressed.
- The wipers are not in continuous operation.
- The vehicle is not accelerating or braking, and the steering wheel is not being turned.
- The system makes a determination that the driver is not actively accelerating, braking or steering.

## How the System Activates

The RDM system may automatically shut off and the  indicator comes and stays on.

➤ **Indicators** P. 91

RDM system function can be impacted when the vehicle is:

- Not driven within a traffic lane.
- Driven on the inside edge of a curve, or outside of a lane.
- Driven in a narrow lane.

## ■ RDM On and Off

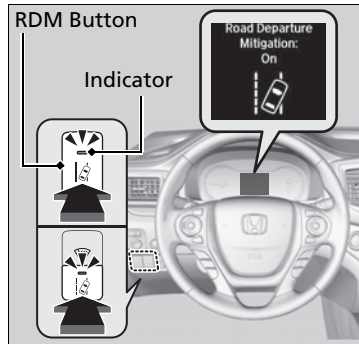

Press the RDM button to turn the system on and off.

- ▶ The indicator in the button comes on and the message appears on the MID when the system is on.

## ▣ RDM On and Off

When you have selected **Warning Only** from the customized options using the MID, the system does not operate the steering wheel and braking.

## RDM Conditions and Limitations

The system may not properly detect lane markings and the position of your vehicle under certain conditions. Some examples of these conditions are listed below.

### ■ Environmental conditions

- Driving in bad weather (rain, fog, snow, etc.).
- Sudden changes between light and dark, such as an entrance or exit of a tunnel.
- There is little contrast between lane lines and the roadway surface.
- Driving into low sunlight (e.g., at dawn or dusk).
- Strong light is reflected onto the roadway.
- Driving in the shadows of trees, buildings, etc.
- Shadows of adjacent objects are parallel to lane markings.
- Roadway objects or structures are misinterpreted as lane markers.
- Reflections on the interior of the front windshield.

■ **Roadway conditions**

- Driving on a snowy or wet roadway (obscured lane marking, vehicle tracks, reflected lights, road spray, high contrast).
- Driving on a road with temporary lane markings.
- Faint, multiple, or varied lane markings are visible on the roadway due to road repairs or old lane markings.
- The roadway has merging, split, or crossing lines (e.g., such as at an intersection or crosswalk).
- The lane markings are extremely narrow, wide, or changing.
- The vehicle in front of you is driving near the lane lines.
- The road is hilly or the vehicle is approaching the crest of a hill.
- Driving on rough or unpaved roads, or over bumpy surfaces.
- When objects on the road (curb, guard rail, pylons, etc.) are recognized as white lines (or yellow lines).
- When driving on roads with double lines.

■ **Vehicle conditions**

- Headlight lenses are dirty or the headlights are not properly adjusted.
- The outside of the windshield is streaked or blocked by dirt, mud, leaves, wet snow, etc.
- The inside of the windshield is fogged.
- The camera temperature gets too hot.
- An abnormal tire or wheel condition (wrong sized, varied size or construction, improperly inflated, compact spare tire, etc.).
- The vehicle is tilted due to a heavy load or suspension modifications.
- When tire chains are installed.

## Lane Keeping Assist System (LKAS)\*

Provides steering input to help keep the vehicle in the middle of a detected lane and provides tactile and visual alerts if the vehicle is detected drifting out of its lane.

### ■ Steering input assist

The system applies torque to the steering to keep the vehicle between the left and right lane lines. The applied torque becomes stronger as the vehicle gets closer to either of the lane lines.

■ LKAS camera  
Monitors the lane lines

### ■ Tactile and visual alerts

Rapid vibrations on the steering wheel and a warning display alert you that the vehicle is drifting out of a detected lane.

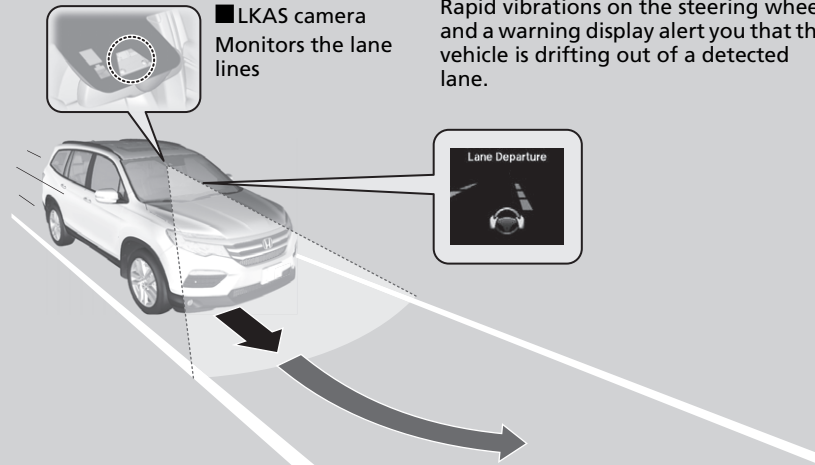

When you operate the turn signals to change lanes, the system is suspended, and resumes after the signals are off.

If you make a lane change without operating the turn signals, the LKAS alerts activate, and torque is applied to the steering.

### ▣ Lane Keeping Assist System (LKAS)\*

#### Important Safety Reminders

The LKAS is for your convenience only. It is not a substitute for your vehicle control. The system does not work if you take your hands off the steering wheel or fail to steer the vehicle.

#### ▣ Multi-Information Display Warning and Information Messages P. 109

Do not place objects on the instrument panel. Objects may reflect on the front windshield and prevent correct detection of the traffic lanes.

LKAS only alerts you when lane drift is detected without a turn signal in use. LKAS may not detect all lane markings or lane departures; accuracy will vary based on weather, speed, and lane marker condition. It is always your responsibility to safely operate the vehicle and avoid collisions.

The LKAS is convenient when it is used on freeways.

The LKAS may not work properly or may work improperly under the certain conditions:

#### ▣ LKAS Conditions and Limitations P. 525

LKAS may not function as designed on while driving in frequent stop and go traffic, or on roads with sharp curves.

You can read about handling information for the camera equipped with this system.

#### ▣ Front Sensor Camera\* P. 500



### ■ Lane Keep Support Function

Provides assistance to keep the vehicle in the center of the lane, when the vehicle nears a white or yellow line, steering force of the electric power steering will become stronger.

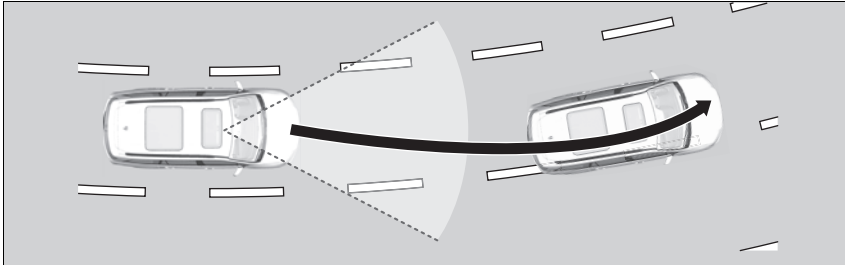

### ■ Lane Departure Warning Function

When the vehicle enters the warning area, LKAS alerts you with slight steering wheel vibration as well a warning display.

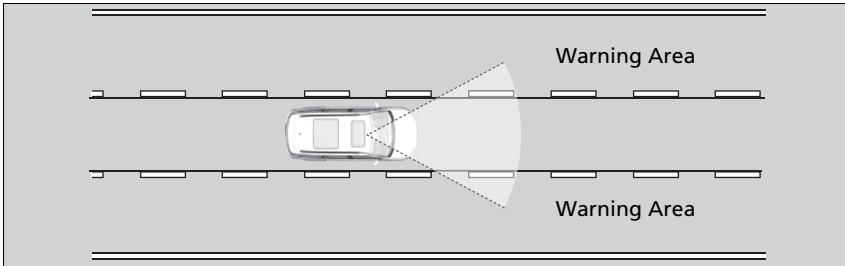

### ▶▶ Lane Keeping Assist System (LKAS)\*

When the vehicle enters the warning area, lane departure warning is provided by steering wheel vibration and display.

## ■ When the System can be Used

The system can be used when the following conditions are met.

- The lane in which you are driving has detectable lane markers on both sides, and your vehicle is in the center of the lane.
- The vehicle speed is between about 45 and 90 mph (72 and 145 km/h).
- You are driving on a straight or slightly curved road.
- The turn signals are off.
- The brake pedal is not depressed.
- The wipers are not in continuous operation.

## ■ How to activate the system

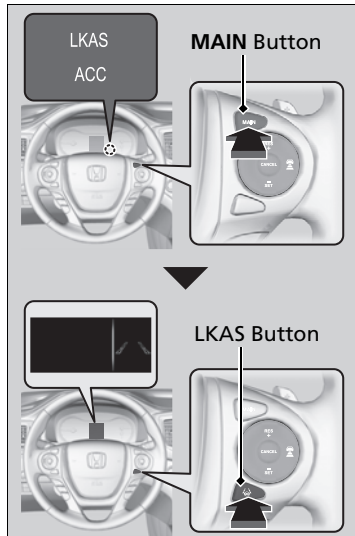

1. Press the **MAIN** button.
  - ▶ The **ACC** and **LKAS** indicators come on. The system is ready to use.
2. Press the LKAS button.
  - ▶ Lane outlines appear on the MID. The system is activated.

\* Not available on all models

Continued

## ▶ Lane Keeping Assist System (LKAS)\*

You can read about handling information for the camera equipped with this system.

▶ **Front Sensor Camera\*** P. 500

If the vehicle drifts toward either left or right lane line due to the system applying torque, turn off the LKAS and have your vehicle checked by a dealer.

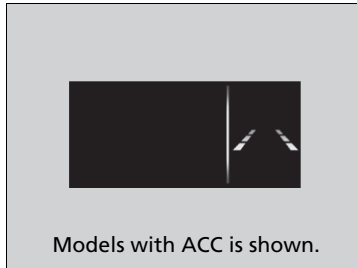

3. Keep your vehicle near the center of the lane while driving.
  - ▶ The dotted outer lines change to solid ones once the system starts operating after detecting the left and right lane markings.

▶▶ When the System can be Used

The LKAS temporarily deactivates when it fails to detect lane lines. When the system detects the lines again, it comes back on automatically.

▶▶ To cancel

Pressing the **MAIN** button also turns ACC on and off.

■ To cancel

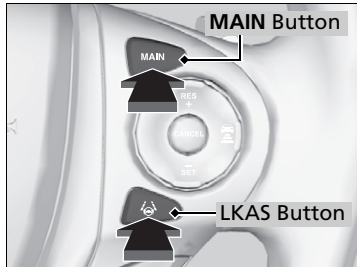

To cancel the LKAS:  
Press the **MAIN** or LKAS button.

The LKAS is turned off every time you stop the engine, even if you turned it on the last time you drove the vehicle.



When the LKAS is suspended, the lane lines on the MID change to contour lines, and the beeper sounds.

■ **The system operation is suspended if you:**

- Set the wipers to continuous operation.
  - ▶ Turning the wipers off resumes the LKAS.
- Decrease the vehicle speed to about 40 mph (64 km/h) or less.
  - ▶ Increasing the vehicle speed to about 45 mph (72 km/h) or more resumes the LKAS.
- Depress the brake pedal.
  - ▶ The LKAS resumes and starts detecting the lane lines again once you release the brake pedal.

**Models with automatic intermittent wipers**

- Set the wiper switch to **AUTO** and the wipers operate continuously.
  - ▶ The LKAS resumes when the wipers stop or operate intermittently.

■ **The LKAS may automatically be suspended when:**

- The system fails to detect lane lines.
- The steering wheel is quickly turned.
- You fail to steer the vehicle.
- The vehicle speed is over the posted speed limit, on a curve road.

Once these conditions no longer exist, the LKAS automatically resumes.

■ **The LKAS may automatically be canceled when:**

- The camera temperature gets too high.
- The camera behind the rearview mirror, or the area around the camera, including the windshield, gets dirty.
- When driving through a sharp curve.
- When driving at a speed in excess of approximately 90 mph (145 km/h).
- When the ABS or VSA® systems engage.

A beeper will sound if the LKAS is automatically canceled.

## ■ LKAS Conditions and Limitations

The system may not detect lane markings and therefore may not keep the vehicle in the middle of a lane under certain conditions, including the following:

### ■ Environmental conditions

- Driving in bad weather (rain, fog, snow, etc.).
- Sudden changes between light and dark, such as an entrance or exit of a tunnel.
- There is little contrast between lane lines and the roadway surface.
- Driving into low sunlight (e.g., at dawn or dusk).
- Strong light is reflected onto the roadway.
- Driving in the shadows of trees, buildings, etc.
- Shadows of adjacent objects are parallel to lane markings.
- Roadway objects or structures are misinterpreted as lane markers.
- Reflections on the interior of the front windshield.

### ■ Roadway conditions

- Driving on a snowy or wet roadway (obscured lane marking, vehicle tracks, reflected lights, road spray, high contrast).
- Driving on a road with temporary lane markings.
- Faint, multiple, or varied lane markings are visible on the roadway due to road repairs or old lane markings.
- The roadway has merging, split, or crossing lines (e.g., such as at an intersection or crosswalk).
- The lane markings are extremely narrow, wide, or changing.
- The vehicle in front of you is driving near the lane lines.
- The road is hilly or the vehicle is approaching the crest of a hill.
- Driving on rough or unpaved roads, or over bumpy surfaces.
- When objects on the road (curb, guard rail, pylons, etc.) are recognized as white lines (or yellow lines).
- When driving on roads with double lines.

### ■ Vehicle conditions

- Headlight lenses are dirty or the headlights are not properly adjusted.
- The outside of the windshield is streaked or blocked by dirt, mud, leaves, wet snow, etc.
- The inside of the windshield is fogged.
- The camera temperature gets too hot.
- An abnormal tire or wheel condition (wrong sized, varied size or construction, improperly inflated, compact spare tire, etc.).
- The vehicle is tilted due to a heavy load or suspension modifications.

## Vehicle Stability Assist (VSA®), aka Electronic Stability Control (ESC), System

VSA® helps to stabilize the vehicle during cornering if the vehicle turns more or less than what was intended. It also assists in maintaining traction on slippery surfaces. It does so by regulating engine output and selectively applying the brakes.

### ■ VSA® Operation

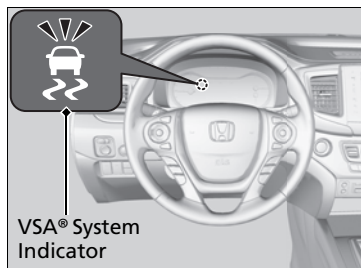

When VSA® activates, you may notice that the engine does not respond to the accelerator. You may also notice some noise from the hydraulic system. You will also see the indicator blink.

### ▣ Vehicle Stability Assist (VSA®), aka Electronic Stability Control (ESC), System

The VSA® may not function properly if tire type and size are mixed. Make sure to use the same size and type of tire, and the air pressures as specified.

When the VSA® indicator comes on and stays on while driving, there may be a problem with the system. While this may not interfere with normal driving, have your vehicle checked by a dealer immediately.

VSA® cannot enhance stability in all driving situations and does not control the entire braking system. You still need to drive and corner at speeds appropriate for the conditions and always leave a sufficient margin of safety.

The main function of the VSA® system is generally known as Electronic Stability Control (ESC). The system also includes a traction control function.



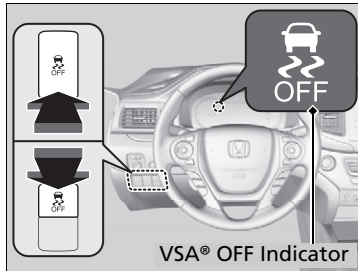

## ■ VSA® On and Off



This button is on the driver side control panel. To partially disable VSA® functionality/features, press and hold it until you hear a beep.

The traction control stops fully functioning, allowing the wheels to spin more freely at low speed. The VSA® OFF indicator will also come on and a message on the MID informs you that the mode is changed.

Traction control mode can not be changed during Mud or Sand modes. If you are driving on mud or sand, Mud or Sand Intelligent Traction Management modes can also be used to free a stuck vehicle. On other road surfaces, change to Normal or Snow mode, then press and hold the  (VSA® OFF) button.



To restore VSA® functionality/features, press the  (VSA® OFF) button until you hear a beep.



VSA® is turned on every time you start the engine, even if you turned it off the last time you drove the vehicle.

## ▣ Vehicle Stability Assist (VSA®), aka Electronic Stability Control (ESC), System

With the  button pressed, your vehicle will have normal braking and cornering ability, but VSA® traction and stability enhancement becomes less effective.

In certain unusual conditions when your vehicle gets stuck in shallow mud or fresh snow, it may be easier to free it with the  button pressed.

When the  button is pressed, the traction control function becomes less effective. This allows for the wheels to spin more freely at low speed. You should only attempt to free your vehicle with the  button pressed if you are not able to free it without.

Immediately after freeing your vehicle, be sure to press the  button again. We do not recommend driving your vehicle with the  button pressed (indicator on).

You may hear a motor sound coming from the engine compartment while system checks are being performed immediately after starting the engine or while driving. This is normal.

## Agile Handling Assist

---

Lightly brakes each of the front and rear wheels, as needed, when you turn the steering wheel, and helps support the vehicle's stability and performance during cornering.

### ⓘ Agile Handling Assist

The agile handling assist cannot enhance stability in all driving situations. You still need to drive and corner at speeds appropriate for the conditions and always leave a sufficient margin of safety.

When the VSA® system indicator comes on and stays on while driving, the agile handling assist does not activate.

You may hear a sound coming from the engine compartment while the agile handling assist is activated. This is normal.

## Blind spot information (BSI) System\*

Is designed to detect vehicles in specified alert zones adjacent to your vehicle, particularly in harder to see areas commonly known as “blind spots.”

When the system detects vehicles approaching from behind in adjacent lanes, the appropriate indicator comes on for a few seconds, providing assistance when you change lanes.

### ■ How the system works

- The transmission is in **D**.
- Your vehicle speed is between 20 mph (32 km/h) and 100 mph (160 km/h)

#### Alert zone range

- A: Approx. 1.6 ft. (0.5 m)
- B: Approx. 10 ft. (3 m)
- C: Approx. 10 ft. (3 m)

Radar Sensors:  
underneath the  
rear bumper  
corners

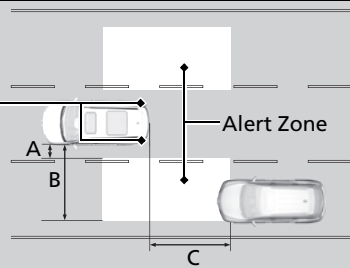

### ▶▶ Blind spot information (BSI) System\*

## ⚠ WARNING

Failure to visually confirm that it is safe to change lanes before doing so may result in a crash and serious injury or death. Do not rely only on the blind spot information system when changing lanes.

Always look in your mirrors, to either side of your vehicle, and behind you for other vehicles before changing lanes.

### Important Safety Reminder

Like all assistance systems, BSI has limitations. Over reliance on BSI may result in a collision.

The system is for your convenience only. Even if an object is within the alert zone, the following situations may occur.

- The BSI alert indicator may not come on due to obstruction (splashes, etc.) even without the **Blind Spot Info Not Available** MID appearing.
- The BSI alert indicator may come on even with the message appearing.

The BSI alert indicator may not come on under the following conditions:

- A vehicle does not stay in the alert zone for more than two seconds.
- A vehicle is parked in a side lane.
- The speed difference between your vehicle and the vehicle you are passing is greater than 6 mph (10 km/h).
- An object not detected by the radar sensors approaches or passes your vehicle.

## ■ When the system detects a vehicle

**BSI Alert Indicator:** Located near the outside rearview mirror on both sides.

### ■ Comes on when

- A vehicle enters the alert zone from behind to overtake you with a speed difference of no more than 31 mph (50 km/h) from your vehicle.
- You pass a vehicle with a speed difference of no more than 12 mph (20 km/h).

### ■ Blinks and the beeper sounds when

You move the turn signal lever in the direction of the detected vehicle. The beeper sounds three times.

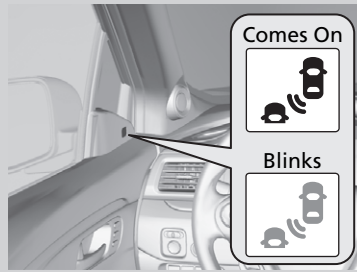

## ▣ Blind spot information (BSI) System\*

You can change the setting for BSI.

▣ **Customized Features** P. 351

Turn the system off when towing a trailer.

The system may not work properly for the following reasons:

- The added mass tilts the vehicle and changes the radar coverage.
- The trailer itself can be detected by the radar sensors, causing the BSI alert indicators to come on.

BSI may be adversely affected when:

- Objects (guard rails, poles, trees, etc.) are detected.
- An object that does not reflect radio waves well, such as a motorcycle, is in the alert zone.
- Driving on a curved road.
- A vehicle is moving from a far lane to the adjacent lane.
- The system picks up external electrical interference.
- The rear bumper or the sensors have been improperly repaired or the rear bumper has been deformed.
- The orientation of the sensors has been changed.
- In bad weather (Heavy rain, snow, and fog).

For proper BSI use:

- Always keep the rear bumper corner area clean.
- Do not cover the rear bumper corner area with labels or stickers of any kind.
- Take your vehicle to a dealer if you need the rear bumper corner area or the radar sensors to be repaired, or the rear bumper corner area is strongly impacted.

\* Not available on all models

## LaneWatch™\*

LaneWatch is an assistance system that allows you to check the passenger side rear areas displayed on the audio/information screen when the turn signal is activated to the passenger's side. A camera in the passenger side door mirror monitors these areas and allows you to check for vehicle, in addition to your visual check and use of the passenger door mirror. You can also keep the system on for your convenience while driving.

### 1 The system activates when you:

Move the turn signal lever to the passenger side.

Press the LaneWatch button.



### The system deactivates when you:

Pull the turn signal lever back.

Press the LaneWatch button again.

### 2

The passenger side view display appears on the audio/information screen.



### ▶▶ LaneWatch™\*

## ⚠ WARNING

Failure to visually confirm that it is safe to change lanes before doing so may result in a crash and serious injury or death.

Do not rely only on LaneWatch while driving.

Always look in your mirrors, to either side of your vehicle, and behind you for other vehicles before changing lanes.

### Important Safety Reminder

Like all assistance systems, LaneWatch has limitations. Over reliance on LaneWatch may result in a collision.

The LaneWatch function can be affected by weather, lighting (including headlights and low sun angle), ambient darkness, camera condition, and loading.

The LaneWatch may not provide the intended display of traffic to the side and rear under the following conditions:

- Your vehicle's suspension has been altered, changing the height of the vehicle.
- Your tires are over or under inflated.
- Your tires or wheels are of varied size or construction.

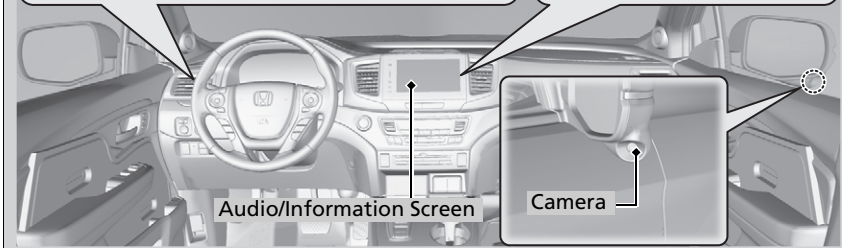

## ■ Customizing the LaneWatch settings

You can customize the following items using the audio/information screen.

- **Show with Turn Signal:** Selects whether LaneWatch monitor comes on when you operate the turn signal light lever.
- **Display Time after Turn Signal Off:** Changes the remaining Lane Watch display time after you pull the turn signal lever back.
- **Reference Line:** Selects whether the reference lines appear on the LaneWatch monitor.
- **Display:** Adjusts display settings.
  - ☒ **Customized Features** P. 351

## ■ Reference Lines

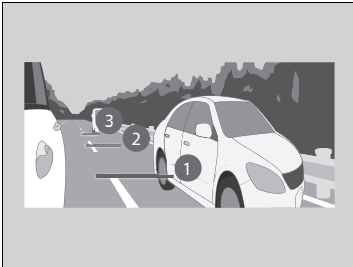

Three lines that appear on the screen can give an idea of how far the vehicles or objects on the screen are from your vehicle, respectively. If an object is near line 1 (in red), it indicates that it is close to your vehicle whereas an object near line 3 farther away.

### ☒ LaneWatch™\*

The LaneWatch camera view is restricted. Its unique lens makes objects on the screen look slightly different from what they are.

LaneWatch display does not come on when the shift lever is in **[R]**.

For proper LaneWatch operation:

- The camera is located in the passenger side door mirror. Always keep this area clean. If the camera lens is covered with dirt or moisture, use a soft, moist cloth to keep the lens clean and free of debris.
- Do not cover the camera lens with labels or stickers of any kind.
- Do not touch the camera lens.

### ☒ Reference Lines

The area around the reference line 1 (red) is very close to your vehicle. As always, make sure to visually confirm the safety of a lane change before changing lanes.

The distance between your vehicle and lines 1, 2 and 3 on the screen vary depending on road conditions and vehicle loading. For example, the reference lines on the screen may seem to appear closer than the actual distances when the rear of your vehicle is more heavily loaded.

Consult a dealer if:

- The passenger side door mirror, or area around it is severely impacted, resulting in changing the camera angle.
- The LaneWatch display does not come on at all.

## Intelligent VTM4 (i-VTM4)\*

The Intelligent VTM4 (i-VTM4) is a full time all wheel drive system that automatically controls and transfers varying amount of engine torque to all wheels independently according to the driving conditions.

You still need to exercise the same care when accelerating, steering, and braking that you would in a two wheel drive vehicle.

Avoid continuously driving on slippery surfaces where a wheel is likely to spin out, and do not drive if the AWD indicator starts blinking. Driving continuously under such conditions can damage the system's torque distribution unit.

If the AWD indicator blinks while driving, it indicates the differential temperature is too high. If this happens, pull to the side of the road when it is safe, shift to park, an idle the engine idle until the indicator goes out. If the indicator does not go out, take your vehicle to a dealer to have it checked.

### Intelligent VTM4 (i-VTM4)\*

#### NOTICE

Do not continuously spin the front tires of your vehicle. Continuously spinning the front tires can cause transmission or rear differential damage.

The i-VTM4 system may not function properly if tire type and size are mixed. Make sure to use the same size and type of tire, and the air pressures as specified.

🔧 **Tire and Wheel Replacement** P. 603

## Tire Pressure Monitoring System (TPMS) with Tire Fill Assist

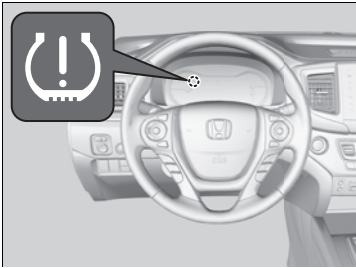

Monitors the tire pressure while you are driving. If your vehicle's tire pressure becomes significantly low, the Low Tire Pressure/TPMS indicator comes on and a message appears on the MID.

### ▣ Tire Pressure Monitoring System (TPMS) with Tire Fill Assist

Conditions such as low ambient temperature and altitude change directly affect tire pressure and can trigger the Low Tire Pressure/TPMS indicator to come on.

#### ▣ If the Low Tire Pressure/Tire Pressure Monitoring System (TPMS) Indicator Comes On or Blinks P. 641

Tire pressure checked and inflated in:

- Warm weather can become under-inflated in colder weather.
- Cold weather can become over-inflated in warmer weather.

The Low Tire Pressure/TPMS indicator will not come on as a result of over inflation.

The TPMS audibly and visually informs you of changes in tire pressure of the individual tire that you are adjusting using audible and visual indications.

If a change in tire pressure has been significant, the system beeps and the hazard lights flash continuously for five seconds when the specified tire pressure is reached. Stop filling the tire.



## ■ Tire Pressure Monitor

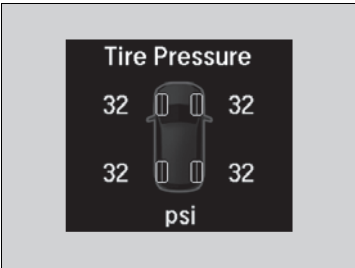

To select the tire pressure monitor, set the power mode to ON, and roll the multi-function steering-wheel controls until you see the tire pressure screen.

The pressure for each tire is displayed in psi (U.S.) or kPa (Canada).

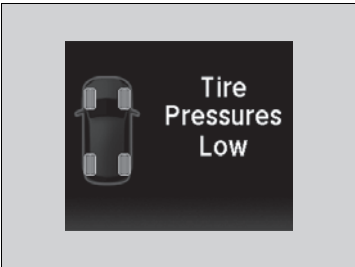

**Tire Pressures Low** is displayed when a tire has significantly low pressure. The specific tire is displayed on the screen.

## ▶▶ Tire Pressure Monitor

The pressure displayed on the MID can be slightly different from the actual pressure as measured by a gauge. If there is a significant difference between the two values, or if the Low Tire Pressure/TPMS indicator and the message on the MID do not go off after you have inflated the tire to the specified pressure, have the system checked by a dealer.

**Tire Pressure Monitor Problem** may appear if you drive with the compact spare tire, or there is a problem with the TPMS.

## Tire Pressure Monitoring System (TPMS) - Required Federal Explanation

---

Each tire, including the spare (if provided), should be checked monthly when cold and inflated to the inflation pressure recommended by the vehicle manufacturer on the vehicle placard or tire inflation pressure label.

(If your vehicle has tires of a different size than the size indicated on the vehicle placard or tire inflation pressure label, you should determine the proper tire inflation pressure for those tires.)

As an added safety feature, your vehicle has been equipped with a tire pressure monitoring system (TPMS) that illuminates a low tire pressure telltale



when one or more of your tires is significantly under-inflated.

Accordingly, when the low tire pressure telltale illuminates, you should stop and check your tires as soon as possible, and inflate them to the proper pressure.

Driving on a significantly under-inflated tire causes the tire to overheat and can lead to tire failure. Under-inflation also reduces fuel efficiency and tire tread life, and may affect the vehicle's handling and stopping ability.

Please note that the TPMS is not a substitute for proper tire maintenance, and it is the driver's responsibility to maintain correct tire pressure, even if under-inflation has not reached the level to trigger illumination of the TPMS low tire pressure telltale.

Your vehicle has also been equipped with a TPMS malfunction indicator to indicate when the system is not operating properly. The TPMS malfunction indicator is combined with the low tire pressure telltale. When the system detects a malfunction, the telltale will flash for approximately one minute and then remain continuously illuminated. This sequence will continue upon subsequent vehicle start-ups as long as the malfunction exists.

When the malfunction indicator is illuminated, the system may not be able to detect or signal low tire pressure as intended.

TPMS malfunctions may occur for a variety of reasons, including the installation of replacement or alternate tires or wheels on the vehicle that prevent the TPMS from functioning properly.

Always check the TPMS malfunction telltale after replacing one or more tires or wheels on your vehicle to ensure that the replacement or alternate tires and wheels allow the TPMS to continue to function properly.

## Brake System

### ■ Parking Brake

Use the parking brake to keep the vehicle stationary when parking.

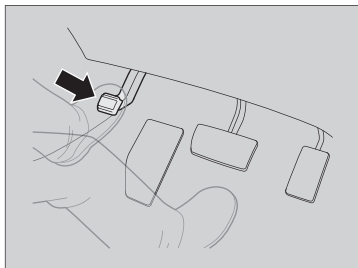

#### **To apply:**

Depress the parking brake pedal down with your foot.

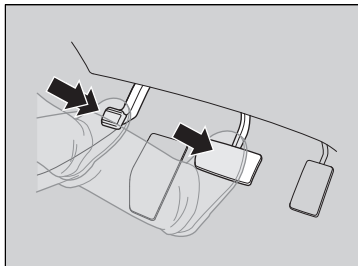

#### **To release:**

1. Depress the brake pedal.
2. Depress the parking brake.

### ▣ Parking Brake

#### **NOTICE**

Release the parking brake fully before driving. The rear brakes and axle can be damaged if you drive with the parking brake applied.

If you start driving without fully releasing the parking brake, a buzzer sounds as a warning, and **Release Parking Brake** appears on the MID.

Always apply the parking brake when parking.

## ■ Foot Brake

Your vehicle is equipped with disc brakes at all four wheels. A vacuum power assist helps reduce the effort needed on the brake pedal. The brake assist system increases the stopping force when you depress the brake pedal hard in an emergency situation. The anti-lock brake system (ABS) helps you retain steering control when braking very hard.

➤ **Brake Assist System** P. 542

➤ **Anti-lock Brake System (ABS)** P. 541

## ☒ Foot Brake

Check the brakes after driving through deep water, or if there is a buildup of road surface water. If necessary, dry the brakes by lightly depressing the pedal several times.

If you hear a continuous metallic friction sound when applying the brakes, this is caused by the brake wear indicator rubbing on the brake rotor and indicates that the brake pads need to be replaced. Have the vehicle checked by a dealer. If you hear only an occasional squeak or squeal when you initially apply the brake pedal, this may be normal and caused by high frequency vibration of the brake pads against the rotating brake disc.

Constantly using the brake pedal while going down a long hill builds up heat, which reduces the brake effectiveness. Apply engine braking by taking your foot off the accelerator pedal and downshifting to a lower gear.

Do not rest your foot on the brake pedal while driving, as it will lightly apply the brakes and cause them to lose effectiveness over time and reduce pad life. It will also confuse drivers behind you.

## Anti-lock Brake System (ABS)

### ■ ABS

Helps prevent the wheels from locking up, and helps you retain steering control by pumping the brakes rapidly, much faster than you.

The electronic brake distribution (EBD) system, which is part of the ABS, also balances the front-to-rear braking distribution according to vehicle loading.

You should never pump the brake pedal. Let the ABS work for you by always keeping firm, steady pressure on the brake pedal. This is sometimes referred to as “stomp and steer.”

### ■ ABS operation

The brake pedal may pulsate slightly when the ABS is working. Keep holding the pedal firmly down. On dry pavement, you will need to press on the brake pedal very hard before the ABS activates. However, you may feel the ABS activate immediately if you are trying to stop on snow or ice.

When the vehicle speed goes under 6 mph (10 km/h), the ABS stops.

### ⓘ Anti-lock Brake System (ABS)

#### NOTICE

The ABS may not function correctly if you use an incorrect tire type and size.

When the **ABS** indicator comes on while driving, there may be a problem with the system. While normal braking is not affected, there is a possibility of the ABS not operating. Have the vehicle checked by a dealer immediately.

The ABS does not reduce the time or distance it takes to stop the vehicle. It only helps with steering control during hard braking.

In the following cases, your vehicle may need more stopping distance than a vehicle without the ABS:

- When driving on rough road surfaces, including when driving on uneven surfaces, such as gravel or snow.
- When tire chains are installed.

You may hear a motor sound coming from the engine compartment while system checks are being performed immediately after starting the engine or while driving. This is normal.

## Brake Assist System

---

Designed to assist the driver by generating greater braking force when you depress the brake pedal hard during emergency braking.

### ■ Brake assist system operation

Press the brake pedal firmly for more powerful braking.

When brake assist operates, the pedal may wiggle slightly and an operating noise may be heard. This is normal. Keep holding the brake pedal firmly down.

## Collision Mitigation Braking System™ (CMBS™)\*

Can assist you when there is a possibility of your vehicle colliding with a vehicle or a pedestrian detected in front of yours. The CMBS™ is designed to alert you when a potential collision is determined, as well as to reduce your vehicle speed to help minimize collision severity when a collision is deemed unavoidable.

### ■ How the system works

**When to use**

The camera is located behind the rearview mirror.

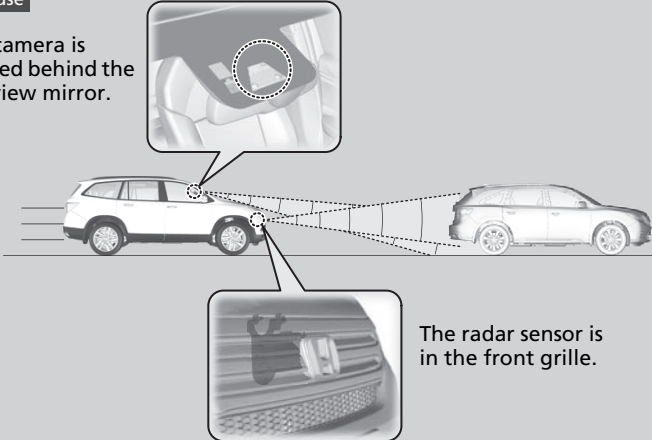

The radar sensor is in the front grille.

The system starts monitoring the roadway ahead when your vehicle speed is about 3 mph (5 km/h) and there is a vehicle in front of you.

The CMBS™ activates when:

- The speed difference between your vehicle and a vehicle or pedestrian detected in front of you becomes about 3 mph (5 km/h) and over with a chance of a collision.
- Your vehicle speed is about 62 mph (100 km/h) or less and there is a chance of a collision with an oncoming detected vehicle or a pedestrian in front of you.

\* Not available on all models

Continued

### ⊠ Collision Mitigation Braking System™ (CMBS™)\*

#### Important Safety Reminder

The CMBS™ is designed to reduce the severity of an unavoidable collision. It does not prevent collision nor stop the vehicle automatically. It is still your responsibility to operate the brake pedal and steering wheel appropriately according to the driving conditions.

The CMBS™ may not activate or may not detect a vehicle in front of your vehicle under certain conditions:

⊠ **CMBS™ Conditions and Limitations** P. 547

You can read about handling information for the camera equipped with this system.

⊠ **Front Sensor Camera\*** P. 500

### ⊠ How the system works

Rapid vibrations on the steering wheel alert you when the your vehicle speed is between 19 and 62 mph (30 and 100 km/h) with an oncoming vehicle detected in front of you.



## ■ When the system activates

The system provides visual, audible and Tactile alerts of a possible collision, and stops if the collision is avoided.

- ▶ Take appropriate action to prevent a collision (apply the brakes, change lanes, etc.)

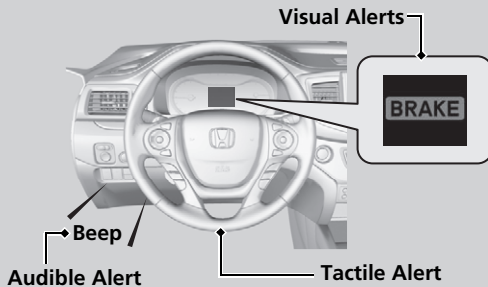

At system's earliest collision alert stage, you can change the distance (**Long/Normal/Short**) between vehicles at which alerts will come on through MID setting options.

## ■ Vibration alert on the steering wheel

When a potential collision to an oncoming detected vehicle is determined, the system alerts you with rapid vibration on the steering wheel, in addition to visual and audible alerts.

- ▶ Take appropriate action to prevent a collision (apply the brakes, operate the steering wheel, etc.).

## ▶▶ When the system activates

The camera in the CMBS™ is also designed to detect pedestrians.

However, this pedestrian detection feature may not activate or may not detect a pedestrian in front of your vehicle under certain conditions.

Refer to the ones indicating the pedestrian detection limitations from the list.

- ▶▶ **CMBS™ Conditions and Limitations** P. 547

## ▶▶ Vibration alert on the steering wheel

Vibration alert function is disabled when the electric power steering (EPS) system indicator comes on.

- ▶▶ **Electric Power Steering (EPS) System Indicator** P. 86

## ■ Collision Alert Stages

The system has three alert stages for a possible collision. However, depending on circumstances, the CMBS™ may not go through all of the stages before initiating the last stage.

Distance between vehicles		CMBS™			
		The sensors detect a vehicle	Audible & Visual WARNINGS	Steering Wheel	Braking
Stage one		There is a risk of a collision with the vehicle ahead of you.	When in <b>Long</b> , visual and audible alerts come on at a longer distance from a vehicle ahead than in <b>Normal</b> setting, and in <b>Short</b> , at a shorter distance than in <b>Normal</b> .	In case of an oncoming vehicle detected, rapid vibration is provided.	—
Stage two		The risk of a collision has increased, time to respond is reduced.	Visual and audible alerts.	—	Lightly applied
Stage three		The CMBS™ determines that a collision is unavoidable.		—	Forcefully applied

## ■ CMBS™ On and Off

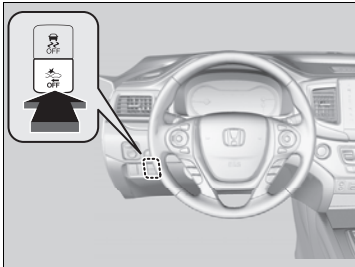

Press this button until the beeper sounds to switch the system on or off.

When the CMBS™ is off:

- The CMBS™ indicator in the instrument panel comes on.
- A message on the MID reminds you that the system is off.

The CMBS™ is in the previously selected ON or OFF setting each time you start the engine.

## ►► Collision Mitigation Braking System™ (CMBS™)\*

The CMBS™ may automatically shut off, and the CMBS™ indicator will come and stay on under certain conditions:

► **CMBS™ Conditions and Limitations** P. 547

## CMBS™ Conditions and Limitations

The system may automatically shut off and the CMBS™ indicator will come on under certain conditions. Some examples of these conditions are listed below. Other conditions may reduce some of the CMBS™ functions.

📷 **Front Sensor Camera**\* P. 500

### ■ Environmental conditions

- Driving in bad weather (rain, fog, snow, etc.).
- Sudden changes between light and dark, such as an entrance or exit of a tunnel.
- There is little contrast between objects and the background.
- Driving into low sunlight (e.g., at dawn or dusk).
- Strong light is reflected onto the roadway.
- Driving in the shadows of trees, buildings, etc.
- Roadway objects or structures are misinterpreted as vehicles and pedestrians.
- Reflections on the interior of the front windshield.

### ■ Roadway conditions

- Driving on a snowy or wet roadway (obscured lane marking, vehicle tracks, reflected lights, road spray, high contrast).
- The road is hilly or the vehicle is approaching the crest of a hill.
- Driving on curvy, winding, or undulating roads.

■ **Vehicle conditions**

- Headlight lenses are dirty or the headlights are not properly adjusted.
- The outside of the windshield is blocked by dirt, mud, leaves, wet snow, etc.
- The inside of the windshield is fogged.
- An abnormal tire or wheel condition (wrong sized, varied size or construction, improperly inflated, compact spare tire, etc.).
- When tire chains are installed.
- The vehicle is tilted due to a heavy load or suspension modifications.
- The camera temperature gets too hot.
- Driving with the parking brake applied.
- When the radar sensor in the front grille gets dirty.

**■ Detection limitations**

- A vehicle or pedestrian suddenly crosses in front of you.
- The distance between your vehicle and the vehicle or pedestrian ahead of you is too short.
- A vehicle cuts in front of you at a slow speed, and it brakes suddenly.
- When you accelerate rapidly and approach the vehicle or pedestrian ahead of you at high speed.
- The vehicle ahead of you is a motorcycle, bicycle, mobility scooter or other small vehicle.
- When there are animals in front of your vehicle.
- When you drive on a curved, winding or undulating road that makes it difficult for the sensor to properly detect a vehicle in front of you.
- The speed difference between your vehicle and a vehicle or pedestrian in front of you is significantly large.
- An oncoming vehicle suddenly comes in front of you.
- Another vehicle suddenly comes in front of you at an intersection, etc.
- Your vehicle abruptly crosses over in front of an oncoming vehicle.
- When driving through a narrow iron bridge.
- When a pedestrian blends in with the background.
- When a pedestrian is bent over or squatting, or when their hands or raised or they are running.
- When several pedestrians are walking ahead in a group.
- When the lead vehicle suddenly slows down.
- When the camera cannot correctly identify that a pedestrian is present due to an unusual shape (holding cargo, body position, size).

### ■ Automatic shutoff

CMBS™ may automatically shut itself off and the CMBS™ indicator comes and stays on when:

- The temperature inside the system is high.
- You drive off-road or on a mountain road, or curved and winding road for an extended period.
- An abnormal tire condition is detected (wrong tire size, flat tire, etc.).
- The camera behind the rearview mirror, or the area around the camera, including the windshield, gets dirty.

Once the conditions that caused CMBS™ to shut off improve or are addressed (e.g., cleaning), the system comes back on.

## ■ With Little Chance of a Collision

The CMBS™ may activate even when you are aware of a vehicle ahead of you, or when there is no vehicle ahead. Some examples of this are:

### ■ When Passing

Your vehicle approaches another vehicle ahead of you and you change lanes to pass.

### ■ At an intersection

Your vehicle approaches or passes another vehicle that is making a left or right turn.

### ■ On a curve

When driving through curves, your vehicle comes to a point where an oncoming vehicle is right in front of you.

### ■ Through a low bridge at high speed

You drive under a low or narrow bridge at high speed.

### ■ Speed bumps, road work sites, train tracks, roadside objects, etc.

You drive over speed bumps, steel road plates, etc., or your vehicle approaches train tracks or roadside objects [such as a traffic sign and guard rail] on a curve or, when parking, stationary vehicles and walls.

## ⊠ Collision Mitigation Braking System™ (CMBS™)\*

For the CMBS™ to work properly:

Always keep the radar sensor cover clean.

Never use chemical solvents or polishing powder for cleaning the sensor cover. Clean it with water or a mild detergent.

Do not paint, or apply any coverings or paint to radar sensor area. This can impact CMBS operation.

If you need the radar sensor to be repaired, or removed, or the radar sensor cover is strongly impacted, turn off the system by pressing the CMBS™ off button and take your vehicle to a dealer.

\* Not available on all models



## When Stopped

1. Depress the brake pedal firmly.
2. Firmly apply the parking brake.
3. Change the gear position to **P**.
4. Turn off the engine.

Always set the parking brake firmly, in particular if you are parked on an incline.

### » Parking Your Vehicle

Do not park your vehicle near flammable objects, such as dry grass, oil, or timber. Heat from the exhaust can cause a fire.

### » When Stopped

#### NOTICE

The following can damage the transmission:

- Depressing the accelerator and brake pedals simultaneously.
- Changing into **P** before the vehicle stops completely.

When facing uphill, do not hold the vehicle by depressing the accelerator pedal.

Doing so may cause the items to malfunction or a fire inside the vehicle.

## **WARNING**

The vehicle can roll away if left unattended without confirming that Park is engaged.

Always keep your foot on the brake pedal until you have confirmed that **P** is shown on the gear position Indicator.

In extremely cold temperatures, the parking brake may freeze up if applied. If such temperatures are expected, do not apply the parking brake but, if parking on a slope, either turn the front wheels so they will contact the curb if the vehicle rolls down the slope or block the wheels to keep the vehicle from moving. If you do not take either precaution, the vehicle may roll unexpectedly, leading to a crash.

## Parking Sensor System\*

The corner and center sensors monitor obstacles near your vehicle. The beeper and audio/information screen let you know the approximate distance between your vehicle and the obstacle.

### ■ The sensor location and range

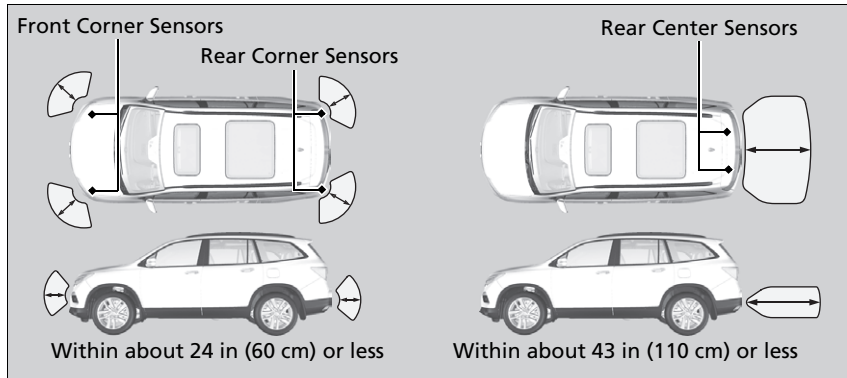

### ⊠ Parking Sensor System\*

Even when the system is on, always confirm if there is no obstacle near your vehicle before parking.

The system may not work properly when:

- The sensors are covered with snow, ice, mud or dirt, etc.
- The vehicle is on uneven surface, such as grass, bumpy road, or a hill.
- The vehicle has been out in hot or cold weather.
- The system is affected by devices that emit ultrasonic waves.
- Driving in bad weather.

The system may not sense:

- Thin or low objects.
- Sonic-absorptive materials, such as snow, cotton, or sponge.
- Objects directly under the bumper.

Do not put any accessories on or around the sensors.

\* Not available on all models

Continued

### ■ Parking sensor system on and off

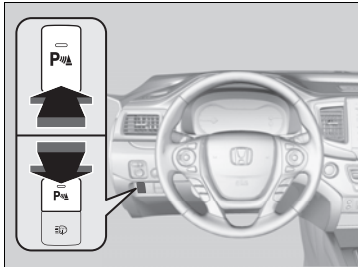

With the power mode in ON, press the parking sensor system button to turn on or off the system. The indicator in the button comes on and the beeper sounds when the system is on.

The rear center and corner sensors start to detect an obstacle when the transmission is in **[R]**, and the vehicle speed is less than 5 mph (8 km/h).

The front corner sensors start to detect an obstacle when the transmission is not in **[P]**, and the vehicle speed is less than 5 mph (8 km/h).

■ When the distance between your vehicle and obstacles behind becomes shorter

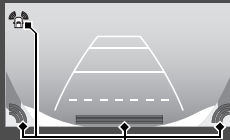
Length of the intermittent beep	Distance between the Bumper and Obstacle		Indicator	Audio/information screen
	Corner Sensors	Center Sensors		
Moderate	—	Rear: About 43-24 in (110-60 cm)	Blinks in Yellow* <sup>1</sup>	 <p>Indicators light where the sensor detects an obstacle</p>
Short	About 24-18 in (60-45 cm)	About 24-18 in (60-45 cm)	Blinks in Amber	
Very short	About 18-14 in (45-35 cm)	About 18-14 in (45-35 cm)	Blinks in Amber	
Continuous	About 14 in (35 cm) or less	About 14 in (35 cm) or less	Blinks in Red	

\*1: At this stage, only the center sensors detect obstacles.

## ■ Turning off All Rear Sensors

1. Make sure that the parking sensor system is not activated. Set the power mode to VEHICLE OFF (LOCK).
2. Press and hold the parking sensor system button, and set the power mode to ON.
3. Keep pressing the button for 10 seconds. Release the button when the indicator in the button flashes.
4. Press the button again. The indicator in the button goes off.
  - ▶ The beeper sounds twice. The rear sensors are now turned off.

To turn the rear sensors on again, follow the above procedure. The beeper sounds three times when the rear sensors come back on.

## ▶▶ Turning off All Rear Sensors

When you set the gear position to **[R]**, the indicator in the parking sensor system button blinks as a reminder that the rear sensors have been turned off.

## Cross Traffic Monitor\*

Monitors the rear corner areas using the radar sensors when reversing, and alerts you if a vehicle approaching from a rear corner is detected.

The system is convenient when you are backing out of a parking space.

### ⚠ Cross Traffic Monitor\*

#### ⚠ CAUTION

Cross Traffic Monitor cannot detect all approaching vehicles and may not detect an approaching vehicle at all.

Failure to visually confirm that it is safe to back up the vehicle before doing so may result in a collision.

Do not solely rely on the system when reversing; always also use your mirrors, and look behind and to the sides of your vehicle before reversing.

\* Not available on all models

*Continued*

## ■ How the System Works

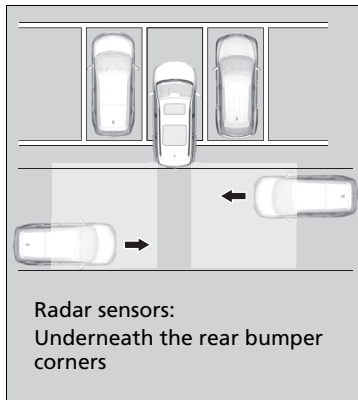

The system activates when:

- The power mode is in ON.
- The Cross Traffic Monitor system is turned on.
- **☑ Cross Traffic Monitor On and Off P. 560**
- The transmission is in **R**.
- Your vehicle is moving at 3 mph (5 km/h) or lower.

When a vehicle is detected approaching from a rear corner, Cross Traffic Monitor alerts you with a buzzer and a displayed warning.

The system will not detect a vehicle that approaches from directly behind your vehicle, nor will it provide alerts about a detected vehicle when it moves directly behind your vehicle.

The system does not detect or provide alerts for a vehicle that is moving away from your vehicle, and it may not detect or alert for pedestrians, bicycles, or stationary objects.

## ☒ Cross Traffic Monitor\*

Cross Traffic Monitor may not detect an approaching vehicle, or may delay alerting you under the following conditions:

- A vehicle, which is parked adjacent to your vehicle, is blocking the radar sensor's scope.
- Your vehicle is moving at the speed of about 3 mph (5 km/h) or higher.
- A vehicle is approaching at the speed other than between about 6 and 16 mph (10 and 25 km/h).
- The system picks up external interference such as other radar sensors from another vehicle or strong radio wave transmitted from a facility nearby.
- Either corner of the rear bumper is covered with snow, ice, mud or dirt.
- When there is bad weather.
- Your vehicle is on an incline.
- Your vehicle is tilted due to a heavy load in the rear.
- The rear bumper or the sensors have been improperly repaired or the rear bumper has been deformed. Have a vehicle checked by a dealer.

For proper operation, always keep the rear bumper corner area clean.

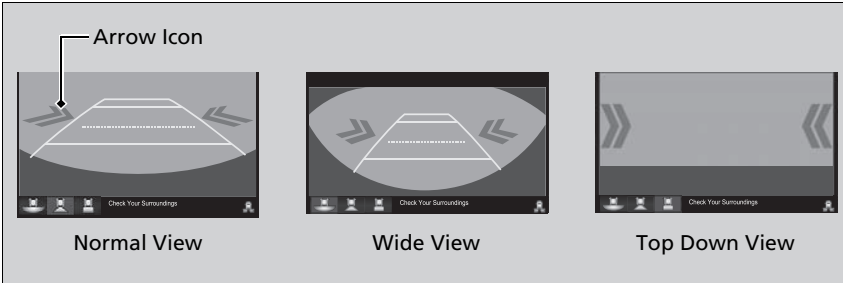

Do not cover the rear bumper corner area with labels or stickers of any kind.

## When the System Detects a Vehicle



An arrow icon appears on the side a vehicle is approaching on the audio/information screen.

## When the System Detects a Vehicle

If the  on the lower right changes to  when the transmission is in **R**, mud snow or ice may have accumulated in the vicinity of the sensor. Check the bumper corners for any obstructions, and thoroughly clean the area if necessary.

If the  comes on when the transmission is in **R**, there may be a problem with the Cross Traffic Monitor system. Do not use the system and have your vehicle checked by a dealer.



## ■ Cross Traffic Monitor On and Off

You can switch on and off the system using the audio/information screen.

1. Select .
2. Select **Settings**.
3. Select **Camera**.
4. Select **Cross Traffic Monitor**.
5. Select **On** or **Off**, then select **OK**.

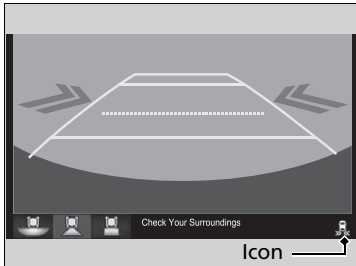

The system can also be turned on and off on the audio/information screen by pressing the CTM icon.

## About Your Multi-view rear camera

The audio/information screen can display your vehicle's rear view. The display automatically changes to a rear view when the gear position is changed to **R**.

### Multi-view rear camera Display Area

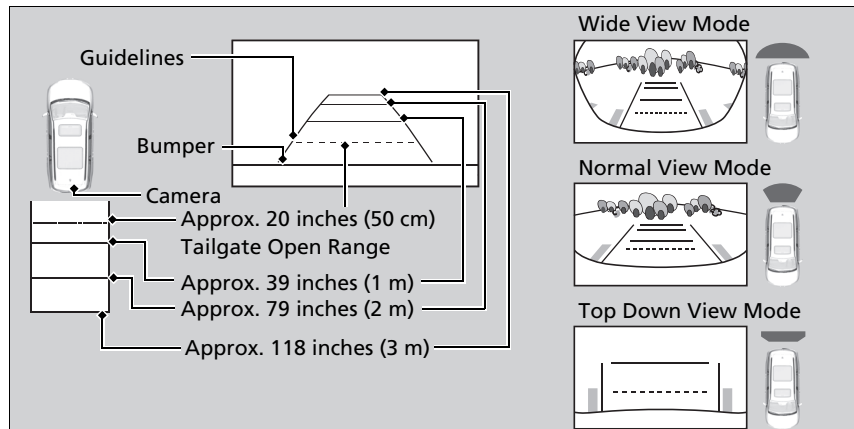

You can view three different camera angles on the rearview display. Press the selector knob to switch the angle.

If the last used viewing mode is Wide or Normal, the same mode is selected the next time you change the gear position to **R**. If Top view was last used, Wide mode is selected.

### About Your Multi-view rear camera

The rear camera view is restricted. You cannot see the corner ends of the bumper or what is underneath the bumper. Its unique lens also makes objects appear closer or farther than they actually are.

Visually confirm that it is safe to drive before backing up. Certain conditions (such as weather, lighting, and high temperatures) may also restrict the rear view. Do not rely on the rearview display which does not give you all information about conditions at the back of your vehicle.

If the camera lens is covered with dirt or moisture, use a soft, moist cloth to keep the lens clean and free of debris.

You can change the **Fixed Guideline** and **Dynamic Guideline** settings.

➤ **Customized Features** P. 351

#### Fixed Guideline

**On:** Guidelines appear when you change the gear position to **R**.

**Off:** Guidelines do not appear.

#### Dynamic Guideline

**On:** Guidelines move according to the steering wheel direction.

**Off:** Guidelines do not move.

\* Not available on all models

## Fuel Information

### ■ Fuel recommendation

**Unleaded gasoline, pump octane number 87 or higher**

Use of a lower octane gasoline can cause a persistent, heavy metallic knocking noise that can lead to engine damage.

### ■ Top tier detergent gasoline

Because the level of detergency and additives in gasoline vary in the market, Honda endorses the use of "TOP TIER Detergent Gasoline" where available to help maintain the performance and reliability of your vehicle. TOP TIER Detergent Gasoline meets a new gasoline standard jointly established by leading automotive manufacturers to meet the needs of today's advanced engines.

Qualifying gasoline retailers will, in most cases, identify their gasoline as having met "TOP TIER Detergent Gasoline" standards at the retail location. This fuel is guaranteed to contain the proper level of detergent additives and be free of metallic additives. The proper level of detergent additives, and absence of harmful metallic additives in gasoline, help avoid build-up of deposits in your engine and emission control system.

For further important fuel-related information for your vehicle, or on information on gasoline that does not contain MMT, visit [www.hondacars.com](http://www.hondacars.com). In Canada, visit [www.honda.ca](http://www.honda.ca) for additional information on gasoline. For more information on top tier gasoline, visit [www.toptiergas.com](http://www.toptiergas.com).

■ **Fuel tank capacity: 19.5 US gal (73.8 liters)**

### » Fuel Information

#### NOTICE

We recommend quality gasoline containing detergent additives that help prevent fuel system and engine deposits. In addition, in order to maintain good performance, fuel economy, and emissions control, we strongly recommend the use of gasoline that does NOT contain harmful manganese-based fuel additives such as MMT, if such gasoline is available.

Use of gasoline with these additives may adversely affect performance, and cause the malfunction indicator lamp on your instrument panel to come on. If this happens, contact a dealer for service. Some gasoline today is blended with oxygenates such as ethanol. Your vehicle is designed to operate on oxygenated gasoline containing up to 15% ethanol by volume. Do not use gasoline containing methanol. If you notice any undesirable operating symptoms, try another service station or switch to another brand of gasoline.

## How to Refuel

Your fuel tank is not equipped with a fuel filler cap. You can insert the filler nozzle directly into the filler neck. The tank seals itself again when you pull out the filler nozzle.

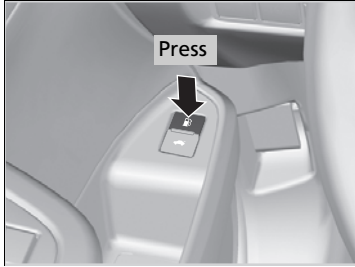

1. Stop your vehicle with the service station pump on the left side of the vehicle in the rear.
2. Turn off the engine.
3. Press the fuel fill door release button.
  - ▶ The fuel fill door opens.

### How to Refuel

## ⚠ WARNING

Gasoline is highly flammable and explosive. You can be burned or seriously injured when handling fuel.

- Stop the engine, and keep heat, sparks, and flame away.
- Handle fuel only outdoors.
- Wipe up spills immediately.

The fuel filler opening is designed to accept only service station filler nozzles for refueling. Use of smaller diameter tubes (e.g., those used to siphon fuel for other uses) or other non-service station devices can damage the area in and around the filler opening.

The filler nozzle automatically stops to leave space in the fuel tank so that fuel does not overflow as a result of changes in air temperature.

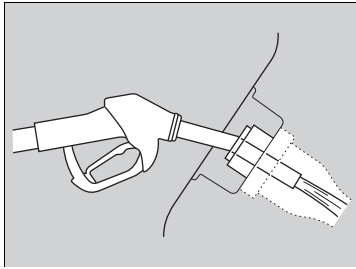

4. Place the end of the filler nozzle on the lower part of filler opening, then insert it slowly and fully.
  - ▶ Make sure that the end of the filler nozzle goes down along with the filler pipe.
  - ▶ Keep the filler nozzle level.
  - ▶ When the tank is full, the filler nozzle will click off automatically.
  - ▶ After filling, wait about five seconds before removing the filler nozzle.
5. Shut the fuel fill door by hand.

#### ▶ How to Refuel

If the fuel filler nozzle keeps turning off when the tank is not full, there may be a problem with the pump's fuel vapor recovery system. Try filling at another pump. If this does not fix the problem, consult a dealer.

Do not continue to add fuel after the nozzle has automatically stopped. Additional fuel can exceed the full tank capacity.

If you have to refuel your vehicle from a portable container, use the funnel provided with your vehicle.

▶ **Refueling From a Portable Fuel Container**  
P. 649

## Improving Fuel Economy and Reducing CO<sub>2</sub> Emissions

Achieving fuel economy and reducing CO<sub>2</sub> emissions is dependent on several factors, including driving conditions, load weight, idling time, driving habits, and vehicle condition. Depending on these and other factors, you may not achieve the rated fuel economy of this vehicle.

### Maintenance and Fuel Economy

You can optimize your fuel economy with proper maintenance of your vehicle. Always maintain your vehicle in accordance with the messages displayed on the MID.

- Use the recommended viscosity engine oil, displaying the API Certification Seal.
- Maintain the specified tire pressure.
- Do not load the vehicle with excess cargo.
- Keep your vehicle clean. A buildup of snow or mud on your vehicle's underside adds weight and increases wind resistance.

### Improving Fuel Economy and Reducing CO<sub>2</sub> Emissions

Direct calculation is the recommended method to determine actual fuel consumed while driving.

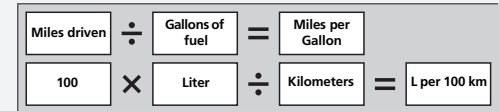

In Canada, posted fuel economy numbers are established following a simulated test. For more information on how this test is performed, please visit <http://oee.nrcan.gc.ca/>



# Maintenance

This chapter discusses basic maintenance.



## Before Performing Maintenance

Inspection and Maintenance .....	568
Safety When Performing Maintenance..	569
Parts and Fluids Used in Maintenance Service .....	570
<b>Maintenance Minder™</b> .....	571

## Maintenance Under the Hood

Maintenance Items Under the Hood..	575
Opening the Hood .....	576
Engine Compartment Cover .....	577
Recommended Engine Oil .....	578
Oil Check.....	579
Adding Engine Oil .....	580
Changing the Engine Oil and Oil Filter...	581

Engine Coolant.....	583
Transmission Fluid.....	585
Brake Fluid.....	586
Refilling Window Washer Fluid.....	586
<b>Replacing Light Bulbs</b> .....	587
<b>Checking and Maintaining Wiper Blades</b> ...	593
<b>Checking and Maintaining Tires</b>	
Checking Tires .....	597
Tire and Loading Information Label ..	598
Tire Labeling .....	598
DOT Tire Quality Grading (U.S. Vehicles)..	600
Wear Indicators.....	602
Tire Service Life .....	602

Tire and Wheel Replacement .....	603
Tire Rotation .....	604
Winter Tires .....	605
<b>Battery</b> .....	606
<b>Remote Transmitter Care</b> .....	608
<b>Remote Control and Wireless Headphone Care*</b> .....	609
<b>Heating and Cooling System*/Climate Control System* Maintenance</b> .....	611
<b>Cleaning</b>	
Interior Care .....	613
Exterior Care.....	615
<b>Accessories and Modifications</b> .....	618

\* Not available on all models



## Inspection and Maintenance

For your safety, perform all listed inspections and maintenance to keep your vehicle in good condition. If you become aware of any abnormality (noise, smell, insufficient brake fluid, oil residue on the ground, etc.), have your vehicle inspected by a dealer. (Note, however, that service at a dealer is not mandatory to keep your warranties in effect.)

### Types of Inspection and Maintenance

#### ■ Daily inspections

Perform inspections before long distance trips, when washing the vehicle, or when refueling.

#### ■ Periodic inspections

##### Automatic transmission models with shift lever

- Check the automatic transmission fluid level monthly.
  - **Automatic Transmission Fluid** P. 585

##### All models

- Check the brake fluid level monthly.
  - **Checking the Brake Fluid** P. 586
- Check the tire pressure monthly. Examine the tread for wear and foreign objects.
  - **Checking and Maintaining Tires** P. 597
- Check the operation of the exterior lights monthly.
  - **Replacing Light Bulbs** P. 587
- Check the condition of the wiper blades at least every six months.
  - **Checking and Maintaining Wiper Blades** P. 593

### » Inspection and Maintenance

#### U.S. models

**Maintenance, replacement, or repair of emissions control devices and systems may be done by any automotive repair establishment or individuals using parts that are “certified” to EPA standards.**

According to state and federal regulations, failure to perform maintenance on the maintenance main items marked with # will not void your emissions warranties. However, all maintenance services should be performed in accordance with the intervals indicated by the multi-information display (MID).

➤ **Maintenance Service Items** P. 573

If you want to perform complex maintenance tasks that require more skills and tools, you can purchase a subscription to the Service Express website at [www.techinfo.honda.com](http://www.techinfo.honda.com).

➤ **Authorized Manuals** P. 661

If you want to perform maintenance yourself, make sure that you have the necessary tools and skills first. After performing maintenance, update the records in the separate maintenance booklet.

## Safety When Performing Maintenance

Some of the most important safety precautions are given here. However, we cannot warn you of every conceivable hazard that can arise in performing maintenance. Only you can decide whether or not you should perform a given task.

### Maintenance Safety

- To reduce the possibility of fire or explosion, keep cigarettes, sparks, and flames away from the battery and all fuel related parts.
- Never leave rags, towels, or other flammable objects under the hood.
  - ▶ Heat from the engine and exhaust can ignite them causing a fire.
- To clean parts, use a commercially available degreaser or parts cleaner, not gasoline.
- Wear eye protection and protective clothing when working with the battery or compressed air.
- Engine exhaust contains carbon monoxide, which is poisonous and can kill you.
  - ▶ Only operate the engine if there is sufficient ventilation.

### Vehicle Safety

- The vehicle must be in a stationary condition.
  - ▶ Make sure your vehicle is parked on level ground, the parking brake is set, and the engine is off.
- Be aware that hot parts can burn you.
  - ▶ Make sure to let the engine and exhaust system cool thoroughly before touching vehicle parts.
- Be aware that moving parts can injure you.
  - ▶ Do not start the engine unless instructed, and keep your hands and limbs away from moving parts.
  - ▶ Do not open the hood while the Auto Idle-stop function\* is activated.

\* Not available on all models

#### ⚠ Safety When Performing Maintenance

### ⚠ WARNING

Improperly maintaining this vehicle or failing to correct a problem before driving can cause a crash in which you can be seriously hurt or killed.

Always follow the inspection and maintenance recommendations according to the schedules in this owner's manual.

### ⚠ WARNING

Failure to properly follow maintenance instructions and precautions can cause you to be seriously hurt or killed.

Always follow the procedures and precautions in this owner's manual.

## Parts and Fluids Used in Maintenance Service

---

The use of Honda genuine parts and fluids is recommended when maintaining and servicing your vehicle. Honda genuine parts are manufactured according to the same high quality standards used in Honda vehicles.

### ⌘ Parts and Fluids Used in Maintenance Service

Do not press the engine cover forcibly. This may damage the engine cover and component parts.

Maintenance items, which should be serviced at the same time that you replace the engine oil, appear on the MID.

You can view them on the engine oil life screen at any time.

## To Use Maintenance Minder™

### ■ Displaying the Engine Oil Life and Maintenance Items

1. Set the power mode to ON.
2. Press the  (Information) button until the engine oil life appears on the MID.

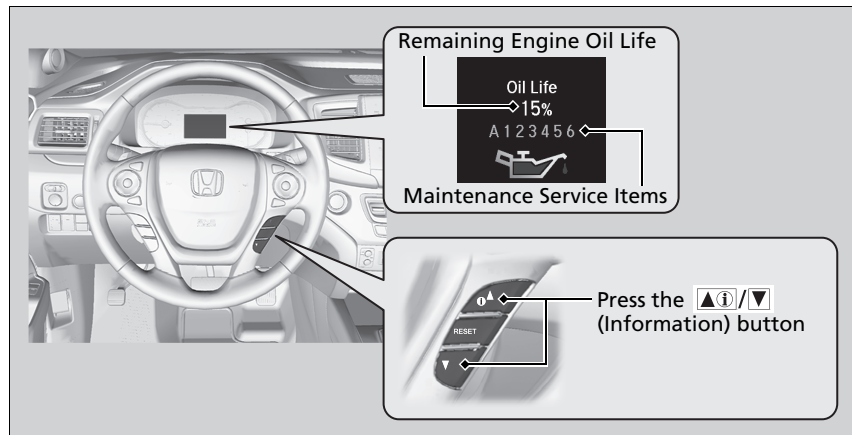

### ▣ Displaying the Engine Oil Life and Maintenance Items







Based on the engine operating conditions, the remaining engine oil life is calculated and displayed as a percentage.

Displayed Engine Oil Life (%)	Calculated Engine Oil Life (%)
100	100 to 91
90	90 to 81
80	80 to 71
70	70 to 61
60	60 to 51
50	50 to 41
40	40 to 31
30	30 to 21
20	20 to 16
15	15 to 11
10	10 to 6
5	5 to 1
0	0

There is a list of maintenance main and sub items you can view on the MID.

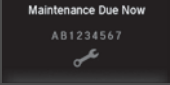
▣ **Maintenance Service Items** P. 573

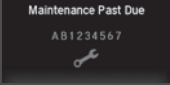
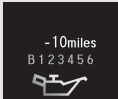
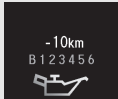
## Maintenance Minder Messages on the Multi-Information Display (MID)

Maintenance Message	Oil Life Display	Explanation	Information
<p><b>Maintenance Due Soon</b></p> 	<p>15%</p> 	<p>The remaining engine oil life is 15 to 6 percent. Once you switch the display by pressing the  (Information) button, this message will go off.</p>	<p>The engine oil is approaching the end of its service life, and the maintenance items should be inspected and serviced soon.</p>
<p><b>Maintenance Due Now</b></p> 	<p>5%</p> 	<p>The remaining engine oil life is 5 to 1 percent. Pressing the  (Information) button to switch to another display.</p>	<p>The engine oil has almost reached the end of its service life, and the maintenance items should be inspected and serviced as soon as possible.</p>
<p><b>Maintenance Past Due</b></p> 	<p>Negative Distance</p> <p><b>U.S.</b></p>  <p><b>Canada</b></p> 	<p>The remaining engine oil life has passed its service life, and a negative distance appears after driving over 10 miles (U.S. models) or 10 km (Canadian models). Pressing the  (Information) button to switch to another display.</p>	<p>The engine oil life has passed. The maintenance items must be inspected and serviced immediately.</p>

The system message indicator (i) comes on along with the Maintenance Minder message.

## Maintenance Service Items

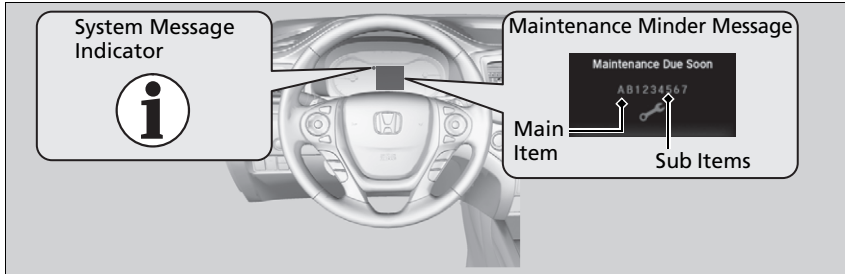

### ⌘ Maintenance Service Items

- Independent of the Maintenance Minder information, replace the brake fluid every 3 years.
- Inspect idle speed every 160,000 miles (256,000 km).
- Adjust the valves during services A, B, 1, 2, or 3 if they are noisy.

CODE	Maintenance Main Items
A	• Replace engine oil* <sup>1</sup>
B	• Replace engine oil* <sup>1</sup> and oil filter • Inspect front and rear brakes • Check parking brake adjustment • Inspect tie rod ends, steering gearbox, and boots • Inspect suspension components • Inspect driveshaft boots • Inspect brake hoses and lines (Including ABS/VA) • Inspect all fluid levels and condition of fluids • Inspect exhaust system <sup>#</sup> • Inspect fuel lines and connections <sup>#</sup>

\*1: If the message **Maintenance Due Now** does not appear more than 12 months after the display is reset, change the engine oil every year.

# : See information on maintenance and emissions warranty in the first column on page 659.

\*2: If you drive in dusty conditions, replace the air cleaner element every 15,000 miles (24,000 km).

\*3: If you drive primarily in urban areas that have high concentrations of soot in the air from industry and from diesel-powered vehicles, replace every 15,000 miles (24,000 km).

CODE	Maintenance Sub Items
1	• Rotate tires
2	• Replace air cleaner element* <sup>2</sup> • Replace dust and pollen filter* <sup>3</sup> • Inspect drive belt
3	• Replace transmission fluid and transfer fluid* <sup>4</sup>
4	• Replace spark plugs • Replace timing belt and inspect water pump* <sup>4</sup> • Inspect valve clearance
5	• Replace engine coolant
6	• Replace rear differential fluid* <sup>5</sup>

\*4: If you drive regularly in very high temperatures (over 110°F, 43°C), in very low temperatures (under -20°F, -29°C), or towing a trailer, replace every 60,000 miles (U.S.) /100,000 km (Canada).

\*5: Driving in mountainous areas at very low vehicle speeds or trailer towing results in higher level of mechanical (Shear) stress to fluid. This requires differential fluid changes more frequently than recommended by the Maintenance Minder. If you regularly drive your vehicle under these conditions, have the differential fluid changed at 7,500 miles (12,000 km), then every 15,000 miles (24,000 km).

\* Not available on all models

Continued

## ■ Resetting the Display

Reset the engine oil life display if you have performed the maintenance service.

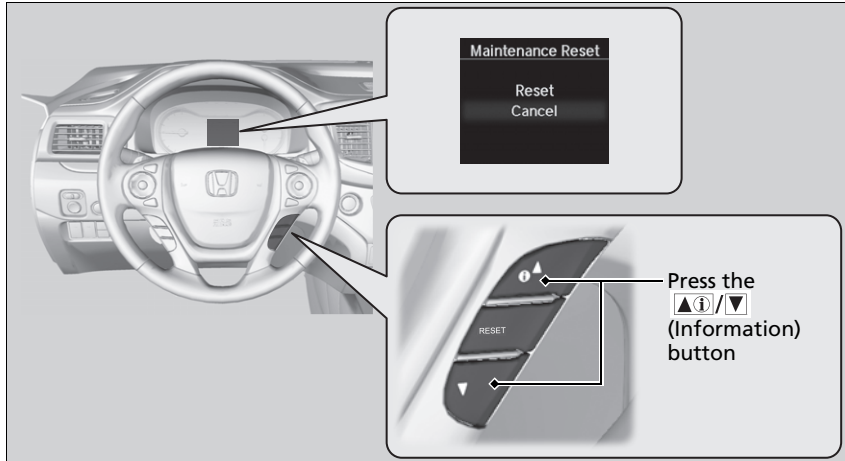

1. Set the power mode to ON.
2. Go to the **Maintenance Info.** group.  
▶ **Customized Features** P. 351
3. Press and hold the **RESET** button  
▶ The oil life reset mode is displayed on the MID.
4. Select **Reset** with the **▲i▼** (Information) button, then push the **RESET** button.  
▶ The displayed maintenance items disappear, and the engine oil life display returns to **100%**.  
▶ To cancel the oil life reset mode, select **Cancel**, then push the **RESET** button.

## ▶▶ Resetting the Display

### NOTICE

Failure to reset the engine oil life after a maintenance service results in the system showing incorrect maintenance intervals, which can lead to serious mechanical problems.

The dealer will reset the engine oil life display after completing the required maintenance service. If someone other than a dealer performs maintenance service, reset the engine oil life display yourself.

### Models with Display Audio

You can reset the engine oil life display using the audio/information screen.

▶ **Customized Features** P. 351

## Maintenance Items Under the Hood

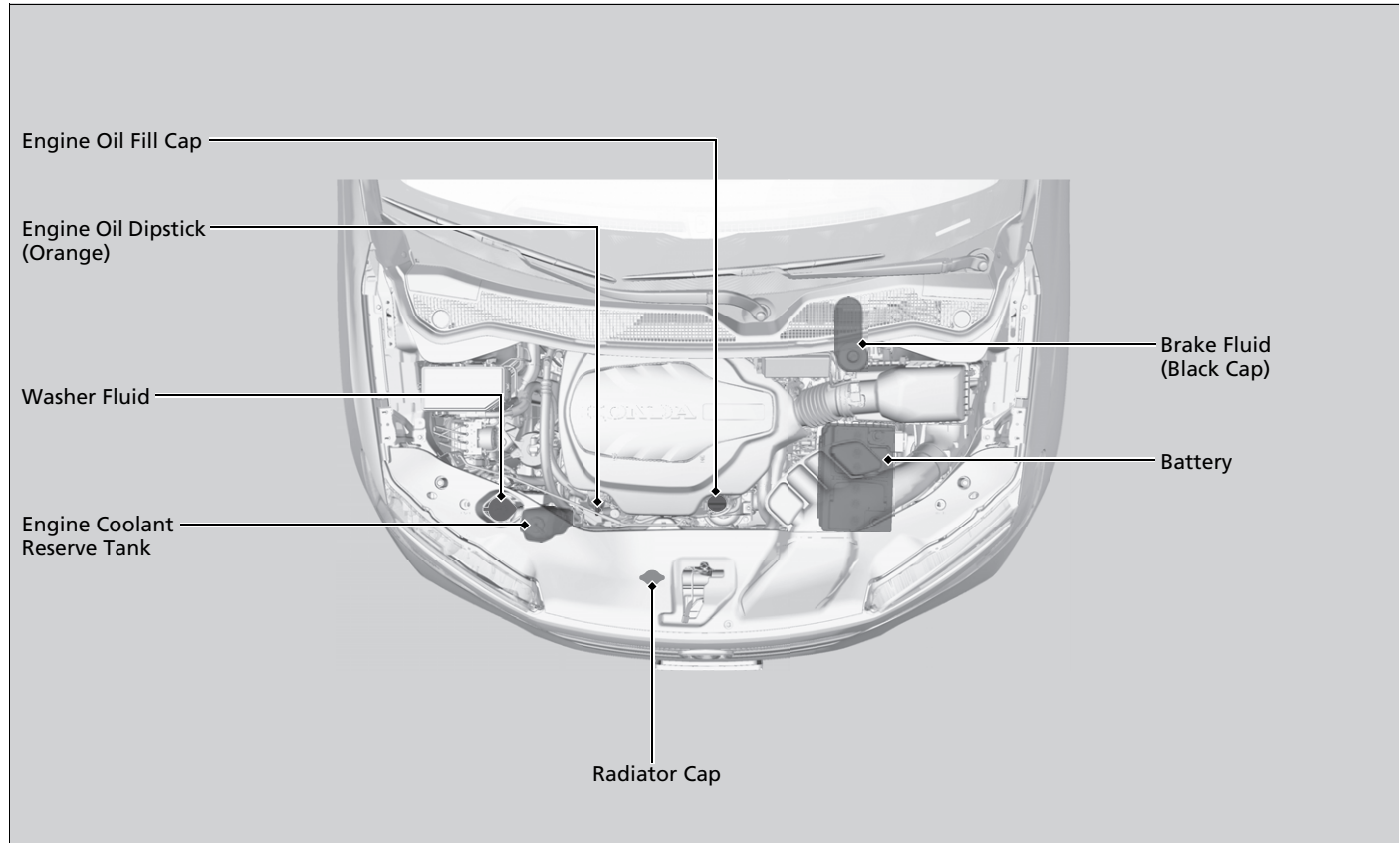



## Opening the Hood

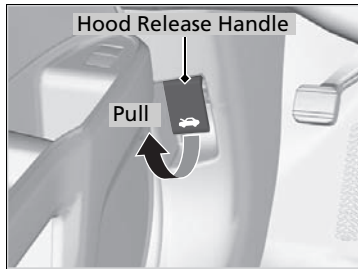

1. Park the vehicle on a level surface, and set the parking brake.
2. Pull the hood release handle under the lower left corner of the dashboard.
  - The hood will pop up slightly.

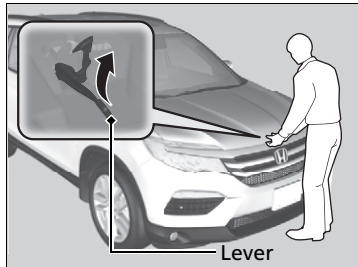

3. Pull up the hood latch lever (located under the front edge of the hood to the center) and raise the hood. Once you have raised the food slightly, you can release the lever.

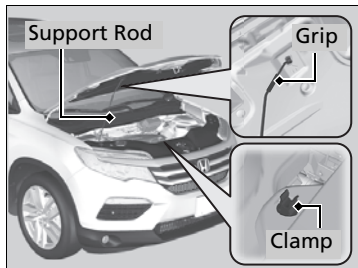

4. Remove the support rod from the clamp using the grip. Mount the support rod in the hood.

When closing, remove the support rod, and stow it in the clamp, then gently lower the hood. Remove your hand at a height of approximately 12 inches (30 cm) and let the hood close.

### ►► Opening the Hood

#### NOTICE

Do not open the hood when the wiper arms are raised. The hood will strike the wipers, and may damage either the hood or the wipers.

When closing the hood, check that the hood is securely latched.

If the hood latch lever moves stiffly, or if you can open the hood without lifting the lever, the latch mechanism should be cleaned and lubricated.

#### Models with Auto Idle-stop

Do not open the hood while the Auto Idle-stop function is activated.

## Engine Compartment Cover

The component parts in the engine compartment are protected by a cover. You may need to remove the cover when you perform certain maintenance work. Pull up on the engine compartment cover, remove it from the pins.

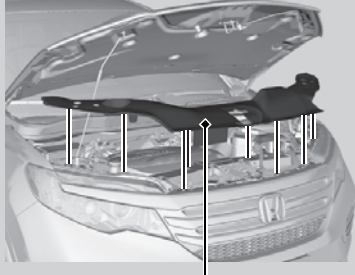

Engine Compartment Cover

## Recommended Engine Oil

- **Genuine Honda Motor Oil**
- **Premium-grade 0W-20 detergent oil with an API Certification Seal on the container.**



Oil is a major contributor to your engine's performance and longevity. If you drive the vehicle with insufficient or deteriorated oil, the engine may fail or be damaged.

This seal indicates the oil is energy conserving and that it meets the American Petroleum Institute's latest requirements.

Use a Genuine Honda Motor Oil or another commercial engine oil of suitable viscosity for the ambient temperature as shown.

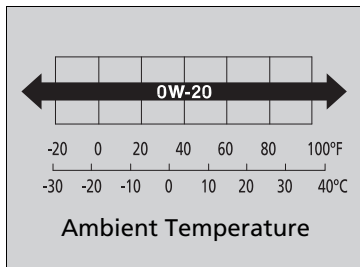

### ■ Synthetic oil

You may also use synthetic motor oil if it is labeled with the API Certification Seal and is the specified viscosity grade.

### ►► Recommended Engine Oil

#### Engine Oil Additives

Your vehicle does not require oil additives. In fact, they may adversely affect the engine performance and durability.

## Oil Check

We recommend that you check the engine oil level every time you refuel.

Park the vehicle on level ground.

Wait approximately three minutes after turning the engine off before you check the oil.

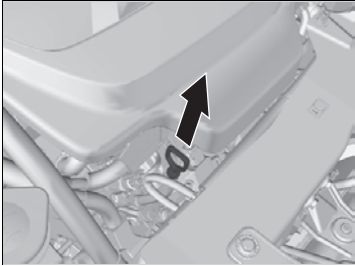

1. Remove the dipstick (orange).
2. Wipe the dipstick with a clean cloth or paper towel.
3. Insert the dipstick back all the way into its hole.

4. Remove the dipstick again, and check the level. It should be between the upper and lower marks. Add oil if necessary.

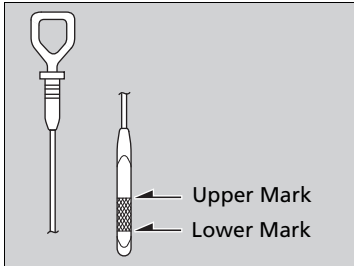

### Oil Check

If the oil level is near or below the lower mark, slowly add oil being careful not to overfill.

## Adding Engine Oil

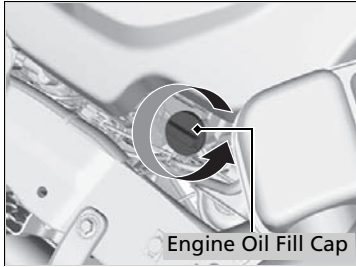

1. Unscrew and remove the engine oil fill cap.
2. Add oil slowly.
3. Reinstall the engine oil fill cap, and tighten it securely.
4. Wait for three minutes and recheck the engine oil dipstick.

### ► Adding Engine Oil

If any oil spills, wipe it up immediately. Spilled oil may damage the engine compartment components.

#### **NOTICE**

Do not fill the engine oil above the upper mark. Overfilling the engine oil can result in leaks and engine damage.

## Changing the Engine Oil and Oil Filter

You must change the engine oil and oil filter regularly in order to maintain the engine's lubrication. The engine may be damaged if they are not changed regularly.

Change the oil and filter in accordance with the maintenance message on the multi-information display.

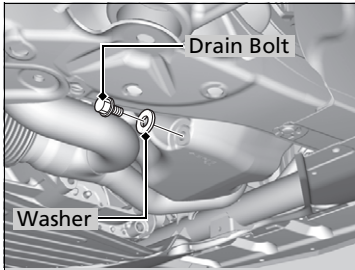

1. Run the engine until it reaches normal operating temperature, and then turn the engine off.
2. Open the hood and remove the engine oil fill cap.
3. Remove the drain bolt and washer from the bottom of the engine, and drain the oil into a suitable container.

### Changing the Engine Oil and Oil Filter

#### NOTICE

You may damage the environment if you do not dispose of the oil in a suitable way. If you are changing the oil by yourself, appropriately dispose of the used oil. Put the oil in a sealed container and take it to a recycling center. Do not throw the oil away into a garbage can or onto the ground.

Continued

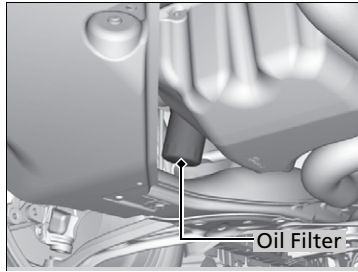

4. Remove the oil filter and dispose of the remaining oil.
5. Check that the filter gasket is not stuck to the engine contact surface.
  - If it is stuck, you must detach it.
6. Wipe away dirt and dust adhering to the contact surface of the oil filter base, and install a new oil filter.
  - Apply a light coat of new engine oil to the oil filter rubber seal.
7. Put a new washer on the drain bolt, then reinstall the drain bolt.
  - Tightening torque:  
29 lbf·ft (39 N·m, 4.0 kgf·m)
8. Pour the recommended engine oil into the engine.
  - Engine oil change capacity (including filter):  
5.7 US qt (5.4 ℓ)
9. Reinstall the engine oil fill cap securely and start the engine.
10. Run the engine for a few minutes, and then check that there is no leak from the drain bolt or oil filter.
11. Stop the engine, wait for three minutes, and then check the oil level on the dipstick.
  - If necessary, add more engine oil.

#### ► Changing the Engine Oil and Oil Filter

You will need a special wrench to replace the oil filter. You can buy this wrench from a dealer.

When installing the new oil filter, follow the instructions supplied with the oil filter.

Reinstall the engine oil fill cap. Start the engine. The low oil pressure indicator should go off within five seconds. If it does not, turn off the engine, and check your work.

## Engine Coolant

### Specified coolant: Honda Long Life Antifreeze/Coolant Type 2

This coolant is premixed with 50% antifreeze and 50% water. Do not add any straight antifreeze or water.

We recommend you check the engine coolant level every time you refuel. Check the reserve tank first. If it is completely empty, also check the coolant level in the radiator. Add the engine coolant accordingly.

### Reserve Tank

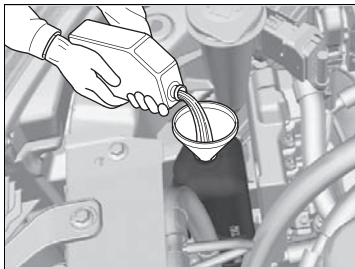
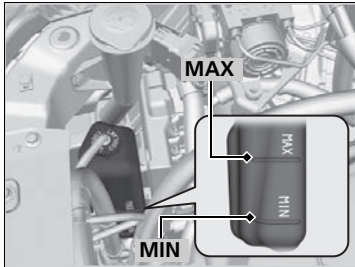

1. Check the amount of coolant in the reserve tank.
2. If the coolant level is below the **MIN** mark, add the specified coolant until it reaches the **MAX** mark.
3. Inspect the cooling system for leaks.

### Engine Coolant

## ⚠ WARNING

Removing the radiator cap while the engine is hot can cause the coolant to spray out, seriously scalding you.

Always let the engine and radiator cool down before removing the radiator cap.

### NOTICE

Genuine Honda engine coolant is a 50/50 mixture of antifreeze and water that can withstand freezing at temperatures as low as about -31°F (-35°C). If your vehicle is consistently subjected to temperatures below this, the concentration of antifreeze in the coolant should be increased. Consult a dealer for details.

If Honda antifreeze/coolant is not available, you may use another major brand non-silicate coolant as a temporary replacement. Check that it is a high quality coolant recommended for aluminum engines. Continued use of any non-Honda coolant can result in corrosion, causing the cooling system to malfunction or fail. Have the cooling system flushed and refilled with Honda antifreeze/coolant as soon as possible.

Do not add rust inhibitors or other additives to your vehicle's cooling system. They may not be compatible with the coolant or with the engine components.

*Continued*



## ■ Radiator

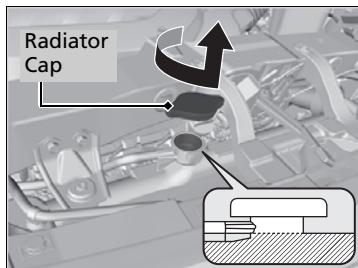

**1. Make sure the engine and radiator are cool.**

**2. Remove the engine compartment cover.**

➤ **Engine Compartment Cover** P. 577

**3. Turn the radiator cap counterclockwise and relieve any pressure in the coolant system. Do not push the cap down when turning.**

**4. Push down and turn the radiator cap counterclockwise to remove it.**

**5. The coolant level should be up to the base of the filler neck. Add coolant if it is low.**

**6. Put the radiator cap back on, and tighten it fully.**

**7. Pour coolant into the reserve tank until it reaches the **MAX** mark. Put the cap back on the reserve tank.**

## » Radiator

### NOTICE

Pour the fluid slowly and carefully so you do not spill any. Clean up any spills immediately; they can damage components in the engine compartment.

## Transmission Fluid

### Automatic Transmission Fluid

Automatic transmission models with shift lever

**Specified fluid: Honda ATF DW-1 (automatic transmission fluid)**

Automatic transmission models with electronic gear selector

**Specified fluid: Honda Automatic Transmission Fluid ATF-TYPE 3.1 or higher**

All models

Have a dealer check the fluid level and replace if necessary.

Do not attempt to check or change the automatic transmission fluid yourself.

### Automatic Transmission Fluid

#### NOTICE

Automatic transmission models with shift lever

**Do not mix Honda ATF DW-1 (automatic transmission fluid) with other transmission fluids.**

Using a transmission fluid other than Honda ATF DW-1 (automatic transmission fluid) may adversely affect the operation and durability of your vehicle's transmission, and damage the transmission. Any damage caused by using a transmission fluid that is not equivalent to Honda ATF DW-1 (automatic transmission fluid) is not covered by Honda's new vehicle warranty.

Automatic transmission models with electronic gear selector

**Do not mix Honda ATF-TYPE 3.1 (or higher) with other transmission fluids.**

Using a transmission fluid other than Honda ATF-TYPE 3.1 (or higher) may adversely affect the operation and durability of your vehicle's transmission, and damage the transmission. Any damage caused by using a transmission fluid that is not equivalent to Honda ATF-TYPE 3.1 (or higher) is not covered by Honda's new vehicle warranty.

## Brake Fluid

**Specified fluid: Honda Heavy Duty Brake Fluid DOT 3**

### ■ Checking the Brake Fluid

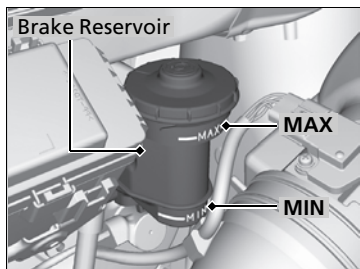

The fluid level should be between the **MIN** and **MAX** marks on the side of the reservoir.

### » Brake Fluid

#### **NOTICE**

Brake fluid marked DOT 5 is not compatible with your vehicle's braking system and can cause extensive damage.

If the specified brake fluid is not available, you should use only DOT 3 or DOT 4 fluid from a sealed container as a temporary replacement.

Using any non-Honda brake fluid can cause corrosion and decrease the longevity of the system. Have the brake system flushed and refilled with Honda Heavy Duty Brake Fluid DOT 3 as soon as possible.

If the brake fluid level is at or below the **MIN** mark, have a dealer inspect for leaks or worn brake pads as soon as possible.

### Refilling Window Washer Fluid

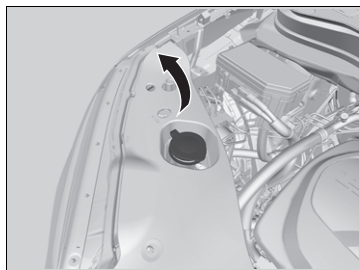

#### **Models without washer level sensor**

Check the amount of window washer fluid by looking at the reservoir. If the level is low, fill the washer reservoir.

#### **Models with washer level sensor**

If the washer fluid is low, a message appears on the MID.

### » Refilling Window Washer Fluid

#### **NOTICE**

Do not use engine antifreeze or a vinegar/water solution in the windshield washer reservoir. Antifreeze can damage your vehicle's paint. A vinegar/water solution can damage the windshield washer pump.

Pour the washer fluid carefully. Do not overflow the reservoir.

## Headlight Bulbs

When replacing, use the following bulbs.

<b>High beam headlight:</b>	<b>60 W (HB3 for halogen bulb type)</b>
<b>Low beam headlight:</b>	<b>LED type</b>
	<b>Models with Auto high-beam system</b>
	<b>Models without Auto high-beam system</b>
	<b>55 W (H11 for halogen bulb type)</b>

### High Beam Headlight

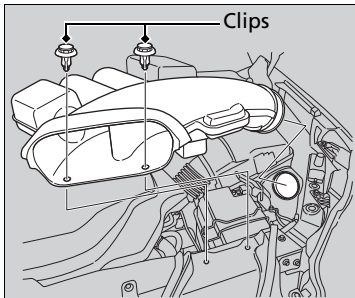

#### Driver side

1. Remove the clips.
2. Remove the air intake duct.

#### Headlight Bulbs

##### NOTICE

Halogen bulbs get very hot when lit. Oil, perspiration, or a scratch on the glass can cause the bulb to overheat and shatter.

The headlight aim is set by the factory, and does not need to be adjusted.

##### Models without automatic headlight adjusting system

However, if you regularly carry heavy items in the cargo area, have the aiming readjusted at a dealer or by a qualified technician.

When replacing a halogen bulb, handle it by its base, and protect the glass from contact with your skin or hard objects. If you touch the glass, clean it with denatured alcohol and a clean cloth.

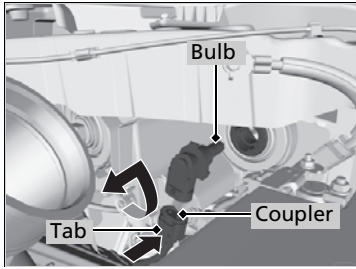

**Both sides**

3. Push the tab to remove the coupler.
4. Rotate the old bulb counterclockwise to remove.
5. Insert a new bulb into the headlight assembly and turn it clockwise.
6. Insert the coupler into the connector of the bulb.

►► Headlight Bulbs

Remove clip using phillips head screwdriver.

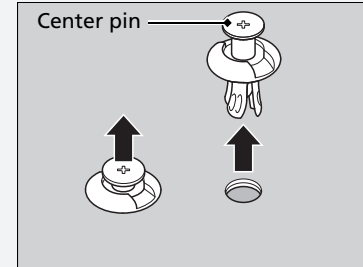

Insert the clip with the central pin raised, and push until it is flat.

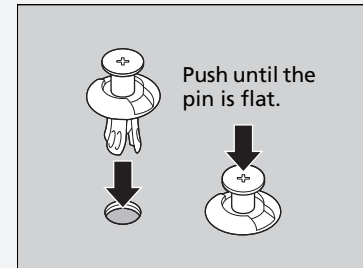

## Low Beam Headlights

### Models without Auto high-beam system

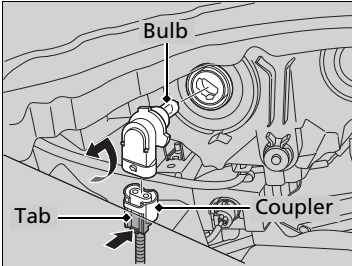

1. Push the tab to remove the coupler.
2. Rotate the old bulb counterclockwise to remove.
3. Insert a new bulb into the headlight assembly and turn it clockwise.
4. Insert the coupler into the connector of the bulb.

## Daytime Running Lights and Parking Lights

### Models with fog light

Daytime running lights and parking lights are LED type. Have an authorized Honda dealer inspect and replace the light assembly.

### Models without fog light

Daytime running light bulbs and high beam headlight bulbs are the same.

➤ **Headlight Bulbs** P. 587

Parking light bulbs and front turn signal bulbs are the same.

➤ **Front Turn Signal/Parking\* and Fog\* Light Bulbs** P. 590

## Front Side Marker Lights

Front side marker lights are LED type. Have an authorized Honda dealer inspect and replace the light assembly.

\* Not available on all models

### Low Beam Headlights

#### Models with Auto high-beam system

Low beam headlights are LED type. Have an authorized Honda dealer inspect and replace the light assembly.

## Front Turn Signal/Parking\* and Fog\* Light Bulbs

When replacing, use the following bulbs.

**Front Turn Signal/Parking\* Light: 28/8W (Amber)**  
**Fog Light\*: 35 W (H8 for halogen bulb type)**

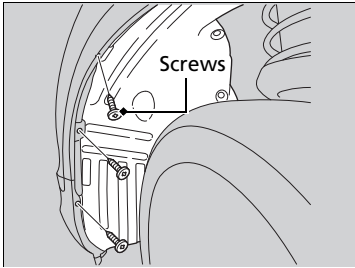

1. Remove the screws, pull the inner fender back.

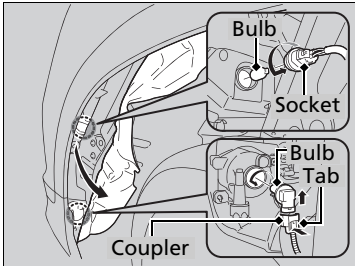

**Models with fog light**

2. Remove the coupler

**All models**

3. Turn the socket counterclockwise and remove it.
4. Remove the old bulb and insert a new bulb.

## Side Turn Signal/Emergency Indicator Lights

Side turn lights are LED type. Have an authorized Honda dealer inspect and replace the light assembly.

## Brake Light and Turn Signal Light Bulbs

When replacing, use the following bulbs.

**Brake Light: LED**  
**Rear Turn Signal Light: 21 W**

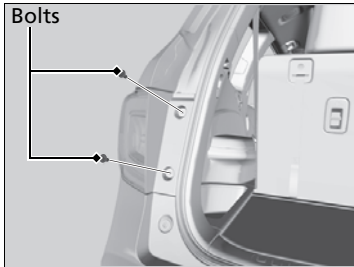

1. Use a Phillip-head screwdriver to remove the bolts.
2. Pull the light assembly out of the rear pillar.

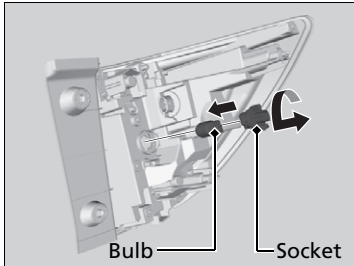

3. Turn the socket counterclockwise and remove it. Remove the old bulb.
4. Insert a new bulb and turn clockwise.
5. Slide the light assembly onto the guide on the body.
6. Align the pins with the body grommets, then push in until they fully seat.

### ☒ Brake Light and Turn Signal Light Bulbs

Brake lights are LED type. Have an authorized Honda dealer inspect and replace the light assembly.

## Taillight and Rear Side Marker Lights

Taillight and rear side marker lights are LED type. Have an authorized Honda dealer inspect and replace the light assembly.



## Back-Up Light

---

When replacing, use the following bulbs.

**Back-Up Light: 21 W**

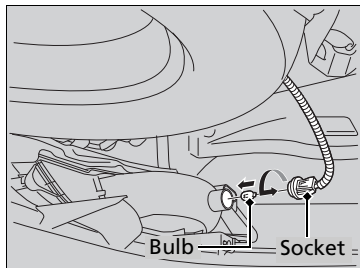

1. Turn the socket counterclockwise and remove it. Remove the old bulb.
2. Insert a new bulb and turn clockwise.

## Rear License Plate Lights

---

Rear license plate lights are LED type. Have an authorized Honda dealer inspect and replace the light assembly.

## High-Mount Brake Light

---

High-mount brake light is LED type. Have an authorized Honda dealer inspect and replace the light assembly.

## Checking Wiper Blades

If the wiper blade rubber has deteriorated, it will leave streaks and the hard surfaces of the blade may scratch the window glass.

## Changing the Front Wiper Blade Rubber

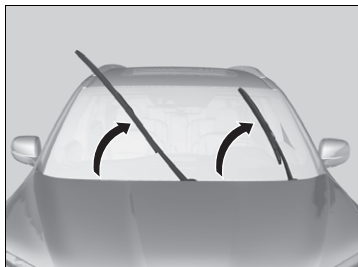

1. Lift the driver side wiper arm first, then the passenger side.

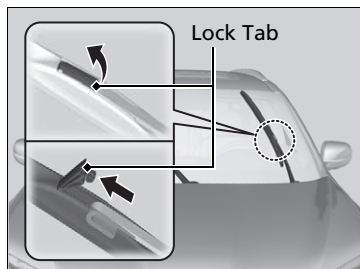

2. Place a cloth on the edge of the lock tab. Push the lock tab up with a flat-tip screw driver.
3. Slide the blade from the wiper arm.

### Changing the Front Wiper Blade Rubber

#### NOTICE

Avoid dropping the wiper arm; it may damage the windshield.

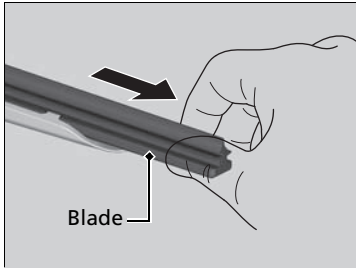

4. Slide the wiper blade out from its holder by pulling the tabbed end out.

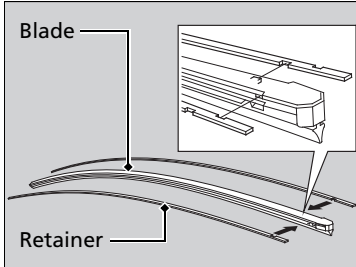

5. Remove the retainers from the rubber blade that has been removed, and mount to a new rubber blade.
  - ▶ Correctly align the rubber protrusion and the retainer grooves.

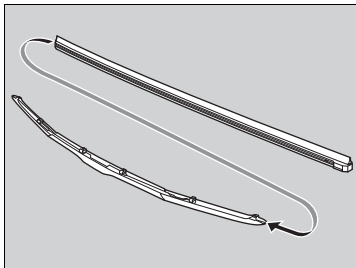

6. Slide the new wiper blade onto the holder from the bottom end.
  - ▶ The tab on the holder should fit in the indent of the wiper blade.
7. Slide the holder onto the wiper arm, then push down the lock tab.
8. Lower the passenger side wiper arm first, then the driver side.

## Changing the Rear Wiper Blade Rubber



1. Raise the wiper arm off.

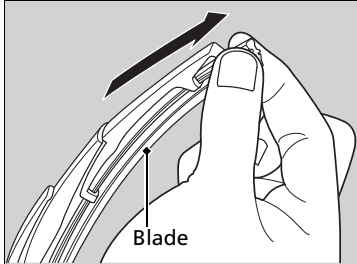

2. Slide the wiper blade out from the end with the indent.

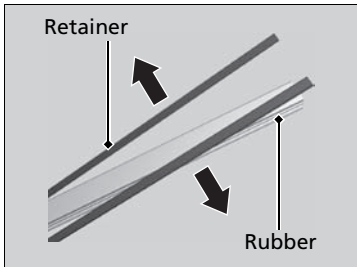

3. Remove the retainers from wiper blade and mount to a new rubber blade.

### Changing the Rear Wiper Blade Rubber

#### NOTICE

Avoid dropping the wiper arm; it may damage the windshield.

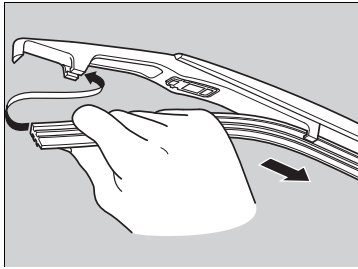

4. Slide the wiper blade onto the holder.
  - ▶ Make sure it is engaged correctly, then install the wiper blade assembly onto the wiper arm.

## Checking Tires

To safely operate your vehicle, your tires must be of the proper type and size, in good condition with adequate tread, and properly inflated.

### ■ Inflation guidelines

Properly inflated tires provide the best combination of handling, tread life, and comfort. Refer to the driver's doorjamb label or specification's page for the specified pressure.

Underinflated tires wear unevenly, adversely affect handling and fuel economy, and are more likely to fail from overheating.

Overinflated tires make your vehicle ride harshly, are more prone to road hazards, and wear unevenly.

Every day before you drive, look at each of the tires. If one looks lower than the others, check the pressure with a tire gauge.

At least once a month or before long trips, use a gauge to measure the pressure in all tires, including the spare. Even tires in good condition can lose 1-2 psi (10-20 kPa, 0.1-0.2 kgf/cm<sup>2</sup>) per month.

### ■ Inspection guidelines

Every time you check inflation, also examine the tires and valve stems. Look for:

- Bumps or bulges on the side or in the tread. Replace the tire if you find any cuts, splits, or cracks in the side of the tire. Replace it if you see fabric or cord.
- Remove any foreign objects and inspect for air leaks.
- Uneven tread wear. Have a dealer check the wheel alignment.
- Excessive tread wear.

➤ **Wear Indicators** P. 602

- Cracks or other damage around valve stem.

### ☒ Checking Tires

## ⚠ WARNING

Using tires that are excessively worn or improperly inflated can cause a crash in which you can be seriously hurt or killed.

Follow all instructions in this owner's manual regarding tire inflation and maintenance.

Measure the air pressure when tires are cold. This means the vehicle has been parked for at least three hours, or driven less than 1 mile (1.6 km). If necessary, add or release air until the specified pressure is reached.

If checked when hot, tire pressure can be as much as 4-6 psi (30-40 kPa, 0.3-0.4 kgf/cm<sup>2</sup>) higher than if checked when cold.

➤ **Tire Pressure Monitoring System (TPMS) with Tire Fill Assist** P. 535

Have a dealer check the tires if you feel a consistent vibration while driving. New tires and any that have been removed and reinstalled should be properly balanced.

## Tire and Loading Information Label

The label attached to the driver's doorjamb provides necessary tire and loading information.

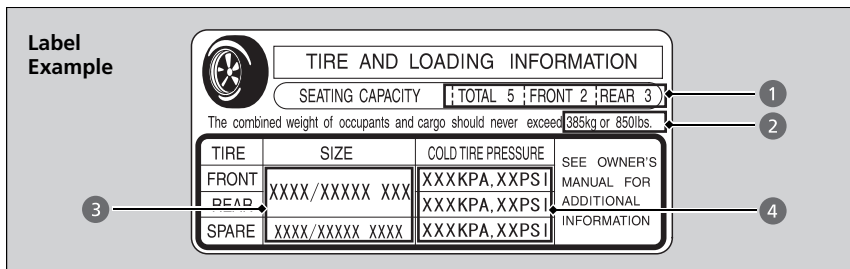

### ▶▶ Tire and Loading Information Label

The tire and loading information label attached to the driver's doorjamb contains:

- 1 The number of people your vehicle can carry.
- 2 The total weight your vehicle can carry. Do not exceed this weight.
- 3 The original tire sizes for front, rear, and spare.
- 4 The proper cold tire pressure for front, rear, and spare.

## Tire Labeling

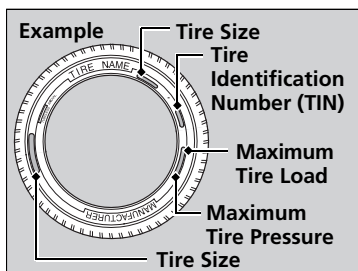

The tires that came on your vehicle have a number of markings. Those you should be aware of are described below.

### ▶▶ Tire Sizes

Following is an example of tire size with an explanation of what each component means.

#### **P235/60R18 102V**

P: Vehicle type (P indicates passenger vehicle).

235: Tire width in millimeters.

60: Aspect ratio (the tire's section height as a percentage of its width).

R: Tire construction code (R indicates radial).

18: Rim diameter in inches.

102: Load index (a numerical code associated with the maximum load the tire can carry).

V: Speed symbol (an alphabetical code indicating the maximum speed rating).

### Tire Sizes

Whenever tires are replaced, they should be replaced with tires of the same size.

## ■ Tire Identification Number (TIN)

The tire identification number (TIN) is a group of numbers and letters that look like the example in the side column. TIN is located on the sidewall of the tire.

## ■ Glossary of Tire Terminology

**Cold Tire Pressure** – The tire air pressure when the vehicle has been parked for at least three hours or driven less than 1 mile (1.6 km).

**Load Rating** – Means the maximum load that a tire is rated to carry for a given inflation pressure.

**Maximum Inflation Pressure** – The maximum tire air pressure that the tire can hold.

**Maximum Load Rating** – Means the load rating for a tire at the maximum permissible inflation pressure for that tire.

**Recommended Inflation Pressure** – The cold tire inflation pressure recommended by the manufacturer.

**Treadwear Indicators (TWI)** – Means the projections within the principal grooves designed to give a visual indication of the degrees of wear of the tread.

## ☒ Tire Identification Number (TIN)

### DOT B97R FW6X 2209

DOT: This indicates that the tire meets all requirements of the U.S. Department of Transportation.

B97R: Manufacturer's identification mark.

FW6X: Tire type code.

22 09: Date of manufacture.

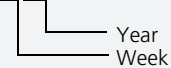



## DOT Tire Quality Grading (U.S. Vehicles)

The tires on your vehicle meet all U.S. Federal Safety Requirements. All tires are also graded for treadwear, traction, and temperature performance according to Department of Transportation (DOT) standards. The following explains these gradings.

### ■ Uniform Tire Quality Grading

Quality grades can be found where applicable on the tire sidewall between tread shoulder and maximum section width.

### ■ Treadwear

The treadwear grade is a comparative rating based on the wear rate of the tire when tested under controlled conditions on a specified government test course. For example, a tire graded 150 would wear one and one-half (1 1/2) times as well on the government course as a tire graded 100. The relative performance of tires depends upon the actual conditions of their use, however, and may depart significantly from the norm due to variations in driving habits, service practices and differences in road characteristics and climate.

### ▣ Uniform Tire Quality Grading

For example:

**Treadwear 200**  
**Traction AA**  
**Temperature A**

All passenger car tires must conform to Federal Safety Requirements in addition to these grades.

## ■ Traction

The traction grades, from highest to lowest, are AA, A, B, and C. Those grades represent the tire's ability to stop on wet pavement as measured under controlled conditions on specified government test surfaces of asphalt and concrete. A tire marked C may have poor traction performance.

## ■ Temperature

The temperature grades are A (the highest), B, and C, representing the tire's resistance to the generation of heat and its ability to dissipate heat when tested under controlled conditions on a specified indoor laboratory test wheel. Sustained high temperature can cause the material of the tire to degenerate and reduce tire life, and excessive temperature can lead to sudden tire failure. The grade C corresponds to a level of performance which all passenger car tires must meet under the Federal Motor Vehicle Safety Standard No. 109. Grades B and A represent higher levels of performance on the laboratory test wheel than the minimum required by law.

### ☒ Traction

Warning: The traction grade assigned to this tire is based on straight-ahead braking traction tests, and does not include acceleration, cornering, hydroplaning, or peak traction characteristics.

### ☒ Temperature

Warning: The temperature grade for this tire is established for a tire that is properly inflated and not overloaded. Excessive speed, underinflation, or excessive loading, either separately or in combination, can cause heat buildup and possible tire failure.

## Wear Indicators

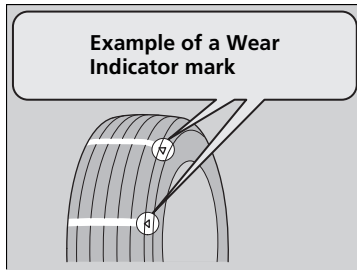

The groove where the wear indicator is located is 1/16 inch (1.6 mm) shallower than elsewhere on the tire. If the tread has worn so that the indicator is exposed, replace the tire.

**Worn out tires have poor traction on wet roads.**

## Tire Service Life

The life of your tires is dependent on many factors, including driving habits, road conditions, vehicle loading, inflation pressure, maintenance history, speed, and environmental conditions (even when the tires are not in use).

In addition to regular inspections and inflation pressure maintenance, it is recommended that you have annual inspections performed once the tires reach five years old. All tires, including the spare, should be removed from service after 10 years from the date of manufacture, regardless of their condition or state of wear.

## Tire and Wheel Replacement

Replace your tires with radials of the same size, load range, speed rating, and maximum cold tire pressure rating (as shown on the tire's sidewall). Using tires of a different size or construction can cause certain vehicle systems such as the ABS and Vehicle Stability Assist (VSA®) system to work incorrectly.

It is best to replace all four tires at the same time. If that isn't possible, replace the front or rear tires in pairs.

If you replace a wheel, only use TPMS specified wheels approved for your vehicle.

Make sure that the wheel's specifications match those of the original wheels.

### ⚠ Tire and Wheel Replacement

#### **⚠ WARNING**

Installing improper tires on your vehicle can affect handling and stability. This can cause a crash in which you can be seriously hurt or killed.

Always use the size and type of tires recommended in this owner's manual.

## Tire Rotation

Rotating tires according to the maintenance messages on the MID helps to distribute wear more evenly and increase tire life.

### ■ Tires without rotation marks

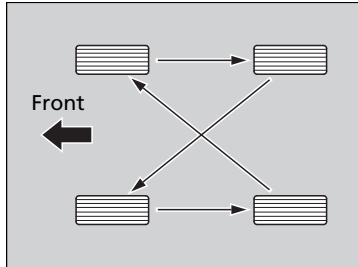

Rotate the tires as shown here.

### ■ Tires with rotation marks

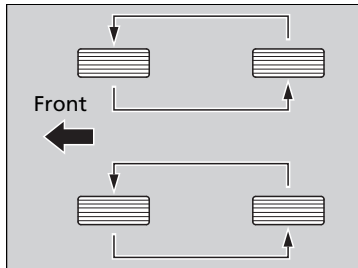

Rotate the tires as shown here.

### ►► Tire Rotation

Tires with directional tread patterns should only be rotated front to back (not from one side to the other). Directional tires should be mounted with the rotation indication mark facing forward, as shown below.

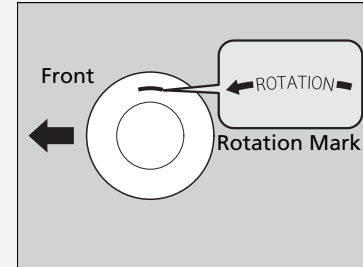

## Winter Tires

If driving on snowy or frozen roads, mount all season marked “M+S” tires, snow tires, or tire chains; reduce speed; and maintain sufficient distance between vehicles when driving.

Be particularly careful when operating the steering wheel or brakes to prevent skidding.

Use tire chains, snow tires, or all season tires when necessary or according to the law.

When mounting, refer to the following points.

For winter tires:

- Select the size and load ranges that are the same as the original tires.
- Mount the tires to all four wheels.

For tire chains:

- Install them on the front tires only.
- Because your vehicle has limited tire clearance, we strongly recommend using the chains listed below:

**Cable-type: SCC Cable Chain ZT735**

- Follow the chain manufacturer’s instruction when installing. Mount them as tightly as you can.
- Check that the chains do not touch the brake lines or suspension.
- Drive slowly.

### ❗ Winter Tires

#### ⚠ WARNING

Using the wrong chains, or not properly installing chains, can damage the brake lines and cause a crash in which you can be seriously injured or killed.

Follow all instructions in this owner’s manual regarding the selection and use of tire chains.

#### NOTICE

Traction devices that are the wrong size or improperly installed can damage your vehicle’s brake lines, suspension, body, and wheels. Stop driving if they are hitting any part of the vehicle.

When tire chains are mounted, follow the chain manufacturer’s instructions regarding vehicle operational limits.

If your vehicle is equipped with summer tires, be aware that these tires are not designed for winter driving conditions. For more information, contact a dealer.

## Checking the Battery

The battery condition is being monitored by the sensor on the negative terminal. If there is a problem with the sensor, the warning message on MID will let you know. Have your vehicle checked by a dealer.

If your vehicle's battery is disconnected or goes dead:

- The audio system is disabled.
  - **Audio System Theft Protection** P. 221
- The clock resets.
  - **Clock** P. 120

## Charging the Battery

Disconnect both battery cables to prevent damaging your vehicle's electrical system. Always disconnect the negative (-) cable first, and reconnect it last.

### ⓘ Battery

#### **WARNING**

The battery gives off explosive hydrogen gas during normal operation.

A spark or flame can cause the battery to explode with enough force to kill or seriously hurt you.

When conducting any battery maintenance, wear protective clothing and a face shield, or have a skilled technician do it.

**WARNING:** Battery post, terminals, and related accessories contain lead and lead compounds.

**Wash your hands after handling.**

When you find corrosion, clean the battery terminals by applying a baking powder and water solution. Clean the terminals with a damp towel. Cloth/towel dry the battery. Coat the terminals with grease to help prevent future corrosion.

When replacing the battery, the replacement must be of the same specifications. Please consult a dealer for more information.

## Charging the AGM Battery\*

AGM labeled batteries like those installed in your vehicle require a compatible charger to be properly charged. Damage to the battery can result if the battery is charged improperly or with the wrong equipment. For more information on how to charge your vehicle's AGM battery, consult a dealer.

### ▶▶ Battery

#### Models with Auto Idle-stop

The battery installed in this vehicle is specifically designed for a model with Auto Idle-stop. Using a battery other than this specified type may shorten the battery life, and prevent Auto Idle-stop from activating. If you need to replace the battery, make sure to select the specified type. Ask a dealer for more details.

\* Not available on all models



## Replacing the Button Battery

If the indicator does not come on when the button is pressed, replace the battery.



### Battery type: CR2032

1. Remove the built-in key.
2. Remove the upper half of the cover by carefully prying on the edge with a coin.
  - ▶ Remove carefully to avoid losing the buttons.
  - ▶ Wrap a coin with a cloth to prevent scratching the transmitter.
3. Make sure to replace the battery with the correct polarity.

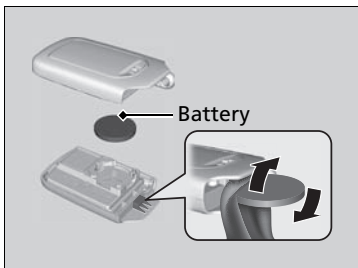

### Replacing the Button Battery

#### NOTICE

An improperly disposed of battery can damage the environment. Always confirm local regulations for battery disposal.

Replacement batteries are commercially available or at a dealer.

Models with Rear Entertainment System

## Replacing the Battery

### Remote Control

If it takes several pushes on the remote control buttons to operate the rear entertainment system, replace the battery.

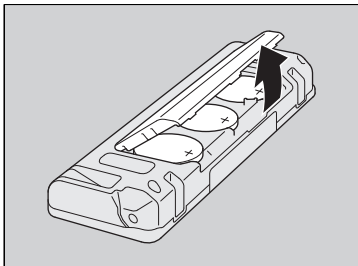

**Battery type: BR3032**

1. Remove the cover.
2. Make sure to replace the battery with the correct polarity.

### Replacing the Battery

#### NOTICE

An improperly disposed of battery can damage the environment. Always confirm local regulations for battery disposal.

Replacement batteries are commercially available or at a dealer.

## ■ Wireless Headphone

If there is no sound coming from the wireless headphone, replace the battery.

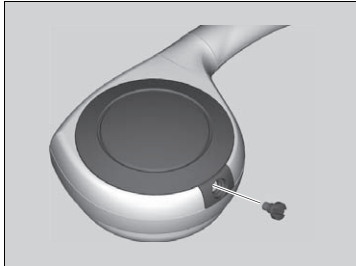

**Battery type: AAA**

1. Remove the screw.

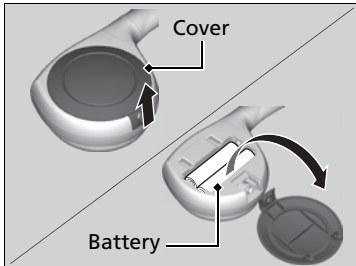

2. Open the cover.

3. Make sure to replace the battery with the correct polarity.

## Air Conditioning

To ensure proper and safe operation, the Society of Automotive Engineers (SAE J2845) recommends that the refrigerant system only be serviced by trained and certified technicians.

Never repair or replace the air conditioning evaporator (cooling coil) with one removed from a used or salvaged vehicle.

New replacement mobile air conditioning evaporators must be certified (and labeled) as meeting SAE Standard J2842.

### Heating and Cooling System\*/Climate Control System\* Maintenance

#### NOTICE

Vented refrigerant is harmful to the environment. To avoid refrigerant from venting, never replace the evaporator with one removed from a used or salvaged vehicle.

Refrigerant in your vehicle's air conditioning system is flammable and can be ignited during servicing if proper procedures are not followed.

Air Conditioner label is found under the hood:

➤ **Safety Labels** P. 75

➤ **Specifications** P. 652

#### Canadian models



 : Caution

 : Flammable Refrigerant

 : Requires Registered Technician to Service

 : Air Conditioning System

\* Not available on all models

## Dust and Pollen Filter

The climate control system is equipped with a dust and pollen filter that collects pollen, dust, and other debris in the air. The Maintenance Minder™ messages will let you know when to replace the filter.

We recommend that you replace the dust and pollen filter sooner when using your vehicle in areas with high concentrations of dust.

### » Dust and Pollen Filter

If the airflow from the climate control system deteriorates noticeably, and the windows fog up easily, the filter may need to be replaced. Please contact a dealer for replacement.

## Interior Care

Use a damp cloth with a mixture of mild detergent and warm water to remove dirt. Use a clean cloth to remove detergent residue.

### Cleaning Seat Belts

Use a soft brush with a mixture of mild soap and warm water to clean the seat belts. Let the belts air dry. Wipe the loops of the seat belt anchors using a clean cloth.

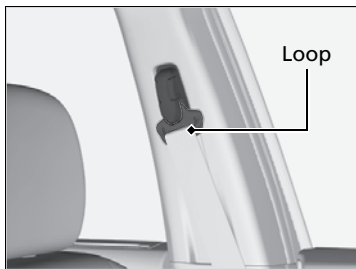

### Cleaning the Window

Wipe using a glass cleaner.

#### Interior Care

Do not spill liquids inside the vehicle. Electrical devices and systems may malfunction if liquids are splashed on them.

Do not use silicone based sprays on electrical devices such as audio devices and switches. Doing so may cause the items to malfunction or a fire inside the vehicle. If a silicone based spray is inadvertently used on electrical devices, consult a dealer.

Depending on their composition, chemicals and liquid aromatics may cause discoloration, wrinkles, and cracking to resin-based parts and textiles. Do not use alkali solvents or organic solvents such as benzene or gasoline.

After using chemicals, make sure to gently wipe them off using a dry cloth. Do not place used cloths on top of resin based parts or textiles for long periods of time without washing.

#### Cleaning the Window

Wires are mounted to the inside of the rear window. Wipe along the same direction as the wires with a soft cloth so as not to damage them.

## ■ Floor Mats

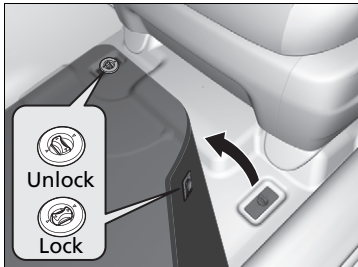

The front and second row passenger's floor mats hook over the floor anchors, which keep the mats from sliding forward. To remove a mat for cleaning, turn the anchor knobs to the unlock position. When reinstalling the mat after cleaning, turn the knobs to the lock position.

**Do not put additional floor mats on top of the anchored mat.**

## ■ Maintaining Genuine Leather\*

Vacuum dirt and dust from the leather frequently. Pay close attention to the pleats and seams. Clean the leather with a soft cloth dampened with a 90% water and 10% neutral soap solution. Then buff it with a clean, dry cloth. Remove any dust or dirt on leather surfaces immediately.

## » Floor Mats

If you use any floor mats that were not originally provided with your vehicle, make sure they are designed for your specific vehicle, fit correctly, and are securely anchored by the floor anchors. Position the rear seat floor mats properly. If they are not properly positioned, the floor mats can interfere with the front seat functions.

## Exterior Care

Dust off the vehicle body after you drive.

Regularly inspect your vehicle for scratches on painted surfaces. A scratch on a painted surface can result in body rust. If you find a scratch, promptly repair it.

### Washing the Vehicle

Wash the vehicle regularly. Wash more frequently when driving in the following conditions:

- If driving on roads with road salt.
- If driving in coastal areas.
- If tar, soot, bird droppings, insects, or tree sap are stuck to painted surfaces.

### Using an Automated Car Wash

- Fold in the door mirrors.
- Turn off the automatic intermittent wipers\*.

Make sure to follow the instructions indicated on the automated car wash.

Automatic transmission models with electronic gear selector

If you use a conveyor type automatic car wash, keep the transmission in **[N]** position.

▶ **If you want to keep the transmission in **[N]** position [car wash mode]** P. 485

### Using High Pressure Cleaners

- Keep sufficient distance between the cleaning nozzle and the vehicle body.
- Take particular care around the windows. Standing too close may cause water to enter the vehicle interior.
- Do not spray high pressure water directly into the engine compartment. Instead, use low pressure water and a mild detergent.

### Washing the Vehicle

Do not spray water into the air intake vents. It can cause a malfunction.

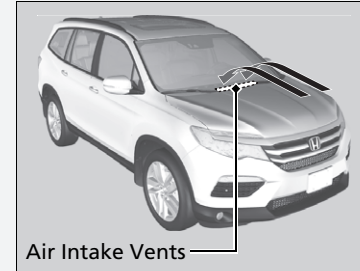

Air Intake Vents

Do not spray water onto the capless unit when the fuel fill door is open. It can cause damage to the fuel system or engine.

\* Not available on all models

Continued



## ■ Applying Wax

A good coat of automotive body wax helps protect your vehicle's paint from the elements. Wax will wear off over time and expose your vehicle's paint to the elements, so reapply as necessary.

## ■ Maintaining the Bumpers and Other Resin Coated Parts

If you get gasoline, oil, engine coolant, or battery fluid on resin coated parts, they may be stained or the coating may peel. Promptly wipe it away using a soft cloth and clean water.

## ■ Cleaning the Window

Wipe using a glass cleaner.

## ■ Maintaining Aluminum Wheels

Aluminum is susceptible to deterioration caused by salt and other road contaminants. Use a sponge and mild detergent to wipe away promptly. Be careful not to use harsh chemicals (including some commercial wheel cleaners) or a stiff brush. They can damage the clear coat of the aluminum alloy wheels that helps keep the aluminum from corroding and tarnishing.

## ►► Applying Wax

### NOTICE

Chemical solvents and strong cleaners can damage the paint, metal, and plastic on your vehicle. Wipe up spills immediately.

## ►► Maintaining the Bumpers and Other Resin Coated Parts

Ask a dealer about the correct coating material when you want to repair the painted surface of the parts made of resin.

## ■ Fogged Exterior Light Lenses

The inside lenses of exterior lights (headlights, brake lights, etc.) may fog temporarily if you have driven in the rain, or after the vehicle has been run through a car wash. Dew condensation also may build up inside the lenses when there is a significant enough difference between the ambient and inside lens temperatures (similar to vehicle windows fogging up in rainy conditions). These conditions are natural processes, not structural design problems in the exterior lights.

Lens design characteristics may result in moisture developing on the light lens frame surfaces. This also is not a malfunction.

However, if you see large amounts water accumulation, or large water drops building up inside the lenses, have your vehicle inspected by a dealer.

## Accessories

When installing accessories, check the following:

- Do not install accessories on the windshield. They can obstruct your view and delay your reaction to driving conditions.
- Do not install any accessories over areas marked SRS Airbag, on the sides or backs of the front seats, on front or side pillars, or near the side windows. Accessories installed in these areas may interfere with proper operation of the vehicle's airbags or may be propelled into you or another occupant if the airbags deploy.
- Be sure electronic accessories do not overload electrical circuits or interfere with proper operation of your vehicle.
  - **Fuses** P. 642
- Before installing any electronic accessory, have the installer contact a dealer for assistance. If possible, have a dealer inspect the final installation.

## Modifications

Do not modify your vehicle in a manner that may affect its handling, stability, or reliability, or install non-genuine Honda parts or accessories that may have a similar effect.

The on-board diagnostic port (OBD-II/J2534 connector) installed on this vehicle is intended to be used only with automobile system diagnostic devices. Use of any other type of device may adversely affect the vehicle's electronic systems or allow them to be compromised, and could result in a system malfunction, drained battery, or other unexpected problems.

Even minor modifications to vehicle systems can affect overall vehicle performance. Always make sure all equipment is properly installed and maintained, and do not make any modification to your vehicle or its systems that might cause your vehicle to no longer meet federal, state, province, territory, and local regulations.

Do not modify or attempt to repair any of the electrical components.

### Accessories and Modifications

## **WARNING**

**Improper accessories or modifications can affect your vehicle's handling, stability, and performance, and cause a crash in which you can be seriously hurt or killed.**

**Follow all instructions in this owner's manual regarding accessories and modifications.**

Honda Genuine accessories are recommended to ensure proper operation on your vehicle.

# Handling the Unexpected

This chapter explains how to handle unexpected troubles.



<b>Tools</b>	
Types of Tools.....	620
<b>If a Tire Goes Flat</b>	
Changing a Flat Tire.....	621
<b>Engine Does Not Start</b>	
Checking the Engine.....	629
If the Smart Entry Remote Battery is Weak.....	630
Emergency Engine Stop .....	631
<b>Shift Lever Does Not Move*</b> .....	632
<b>Jump Starting</b> .....	633

<b>Overheating</b>	
How to Handle Overheating.....	636
<b>Indicator, Coming On/Blinking</b>	
If the Low Oil Pressure Indicator Comes On .....	638
If the Charging System Indicator Comes On .....	638
If the Malfunction Indicator Lamp Comes On or Blinks .....	639
If the Brake System Indicator (Red) Comes On .....	640
If the Electric Power Steering (EPS) System Indicator Comes On.....	640

If the Low Tire Pressure/Tire Pressure Monitoring System (TPMS) Indicator Comes On or Blinks.....	641
If the Transmission Indicator Blinks along with the Warning Message* .....	641
<b>Fuses</b>	
Fuse Locations .....	642
Inspecting and Changing Fuses.....	646
<b>Emergency Towing</b> .....	647
<b>When You Cannot Unlock the Fuel Fill Door.</b>	648
<b>Refueling</b>	
Refueling From a Portable Fuel Container ....	649
<b>When You Cannot Open the Tailgate</b> ..	650

\* Not available on all models

## Types of Tools

### Types of Tools

The tools are stored in the cargo area.

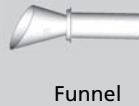
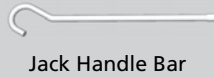
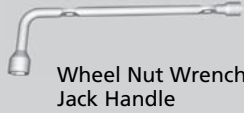
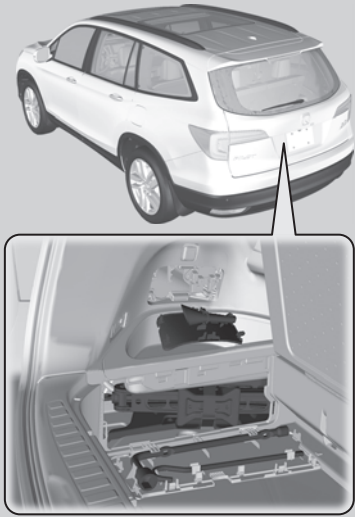

## Changing a Flat Tire

If a tire goes flat while driving, grasp the steering wheel firmly, and brake gradually to reduce speed. Then, stop in a safe place. Replace the flat tire with a compact spare tire. Go to a dealer as soon as possible to have the full-size tire repaired or replaced.

1. Park the vehicle on firm, level, non-slippery surface and apply the parking brake.
2. Change the gear position to **P**.
3. Turn on the hazard warning lights and set the power mode to VEHICLE OFF (LOCK).

### ✘ Changing a Flat Tire

Periodically check the tire pressure of the compact spare. It should be set to the specified pressure.  
Specified Pressure: 60 psi (420 kPa, 4.2 kgf/cm<sup>2</sup>)

When driving with the compact spare tire, keep the vehicle speed under 50 mph (80 km/h). Replace with a full-size tire as soon as possible.

The compact spare tire and wheel in your vehicle are specifically for this model. Do not use them with another vehicle. Do not use another type of compact spare tire or wheel with your vehicle.

Do not mount tire chains on a compact spare tire. If a chain-mounted front tire goes flat, remove one of the full-size rear tires and replace it with the compact spare tire. Remove the flat front tire and replace it with the full-size tire that was removed from the rear. Mount the tire chains on the front tire.

Do not use a puncture-repairing agent on a flat tire, as it can damage the tire pressure sensor.

## ■ Getting Ready to Replace the Flat Tire

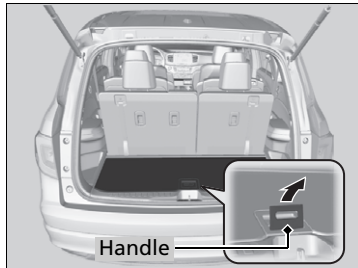

1. Push the rear edge of the handle on the floor lid and open the lid.

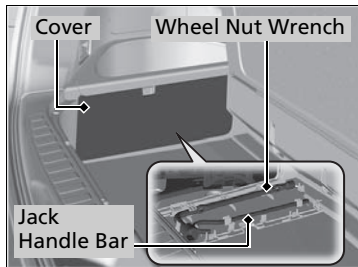

2. Pull and remove the cover. Take the wheel nut wrench and jack-handle bar out of the rear side compartment.

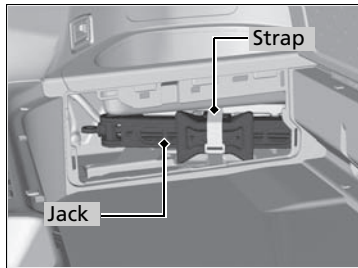

3. Loosen the strap, then take the jack out.

## ▣ Changing a Flat Tire

### NOTICE

Do not use the jack if it doesn't work properly. Call your dealer or a professional towing service.

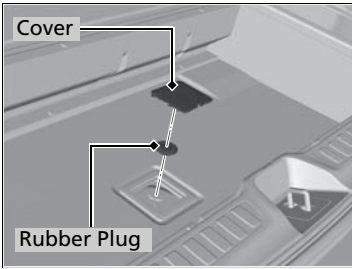

**4.** Remove the cover and the rubber plug on the cargo area lining to access the shaft for the spare tire hoist.

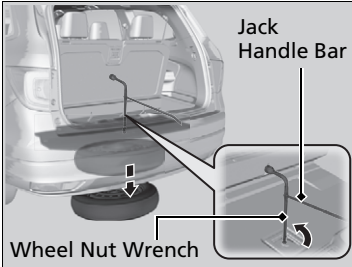

**5.** Put the wheel nut wrench with the jack handle bar on the hoist shaft. Turn the wrench to the left to lower the spare tire to the ground.

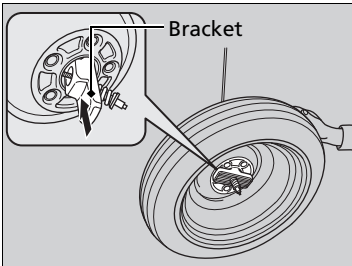

**6.** Keep turning the wheel nut wrench to create slack in the cable.  
**7.** Remove the bracket from the spare tire.



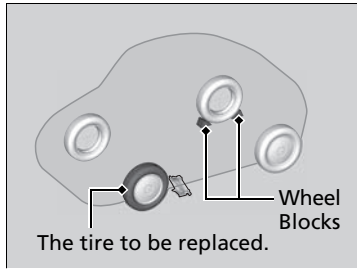

**8.** Place a wheel block or rock in front and rear of the wheel diagonal to the flat tire.

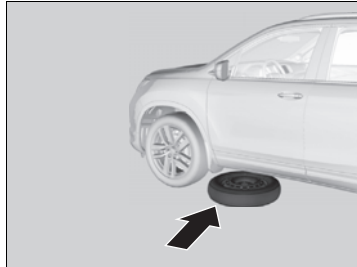

**9.** Place the compact spare tire (wheel side up) under the vehicle body, near the tire that needs to be replaced.



**10.** Loosen each wheel nut about one turn using the wheel nut wrench.

## How to Set Up the Jack

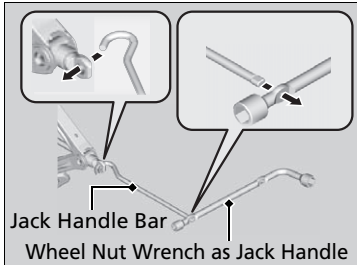
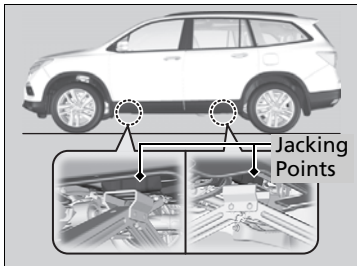

1. Place the jack under the jacking point closest to the tire to be changed.

2. Turn the end bracket clockwise as shown in the image until the top of the jack contacts the jacking point.

▶ Make sure that the jacking point tab is resting in the jack notch.

3. Raise the vehicle, using the jack handle bar and the jack handle, until the tire is off the ground.

### How to Set Up the Jack

## ⚠ WARNING

The vehicle can easily roll off the jack, seriously injuring anyone underneath.

Follow the directions for changing a tire exactly, and never get under the vehicle when it is supported only by the jack.

Do not use the jack with people or luggage in the vehicle.

Use the jack provided in your vehicle. Other jacks may not support the weight ("load") or may not fit the jacking point.

The following instructions must be followed to use the jack safely:

- Do not use while the engine is running.
- Use only where the ground is firm and level.
- Use only at the jacking points.
- Do not get in the vehicle while using the jack.
- Do not put anything on top of or underneath the jack.

## ■ Replacing the Flat Tire

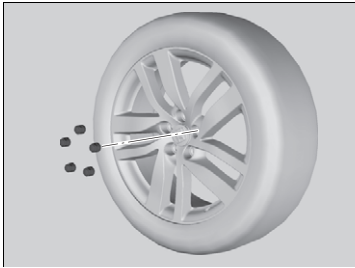

1. Remove the wheel nuts and flat tire.

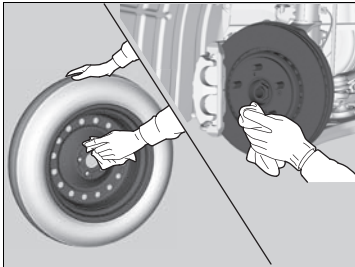

2. Wipe the mounting surfaces of the wheel with a clean cloth.
3. Mount the compact spare tire.
4. Screw the wheel nuts until they touch the lips around the mounting holes, then stop rotating.

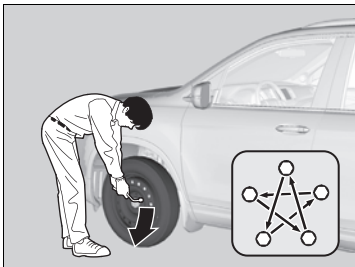

5. Lower the vehicle and remove the jack. Tighten the wheel nuts in the order indicated in the image. Go around, tightening the nuts, two to three times in this order.

**Wheel nut torque:**

94 lbf-ft (127 N·m, 13 kgf·m)

## ▣ Replacing the Flat Tire

Do not over tighten the wheel nuts by applying extra torque using your foot or a pipe.

## Storing the Flat Tire

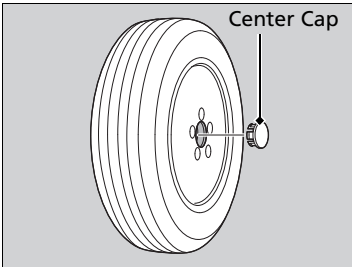

1. Remove the center cap and place the flat tire face up under the hoist.
2. Insert the hoist bracket into the center hole of the flat tire.

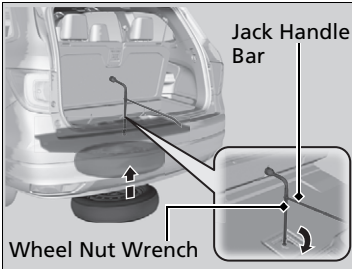

3. Turn the wheel nut wrench with the jack handle bar clockwise until the flat tire rests against the underbody of the vehicle and you hear the hoist click.
4. Securely put the jack and wheel nut wrench back in the tool case. Store the case in the cargo area.

### Storing the Flat Tire

## ⚠ WARNING

Loose items can fly around the interior in a crash and can seriously injure the occupants.  
Store the jack and tools securely before driving.

### ■ TPMS with Tire Fill Assist and the Spare Tire

If you replace a flat tire with the spare tire, the low tire pressure/TPMS indicator comes on while you are driving. After driving for a few miles (kilometers), the indicator will start blinking for a short time and then stay on. **Tire Pressure Monitor Problem** appears on the multi-information display (MID), but this is normal.

If you replace the tire with a specified regular tire, the warning message on the MID and the low tire pressure/TPMS indicator will go off after a few miles (kilometers).

### ▣ TPMS with Tire Fill Assist and the Spare Tire

The system cannot monitor the pressure of the spare tire. Manually check the spare tire pressure to be sure that it is correct.

Use the TPMS specific wheels. Each is equipped with a tire pressure sensor mounted inside the tire behind the valve stem.

## Checking the Engine

If the engine does not start, check the starter.

### ☒ Checking the Engine

If you must start the vehicle immediately, use an assisting vehicle to jump start it.

☒ **Jump Starting** P. 633

Starter condition	Checklist
<b>Starter doesn't turn or turns over slowly.</b> The battery may be dead. Check each of the items on the right and respond accordingly.	<b>Check for a message on the MID.</b> <ul style="list-style-type: none"><li>• If the <b>To Start, Hold Remote Near Start Button</b> message appears<ul style="list-style-type: none"><li>☒ <b>If the Smart Entry Remote Battery is Weak</b> P. 630</li></ul></li><li>▶ Make sure the smart entry remote is in its operating range.<ul style="list-style-type: none"><li>☒ <b>ENGINE START/STOP Button Operating Range</b> P. 152</li></ul></li></ul> <hr/> <b>Check the brightness of the interior lights.</b> <p>Turn on the interior lights and check the brightness.</p> <ul style="list-style-type: none"><li>• If the interior lights are dim or do not come on at all<ul style="list-style-type: none"><li>☒ <b>Battery</b> P. 606</li></ul></li><li>• If the interior lights come on normally ☒ <b>Fuses</b> P. 642</li></ul>
<b>The starter turns over normally but the engine doesn't start.</b> There may be a problem with a fuse. Check each of the items on the right and respond accordingly.	<b>Review the engine start procedure.</b> <p>Follow its instructions, and try to start the engine again. ☒ <b>Starting the Engine</b> P. 471</p> <hr/> <b>Check the immobilizer system indicator.</b> <p>When the immobilizer system indicator is blinking, the engine cannot be started.</p> <ul style="list-style-type: none"><li>☒ <b>Immobilizer System</b> P. 143</li></ul> <hr/> <b>Check the fuel level.</b> <p>There should be enough fuel in the tank. ☒ <b>Fuel Gauge</b> P. 113</p> <hr/> <b>Check the fuses.</b> <p>Check all fuses, or have the vehicle checked by a dealer.</p> <ul style="list-style-type: none"><li>☒ <b>Inspecting and Changing Fuses</b> P. 646</li></ul> <hr/> <b>If the problem continues:</b> <ul style="list-style-type: none"><li>☒ <b>Emergency Towing</b> P. 647</li></ul>

## If the Smart Entry Remote Battery is Weak

If the beeper sounds, the **To Start, Hold Remote Near Start Button** message appears on the MID, the **ENGINE START/STOP** button flashes, and the engine won't start, start the engine as follows:

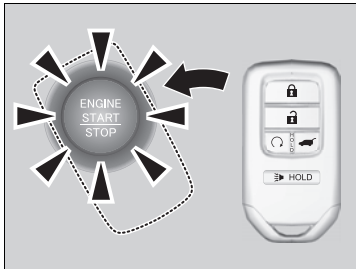

1. Touch the center of the **ENGINE START/STOP** button with the **H** logo on the smart entry remote while the **ENGINE START/STOP** button is flashing. The buttons on the smart entry remote should be facing you.

▶ The **ENGINE START/STOP** button flashes for about 30 seconds.

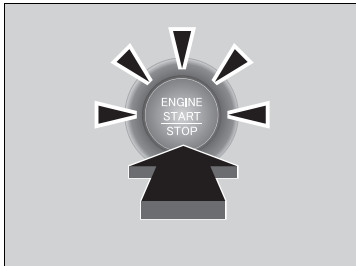

2. Depress the brake pedal and press the **ENGINE START/STOP** button within 10 seconds after the beeper sounds and the **ENGINE START/STOP** button changes from flashing to on.

▶ If you don't depress the pedal, the mode will change to ACCESSORY.

## Emergency Engine Stop

The **ENGINE START/STOP** button may be used to stop the engine due to an emergency situation even while driving. If you must stop the engine, do either of the following operations:

- Press and hold the **ENGINE START/STOP** button for about two seconds.
- Firmly press the **ENGINE START/STOP** button twice.

The steering wheel will not lock. However, because turning off the engine disables the power assist the engine provides to the steering and braking systems, it will require significantly more physical effort and time to steer and slow the vehicle. Use both feet on the brake pedal to slow down the vehicle and stop immediately in a safe place.

### Automatic transmission models with electronic gear selector for U.S. models

The gear position automatically changes to **P** after the vehicle comes to a complete stop. Then, the power mode changes to VEHICLE OFF.

### Automatic transmission models with electronic gear selector for Canadian models

The gear position automatically changes to **P** after the vehicle comes to a complete stop. Then press the **ENGINE START/STOP** button twice without depressing the brake pedal to change the mode VEHICLE OFF.

### Automatic transmission models with shift lever

The power mode is in ACCESSORY when the engine is stopped. To change the mode to VEHICLE OFF, change the gear position to **P** after the vehicle comes to a complete stop.

### Automatic transmission models with shift lever for Canadian models

Then press the **ENGINE START/STOP** button twice without depressing the brake pedal.

### Emergency Engine Stop

Do not press the button while driving unless it is absolutely necessary for the engine to be switched off.



# Shift Lever Does Not Move\*

Follow the procedure below if you cannot move the shift lever out of the **P** position.

## Releasing the Lock

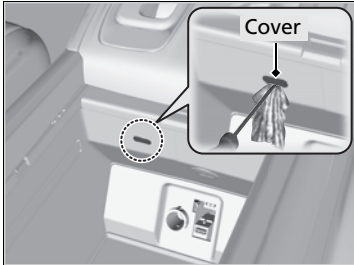

1. Set the parking brake.
2. Remove the built-in key from the smart entry remote.
3. Open the lid of the console compartment.
4. Wrap a cloth around the tip of a small flat-tip screwdriver. Put it into the shift lock release slot as shown in the image, and remove the cover.

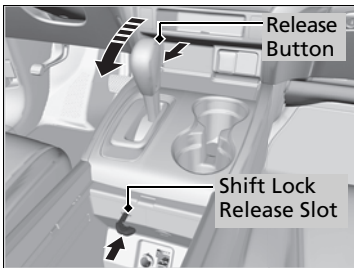

5. Insert the key into the shift lock release slot.
6. While pushing the key down, press the shift lever release button and place the shift lever into **N**.
  - ▶ The lock is now released. Have the shift lever checked by a dealer as soon as possible.

## Jump Starting Procedure

Turn off the power to electric devices, such as audio and lights. Turn off the engine, then open the hood.

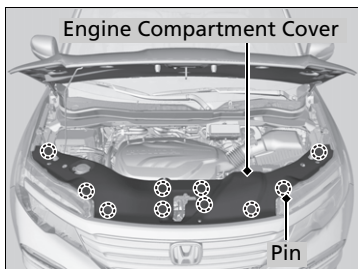

1. Pull up on the engine compartment cover, remove it from the pins.

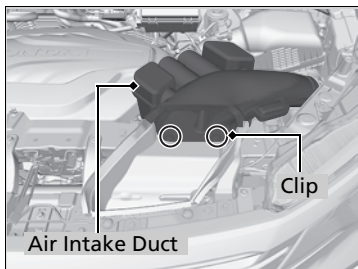

2. Remove the holding clips and the air intake duct.

## Jump Starting

### **⚠ WARNING**

A battery can explode if you do not follow the correct procedure, seriously injuring anyone nearby.

Keep all sparks, open flames, and smoking materials away from the battery.

Securely attach the jumper cables clips so that they do not come off when the engine vibrates. Also be careful not to tangle the jumper cables or allow the cable ends to touch each other while attaching or detaching the jumper cables.

Battery performance degrades in cold conditions and may prevent the engine from starting.

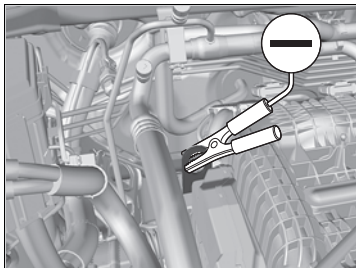
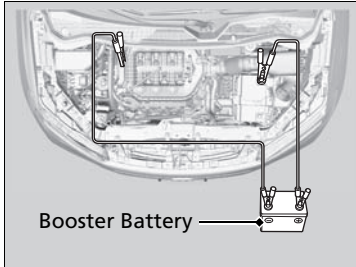
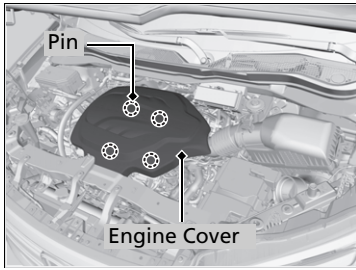

3. Pull up on the engine cover, remove it from the pins.
  - ▶ Start on the passenger side and lift the outermost edge of the cover.
  - ▶ Move towards the driver side while applying uniform upward pressure.
4. Connect the first jumper cable to your vehicle's battery ⊕ terminal.
5. Connect the other end of the first jumper cable to the booster battery ⊕ terminal.
  - ▶ Use a 12-volt booster battery only.
  - ▶ When using an automotive battery charger to boost your 12-volt battery, select a lower charging voltage than 15 volts. Check the charger manual for the proper setting.
6. Connect the second jumper cable to the booster battery ⊖ terminal.
7. Connect the other end of the second jumper cable to the engine hanger as shown. Do not connect this jumper cable to any other part.
8. If your vehicle is connected to another vehicle, start the assisting vehicle's engine and increase its rpm slightly.
9. Attempt to start your vehicle's engine. If it turns over slowly, check that the jumper cables have good metal-to-metal contact.

## ■ What to Do After the Engine Starts

Once your vehicle's engine has started, remove the jumper cables in the following order:

1. Disconnect the jumper cable from your vehicle's ground.
2. Disconnect the other end of the jumper cable from the booster battery  $\ominus$  terminal.
3. Disconnect the jumper cable from your vehicle's battery  $\oplus$  terminal.
4. Disconnect the other end of the jumper cable from the booster battery  $\oplus$  terminal.

Have your vehicle inspected by a nearby service station or a dealer.

## How to Handle Overheating

Overheating symptoms are as follows:

- The temperature gauge needle is at the **H** mark or the engine suddenly loses power.
- Steam or spray comes out of the engine compartment.

### ■ First thing to do

1. Immediately park the vehicle in a safe place.
2. Turn off all accessories and turn on the hazard warning lights.
  - ▶ **No steam or spray present:** Keep the engine running and open the hood.
  - ▶ **Steam or spray is present:** Turn off the engine and wait until it subsides. Then, open the hood.

### » How to Handle Overheating

## **WARNING**

Steam and spray from an overheated engine can seriously scald you.

Do not open the hood if steam is coming out.

### **NOTICE**

Continuing to drive with the temperature gauge needle at the **H** mark may damage the engine.

### ■ Next thing to do

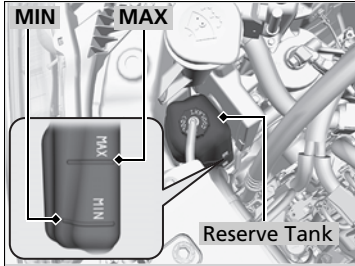

1. Check that the cooling fan is operating and stop the engine once the temperature gauge needle goes down.
  - ▶ If the cooling fan is not operating, immediately stop the engine.
2. Once the engine has cooled down, inspect the coolant level and check the cooling system components for leaks.
  - ▶ If the coolant level in the reserve tank is low, remove the engine compartment cover then add coolant until it reaches the **MAX** mark.
    - 🔧 **Engine Compartment Cover** P. 577
  - ▶ If there is no coolant in the reserve tank, check that the radiator is cool. Cover the radiator cap with a heavy cloth and open the cap. If necessary, add coolant up to the base of the filler neck, and put the cap back on.

### ■ Last thing to do

Once the engine has cooled sufficiently, restart it and check the temperature gauge. If the temperature gauge needle has gone down, resume driving. If it has not gone down, contact a dealer for repairs.

#### 🔧 How to Handle Overheating

## ⚠ WARNING

Removing the radiator cap while the engine is hot can cause the coolant to spray out, seriously scalding you.

Always let the engine and radiator cool down before removing the radiator cap.

If the coolant is leaking, contact a dealer for repairs.

Use water as an emergency/temporary measure only. Have a dealer flush the system with proper antifreeze as soon as possible.

## If the Low Oil Pressure Indicator Comes On



### ■ Reasons for the indicator to come on

Comes on when the engine oil pressure is low.

### ■ What to do as soon as the indicator comes on

1. Immediately park the vehicle on level ground in a safe place.
2. If necessary, turn the hazard warning lights on.

### ■ What to do after parking the vehicle

1. Stop the engine and let it sit for about three minutes.
2. Open the hood and check the oil level.
  - **Oil Check** P. 579
3. Start the engine and check the low oil pressure indicator.
  - ▶ The indicator goes off: Start driving again.
  - ▶ The indicator does not go off within 10 seconds: Stop the engine and contact a dealer for repairs immediately.

## If the Charging System Indicator Comes On



### ■ Reasons for the indicator to come on

Comes on when the battery is not being charged.

### ■ What to do when the indicator comes on

Turn off the climate control system, rear defogger, and other electrical systems, and immediately contact a dealer for repairs.

### ☞ If the Low Oil Pressure Indicator Comes On

#### NOTICE

Running the engine with low oil pressure can cause serious mechanical damage almost immediately.

### ☞ If the Charging System Indicator Comes On

If you need to stop temporarily, do not turn off the engine. Restarting the engine may rapidly discharge the battery.

## If the Malfunction Indicator Lamp Comes On or Blinks



### ■ Reasons for the indicator lamp to come on or blink

- Comes on if there is a problem with the engine emissions control system.
- Blinks when engine misfiring is detected.

### ■ What to do when the indicator lamp comes on

Avoid high speeds and immediately get your vehicle inspected at a dealer.

### ■ What to do when the indicator lamp blinks

Park the vehicle in a safe place with no flammable items and wait at least 10 minutes or more with the engine stopped until it cools.

### ▶ If the Malfunction Indicator Lamp Comes On or Blinks

#### NOTICE

If you drive with the malfunction indicator lamp on, the emissions control system and the engine could be damaged.

If the malfunction indicator lamp blinks again when restarting the engine, drive to the nearest dealer at 31 mph (50 km/h) or less. Have your vehicle inspected.



## If the Brake System Indicator (Red) Comes On

U.S.



### ■ Reasons for the indicator to come on

- The brake fluid is low.
- There is a malfunction in the brake system.

Canada



### ■ What to do when the indicator comes on while driving

Press the brake pedal lightly to check pedal pressure.

- If normal, check the brake fluid level the next time you stop.
- If abnormal, take immediate action. If necessary, downshift the transmission to slow the vehicle using engine braking.

## If the Electric Power Steering (EPS) System Indicator Comes On



### ■ Reasons for the indicator to come on

- Comes on if there is a problem with the EPS system.
- If you depress the accelerator pedal repeatedly to increase the engine speed while the engine is idling, the indicator comes on, and sometimes the steering wheel becomes harder to operate.

### ■ What to do when the indicator comes on

Stop the vehicle in a safe place and restart the engine.

If the indicator comes on and stays on, immediately have your vehicle inspected by a dealer.

### ▶▶ If the Brake System Indicator (Red) Comes On

Have your vehicle repaired immediately.

It is dangerous to drive with low brake fluid. If there is no resistance from the brake pedal, stop immediately in a safe place. If necessary downshift the gears.

If the brake system indicator and **ABS** indicator come on simultaneously, the electronic brake distribution system is not working. This can result in vehicle instability under sudden braking.

Have your vehicle inspected by a dealer immediately.

## If the Low Tire Pressure/Tire Pressure Monitoring System (TPMS) Indicator Comes On or Blinks



### ■ Reasons for the indicator to come on or blink

A tire pressure is significantly low. If there is a problem with the TPMS with Tire Fill Assist or the compact spare tire\* is installed, the indicator blinks for about one minute, and then stays on.

### ■ What to do when the indicator comes on

Stop your vehicle in a safe place. Check the tire pressure and adjust the pressure to the specified level. The specified tire pressure is on a label on the driver side doorjamb.

### ■ What to do when the indicator blinks

Have the tire inspected by a dealer as soon as possible. If the compact spare tire\* causes the indicator to blink, change the tire to a full-size tire. The indicator goes off after driving for a few miles (kilometers).

## If the Transmission Indicator Blinks along with the Warning Message\*



### ■ Reasons for the indicator to blink

There is a problem with the transmission.

### ■ What to do when the indicator blinks

- Immediately have your vehicle inspected by a dealer.
- Select **[N]** after starting the engine.
  - ▶ Check if the **[N]** position in the instrument panel and the indicator on the **[N]** button light/blink.
  - ▶ The engine cannot be turned on unless the parking brake is set.

▶ **Starting the Engine** P. 471



▶▶ If the Low Tire Pressure/Tire Pressure Monitoring System (TPMS) Indicator Comes On or Blinks

### NOTICE

Driving on an extremely underinflated tire can cause it to overheat. An overheated tire can fail. Always inflate your tires to the prescribed level.

TPMS with Tire Fill Assist provides visual and audible assistance during tire pressure adjustment. With the power mode in ON, while you adjust tire pressure up or down, the system alerts you as follows:

**Below recommended pressure:** The beeper sounds and exterior lights flash once every five seconds.

**At recommended pressure:** The beeper sounds and exterior lights flash rapidly for ~ five seconds.

**Above recommended pressure:** The beeper sounds and lights flash twice every three seconds.

▶▶ If the Transmission Indicator Blinks along with the Warning Message\*

You may not be able to start the engine.

Make sure to set the parking brake when parking your vehicle.

Call a professional towing service if you need to tow your vehicle.

▶ **Emergency Towing** P. 647

\* Not available on all models

## Fuse Locations

If any electrical devices are not working, set the power mode to VEHICLE OFF (LOCK) and check to see if any applicable fuse is blown.

### Engine Compartment Fuse Box Type A

Fuse locations are shown on the fuse box cover. Locate the fuse in question by the fuse number and box cover number. Located near the passenger's side damper house. Push the tabs to open the box.

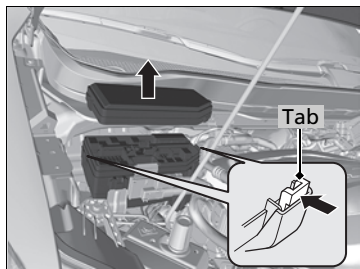

### ■ Circuit protected and fuse rating

	Circuit Protected	Amps
1	–	(70 A)
	RR BLOWER	30 A
	ABS/VSA MTR	40 A
	ABS/VSA FSR	20 A
	MAIN FAN	30 A
	MAIN FUSE	150 A
	SUB FAN	30 A
	WIP MTR	30 A
	WASHER	20 A
	SUNSHADE	(20 A)
2	–	(30 A)
	FR BLOWER	40 A
	AC INVERTER	(30 A)
	AUDIO AMP	(30 A)
	RR DEF	40 A
	–	(30 A)
	–	(20 A)
	–	–
3	–	–
	–	–
	–	–
	–	–
4	PARKING LIGHT	10 A
5	–	–
6	STOP LIGHT	10 A
7	–	–

	Circuit Protected	Amps
8	L H/L LO	10 A
9	–	–
10	R H/L LO	10 A
11	IGPS	7.5 A
12	INJECTOR	(20 A)
13	H/L LO MAIN	20 A
14	USB CHARGER	(15 A)
15	FR FOG	(15 A)
16	HAZARD	15 A
17	AS P/SEAT (REC)	(20 A)
18	AS P/SEAT (SLIDE)	(20 A)
19	ACM	20 A
20	MG CLUTCH	7.5 A
21	MAIN RLY	15 A
22	FI SUB	15 A
23	IG COIL	15 A
24	DBW	15 A
25	SMALL/STOP MAIN	(20 A)
26	BACK UP	10 A
27	HTD STRG WHEEL	(10 A)
28	HORN	10 A
29	RADIO	(20 A)

## ■ Engine Compartment Fuse Box Type B

Fuse locations are shown on the fuse box cover. Locate the fuse in question by the fuse number and box cover number.

Located near the brake fluid reservoir. Push the tabs to open the box.

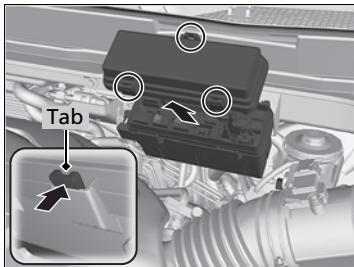

## ■ Circuit protected and fuse rating

	Circuit Protected	Amps
1	ST CUT1	(40 A)
	4WD	(20 A)
	IG MAIN	30 A
	IG MAIN2	30 A
	PTG MTR	(40 A)
	F/B MAIN2	60 A
	F/B MAIN	60 A
	EPS	60 A
2	TRL MAIN	(30 A)
3	TRL E-BRAKE	(20 A)
4	BMS	7.5 A
5	H/L HI MAIN	20 A
6	PTG CLOSER	(20 A)
7	CTR ACC SOCKET	20 A
8	RR ACC SOCKET	(20 A)
9	FR DE-ICE	(15 A)
10	ACC/IG2_MAIN	10 A
11	TRL CHARGE	(20 A)
12	IDLE STOP ST CUT	(30 A)
13	IDLE STOP	(30 A)
14	IDLE STOP	(30 A)
15	TCU/SBW	(15 A)
16	RR HEATED SEAT	(20 A)
17	STRLD	7.5 A

### ■ Interior Fuse Box Type A

Located under the dashboard.

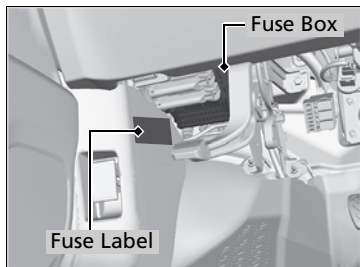

Fuse locations are shown on the label on the outer side of the side panel cover. Locate the fuse in question by the fuse number and label number.

### ■ Circuit protected and fuse rating

	Circuit Protected	Amps
1	DR P/W	20 A
2	DOOR LOCK	20 A
3	SMART	7.5 A
4	AS P/W	20 A
5	FR ACC SOCKET	20 A
6	FUEL PUMP	20 A
7	ACG	15 A
8	FRONT WIPER	7.5 A
9	IG1 SMART* <sup>1</sup>	7.5 A
	ABS/VSA* <sup>2</sup>	7.5 A
10	SRS	10 A
11	REAR LEFT P/W	20 A
12	–	–
13	REAR RIGHT P/W	20 A
14	FUEL LID	20 A
15	DR P/SEAT (REC)	(20 A)
16	REAR FOG	(7.5 A)
17	FR SEAT HEATER	(20 A)
18	INTR LT	7.5 A
19	DR REAR DOOR UNLOCK	10 A
20	AS SIDE DOOR UNLOCK	10 A
21	DRL	7.5 A
22	KEY LOCK	7.5 A
23	A/C	7.5 A
24	IG1a FEED BACK	7.5 A

	Circuit Protected	Amps
25	INST PANEL LIGHTS	7.5 A
26	LUMBAR SUPPORT	(10 A)
27	PARKING LIGHTS	7.5 A
28	OPTION	10 A
29	BACK LT* <sup>1</sup>	7.5 A
	METER* <sup>2</sup>	7.5 A
30	REAR WIPER	10 A
31	ST MOTOR* <sup>1</sup>	7.5 A
	MISS SOL* <sup>2</sup>	7.5 A
32	SRS	7.5 A
33	AS SIDE DOOR LOCK	10 A
34	DR DOOR LOCK	10 A
35	DR DOOR UNLOCK	10 A
36	DR P/SEAT (SLIDE)	(20 A)
37	RIGHT H/L HI	10 A
38	LEFT H/L HI	10 A
39	IG1b FEED BACK	7.5 A
40	ACC	7.5 A
41	DR REAR DOOR LOCK	10 A
42	–	–

\*1: Models with Auto idle-stop system

\*2: Models without Auto idle-stop system

### ■ Interior Fuse Box Type B\*

Located under the dashboard.

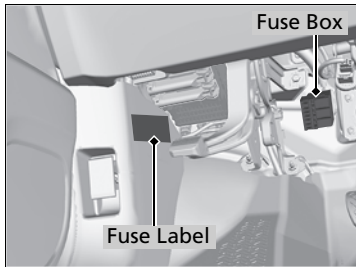

Fuse locations are shown on the image. Locate the fuse in question by the fuse number and label number.

### ■ Circuit protected and fuse rating

	Circuit Protected	Amps
A	METER	7.5 A
B	ABS/VSA	7.5 A
C	ACG	7.5 A
D	MICU	7.5 A
E	AUDIO	20 A
F	BACK UP	10 A
G	ACC	7.5 A

\* Not available on all models

## Inspecting and Changing Fuses

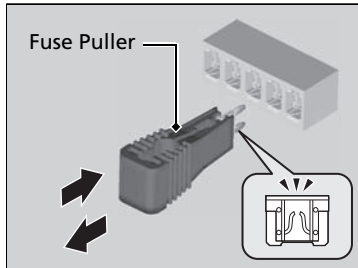
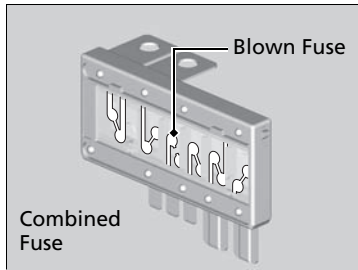

1. Set the power mode to VEHICLE OFF (LOCK). Turn headlights and all accessories off.
2. Remove the fuse box cover.
3. Check the large fuse in the engine compartment.
  - If the fuse is blown, use a Phillips-head screwdriver to remove the screw and replace it with a new one.
4. Inspect the small fuses in the engine compartment and the vehicle interior.
  - If there is a burned out fuse, remove it with the fuse puller and replace it with a new one.

### Inspecting and Changing Fuses

#### NOTICE

Replacing a fuse with one that has a higher rating greatly increases the chances of damaging the electrical system.

Replace fuse with a spare fuse of the same specified amperage  
Confirm the specified amperage using the charts on P. 642 to P. 645.

There is a fuse puller in the engine compartment fuse box.

# Emergency Towing

Call a professional towing service if you need to tow your vehicle.

## All models

### ■ Flat bed equipment

The operator loads your vehicle on the back of a truck.

**This is the best way to transport your vehicle.**

## 2WD models

### ■ Wheel lift equipment

The tow truck uses two pivoting arms that go under the front tires and lift them off the ground. The rear tires remain on the ground. **This is an acceptable way to tow your vehicle.**

## Emergency Towing

### NOTICE

Trying to lift or tow your vehicle by the bumpers will cause serious damage. The bumpers are not designed to support the vehicle's weight.

### NOTICE

Improper towing such as towing behind a motorhome or other motor vehicle can damage the transmission.

Never tow your vehicle with just a rope or chain. It is very dangerous since ropes or chains may shift from side to side or break.



# When You Cannot Unlock the Fuel Fill Door

## What to Do When Unable to Unlock the Fuel Fill Door

If you cannot unlock the fuel fill door, use the following procedure:

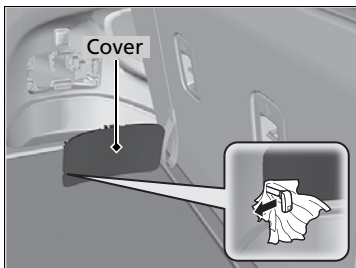

1. Open the tailgate.
2. Wrap a cloth around the built-in key. Put it into the cover slot as shown in the image, and remove the cover.



3. Pull the release lever toward you.
  - ▶ The release lever unlocks the fuel fill door when it is pulled.

## What to Do When Unable to Unlock the Fuel Fill Door

After taking these steps, contact a dealer to have the vehicle checked.

## Refueling From a Portable Fuel Container

If you have run out of fuel and need to refuel your vehicle from a portable fuel container, use the funnel provided with your vehicle.

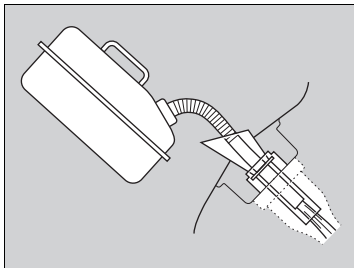
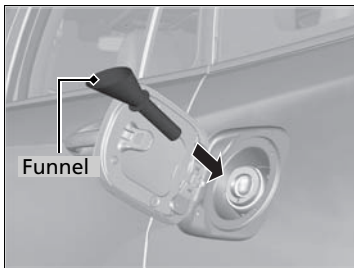
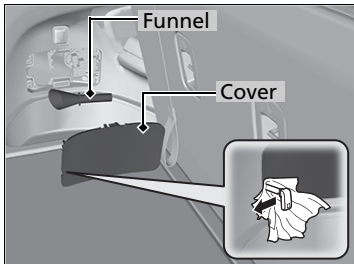

1. Turn off the engine.
2. Press the fuel fill door release button.
  - ▶ The fuel fill door opens.
3. Wrap a cloth around the built-in key. Put it into the cover slot as shown in the image, and remove the cover.
4. Remove the funnel from the cover.
5. Place the end of the funnel on the lower part of filler opening, then insert it slowly and fully.
  - ▶ Make sure that the end of the funnel goes down along with the filler pipe.
6. Fill the tank with fuel from the portable fuel container.
  - ▶ Pour fuel carefully so you do not spill any.
7. Remove the funnel from the filler neck.
  - ▶ Wipe up any fuel from the funnel before storing it.
8. Shut the fuel fill door by hand.

### Refueling From a Portable Fuel Container

#### **WARNING**

Gasoline is highly flammable and explosive. You can be burned or seriously injured when handling fuel.

- Stop the engine, and keep heat, sparks, and flame away.
- Handle fuel only outdoors.
- Wipe up spills immediately.

#### **NOTICE**

Do not insert the nozzle of a portable fuel container or any funnel other than the one provided with your vehicle. Doing so can damage the fuel system. Do not try to pry open or push open the sealed fuel tank with foreign objects. This can damage the fuel system and its seal.

Make sure the fuel in the portable fuel container is gasoline before you refuel.

## What to Do When Unable to Open the Tailgate

If you cannot open the tailgate, use the following procedure:

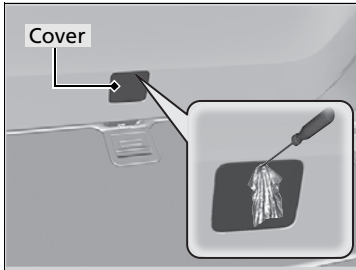

1. Wrap a cloth around the flat-tip screwdriver. Put it into the cover as shown in the image, and remove the cover.

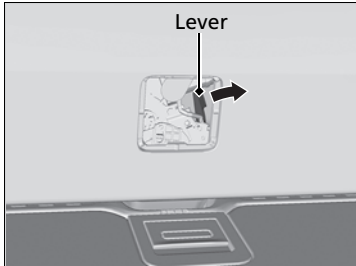

2. To open the tailgate, push the tailgate while sliding the lever to the right.

## What to Do When Unable to Open the Tailgate

What to do—following up

After taking these steps, contact a dealer to have the vehicle checked.

When you open the tailgate from inside, make sure there is enough space around the tailgate, and it does not hit anyone or any object.

# Information

This chapter includes your vehicle's specifications, locations of identification numbers, and other information required by regulation.

<b>Specifications</b> .....	652
<b>Identification Numbers</b>	
Vehicle Identification Number (VIN), Engine Number, and Transmission Number .....	654
<b>Devices that Emit Radio Waves</b> .....	655
<b>Reporting Safety Defects</b> .....	656
<b>Emissions Testing</b>	
Testing of Readiness Codes .....	657
<b>Warranty Coverages</b> .....	659
<b>Authorized Manuals</b> .....	661
<b>Customer Service Information</b> .....	662

## ■ Vehicle Specifications

Model	Honda Pilot	
No. of Passengers:		
Front	2	
Rear	2nd Row	3 (2 <sup>*1</sup> )
	3rd Row	3
Total	8 (7 <sup>*1</sup> )	
<b>Weights:</b>		
Gross Vehicle	5,545 lbs (2,515 kg) <sup>*2</sup>	
Weight Rating	5,842 lbs (2,650 kg) <sup>*3</sup>	
Gross Axle Weight	2,734 lbs (1,240 kg) <sup>*2</sup>	
Rating (Front)	2,855 lbs (1,295kg) <sup>*3</sup>	
Gross Axle Weight	2,921 lbs (1,325 kg) <sup>*2</sup>	
Rating (Rear)	3,097 lbs (1,405 kg) <sup>*3</sup>	
Gross Combined Weight	8,025 lbs (3,640 kg) <sup>*2</sup>	
Rating	9,755 lbs (4,425 kg) <sup>*3</sup>	

\*1: ELITE grade and TRY grade of Canadian models

\*2: 2WD models

\*3: AWD models

## ■ Air Conditioning

Refrigerant Type	HFO-1234yf (R-1234yf)
Charge Quantity	23.8 – 25.6 oz (675 – 725 g)
Lubricant Type	RL85HM (POE)
Quantity	7.5 – 8.72 cu-in (123 – 143 cm <sup>3</sup> )

## ■ Engine Specifications

Displacement	211.8 cu-in (3,471 cm <sup>3</sup> )	
Spark Plugs	NGK	DILZKR7B11G

## ■ Fuel

Type	Unleaded gasoline, Pump octane number of 87 or higher	
Fuel Tank Capacity	19.5 US gal (73.8 L)	

## ■ Washer Fluid

Tank Capacity	U.S.: 4 US qt (3.8 L) Canada: 5.6 US qt (5.3 L)	
---------------	--	--

## ■ Light Bulbs

Headlights (Low Beam)	LED*
	55 W* (H11)
Headlights (High Beam)	60W (HB3)
Fog Lights*	35 W (H8)
Parking lights*	LED
Front Turn Signal/Parking Lights*	28/8 W
Front Side Marker Lights	LED
Daytime Running Lights	60 W*
	LED*
Side Turn Signal Lights (on Door Mirrors)*	LED
Brake Lights	LED
Rear Side Marker Lights	LED
Taillights	LED
Back-Up Lights	21 W
Rear Turn Signal Lights	21 W
High-Mount Brake Light	LED
Rear License Plate Light	LED
<b>Interior Lights</b>	
Map Lights	LED*
	5 W*
Ceiling Lights	5 W
Front and Rear Ambient Lights	LED
Vanity Mirror Lights	1.4 W
Door Courtesy Lights	3.8 W
Door Inner Handle Lights	LED
Door Pocket Lights	LED
Console Compartment Light	1.4 W
Glove Box Light	1.4 W
Cargo Area Lights	8 W

■ Brake Fluid

Specified	Honda Heavy Duty Brake Fluid DOT 3
-----------	------------------------------------

Automatic transmission models with shift lever

■ Automatic Transmission Fluid

Specified	Honda Automatic Transmission ATF DW-1
Capacity	Change 3.3 US qt (3.1 L)

Automatic transmission models with electronic gear selector

■ Automatic Transmission Fluid

Specified	Honda Automatic Transmission Fluid ATF-TYPE 3.1 or higher
Capacity	Change 3.5 US qt (3.3 L)

■ Rear Differential Fluid\*

Specified	Honda DPSF-II
Capacity	Change 1.92 US qt (1.82 L)

■ Transfer Assembly Fluid\*

Specified	-Honda Hypoid Gear Oil HGO-1 -Hypoid gear oil SAE 75W-85 or SAE 90 (API grade GL4 or GL5)
Capacity	Change 0.45 US qt (0.43 L)

■ Engine Oil

Recommended	-Genuine Honda Motor Oil 0W-20 -API Premium-grade 0W-20 detergent oil
Change	5.4 US qt (5.1 L)
Capacity	Change including filter 5.7 US qt (5.4 L)

■ Engine Coolant

Specified	Honda Long Life Antifreeze/Coolant Type 2
Ratio	50/50 with distilled water
Capacity	1.88 US gal (7.13 L)* <sup>1</sup> 1.93 US gal (7.3 L)* <sup>2</sup> (change including the remaining 0.19 US gal (0.72 L) in the reserve tank)

\*1: Automatic transmission models with shift lever

\*2: Automatic transmission models with electronic gear selector

■ Tire

Regular	Size	245/60R18 105H <sup>1</sup> 245/50R20 102H* <sup>2</sup>
	Pressure psi (kPa [kgf/cm <sup>2</sup> ])	32 (220 [2.2]) <sup>1</sup> 35 (240 [2.4]) <sup>2</sup>
Compact Spare	Size	T165/80D17 104M
	Pressure psi (kPa [kgf/cm <sup>2</sup> ])	60 (420 [4.2])
Wheel Size	Regular	18 x 8J <sup>1</sup>
	Compact Spare	20 x 8J <sup>2</sup> 17 x 4T

\*1: Model with 18 inch wheel

\*2: Model with 20 inch wheel

\* Not available on all models

## Vehicle Identification Number (VIN), Engine Number, and Transmission Number

Your vehicle has a 17-digit vehicle identification number (VIN) used to register your vehicle for warranty purposes, and for licensing and insuring your vehicle. The locations of your vehicle's VIN, engine number, and transmission number are shown as follows:

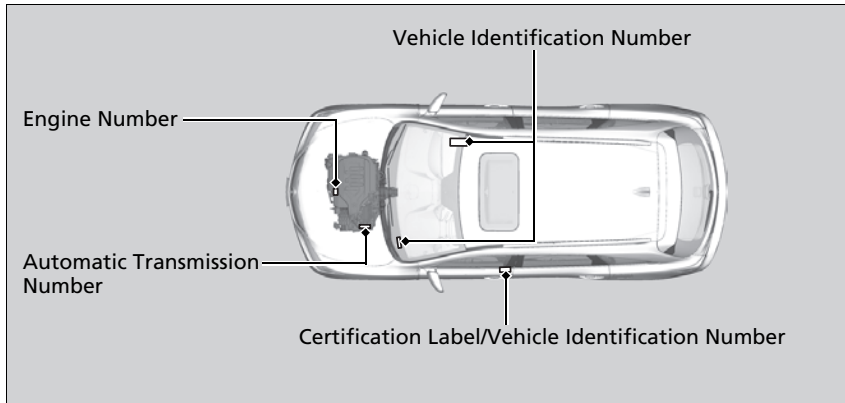

### Vehicle Identification Number (VIN), Engine Number, and Transmission Number

The interior vehicle identification number (VIN) is located under the cover.

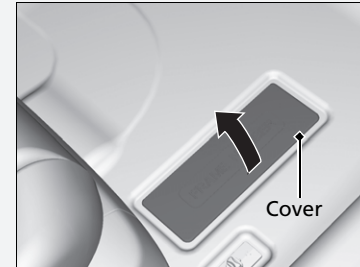

## Devices that Emit Radio Waves

The following products and systems on your vehicle emit radio waves when in operation.

HondaLink

Audio System

Blind spot information System\*

*Bluetooth*® Audio

*Bluetooth*® HandsFreeLink®

HomeLink® Universal Transceiver\*

Collision Mitigation Braking System™\*

Immobilizer System

Remote Transmitter

Smart Entry System\*

Tire Pressure Monitoring System (TPMS)

Remote Engine Start System\*

Each of the above complies with the appropriate requirements or the required standards of FCC (Federal Communications Commission) and Industry Canada Standard, described below:

As required by the FCC:

This device complies with Part 15 of the FCC rules. Operation is subject to the following two conditions: (1) This device may not cause harmful interference, and (2) this device must accept any interference received, including interference that may cause undesired operation.

Changes or modifications not expressly approved by the party responsible for compliance could void the user's authority to operate the equipment.

This device complies with industry Canada licence-exempt RSS standard(s). Operation is subject to the following two conditions: (1) this device may not cause interference, and (2) this device must accept any interference, including interference that may cause undesired operation of the device.

\* Not available on all models



In the U.S.

If you believe that your vehicle has a defect which could cause a crash or could cause injury or death, you should immediately inform the National Highway Traffic Safety Administration (NHTSA) in addition to notifying American Honda Motor Co., Inc.

If NHTSA receives similar complaints, it may open an investigation, and if it finds that a safety defect exists in a group of vehicles, it may order a recall and remedy campaign. However, NHTSA cannot become involved in individual problems between you, your dealer, or American Honda Motor Co., Inc.

To contact NHTSA, you may call the Vehicle Safety Hotline toll-free at 1-888-327-4236 (TTY: 1-800-424-9153); go to <http://www.safercar.gov>; or write to: Administrator, NHTSA, 1200 New Jersey Avenue, SE., Washington, DC 20590. You can also obtain other information about motor vehicle safety from <http://www.safercar.gov>.

In Canada

If you believe that your vehicle has a defect which could cause a crash or could cause injury or death, you should immediately inform Honda Canada Inc. and you may also inform Transport Canada.

If Transport Canada receives similar complaints, it may open an investigation, and if it finds that a safety defect exists in a group of vehicles, it may lead to a recall and remedy campaign. However, Transport Canada cannot become involved in individual problems between you, your dealer, or Honda Canada Inc.

To contact Transport Canada's Defect Investigations and Recalls Division, you may call 1-800-333-0510. For more information on reporting safety defects or about motor vehicle safety, go to <http://www.tc.gc.ca/roadsafety>.

## Testing of Readiness Codes

Your vehicle has readiness code as part of the onboard self diagnostic system. Some States use these codes for testing to verify whether your vehicle's emissions components are working properly. The codes may not be read properly if testing is performed just after the battery has gone dead or been disconnected.

To check if they are set, set the power mode to ON, without starting the engine. The malfunction indicator lamp will come on for several seconds. If it then goes off, the readiness codes are set. If it blinks five times, the readiness codes are not set.

If you are required to have your vehicle tested before the readiness codes are ready, prepare the vehicle for retesting by doing the following:

1. Fill the gas tank to approximately 3/4 full.
2. Park the vehicle and leave the engine off for 6 hours or more.
3. Make sure the ambient temperature is between 40°F and 95°F (4°C and 35°C).
4. Start the engine without touching the accelerator pedal, and let it idle for 20 seconds.
5. Keep the vehicle in **P**. Increase the engine speed to 2,000 rpm, and hold it there for about 3 minutes.
6. Let the engine idle with your foot off the accelerator for 20 seconds.

### Testing of Readiness Codes

The readiness codes are erased when the battery is disconnected, and set again only after several days of driving under a variety of conditions.

If a testing facility determines that the readiness codes are not set, you may be requested to return at a later date to complete the test.

If the testing facility determines the readiness codes are still not set, see a dealer.

7. Select a nearby, lightly traveled major highway where you can maintain a speed of 50 to 60 mph (80 to 97 km/h) for at least 20 minutes. Drive on the highway in **D**. Do not use cruise control. When traffic allows, drive for 90 seconds without moving the accelerator pedal. (Vehicle speed may vary slightly; this is okay.) If you cannot do this for a continuous 90 seconds because of traffic conditions, drive for at least 30 seconds, then repeat it two more times (for a total of 90 seconds).
8. Drive in city or suburban traffic for at least 10 minutes. When traffic conditions allow, let the vehicle coast for several seconds without using the accelerator pedal or the brake pedal.
9. Park the vehicle and leave the engine off for 30 minutes.

## ■ U.S. Owners

Your new vehicle is covered by these warranties:

***New Vehicle Limited Warranty*** – covers your new vehicle, except for the emissions control systems and accessories, against defects in materials and workmanship.

***Emissions Control Systems Defects Warranty and Emissions Performance Warranty*** – these two warranties cover your vehicle's emissions control systems. Time, mileage, and coverage are conditional. Please read your warranty booklet for exact information.

***Seat Belt Limited Warranty*** – a seat belt that fails to function properly is covered by a limited warranty. Please read your warranty booklet for details.

***Rust Perforation Limited Warranty*** – all exterior body panels are covered for rust-through from the inside for the specified time period with no mileage limit.

***Accessory Limited Warranty*** – Honda accessories are covered under this warranty. Time and mileage limits depend on the type of accessory and other factors. Please read your warranty booklet for details.

***Replacement Parts Limited Warranty*** – covers all Honda replacement parts against defects in materials and workmanship.

**Replacement Battery Limited Warranty** – provides prorated coverage for a replacement battery purchased from a dealer.

**Replacement Muffler Lifetime Limited Warranty** – provides coverage for as long as the purchaser of the muffler owns the vehicle.

Restrictions and exclusions apply to all these warranties. Please read the Honda warranty information booklet that came with your vehicle for precise information on warranty coverages. Your vehicle's original tires are covered by their manufacturer. Tire warranty information is in a separate booklet.

#### ■ Canadian Owners

Please refer to the warranty manual that came with your vehicle.

#### ■ EPA Contact Information

An owner may obtain further information concerning emission warranties or report violations of the terms of the emission warranties by contacting:

U.S. Environmental Protection Agency  
Office of Transportation and Air Quality  
Compliance Division, Light-Duty Vehicle Group  
Attn: Warranty Complaints  
2000 Traverwood Drive  
Ann Arbor, MI 48105  
Email: [complianceinfo@epa.gov](mailto:complianceinfo@epa.gov)

## ■ Service Express

For electronic copies of service publications, you can purchase a subscription to Service Express. Visit [www.techinfo.honda.com](http://www.techinfo.honda.com) for pricing and options.

## ■ For U.S. Owners

Manuals be purchased from Helm Incorporated. You can order a manual by phone at (800) 782-4356 (credit card orders only), or online at [www.helminc.com](http://www.helminc.com).

## ■ For Canadian Owners

Please contact a dealer to order any manuals that you may require.

Honda dealership personnel are trained professionals.

They should be able to answer all your questions. If you encounter a problem that your dealership does not solve to your satisfaction, please discuss it with the dealership's service manager or general manager. If you are dissatisfied with the decision made by the dealership's management, contact Honda Customer Services.

## U.S. Owners

American Honda Motor Co., Inc.  
Honda Automobile Customer Services  
Mail Stop 500-2N-7A  
1919 Torrance Blvd.  
Torrance, CA 90501-2746  
Tel: 1 (800) 999-1009

## Canadian Owners

Canadian Owners:  
Honda Canada Inc.  
Customer Relations  
180 Honda Boulevard  
Markham, ON  
L6C 0H9  
Tel: 1-888-9-HONDA-9  
Fax: 1-877-939-0909  
E-mail: Honda\_cr@ch.honda.com

## In Puerto Rico and the U.S. Virgin Islands

Bella International  
P.O. Box 190816  
San Juan, PR 00919-0816  
Tel: 1 (787) 620-7546

## Customer Service Information

When you call or write, please give us the following information:

- Vehicle Identification Number
  - **Vehicle Identification Number (VIN), Engine Number, and Transmission Number** P. 654
- Date of purchase
- Odometer reading of your vehicle
- Your name, address, and telephone number
- A detailed description of the problem
- Name of the dealer who sold the vehicle to you

## A

- ABS (Anti-lock Brake System) ..... 541
- AC Power Outlet ..... 197
- Accessories and Modifications ..... 618
- Accessory Power Sockets ..... 196
- Adaptive Cruise Control (ACC) ..... 502
  - Indicator ..... 92
- Adaptive Cruise Control (ACC) with Low Speed Follow (LSF)
  - Indicator ..... 92
- Additives
  - Coolant ..... 583
  - Engine Oil ..... 578
  - Washer ..... 586
- Additives, Engine Oil ..... 578
- Adjusting
  - Armrest ..... 186
  - Front Seats ..... 174
  - Head Restraints ..... 179, 180, 181
  - Mirrors ..... 172
  - Rear Seats ..... 183
  - Second Row Seat ..... 176
  - Steering Wheel ..... 171
  - Temperature ..... 116
- Agile Handling Assist System ..... 529
- Air Conditioning System (Climate Control System) ..... 210
  - Changing the Mode ..... 211
  - Defrosting the Windshield and Windows ..... 211
  - Dust and Pollen Filter ..... 612
  - Recirculation/Fresh Air Mode ..... 211
  - Sensor ..... 216
  - Synchronized Mode ..... 213
  - Using Automatic Climate Control ..... 210
- Air Conditioning System (Heating and Cooling System) ..... 205
  - Cooling ..... 207
  - Defrosting the Windshield and Windows ..... 208
  - Heating ..... 206
- Air Pressure ..... 598, 653
- Airbags ..... 45
  - Advanced Airbags ..... 51
  - After a Collision ..... 49
  - Airbag Care ..... 57
  - Event Data Recorder ..... 0
  - Front Airbags (SRS) ..... 48
  - Indicator ..... 55, 83
  - Passenger Airbag Off Indicator ..... 56
  - Sensors ..... 45
  - Side Airbags ..... 52
  - Side Curtain Airbags ..... 54
- All-wheel drive (AWD) Indicator ..... 89
- AM/FM Radio ..... 231, 267
- Android Auto™ ..... 306
- Anti-lock Brake System (ABS) ..... 541
  - Indicator ..... 83
- Apple CarPlay™ ..... 303
- Armrest ..... 186
- Audio Remote Controls ..... 222
- Audio System ..... 218, 224, 242
- Adjusting the Sound ..... 229, 260
- AM/FM Radio ..... 231, 267
- Android Auto™ ..... 306
- Apple CarPlay™ ..... 303
- Audio/Information Screen ..... 225, 243
- Auxiliary Input Jack ..... 220
- Changing the Home Screen Icon Layout .. 247
- Closing Apps ..... 257
- Display Setup ..... 230, 261
- Error Messages ..... 310
- General Information ..... 314
- Home Screen ..... 250
- HondaLink® ..... 295
- How to use Siri® Eyes Free ..... 302
- iPod ..... 233, 281
- Limitations for Manual Operation ..... 262
- MP3/WMA/AAC ..... 236, 278, 290
- Pandora® ..... 288
- Playing a CD ..... 278
- Playing Bluetooth® Audio ..... 239, 293
- Playing SiriusXM® Radio ..... 271
- Reactivating ..... 221
- Recommended CDs ..... 315
- Remote Controls ..... 222
- Security Code ..... 221
- Selecting an Audio Source ..... 262
- Song By Voice™ (SBV) ..... 284
- Status Area ..... 256
- Theft Protection ..... 221
- Updating Apps ..... 258
- USB Flash Drives ..... 236, 290, 317



USB Port.....	219
Voice Operation.....	263
Wallpaper Setup.....	227, 248
Wi-Fi Connection.....	300
<b>Audio/Information Screen</b> .....	225, 243
<b>Authorized Manuals</b> .....	661
<b>Auto Door Locking/Unlocking</b> .....	134
Customize.....	376
<b>Auto High-Beam System</b> .....	160
<b>Auto high-beam system Indicator</b> .....	87
<b>Auto Idle-stop</b> .....	489
OFF Button.....	490
<b>Auto Idle-stop Indicator (Green)</b> .....	90
<b>Auto Idle-stop System Indicator (Amber)</b> ..	90
<b>Automatic Intermittent Wipers</b> .....	165
<b>Automatic Lighting</b> .....	157
<b>Automatic Transmission</b> .....	478
Creeping.....	478
Fluid.....	585
Kickdown.....	478
Operating the Shift Button.....	483
Shift Lever Does Not Move.....	632
Shift Lever Operation.....	480
Shifting.....	479, 481
<b>Auxiliary Input Jack</b> .....	220
<b>Average Fuel Economy</b> .....	116

## B

<b>Back-Up Light</b> .....	592
<b>Battery</b> .....	606
Charging System Indicator.....	79, 638
Jump Starting.....	633
Maintenance (Checking the Battery).....	606
<b>Belts (Seat)</b> .....	37
<b>Beverage Holders</b> .....	194
<b>Blind spot information (BSI) System</b> .....	530
Indicator.....	94
<b>Bluetooth® Audio</b> .....	239, 293
<b>Bluetooth® HandsFreeLink®</b> .....	390, 415
<b>Blu-ray/DVD Rear Entertainment System</b> .....	322
Audio Sources for Front and Rear Seats...	343
Auxiliary Console Panel.....	323
DVD or Blu-ray™ Player Error Messages...	350
Front Control Panel Operation.....	336
HDMI™ Port.....	324
Initial Settings.....	334
Operating the Blu-ray/DVD rear entertainment system.....	336
Operating the System.....	325
Overhead Screen.....	325
Playable Disc Region Codes.....	348
Playable Disc Types.....	348
Playable Discs.....	344
Playing a Disc in the Rear.....	342
Playing a DVD/Blu-ray™.....	326
Playing AM/FM Radio in the Rear.....	341

Playing an iPod and a USB Flash Drive in the Rear.....	342
Playing Audio.....	340
Playing SiriusXM® Radio in the Rear.....	341
Rear DVD or Blu-ray™ Menu.....	327
Rear System Setup.....	337
Recommended Discs.....	349
Screen and Surround Settings.....	330
Selecting the Audio Source using Front Control Panel.....	336
Setting the DVD or Blu-ray™ Menu.....	338
System Controls.....	326, 340
USB Ports.....	324
Wireless Headphones.....	322
<b>Booster Seats (For Children)</b> .....	73
<b>Brake System</b> .....	539
Anti-lock Brake System (ABS).....	541
Brake Assist System.....	542
Brake System Indicator.....	78
Fluid.....	586
Foot Brake.....	540
Indicator.....	78, 640
Parking Brake.....	539
<b>Brake System (Amber)</b> .....	78
Indicator.....	78
<b>Brake System (Red)</b> .....	78, 640
Indicator.....	78, 640
<b>Brightness Control (Instrument Panel)</b> ...	167
<b>Bulb Replacement</b> .....	587
Back-Up Light.....	592
Brake Light and Turn Signal Light.....	591

Daytime Running Light.....	589	Cleaning the Interior.....	613	Indicator.....	88
Headlights .....	587	Client Service Information .....	662	Cup Holders.....	194
High-Mount Brake Light.....	592	Climate Control System.....	210	Customized Features.....	351
Rear License Plate Light.....	592	Changing the Mode .....	210		
Side Turn Signal/Emergency Indicator Light .....	590	Defrosting the Windshield and Windows .....	211	<b>D</b>	
Taillight and Rear Side Marker Light.....	591	Dust and Pollen Filter.....	612	Daytime Running Lights .....	163
<b>Bulb Specifications.....</b>	<b>652</b>	Recirculation and Fresh Air Mode .....	211	Dead Battery.....	633
		Sensors.....	216	Defaulting All the Settings.....	386
		Synchronized Mode.....	213	Defrosting the Windshield and Windows .....	208, 211
		Using Automatic Climate Control .....	210	Detachable Anchor .....	42
<b>C</b>		Clock.....	120	Devices that Emit Radio Waves .....	655
Car Wash Mode.....	485	Coat Hook.....	198	Dimming	
Carbon Monoxide Gas .....	74	Collision Mitigation Braking System™ (CMBS™).....	543	Headlights.....	156
Carrying Cargo .....	453, 455	Collision Mitigation Braking System™ (CMBS™).....	95, 96	Rearview Mirror.....	172
CD Player .....	278	Indicator.....	621, 653	Dipstick (Engine Oil).....	579
Certification Label .....	654	Compact Spare Tire .....	448	Directional Signals (Turn Signal) .....	155
Changing Bulbs.....	587	Compass .....	191	Display Button.....	243
Charging System Indicator .....	79, 638	Console Compartment .....	119	Door Mirrors.....	173
Child Safety .....	58	Controls.....	583	Doors.....	121
Childproof Door Locks .....	133	Coolant (Engine).....	584	Auto Door Locking.....	134
Child Seat .....	58	Adding to the Radiator .....	583	Auto Door Unlocking .....	134
Booster Seats.....	73	Adding to the Reserve Tank.....	636	Door Open Message.....	36
Child Seat for Infants .....	60	Overheating .....	478	Keys.....	121
Child Seat for Small Children .....	61	Creeping (Automatic Transmission) .....	557	Locking/Unlocking the Doors from the Inside .....	15, 131
Installing a Child Seat with a Lap/Shoulder Seat Belt .....	67	Cross Traffic Monitor.....	497	Locking/Unlocking the Doors from the Outside .....	124
Larger Children.....	72	Cruise Control .....	88	Lockout Prevention System.....	130
Rear-facing Child Seat.....	60	CRUISE CONTROL Indicator .....	88	DOT Tire Quality Grading.....	600
Selecting a Child Seat .....	62	CRUISE MAIN Indicator.....	88		
Childproof Door Locks.....	133				
Cleaning the Exterior.....	615				

Driving.....	451
Adaptive Cruise Control (ACC) .....	502
Automatic Transmission.....	478
Braking.....	539
Cruise Control.....	497
Off-Highway Driving Guidelines.....	469
Shifting Gear.....	481
Starting the Engine.....	471
Driving Position Memory System.....	169
Dust and Pollen Filter.....	612

## E

ECON Button.....	494
ECON Mode Indicator.....	94
Electric Power Steering (EPS) System	
Indicator.....	86, 640
Electronic Stability Control (ESC).....	527
Emergency.....	647
Emissions Testing (Readiness Codes).....	657
Engine.....	654
Coolant.....	583
Jump Starting.....	633
Oil.....	578
Remote Engine Start.....	473
Starting.....	471
Engine Compartment Cover.....	577
Engine Coolant.....	583
Adding to the Radiator.....	584
Adding to the Reserve Tank.....	583
Overheating.....	636

Temperature Gauge.....	113
Engine Oil.....	578
Adding.....	580
Checking.....	579
Displaying Oil Life.....	571
Engine Oil Life.....	117
Low Oil Pressure Indicator.....	79, 638
Recommended Engine Oil.....	578
ENGINE START/STOP Button.....	152
EPS (Electric Power Steering)	
System.....	86, 640
Exhaust Gas Hazard (Carbon Monoxide).....	74
Exterior Care (Cleaning).....	615
Exterior Mirrors.....	173

## F

Features.....	217
Filters.....	
Dust and Pollen.....	612
Oil.....	581
Flat Tire.....	621
Floor Mats.....	614
Fluids.....	
Automatic Transmission.....	585
Brake.....	586
Engine Coolant.....	583
Windshield Washer.....	586
FM/AM Radio.....	231, 267
Fog Lights.....	159
Indicator.....	87

Folding Down the Second Row Seat.....	184
Folding Down the Third Row Seat.....	185
Foot Brake.....	540
Front Airbags (SRS).....	48
Front Seats.....	174
Adjusting.....	174
Front Sensor Camera.....	500
Fuel.....	24, 562
Economy.....	565
Gauge.....	113
Instant Fuel Economy.....	117
Low Fuel Indicator.....	82
Range.....	117
Recommendation.....	562
Refueling.....	562
Fuel Economy.....	565
Fuel Fill Cap.....	24, 564
Fuel Fill Door.....	24, 563
Unable to Unlock.....	648
Fuses.....	642
Inspecting and Changing.....	646
Locations.....	642, 643, 644, 645

## G

Gasoline (Fuel).....	
Economy.....	565
Gauge.....	113
Information.....	562
Low Fuel Indicator.....	82
Refueling.....	562

Gauges.....	113
Gear Position Indicator.....	80, 483
Gear Shift Positions	
Automatic Transmission.....	481
Glass (care).....	616
Glove Box.....	191

## H

Handling the Unexpected.....	619
HandsFreeLink® (HFL).....	390, 415
Automatic Import of Cellular Phonebook and Call History.....	404, 428
Caller's ID Information.....	402
Displaying Messages.....	442
HFL Buttons.....	390, 415
HFL Menus.....	392, 418
HFL Status Display.....	391, 417
In Case of Emergency.....	446
Limitations for Manual Operation....	391, 417
Making a Call.....	409, 436
Options During a Call.....	414, 439
Phone Setup.....	396, 423
Phonebook Phonetic Modification.....	432
Receiving a Call.....	413, 439
Receiving a Text Message/E-mail.....	440
Ring Tone.....	402, 427
Selecting a Mail Account.....	441
Speed Dial.....	405, 429
To Clear the System.....	403

To Set Up a Text Message/E-mail Options.....	426
Hazard Warning Button.....	4
Hazard Warning Indicator.....	86
HD Radio™.....	267
HDMI™ Port.....	324
Head Restraints.....	179, 180, 181
Headlights.....	156
Auto High-Beam System.....	160
Automatic Operation.....	157
Dimming.....	156, 163
Operating.....	156
Heated Door Mirrors.....	168
Heated Steering Wheel.....	200
Heated Windshield Button.....	168
Heater (Steering Wheel).....	200
Heaters (Seat).....	201, 202, 203
Heating and Cooling System.....	205
Cooling.....	207
Defrosting the Windshield and Windows.....	208
Heating.....	206
HFL (HandsFreeLink®).....	390, 415
High Beam Indicator.....	86
Hill Start Assist System.....	476
HomeLink® Universal Transceiver.....	387
Honda Sensing™.....	25
HondaLink®.....	295

## I

Identification Numbers.....	654
Engine and Transmission.....	654
Vehicle Identification.....	654
Illumination Control.....	167
Button.....	167
Immobilizer System.....	143
Indicator.....	87
Indicators.....	78
Adaptive Cruise Control (ACC).....	92
All-wheel drive (AWD).....	89
Anti-lock Brake System (ABS).....	83
Auto high-beam system.....	87
Auto Idle-stop.....	90
Auto Idle-stop System.....	90
Blind spot information (BSI).....	94, 531
Brake System (Amber).....	78
Brake System (Red).....	78, 640
Charging System.....	79, 638
Collision Mitigation Braking System™ (CMBS™).....	95, 96
CRUISE CONTROL.....	88, 498
CRUISE MAIN.....	88, 497
ECON Mode.....	94
Electric Power Steering (EPS) System..	86, 640
Fog Lights.....	87
Gear Position.....	80
Hazard Warning.....	86
High Beam.....	86
Immobilizer System.....	87
Lane Keeping Assist System (LKAS)....	93, 521

- Lights On..... 87
  - Low Fuel..... 82
  - Low Oil Pressure ..... 79, 638
  - Low Tire Pressure/TPMS ..... 86, 641
  - M (sequential mode) Indicator/Sequential Mode Gear Selection ..... 80
  - Malfunction Indicator Lamp ..... 79, 639
  - Parking Brake and Brake System ..... 78, 640
  - Road Departure Mitigation (RDM)..... 91
  - Seat Belt Reminder ..... 38, 82
  - Security System Alarm ..... 88
  - Supplemental Restraint System ..... 55, 83
  - System Message ..... 88
  - Transmission..... 80
  - Turn Signal ..... 86
  - Vehicle Stability Assist (VSA®) OFF..... 85, 528
  - Vehicle Stability Assist (VSA®) System..... 84, 527
  - Information..... 651
  - Information Button ..... 114
  - Instant Fuel Economy ..... 117
  - Instrument Panel ..... 77
    - Brightness Control..... 167
  - Intelligent Traction Management System..... 495
  - Intelligent VTM4 (i-VTM4) ..... 534
  - Interior Lights ..... 188
  - Interior Rearview Mirror ..... 172
  - iPhone ..... 317
  - iPod..... 233, 281, 317
- J**
- Jack (Wheel Nut Wrench) ..... 625
  - Jump Starting ..... 633
- K**
- Key Number Tag..... 122
  - Keyless Lockout Prevention ..... 130
  - Keys ..... 121
    - Lockout Prevention..... 130
    - Number Tag ..... 122
    - Rear Door Won't Open..... 133
    - Remote Transmitter..... 129
    - Types and Functions ..... 121
  - Kickdown (Automatic Transmission)..... 478
- L**
- Lane Keeping Assist System (LKAS) ..... 519
    - Indicator..... 93
  - LaneWatch™..... 532
  - Language (HFL) ..... 391, 417
  - LATCH (Child Seats)..... 63, 69
  - Lights..... 156, 587
    - Automatic..... 157
    - Bulb Replacement ..... 587
    - Daytime Running Lights..... 163
    - High Beam Indicator..... 86
    - Interior..... 188
    - Light Switches ..... 156
    - Lights On Indicator ..... 87
    - Turn Signals..... 155
  - Load Limits ..... 455
  - Locking/Unlocking ..... 121
    - Auto Door Locking/Unlocking ..... 134
    - Childproof Door Locks ..... 133
    - From Inside ..... 131
    - From Outside ..... 124
    - Keys..... 121
    - Using a Key..... 130
  - Lockout Prevention System ..... 130
  - Low Battery Charge ..... 638
  - Low Fuel Indicator ..... 82
  - Low Oil Pressure Indicator..... 79, 638
  - Low Tire Pressure Indicator ..... 86
  - Lower Anchors ..... 63, 69
  - Lubricant Specifications Chart ..... 653
  - Luggage (Maximum Load Limit)..... 455
  - Lumbar Support ..... 174
- M**
- M (sequential mode) Indicator/Sequential Mode Gear Selection Indicator ..... 80
  - Maintenance ..... 567
    - Battery..... 606
    - Brake Fluid..... 586
    - Cleaning ..... 613
    - Coolant ..... 583
    - Maintenance Minder™..... 571
    - Oil ..... 579
    - Precautions ..... 568

Radiator.....	584
Remote Control .....	609
Remote Transmitter .....	608
Replacing Light Bulbs .....	587
Safety .....	569
Service Items.....	573
Tires.....	597
Transmission Fluid.....	585
Under the Hood.....	575
Wireless Headphone .....	610
<b>Malfunction Indicator Lamp .....</b>	<b>79, 639</b>
<b>Map Lights.....</b>	<b>189</b>
<b>Maximum Load Limit.....</b>	<b>455</b>
<b>Meters, Gauges .....</b>	<b>113</b>
<b>MID (Multi-information Display) .....</b>	<b>114</b>
<b>Mirrors .....</b>	<b>172</b>
Adjusting.....	172
Door.....	173
Exterior.....	173
Interior Rearview.....	172
<b>Modifications (and Accessories).....</b>	<b>618</b>
<b>Moonroof.....</b>	<b>148</b>
<b>MP3.....</b>	<b>236, 278, 290</b>
<b>MP3/WMA/AAC.....</b>	<b>236, 278, 290</b>
<b>Multi-Information Display (MID) .....</b>	<b>114</b>
<b>Multi-View Rear Camera .....</b>	<b>561</b>

## N

<b>Numbers (Identification) .....</b>	<b>654</b>
---------------------------------------	------------

## O

<b>Odometer.....</b>	<b>115</b>
<b>Off-Highway Driving Guidelines .....</b>	<b>469</b>
<b>Oil (Engine).....</b>	<b>578</b>
Adding .....	580
Checking.....	579
Displaying Oil Life .....	571
Low Oil Pressure Indicator.....	79, 638
Recommended Engine Oil.....	578
Viscosity .....	578
<b>Open Source Licences .....</b>	<b>320</b>
<b>Opening/Closing .....</b>	<b>576</b>
Hood.....	148
Moonroof.....	148
Power Windows .....	146
Tailgate .....	135
<b>Operating the Switches Around the Steering Wheel .....</b>	<b>152</b>
<b>Outside Temperature Display .....</b>	<b>116</b>
<b>Overheating.....</b>	<b>636</b>

## P

<b>Paddle Shifters (Sequential Mode).....</b>	<b>488</b>
<b>Pandora® .....</b>	<b>288</b>
<b>Panic Mode .....</b>	<b>145</b>
<b>Panoramic Roof .....</b>	<b>149</b>
<b>Parking.....</b>	<b>552</b>
<b>Parking Brake .....</b>	<b>539</b>
<b>Parking Brake and Brake System Indicator.....</b>	<b>78, 640</b>

<b>Parking Sensor System.....</b>	<b>553</b>
<b>Passenger Airbag Off Indicator .....</b>	<b>56</b>
<b>Passing Indicators.....</b>	<b>156</b>
<b>Playing Bluetooth® Audio.....</b>	<b>239, 293</b>
<b>Power Tailgate .....</b>	<b>138</b>
<b>Power Windows .....</b>	<b>146</b>
<b>Precautions While Driving .....</b>	<b>477</b>
Driving Guidelines for Your Utility Vehicle.....	477
Rain .....	477
<b>Pregnant Women .....</b>	<b>43</b>
<b>Puncture (Tire).....</b>	<b>621</b>

## R

<b>Radiator .....</b>	<b>584</b>
<b>Radio (FM/AM) .....</b>	<b>231, 267</b>
<b>Radio (SiriusXM®) .....</b>	<b>271</b>
<b>Radio Data System (RDS) .....</b>	<b>232, 269</b>
<b>Range.....</b>	<b>117</b>
<b>RDS (Radio Data System) .....</b>	<b>232, 269</b>
<b>Readiness Codes (Emissions Testing).....</b>	<b>657</b>
<b>Rear Climate Control System .....</b>	<b>215</b>
From the Rear Panel.....	215
<b>Rear Defogger/Heated Door Mirror .....</b>	<b>168</b>
Button .....	168
<b>Rear Entertainment System.....</b>	<b>322</b>
<b>Rear Seats .....</b>	<b>183</b>
Second Row Seat .....	183, 184
Third Row Seat.....	185
<b>Rearview Mirror .....</b>	<b>172</b>

Refueling.....	562	Checking.....	44	Sequential Mode Operation .....	488
Fuel Gauge.....	113	Detachable Anchor.....	42	Setting the Clock.....	120
Gasoline.....	562, 652	Fastening .....	40	Shift Button.....	21, 481
Low Fuel Indicator .....	82	Installing a Child Seat with a Lap/Shoulder Seat Belt.....	67	Shift Lever .....	23
Regulations.....	537, 600, 655	Pregnant Women.....	43	Does Not Move.....	632
Remote Engine Start .....	473	Reminder .....	38	Releasing.....	632
Remote Transmitter.....	129	Warning Indicator .....	38, 82	Shifting (Transmission) .....	21, 23, 479, 481
Replacement		Seat Heaters.....	201, 202, 203	Shoulder Anchor .....	41
Battery.....	608, 609, 610	Seat Ventilation.....	202	Side Airbags .....	52
Bulbs .....	587	Seats.....	174	Side Curtain Airbags.....	54
Front Wiper Blade Rubber.....	593	Adjusting .....	174	Siri® Eyes Free .....	302
Fuses.....	642, 643, 644, 645	Driver's Seat Lumbar Support .....	174	SiriusXM® Radio .....	271
Rear Wiper Blade Rubber.....	595	Front Seats.....	174	Smart Entry System Indicator .....	89
Tires .....	603	Rear Seats.....	183	Snow Tires.....	605
Reporting Safety Defects .....	656	Seat Heaters.....	201, 202, 203	Song By Voice™ (SBV).....	284
RESET Button .....	114	Seat Ventilation.....	202	Spare Tire .....	621, 653
Resetting a Trip Meter .....	116	Second Row Seat .....	183, 184	Spark Plugs.....	652
Reverse Tilt Door Mirror.....	173	Third Row Seat.....	185	Specifications .....	652
Road Departure Mitigation (RDM).....	514	Second Row Outer Seats Heaters.....	203	Specified Fuel.....	562, 652
Indicator.....	91	Second Row Seat (Folding Down).....	184	Speedometer.....	113
On and Off.....	516	Security System.....	143	SRS Airbags (Airbags) .....	48
		Immobilizer System Indicator.....	87	Starting Assist Brake Function .....	493
		Security System Alarm Indicator.....	88	Starting the Engine.....	471
<b>S</b>		Select Button .....	21, 481	Does Not Start .....	629
Safe Driving.....	31	Operation.....	21, 483	Jump Starting .....	633
Safety Check.....	36	Select Lever.....	21, 23	Remote Engine Start .....	473
Safety Labels .....	75	Operation.....	21, 23	Steering Wheel .....	171
Safety Message .....	1	Selecting a Child Seat.....	62	Adjusting.....	171
Seat Belts.....	37	Selector Knob (Audio).....	224	Heater .....	200
Adjusting the Shoulder Anchor.....	41	Sequential Mode .....	487	Stopping.....	552
Automatic Seat Belt Tensioners.....	39			Summer Tires.....	605

Sunglasses Holder .....	199
Supplemental Restraint System (SRS) .....	48
Indicator .....	83
Switches (Around the Steering Wheel) .....	4, 5, 152
SYNC Mode .....	213
System Message Indicator .....	88

## T

Tachometer .....	113
Tailgate .....	135
Unable to Open .....	650
Temperature	
Gauge .....	113
Outside Temperature Display .....	116
Temperature Gauge .....	113
Temperature Sensor .....	116, 216
Third Row Seat (Folding Down) .....	185
Third Row Seat Access .....	183
Tie-down Anchors .....	198
Time (Setting) .....	120
Tire Fill Assist .....	641
Tires .....	597
Air Pressure .....	598, 653
Checking and Maintaining .....	597
Inspection .....	597
Labeling .....	598
Puncture (Flat Tire) .....	621
Regulations .....	600
Rotation .....	604

Spare Tire .....	621, 653
Summer .....	605
Tire Chains .....	605
Wear Indicators .....	602
Winter .....	605
Tools .....	620
Towing a Trailer .....	458
Equipment and Accessories .....	462
Load Limits .....	458
Towing Your Vehicle .....	468
Emergency .....	647
TPMS with Tire Fill Assist .....	535
Indicator .....	86, 641
Tire Fill Assist .....	641
Trailer Stability Assist .....	466
Transmission .....	21, 23, 479, 481
Automatic .....	21, 23, 479, 481
Fluid .....	585
Gear Position Indicator .....	80, 483
Number .....	654
Operating the Shift Lever .....	23
Sequential Mode .....	487
Transmission Indicator .....	80
Trip Meter .....	116
Troubleshooting .....	619
Blown Fuse .....	642, 643, 644, 645
Brake Pedal Vibrates .....	28
Buzzer Sounds When Opening Door .....	29
Emergency Towing .....	647
Engine Won't Start .....	629
Noise When Braking .....	30

Overheating .....	636
Puncture/Flat Tire .....	621
Rear Door Won't Open .....	29, 133
Shift Lever Does Not Move .....	632
Warning Indicators .....	78
Turn Signals .....	155
Indicators (Instrument Panel) .....	86
Turn-by-Turn Directions .....	117

## U

Under-floor Storage Area .....	192
Unlocking the Doors .....	124
Unlocking the Front Doors from the Inside .....	15, 131
USB Flash Drives .....	236, 290, 317
USB Port .....	219, 324

## V

Vanity Mirrors .....	7
Vehicle Identification Number .....	654
Vehicle Stability Assist (VSA®) .....	527
Off Button .....	528
System Indicator .....	84, 527
Ventilation .....	211
Ventilation .....	205
Viscosity (Oil) .....	578, 653
Voice Control Operation .....	263
Audio Commands .....	265
Climate Control Commands .....	266



General Commands.....	266
Music Search Commands.....	266
On Screen Commands.....	266
Phone Commands.....	265
Useful Commands.....	265
Voice Portal Screen.....	264
Voice Recognition.....	263

## W

Wallpaper.....	227, 248
Warning and Information Messages.....	97
Warning Indicator On/Blinking.....	638
Warning Labels.....	75
Warranties (Warranty Manual provided separately).....	659
Watts.....	652
Wear Indicators (Tire).....	602
Wheel Nut Wrench (Jack Handle).....	625
Wi-Fi Connection.....	300
Window Washers.....	164
Adding/Refilling Fluid.....	586
Switch.....	164
Windows (Opening and Closing).....	146
Windshield.....	164
Cleaning.....	616
Defrosting.....	208
Defrosting/Defogging.....	211
Washer Fluid.....	586
Wiper Blades.....	593
Wipers and Washers.....	164

<b>Winter Tires</b> .....	605
Snow Tires.....	605
Tire Chains.....	605
<b>Wipers and Washers</b> .....	164
Automatic Intermittent Wipers.....	165
Checking and Replacing Wiper Blades.....	593
Front.....	164
Rear.....	166
<b>WMA</b> .....	236, 278, 290
<b>Worn Tires</b> .....	597