

FORD **EXPLORER** Owner's Manual

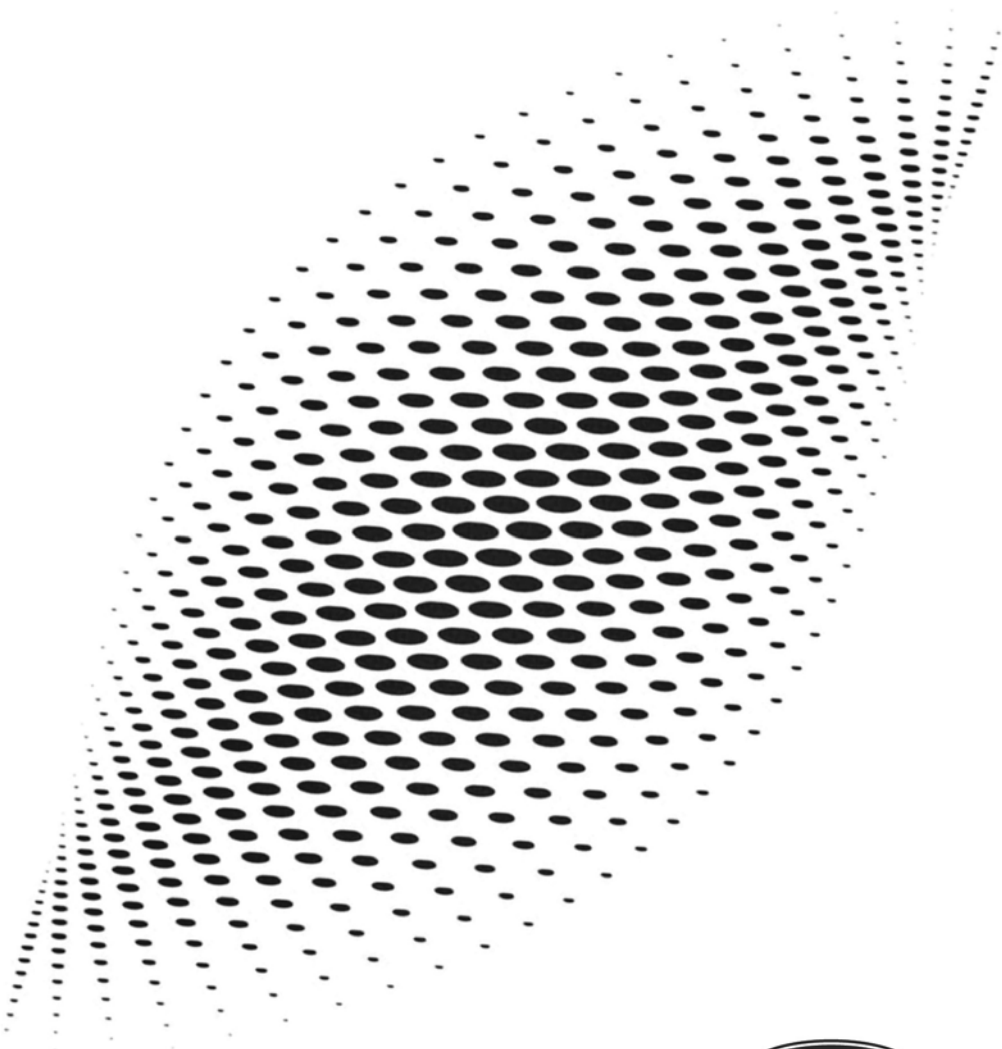

The information contained in this publication was correct at the time of release. In the interest of continuous development, we reserve the right to change specifications, design or equipment at any time without notice or obligation. No part of this publication may be reproduced, transmitted, stored in a retrieval system or translated into any language in any form by any means without our written permission. Errors and omissions excepted.

© Ford Motor Company 2025

All rights reserved.

Part Number: -202507-20250730190404

California Proposition 65



WARNING: Operating, servicing and maintaining a passenger vehicle or off-highway motor vehicle can expose you to chemicals including engine exhaust, carbon monoxide, phthalates, and lead, which are known to the State of California to cause cancer and birth defects or other reproductive harm. To minimize exposure, avoid breathing exhaust, do not idle the engine except as necessary, service your vehicle in a well-ventilated area and wear gloves or wash your hands frequently when servicing your vehicle. For more information go to www.P65Warnings.ca.gov/passenger-vehicle.



WARNING: Battery posts, terminals and related accessories contain lead and lead compounds, chemicals known to the State of California to cause cancer and reproductive harm.
Wash your hands after handling.

Table of Contents

Contacting Us

Contacting Us	15
---------------------	----

Introduction

About This Publication	17
Using This Publication	19

Symbols Glossary

Symbols Used on Your Vehicle	20
Symbols Used On Your Instrument Cluster	22

Data Privacy

Data Privacy	25
Service Data	26
Event Data	26
Settings Data	27
Connected Vehicle Data	27
Mobile Device Data	28
Emergency Call System Data	28

Environment

Protecting the Environment	30
----------------------------------	----

Visual Search

Interior Overview	31
Exterior Overview	32

Child Safety

Child Safety Precautions	34
Child Restraint Anchor Points	35
Child Restraints	36
Installing Child Restraints	38
Booster Seats	43
Child Safety Locks	45

Seatbelts

Seatbelt Precautions	47
Fastening and Unfastening the Seatbelts	48

Sensitive Locking Mode	49
Automatic Locking Mode	49
Adjusting the Seatbelts During Pregnancy	50
Adjusting the Seatbelt Height	50
Seatbelt Reminder	50
Checking the Seatbelts	52
Seatbelt Extensions	52

Personal Safety System™

What Is the Personal Safety System	54
How Does the Personal Safety System Work	54
Personal Safety System Components	54

Airbags

How Do the Front Airbags Work	55
How Do the Side Airbags Work	55
How Do the Knee Airbags Work - Excluding: Police	56
How Do the Knee Airbags Work - Police	56
How Does the Safety Canopy™ Work	57
Airbag Precautions	58
Properly Adjusting the Driver and Front Passenger Seats	58
Children and Airbags	59
Front Passenger Sensing System	59
Crash Sensors and Airbag Indicator - Excluding: Police	62
Crash Sensors and Airbag Indicator - Police	63
Disposing of Airbags	69

Pedestrian Alert System

What Is the Pedestrian Alert System	70
---	----

Table of Contents

911 Assist

What Is 911 Assist	71
How Does 911 Assist Work	71
Emergency Call Requirements	71
Emergency Call Limitations	72

Keys and Remote Controls

Remote Control Limitations	73
Using the Remote Control - Excluding: Police	73
Using the Remote Control - Police	74
Removing the Key Blade	74
Sounding the Panic Alarm - Excluding: Police	75
Sounding the Panic Alarm - Police	75
Locating Your Vehicle	75
Changing the Remote Control Battery - Vehicles With: Push Button Start, Excluding: Police	75
Changing the Remote Control Battery - Police	77
Replacing a Lost Key or Remote Control	78
Programming the Remote Control	78
Keys and Remote Controls Audible Warnings - Excluding: Police	79
Keys and Remote Controls Audible Warnings - Police	79
Using the Valet Mode	79
Keys and Remote Controls – Troubleshooting	80

Doors and Locks

Operating the Doors From Outside Your Vehicle	81
Operating the Doors From Inside Your Vehicle	82
Autounlock	82
Autolock	83
Mislock	83
Door Lock Indicators	83
Doors and Locks Audible Warnings	83

Doors and Locks – Troubleshooting	83
--	----

Keyless Entry

What Is Keyless Entry	86
Keyless Entry Limitations	86
Keyless Entry Settings	86
Using Keyless Entry	86
Keyless Entry – Troubleshooting	87

Keyless Entry Keypad

What Is the Keyless Entry Keypad	88
Keyless Entry Keypad Limitations	88
Locating the Keyless Entry Keypad	88
Keyless Entry Keypad Master Access Code	88
Keyless Entry Keypad Personal Access Codes	89
Using the Keyless Entry Keypad	89
Keyless Entry Keypad – Troubleshooting	90

Easy Entry and Exit

How Does Easy Entry and Exit Work	91
Switching Easy Entry and Exit On and Off	91

Liftgate - Vehicles With: Manual Liftgate

Opening the Liftgate	92
Closing the Liftgate	93

Liftgate - Vehicles With: Power Liftgate

Liftgate Precautions	94
Opening the Liftgate	94
Open On Approach Settings	95
Setting the Liftgate Opening Height	96
Closing the Liftgate	96

Table of Contents

Stopping the Liftgate Movement	97
Liftgate Obstacle Detection	97
Liftgate – Troubleshooting	98

Security

Passive Anti-Theft System	100
Anti-Theft Alarm System	100
Using the Police Perimeter Alert System - Police	101
Security – Troubleshooting	102

Steering Wheel

Adjusting the Steering Wheel	104
Horn	104
Switching the Heated Steering Wheel On and Off - Vehicles With: Heated Steering Wheel	104

Wipers and Washers

Wipers	105
Autowipers	105
Switching the Rear Window Wiper On and Off - Excluding: Police	106
Switching the Rear Window Wiper On and Off - Police	106
Reverse Wipe	107
Checking the Wiper Blades	107
Replacing the Front Wiper Blades	107
Replacing the Rear Wiper Blades	108
Washers	108
Wipers and Washers – Troubleshooting	111

Exterior Lighting

Exterior Lighting Control - Excluding: Police	112
Exterior Lighting Control	112
Headlamps	112
Autolamps	113
Exterior Lamps	114

Automatic High Beam Control - Excluding: Police	117
Adaptive Front Lighting	120
Exterior Lighting – Frequently Asked Questions	120

Interior Lighting

Switching All of the Interior Lamps On and Off - Excluding: Police	122
Switching All of the Interior Lamps On and Off - Police	122
Switching the Front Interior Lamps On and Off - Excluding: Police	122
Switching the Front Interior Lamps On and Off - Police	123
Switching the Rear Interior Lamps On and Off - Excluding: Police	123
Switching the Rear Interior Lamps On and Off - Police	124
Interior Lamp Function	124
Adjusting the Instrument Panel Lighting Brightness	124
Ambient Lighting	124
Interior Lighting – Troubleshooting	125

Windows

Opening and Closing the Windows	126
Global Opening	127
Window Bounce-Back	127
Locking the Rear Window Controls	127

Interior Mirror

Interior Mirror Precautions	128
Manually Dimming the Interior Mirror	128
Auto-Dimming Interior Mirror	128

Exterior Mirrors

Adjusting the Exterior Mirrors	129
Folding the Exterior Mirrors - Vehicles With: Power Folding Mirrors	129

Table of Contents

Folding the Exterior Mirrors - Vehicles With: Manual Folding Mirrors	130
Auto-Dimming Exterior Mirror	130

Glass Roof

Opening and Closing the Sunshade	131
--	-----

Instrument Cluster

Instrument Cluster Overview	132
Tachometer	132
Speedometer	132
Fuel Gauge	133
Engine Coolant Temperature Gauge	133

Instrument Cluster Display

Using the Instrument Cluster Display Controls	134
Instrument Cluster Display Main Menu	134
Customizing the Instrument Cluster Display	134

Trip Computer

Accessing the Trip Computer	136
Resetting the Trip Computer	136
Trip Data	136

Remote Start

Using Remote Start - Vehicles With: FordPass	137
Using Remote Start - Vehicles With: Remote Control	137
Remote Start Settings	138

Climate Control

Identifying the Climate Control Unit	139
Switching Climate Control On and Off	139
Switching Recirculated Air On and Off	139

Switching Air Conditioning On and Off	139
Switching Defrost On and Off	139
Switching Maximum Defrost On and Off	139
Switching Maximum Cooling On and Off	140
Switching the Heated Rear Window On and Off	140
Setting the Blower Motor Speed	140
Switching the Heated Mirrors On and Off	140
Setting the Temperature	140
Directing the Flow of Air	141
Air Conditioning System Refrigerant	141

Rear Passenger Climate Control

Identifying the Rear Passenger Climate Control Unit	142
Switching the Rear Passenger Climate Controls On and Off	142
Setting the Blower Motor Speed	142
Setting the Temperature	142
Directing the Flow of Air	143

Interior Air Quality

What Is the Cabin Air Filter	144
Locating the Cabin Air Filter	144

Front Seats

Front Seat Precautions	145
Sitting in the Correct Position	145
Manual Seats	146
Power Seats	147
Massage Seats	150
Heated Seats	151
Ventilated Seats	151

Table of Contents

Rear Seats

Manual Seats	153
Power Seats	156
Heated Seats	158

Rear Occupant Alert System

What is the Rear Occupant Alert System	159
How Does the Rear Occupant Alert System Work	159
Rear Occupant Alert System Precautions	159
Rear Occupant Alert System Limitations	159
Rear Occupant Alert System Settings	160
Rear Occupant Alert System Indicators	160
Rear Occupant Alert System Audible Warnings	161

Memory Function

How Does the Memory Function Work	162
Memory Function Precautions	162
Locating the Memory Function Buttons	162
Saving a Preset Position	162
Recalling a Preset Position	162

Garage Door Opener

Garage Door Opener Introduction	163
Garage Door Opener Precautions and Frequencies	163
Programming the Garage Door Opener	164

USB Ports

Locating the USB Ports	167
Playing Media Using the USB Port	167
Charging a Device	167

Power Outlet - Vehicles With: 110V Power Outlet/230V Power Outlet

What Is the Power Outlet	169
Power Outlet Precautions	169
Power Outlet Limitations	169
Locating the Power Outlets	169
Power Outlet Indicators	169

Power Outlet - Vehicles With: 12V Power Outlet

What Is the Power Outlet	171
Power Outlet Precautions	171
Locating the Power Outlets	171

Storage

Glove Compartment	172
Center Console - Excluding: Police	172
Under Floor Storage	173
Glasses Holder	173

Starting and Stopping the Engine

Starting and Stopping the Engine – Precautions	174
Ignition Switch - Police, Vehicles With: Keyed Ignition	174
Push Button Ignition Switch - Vehicles With: Push Button Start	175
Starting the Engine	175
Engine Block Heater - Vehicles With: Block Heater	176
Stopping the Engine	178
Police Engine Idle - Police	179
Automatic Engine Stop - Vehicles With: Push Button Start	180
Accessing the Passive Key Backup Position - Vehicles With: Push Button Start	181
Starting and Stopping the Engine – Troubleshooting	181

Table of Contents

Hybrid Electric Vehicle Information - Full Hybrid Electric Vehicle (FHEV)

Hybrid Electric Vehicle Information	185
Power Flow	186

Auto-Start-Stop - Excluding: Full Hybrid Electric Vehicle (FHEV)

What Is Auto-Start-Stop	188
Auto-Start-Stop Precautions	188
Switching Auto-Start-Stop On and Off	188
Stopping the Engine	188
Restarting the Engine	188
Auto-Start-Stop Indicators	188
Auto-Start-Stop – Troubleshooting	189

Fuel and Refueling

Fuel and Refueling Precautions	191
Fuel Quality	191
Locating the Fuel Filler Funnel	192
Running Out of Fuel	192
Refueling	194
Fuel Tank Capacity - Excluding: Full Hybrid Electric Vehicle (FHEV)	199
Fuel Tank Capacity - Full Hybrid Electric Vehicle (FHEV)	199
Fuel and Refueling – Troubleshooting	199

Catalytic Converter

What Is the Catalytic Converter	202
Catalytic Converter Precautions	202
Catalytic Converter – Troubleshooting	202

High Voltage Battery - Full Hybrid Electric Vehicle (FHEV)/Police

What Is the High Voltage Battery	203
High Voltage Battery Precautions	203
Recycling and Disposing of the High Voltage Battery	203
High Voltage Battery – Troubleshooting	203

Automatic Transmission

Automatic Transmission Precautions	204
Automatic Transmission Positions	204
Shifting Your Vehicle Into Gear - Excluding: Police	205
Shifting Your Vehicle Into Gear - Police	206
Automatic Transmission Position Indicators - Excluding: Police	206
Automatic Transmission Position Indicators - Police	206
Manually Shifting Gears - Excluding: Police	206
Temporary Neutral Mode	207
Automatic Return to Park (P) - Excluding: Police	208
Grade Assist	208
Shifting Your Immobile Vehicle Out of Park (P) - Excluding: Police	208
Shifting Your Immobile Vehicle Out of Park (P) - Police	210
Automatic Transmission Audible Warnings - Excluding: Police	212
Automatic Transmission Audible Warnings - Police	212
Automatic Transmission Fluid Capacity and Specification	212
Automatic Transmission – Information Messages	213

All-Wheel Drive

How Does All-Wheel Drive Work	214
-------------------------------------	-----

Table of Contents

Four-Wheel Drive

How Does Four-Wheel Drive Work	217
Four-Wheel Drive Limitations	217
Transfer Case Fluid Capacity and Specification	219
Four-Wheel Drive – Troubleshooting	219

Front Axle

Front Axle Fluid Capacity and Specification	221
---	-----

Rear Axle

Limited Slip Differential - Vehicles With: Limited-Slip Differential	222
Rear Axle Fluid Capacity and Specification	222

Drive Mode Control

What Is Drive Mode Control	223
How Does Drive Mode Control Work	223
Selecting a Drive Mode - Excluding: Police	223
Selecting a Drive Mode - Police	223
Drive Modes	224
Drive Mode Control – Troubleshooting	226

Brakes

Brake Precautions	228
Anti-Lock Braking System	228
Brake Over Accelerator	228
Locating the Brake Fluid Reservoir	228
Checking the Brake Fluid	228
Brake Fluid Specification	229
Brakes – Troubleshooting	230

Electric Parking Brake

What Is the Electric Parking Brake	232
Applying the Electric Parking Brake	232

Applying the Electric Parking Brake in an Emergency	232
Manually Releasing the Electric Parking Brake	232
Automatically Releasing the Electric Parking Brake	233
Electric Parking Brake Audible Warning	233
Releasing the Electric Parking Brake if the Vehicle Battery Has Run Out of Charge	233
Electric Parking Brake – Troubleshooting	233

Reverse Brake Assist

How Does Reverse Brake Assist Work	235
Reverse Brake Assist Precautions	235
Switching Reverse Brake Assist On and Off	236
Overriding Reverse Brake Assist	236
Reverse Brake Assist Indicators	236
Reverse Brake Assist – Troubleshooting	237

Hill Start Assist

What Is Hill Start Assist	239
How Does Hill Start Assist Work	239
Hill Start Assist Precautions	239
Hill Start Assist – Troubleshooting	239

Auto Hold

How Does Auto Hold Work	240
Switching Auto Hold On and Off	240
Using Auto Hold	240
Auto Hold Indicators	241

Traction Control

What Is Traction Control	242
How Does Traction Control Work	242
Switching Traction Control On and Off	242

Table of Contents

Traction Control Indicator	242
Traction Control – Troubleshooting	243

Stability Control

How Does Stability Control Work	244
Switching Stability Control On and Off - Excluding: Police	245
Switching Stability Control On and Off - Police	246
Stability Control Indicator	247

Hill Descent Control

What Is Hill Descent Control	248
Switching Hill Descent Control On and Off	248
Setting the Hill Descent Speed	248
Hill Descent Control Indicator	248

Steering

Electric Power Steering	249
Steering – Troubleshooting	250

Parking Aids

Parking Aid Precautions	251
Switching Parking Aid On and Off	251
Rear Parking Aid	252
Front Parking Aid	252
Parking Aid Indicators	254
Parking Aids – Troubleshooting	255

Rear View Camera

What Is the Rear View Camera	256
Rear View Camera Precautions	256
Locating the Rear View Camera	256
Rear View Camera Guide Lines	257
Rear View Camera Settings	257

360 Degree Camera

How Does the 360 Degree Camera Work	259
--	-----

360 Degree Camera Precautions	259
Locating the 360 Degree Cameras	259
360 Degree Camera Guide Lines	260
360 Degree Camera Settings	261

Cruise Control - Police

What Is Cruise Control	262
Switching Cruise Control On and Off	262
Setting the Cruise Control Speed	262
Canceling the Set Speed	263
Resuming the Set Speed	263
Cruise Control Indicators	263

Adaptive Cruise Control - Excluding: Police

How Does Adaptive Cruise Control With Stop and Go Work	264
Adaptive Cruise Control Precautions	264
Adaptive Cruise Control Limitations	265
Switching Adaptive Cruise Control On and Off	266
Adaptive Cruise Control Automatic Cancellation	267
Setting the Adaptive Cruise Control Speed	267
Setting the Adaptive Cruise Control Gap	268
Canceling the Set Speed	269
Resuming the Set Speed	269
Overriding the Set Speed	270
Adaptive Cruise Control Indicators	271
Switching From Adaptive Cruise Control to Cruise Control	271
Lane Centering	271
Lane Centering – Troubleshooting	274
Predictive Speed Assist	275
Predictive Speed Assist – Troubleshooting	277

Table of Contents

Adaptive Cruise Control – Troubleshooting	277
---	-----

BlueCruise

How Does BlueCruise Work	279
BlueCruise Precautions	279
BlueCruise Requirements	281
BlueCruise Limitations	281
BlueCruise Settings	282
Switching BlueCruise On and Off	282
BlueCruise Alerts	283
BlueCruise Automatic Cancellation	283
BlueCruise Indicators	284
Lane Change Assist	284
Automatic Lane Change	286
In-Lane Repositioning	287
BlueCruise – Information Messages	288

Lane Keeping System

What Is the Lane Keeping System	290
How Does the Lane Keeping System Work	290
Lane Keeping System Precautions	290
Lane Keeping System Limitations	290
Switching the Lane Keeping System On and Off	291
Switching the Lane Keeping System Mode	291
Alert Mode	291
Aid Mode	292
Alert and Aid Mode	292
Lane Keeping System Indicators	293
Blind Spot Assist	294
Blind Spot Assist with Trailer Coverage	294
Lane Keeping System – Troubleshooting	297

Blind Spot Information System

What Is Blind Spot Information System	299
How Does Blind Spot Information System Work	299
Blind Spot Information System Precautions	299
Blind Spot Information System Limitations	299
Blind Spot Information System Requirements	299
Switching Blind Spot Information System On and Off	300
Locating the Blind Spot Information System Sensors	300
Blind Spot Information System With Trailer Coverage	300
Blind Spot Information System Indicators	302
Blind Spot Information System – Troubleshooting	303

Exit Warning

What is Exit Warning	304
How Does Exit Warning Work	304
Exit Warning Precautions	304
Exit Warning Limitations	304
Exit Warning Indicators	305
Switching Exit Warning On and Off	305
Locating the Exit Warning Sensors	305
Exit Warning – Troubleshooting	306

Cross Traffic Alert

What Is Cross Traffic Alert	307
How Does Cross Traffic Alert Work	307
Cross Traffic Alert Precautions	307
Cross Traffic Alert Limitations	308
Switching Cross Traffic Alert On and Off	309
Locating the Cross Traffic Alert Sensors	309

Table of Contents

Cross Traffic Alert Indicators	310
Cross Traffic Alert – Troubleshooting	310

Pre-Collision Assist

What Is Pre-Collision Assist	311
How Does Pre-Collision Assist Work	311
Pre-Collision Assist Precautions	311
Pre-Collision Assist Limitations	312
Switching Pre-Collision Assist On and Off - Excluding: Police	314
Switching Pre-Collision Assist On and Off - Police	314
Locating the Pre-Collision Assist Sensors	314
Automatic Emergency Braking	315
Evasive Steering Assist	315
Pre-Collision Assist – Troubleshooting	316

Speed Sign Recognition

What Is Speed Sign Recognition	318
How Does Speed Sign Recognition Work	318
Speed Sign Recognition Precautions	318
Speed Sign Recognition Limitations	318
Speed Sign Recognition Indicators	319
Speed Sign Recognition Settings	319
Speed Sign Recognition – Troubleshooting	319

Driver Alert

What Is Driver Alert	320
How Does Driver Alert Work	320
Driver Alert Precautions	320
Driver Alert Limitations	320
Switching Driver Alert On and Off	321
Driver Alert – Troubleshooting	321

Load Carrying

Load Carrying Precautions	322
Locating the Safety Compliance Certification Labels	323
What Is the Gross Axle Weight Rating	323
What Is the Gross Vehicle Weight Rating	323
What Is the Gross Combined Weight Rating	324
Calculating Payload	324
Calculating the Load Limit	325
Roof Rack	326

Luggage Compartment

Luggage Compartment Precautions	328
Installing and Removing the Luggage Compartment Cargo Net	328
Installing and Removing the Luggage Compartment Cover	329
Luggage Compartment Anchor Points	330

Connecting a Trailer

Connecting a Trailer Precautions	331
Connecting a Trailer	331
Connecting a Trailer – Troubleshooting	332

Towing a Trailer

Towing a Trailer Precautions	333
Trailer Brake Precautions	333
Towing a Trailer Limitations	334
Loading Your Trailer	334
Trailer Towing Hints	334
Launching or Retrieving a Boat or Personal Watercraft	335
Towing Weights and Dimensions	336
Towing a Trailer – Troubleshooting	337

Table of Contents

Trailer Sway Control

How Does Trailer Sway Control Work	338
Trailer Sway Control Precautions	338

Driving Hints

Breaking-In	339
Driving Economically	339
Driving in Cold Weather	339
Driving Through Mud and Water	340
Driving on Hilly or Sloping Terrain	340
Driving In Sand	341
Driving Through Shallow Water	341
Floor Mats	341

Crash and Breakdown Information

Roadside Assistance	343
High Voltage Battery Vehicle Precautions - Full Hybrid Electric Vehicle (FHEV)	344
Switching the Hazard Flashers On and Off	345
Jump Starting the Vehicle	345
Post-Crash Alert System	348
Post-Collision Braking - Excluding: Police	348
Automatic Crash Shutoff	349
Transporting the Vehicle	349
Fail-Safe Cooling	350

Towing Your Vehicle

Towing Your Vehicle Precautions	352
Recreationally Towing Your Vehicle	352
Emergency Towing - Police	352
Emergency Towing - Excluding: Police	352

Fuses

Fuse Precautions	353
------------------------	-----

Under Hood Fuse Box	353
Interior Fuse Box	359
Identifying Fuse Types	362
Fuses – Troubleshooting	362

Maintenance

Maintenance Precautions	364
Opening and Closing the Hood	364
Under Hood Overview - 2.3L	366
Under Hood Overview - 3.0L	367
Under Hood Overview - 3.3L	368
Engine Oil	369
Engine Air Filter	376
Coolant	379
Changing the Fuel Filter	384
Drive Belt Routing Overview - 2.3L	384
Drive Belt Routing Overview - 3.0L	384
Drive Belt Routing Overview - 3.3L, Gasoline	385
Drive Belt Routing Overview - 3.3L, Hybrid Electric Vehicle (HEV)	385
12V Battery	385
12V Battery – Troubleshooting	390
Adjusting the Headlamps	392
Exterior Bulbs	393
Interior Bulbs	393

Vehicle Specifications

Engine Specifications - 2.3L	394
Engine Specifications - 3.0L	395
Engine Specifications - 3.3L, Gasoline	396
Engine Specifications - 3.3L, Hybrid Electric Vehicle (HEV)	397
Motorcraft Parts - 2.3L	398
Motorcraft Parts - 3.0L	398
Motorcraft Parts - 3.3L	399

Vehicle Care

Cleaning Products	401
-------------------------	-----

Table of Contents

Cleaning the Exterior	402
Cleaning the Interior	404
Repairing Minor Paint Damage	406
Waxing Your Vehicle	406

Storing Your Vehicle

Preparing Your Vehicle for Storage	407
Removing Your Vehicle From Storage	408

Wheel and Tire Information

Locating the Tire label	409
Department of Transportation Uniform Tire Quality Grades	409
Information on the Tire Sidewall	410
Glossary of Tire Terminology	415
Tire Replacement Requirements	416
Using Snow Chains	418

Tire Care

Checking the Tire Pressures	420
Inflating the Tires	420
Inspecting the Tire for Wear	421
Inspecting the Tire for Damage	422
Inspecting the Wheel Valve Stems	426
Tire Rotation	426

Tire Sealant and Inflator Kit

What Is the Tire Sealant and Inflator Kit	428
Tire Sealant and Inflator Kit Precautions	428
Locating the Tire Sealant and Inflator Kit	428
Tire Sealant and Inflator Kit Components	429
Using the Tire Sealant and Inflator Kit	429

Tire Pressure Monitoring System

What Is the Tire Pressure Monitoring System	435
Tire Pressure Monitoring System Overview	435
Tire Pressure Monitoring System Precautions	436
Tire Pressure Monitoring System Limitations	436
Viewing the Tire Pressures	437
Tire Pressure Monitoring System – Troubleshooting	437

Changing a Road Wheel

Changing a Flat Tire - Excluding: Police	439
Changing a Flat Tire - Police	444
Wheel Nuts	449

Vehicle Identification

Vehicle Identification Number	451
-------------------------------------	-----

Connected Vehicle

What Is a Connected Vehicle	452
Connected Vehicle Requirements	452
Connected Vehicle Limitations	452
Connecting the Vehicle to a Mobile Network	452
Connecting the Vehicle to a Wi-Fi Network	452
Connected Vehicle Settings	452
Connected Vehicle – Troubleshooting	453

Vehicle Hotspot

Setting Up a Vehicle Hotspot	455
Vehicle Hotspot Settings	455
Vehicle Hotspot – Troubleshooting	456

Table of Contents

Audio System

Audio System Precautions	457
Switching the Audio Unit On and Off	457
Selecting the Audio Source	457
Media Control Buttons	457
Adjusting the Volume	458
Setting a Memory Preset	458
Adjusting the Sound Settings	458
Setting the Clock and Date	458
AM/FM Radio	458
Digital Radio	459
Satellite Radio	460
Audio System – Troubleshooting	463

Center Display

Center Display Overview	467
Status Bar	467
Apps	468
Controls	468
Settings	468
Driver Assistance Menu	469
Rebooting the Displays	469

Voice Interaction

What is Voice Interaction	470
Setting Your Default Assistant	470
Google Assistant	470

Phone

Phone Precautions	472
Connecting Your Phone	472
Phone Menu	472
Making and Receiving a Phone Call	473
Sending and Receiving a Text Message	474
Switching Text Message Notification On and Off	475
Switching Apple CarPlay On and Off	475

Switching Android Auto™ On and Off	475
--	-----

Bluetooth®

Connecting a Bluetooth® Device	477
Playing Media Using Bluetooth®	477

Personal Profiles

How Do Personal Profiles Work	478
Enabling or Disabling Personal Profiles	478
Creating a Personal Profile	478
Linking or Unlinking a Personal Profile	478

Navigation

Navigation	480
------------------	-----

Vehicle Software Updates

Vehicle Software Updates	481
Software Update Settings	481
Software Update Indicators	482

Vehicle System Reset

Performing a System Reset	483
---------------------------------	-----

Accessories

Accessories	484
-------------------	-----

Ford Protect

What Is Ford Protect	486
----------------------------	-----

Scheduled Maintenance

Scheduled Maintenance	488
General Maintenance Information	492

Customer Information

Rollover Warning	496
Getting the Services You Need	496
In California (U.S. Only)	498

Table of Contents

The Better Business Bureau Auto Line Program	500
The Mediation and Arbitration Program	500
Getting Assistance Outside the U.S. and Canada	501
Reporting Safety Defects in the United States	502
Reporting Safety Defects in Canada	502
Third Party Software Copyright Acknowledgment	503
Radio Frequency Certification Labels	503
Perchlorate	503
Replacement Parts Recommendation	503
Mobile Communications Equipment	504
Federal Highway Administration Regulation	504
Emission Law	504
Export Unique Options	505
Warranty Information	506

Decommissioning the Vehicle - Police

Decommissioning Requirements	507
------------------------------------	-----

Appendices

Electromagnetic Compatibility	509
-------------------------------------	-----

Contacting Us

If you require assistance or clarification on policies or procedures, please contact the customer relationship center.

United States

Ford Motor Company
Customer Relationship Center
PO Box 6248
Dearborn, MI 48126
1-800-392-3673 (FORD)
TDD for the hearing impaired:
7-1-1 (where offered by your telephone
service provider)
www.ford.com/help/contact/

Ford Credit - US Only

Ford Credit offers a full range of financing and lease plans to help you acquire your vehicle. If you have financed or leased your vehicle through Ford Credit, thank you for your business.

For assistance call 1-800-727-7000, or for more information about Ford Credit and access to an account manager, visit www.ford.com/finance.

Canada

Customer Relationship Centre
Ford Motor Company of Canada Limited
P.O. Box 2000
Oakville, Ontario L6J 5E4
1-800-565-3673 (FORD)
TDD for the hearing impaired:
7-1-1 (where offered by your telephone
service provider)
www.ford.ca

Australia

Ford Motor Company of Australia Pty Ltd.
Customer Relationship Centre
Private Mail Bag 5
Campbellfield, Victoria, 3061
Telephone: (13 FORD) 13 3673
E-mail: foacust1@ford.com

New Zealand

Ford Motor Company
Attention: Customer Relationship Centre
Private Bag 76912
Manukau City 2241
Telephone: 0800 367 369 (FORDNZ)
E-mail: fnzcust@ford.com

China - Imported Vehicle

Customer Relationship Center
Telephone: 400-690-1886
Website: <https://www.ford.com.cn/>

China - Chang'An Ford

Customer Relationship Center
Telephone: 800-810-8168
Mobile: 400-887-7766
Website: <https://www.ford.com.cn/>

Asia Pacific Direct Markets (APDM)

E-mail: apemcrc@ford.com

Caribbean, Central America and Israel

Ford Motor Company
Ford Export Operations
Attention: Owner Relations
1555 Fairlane Drive
Fairlane Business Park #3
Allen Park, MI 48101
Fax: (313) 390-0804
Telephone: (800) 841-3673
E-mail: atnclien@ford.com

U.S. Virgin Islands and Puerto Rico

Ford Motor Company
Ford Export Operations
Attention: Owner Relations
1555 Fairlane Drive
Fairlane Business Park #3
Allen Park, MI 48101
Telephone: (800) 841-3673
E-mail: atnclien@ford.com

Contacting Us

Argentina

Telephone: 0800-888-3673

Brazil

Website: www.ford.com.br
Telephone: 0800-703-3673
E-mail: central@ford.com

North Africa

E-mail: nafcrc@ford.com

South Africa

Telephone: 0860011022
Email: fordcrc2@ford.com

Sub-Saharan Africa

E-mail: ssacrc@ford.com

Puerto Rico

Ford International Business Development,
Inc.
P.O. Box 11957
Caparra Heights Station
San Juan, PR 00922-1957
1-800-392-3673 (FORD)
Fax: (313) 390-0804
E-mail: prcac@ford.com
www.ford.com.pr

Middle East

Ford Middle East Customer Relationship
Center
P.O. Box 21740
Dubai, United Arab Emirates
Telephone: 80004441066
Toll-free number for the Kingdom of Saudi
Arabia: 8008443673
Mobily and Zain cell phone users in Saudi
Arabia: 800850078
Kuwait: 22280384
Local telephone number for Kuwait: +965
1 898900
Fax: +971 4 3327266
E-mail: menacac@ford.com
www.me.ford.com

South Korea

Customer Relationship Center
Telephone: +82-02-1600-6003
E-mail: infokr1@ford.com
Emergency Dispatch Service call:
080-300-3673

Philippines

Telephone: 02-88669408
Email: emailus@ford.com

Taiwan

Telephone: 0800-032100
705 Zhonghua Rd., Sec. 1
Zhongli District, Taoyuan, Taiwan, 32068

Thailand

Telephone: 1383
E-mail: fordthai@ford.com

Vietnam

Telephone: 1800588888
E-mail: fordvn@ford.com

Introduction

ABOUT THIS PUBLICATION



WARNING: Driving while distracted can result in loss of vehicle control, crash and injury. We strongly recommend that you use extreme caution when using any device that may take your focus off the road. Your primary responsibility is the safe operation of your vehicle. We recommend against the use of any hand-held device while driving and encourage the use of voice-operated systems when possible. Make sure you are aware of all applicable local laws that may affect the use of electronic devices while driving.



WARNING: You risk death, fire, or serious injury to yourself and others if you do not follow the instruction highlighted by the warning symbol.

Thank you for choosing Ford. We recommend that you take some time to get to know your vehicle in order to benefit from greater safety and pleasure from driving it. Use this publication, whether in-vehicle center display screen, print, in Ford mobile app or online, to familiarize yourself with the features on your vehicle.

Note: *Use and operate your vehicle in line with all applicable laws and regulations.*

Note: *Pass on all printed owner's information when selling this vehicle.*

Features and Options

This publication describes product features and options available throughout the range of available models, sometimes even before they are generally available. It could describe options that are not available on the vehicle you have purchased.

Driver Assistance Technologies

Your vehicle may contain certain Driver Assistance Technologies (for example Pre-Collision Assist, Adaptive Cruise Control, Lane Keeping System, and BlueCruise). Use of these technologies still requires your complete attention while driving. Even if a certain technology allows you not to have your hands on the steering wheel, your eyes need to be on the road, and you must be alert to your surroundings. Your complete attention is required while driving since you may need to take immediate control due to the presence of roadway hazards or a change in road, weather, or lighting conditions. Use of these features does not relieve you of your responsibility to drive with due care and attention. Always be prepared to manually control the speed and direction of your vehicle. Please refer to this manual for information pertaining to each Driver Assistance feature.

Providing Feedback

If you would like to provide feedback to the Owner's Manual team, please email us at OWNERMANUALFEEDBACK@ford.com.

You will not receive a direct email response. Your submission will be investigated and necessary changes will be made to the Owner's Manual content.

To help investigate your submission, please include the following information:

- Your vehicle model
- The country in which your vehicle was purchased
- The Owner's Manual section needing investigation

Introduction

Illustrations

Note: Some of the illustrations in this publication could show features as used in different models, so could appear different to you on your vehicle.

Location of Components

This manual may qualify the location of a component as left-hand side or right-hand side. The side is determined when facing forward in the seat.

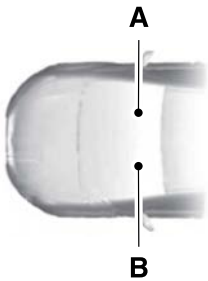

- A Right-hand side.
- B Left-hand side.

Accessing the Digital Owner's Manual

You can find the latest version of the Owner's Manual through the Owner's Manual application if your vehicle is connected. If your vehicle is not connected, a code is displayed in the app. Scan the code with your smart device which leads you to the same version of the Owner's Manual online. This content may vary slightly from the printed Supplemental Owner's Guide originally placed in your vehicle.



Vehicles with a Portrait Center Display Screen

The Owner's Manual application is located in the Apps list.

Vehicles with a Landscape Center Display Screen

Depending on your vehicle, the Owner's Manual application is located in either the Apps list or the Features list.

Accessing the Online and Printed Owner's Manual

Online Owner's Manual

- Through your device's app store, you can download the Ford mobile app.
- You can visit the local Ford Website.

Note: To find the local Ford website, visit <https://corporate.ford.com/operations/locations/global-links.html>.

Note: We strongly recommend downloading a copy of the Owner's Manual and having it with you whenever you drive, and to view the information if you are unable to be inside the vehicle.

Printed Owner's Manual

In U.S. and Canada, visit <https://www.helminc.com> or see an authorized dealer.

Introduction



In Europe, visit <https://www.z-order.de> or see an authorized dealer.



For all other Countries, see your authorized dealer.

USING THIS PUBLICATION















To quickly locate information about your vehicle, use the word search within the Owner's Manual application.

Symbols Glossary

SYMBOLS USED ON YOUR VEHICLE

These are some of the symbols you may see on your vehicle.

	Airbag
	Air conditioning system
	Air conditioning system lubricant type
	Anti-lock braking system
	Avoid smoking, flames or sparks
	Battery
	Battery acid
	Blower motor
	Brake fluid - non petroleum based
	Brake system
	Brake system
	Cabin air filter
	Check fuel cap

	Child safety door lock or unlock
	Child seat lower anchor
	Child seat tether anchor
	Cruise control
	Do not open when hot
	Electric Parking brake
	Engine air filter
	Engine coolant
	Engine coolant temperature
	Engine oil
	Explosive gas
	Fan warning
	Fasten seatbelt
	Flammable
	Front fog lamps

Symbols Glossary



Fuel pump reset



Fuse compartment



Hazard flashers



Headlamp high beams



Headlamps on



Heated rear window



Hill descent control



Horn control



Interior luggage compartment release



Jack



Keep out of reach of children



Lighting control



Low fuel level



Low tire pressure warning



Maintain correct fluid level



Malfunction Indicator Lamp (MIL)



Note operating instructions



Panic alarm



Parking aid



Parking lamps



Passenger airbag activated



Passenger airbag deactivated



Power steering fluid



Power windows front/rear



Power window lockout



Requires registered technician



Safety alert



See Owner's Manual



See Service Manual



Side airbag

Symbols Glossary



Shield the eyes



Stability control



Stability control off



Trail control



Turn Signal



Windshield defrosting system



Windshield wiping system



Windshield wash and wipe

SYMBOLS USED ON YOUR INSTRUMENT CLUSTER

Depending on your vehicle options, market, and instrument cluster type, not all symbols shown are available.

Lighting and Signaling



High beams. See **Headlamp Indicators** (page 113).



Auto high beams. See **Automatic High Beam Control Indicators** (page 119).



Front fog lamps. See **Using the Front Fog Lamps** (page 115).



Off road auxiliary lighting active.



Turn signal - right. See **Using the Turn Signal Lamps** (page 114).



Turn signal - left. See **Using the Turn Signal Lamps** (page 114).



Positioning/side lights. See **Headlamp Indicators** (page 113).



Exterior bulb failure. See **Exterior Bulb Specification Chart** (page 393).

Brakes



Brake failure. See **Brakes – Warning Lamps** (page 230).



Brake failure. See **Brakes – Warning Lamps** (page 230).



Electric parking brake fault. See **Electric Parking Brake – Warning Lamps** (page 233).



Anti-lock brake system malfunction. See **Brakes – Warning Lamps** (page 230).



Automatic brake hold. See **Auto Hold Indicators** (page 241).



Automatic brake hold off or unavailable. See **Auto Hold Indicators** (page 241).

Visibility



Windshield washer fluid level. See **Wipers and Washers – Warning Lamps** (page 111).

Engine



Check engine. See **Starting and Stopping the Engine – Warning Lamps** (page 181).

Symbols Glossary



Engine oil pressure. See **Starting and Stopping the Engine – Warning Lamps** (page 181).



Engine coolant temperature. See **Coolant – Warning Lamps** (page 383).



Auto Start/Stop. See **Auto-Start-Stop Indicators** (page 188).



Auto Start/Stop off or unavailable. See **Auto-Start-Stop Indicators** (page 188).

Fuel



Fuel. See **Fuel and Refueling – Warning Lamps** (page 199).

Transmission



Non-emission powertrain fault. See **Starting and Stopping the Engine – Warning Lamps** (page 181).

Vehicle Handling



Selectable drive mode - normal. See **Normal** (page 224).



Selectable drive mode - ECO. See **Eco** (page 224).



Selectable drive mode - sport. See **Sport** (page 225).



Selectable drive mode - tow/haul. See **Tow/Haul** (page 225).



Selectable drive mode - slippery. See **Slippery** (page 225).



Selectable drive mode - trail. See **Trail** (page 225).



Selectable drive mode - snow/sand. See **Deep Snow/Sand** (page 224).



Selectable drive mode - off-road. See **Off-Road** (page 224).



Selectable drive mode - pursuit. See **Pursuit** (page 224).

Driver Assistance



Cruise control. See **Cruise Control Indicators** (page 263).



Adaptive cruise control. See **Adaptive Cruise Control Indicators** (page 271).



Hill descent control. See **Hill Descent Control Indicator** (page 248).



Lane keeping assist. See **Switching the Lane Keeping System On and Off** (page 291).



Lane centering assist. See **Lane Centering Indicators** (page 274).

Safety



Seatbelt. See **Seatbelt Reminder Indicators** (page 50).



Airbag. See **Crash Sensors and Airbag Indicator** (page 62).



Stability control system active or not available. See **Stability Control Indicator** (page 247).

Symbols Glossary



Stability control system off. See **Stability Control Indicator** (page 247).



Tire failure/Low tire pressure. See **Tire Pressure Monitoring System – Warning Lamps** (page 437).



Forward collision warning system off or unavailable. See **Pre-Collision Assist – Warning Lamps** (page 316).



Blind spot information system off or unavailable. See **Switching Blind Spot Information System On and Off** (page 300).



Door(s) ajar. See **Doors and Locks – Warning Lamps** (page 83).

Security



Hood release/ajar. See **Opening and Closing the Hood** (page 364).



Liftgate release/ajar. See **Liftgate – Warning Lamps** (page 98).



Keyless idle. See **How Does Police Engine Idle Work** (page 179).



Pursuit mode. See **Pursuit** (page 224).



Boundary alert. See **Using the Police Perimeter Alert System** (page 101).



Liftgate unlock.

Electrical Systems



Battery charge level. See **12V Battery – Warning Lamps** (page 390).



Hybrid/electric system failure. See **Hybrid Electric Vehicle Information** (page 185).



Ready to drive. See **Hybrid Electric Vehicle Information** (page 185).

Data Privacy



WARNING: Do not connect wireless plug-in devices to the data link connector. Unauthorized third parties could gain access to vehicle data and impair the performance of safety related systems. Only allow repair facilities that follow our service and repair instructions to connect their equipment to the data link connector.

We respect your privacy and are committed to protecting it. The information contained in this publication was correct at the time of release, but as technology rapidly changes, we recommend that you visit the local Ford website for the latest information.

Your vehicle has electronic control units that have data recording functionality and the ability to permanently or temporarily store data. This data could include information on the condition and status of your vehicle, vehicle maintenance requirements, events and malfunctions. The types of data that can be recorded are described in this section. Some of the data recorded is stored in event logs or error logs.

Note: *Error logs are reset following a service or repair.*

Note: *We may provide information in response to requests from law enforcement, other government authorities and third parties acting with lawful authority or through a legal process. Such information could be used by them in legal proceedings.*

Data recorded includes, for example:

- Operating states of system components, for example fuel level, tire pressure and battery charge level.
- Vehicle and component status, for example wheel speed, deceleration, lateral acceleration and seatbelt status.

- Events or errors in essential systems, for example headlamps and brakes.
- System responses to driving situations, for example airbag deployment and stability control.
- Environmental conditions, for example temperature.

Some of this data, when used in combination with other information, for example an accident report, damage to a vehicle or eyewitness statements, could be associated with a specific person.

Services That We Provide

If you use our services, we collect and use data, for example account information, vehicle location and driving characteristics, that could identify you. We transmit this data through a dedicated, protected connection. We only collect and use data to enable your use of our services to which you have subscribed, with your consent or where permitted by law. For additional information, see the terms and conditions of the services to which you have subscribed.

For additional information about our privacy policy, refer to the local Ford website.

Services That Third Parties Provide

We recommend that you review the terms and conditions and data privacy information for any services equipped with your vehicle or to which you subscribe. We take no responsibility for services that third parties provide.

Where equipped, SiriusXM with 360L could use the modem. To disable, turn off the SiriusXM with 360L or Vehicle Connectivity setting. See **Enabling and Disabling the Modem** (page 452).

Data Privacy

Note: *Consistent with your data and connectivity settings, data may be accessed by third parties.*

SERVICE DATA

Service data recorders in your vehicle are capable of collecting and storing diagnostic information about your vehicle. This potentially includes information about the performance or status of various systems and modules in the vehicle, such as engine, throttle, steering or brake systems. In order to properly diagnose and service your vehicle, Ford Motor Company (Ford of Canada in Canada), and service and repair facilities may access or share among them vehicle diagnostic information received through a direct connection to your vehicle when diagnosing or servicing your vehicle. Additionally, Ford Motor Company (Ford of Canada, in Canada) may, where permitted by law, use vehicle diagnostic information for vehicle improvement or with other information we may have about you, for example, your contact information, to offer you products or services that may interest you. Data may be provided to our service providers such as part suppliers that may help diagnose malfunctions, and who are similarly obligated to protect data. We retain this data only as long as necessary to perform these functions or to comply with law. We may provide information where required in response to official requests to law enforcement or other government authorities or third parties acting with lawful authority or court order, and such information may be used in legal proceedings. For U.S. only (if equipped), if you choose to use connected apps and services, you consent that certain diagnostic information may also be accessed electronically by Ford Motor Company and Ford authorized service facilities, and that the diagnostic

information may be used to provide services to you, personalizing your experience, troubleshoot, and to improve products and services and offer you products and services that may interest you, where permitted by law. For Canada only, for more information, please review the Ford of Canada privacy policy at www.ford.ca, including our U.S. data storage and use of service providers in other jurisdictions who may be subject to legal requirements in Canada, the United States and other countries applicable to them, for example, lawful requirements to disclose personal information to governmental authorities in those countries.

EVENT DATA

This vehicle is equipped with an event data recorder. The main purpose of an event data recorder is to record, in certain crash or near crash-like situations, such as an airbag deployment or hitting a road obstacle; this data will assist in understanding how a vehicle's systems performed. The event data recorder is designed to record data related to vehicle dynamics and safety systems for a short period of time, typically 30 seconds or less.

The event data recorder in this vehicle is designed to record such data as:

- How various systems in your vehicle were operating.
- Whether or not the driver and passenger seatbelts were buckled/fastened.
- How far (if at all) the driver was depressing the accelerator and/or the brake pedal.
- How fast the vehicle was traveling.
- Where the driver was positioning the steering wheel.

Data Privacy

This data can help provide a better understanding of the circumstances in which crashes and injuries occur.

Note: *Event data recorder data is recorded by your vehicle only if a non-trivial crash situation occurs; no data is recorded by the event data recorder under normal driving conditions and no personal data or information (for example name, gender, age, and crash location) is recorded. However, parties, such as law enforcement, could combine the event data recorder data with the type of personally identifying data routinely acquired during a crash investigation.*

To read data recorded by an event data recorder, special equipment is required, and access to the vehicle or the event data recorder is needed. In addition to the vehicle manufacturer, other parties, such as law enforcement, that have such special equipment, can read the information if they have access to the vehicle or the event data recorder.

BlueCruise Data (If Equipped)

If BlueCruise is active in certain crash or near crash-like situations, such as an airbag deployment or hitting a road obstacle, the system may record driver attentiveness, based on the direction of eyes and duration, and photographs of the driver seat area.

Note: *No data is recorded under normal driving conditions.*

SETTINGS DATA

Your vehicle has electronic control units that have the ability to store data based on your personalized settings. The data is stored locally in the vehicle or on devices that you connect to it, for example, a USB drive or mobile device. You can delete some of this data and also choose whether to share it through the services to which you subscribe. See **Settings** (page 468).

Comfort and Convenience Data

Data recorded includes, for example:

- Seat and steering wheel position.
- Climate control settings.
- Radio presets.

Entertainment Data

Data recorded includes, for example:

- Music, videos or album art.
- Contacts and corresponding address book entries.
- Navigation destinations.

CONNECTED VEHICLE DATA

The modem has a SIM. The modem was enabled when your vehicle was built and periodically sends messages to stay connected to the cell phone network, receive automatic software updates and may send vehicle-related information to us, for example diagnostic information. Subject to your consent, the vehicle may send vehicle, driving and location data. These messages could include information that identifies your vehicle, the SIM and the electronic serial number of the modem. Cell phone network service providers could

Data Privacy

have access to additional information, for example cell phone network tower identification. For additional information about our privacy policy, visit <https://www.fordconnected.com> or refer to your local Ford website.

Note: *The modem may continue to send this information unless you disable the modem or stop the modem from sharing vehicle data by changing the connectivity settings. See **Connected Vehicle** (page 452).*

Note: *The service can be unavailable or interrupted for a number of reasons, for example environmental or topographical conditions and data plan coverage.*

Note: *To find out if your vehicle has connectivity technology, visit <https://www.fordconnected.com>.*

MOBILE DEVICE DATA

If you connect a mobile device to your vehicle, you can display data from your device on the touchscreen for example, music and album art. You can grant apps permission to access your connected vehicle information with mobile apps on your device through the system.

The mobile apps function operates by your connected device sending data to us in the United States. The data is encrypted and includes, for example, the vehicle identification number of your vehicle, the operating system module serial number, odometer, enabled apps, usage statistics and debugging information. We retain it only as long as necessary to provide the service, to troubleshoot, for continuous improvement and to offer you products and services that may be of interest to you according to your preferences and where allowed by law.

If you connect a cell phone to the system, the system creates a profile that links to that cell phone. The cell phone profile enables more mobile features and efficient operation. The profile contains, for example data from your phonebook, read and unread text messages and call history, including history of calls when your cell phone was not connected to the system.

If you connect a media device, the system creates and retains a media device index of supported media content. The system also records a short diagnostic log of approximately 10 minutes of all recent system activity.

The cell phone profile, media device index and diagnostic log remain in your vehicle unless you delete them and are generally accessible only in your vehicle when you connect your cell phone or media device. If you no longer plan to use the system or your vehicle, we recommend you use the applicable reset function to erase the stored information. See **Performing a System Reset** (page 483).

System data cannot be accessed without special equipment and access to your vehicle's module.

For additional information about our privacy policy, refer to the local Ford website.

Note: *To find out if your vehicle has connectivity technology, visit <https://www.fordconnected.com>.*

EMERGENCY CALL SYSTEM DATA

When the emergency call system is active, it may disclose to emergency services that your vehicle has been in a crash involving the deployment of an airbag or activation of the fuel pump shut-off. Certain versions or updates to the emergency call system may also be capable of electronically or

Data Privacy

verbally disclosing to emergency services operators your vehicle location or other details about your vehicle or crash to assist emergency services operators to provide the most appropriate emergency services. If you do not want to disclose this information, do not activate the emergency call system.

Note: *You cannot deactivate emergency call systems that are required by law.*

Environment

PROTECTING THE ENVIRONMENT

Sustainability is a priority at Ford. We are constantly looking for ways to reduce our impact on the planet while providing customers with great products and delivering a strong business. You should play your part in protecting the environment. Correct vehicle usage and the authorized disposal of waste, cleaning and lubrication materials are significant steps toward this aim.

For additional information about our sustainability progress and initiatives, visit www.sustainability.ford.com.

Visual Search

INTERIOR OVERVIEW

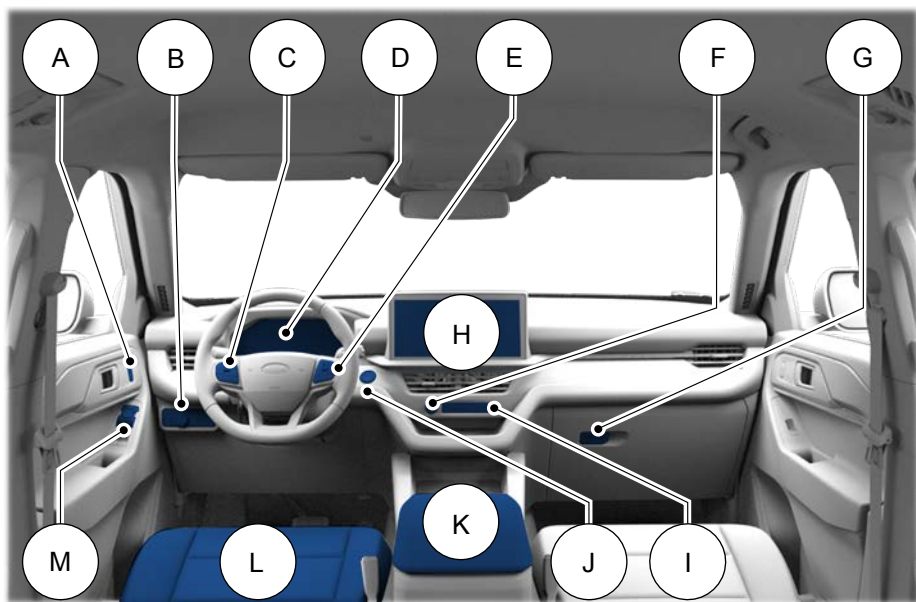

- A See **Unlocking and Locking the Doors Using the Central Locking** (page 82).
- B See **Exterior Lighting Control** (page 112). See **Exterior Lighting Control** (page 112).
- C See **Switching Cruise Control On and Off** (page 262). See **Switching Adaptive Cruise Control On and Off** (page 266).
- D See **Instrument Cluster Overview** (page 132).
- E See **Using the Instrument Cluster Display Controls** (page 134).
- F See **Switching the Audio Unit On and Off** (page 457).
- G See **Opening the Glove Compartment** (page 172).
- H See **Center Display Overview** (page 467).
- I See **Switching the Hazard Flashers On and Off** (page 345).
- J See **Ignition Switch** (page 174). See **Push Button Ignition Switch** (page 175).

Visual Search

- K See **Opening the Center Console** (page 172).
- L See **Sitting in the Correct Position** (page 145).
- M See **Adjusting the Exterior Mirrors** (page 129).

EXTERIOR OVERVIEW

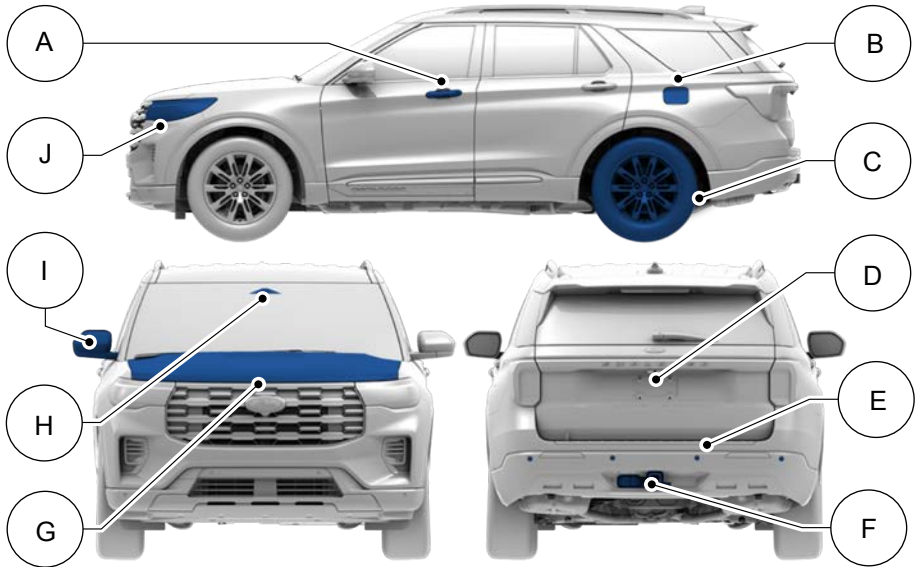

- A See **Unlocking and Locking the Doors Using the Remote Control** (page 81).
- B See **Refueling Your Vehicle** (page 194). See **Refueling Your Vehicle** (page 195).
- C See **Changing a Flat Tire** (page 439).
- D See **Locating the 360 Degree Cameras** (page 259).
- E See **Locating the Rear Parking Aid Sensors** (page 252).
- F See **Connecting a Trailer** (page 331).

Visual Search

- G See **Opening and Closing the Hood** (page 364).
- H See **Locating the Pre-Collision Assist Sensors** (page 314).
- I See **Folding the Exterior Mirrors** (page 129).
- J See **Using the High Beam Headlamps** (page 112). See **Using the High Beam Headlamps** (page 113).

Child Safety

CHILD SAFETY PRECAUTIONS



WARNING: Always make sure your child is secured properly in a device that is appropriate for their height, age and weight. Child safety restraints must be bought separately from your vehicle. Failure to follow these instructions and guidelines may result in an increased risk of serious injury or death to your child.



WARNING: All children are shaped differently. The National Highway Traffic Safety Administration and other safety organizations, base their recommendations for child restraints on probable child height, age and weight thresholds, or on the minimum requirements of the law. We recommend that you check with a NHTSA Certified Child Passenger Safety Technician (CPST) to make sure that you properly install the child restraint in your vehicle and that you consult your pediatrician to make sure you have a child restraint appropriate for your child. To locate a child restraint fitting station and CPST, contact NHTSA toll free at 1-888-327-4236 or go to www.nhtsa.dot.gov. In Canada, contact Transport Canada toll free at 1-800-333-0371 or go to www.tc.gc.ca to find a Child Car Seat Clinic in your area. Failure to properly restrain children in child restraints made especially for their height, age and weight, may result in an increased risk of serious injury or death to your child.



WARNING: On hot days, the temperature inside the vehicle can rise very quickly. Exposure of people or animals to these high temperatures for even a short time can cause death or serious heat related injuries, including brain damage. Small children are particularly at risk.



WARNING: Do not place a rearward facing child restraint in front of an active airbag. Failure to follow this instruction could result in personal injury or death.



WARNING: Properly secure children 13 years old and under in a rear seating position whenever possible. If you are unable to properly secure all children in a rear seating position, properly secure the largest child on the front seat. If you must use a forward facing child restraint on the front seat, move the seat as far back as possible. Failure to follow these instructions could result in personal injury or death.



WARNING: Always carefully follow the instructions and warnings provided by the manufacturer of any child restraint to determine if the restraint device is appropriate for your child's size, height, weight, or age. Follow the child restraint manufacturer's instructions and warnings provided for installation and use in conjunction with the instructions and warnings provided by your vehicle manufacturer. A safety seat that is improperly installed or utilized, is inappropriate for your child's height, age, or weight or does not properly fit the child may increase the risk of serious injury or death.

Child Safety

WARNING: Do not allow a passenger to hold a child on their lap when your vehicle is moving. Failure to follow this instruction could result in personal injury or death in the event of a sudden stop or crash.

WARNING: Do not use pillows, books or towels to boost your child's height. Failure to follow this instruction could result in personal injury or death.

WARNING: Properly secure child restraints or booster seats when they are not in use. They could become projectiles in a sudden stop or crash. Failure to follow this instruction could result in personal injury or death.

WARNING: Do not put the shoulder section of the seatbelt or allow the child to put the shoulder section of the seatbelt under their arm or behind their back. Failure to follow this instruction could reduce the effectiveness of the seatbelt and increase the risk of injury or death in a crash.

WARNING: Do not leave children or pets unattended in your vehicle. Failure to follow this instruction could result in personal injury or death.

When installing a child restraint with seatbelts:

- Place the vehicle seat in the upright position before you install the child restraint.
- Use the correct seatbelt buckle for that seating position.
- Insert the belt tongue into the buckle. Make sure the tongue is securely fastened in the buckle.

- Keep the buckle release button pointing up and away from the child restraint, with the tongue between the child restraint and the release button, to prevent accidental unbuckling.
- Put the seatbelt in the automatic locking mode.

CHILD RESTRAINT ANCHOR POINTS

WHAT ARE THE CHILD RESTRAINT ANCHOR POINTS

Anchor points allow you to quickly and safely install a child restraint.

LOCATING THE CHILD RESTRAINT LOWER ANCHOR POINTS

Second Row Bucket Seats and Third Row Seats

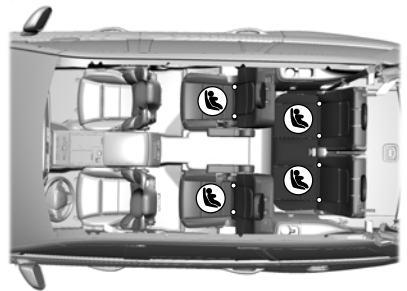

Second Row Bench Seats and Third Row Seats

Child Safety

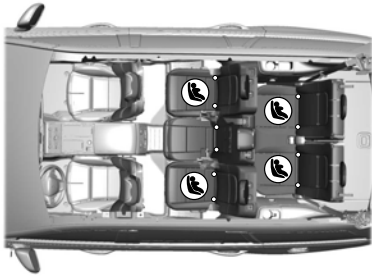

Second-Row Bench Seats and Third-Row Seats

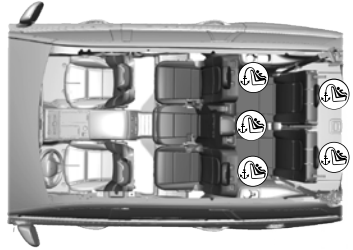

LOCATING THE CHILD RESTRAINT TOP TETHER ANCHOR POINTS

Second-Row Bucket Seats and Third-Row Seats

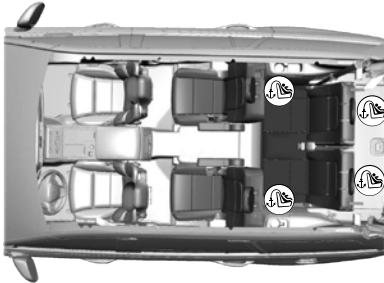

CHILD RESTRAINTS

CHILD RESTRAINT POSITION INFORMATION

Install the child restraint tightly against the vehicle seat. It may be necessary to lift or remove the head restraint.

Rear Facing Child Restraints

Combined Weight of Child and Child Restraint	LATCH (Lower Anchors Only)	Seatbelt Only
Up to 65 lb (29 kg)	X	X
Over 65 lb (29 kg)		X

Child Safety

Forward Facing Child Restraints

Combined Weight of Child and Child Restraint	LATCH (Lower Anchors and Top Tether Anchor)	Seatbelt and Top Tether Anchor	Seatbelt and LATCH (Lower Anchors and Top Tether Anchor)
Up to 65 lb (29 kg)	X	X	X
Over 65 lb (29 kg)		X	X

Child Safety

CHILD RESTRAINTS RECOMMENDATION

Child Size, Height, Weight, or Age	Recommended Restraint Type
Children weighing 40 lb (18 kg) or less (generally age four or younger).	Use a child restraint (sometimes called an infant carrier, convertible seat, or toddler seat).
Children who have outgrown or no longer properly fit in a child restraint (generally children who are less than 57 in (1.45 m) tall, are greater than age four and less than age 13, and between 40 lb (18 kg) and 80 lb (36 kg) and upward to 100 lb (45 kg) if recommended by your child restraint manufacturer).	Use a belt-positioning booster seat.
Children who have outgrown or no longer properly fit in a belt-positioning booster seat (generally children who are at least 57 in (1.45 m) tall or greater than 80 lb (36 kg) or 100 lb (45 kg) if recommended by child restraint manufacturer).	Use a vehicle seatbelt having the lap belt snug and low across the hips, shoulder belt centered across the shoulder and chest, and seat backrest upright.

You are required by law to properly use child restraints for infants and toddlers in the United States, Canada and Mexico.

Many states and provinces require that small children use approved booster seats until they reach age eight, a height of 57 in (1.45 m) tall, or 80 lb (36 kg). Check your local and state or provincial laws for specific requirements about the safety of children in your vehicle.

When possible, properly restrain children 13 years of age and under in a rear seating position of your vehicle. Accident statistics suggest that children are safer when properly restrained in the rear seating positions than in a front seating position.

When installing a rear facing child restraint, adjust the vehicle seats to avoid interference between the child restraint and the vehicle seat in front of the child restraint.

INSTALLING CHILD RESTRAINTS

USING SEATBELTS



WARNING: Depending on where you secure a child restraint, and depending on the child restraint design, you may block access to certain seatbelt buckle assemblies and LATCH lower anchors, rendering those features potentially unusable. To avoid risk of injury, make sure occupants only use seating positions where they are able to be properly restrained.

Note: *Although the child restraint illustrated is a forward facing child restraint, the steps are the same for installing a rear facing child restraint.*

Perform the following steps when installing a child restraint with seatbelts.

Child Safety

1. Position the child restraint in a seat with a seatbelt.



2. Pull down on the shoulder belt and then grasp the shoulder belt and lap belt together.



3. While holding the shoulder and lap belt portions together, route the tongue through the child restraint according to the child restraint manufacturer's instructions. Make sure you did not twist the belt webbing.

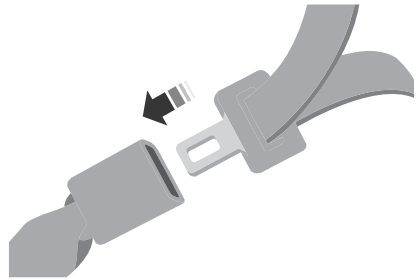

4. Insert the belt tongue into the proper buckle for that seating position until the latch engages. Make sure the tongue is latched securely by pulling on it.



5. To put the retractor in the automatic locking mode, grasp the shoulder portion of the belt and pull downward until you pull all of the seatbelt out.

Note: *The automatic locking mode is available on the front passenger and rear seats. This vehicle does not require the use of a locking clip.*

6. Allow the belt to retract to remove slack. The seatbelt clicks as it retracts to indicate it is in the automatic locking mode.

Child Safety

7. Pull the seatbelt out of the retractor to make sure the retractor is in the automatic locking mode. You should not be able to pull more belt out. If the retractor is not locked, unbuckle the belt and repeat Steps 5 and 6.



8. Remove remaining slack from the belt. Force the seat down with extra weight, for example, by pressing down or kneeling on the child restraint while pulling up on the shoulder belt in order to force slack from the belt. This is necessary to remove the remaining slack that exists once you add the extra weight of the child to the child restraint. It also helps to achieve the proper snugness of the child restraint to your vehicle. Sometimes, a slight lean toward the buckle helps to remove remaining slack from the belt.
9. If the child restraint has a tether strap, attach it.

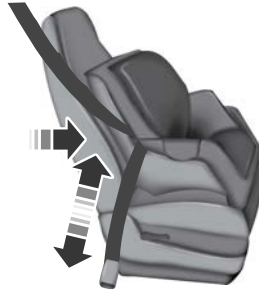

10. Before placing the child in the seat, forcibly move the seat forward and back to make sure the seat is securely held in place.

To check this, grab the seat at the belt path and attempt to move it side to side and forward and back. There should be no more than 1 in (2.5 cm) of movement.

We recommend checking with a NHTSA Certified Child Passenger Safety Technician to make certain the child restraint is properly installed. In Canada, check with Transport Canada for referral to a Child Car Seat Clinic.

USING LOWER ANCHORS AND TETHERS FOR CHILDREN



WARNING: Do not attach two child safety restraints to the same anchor. In a crash, one anchor may not be strong enough to hold two child safety restraint attachments and may break, causing serious injury or death.

Child Safety



WARNING: Depending on where you secure a child restraint, and depending on the child restraint design, you may block access to certain seatbelt buckle assemblies and LATCH lower anchors, rendering those features potentially unusable. To avoid risk of injury, make sure occupants only use seating positions where they are able to be properly restrained.

The Lower Anchors and Tethers for Children (LATCH) system has three vehicle anchor points:

- Two lower anchors where the vehicle seat backrest and seat cushion meet, called the seat bight.
- One top tether anchor behind that seating position.

LATCH compatible child restraints have two rigid or webbing mounted attachments. These attachments connect to the two lower anchors at the LATCH equipped seating positions in your vehicle. This type of attachment method eliminates the need to use seatbelts to attach the child restraint.

However, you can still use the seatbelt to attach the child restraint if the lower anchors are not used. For forward-facing child restraints, you must also attach the top tether strap to the proper top tether anchor if a top tether strap has been provided with your child restraint.

Follow the instructions later in this chapter on attaching child restraints with tether straps.

INSTALLING A CHILD RESTRAINT IN A CENTER SEAT



WARNING: The standardized spacing for LATCH lower anchors is 11 in (280 mm) center to center. Do not use LATCH lower anchors for the center seating position unless the child restraint manufacturer's instructions permit and specify using anchors spaced at least as far apart as those in this vehicle.

The lower anchors at the center of the second row bench seat are spaced 20 in (52 cm) apart. The standardized spacing for LATCH lower anchors is 11 in (28 cm) center to center.

You cannot install a child restraint with rigid LATCH attachments at the center seating position. You can only use LATCH compatible child restraints with attachments on belt webbing at this seating position provided that the child restraint manufacturer's instructions permit use with the anchor spacing stated.

Do not attach a child restraint to any lower anchor if another child restraint is attached to that anchor.

Each time you use the child restraint, check that the seat is properly attached to the lower anchors and tether anchor, if applicable. Tug the child restraint from side to side and forward and back where it is secured to the vehicle. The seat should move less than 1 in (2.5 cm).

If you did not properly anchor the child restraint, the risk of a child being injured in a crash greatly increases.

Child Safety

COMBINING THE SEATBELT AND LOWER ANCHORS FOR ATTACHING CHILD RESTRAINTS

When used in combination, you may attach either the seatbelt or the LATCH lower anchors first, provided a proper installation is achieved. Attach the tether strap afterward, if it is included with the child restraint.

USING TETHER STRAPS

Many forward-facing child restraints include a tether strap which extends from the back of the child restraint and hooks to an anchoring point called the top tether anchor. Tether straps are available as an accessory for many older child restraints.

Contact the manufacturer of your child restraint for information about ordering a tether strap, or to obtain a longer tether strap if the tether strap on your child restraint does not reach the appropriate top tether anchor in the vehicle.

Attach the tether strap only to the appropriate tether anchor. The tether strap may not work properly if attached somewhere other than the correct tether anchor.

If you install a child restraint with rigid LATCH attachments, do not tighten the tether strap enough to lift the child restraint off the vehicle seat cushion when the child is seated in it. Keep the tether strap just snug without lifting the front of the child restraint. Keeping the child restraint just touching the vehicle seat gives the best protection in a severe crash.

Once you have installed the child restraint using either the seatbelt, the lower anchors of the LATCH system, or both, you can attach the top tether strap.

Perform the following steps to install a child restraint with tether anchors:

For second row outermost seating positions, route the child restraint tether strap over the seat backrest, under the head restraint and between the head restraint posts. If needed, remove the head restraint to improve the fit of the child restraint or tether strap.

For the second row center seating position, route the child restraint tether strap over the top of the head restraint. If needed, remove the head restraint to improve the fit of the child restraint or tether strap. See **Head Restraint Components** (page 153).

For third row seating positions, route the child restraint tether strap over the seat backrest, under the head restraint and between the head restraint posts. If needed, fold the head restraint down to improve the fit of the child restraint or tether strap. See **Head Restraint Components** (page 153).

1. Route the tether strap.
2. Locate the correct anchor for the selected seating position.
3. Clip the tether strap to the anchor as shown. The tether hook may be twisted ½ turn to improve installation. If you clip the tether strap incorrectly, the child restraint may not be retained properly in the event of a crash.



E190833

Child Safety

4. Tighten the child restraint tether strap according to the manufacturer's instructions.

If the child restraint is not anchored properly, the risk of injury to a child greatly increases in a crash.

If your child restraint system has a tether strap, and the child restraint manufacturer recommends its use, we also recommend its use.

Note: *The cargo tie downs at the rear edge of the floor are not tether anchors.*

BOOSTER SEATS

Use a belt-positioning booster seat for children who have outgrown or no longer properly fit in a child restraint and meet the following criteria.

- Generally children who are less than 57 in (1.45 m) tall.
- Are greater than age four (4) and less than age twelve (12).
- Are between 40 lb (18 kg) and 80 lb (36 kg) and upward to 100 lb (45 kg).

Many state and provincial laws require that children use approved booster seats until they reach age eight, a height of 57 in (1.45 m) tall, or 80 lb (36 kg).

Booster seats should be used until you can answer yes to all of these questions when seated without a booster seat:

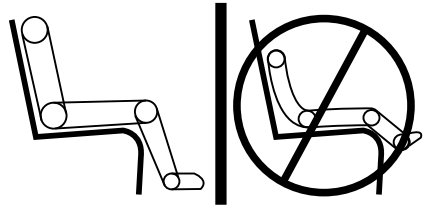

- Can the child sit all the way back against their vehicle seat backrest with knees bent comfortably at the edge of the seat cushion?
- Can the child sit without slouching?
- Does the lap belt rest low across the hips?
- Is the shoulder belt centered on the shoulder and chest?
- Can the child stay seated like this for the whole trip?

Always use booster seats in conjunction with your vehicle lap and shoulder belt.

Types of Booster Seats



- Backless booster seats

If your backless booster seat has a removable shield, remove the shield.

Child Safety

If a vehicle seating position has a low seat backrest or no head restraint, a backless booster seat may place your child's head, as measured at the tops of the ears, above the top of the seat. In this case, move the backless booster to another seating position with a higher seat backrest or head restraint and lap and shoulder belts, or consider using a high-back booster seat.



- High-back booster seats

If, with a backless booster seat, you cannot find a seating position that adequately supports your child's head, a high-back booster seat would be a better choice.

Children and booster seats vary in size and shape. Choose a booster that keeps the lap belt low and snug across the hips, never up across the stomach, and lets you adjust the shoulder belt to cross the chest and rest snugly near the center of the shoulder.

The following drawings compare the ideal fit to a shoulder belt uncomfortably close to the neck and a shoulder belt that could slip off the shoulder. The drawings also show how the lap belt should be low and snug across the child's hips.



Child Safety



If the booster seat slides on the vehicle seat upon which it is being used, placing a rubberized mesh sold as shelf or carpet liner under the booster seat may improve this condition. Do not use any item thicker than this under the booster seat. Check with the booster seat manufacturer's instructions.

CHILD SAFETY LOCKS



WARNING: You cannot open the rear doors from inside if you have put the child safety locks on.

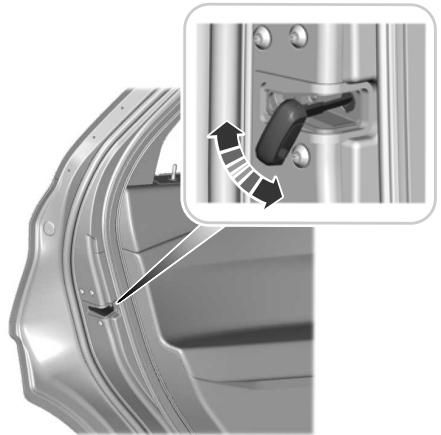

A child safety lock is on the rear edge of each rear door. You must set the child safety lock separately on each door.

Left-Hand Side

Turn the key clockwise to switch the child lock on and counter clockwise to switch it off.

Right-Hand Side

Turn the key counter clockwise to switch the child lock on and clockwise to switch it off.

Child Safety

Note: *To make sure the child safety lock is on, pull the inside door handle twice to verify the door does not open.*

Note: *To open the rear doors from inside the vehicle when the child lock is engaged, roll down the rear window and use the outside door handle. Or have someone outside the vehicle open the door.*

Seatbelts

SEATBELT PRECAUTIONS

 **WARNING:** Always drive and ride with your seatback upright and the lap belt snug and low across the hips.

 **WARNING:** Children must always be properly restrained.

 **WARNING:** Do not allow a passenger to hold a child on their lap when your vehicle is moving. Failure to follow this instruction could result in personal injury or death in the event of a sudden stop or crash.

 **WARNING:** All occupants of your vehicle, including the driver, should always properly wear their seatbelts, even when an airbag supplemental restraint system is provided. Failure to properly wear your seatbelt could seriously increase the risk of injury or death.

 **WARNING:** It is extremely dangerous to ride in a cargo area, inside or outside of a vehicle. In a crash, people riding in these areas are more likely to be seriously injured or killed. Do not allow people to ride in any area of your vehicle that is not equipped with seats and seatbelts. Make sure everyone in your vehicle is in a seat and properly using a seatbelt. Failure to follow this warning could result in serious personal injury or death.

 **WARNING:** In a rollover crash, an unbelted person is significantly more likely to die than a person wearing a seatbelt.

 **WARNING:** Each seating position in your vehicle has a specific seatbelt assembly made up of one buckle and one tongue designed to be used as a pair. Use the shoulder belt on the outside shoulder only. Never wear the shoulder belt under the arm. Never use a single seatbelt for more than one person.

 **WARNING:** Even with advanced restraints systems, properly restrain children 12 and under in a rear seating position. Failure to follow this could seriously increase the risk of injury or death.

 **WARNING:** Seatbelts and seats may be hot in a vehicle that is in the sunshine. The hot seatbelts or seats may burn a small child. Check seat covers and buckles before you place a child anywhere near them.

 **WARNING:** If your vehicle is involved in a crash, have the seatbelts and associated components inspected as soon as possible. Failure to follow this instruction could result in personal injury or death.

All seating positions in this vehicle have seatbelts. All occupants of the vehicle should properly wear their seatbelts, even when an airbag supplemental restraint system is provided.

The seatbelt system consists of:

- Lap and shoulder seatbelts.
- A shoulder seatbelt with automatic locking mode, except driver seatbelt.
- Height adjusters at the front outermost seating positions.
- Seatbelt pretensioners at the front outermost and second row outermost seating positions.

Seatbelts



A seatbelt warning light and tone.



Crash sensors and monitoring system with a readiness indicator.

The seatbelt pretensioners are designed to tighten the seatbelts when activated. In frontal and near-frontal crashes, the seatbelt pretensioners may be activated alone or, if the crash is of sufficient severity, together with the front airbags. In side crashes and rollovers, the pretensioners will be activated when the Safety Canopy is activated.

FASTENING AND UNFASTENING THE SEATBELTS

All seatbelts in your vehicle are a three-point combination lap and shoulder seatbelt.

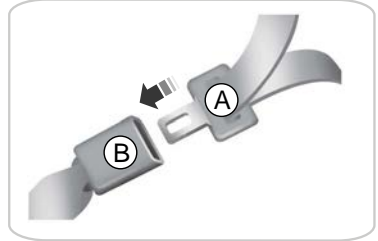

- A Seatbelt tongue.
- B Seatbelt buckle.

1. Pull the seatbelt out steadily.

Note: *It may lock if you pull it sharply or if the vehicle is on a slope.*

2. Insert the tongue into the buckle.
3. Pull the seatbelt tight to remove any slack.

Unfastening the Seatbelts

1. Press the red button on the buckle to release the seatbelt.
2. Hold the seatbelt tongue and let it retract completely and smoothly to its stowed position.

Seatbelts

SENSITIVE LOCKING MODE

WHAT IS SENSITIVE LOCKING MODE

Sensitive locking mode is a seatbelt retractor feature that allows shoulder belt length adjustment according to your movements and locking in response to vehicle movement.

HOW DOES SENSITIVE LOCKING MODE WORK

If the driver suddenly brakes, turns a corner sharply, or the vehicle receives an impact of about 5 mph (8 km/h) or more, the seatbelts lock to help reduce forward movement of the driver and passengers.

In addition, the seatbelt retractor locks if you pull the seatbelt webbing out too quickly. If the retractor locks, slowly lower the height adjuster to allow the seatbelt to retract.

If the retractor does not unlock, pull the seatbelt out slowly then feed a small length of webbing back toward the stowed position.

For rear seatbelts, recline the rear seat backrest or push the seat backrest cushion away from the seatbelt. Feed a small length of webbing back toward the stowed position.

AUTOMATIC LOCKING MODE

WHAT IS AUTOMATIC LOCKING MODE

This feature keeps the seatbelts pre-locked. The belt still retracts to remove any slack in the shoulder belt.

WHEN TO USE AUTOMATIC LOCKING MODE

Use this mode any time you install a child restraint in the front passenger seating position or any rear seating position. Properly restrain children 12 years old and under in a rear seat whenever possible.

Note: *Automatic locking mode is not available on the driver seatbelt.*

ENGAGING AUTOMATIC LOCKING MODE



1. Fasten the combination lap and shoulder belt.
2. Grasp the shoulder portion and pull downward until you pull the entire belt out.
3. Allow the belt to retract. As the belt retracts, you will hear a clicking sound. This indicates the seatbelt is now in the automatic locking mode.

DISENGAGING AUTOMATIC LOCKING MODE

Unbuckle the combination lap and shoulder belt and allow it to retract completely to disengage the automatic locking mode and activate the vehicle sensitive locking mode.

Seatbelts

ADJUSTING THE SEATBELTS DURING PREGNANCY



WARNING: Always ride and drive with your seatback upright and properly fasten your seatbelt. Fit the lap portion of the seatbelt snugly and low across the hips. Position the shoulder portion of the seatbelt across your chest. Pregnant women must follow this practice. See the following figure.

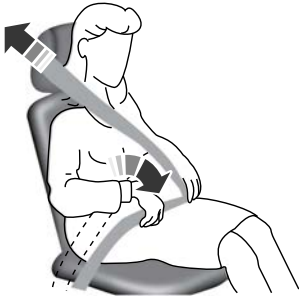

Pregnant women should always wear their seatbelt. Position the lap belt portion of a combination lap and shoulder belt low across the hips below the belly and worn as tight as comfort allows. Position the shoulder belt to cross the middle of the shoulder and the center of the chest.

ADJUSTING THE SEATBELT HEIGHT



WARNING: Position the seatbelt height adjuster so that the seatbelt rests across the middle of your shoulder. Failure to adjust the seatbelt correctly could reduce its effectiveness and increase the risk of injury in a crash.

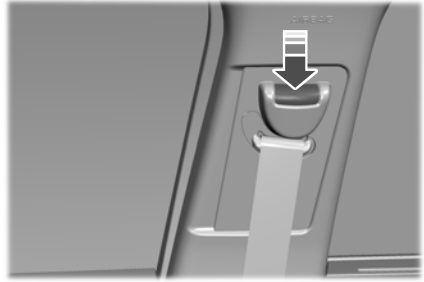

1. Press the button and slide the height adjuster up or down.
2. Release the button and pull down on the height adjuster to make sure it is locked in place.

SEATBELT REMINDER

HOW DOES THE SEATBELT REMINDER WORK



WARNING: The system will only provide protection when you use the seatbelt correctly.

This system monitors all seating positions and provides audio and graphic feedback.

SEATBELT REMINDER INDICATORS



This lamp illuminates if you do not fasten your seatbelt when you switch the ignition on. The lamp switches off when you fasten your seatbelt or about one minute has elapsed.

Seatbelts

When the initial warning expires for the driver, more warnings are provided for the driver and front passenger. This lamp illuminates if you or your front passenger do not fasten the seatbelt buckle and the vehicle speed exceeds 6 mph (10 km/h).

Note: To avoid inadvertent warnings, do not place large objects on the front passenger seat.



This lamp illuminates when you switch the ignition on, identifying the number of seating positions with fastened buckles. It illuminates again when a seating position changes from unfastened to fastened.



This warning displays if an occupant unfastens the rear seatbelt buckle or it becomes unfastened.

Note: If a rear seat is unoccupied, or an occupant never fastens the seatbelt buckle to begin with, the warning does not display.

Note: Front seating positions appear in this warning display. Warnings for unfastened front seatbelt buckles appear in the initial warning lamp.

Checking Seatbelt Status

To view the seatbelt status, use the instrument cluster display controls on the steering wheel.

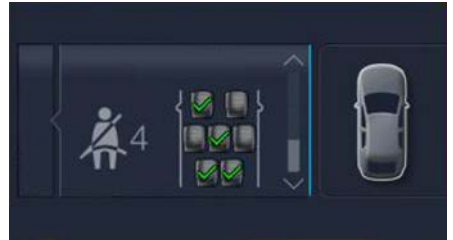

A



C



B



D

- A Seatbelt fastened.
- B Seatbelt not fastened.
- C Seatbelt recently unfastened.
- D Fault.

SEATBELT REMINDER AUDIBLE WARNINGS

A warning tone sounds if you do not fasten your seatbelt when you switch the ignition on. The tone switches off when you fasten your seatbelt or about one minute elapses.

When the initial warning expires for the driver, more warnings are provided for the driver and front passenger. This warning tone sounds if you or your front passenger do not fasten the seatbelt buckle and the vehicle speed exceeds 6 mph (10 km/h).

This tone also sounds if an occupant unfastens the rear seatbelt buckle or it becomes unfastened.

Seatbelts

SWITCHING THE SEATBELT REMINDER ON AND OFF



WARNING: While the system allows you to deactivate it, this system is designed to improve your chances of being safely belted and surviving an accident. We recommend you leave the system activated for yourself and others who may use the vehicle.

Note: *The driver and front passenger warnings switch off independently. When you perform this procedure for one seating position, do not buckle the other position as this cancels the process.*

Read Steps 1–4 before proceeding with the programming procedure.

Make sure that:

- You set the parking brake.
 - The transmission is in park (P).
 - The ignition is off.
 - You close all vehicle doors.
 - You unfasten the driver and front passenger seatbelts.
1. Switch the ignition on. Do not start the engine.
 2. Immediately start the deactivation or reactivation procedure in Step 3. Once you start Step 3, you must complete the procedure within 30 seconds.
 3. For the seating position you are switching off or on, fasten then unfasten the seatbelt four times at a moderate speed, ending in the unfastened state. The seatbelt warning light flashes for confirmation.

This switches the feature off for that seating position if it is currently on.

This switches the feature on for that seating position if it is currently off.

CHECKING THE SEATBELTS

Check the seatbelts and child restraints periodically to make sure they work properly and are not damaged. Make sure there are no nicks, tears or cuts. Replace if necessary.

Check the following seatbelt assemblies after a crash.

- Retractors.
- Buckles.
- Front seatbelt buckle assemblies.
- Shoulder belt height adjusters.
- Shoulder belt guide on seat backrest.
- Child restraint LATCH and tether anchors.
- Attaching hardware.

Read the child restraint manufacturer's instructions for additional inspection and maintenance information specific to the child restraint.

We recommend that all seatbelt assemblies in use in vehicles involved in a crash be replaced. However, if the crash was minor and an authorized dealer finds that the belts do not show damage and continue to operate properly, they do not need to be replaced. Seatbelt assemblies not in use during a crash should also be checked and replaced if either damage or improper operation is noted.

Properly care for seatbelts. See **Cleaning Seatbelts** (page 406).

SEATBELT EXTENSIONS



WARNING: Persons who fit into the vehicle's seatbelt should not use an extension. Unnecessary use could result in serious personal injury in the event of a crash.

Seatbelts



WARNING: Never use seatbelt extensions to install child restraints.



WARNING: Only use extensions provided by our dealers. The dealer will provide an extension designed specifically for this vehicle and seating position. The use of an extension intended for another vehicle, model year or seating position may not offer you the full protection of your vehicle's seatbelt restraint system.



WARNING: Do not use extensions to change the way the seatbelt fits across the torso, over the lap or to make the seatbelt buckle easier to reach.

If, because of body size or driving position, it is not possible to properly fasten the seatbelt over your lap and shoulder, an extension that is compatible with the seatbelts is available from our dealers. Only use our seatbelt extensions made by the original equipment seatbelt manufacturer with our seatbelts. Ask your authorized dealer if your extension is compatible with your vehicle restraint system.

Personal Safety System™

WHAT IS THE PERSONAL SAFETY SYSTEM

An advanced safety system that protects occupants in frontal crashes.

HOW DOES THE PERSONAL SAFETY SYSTEM WORK

This system provides an improved level of frontal crash protection to front seat occupants and is designed to reduce the risk of airbag-related injuries. The system analyzes occupant conditions and crash severity before activating the appropriate safety devices. During a crash, the restraints control module may deploy the seatbelt pretensioners, and one or both stages of the dual-stage airbags based on crash severity and occupant conditions.

PERSONAL SAFETY SYSTEM COMPONENTS

- Driver and passenger dual-stage airbag supplemental restraints.
- Front seat outermost seatbelts with pretensioners, energy management retractors and seatbelt usage sensors.
- Driver seat position sensor.
- Front passenger sensing system.
- Passenger airbag off and on indicators.
- Front crash severity sensors.
- Restraints control module with impact and safing sensors.
- Restraint system warning light and tone.
- The electrical wiring for the airbags, crash sensors, seatbelt pretensioners, front seatbelt usage sensors, driver seat position sensor, front passenger sensing system and indicator lights.

Airbags

HOW DO THE FRONT AIRBAGS WORK

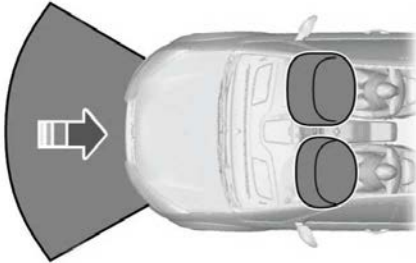

The driver and front passenger airbags deploy during significant frontal and near frontal crashes.

The driver and passenger front airbag system consists of:

- Driver and passenger airbag modules.
- Front passenger sensing system.
- Crash sensors and monitoring system with readiness indicator. See **Crash Sensors and Airbag Indicator** (page 62).

The airbags are a supplemental restraint system and are designed to work with the seatbelts to help protect the driver and right front passenger from certain upper body injuries. Airbags do not inflate slowly; there is a risk of injury from a deploying airbag.

Note: *You will hear a loud bang and see a cloud of harmless powdery residue if an airbag deploys. This is normal.*

The airbags inflate and deflate rapidly upon activation. After airbag deployment, it is normal to notice a smoke-like, powdery residue or smell the burnt propellant. This may consist of cornstarch, talcum powder (to lubricate the bag) or sodium

compounds (for example, baking soda) that result from the combustion process that inflates the airbag. Small amounts of sodium hydroxide may be present which may irritate the skin and eyes, but none of the residue is toxic.

Contact with a deploying airbag may cause abrasions or swelling. Temporary hearing loss is also a possibility as a result of the noise associated with a deploying airbag.

Because airbags must inflate rapidly and with considerable force, there is the risk of death or serious injuries such as fractures, facial and eye injuries or internal injuries, particularly to occupants who are not properly restrained or are otherwise out of position at the time of airbag deployment. Thus, it is extremely important that occupants be properly restrained as far away from the airbag module as possible.

Routine maintenance of the airbags is not required.

HOW DO THE SIDE AIRBAGS WORK

 **WARNING:** Do not place objects or mount equipment on or near the airbag cover, on the side of the front or rear seatbacks, or in areas that may come into contact with a deploying airbag. Failure to follow these instructions may increase the risk of personal injury in the event of a crash.

 **WARNING:** Accessory seat covers not released by Ford Motor Company could prevent the deployment of the airbags and increase the risk of injuries in a crash.

Airbags



WARNING: Do not lean your head on the door. The side airbag could injure you as it deploys from the side of the seatback.

The side airbags are on the outermost side of the seat backrests of the front seats. In certain sideways crashes or rollovers, the airbags will be inflated. The airbag was designed to inflate between the door panel and occupant to further enhance the protection provided to occupants in side impact crashes.



The system consists of the following:

- A label or embossed side panel indicating that side airbags are fitted to your vehicle.
- Side airbags inside the driver and front passenger seat backrests.
- Crash sensors and monitoring system with readiness indicator. See **Crash Sensors and Airbag Indicator** (page 62).

HOW DO THE KNEE AIRBAGS WORK - EXCLUDING: POLICE



WARNING: To reduce risk of injury, do not obstruct or place objects in the deployment path of the airbag.

A driver knee airbag is under or within the instrument panel.

During a crash, the restraints control module may activate the knee airbag based on crash severity and occupant conditions. Under certain crash and occupant conditions, the knee airbag may deploy but the driver front airbag may not activate.

As with front and side airbags, it is important that you are properly seated and restrained to reduce the risk of death or serious injury.



Make sure the knee airbag is operating properly. See **Crash Sensors and Airbag Indicator** (page 62).

HOW DO THE KNEE AIRBAGS WORK - POLICE



WARNING: To reduce risk of injury, do not obstruct or place objects in the deployment path of the airbag.



WARNING: Close the glove box door when your vehicle is moving. Failure to follow this instruction could reduce the effectiveness of the passenger knee airbag and increase the risk of injury in a crash.

The driver and passenger knee airbags are under or within the instrument panel.

Airbags

During a crash, the restraints control module may activate the driver and passenger knee airbags, individually or both, based on crash severity and respective occupant conditions. Under certain crash and occupant conditions, the driver and passenger knee airbags may deploy, but the corresponding front airbag may not activate.

As with front and side airbags, it is important that you are properly seated and restrained to reduce the risk of death or serious injury.



Make sure the knee airbags are operating properly. See **Crash Sensors and Airbag Indicator**

(page 63).

HOW DOES THE SAFETY CANOPY™ WORK



WARNING: Do not place objects or mount equipment on or near the headliner at the siderail that may come into contact with a deploying curtain airbag. Failure to follow these instructions may increase the risk of personal injury in the event of a crash.



WARNING: Do not lean your head on the door. The curtain airbag could injure you as it deploys from the headliner.



WARNING: To reduce risk of injury, do not obstruct or place objects in the deployment path of the airbag.

The Safety Canopy deploys during significant side crashes or when a certain likelihood of a rollover event is detected. The Safety Canopy is mounted to the roof side-rail sheet metal, behind the headliner, above each row of seats. In certain

sideways crashes or rollover events, the Safety Canopy will be activated, regardless of which seats are occupied. The Safety Canopy inflates between the side window area and occupants to further enhance protection provided in side impact crashes and rollover events.

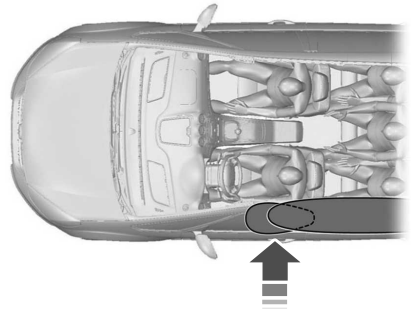

The system consists of the following:

- Safety Canopy curtain airbags above the trim panels over the front and rear side windows identified by a label or wording on the headliner or roof-pillar trim.
- A flexible headliner which opens above the side doors to allow air curtain deployment





- Crash sensors and monitoring system with a readiness indicator. See **Crash Sensors and Airbag Indicator** (page 62).

Properly restrain children 12 years old and under in the rear seats. The Safety Canopy will not interfere with children restrained using a properly installed child or booster seat because it is designed to inflate downward from the headliner above the doors along the side window opening.

Airbags

AIRBAG PRECAUTIONS

 **WARNING:** Airbags do not inflate slowly or gently, and the risk of injury from a deploying airbag is the greatest close to the trim covering the airbag module.

 **WARNING:** All occupants of your vehicle, including the driver, should always properly wear their seatbelts, even when an airbag supplemental restraint system is provided. Failure to properly wear your seatbelt could seriously increase the risk of injury or death.

 **WARNING:** Properly secure children 13 years old and under in a rear seating position whenever possible. If you are unable to properly secure all children in a rear seating position, properly secure the largest child on the front seat. If you must use a forward facing child restraint on the front seat, move the seat as far back as possible. Failure to follow these instructions could result in personal injury or death.

 **WARNING:** Do not place your arms on the airbag cover or through the steering wheel. Failure to follow this instruction could result in personal injury.

 **WARNING:** Keep the areas in front of the airbags free from obstruction. Do not affix anything to or over the airbag covers. Objects could become projectiles during airbag deployment. Failure to follow this instruction could result in personal injury or death.

 **WARNING:** To reduce risk of injury, do not obstruct or place objects in the deployment path of the airbag.

 **WARNING:** Do not place a rearward facing child restraint in front of an active airbag. Failure to follow this instruction could result in personal injury or death.

 **WARNING:** Do not attempt to service, repair, or modify the supplementary restraint system or associated components. Failure to follow this instruction could result in personal injury or death.

 **WARNING:** Several airbag system components get hot after inflation. To reduce the risk of injury, do not touch them after inflation.

 **WARNING:** If a supplementary restraint system component has deployed, it will not function again. Have the system and associated components inspected as soon as possible. Failure to follow this instruction could result in personal injury or death.

PROPERLY ADJUSTING THE DRIVER AND FRONT PASSENGER SEATS

 **WARNING:** National Highway Traffic Safety Administration (NHTSA) recommends a minimum distance of at least 10 in (25 cm) between an occupant's chest and the driver airbag module.

Airbags

To properly position yourself away from the airbag:

- Move your seat to the rear as far as you can while still reaching the pedals comfortably.
- Recline the seat slightly one or two degrees from the upright position.

After all occupants have adjusted their seats and put on seatbelts, it is very important that they continue to sit properly. Properly seated occupants sit upright, lean against the seat backrest, and center themselves on the seat cushion, with their feet comfortably extended on the floor. Sitting improperly can increase the chance of injury in a crash event. For example, if an occupant slouches, lies down, turns sideways, sits forward, leans forward or sideways, or puts one or both feet up, the chance of injury during a crash greatly increases.

CHILDREN AND AIRBAGS



WARNING: Do not place a rearward facing child restraint in front of an active airbag. Failure to follow this instruction could result in personal injury or death.



Children must always be properly restrained. Accident statistics suggest that children are safer when properly restrained in the rear seating positions than in the front seating position. Failure to follow these instructions may increase the risk of injury in a crash.

If two adults and a child occupy a vehicle without rear seats, properly restrain the child in the center front seat unless doing so would interfere with driving your vehicle. This provides lap and shoulder belt protection for all occupants, and airbag protection for the adults. A child or infant properly restrained in the center front seat should have a reduced risk to serious injury from the airbags.

FRONT PASSENGER SENSING SYSTEM

WHAT IS THE FRONT PASSENGER SENSING SYSTEM

This system detects a properly seated occupant and determines if the front passenger airbag should be enabled.

HOW DOES THE FRONT PASSENGER SENSING SYSTEM WORK

The system uses a passenger airbag status indicator which illuminates indicating that the front passenger frontal airbag is either enabled or disabled.

Note: When you first switch the ignition on, the passenger airbag status indicator off and on lamps illuminate for a short period to confirm they are functional.

Airbags



The indicator lamps are in the center stack of the instrument panel.

The front passenger sensing system is designed to disable the front passenger frontal airbag under these conditions:

- The front passenger seat is unoccupied.
- The system determines an infant is present in a child restraint.
- A passenger takes their weight off of the seat for a period of time.
- If there is a problem with the airbag system or the passenger sensing system.

Note: *Even with this technology, parents are strongly encouraged to always properly restrain children in the rear seat.*

- When the front passenger sensing system disables the front passenger frontal airbag, the passenger airbag status indicator illuminates the off lamp.
- If you have installed the child restraint and the passenger airbag status indicator illuminates the on lamp, switch your vehicle off, remove the child restraint from your vehicle and reinstall the restraint following the child restraint manufacturer's instructions.

The front passenger sensing system works with sensors that are part of the front passenger seat and seatbelt. The sensors are designed to detect the presence of a properly seated occupant and determine if the front passenger frontal airbag should be enabled.

- When the front passenger sensing system enables the front passenger frontal airbag, the passenger airbag status indicator illuminates the on lamp.

If a person of adult size is sitting in the front passenger seat, but the passenger airbag status indicator off lamp is illuminated, it is possible that the person is not sitting properly in the seat. If this happens:

- Switch your vehicle off and ask the person to place the seat backrest in an upright position.
- Have the person sit upright in the seat, centered on the seat cushion, with the person's legs comfortably extended.
- Restart your vehicle and have the person remain in this position for about two minutes. This allows the system to detect that person and enable the passenger frontal airbag.
- If the indicator off lamp remains illuminated even after this, you should advise the person to ride in the rear seat.

After all occupants have adjusted their seats and put on seatbelts, it is very important that they continue to sit upright, leaning against the seat backrest, and centered on the seat cushion, with their feet comfortably extended on the floor.

Sitting improperly can increase the chance of injury in a crash event. For example, if an occupant slouches, lies down, turns sideways, sits forward, leans forward or sideways, or puts one or both feet up, the chance of injury during a crash greatly increases.

If you think that the state of the passenger airbag status indicator lamp is incorrect, check for the following:

- Objects lodged underneath the seat.
- Objects between the seat cushion and the center console.

Airbags

- Objects hanging off the seat backrest.
- Objects stowed in the seat backrest map pocket.
- Objects placed on the occupant's lap.
- Cargo interference with the seat
- Other passengers pushing or pulling on the seat.
- Rear passenger feet and knees resting or pushing on the seat.

The listed conditions could cause the weight of a properly seated occupant to be incorrectly interpreted by the front passenger sensing system. The person in the front passenger seat could appear heavier or lighter due to the conditions listed.



Make sure the front passenger sensing system is operating properly. See **Crash Sensors and Airbag Indicator** (page 62).

If the airbag readiness light is on, do the following:

- Pull your vehicle over.
- Switch your vehicle off.
- Check for any objects lodged underneath the front passenger seat or cargo interfering with the seat.
- Remove the obstruction if found.
- Restart your vehicle.
- Wait at least two minutes and verify that the airbag readiness light in the instrument cluster is no longer illuminated.
- If the airbag readiness light in the instrument cluster remains illuminated, there may be a problem due to the front passenger sensing system.

Do not attempt to repair or service the system. Take your vehicle in for service immediately.

If it is necessary to modify an advanced front airbag system to accommodate a person with disabilities, contact your Customer Relationship Center. See **Contacting Us** (page 15).

FRONT PASSENGER SENSING SYSTEM PRECAUTIONS



WARNING: Sitting improperly, out of position or with the seatback reclined too far can take weight off the seat cushion and affect the decision of the passenger sensing system, resulting in serious injury or death in the event of a crash. Always sit upright against your seat back, with your feet on the floor.



WARNING: Any alteration or modification to the front passenger seat may affect the performance of the front passenger sensing system. This could seriously increase the risk of injury or death.



WARNING: Do not place objects under the front passenger seat or between the seat and the center console. Failure to follow this instruction may interfere with the front passenger seat sensing system and increase the risk of injury or death in a crash.



WARNING: Check the passenger airbag indicator lamp for proper airbag status. Failure to follow this instruction could result in personal injury or death.

Airbags

FRONT PASSENGER SENSING SYSTEM INDICATORS

Occupant	Passenger Airbag Status Indicator	Passenger Airbag
Empty	OFF: Illuminated	Disabled
	ON: Not Illuminated	
Child	OFF: Illuminated	Disabled
	ON: Not Illuminated	
Adult	OFF: Not Illuminated	Enabled
	ON: Illuminated	

CRASH SENSORS AND AIRBAG INDICATOR - EXCLUDING: POLICE



WARNING: Modifying or adding equipment to the front of your vehicle could affect the performance of the airbag system, increasing the risk of injury. This includes the hood, bumper system, frame, front body structure, tow hooks, hood pins, push bar and snowplows.

Your vehicle has a collection of crash and occupant sensors. These sensors provide information to the restraints control module which activates the following:

- Front seatbelt pretensioners.
- Driver airbag.
- Passenger airbag.
- Knee airbag(s).
- Seat mounted side airbags.
- Safety Canopy.

Based on the type of crash, the restraints control module deploys the appropriate safety devices.

The restraints control module also monitors the readiness of the above safety devices plus the crash and occupant sensors. The readiness of the safety system is indicated by a warning indicator light in the instrument cluster or by a backup tone if the warning light is not working. Routine maintenance of the airbag is not required.

A difficulty with the system is indicated by one or more of the following:



The readiness light will not illuminate immediately after you switch the ignition on.

- The readiness light either flashes or stays on.
- You hear a series of five tones. The tone pattern repeats periodically until the problem, the light or both are repaired.

If any of these things happen, even intermittently, have the supplemental restraint system serviced immediately. Unless serviced, the system may not function properly in the event of a crash.

Airbags

The fact that the seatbelt pretensioners or front airbags did not activate for both front seat occupants in a crash does not mean that something is wrong with the system. Rather, it means the restraints control module determined the accident conditions (crash severity, seatbelt usage) were not appropriate to activate these safety devices.

- The front airbags activate only in frontal and near-frontal crashes. Front airbags may activate in rollovers, side impacts or rear impacts if the crash causes sufficient frontal deceleration.
- The seatbelt pretensioners activate in frontal, near-frontal and side crashes, and in rollovers.
- The side airbags inflate in certain side impact crashes or rollover events. Side airbags may activate in other types of crashes if the vehicle experiences sufficient sideways motion or deformation.
- The knee airbag(s) may deploy based on crash severity and occupant conditions.
- The Safety Canopy inflates in certain side impact crashes or rollover events. The Safety Canopy may activate in other types of crashes if the vehicle experiences sufficient sideways motion or deformation, or a certain likelihood of rollover.

CRASH SENSORS AND AIRBAG INDICATOR - POLICE



WARNING: Modifying or adding equipment to the front of your vehicle could affect the performance of the airbag system, increasing the risk of injury. This includes the hood, bumper system, frame, front body structure, tow hooks, hood pins, push bar and snowplows.

Your vehicle has a collection of crash and occupant sensors. These sensors provide information to the restraints control module which activates the following:

- Seatbelt pretensioners.
- Driver airbag.
- Passenger airbag.
- Knee airbag(s).
- Seat mounted side airbags.
- Safety Canopy.

Based on the type of crash, the restraints control module deploys the appropriate safety devices.

The restraints control module also monitors the readiness of the above safety devices plus the crash and occupant sensors. The readiness of the safety system is indicated by a warning indicator light in the instrument cluster or by a backup tone if the warning light is not working. Routine maintenance of the airbag is not required.

A difficulty with the system is indicated by one or more of the following:

- The readiness light either flashes or stays on.
- You hear a series of five tones. The tone pattern repeats periodically until the problem, the light or both are repaired.

Airbags



- The readiness light will not illuminate immediately after you switch the ignition on.

If any of these things happen, even intermittently, have the supplemental restraint system serviced at an authorized dealer immediately. Unless serviced, the system may not function properly in the event of a crash.

The seatbelt pretensioners and the airbag supplemental restraint system are designed to activate when the vehicle sustains frontal or sideways deceleration sufficient to cause the restraints control module to deploy a safety device or when a certain likelihood of a rollover event is detected by the rollover sensor.

The fact that the seatbelt pretensioners or airbags did not activate for both front seat occupants in a crash does not mean that something is wrong with the system. Rather, it means the restraints control module determined the accident conditions (crash severity, belt usage) were not appropriate to activate these safety devices.

- The front airbags activate only in frontal and near-frontal crashes (not rollovers, side impacts or rear impacts) unless the crash causes sufficient frontal deceleration.
- The seatbelt pretensioners activate in frontal, near-frontal and side crashes and in rollovers.
- The side airbags inflate in certain side impact crashes and in rollovers. Side airbags may activate in other types of crashes if the vehicle experiences sufficient sideways motion or deformation.

- The knee airbag(s) may deploy based on crash severity and occupant conditions.
- The Safety Canopy inflates in certain side impact crashes or rollover events. The Safety Canopy may activate in other types of crashes if the vehicle experiences sufficient sideways motion or deformation, or a certain likelihood of rollover.

Airbags and Police Equipment



WARNING: Do not place objects or mount equipment on or near the airbag cover, on the side of the front or rear seatbacks, or in areas that may come into contact with a deploying airbag. Failure to follow these instructions may increase the risk of personal injury in the event of a crash.



WARNING: Keep the areas in front of the airbags free from obstruction. Do not affix anything to or over the airbag covers. Objects could become projectiles during airbag deployment. Failure to follow this instruction could result in personal injury or death.

Dual driver and passenger airbags, side airbags and knee airbags affect the way police equipment can be mounted in police vehicles.

Any surfaces that could come into contact with an airbag, once it has deployed, must not damage the airbag or alter its deployment path.

Airbags

Once the airbag has fully deployed, any peripheral equipment surfaces that could come into contact with the airbag (such as when the airbag deflates with the loading of an occupant) must not damage the airbag or alter its deployment path. Sharp edges, corners or protrusions could damage the nylon airbag material and reduce the effectiveness of the airbag.

Some approximate dimensions for airbags, at full inflation, are provided. These dimensions are somewhat flexible and represent free form deployments without the loading of occupants. The shaded areas in Figures 8 through 10 represent available police equipment mounting zones. These zones are shown for police vehicles with standard bucket seats. The zone dimensions provided in Figures 8 through 10 are approximate and will vary with the loading of occupants in the seats.

All airbag and equipment mounting zone dimensions are approximate due to different airbag deployment characteristics.

Do not mount equipment between the side of the front seat and the door trim that will block deployment of the side airbag.

Do not mount equipment between the seats and the body side as shown in Figure 7 that would prevent the side curtain airbag from achieving occupant coverage.

Figure 1 (Driver and Passenger Airbag Dimensions)

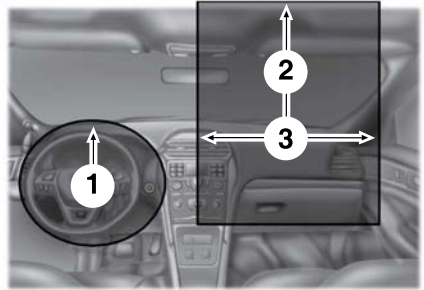

1. 9.5 in (240 mm) from center of emblem.
2. 13.8 in (350 mm) from center of airbag door.
3. 28.3 in (720 mm).

Note: No objects should be placed between the airbags due to airbag variability.

Figure 2 (Side View of Driver Airbag at Full Inflation)

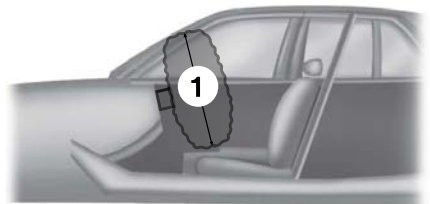

1. 27.5 in (700 mm).

Airbags

Figure 3 (Top View of Driver and Passenger Airbags at Full Inflation)

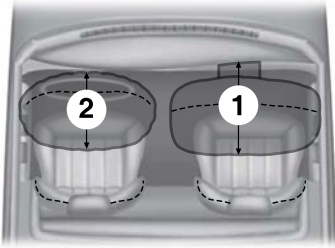

1. Front passenger airbag - 22.8 in (580 mm).
2. Front driver airbag - 17 in (430 mm).

Note: No objects should be placed between the driver side steering wheel airbag and the passenger side dash airbag.

Figure 4 (Top View of Side Airbags at Full Inflation-If equipped)

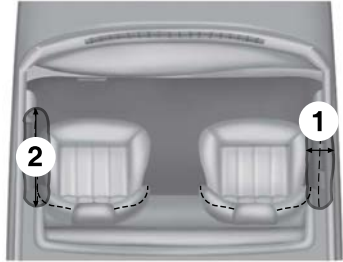

1. From outermost side of seat - 8 in (200 mm).
2. Forward of seat backrest - 15 in (380 mm).

Figure 5 (Side View of Side Airbag at Full Inflation-If equipped)

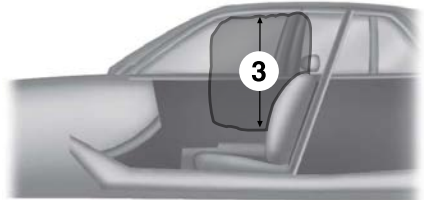

3. Up from side airbag module - 27.5 in (700 mm).

Airbags

Figure 6 (Side View of Side Curtain Dimension)

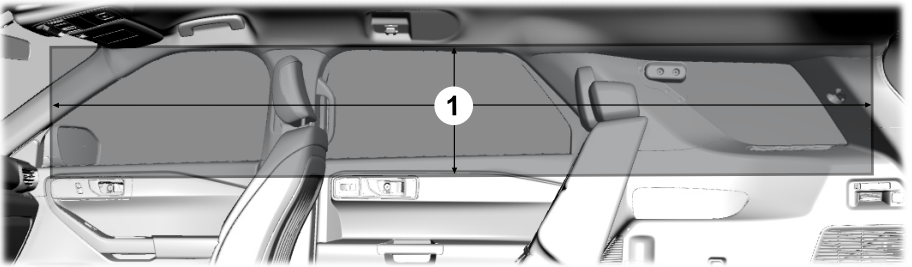

1. Roof rail to 1 in (25mm) below window sill.

Note: No objects should be placed on the headliner or pillar trims (A through D) used to conceal the airbag when stowed.

Figure 7 (Front View of Side Curtain at Full Inflation)

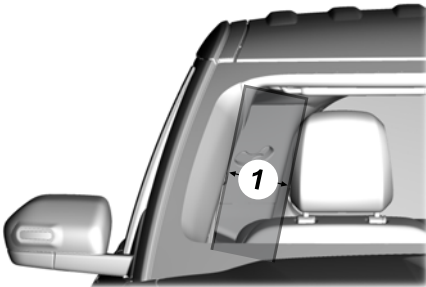

1. 6 in (75mm) from pillar trim (A through D).

Figure 8 (Equipment Mounting Zones)

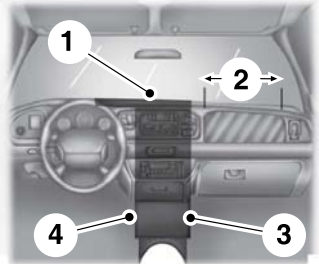

1. Area on top of the instrument panel (**Note:** Equipment must not interfere with driver visibility).
2. Airbag door must be kept clear for deployment of the airbag.
3. Area in front of the center console from the bottom to the top of the instrument panel.
4. Area in front of electronic finish panel from the bottom to the top of the instrument panel.

Airbags

Figure 9 (Equipment Mounting Zones)

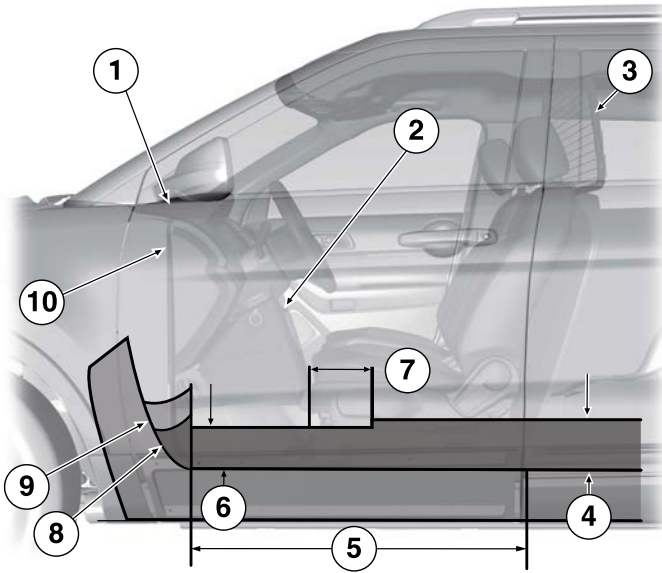

1. Area on top of instrument panel.
2. Area in front of center console from tunnel up to instrument panel.
3. Prisoner screen (reference only).
4. 10 in (254 mm).
5. Area on tunnel between seats.
6. Height: 8.5 in (216 mm).
7. 12 in (305 mm).
8. Area on tunnel beneath center console.
9. Tunnel.
10. Depth: 1.5 in (38 mm).

Airbags

Figure 10 (Top View of Equipment Mounting Zones)

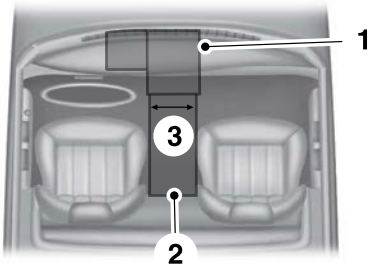

1. Area on top of the instrument panel. **Note:** Equipment must not interfere with driver visibility.
2. Area on tunnel between seats.
3. 9 in (229 mm).

DISPOSING OF AIRBAGS

Contact your authorized dealer as soon as possible. Airbags must be disposed of by qualified personnel.

Pedestrian Alert System

WHAT IS THE PEDESTRIAN ALERT SYSTEM

Due to the quiet operation of hybrid and electric vehicles at low speeds, the system creates a subtle sound to alert pedestrians.

The system is on when your vehicle is running and not in park (P). Some sound may be audible in the passenger compartment.

911 Assist (If Equipped)

WHAT IS 911 ASSIST

911 Assist is a feature that can call for help.

For more information, visit <https://www.owner.ford.com>.

HOW DOES 911 ASSIST WORK

If a crash deploys an airbag, excluding knee airbags and rear inflatable seatbelts, or activates the fuel pump shut-off, your vehicle may be able to contact emergency services by dialing 911 through a paired and connected **Bluetooth®** enabled phone.

Not all crashes deploy an airbag or activate the fuel pump shut-off. If a connected cell phone sustains damage or loses its connection to the operating system during a crash, the system searches for and tries to connect to a previously paired cell phone. The 911 Assist feature attempts to call the emergency services.

Before making the call:

- 911 Assist feature provides about 10 seconds to cancel the call. If you fail to cancel the call, the system attempts to dial 911.
- 911 Assist says the following, or a similar message: the system will attempt to call 911, to cancel the call, press Cancel on your screen or press and hold the phone button on your steering wheel.

If you do not cancel the call, 911 Assist makes a successful call a pre-recorded message plays for the 911 operator. The occupants in your vehicle are able to talk with the operator. Be prepared to provide your name, phone number and location immediately because not all 911 systems are capable of receiving this information electronically.

During an emergency call the system transmits vehicle data to the emergency service.

EMERGENCY CALL REQUIREMENTS



WARNING: Do not wait for 911 Assist to make an emergency call if you can do it yourself. Dial emergency services immediately to avoid delayed response time which could increase the risk of serious injury or death after a crash. If you do not hear 911 Assist within five seconds of the crash, the system or phone may be damaged or non-functional.



WARNING: Always place your phone in a secure location in your vehicle so it does not become a projectile or get damaged in a crash. Failure to do so may cause serious injury to someone or damage the phone which could prevent 911 Assist from working properly.



WARNING: Unless the 911 Assist setting is set on before a crash, the system will not dial for help which could delay response time, potentially increasing the risk of serious injury or death after a crash.

- The operating system must be powered and working properly at the time of the incident and throughout feature activation and use.
- The 911 Assist feature must be set on before the incident.
- You must pair and connect a **Bluetooth®** enabled and compatible cell phone to the operating system.

911 Assist (If Equipped)

- A connected **Bluetooth**® enabled phone must have the ability to make and maintain an outgoing call at the time of the incident.
- A connected **Bluetooth**® enabled phone must have adequate network coverage, battery power and signal strength.
- The vehicle must have battery power and be located in the U.S., Canada or in a territory in which 911 is the emergency number.

Note: *If any user sets 911 Assist to on or off, that setting applies for all paired phones. If 911 Assist is switched off and the phone is connected to the operating system, an icon displays on the status bar.*

Note: *Every phone operates differently. While 911 Assist works with most cellular phones, some may have trouble using this feature.*

EMERGENCY CALL LIMITATIONS

The 911 Assist feature only operates in the U.S., Canada or in a territory in which 911 is the emergency number.

This feature does not operate properly if:

- Your cellular phone or 911 Assist hardware sustains damage in a crash.
- The vehicle's battery or the operating system has no power.
- The phone(s) thrown from your vehicle are the ones paired and connected to the system.

Keys and Remote Controls

REMOTE CONTROL LIMITATIONS



WARNING: Changes or modifications not expressly approved by the party responsible for compliance could void the user's authority to operate the equipment. The term "IC:" before the radio certification number only signifies that Industry Canada technical specifications were met.

This device complies with Part 15 of the FCC Rules and with Industry Canada license-exempt RSS standard(s). Operation is subject to the following two conditions: (1) This device may not cause harmful interference, and (2) This device must accept any interference received, including interference that may cause undesired operation.

Make sure a valid remote control is within 3 ft (1 m) from the front door handles and rear of vehicle.

The system may not function if:

- The remote control remains stationary for about a minute.
- The vehicle battery has no charge.
- The remote control battery has no charge.
- There is interference causing issues with the remote control frequencies.
- The remote control is too close to metal objects or electronic devices, for example keys or a cell phone.

USING THE REMOTE CONTROL - EXCLUDING: POLICE



WARNING: Do not leave a key or remote control unattended in the vehicle. Children or pets could operate the power windows, moonroof or other controls. Failure to follow this instruction could result in personal injury or death.

Use your remote control to access various vehicle systems.

Note: *The buttons on your remote may vary depending on the vehicle region or options.*

Unlock



Press the button to unlock all doors. See **Unlocking and Locking the Doors Using the Remote Control** (page 81).

Lock



Press the button to lock all doors. See **Unlocking and Locking the Doors Using the Remote Control** (page 81).

Remote Start (If Equipped)



Press the button twice within three seconds to remote start. See **Using Remote Start** (page 137).

Opening and Closing the Liftgate



Press the button twice within three seconds to open and close the liftgate. See **Opening the Liftgate Using the Remote Control** (page 95).

Keys and Remote Controls

Panic Alarm (if Equipped)



Press the button to sound the panic alarm. See **Sounding the Panic Alarm** (page 75).

USING THE REMOTE CONTROL - POLICE



WARNING: Do not leave a key or remote control unattended in the vehicle. Children or pets could operate the power windows, moonroof or other controls. Failure to follow this instruction could result in personal injury or death.



Note: If there is a problem with the remote entry system, take all remote controls with you to an authorized dealer to troubleshoot the problem.

Unlock



Press the button to unlock all the doors.

Lock



Press the button to lock all the doors.

Releasing the Liftgate (if Equipped)



Press the button once to release the lock.

Note: The liftgate release button starts a 45 second lock release timer.

Note: Be careful when opening or closing the liftgate in a garage or other enclosed area to avoid damaging the liftgate.

REMOVING THE KEY BLADE



Push the release button on your passive key and pull the key blade out.

Keys and Remote Controls

SOUNDING THE PANIC ALARM - EXCLUDING: POLICE



Press the button to sound the panic alarm. Press the button again, or switch the ignition on to turn it off.

Note: *The panic alarm only operates when the ignition is off.*

SOUNDING THE PANIC ALARM - POLICE



Panic alarm button on police key fobs is disabled from functioning.

Note: *The panic alarm only operates when the ignition is off.*

LOCATING YOUR VEHICLE



Press the lock button twice within three seconds. The turn signal lamps flash.

Note: *We recommend you use this method to locate your vehicle.*

CHANGING THE REMOTE CONTROL BATTERY - VEHICLES WITH: PUSH BUTTON START, EXCLUDING: POLICE



WARNING: Keep batteries away from children to prevent ingestion. Failure to follow this instruction could result in personal injury or death. If ingested, immediately seek medical attention.



WARNING: If the battery compartment does not securely close, stop using the remote control and replace it as soon as possible. In the meantime, keep the remote control away from children. Failure to follow this instruction could result in personal injury or death.

The remote control uses one coin-type 3-volt lithium battery CR2450 or equivalent.



1. Push the release button and pull the key blade out.

Keys and Remote Controls

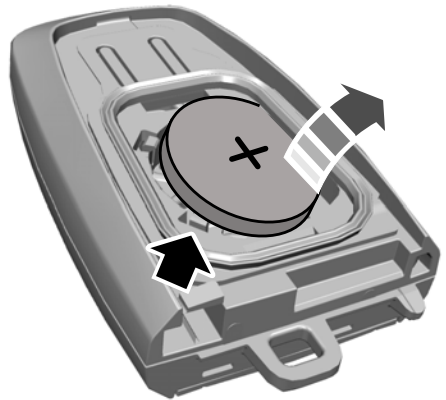
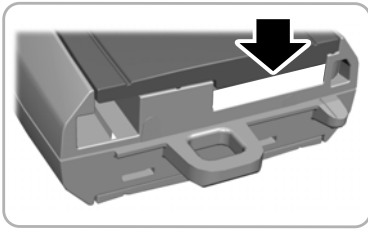

2. Twist a thin coin under the tab hidden behind the key blade head to remove the battery cover.

3. Insert a screwdriver, and carefully remove the battery.
4. Install a new battery with the + facing upward.
5. Reinstall the battery housing cover onto the transmitter and install the key blade.



Dispose of old batteries in an environmentally friendly way. Seek advice from your local authority about recycling old batteries.

Note: Do not wipe off any grease on the battery terminals or on the back surface of the circuit board.

Note: Replacing the battery does not erase the programmed key from your vehicle. The remote control should operate normally.

Keys and Remote Controls

CHANGING THE REMOTE CONTROL BATTERY - POLICE

WARNING: Keep batteries away from children to prevent ingestion. Failure to follow this instruction could result in personal injury or death. If ingested, immediately seek medical attention.

WARNING: If the battery compartment does not securely close, stop using the remote control and replace it as soon as possible. In the meantime, keep the remote control away from children. Failure to follow this instruction could result in personal injury or death.

The remote control uses one coin-type three-volt lithium battery CR2032 or equivalent.



Make sure you dispose of old batteries in an environmentally friendly way. Seek advice from local authorities about recycling old batteries.



1. Twist a thin coin in the slot of the remote control near the key ring to remove the battery cover.

Note: Do not remove the rubber cover and circuit board from the front housing of the remote control.

Note: Do not wipe off any grease on the battery terminals or on the back surface of the circuit board.

2. Remove the old battery.
3. Insert the new battery. Refer to the symbols inside the remote control for the correct orientation of the battery. Press the battery down to make sure you have it fully seated in the housing.
4. Reinstall the battery housing cover onto the remote control.

Note: Replacing the battery does not erase the programmed key from your vehicle. The remote control operates normally.

Keys and Remote Controls

REPLACING A LOST KEY OR REMOTE CONTROL

You can purchase replacement keys or remote controls from an authorized dealer. Authorized dealers can program remote controls for your vehicle.



Note: Your vehicle keys came with a security label that provides important key cut information. Keep the label in a safe place for future reference.

PROGRAMMING THE REMOTE CONTROL

General Information

You must have two previously programmed remote controls inside your vehicle and the new unprogrammed remote controls readily accessible. Contact an authorized dealer to have the spare remote control programmed if two previously programmed remotes are not available. Make sure that your vehicle is off before beginning this procedure. Make sure that you close all the doors before beginning and that they remain closed throughout the procedure. Perform all steps within 30 seconds of starting the sequence. Stop and wait for at least one minute before starting again if you perform any steps out of sequence.

Read and understand the entire procedure before you begin.

Note: You can program a maximum of four remote controls to your vehicle.

Note: If your programmed remote controls are lost or stolen and you do not have an extra coded remote, you need to have your vehicle towed to an authorized dealer. Store an extra programmed remote away from your vehicle in a safe place to help prevent any inconvenience. Contact an authorized dealer to purchase additional spare or replacement remotes.

Steps for Programming Your Spare Remote Control

Note: Your vehicle is equipped with one of the following center consoles.

Programming Backup Location

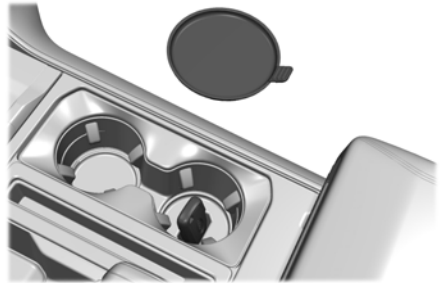

Keys and Remote Controls

1. Place the first programmed remote in the backup slot inside the cup holder or center console with your foot off the brake pedal, press and release the push button ignition switch.
2. Wait five seconds and then press and release the push button ignition switch again.
3. Remove the remote control.
4. Within 10 seconds, place a second programmed remote control in the backup slot. Press and release the push button ignition switch.
5. Wait five seconds and then press and release the push button ignition switch again. Keep the ignition on for at least three seconds, but no more than 10 seconds.
6. Remove the remote control.
7. Place the unprogrammed remote control in the backup slot and press and release the push button ignition switch.

Programming is now complete. With your foot on the brake pedal, press the push button ignition switch to verify the remote control functions operate and your vehicle starts with the new remote control.

If programming was not successful, wait 10 seconds and repeat Steps 1 through 7. If you are still unsuccessful, take your vehicle to an authorized dealer.

KEYS AND REMOTE CONTROLS AUDIBLE WARNINGS - EXCLUDING: POLICE

Sounds when you open the driver's door, turn off the vehicle and you have left the key in the ignition.

KEYS AND REMOTE CONTROLS AUDIBLE WARNINGS - POLICE

Key In Reminder

Sounds when the following conditions are met:

- Vehicle is out of park (P).
- You switch the vehicle off.
- You open the driver's door.
- You have left the key inside the vehicle.

USING THE VALET MODE

What is Valet Mode

The valet mode allows you to limit the access of some features on the touchscreen.

Enabling Classic Valet Mode

Make sure the remote control is in your vehicle.

1. From the settings menu, press Valet Mode.
2. Enter a four digit code to lock the touchscreen.
3. Re-enter the same four digit code to complete enabling valet mode.

Disabling Classic Valet Mode

1. Press Exit Valet Mode.
2. Enter your four digit code to disable valet mode and unlock the touchscreen.

Keys and Remote Controls

KEYS AND REMOTE CONTROLS – TROUBLESHOOTING

KEYS AND REMOTE CONTROLS – INFORMATION MESSAGES

Message	Details
Key Battery Low Replace Soon	Replace remote control battery.

Doors and Locks

OPERATING THE DOORS FROM OUTSIDE YOUR VEHICLE

UNLOCKING AND LOCKING THE DOORS USING THE REMOTE CONTROL

You can only use the remote control when your vehicle is stationary.

Unlocking the Doors



Press the button to unlock all doors. One long flash of the turn signal lamps confirms that your vehicle has unlocked.

One-Stage Unlocking



Press the button to unlock all doors.

Two-Stage Unlocking (If Equipped)



Press the button to unlock the driver's door. Press the button again within three seconds to unlock all doors.

Locking the Doors



Press the button to lock all doors. One short flash of the turn signal lamps confirms your vehicle is locked.

A tone sounds when you press the lock button twice within three seconds on the remote control to confirm your vehicle is locked.

Note: You can also lock and unlock your vehicle without using the remote control. See **Keyless Entry** (page 86).

UNLOCKING AND LOCKING THE DOORS USING THE KEY BLADE

If there is a power door lock fault you can use the key blade to lock and unlock the doors.

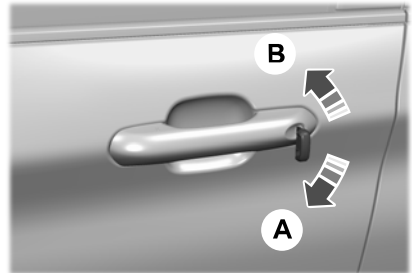

- A Lock.
- B Unlock.

Release the key blade from the remote control. See **Removing the Key Blade** (page 74).

Hidden Rear Door Locks (If Equipped)

Manually lock or unlock the rear doors using the hidden lock knob on the inside front edge of the rear doors.

Doors and Locks

Note: The central locking only operates if the front doors are fully closed.

OPENING THE DOORS FROM INSIDE YOUR VEHICLE

Pull the interior door handle twice to unlock and open a rear door. The first pull unlocks the door and the second pull opens the door.

AUTOUNLOCK

WHAT IS AUTOUNLOCK

Autounlock is a feature that centrally unlocks the vehicle doors when your vehicle comes to a stop and you open the driver door using the interior door handle.

AUTOUNLOCK REQUIREMENTS

Autounlock unlocks all the doors after:

1. The vehicle speed exceeds 12 mph (20 km/h).
2. Your vehicle comes to a stop.
3. You open the driver door.

Note: Autounlock operates for only 10 minutes after the ignition is switched off.

SWITCHING AUTOUNLOCK ON AND OFF

1. From the settings menu, press Vehicle. See **Center Display** (page 467).
2. Press Locks.
3. Switch Autounlock on or off.

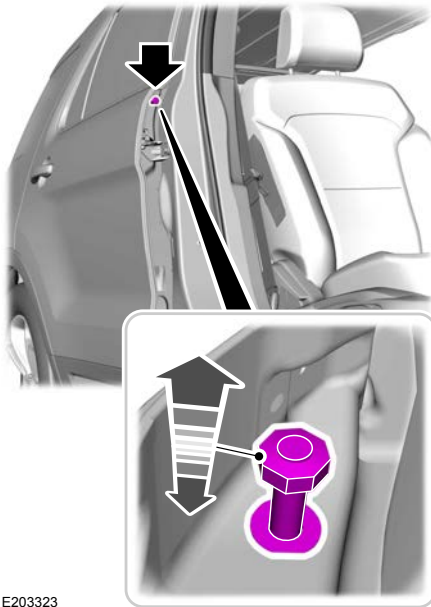

E203323

Open the front doors to access the lock knob. Pull the knob to unlock and push the knob to lock.

OPERATING THE DOORS FROM INSIDE YOUR VEHICLE

UNLOCKING AND LOCKING THE DOORS USING THE CENTRAL LOCKING

The power door lock control is on the front doors.



Press the button to unlock all doors.



Press the button to lock all doors.

Doors and Locks

AUTOLOCK

WHAT IS AUTOLOCK

Autolock is a locking feature that centrally locks your vehicle doors when driving.

AUTOLOCK REQUIREMENTS

Autolock locks all the doors after:

1. All doors are closed and the ignition is on.
2. Your vehicle speed exceeds 12 mph (20 km/h).

Autolock repeats if:

1. Your vehicle is stopped.
2. Any door is opened and closed again.
3. Your vehicle speed exceeds 12 mph (20 km/h).

MISLOCK

WHAT IS MISLOCK

Mislock is a locking feature that warns you if your vehicle has not locked after requesting a lock.

HOW DOES MISLOCK WORK

The horn sounds when you press the lock button on the remote control and a door is open.

MISLOCK LIMITATIONS

When you press the lock button once, the direction indicators do not flash if:

- Any door or the liftgate is open.
- The hood is open.

When you press the lock button twice within three seconds, the horn sounds if:

- Any door or the liftgate is open.
- The hood is open.

If you switch mislock off, the horn does not sound if you press the lock button on the remote control when a door is open.

SWITCHING MISLOCK ON AND OFF

1. From the settings menu, press Vehicle. See **Center Display** (page 467).
2. Press Locks.
3. Switch Mislock chirp on or off.

DOOR LOCK INDICATORS

An LED on the power door lock control illuminates when all doors are locked. It remains on for up to five minutes after you switch the ignition off.

DOORS AND LOCKS AUDIBLE WARNINGS

Door Ajar Audible Warning

Sounds when any front door is not fully closed and your vehicle is moving.

DOORS AND LOCKS – TROUBLESHOOTING

DOORS AND LOCKS – WARNING LAMPS

Door Ajar Warning Lamp



Illuminates when you switch the ignition on and remains on if any door or the hood is open.

Doors and Locks

DOORS AND LOCKS – INFORMATION MESSAGES

Message	Details
Driver door ajar	Displays if a door is open. Fully close the door.
Passenger door ajar	
Rear left door ajar	
Rear right door ajar	
Hood ajar	Displays if a hood is open. Fully close the hood.

Doors and Locks

DOORS AND LOCKS – FREQUENTLY ASKED QUESTIONS

Can accessories such as steps or handles be used with the latch assembly?

- Do not use the door latch assembly to attach any accessory, such as handles or steps, as this can cause damage to your vehicle.

Keyless Entry

WHAT IS KEYLESS ENTRY

The system allows you to lock and unlock your vehicle without taking the passive key out of your pocket or purse.

KEYLESS ENTRY LIMITATIONS

Make sure your remote control is within 3 ft (1 m) from the front door handles and the liftgate.

The system could not function if:

- The remote control remains stationary for about a minute.
- The vehicle battery has no charge.
- The remote control battery has no charge.
- There is interference causing issues with the remote control frequencies.
- The remote control is too close to metal objects or electronic devices, for example keys or a cell phone.

KEYLESS ENTRY SETTINGS

Reprogramming the Unlocking Function (If Equipped)

You can enable the two-stage unlocking function allowing you to unlock only the driver door when you touch the unlock sensor.

Press and hold both the lock and unlock buttons on the remote control for four seconds to disable or enable two-stage unlocking.

If you program the unlocking function so that only the driver door unlocks, you can unlock all of the other doors from inside your vehicle using the power door lock control. You can unlock individual doors by pulling the interior door handles on those doors.

Key Detection Alert

Displays a message in the instrument cluster if no valid key is detected, when you exit your vehicle with a key, after the last front door is closed and your keyless vehicle is in run, indicating your vehicle is still on. An audible alert sounds if you have driven the vehicle and reached a speed of 16 mph (25 km/h) and the above mentioned conditions are met.

You can switch the audible alert on or off.

1. From the settings menu, press Vehicle. See **Center Display** (page 467).
2. Switch Key Detection Alert On or Off.

USING KEYLESS ENTRY

Unlocking the Doors

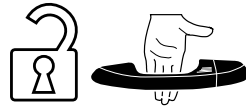

With your passive key within 3 ft (1 m) of your vehicle, touch the unlock sensor on the back of the door handle for a brief period and then pull on the door handle to unlock, being careful not to touch the lock sensor at the same time or pull on the door handle too quickly. The intelligent access system requires a brief delay to authenticate your intelligent access key.

Keyless Entry

Using the Electronic Liftgate with Passive Key (If Equipped)

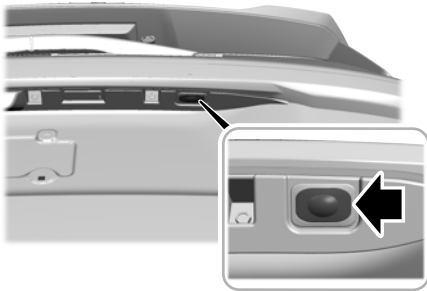

With your passive key within 3 ft (1 m) of your vehicle, press the exterior liftgate release button inside of the liftgate handle. The liftgate unlocks and opens. See **Opening the Liftgate From Outside Your Vehicle** (page 94).

Locking the Doors



With your passive key within 3 ft (1 m) of your vehicle, touch the outer door handle lock sensor for approximately one second to lock, being careful not to touch the unlock sensor on the back of the door handle at the same time. After locking, you can pull on the door handle to confirm locking occurred without inadvertently unlocking.

KEYLESS ENTRY – TROUBLESHOOTING

KEYLESS ENTRY – FREQUENTLY ASKED QUESTIONS

Why does the keyless entry system not function?

- If the system does not function, check to see what may be causing the limitation. See **Keyless Entry Limitations** (page 86).
- If the system still does not function, use the remote control or the key blade to lock and unlock your vehicle.

Why can I not lock my vehicle?

- If you electronically lock your vehicle with a rear door or the liftgate open, the system searches for a passive key inside your vehicle after you close the last door. If the system detects a key, all doors unlock indicating that a key is inside. Your vehicle locks if another passive key is within the detection range after you close the last door.

Keyless Entry Keypad (If Equipped)

WHAT IS THE KEYLESS ENTRY KEYPAD

The keyless entry keypad allows you to lock and unlock your vehicle using the keypad on the window trim.

KEYLESS ENTRY KEYPAD LIMITATIONS

The system may not function if:

- The vehicle battery has no charge.

LOCATING THE KEYLESS ENTRY KEYPAD

The keypad is near the driver window and illuminates when you press it.



KEYLESS ENTRY KEYPAD MASTER ACCESS CODE

What is the Master Access Code

The master access code is a factory-set five-digit entry code. You can operate the keypad with the master access code at any time. The master access code can be displayed in the instrument cluster display.

Displaying the Master Access Code in the Instrument Cluster Display

Read and understand the following before you begin the process.

- You must have two keys inside your vehicle.
- Make sure that you close all the doors and that they remain closed throughout the procedure.
- Do not place the keys on the wireless accessory charging area during the procedure.

Perform all steps within 30 seconds of starting the sequence. If you perform any of the steps out of sequence, stop and wait for at least one minute before starting again.

1. Turn the vehicle off.
2. Locate the backup slot inside the vehicle. See **Accessing the Passive Key Backup Position** (page 181).
3. Place the first key in the backup slot with the buttons upright and facing toward the rear of the vehicle.
4. Without pressing the brake pedal, push the start button to put the vehicle into accessory mode and wait for four seconds.
5. Turn off the vehicle and replace the first key with the second key.
6. Without pressing the brake pedal, push the start button to put the vehicle into accessory mode.

The master access code appears in the instrument cluster display for a few seconds.

Note: *In case of warning messages appearing in the instrument cluster, the master access code displays only after you dismiss them.*

Keyless Entry Keypad (If Equipped)

KEYLESS ENTRY KEYPAD PERSONAL ACCESS CODES

Programming a Personal Entry Code

1. Enter the five-digit master code.
2. Press **1-2** on the keypad within five seconds.
3. Enter your personal five-digit code. You must do this within five seconds of completing Step 2.
4. Press **1-2** on the keypad to save personal code 1.

The doors lock then unlock to confirm that programming was successful.

To program additional personal entry codes, repeat Steps 1 through 3, then for Step 4:

- Press **3-4** to save personal code 2.
- Press **5-6** to save personal code 3.
- Press **7-8** to save personal code 4.
- Press **9-0** to save personal code 5.

If your vehicle comes with the operating system, you can also program the system with one personal entry code.

Note: *Programming a code using the operating system overwrites any code that was already saved on the position 9-0 of the Keypad.*

Hints:

- Do not set a code that uses five of the same number.
- Do not use five numbers in sequential order.
- The five-digit master code works even if you have set your own personal code.

Erasing a Personal Code

1. Enter the five-digit master code.

2. Press and release **1-2** on the keypad within five seconds.
3. Press and hold **1-2** for two seconds. You must do this within five seconds of completing Step 2.

All personal codes erase and only the five-digit master code works.

Anti-Scan Feature

The keypad goes into an anti-scan mode if you enter the wrong code seven times. This mode turns off the keypad for one minute and the keypad lamp flashes.

The anti-scan feature turns off after:

- One minute of keypad inactivity.
- You press the unlock button on the remote control.
- You switch the ignition on.
- You unlock your vehicle using keyless entry.

USING THE KEYLESS ENTRY KEYPAD

Unlocking the Driver Door

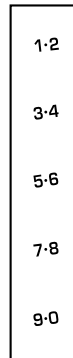

Keyless Entry Keypad (If Equipped)

Enter the factory-set five-digit code or your personal code. You must press each number within five seconds of each other.

Note: All doors unlock if the two-stage unlocking feature is disabled. See **Keyless Entry Settings** (page 86).

Unlocking All Doors

Enter the factory-set code or your personal code, then press 3-4 within five seconds.

Locking the Doors

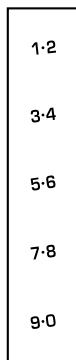

Press and hold **7-8** and **9-0** at the same time with the driver door closed.

Note: You do not need to enter the code first.

KEYLESS ENTRY KEYPAD – TROUBLESHOOTING

KEYLESS ENTRY KEYPAD – FREQUENTLY ASKED QUESTIONS

Why does the keypad not accept the access code?

If you enter the access code too fast on the keypad, the unlock function may not work. Slowly re-enter the access code.

Why does the keypad not function?

The keypad goes into an anti-scan mode if you enter a wrong code seven times. The anti-scan mode disables the keypad for one minute and the red light flashes.

Easy Entry and Exit

HOW DOES EASY ENTRY AND EXIT WORK

Easy entry and exit moves the driver seat rearward and the steering column up when you switch the ignition off. The driver seat and steering column return to their previous positions when you switch the ignition on.

Note: *Depending on your vehicle, the column may move up and in.*

SWITCHING EASY ENTRY AND EXIT ON AND OFF

1. From the settings menu, press Vehicle. See **Center Display** (page 467).
2. Press Easy Entry/Exit.

If you press any adjustment or memory button when in easy exit mode, the system cancels the operation.

Liftgate - Vehicles With: Manual Liftgate

OPENING THE LIFTGATE

OPENING THE LIFTGATE FROM INSIDE YOUR VEHICLE

Using the Over Head Console (If Equipped)

Press the button on the overhead console to unlock the liftgate. The liftgate unlocks for 45 seconds, during which time you can open the liftgate using the outside control button.

Note: The liftgate icon illuminates when the lock is released.

Note: The vehicle must be running to access this feature.

Using the Central Locking (If Equipped)

You can lock and unlock the liftgate using the central locking. See **Unlocking and Locking the Doors Using the Central Locking** (page 82).

Note: Be careful when opening or closing the liftgate in a garage or other enclosed area to avoid damaging the liftgate.

Note: Do not hang anything, for example a bike rack, from the glass or liftgate. This could damage the liftgate and its components.

Note: Do not leave the liftgate open when you are driving. This could damage the liftgate and its components.

OPENING THE LIFTGATE FROM OUTSIDE YOUR VEHICLE

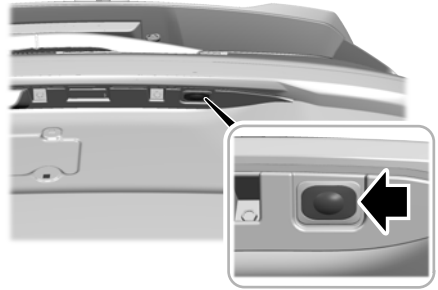

Press the control button to unlatch the liftgate and lift to open.

Note: Be careful when opening or closing the liftgate in a garage or other enclosed area to avoid damaging the liftgate.

Note: Do not hang anything, for example a bike rack, from the glass or liftgate. This could damage the liftgate and its components.

Note: Do not leave the liftgate open while driving.

Note: This could damage the liftgate and its components.

OPENING THE LIFTGATE USING THE REMOTE CONTROL

Using Remote Control Trunk Button (If Equipped)



Press the button to unlock the liftgate. The liftgate unlocks for 45 seconds, during which time you can open the liftgate using the outside control button.

Note: The liftgate automatically locks after 45 seconds.

Liftgate - Vehicles With: Manual Liftgate

Note: Be careful when opening or closing the liftgate in a garage or other enclosed area to avoid damaging the liftgate.

Note: Do not hang anything, for example a bike rack, from the glass or liftgate. This could damage the liftgate and its components.

CLOSING THE LIFTGATE

CLOSING THE LIFTGATE FROM OUTSIDE YOUR VEHICLE



WARNING: It is extremely dangerous to ride in a cargo area, inside or outside of a vehicle. In a crash, people riding in these areas are more likely to be seriously injured or killed. Do not allow people to ride in any area of your vehicle that is not equipped with seats and seatbelts. Make sure everyone in your vehicle is in a seat and properly using a seatbelt. Failure to follow this warning could result in serious personal injury or death.



WARNING: Make sure that you fully close the liftgate to prevent exhaust fumes from entering your vehicle. If you are unable to fully close the liftgate, open the air vents or the windows to allow fresh air to enter your vehicle. Failure to follow this instruction could result in personal injury or death.



A handle is inside the liftgate to help with closing.

Note: Make sure that you fully close the liftgate to prevent cargo from falling out.

You can lock and unlock the liftgate using the key blade. See **Unlocking and Locking the Doors Using the Key Blade** (page 81).

Liftgate - Vehicles With: Power Liftgate

LIFTGATE PRECAUTIONS



WARNING: Make sure all persons are clear of the power liftgate area before opening or closing the liftgate.



WARNING: It is extremely dangerous to ride in a cargo area, inside or outside of a vehicle. In a crash, people riding in these areas are more likely to be seriously injured or killed. Do not allow people to ride in any area of your vehicle that is not equipped with seats and seatbelts. Make sure everyone in your vehicle is in a seat and properly using a seatbelt. Failure to follow this warning could result in serious personal injury or death.



WARNING: Make sure that you fully close the liftgate to prevent exhaust fumes from entering your vehicle. If you are unable to fully close the liftgate, open the air vents or the windows to allow fresh air to enter your vehicle. Failure to follow this instruction could result in personal injury or death.



WARNING: Keep keys out of reach of children. Do not allow children to operate or play near an open or moving power liftgate. You should supervise the operation of the power liftgate at all times.

OPENING THE LIFTGATE

OPENING THE LIFTGATE FROM INSIDE YOUR VEHICLE

Using the Touchscreen

With the transmission in park (P), access the liftgate switch on the touchscreen under vehicle settings.

Using the Instrument Panel Button



With the transmission in park (P), press the button on the instrument panel.

Note: Be careful when opening or closing the liftgate in a garage or other enclosed area to avoid damaging the liftgate.

Note: Do not hang anything, for example a bike rack, from the glass or liftgate. This could damage the liftgate and its components.

Note: Do not leave the liftgate open when you are driving. This could damage the liftgate and its components.

OPENING THE LIFTGATE FROM OUTSIDE YOUR VEHICLE

1. Unlock the liftgate with the remote control or power door unlock control. If a remote control is within 3 ft (1 m) of the liftgate, the liftgate unlocks when you press the liftgate release button.

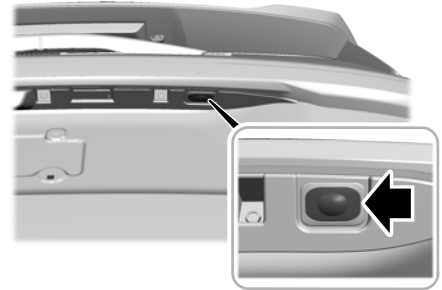

2. Press and release the liftgate control button.

Liftgate - Vehicles With: Power Liftgate

Note: Allow the power system to open the liftgate. Manually pushing or pulling the liftgate may activate the system's obstacle detection feature and stop the power operation or reverse its direction, replicate a strut failure, or damage mechanical components.

Note: Be careful when opening or closing the liftgate in a garage or other enclosed area to avoid damaging the liftgate.

Note: Do not hang anything, for example a bike rack, from the glass or liftgate. This could damage the liftgate and its components.

Note: Do not leave the liftgate open while driving.

Note: This could damage the liftgate and its components.

Switching the Power Liftgate On or Off

You can switch the power liftgate on or off through the vehicle settings in your instrument cluster.

Note: Depending on your region or vehicle type the vehicle settings may be located on your touchscreen.

When switched off, the liftgate only unlatches and will not power open or close.

OPENING THE LIFTGATE USING THE REMOTE CONTROL



Press the button twice within three seconds.

Note: Be careful when opening or closing the liftgate in a garage or other enclosed area to avoid damaging the liftgate.

Note: Do not hang anything, for example a bike rack, from the glass or liftgate. This could damage the liftgate and its components.

Note: Do not leave the liftgate open while driving. This could damage the liftgate and its components.

OPENING THE OPEN ON APPROACH LIFTGATE (If Equipped)

You can open the liftgate using your keyfob under the following conditions:



A Dwell zone.

- The keyfob is within 3 ft (1 m) of your vehicle within the dwell zone (A) for approximately 4 seconds.
- Your vehicle is in Park (P) and switched off.
- All doors and liftgate are closed.
- Open on approach is enabled in the touchscreen.
- Power liftgate is enabled in the touchscreen.
- You can remotely start your vehicle.
- Your vehicle is not in valet mode.

Note: Before the liftgate opens, the tail lamps flash and the vehicle beeps.

Note: Do not leave the liftgate open while driving. This could damage the liftgate and its components.

OPEN ON APPROACH SETTINGS (IF EQUIPPED)

Switching Open On Approach on and off

1. From the settings menu, press Vehicle.

Liftgate - Vehicles With: Power Liftgate

2. Press Liftgate.
3. Press Power Liftgate
4. You can switch the Open On Approach on or off on your touchscreen.

Open on Approach Configuration

You can set the remote control to open the liftgate only or through the touchscreen.

1. From the settings menu, press Vehicle.
2. Press Liftgate.
3. Press Power Liftgate
4. Press Open on Approach.

SETTING THE LIFTGATE OPENING HEIGHT (IF EQUIPPED)

1. Open the liftgate.
2. Stop the liftgate movement by pressing the control button on the liftgate when it reaches the desired height.

Note: Once the liftgate stops moving, you can manually move it to the desired height.

3. Press and hold the control button on the liftgate until a tone sounds, indicating programming is complete.

Note: You can only use the liftgate control button to program the height.

Note: You cannot program the height if the liftgate position is too low.

4. The power liftgate now opens at the programmed height. To change the programmed height, repeat the steps.

Note: You can fully open the liftgate by manually pushing it upward to the maximum open position if it opens in a lower position.

Note: The system recalls the new programmed height until you reprogram it, even if you disconnect the battery.

CLOSING THE LIFTGATE

CLOSING THE LIFTGATE FROM INSIDE YOUR VEHICLE



WARNING: Make sure all persons are clear of the power liftgate area before opening or closing the liftgate.



Press the button on the instrument panel.

Note: Make sure that you shift the transmission into park (P) for automatic transmission or completely stop the vehicle for manual transmission.

Note: Make sure that you close the liftgate before operating or moving your vehicle, especially in an enclosure like a garage or a parking structure. This could damage the liftgate and its components.

Note: Make sure the area behind your vehicle is free from obstruction and that there is enough room for you to operate the liftgate. Objects too close to your vehicle, for example a wall, garage door or another vehicle may come into contact with the moving liftgate. This could damage the liftgate and its components.

Note: Make sure that you fully close the liftgate to prevent cargo from falling out.

CLOSING THE LIFTGATE FROM OUTSIDE YOUR VEHICLE



WARNING: Make sure all persons are clear of the power liftgate area before opening or closing the liftgate.

Liftgate - Vehicles With: Power Liftgate

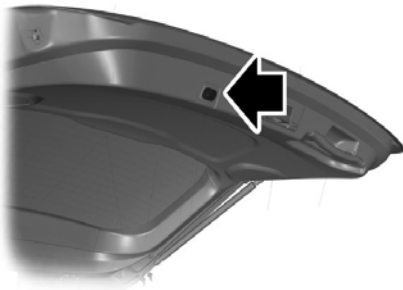

Press the liftgate button.

Note: Make sure that you close the liftgate before operating or moving your vehicle, especially in an enclosure like a garage or a parking structure. This could damage the liftgate and its components.

Note: Make sure the area behind your vehicle is free from obstruction and that there is enough room for you to operate the liftgate. Objects too close to your vehicle, for example a wall, garage door or another vehicle may come into contact with the moving liftgate. This could damage the liftgate and its components.

Note: Make sure that you fully close the liftgate to prevent cargo from falling out.

CLOSING THE LIFTGATE USING THE REMOTE CONTROL



WARNING: Make sure all persons are clear of the power liftgate area before opening or closing the liftgate.



Press the button twice within three seconds. A tone sounds when the liftgate begins to close.

Note: Make sure that you close the liftgate before operating or moving your vehicle, especially in an enclosure like a garage or a parking structure. This could damage the liftgate and its components.

Note: Make sure the area behind your vehicle is free from obstruction and that there is enough room for you to operate the liftgate. This could damage the liftgate and its components.

Note: Make sure that you fully close the liftgate to prevent cargo from falling out.

STOPPING THE LIFTGATE MOVEMENT

Note: Do not apply sudden excessive force to the liftgate while it is in motion. This could damage the power liftgate and its components.

Note: Selections vary depending on region or options.

You can stop the liftgate movement by doing any of the following:

- Pressing the liftgate control button on the liftgate.
- Pressing the liftgate control button inside the vehicle.
- Pressing the liftgate button on the remote control twice.
- Pressing the liftgate button on an authorized device.

LIFTGATE OBSTACLE DETECTION

Closing the Liftgate

The system stops when it detects an obstacle. A tone sounds and the system reverses to open. Once you remove the obstacle, you can power close the liftgate.

Liftgate - Vehicles With: Power Liftgate

Note: *To prevent accidental obstacle detection, let the power liftgate close completely before you enter your vehicle.*

Opening the Liftgate

The system stops when it detects an obstacle and a tone sounds. Once you remove the obstacle, you can continue to operate the liftgate.

LIFTGATE – TROUBLESHOOTING

LIFTGATE – WARNING LAMPS



Illuminates when the liftgate is not completely closed.

LIFTGATE – INFORMATION MESSAGES

Message	Action
Liftgate ajar	The liftgate is not completely closed. Close the liftgate.

Liftgate - Vehicles With: Power Liftgate

LIFTGATE – FREQUENTLY ASKED QUESTIONS

Why won't my power liftgate function?

- It can happen in freezing conditions or when parking on downhill slopes.
- Make sure the power liftgate is enabled in the vehicle settings menu.
- Make sure the transmission is in park (P), ensure nothing is obstructing the liftgate path and there is not excessive weight on the liftgate.
- If there are continued issues, the battery voltage may be low or there may be other system issues. See an authorized dealer.

Security

PASSIVE ANTI-THEFT SYSTEM

WHAT IS THE PASSIVE ANTI-THEFT SYSTEM

The passive anti-theft system prevents someone from starting your vehicle with an incorrectly coded key.

Note: *Do not leave a duplicate coded key in your vehicle. Always take the keys and lock all the doors when leaving your vehicle.*

HOW DOES THE PASSIVE ANTI-THEFT SYSTEM WORK

The passive anti-theft system arms when you switch your vehicle off.

It disarms when you switch your vehicle on with a correctly coded key.

Note: *The system is not compatible with non-Ford aftermarket remote start systems.*

Note: *Do not leave a duplicate coded key in your vehicle. Always take the keys and lock all doors when leaving your vehicle.*

ANTI-THEFT ALARM SYSTEM

WHAT IS THE ANTI-THEFT ALARM SYSTEM

The anti-theft alarm system warns you of an unauthorized entry to your vehicle.

HOW DOES THE ANTI-THEFT ALARM SYSTEM WORK

When armed, the anti-theft alarm is triggered in any of the following ways:

- Opening a door, the tailgate or hood without a correctly coded key or remote control.
- If you turn the power on without a correctly coded key.
- Disconnecting the battery.

Any further attempts to carry out one of the above, sounds the alarm again.

If the anti-theft alarm is triggered, the alarm horn sounds for 30 seconds and the turn signals flash for five minutes.

WHAT IS THE PERIMETER ALARM - EXCLUDING: POLICE

The perimeter alarm is designed to detect unauthorized access to your vehicle.

ARMING THE ANTI-THEFT ALARM SYSTEM

The alarm is ready to arm when you switch your vehicle off.

Lock your vehicle with your remote control to arm the alarm.

DISARMING THE ANTI-THEFT ALARM SYSTEM

Disarm the alarm by performing any of the following actions:

- Unlock the doors or luggage compartment with the remote control.
- Switch your vehicle on or start your vehicle.

Security

USING THE POLICE PERIMETER ALERT SYSTEM - POLICE

The system monitors moving pedestrians and detects objects such as vehicles and bicycles. The system does not function if the ignition is off, transmission is not in park (P) or when any door is open. It uses sensors near the rear bumper of the vehicle to detect and monitor moving objects near your vehicle.

Detected moving objects appear as moving dots on the radar map displayed on the instrument cluster display. The dots turn red if the system identifies a potential threat.



Once the approaching objects cross the selected range perimeter, an alert tone sounds, the rear view camera may show potential threats on the center display and the system may raise the windows and lock the doors depending on the range mode selected.

Switching the Police Perimeter Alert On and Off



Press the button on the center console to manually switch the system on and off.

The system automatically switches off if you:

- Shift your vehicle out of park (P).
- Switch your vehicle off.
- Open a door.

Police Perimeter Alert Indicator



When the system is active, an indicator illuminates on the instrument cluster display.

Police Perimeter Alert Settings

The system has three mode settings that control the range: Low, Medium, or High. A highlighted ring on the radar map with the setting label appear on the instrument cluster display to indicate the selected range mode.

The default setting is Medium. The system defaults to this mode every time you switch your vehicle off.

Note: If you restart your vehicle before the system completely shuts down, the previous mode setting may be retained.

Switching the Police Perimeter Alert Modes

You can change the perimeter alert mode through the steering wheel buttons while the system is active or through the vehicle settings menu when the system is inactive. See **Using the Instrument Cluster Display Controls** (page 134).

When the system is active, you can change the mode setting when the perimeter alert screen is displayed on the instrument cluster display by pressing the up or down buttons on the steering wheel.

When the system is inactive,

1. Press the menu button on the steering wheel to enter the instrument cluster display main menu.
2. Using the instrument cluster controls on the steering wheel, select **Settings**.

Security

3. Select **Vehicle Settings**.
4. Select the desired perimeter alert mode setting.
5. Press the **OK** button.

Automatic Operation of Windows or Door Locks



When windows or door locking function is active, corresponding indicators appear on the instrument cluster display.

The windows and door locking functions are not available when Low mode is selected or Police Idle is active.

When Dark Car mode is active, the radar map in the instrument cluster display switches off.

Object Detection

The system uses sensors located near the rear corners of your vehicle. The sensors perform best when you park your vehicle in an open area without large obstructions or walls nearby.



Note: *The system may not detect fast vehicles, stationary objects, and small objects such as birds.*

Note: *The system may not detect a pedestrian who is near a large obstruction such as a vehicle or a wall until they move away from the obstruction.*

Note: *Sensor reflections from stationary objects may cause false objects to briefly appear on the Police Perimeter Alert System display.*

Note: *Sensor obstructions such as dirt, mud, precipitation, repair compound, stickers, graphics, bumper guards, trailers, bicycle racks or cargo racks in front of the sensors can cause system sensing degradation.*

System Error

If a police perimeter alert system fault occurs, a warning message appears on the instrument cluster display. Have the system checked as soon as possible.

If the system does not activate, have the system checked as soon as possible.

SECURITY – TROUBLESHOOTING

SECURITY – INFORMATION MESSAGES

No key detected	The system has not detected a correctly coded key.
Starting system fault	The system has malfunctioned. Have your vehicle checked as soon as possible.
Vehicle alarm To stop alarm, start vehicle	Displays when the alarm has been triggered due to unauthorized entry.

Security

SECURITY – FREQUENTLY ASKED QUESTIONS

What should I do if there is a potential alarm problem with my vehicle?

- Take all remote controls to an authorized dealer if there is a potential alarm problem with your vehicle.

What should I do if my vehicle is unable to start with a correctly coded key?

- Have your vehicle checked as soon as possible.

Steering Wheel

ADJUSTING THE STEERING WHEEL

WARNING: Do not adjust the steering wheel when your vehicle is moving. Failure to follow this instruction could result in the loss of vehicle control, personal injury or death.

Note: Make sure that you are sitting in the correct position. See **Sitting in the Correct Position** (page 145).

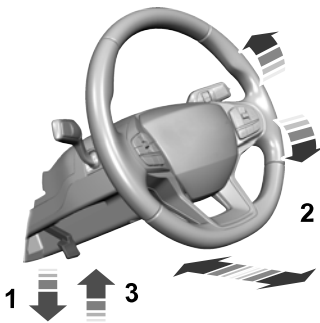

1. Unlock the steering column.
2. Adjust the steering wheel to the position you prefer.
3. Lock the steering column.

HORN



Press on the center of the steering wheel near the horn icon to activate the horn.

SWITCHING THE HEATED STEERING WHEEL ON AND OFF - VEHICLES WITH: HEATED STEERING WHEEL

WARNING: Use caution when using the heated steering wheel if you are unable to feel pain to your skin because of advanced age, chronic illness, diabetes, spinal cord injury, medication, exhaustion or other physical conditions. Failure to follow this instruction could result in personal injury, especially if the heated steering wheel is used for long periods of time.



To activate the heated steering wheel, press the button on the touchscreen. An indicator illuminates when the heated steering wheel is on. To turn it off, press the heated steering wheel button again.

Note: The engine must be running to use the heated steering wheel.

Note: A sensor regulates the temperature of the steering wheel.

Note: The heated steering wheel may remain on after remote starting your vehicle, depending on the remote start settings. It may also turn on when you start your vehicle if it was on the last time the engine was switched off.

Note: In warm temperatures, the steering wheel quickly reaches its maximum temperature and the system reduces the current to the heating element. This could cause you to think that the system has stopped working but it has not. This is normal.

Wipers and Washers

WIPERS

WIPER PRECAUTIONS

Do not operate the wipers on a dry windshield. This could scratch the glass or damage the wiper blades. Use the windshield washers before wiping a dry windshield.

Fully defrost the windshield before you switch the windshield wipers on.

Switch the windshield wipers off before entering a car wash.

SWITCHING WINDSHIELD WIPERS ON AND OFF - EXCLUDING: POLICE

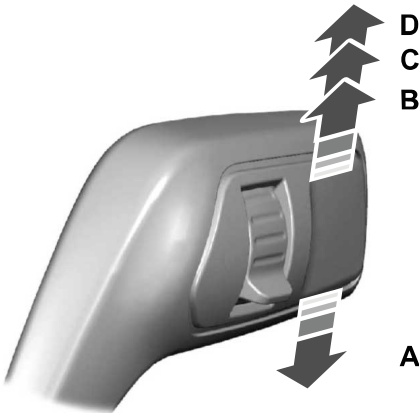

- A Single wipe.
- B Intermittent wipe/Auto wipe.
- C Normal wipe.
- D High-speed wipe.



Push the lever up or down to operate the windshield wipers.

For vehicles with auto lamps, the headlamps turn on when the windshield wipers operate.

SWITCHING WINDSHIELD WIPERS ON AND OFF - POLICE

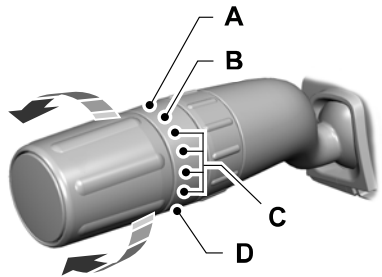

- A High-speed wipe.
- B Low-speed wipe.
- C Auto Wipe/Intermittent wipe.
- D Off.



Use the rotary control.

A AUTOWIPERS (IF EQUIPPED)

WHAT ARE AUTOWIPERS

Autowipers, when turned on, automatically control the speed and frequency of the windshield wipers if the rain sensors detect moisture on the windshield.

Note: Keep the outside of the windshield clean. The rain sensor is very sensitive and the wipers may operate if dirt, mist or insects hit the windshield.

Wipers and Washers

AUTOWIPERS SETTINGS

1. From the settings menu, press Vehicle. See **Center Display** (page 467).
2. Press Wipers.
3. Switch Rain sensing on or off.

Note: When you switch the feature off, the wipers do not operate based on the rain sensor. When you switch on the windshield wipers to the intermittent wipe position with the feature on, the wipers use the wipe speed set by the rotary control.

ADJUSTING THE SENSITIVITY OF THE RAIN SENSOR

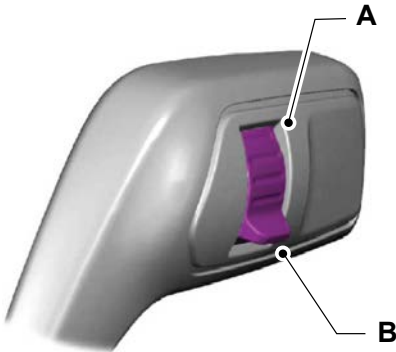

- A High sensitivity.
- B Low sensitivity.

Use the rotary control to set the rain sensor sensitivity.

When you select high sensitivity, the wipers operate when the sensor detects a small amount of water on the windshield.

When you select low sensitivity, the wipers operate when the sensor detects a large amount of water on the windshield.

SWITCHING THE REAR WINDOW WIPER ON AND OFF - EXCLUDING: POLICE

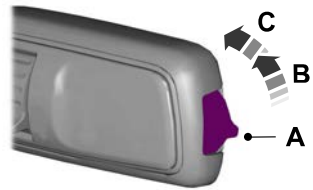

- A Rear window wiper off.
- B Intermittent wipe.
- C Continuous wipe.

SWITCHING THE REAR WINDOW WIPER ON AND OFF - POLICE



Rotate the control away from you for a long wipe interval.

Wipers and Washers

Rotate the control toward you for a short wipe interval.

REVERSE WIPE

WHAT IS REVERSE WIPE

Reverse wipe turns on the rear window wiper when you shift into reverse (R) and the windshield wipers are on.

REVERSE WIPE SETTINGS

1. From the settings menu, press Vehicle. See **Center Display** (page 467).
2. Press Wipers.
3. Switch Rear wiper on or off.

CHECKING THE WIPER BLADES



Run the tip of your fingers over the edge of the blade to check for roughness.

REPLACING THE FRONT WIPER BLADES

Make sure your vehicle is off before beginning this procedure.

Note: Do not manually move the wiper arms when the vehicle is on or in accessory mode, this could damage the wiper motor.

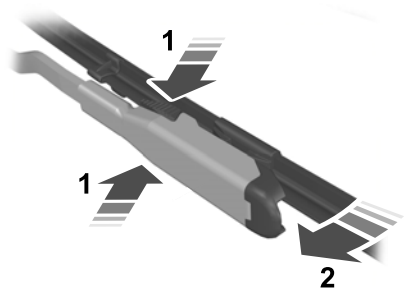

1. Lift the wiper arm and then press the wiper blade locking buttons together.

Note: Do not hold the wiper blade to lift the wiper arm.

Note: Make sure that the wiper arm does not spring back against the glass when the wiper blade is not attached.

2. Slightly rotate the wiper blade.
3. Remove the wiper blade.
4. To install, reverse the removal procedure.

Note: Make sure that the wiper blade locks into place.

Wipers and Washers

REPLACING THE REAR WIPER BLADES

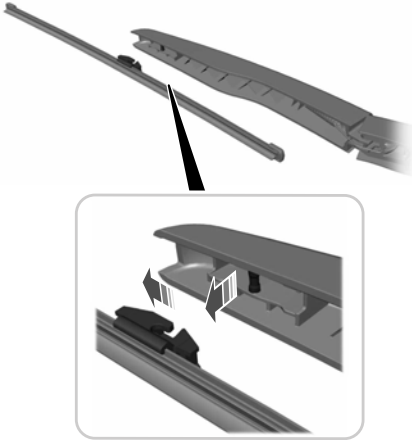

1. Lift the wiper arm.

Note: Do not hold the wiper blade to lift the wiper arm.

Note: Do not lift the wiper arm beyond the limited service-up position, as this might cause damage to the wiper arm. The limited service-up position is intended to protect the wiper arm against car washes.

2. Remove the wiper blade.

Note: Make sure that the wiper arm does not spring back against the glass when the wiper blade is not attached.

3. To install, reverse the removal procedure.

Note: Make sure that the wiper blade locks into place.

WASHERS

WASHER PRECAUTIONS



WARNING: If you operate your vehicle in temperatures below 41°F (5°C), use washer fluid with antifreeze protection. Failure to use washer fluid with antifreeze protection in cold weather could result in impaired windshield vision and increase the risk of injury or accident.

Do not operate the washers when the washer reservoir is empty. This could cause the washer pump to overheat.

Keep the outside of the windshield clean. The rain sensor is very sensitive and the wipers may operate if dirt, mist or insects hit the windshield.

USING THE WINDSHIELD WASHER - EXCLUDING: POLICE



Wipers and Washers



Pull the lever toward you to operate the windshield washer.

Note: A courtesy wipe occurs a short time after the wipers stop to clear any remaining washer fluid when switched on. See **Switching the Courtesy Wipe On and Off** (page 109).

USING THE WINDSHIELD WASHER - POLICE

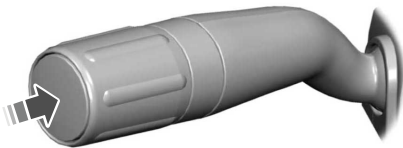

Press and hold the button at the end of the lever to operate the windshield washer.

Note: A courtesy wipe occurs a short time after the wipers stop to clear any remaining washer fluid when switched on. See **Switching the Courtesy Wipe On and Off** (page 109).

SWITCHING THE COURTESY WIPE ON AND OFF

1. From the settings menu, press Vehicle. See **Center Display** (page 467).
2. Press Wipers.
3. Switch Courtesy wipe on or off.

USING THE REAR WINDOW WASHER - EXCLUDING: POLICE



Push the lever away from you to operate the rear window washer.

USING THE REAR WINDOW WASHER - POLICE

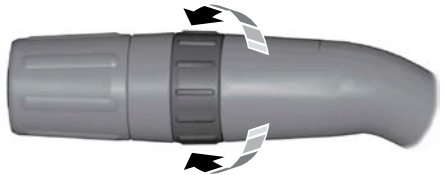

Rotate the control to the top or bottom position and hold it to operate the rear window washer.

Wipers and Washers

ADDING WASHER FLUID

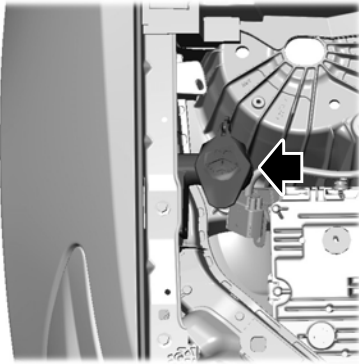

1. Remove the washer fluid reservoir cap.
2. Add washer fluid that meets our specification. See **Washer Fluid Specification** (page 110).
3. Install the washer fluid reservoir cap.

WASHER FLUID SPECIFICATION

Capacities

Variant	Quantity
All.	Fill as required.

Materials

Name	Specification
Motorcraft® Premium Windshield Wash Concentrate with Bitterant(U.S.) Motorcraft® Premium Quality Windshield Washer Fluid -35 °C / Liquide lave-glace de haute qualité - 35 °C Motorcraft®(Canada) ZC-32-B2(U.S.) CXC-37-M(Canada)	WSS-M14P19-A

Wipers and Washers

WIPERS AND WASHERS – TROUBLESHOOTING

WIPERS AND WASHERS – WARNING LAMPS



Illuminates when the windshield washer fluid is low for vehicles equipped with a washer fluid level sensor.

WIPERS AND WASHERS – FREQUENTLY ASKED QUESTIONS

Why are there streaks and smears on the windshield?

- The wiper blades could be dirty, worn or damaged. Check the wiper blades. See **Checking the Wiper Blades** (page 107). If the wiper blades are dirty, clean them with washer fluid or water applied with a soft sponge or cloth. If the wiper blades are worn or damaged, install new ones. See **Replacing the Front Wiper Blades** (page 107).

Exterior Lighting

EXTERIOR LIGHTING CONTROL - EXCLUDING: POLICE

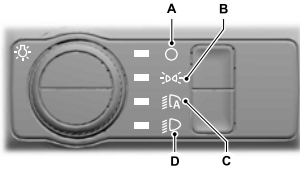

- A Lamps off.
- B Parking lamps on.
- C Autolamps on.
- D Headlamps on.

Rotate the control to make a selection.

Note: *The lighting control defaults to autolamps every time you switch your vehicle on.*

EXTERIOR LIGHTING CONTROL

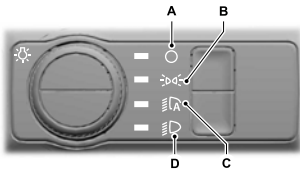

- A Lamps off.
- B Parking lamps on.
- C Autolamps on.
- D Headlamps on.

Rotate the control to make a selection.

Note: *The lighting control defaults to the last known state every time you switch your vehicle on.*

HEADLAMPS

USING THE HIGH BEAM HEADLAMPS - EXCLUDING: POLICE



Push the lever away from you to switch the high beams on.

Push the lever forward again or pull the lever toward you to switch the high beams off.

Slightly pull the lever toward you and release it to flash the headlamps.

Note: *Continuous activation only with headlamps on.*

Exterior Lighting

USING THE HIGH BEAM HEADLAMPS

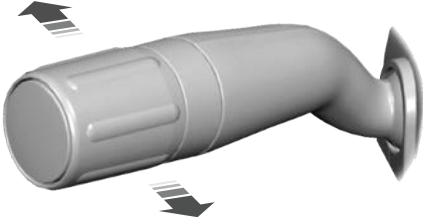

Push the lever away from you to switch the high beam on.

Push the lever forward again or pull the lever toward you to switch the high beams off.

Slightly pull the lever toward you and release it to flash the headlamps.

Note: *Continuous activation only with headlamps on.*

SWITCHING HEADLAMP EXIT DELAY ON AND OFF

To switch headlamp exit delay on, pull the turn signal lever toward you when the headlamps are off and the ignition is off. A short tone sounds when the system is on.

To switch headlamp exit delay off, pull the turn signal lever toward you again or switch your vehicle on.

Note: *The headlamps turn off after three minutes with any door open or 30 seconds after the last door closes.*

HEADLAMP INDICATORS

Lamps On



Illuminates when you switch the low beam headlamps or the parking lamps on.

Headlamp High Beam



Illuminates when you switch the high beam headlamps on.

AUTOLAMPS

WHAT ARE AUTOLAMPS



WARNING: The system does not relieve you of your responsibility to drive with due care and attention. You may need to override the system if it does not turn the headlamps on in low visibility conditions, for example daytime fog.

Autolamps turn the headlamps on in low light situations or when the windshield wipers operate.

AUTOLAMP SETTINGS

Autolamp Exit Delay

You can adjust the amount of time the autolamps remain on after you switch off your vehicle. Use the touchscreen to choose a delay setting.

1. From the settings menu, press Vehicle. See **Center Display** (page 467).
2. Press Lighting.
3. Press Autolamp Delay.
4. Select a setting.

Exterior Lighting

Note: If the setting is off, the external lamps switch off immediately when you shut down your vehicle.

Note: You can pull the turn signal toward you to manually switch off the autolamp exit delay.

EXTERIOR LAMPS

USING THE TURN SIGNAL LAMPS - EXCLUDING: POLICE



 Push the lever up or down to switch the turn signal lamps on.

Set the lever to the middle position to switch the turn signal lamps off.

Note: Tap the lever up or down to make the turn signal lamps flash three times.

Turn Signal Lamp Indicator

 It flashes when you switch the turn signal lamps on.

Note: An increase in the rate of flashing warns of a failed turn signal lamp.

USING THE TURN SIGNAL LAMPS - POLICE

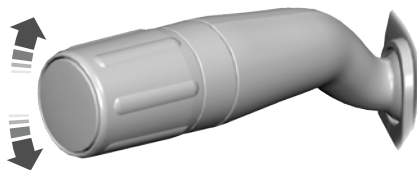

 Push the lever up or down to switch the turn signal lamps on.

Set the lever to the middle position to switch the turn signal lamps off.

Note: Tap the lever up or down to make the turn signal lamps flash three times.

Turn Signal Lamp Indicator

 It flashes when you switch the turn signal lamps on.

Note: An increase in the rate of flashing warns of a failed turn signal lamp.

HOW DO CORNERING LAMPS WORK

The cornering lamps illuminate the inside of a corner when you are turning the steering wheel or when you switch the turn signal lamps on. They turn on when the vehicle speed is below 25 mph (40 km/h).

Note: Only the cornering lamp on the side your vehicle is turning illuminates.

Note: Cornering lamps do not operate if you switch the front fog lamps on.

Exterior Lighting

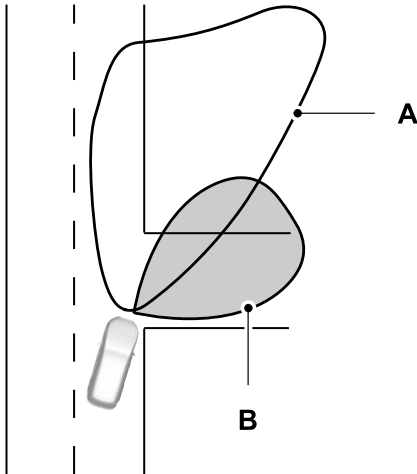

- A Headlamp beam.
B Cornering lamp beam.

SWITCHING THE DAYTIME RUNNING LAMPS ON AND OFF - VEHICLES WITH: CONFIGURABLE DAYTIME RUNNING LAMPS



WARNING: The daytime running lamps system does not activate the rear lamps and may not provide adequate lighting during low visibility driving conditions. Make sure you switch the headlamps on, as appropriate, during all low visibility conditions. Failure to do so may result in a crash.

1. From the settings menu, press Vehicle. See **Center Display** (page 467).
2. Press Lighting.

3. Switch Daytime Running Lights on or off.

The daytime running lamps turn on when all of the following occur:

- You switch the system on.
- You switch your vehicle on.
- The transmission is not in park (P) for vehicles with automatic transmissions or you release the parking brake for vehicles with manual transmissions.
- The lighting control is in the autolamps position.
- The headlamps are off.

Note: Other lighting control positions do not turn on the daytime running lamps.

SWITCHING THE DAYTIME RUNNING LAMPS ON AND OFF - VEHICLES WITH: DAYTIME RUNNING LAMPS (DRL)



WARNING: The daytime running lamps system may not activate the rear lamps and may not provide adequate lighting during low visibility driving conditions. Make sure you switch the headlamps on, as appropriate, during all low visibility conditions. Failure to do so may result in a crash.

Daytime running lamps are always on unless you switch on the headlamps or your vehicle is in park (P).

USING THE FRONT FOG LAMPS (if Equipped)

To switch the lamps on or off:

1. Set the lighting control to the parking lamps, headlamps or autolamps position.

Exterior Lighting

Note: When the lighting control is in the autolamps position, you cannot switch the fog lamps on unless the low beam headlamps are on.

2.  Press the button on the lighting control to switch the front fog lamps on or off.

Note: Only switch the front fog lamps on during reduced visibility.

Note: The brightness of the daytime running lamps may decrease when the front fog lamps are switched on.

Note: The front fog lamps lights switch off automatically when high beams are activated.

Front Fog Lamps Indicator

-  It illuminates when you switch the front fog lamps on.

USING THE OFF-ROAD DRIVING LAMPS (If Equipped)

The grille-mounted lamps provide supplementary lighting for off-road driving. It is your responsibility to use these lamps only when your vehicle is off-road.

Removing the Cover (If Equipped)

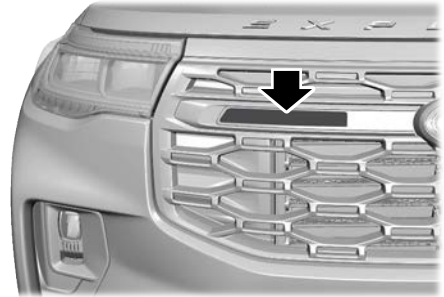

Your vehicle may come with a rubber cover to protect the off-road lamps. To remove it, lift the tab on the side of the cover and pull it in the opposite direction.

To reinstall the cover:

1. Align the rubber cover to the off-road lamps and insert the upper tabs.
2. Push the cover until it is fully in place. If required, pull the grille from below to create more space.

Switching the Off-Road Driving Lamps On and Off

To activate the lamps, follow steps 1-5. If the lamps are already active, see the instructions following step 5.

1. Make sure the exterior lighting control is in the headlamps or autolamps position.
2. From the controls menu, press Lighting. See **Center Display** (page 467).
3. Press Off-Road.
- 4.



Press the off-road lamps button on the touchscreen. A message may appear on the screen.

Note: If the high beams are already on, then the off-road lamps will switch on.

Exterior Lighting

Note: *The off-road lamps do not function with auto high beams.*

5. Switch the high beams on. See **Using the High Beam Headlamps** (page 112).

To switch the lamps off, perform any one of the following:

- Switch the high beams off. See **Using the High Beam Headlamps** (page 112).
- Press the off-road lamps button on the touchscreen.
- Switch the exterior lighting control to the off position.
- Switch your vehicle off.

Note: *Switching your vehicle off disables the off-road lamps. You will need to enable them in the touchscreen again when you switch on your vehicle.*

Off-Road Driving Lamps Indicator



Illuminates when you switch the off-road lamps on.

EXTERIOR LAMPS ON AUDIBLE WARNING

Sounds when you open the driver door and the exterior lamps are on.

AUTOMATIC HIGH BEAM CONTROL - EXCLUDING: POLICE

HOW DOES AUTOMATIC HIGH BEAM CONTROL WORK

Automatic high beam control turns the high beams on if it is dark enough and no other traffic is present. If it detects an approaching vehicle's headlamps or tail lamps, or street lighting ahead, the system turns the high beams off.

A camera sensor, centrally mounted behind the windshield of your vehicle, continuously monitors conditions to turn the high beams on and off.

Exterior Lighting

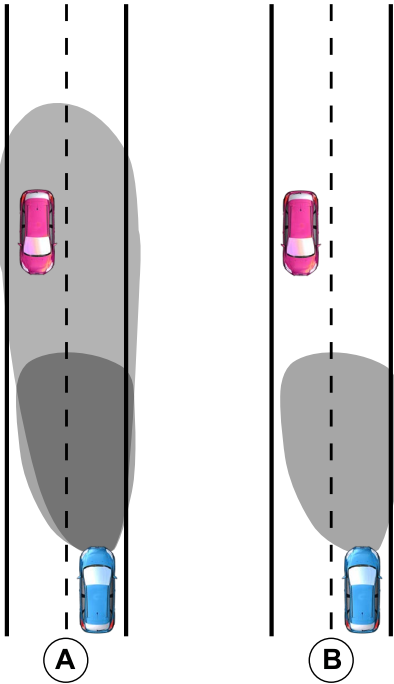

- A Without automatic high beam control.
- B With automatic high beam control.

AUTOMATIC HIGH BEAM CONTROL PRECAUTIONS

WARNING: The system does not relieve you of your responsibility to drive with due care and attention. You may need to override the system if it does not turn the high beams on or off.

WARNING: The system may not switch the high beams off if the lights of oncoming vehicles are hidden by obstacles, for example guard rails.

WARNING: You may need to override the system when approaching other road users.

WARNING: In situations with poor visibility, such as fog, heavy rain or other inclement weather, you may need to override or completely switch off the system.

AUTOMATIC HIGH BEAM CONTROL REQUIREMENTS

The system turns the high beams on if all of the following occur:

- You switch the system on.
- You set the lighting control to the autolamps position.
- The ambient light level is low enough that you require high beams.
- There is no traffic in front of your vehicle.
- The vehicle speed is greater than approximately 25 mph (40 km/h).

AUTOMATIC HIGH BEAM CONTROL LIMITATIONS

The system turns the high beams off if any of the following occur:

- You switch the system off.
- You set the lighting control to any position except autolamps.
- The ambient light level is high enough that you do not require high beams.
- The system detects an approaching vehicle's headlamps or a leading vehicle's tail lamps.

Exterior Lighting

- The system detects severe rain, snow or fog.
- The system detects street lighting.
- The camera has reduced visibility.
- The vehicle speed falls below approximately 19 mph (30 km/h).

Note: *The deactivation speed may be lower on curves.*

SWITCHING AUTOMATIC HIGH BEAM CONTROL ON AND OFF

1. From the settings menu, press Vehicle.
2. Press Lighting.
3. Switch Auto High Beam on or off.

AUTOMATIC HIGH BEAM CONTROL INDICATORS



Illuminates to confirm when the system is ready to assist.

OVERRIDING AUTOMATIC HIGH BEAM CONTROL



Push the lever away from you to switch the high beams on.

Push the lever away from you again to switch the high beams off.

Push the lever away from you for a third time to switch automatic high beam control back on.

AUTOMATIC HIGH BEAM CONTROL – INFORMATION MESSAGES

Message	Details
Front Camera Low Visibility Clean Screen	The camera has reduced visibility. Clean the windshield. If the message continues to appear, have your vehicle checked as soon as possible.
Front Camera Temporarily Not Available	The camera has malfunctioned. Wait a short period of time for the camera to cool down. If the message continues to appear, have your vehicle checked as soon as possible.
Front Camera Malfunction Service Required	The camera has malfunctioned. Have your vehicle checked as soon as possible.

Exterior Lighting

ADAPTIVE FRONT LIGHTING (IF EQUIPPED)

HOW DOES ADAPTIVE FRONT LIGHTING WORK

Adaptive front lighting adjusts the headlamps to improve visibility in certain situations.

Adaptive Front Lighting Types

Name	Details
Speed Dependent Light Mode	Provides additional light on the road depending on your vehicle speed and weather conditions.
Dynamic Bending Light	Directs the light beam based on your steering around a curve. Additionally, lane markings detected by the front windshield camera and map data also help direct the light beam.
Static Bending Light	Adds lighting at the inside of a curve or corner when you are turning the steering wheel.
Sign Based Light Mode	Activates targeted lighting when certain traffic signs are detected in intersection and roundabout scenarios.

Note: This feature may use map data. We recommend having all connected vehicle settings enabled to allow the map content to be updated to the latest version. See **Connected Vehicle Settings** (page 452). If your vehicle does not receive automatic updates, take your vehicle to an authorized dealer to receive periodic updates.

Note: There are several types of adaptive front lighting. Availability and activation conditions may vary based on your vehicle.

Switching Adaptive Front Lighting On or Off

Set the lighting control to the autolamps position to use adaptive front lighting.

Note: Other lighting control positions do not turn on adaptive front lighting.

EXTERIOR LIGHTING – FREQUENTLY ASKED QUESTIONS

Why is there condensation in the exterior lamps?

- Exterior lamps have vents to accommodate normal changes in air pressure. Condensation can be a natural by-product of this design. When moist air enters the lamp assembly through the vents, there is a

Exterior Lighting

possibility that condensation can occur when the temperature is cold. When normal condensation occurs, a fine mist can form on the interior of the lens. The fine mist eventually clears and exits through the vents during normal operation.

How much condensation is acceptable?

- The presence of a fine mist or small droplets without streak marks is normal condensation. This may occur under certain environmental conditions and will clear on its own.

How long does it take for the acceptable condensation to clear?

- Clearing time may vary depending on the outside temperature and environment, the drive duration or speed.

How much condensation is unacceptable?

- Standing water or a water puddle inside the lamp. Condensation with drip marks present on the interior of the lens.

What should I do if unacceptable condensation is present?

- Have your vehicle checked as soon as possible.

Why do my headlamps turn off when I have them switched on when I switch my vehicle off?

- The battery saver turns the headlamps off after a short period of time after you switch your vehicle off.

Interior Lighting

SWITCHING ALL OF THE INTERIOR LAMPS ON AND OFF - EXCLUDING: POLICE

The lamps turn on under the following conditions:

- You open any door.
- You press a button on the remote control.
- You press the all lamps on button on the overhead console.



Press the button on the overhead console to switch all interior lamps on or off.

SWITCHING ALL OF THE INTERIOR LAMPS ON AND OFF - POLICE

The lamps turn on under the following conditions:

- You open any door.
- You press a button on the remote control.
- You press the all lamps on button on the overhead console.



Press the button on the overhead console to switch all interior lamps on or off.

Police Dark Car

Police dark car turns off all the interior lamps and provides stealth mode to minimize detection while the police officer approaches, leaves, and while idling the vehicle.

Note: Police dark car also turns off all the exterior lamps, keypad illuminations and touchscreen.

Switching Police Dark Car On:

1. Make sure the ignition key is on and the headlamps are off.

2.



Press the instrument panel lighting dimmer down button until the instrument cluster displays only the vehicle speed and gear position.

Note: Police dark car mode is disabled temporarily when the headlamps are switched on or when the vehicle is driven above 14.9 mph (24 km/h).

Switching Police Dark Car Off:

1.



Press the instrument panel lighting dimmer up button.

SWITCHING THE FRONT INTERIOR LAMPS ON AND OFF - EXCLUDING: POLICE

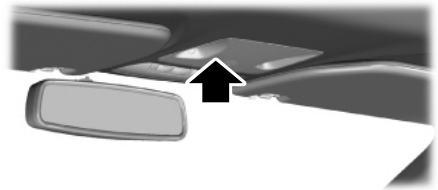

The front interior lamp switches are on the overhead console.

Note: The position of each button on the overhead console depends on your vehicle.

Interior Lighting

Individual Map Lamps



Press to switch the left-hand individual dome lamp on and off.



Press to switch the right-hand individual dome lamp on and off.

Individual Map Lamps



Press to switch the left-hand individual dome lamp on and off.



Press to switch the right-hand individual dome lamp on and off.

SWITCHING THE FRONT INTERIOR LAMPS ON AND OFF - POLICE



The front interior lamp switches are on the overhead console.

Note: *The position of each button on the overhead console depends on your vehicle.*

SWITCHING THE REAR INTERIOR LAMPS ON AND OFF - EXCLUDING: POLICE



The rear interior lamps may be above the rear seat or above the rear windows.



Press to switch the lamps on or off.

Note: *If you switch the rear lamps on through the overhead console, you cannot switch them off with the rear lamp switch.*

Night Vision Red Task Lamp



Press to switch the lamp on or off.

Interior Lighting

SWITCHING THE REAR INTERIOR LAMPS ON AND OFF - POLICE

Dome Task Lamp (If Equipped)

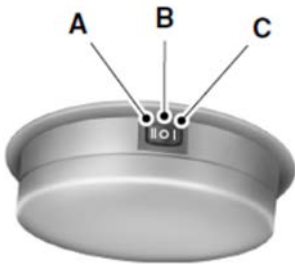

- A Night vision red light on.
- B Lamp off.
- C White light on.

Your vehicle may have a red or white dome task lamp in the headliner. This lamp is at the rear of your vehicle.

INTERIOR LAMP FUNCTION

WHAT IS THE INTERIOR LAMP FUNCTION

The interior lamp function switches the courtesy and door lamps on or off.

SWITCHING THE INTERIOR LAMP FUNCTION ON AND OFF



Press to switch the interior lamp function on and off.

Note: The indicator lamp illuminates amber when the door function is off.

ADJUSTING THE INSTRUMENT PANEL LIGHTING BRIGHTNESS

Using the Instrument Panel Lighting Dimmer Buttons (If Equipped)

The instrument panel lighting dimmer buttons are on the lighting control.



Repeatedly press one of the buttons to adjust the brightness.



Note: There are six stages of brightness adjustments available during the day and twelve stages available at night.

Using the Touchscreen

1. From the settings menu, press Display. See **Center Display** (page 467).
2. Press Brightness.
3. Drag the slider to adjust the brightness of the instrument panel lighting.

Note: There are six stages of brightness adjustments available during the day and twelve stages available at night.

AMBIENT LIGHTING

The ambient lighting system illuminates the interior of your vehicle in your choice of colors.

The ambient lighting controls are on the touchscreen and to access, press Ambient Lighting in the controls menu.

Switching Ambient Lighting On

1. Make sure the exterior lighting control is in the headlamps on or autolamps on position.

Interior Lighting

2. Press the desired color or drag the slider above the zero brightness to switch on the ambient lighting.

Note: *The ambient lighting automatically turns off in daylight conditions when the exterior lighting control is in the autolamps on position.*

Changing the Color

Press the desired color.

Adjusting the Brightness

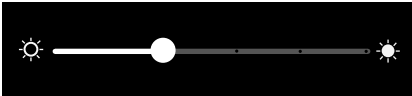

Drag the slider left or right to adjust the ambient lighting intensity.

Switching Ambient Lighting Off

Drag the slider to zero brightness to switch off the ambient lighting.

INTERIOR LIGHTING – TROUBLESHOOTING

INTERIOR LIGHTING – FREQUENTLY ASKED QUESTIONS

Why do my courtesy lamps or interior lamps turn off when I have them switched on when I switch my vehicle off?

- The battery saver turns the courtesy lamps and interior lamps off after a short period of time after you switch your vehicle off.

Windows

OPENING AND CLOSING THE WINDOWS



WARNING: Do not leave children or pets unattended in your vehicle and do not let children play with the power windows. Failure to follow this instruction could result in personal injury or death.



WARNING: When closing the power windows, verify that they are free of obstructions and make sure children and pets are not in the proximity of the window openings. Failure to follow this instruction could result in personal injury or death.



WARNING: If an obstruction is detected, release the switch and reverse the window immediately. Failure to follow this instruction could result in personal injury or death.



WARNING: Do not leave a key or remote control unattended in the vehicle. Children or pets could operate the power windows and could become trapped in a closing window. Failure to follow this instruction could result in personal injury or death.



Press the window control switch to open the window. Lift the window control switch to close the window.

Note: *The front windows operate with the ignition on, and for several minutes after you switch the ignition off or until you open a front door.*

To reduce wind noise or pulsing noise when one window is open, slightly open the opposite window.

One-Touch Open (If Equipped)

Fully press the window control switch and release it. Press again or lift it to stop the window.

One-Touch Close (If Equipped)

Fully lift the window control switch and release it. Press again or lift it to stop the window.

Resetting One-Touch Close

Carry out all steps within 30 seconds of starting the sequence.

1. Close the window.
2. Press and hold the window control switch until the window is fully open. Keep the window control switch pressed for a few seconds.
3. Lift and hold the window control switch until the window is fully closed. Keep the window control switch held for a few seconds.
4. Press and hold the window control switch until the window is fully open. Keep the window control switch pressed for a few seconds.
5. Lift and hold the window control switch until the window is fully closed. Keep the window control switch held for a few seconds.

Note: *Repeat the procedure if the window does not close when you use one-touch.*

Accessory Delay

The front windows switches remain operational for several minutes when you switch the ignition off or until you open either front door.

Windows

GLOBAL OPENING (IF EQUIPPED)

WHAT IS GLOBAL OPENING

You can use the remote control to open the windows with the ignition off.

USING GLOBAL OPENING

1. Press and release the unlock button on the remote control.
2. Press and hold the unlock button on the remote control.
3. Release the button when the windows start to open.

Press the lock or the unlock button on the remote control to stop global opening.

Note: You can use global opening for a short period of time when you unlock your vehicle using the remote control.

SWITCHING GLOBAL OPENING ON AND OFF

1. From the settings menu, press Vehicle. See **Center Display** (page 467).
2. Press Windows.
3. Switch Remote Open on or off.

WINDOW BOUNCE-BACK

WHAT IS WINDOW BOUNCE-BACK

The window stops and reverses if it detects an obstruction when closing.

OVERRIDING WINDOW BOUNCE-BACK



WARNING: If you override bounce-back, the window does not reverse if it detects an obstacle. Take care when closing the windows to avoid personal injury or damage to your vehicle.

1. Close the window until it reaches the point of resistance and let it reverse.
2. Lift and hold the window control switch within two seconds to override bounce-back and close the window. Bounce-back is now disabled and you can close the window manually.

Note: The window goes past the point of resistance and you can fully close it.

Note: If the window does not close, have your vehicle checked as soon as possible.

LOCKING THE REAR WINDOW CONTROLS



WARNING: When children and pets are in the rear seat, use the power window lockout button to prevent accidental operation of the power windows.



Press the window control switch to lock or unlock the rear window controls. It illuminates when you lock the rear window controls.

Interior Mirror

INTERIOR MIRROR PRECAUTIONS



WARNING: Do not adjust the mirrors when your vehicle is moving. This could result in the loss of control of your vehicle, serious personal injury or death.

Note: Do not clean the mirror housing or glass with harsh abrasives, fuel or other petroleum-based cleaning products.

MANUALLY DIMMING THE INTERIOR MIRROR

Pull the tab below the mirror toward you to reduce glare at night.

AUTO-DIMMING INTERIOR MIRROR (IF EQUIPPED)

WHAT IS THE AUTO-DIMMING INTERIOR MIRROR

The mirror dims to reduce the effect of bright light from behind. It returns to normal when the bright light from behind is no longer present or if you shift into reverse (R).

AUTO-DIMMING INTERIOR MIRROR LIMITATIONS

Do not block the sensors on the front and back of the mirror.

Note: A rear center passenger or raised rear center head restraint could prevent light from reaching the sensor.

Exterior Mirrors

ADJUSTING THE EXTERIOR MIRRORS



WARNING: Do not adjust the mirrors when your vehicle is moving. This could result in the loss of control of your vehicle, serious personal injury or death.



- A Window lock.
- B Adjustment control.
- C Right-hand mirror.
- D Left-hand mirror.

To adjust the mirrors, switch your vehicle on and place the ignition in accessory or start.

1. Select the mirror you want to adjust. The control light turns on.
2. Use the adjustment control to adjust the position of the mirror.
3. Press the mirror control again. The control light turns off.

FOLDING THE EXTERIOR MIRRORS - VEHICLES WITH: POWER FOLDING MIRRORS

With the auto-fold feature enabled, the exterior mirrors fold in toward the glass after you place the transmission into park (P), turn off the vehicle, open and close the driver side door and lock the vehicle. The exterior mirrors unfold and return to their driving position after you unlock the vehicle and open and close the driver side door.



For tight parking conditions, press the control to fold the mirrors.

Press the control again to unfold the mirrors.

If you press the control to fold in the mirrors with auto-fold on, the mirrors do not unfold when you unlock your vehicle.

Note: The power folding mirrors operate with the ignition on, and for several minutes after you switch the ignition off.

Note: If you fold and unfold the mirrors several times within one minute, the power fold function may turn off to protect the motors from overheating.

Switching Auto-fold On and Off

1. From the settings menu, press Vehicle. See **Center Display** (page 467).
2. Press Mirrors.
3. Switch Autofold on or off.

Exterior Mirrors

Loose, Noisy or Intermittently Working Mirrors

If you manually fold the power folding mirrors, they may not work properly even after you reposition them. Reset the mirrors if:

- They vibrate when you drive.
- They feel loose.
- They do not stay in the folded or unfolded position.
- One of the mirrors is not in its normal driving position.
- The mirrors are intermittently working.

To reset the power fold feature, use the power folding mirror control to fold and unfold the mirrors. You may hear a loud noise as you reset the power folding mirrors. This sound is normal. Operate the power folding mirrors an additional 3 to 4 times to synchronize the mirrors.

If the above process does not help you to fix the mirror, perform the following steps.

1. Fold or retract both mirrors manually.
2. Using the power folding control switch, operate the mirrors until you hear an audible click.
3. Operate the power folding an additional 3 to 4 times to synchronize the mirrors.

Repeat this process as needed each time you manually fold the mirrors.

FOLDING THE EXTERIOR MIRRORS - VEHICLES WITH: MANUAL FOLDING MIRRORS

Push the mirror toward the door window glass. Make sure that you fully engage the mirror in its support when returning it to its original position.

Heated Exterior Mirrors

See **Switching the Heated Mirrors On and Off** (page 140).

Memory Mirrors

You can save and recall the mirror positions through the memory function. See **Saving a Preset Position** (page 162).

Directional Indicator Mirrors

When your vehicle is running, the forward-facing portion of the appropriate mirror housing blinks when you switch on the turn signal.

Puddle Lamps

The puddle lamps turn on when you approach your vehicle with a remote control or phone. If your vehicle has auto-folding mirrors, the puddle lamps are only on if the mirrors are unfolded and turn off when the mirrors fold.

360 Degree Camera

See **Locating the 360 Degree Cameras** (page 259).

Blind Spot Information System

See **What Is Blind Spot Information System** (page 299).

AUTO-DIMMING EXTERIOR MIRROR (IF EQUIPPED)

WHAT IS THE AUTO-DIMMING EXTERIOR MIRROR

The driver exterior mirror dims when the interior auto-dimming mirror turns on.

Glass Roof (If Equipped)

OPENING AND CLOSING THE SUNSHADE



WARNING: Do not leave children or pets unattended in your vehicle and do not let children play with the sunshade. Failure to follow this instruction could result in personal injury.

To override sunshade bounce back, press and hold the close switch within two seconds after the sunshade comes to a stop.

The controls are on the overhead console.

Opening the Sunshade



Press and release the switch to activate the one-touch open feature. To stop movement, press the switch a second time.

Note: *The sunshade stops short of its fully opened position for the comfort of rear passengers. To fully open the sunshade, press the switch again.*

Closing the Sunshade



WARNING: If an obstruction is detected, press the switch a second time and reverse the sunshade immediately. Failure to follow this instruction could result in personal injury.



Press and release the switch to activate the one-touch close feature. To stop movement, press the switch a second time.

Note: *If fully open, the sunshade stops after covering the rear glass panel. Press and release again to fully close the sunshade.*

Sunshade Bounce Back

The sunshade stops and reverses some distance if it detects an obstacle when closing.

Instrument Cluster

INSTRUMENT CLUSTER OVERVIEW

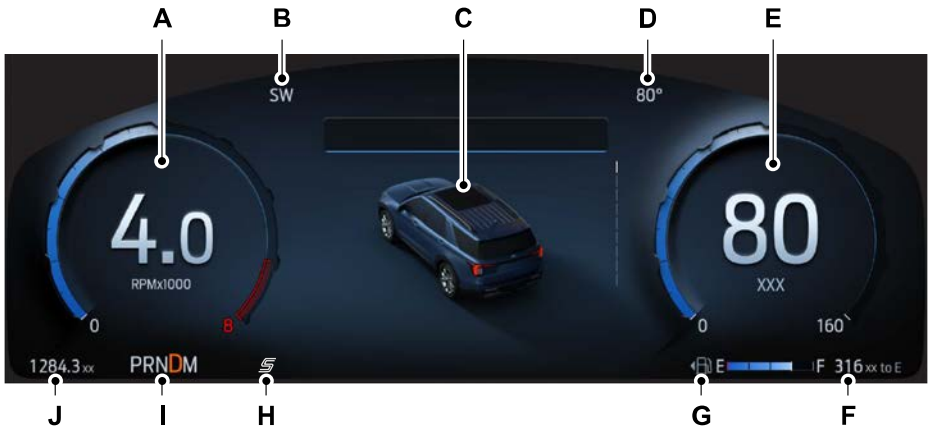

- A Tachometer.
- B Compass.
- C Information on demand area.
- D Outside air temperature.
- E Speedometer.
- F Distance to empty.
- G Fuel gauge.
- H Drive mode indicator.
- I Transmission position indicator.
- J Odometer.

TACHOMETER

Indicates the rotational speed of the engine to the driver at any given moment.

SPEEDOMETER

Indicates the speed of the vehicle to the driver at any given moment.

Instrument Cluster

FUEL GAUGE

WHAT IS THE FUEL GAUGE

Indicates approximately how much fuel is in the fuel tank.

FUEL GAUGE LIMITATIONS

The fuel gauge may not provide an accurate reading when your vehicle is on an incline.

LOCATING THE FUEL FILLER DOOR

The arrow adjacent to the fuel pump symbol indicates on which side of your vehicle the fuel filler door is located.

WHAT IS THE LOW FUEL REMINDER

A low fuel level reminder displays and sounds when the distance to empty reaches 50 mi (80 km), 25 mi (40 km), 10 mi (20 km) and 0 mi (0 km).

Note: *The low fuel reminder can appear at different fuel gauge positions depending on fuel economy conditions. This variation is normal.*

WHAT IS DISTANCE TO EMPTY

Indicates the approximate distance your vehicle can travel on the fuel remaining in the tank. Changes in driving pattern can cause the value to not only decrease but also increase or stay constant for periods of time.

ENGINE COOLANT TEMPERATURE GAUGE

Indicates the engine coolant temperature.

Instrument Cluster Display

USING THE INSTRUMENT CLUSTER DISPLAY CONTROLS



WARNING: Driving while distracted can result in loss of vehicle control, crash and injury. We strongly recommend that you use extreme caution when using any device that may take your focus off the road. Your primary responsibility is the safe operation of your vehicle. We recommend against the use of any hand-held device while driving and encourage the use of voice-operated systems when possible. Make sure you are aware of all applicable local laws that may affect the use of electronic devices while driving.

The controls are on the steering wheel.

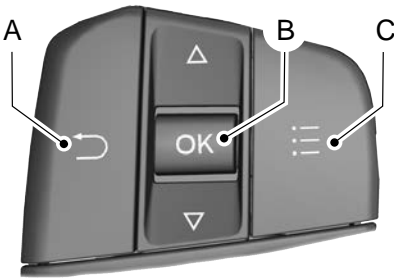

- A Return button.
- B OK button.
- C Menu button.

Return Button

Press to go back or exit a menu.

OK Button

Press to make a selection.

Toggle Buttons

Press the toggle up or down button to scroll through menu items.

Status Indicator



Menu items with a check box indicate a feature's status. A check in the box indicates the feature is on, and unchecked indicates the feature is off.

INSTRUMENT CLUSTER DISPLAY MAIN MENU

Depending on your vehicle options, some menu items can appear different or not at all.

Note: For your safety, some features are speed-dependent and could be unavailable when your vehicle is above a certain speed.

Menu Item
MyView
Trip/Fuel
Status Information
Vehicle Maintenance
Audio
Phone
Settings

CUSTOMIZING THE INSTRUMENT CLUSTER DISPLAY

1. Press the menu button on the steering wheel to enter the instrument cluster display main menu.

Instrument Cluster Display

2. Select MyView.
3. Select Configure MyView.
4. Use the controls on the steering wheel to highlight a screen to add.
5. Press the **OK** button.

Note: *The amount of screens you can add is limited. If the selected screen does not appear, you must deselect screens from the menu.*

Trip Computer

ACCESSING THE TRIP COMPUTER

1. Press the menu button on the steering wheel to enter the instrument cluster display main menu.
2. Select **Trip/Fuel**.

RESETTING THE TRIP COMPUTER

1. Press the menu button on the steering wheel to enter the instrument cluster display main menu.
2. Select **Trip/Fuel**.
3. Select the item to reset.
4. Press and hold the **OK** button for a few seconds.

TRIP DATA

Trip 1 and 2

Provides trip timer, trip average fuel economy and total trip distance traveled. For hybrid vehicles, the trip also shows the distance traveled on electric power only with the engine off.

Note: *Trip 1 and 2 are selectable screens. See **Accessing the Trip Computer** (page 136).*

This Trip

Provides trip timer, trip average fuel economy, total trip distance traveled, and distance traveled on electric power only with the engine off. If the gasoline engine has not turned on during the trip then trip average fuel economy is not shown. This Trip resets each time you start your vehicle.

Note: *This trip is a selectable screen. See **Accessing the Trip Computer** (page 136).*

Remote Start

USING REMOTE START - VEHICLES WITH: FORDPASS



WARNING: Do not start the engine in a closed garage or in other enclosed areas. Exhaust fumes are toxic. Always open the garage door before you start the engine. Failure to follow this instruction could result in personal injury or death.



WARNING: Do not keep electrical devices plugged in the power outlet whenever the device is not in use. Power outlets power up during remote start.

The system allows you to remotely start your vehicle to heat or cool the interior to a preset temperature.

Follow the instructions in the vehicle app to start and stop your vehicle.

Note: *The vehicle app must be paired with your vehicle to remotely start using the app.*

When you successfully remote start your vehicle:

- The vehicle doors lock.
- The turn signal lamps flash twice.
- The parking lamps turn on when the vehicle is running.
- The vehicle remains secured when you have remotely started the vehicle. A valid key must be inside your vehicle to switch your vehicle on and drive your vehicle.
- All other vehicle systems remain off when you have remotely started the vehicle.

The horn sounds if the system fails to start.

Note: *You cannot adjust any comfort settings until you switch your vehicle on from inside your vehicle.*

Remote start does not work under the following conditions:

- Remote start is not enabled.
- The alarm horn is sounding.
- The hood is open.
- The transmission is not in park (P).
- Your vehicle is already on.

Note: *Do not use remote start if your fuel level is low.*

Note: *A maximum of two remote starts are allowed. After that you have to switch your vehicle on and off before you can use remote start again.*

USING REMOTE START - VEHICLES WITH: REMOTE CONTROL





WARNING: Do not start the engine in a closed garage or in other enclosed areas. Exhaust fumes are toxic. Always open the garage door before you start the engine. Failure to follow this instruction could result in personal injury or death.



WARNING: Do not keep electrical devices plugged in the power outlet whenever the device is not in use. Power outlets power up during remote start.

The system allows you to remotely start your vehicle to heat or cool the interior to a preset temperature.

1.  Press the button on the remote control.
2.  Press the button twice within a few seconds.

Remote Start

When you successfully remote start your vehicle:

- The vehicle doors lock.
- The turn signal lamps flash twice.
- The parking lamps turn on when the vehicle is running.
- The vehicle remains secured when you have remotely started the vehicle. A valid key must be inside your vehicle to switch your vehicle on and drive your vehicle.
- All other vehicle systems remain off when you have remotely started the vehicle.

The horn sounds if the system fails to start.

Note: *You cannot adjust any comfort settings until you switch your vehicle on from inside your vehicle.*

Remote start does not work under the following conditions:

- Remote start is not enabled.
- The alarm horn is sounding.
- The hood is open.
- The transmission is not in park (P).
- Your vehicle is already on.

Note: *Do not use remote start if your fuel level is low.*

Note: *A maximum of two remote starts are allowed. After that you have to switch your vehicle on and off before you can use remote start again.*



To remotely stop your vehicle, press the button.

REMOTE START SETTINGS

1. From the settings menu, press Vehicle.
2. Press Remote Start Setup.

You can adjust the following in the remote start settings menu:

- Enable or disable remote start.
- Climate control settings.
- Heated seat settings.
- Heated steering wheel settings.
- Remote start duration.

Climate Control

IDENTIFYING THE CLIMATE CONTROL UNIT



Depending on your vehicle options, the controls could look different than what you see here.

SWITCHING CLIMATE CONTROL ON AND OFF



Press the button.

SWITCHING RECIRCULATED AIR ON AND OFF



Press the button to recirculate air currently in the passenger compartment.

Note: Recirculated air may automatically turn off or prevent you from switching on in all airflow modes except MAX A/C to reduce the risk of fogging. Recirculation may also automatically turn on and off in various air distribution control combinations to improve heating or cooling efficiency.

SWITCHING AIR CONDITIONING ON AND OFF



Press the button.

Note: Under certain conditions, the air conditioning compressor could continue to operate after you switch air conditioning off.

Note: To keep the system and its components fully functional, switch air conditioning on and let your vehicle idle at least once per month for a minimum of two minutes.

SWITCHING DEFROST ON AND OFF



Press the button to activate the selection screen.



Press the button on the touchscreen to switch the windshield air vents on.



Make sure that the instrument panel air vents are switched off.



Make sure that the footwell air vents are switched off.

SWITCHING MAXIMUM DEFROST ON AND OFF



Press the button.

Air flows through the windshield air vents, and the blower motor adjusts to the highest speed.

You can also use this setting to defog and clear the windshield of a thin covering of ice.

Note: To prevent window fogging, you cannot select recirculated air when maximum defrost is on.

Note: The heated rear window also turns on when you select maximum defrost.

Climate Control

Note: When maximum defrost is on, the air conditioning compressor may continue to operate even though you switch off the air conditioning.

SWITCHING MAXIMUM COOLING ON AND OFF



Press the button.

Note: When you switch maximum cooling off, air conditioning remains on.

SWITCHING THE HEATED REAR WINDOW ON AND OFF



Press the button to clear the rear window of thin ice and fog. The heated rear window turns off after a short period of time.

Note: Do not use harsh chemicals, razor blades or other sharp objects to clean or remove decals from the inside of the heated rear window as this could damage the heated rear window gridlines not covered by the vehicle warranty.

Note: Make sure the engine is on before operating the heated rear windows.

SETTING THE BLOWER MOTOR SPEED



Press the arrows to adjust the blower motor speed.

SWITCHING THE HEATED MIRRORS ON AND OFF

When you switch the heated rear window on, the heated exterior mirrors turn on. See **Switching the Heated Rear Window On and Off** (page 140).

Note: Do not remove ice from the mirrors with a scraper or adjust the mirror glass when it is frozen in place.

Note: Do not clean the mirror housing or glass with harsh abrasives, fuel or other petroleum-based cleaning products. The vehicle warranty may not cover damage caused to the mirror housing or glass.

Note: The engine must be running or your vehicle must be ready to drive to switch the system on.

SETTING THE TEMPERATURE



Adjusting the arrows on either side of the climate control sets the temperature for the respective sides.

< Press the arrow to decrease the temperature.

> Press the arrow to increase the temperature.

Note: The blue arrow decreases and the red arrow increases the temperature. Pressing the temperature value allows you to control it using the slider.



Press the button to switch dual mode on.

Climate Control

DIRECTING THE FLOW OF AIR

Directing Air to the Windshield Air Vents



Press the button to activate the selection screen.



Press the button on the touchscreen.

Directing Air to the Instrument Panel Air Vents



Press the button to activate the selection screen.



Press the button on the touchscreen.

Directing Air to the Footwell Air Vents



Press the button to activate the selection screen.



Press the button on the touchscreen.

AIR CONDITIONING SYSTEM REFRIGERANT



WARNING: The air conditioning refrigerant system contains refrigerant under high pressure. Only qualified personnel should service the air conditioning refrigerant system. Opening the air conditioning refrigerant system can cause personal injury.

Your vehicle has an under hood label that identifies the refrigerant used by the air conditioning system.

Note: Only allow a trained and certified technician service the refrigerant system to ensure proper and safe operation, as per local regulatory requirements.

Note: Never repair or replace the air conditioning evaporator with one from a salvage vehicle. Only replace it with a new evaporator to ensure proper and safe operation.

The meaning of each symbol on the under hood label are as follows:



Caution



Air conditioning system.



System lubricant type.



See vehicle service manual for service information.



Requires registered technician to service.



Flammable refrigerant.



Replace safety system components. Do not repair, reuse or try to salvage.

Rear Passenger Climate Control (If Equipped)

IDENTIFYING THE REAR PASSENGER CLIMATE CONTROL UNIT



Note: Depending on your vehicle option package, the controls may look different from what you see here.

SWITCHING THE REAR PASSENGER CLIMATE CONTROLS ON AND OFF



Press and release the button to switch the rear climate control on or off.

Note: If the system is on and Max Defrost is switched on through the front climate controls, the system turns off. It turns back on when Max Defrost is switched off.

Note: If Max Defrost is switched on, the system can be turned on at the same time.

SETTING THE BLOWER MOTOR SPEED

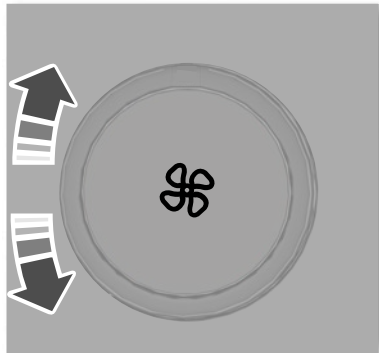

Turn the control to adjust the volume of air circulated in the rear passenger compartment.

SETTING THE TEMPERATURE

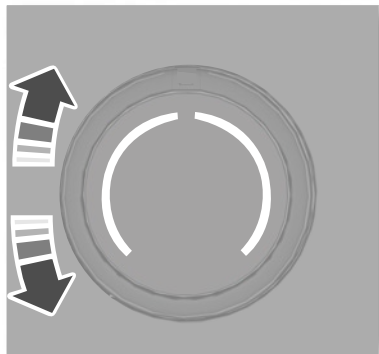

Turn the control to set the temperature in the rear passenger compartment.

Rear Passenger Climate Control (If Equipped)

DIRECTING THE FLOW OF AIR

Directing Air to the Overhead Air Vents



Press and release the button to direct airflow to the overhead air vents.

Directing Air to the Rear Footwell Air Vents



Press and release the button to direct airflow to rear footwell air vents.

Interior Air Quality

WHAT IS THE CABIN AIR FILTER

The cabin air filter improves the quality of air in your vehicle by trapping dust, pollen and other particles.

LOCATING THE CABIN AIR FILTER

You can locate the cabin air filter behind the glove box.

Front Seats

FRONT SEAT PRECAUTIONS

WARNING: Sitting improperly, out of position or with the seatback reclined too far can take weight off the seat cushion and affect the decision of the passenger sensing system, resulting in serious injury or death in the event of a crash. Always sit upright against your seat back, with your feet on the floor.

WARNING: Do not recline the seat backrest too far. This can cause an occupant to slide under the seatbelt in the event of a sudden stop or crash. Failure to follow this instruction can result in personal injury or death.

WARNING: Do not place objects higher than the top of the seat backrest. Failure to follow this instruction could result in personal injury or death in the event of a sudden stop or crash.

WARNING: Do not adjust the driver seat or seat backrest when your vehicle is moving. This may result in sudden seat movement, causing the loss of control of your vehicle.

SITTING IN THE CORRECT POSITION

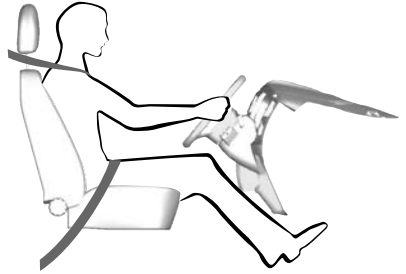

When you use them properly, the seat, head restraint, seatbelt and airbags will provide optimum protection in the event of a crash.

We recommend that you follow these guidelines:

- Sit in an upright position with the base of your spine as far back as possible.
- Do not recline the seat backrest so that your torso is more than 30 degrees from the upright position.
- Adjust the head restraint so that the top of it is level with the top of your head and as far forward as possible. Make sure that you remain comfortable.
- Keep sufficient distance between yourself and the steering wheel. We recommend a minimum of 10 in (25 cm) between your breastbone and the airbag cover.
- Hold the steering wheel with your arms slightly bent.

Front Seats

- Bend your legs slightly so that you can press the pedals fully.
- Position the shoulder strap of the seatbelt over the center of your shoulder and position the lap strap tightly across your hips.

Make sure that your driving position is comfortable and that you can maintain full control of your vehicle.

MANUAL SEATS (IF EQUIPPED)

HEADRESTRAINT COMPONENTS



The head restraints consist of:

- A An energy absorbing head restraint.
- B Two steel stems.
- C Guide sleeve adjust and release button.

ADJUSTING THE HEAD RESTRAINT

WARNING: Fully adjust the head restraint before you sit in or operate your vehicle. This will help minimize the risk of neck injury in the event of a crash. Do not adjust the head restraint when your vehicle is moving.

WARNING: The head restraint is a safety device. Whenever possible it should be installed and properly adjusted when the seat is occupied. Failure to adjust the head restraint properly could reduce its effectiveness during certain impacts.

WARNING: Adjust the head restraints for all passengers before you drive your vehicle. This will help minimize the risk of neck injury in the event of a crash. Do not adjust the head restraints when your vehicle is moving.

Note: Adjust the seat backrest to an upright driving position before adjusting the head restraint. Adjust the head restraint so that the top of it is level with the top of your head and as far forward as possible. Make sure that you remain comfortable. If you are extremely tall, adjust the head restraint to its highest position.

Pull the head restraint up to raise it.

To lower the head restraint:

1. Press and hold the adjust and release button.
2. Push the head restraint down.

Front Seats

MOVING THE SEAT BACKWARD AND FORWARD

WARNING: Do not adjust the driver seat or seat backrest when your vehicle is moving. This may result in sudden seat movement, causing the loss of control of your vehicle.

WARNING: Make sure the seat fully locks into place by rocking it backward and forward. Not securing the seat into the locked position can be dangerous in a crash and could cause serious personal injury or death.



E291151

POWER SEATS

MOVING THE SEAT BACKWARD AND FORWARD - EXCLUDING: POLICE

WARNING: Do not adjust the driver seat or seat backrest when your vehicle is moving. This may result in sudden seat movement, causing the loss of control of your vehicle.



E190838

ADJUSTING THE SEAT BACKREST

WARNING: Always drive and ride with your seatback upright and the lap belt snug and low across the hips.

WARNING: Do not place cargo or any objects behind the seat backrest before returning it to the original position. Pull on the seat backrest to make sure that it has fully latched after returning the seat backrest to its original position. An unlatched seat may become dangerous if you stop suddenly or have a crash.

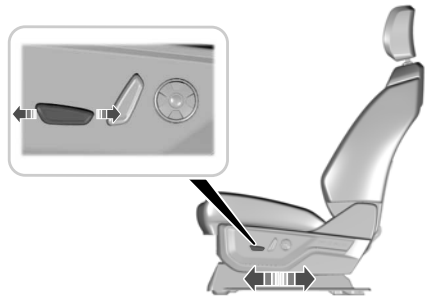

Front Seats

MOVING THE SEAT BACKWARD AND FORWARD - POLICE

WARNING: Do not adjust the driver seat or seat backrest when your vehicle is moving. This may result in sudden seat movement, causing the loss of control of your vehicle.

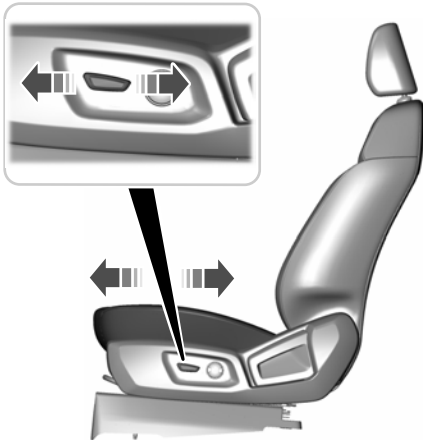

E274074

ADJUSTING THE SEAT CUSHION - EXCLUDING: POLICE

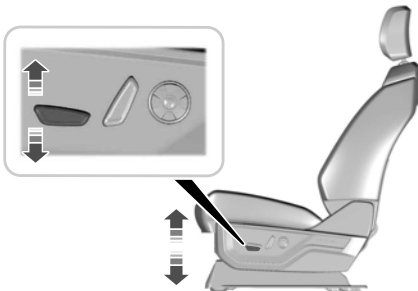

ADJUSTING THE SEAT CUSHION - POLICE

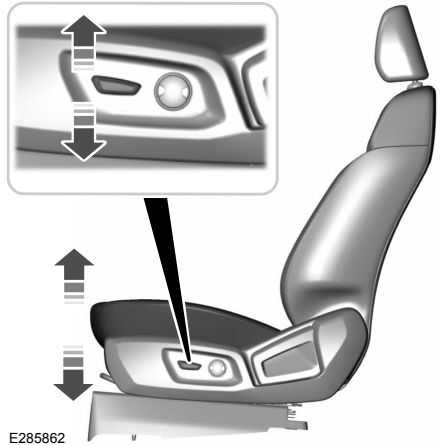

E285862

ADJUSTING THE SEAT BACKREST - EXCLUDING: POLICE

WARNING: Do not adjust the driver seat or seat backrest when your vehicle is moving. This may result in sudden seat movement, causing the loss of control of your vehicle.

WARNING: Do not place cargo or any objects behind the seatback before returning it to the original position.

Front Seats

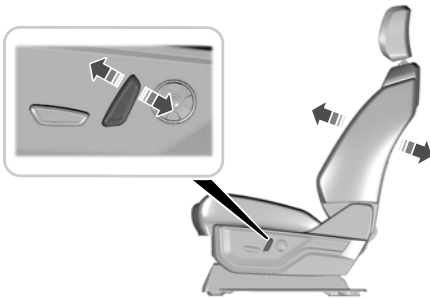

ADJUSTING THE SEAT HEIGHT - EXCLUDING: POLICE

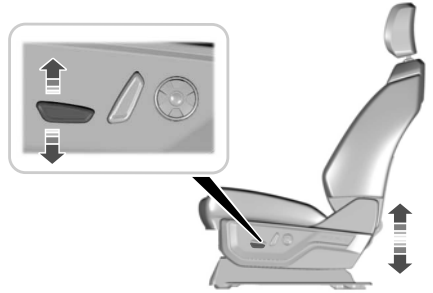

ADJUSTING THE SEAT BACKREST - POLICE



WARNING: Do not adjust the driver seat or seat backrest when your vehicle is moving. This may result in sudden seat movement, causing the loss of control of your vehicle.



WARNING: Do not place cargo or any objects behind the seatback before returning it to the original position.



ADJUSTING THE SEAT HEIGHT - POLICE

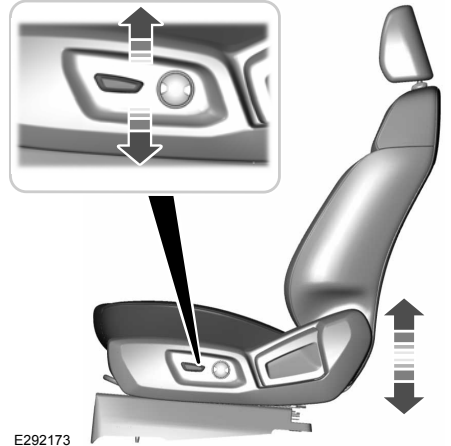

E292173

Front Seats

ADJUSTING THE LUMBAR SUPPORT - EXCLUDING: POLICE

(If Equipped)

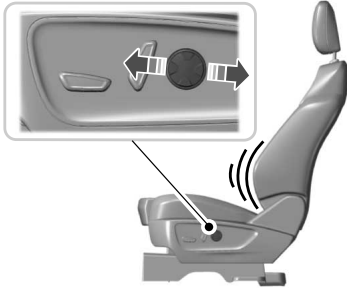

ADJUSTING THE LUMBAR SUPPORT - POLICE (If Equipped)

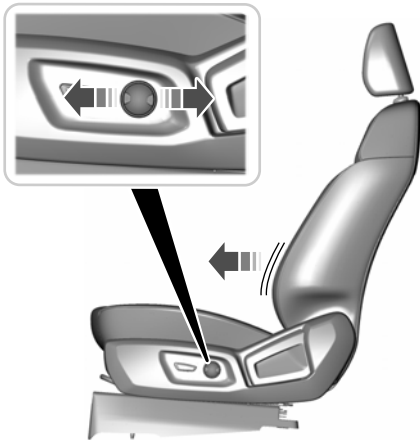

E273887

MESSAGE SEATS (IF EQUIPPED)

MESSAGE SEAT LIMITATIONS

The vehicle must be running or be in accessory mode to activate the seats.

The passenger side message is available if the occupant meets the seat sensor weight requirements.

Allow a few seconds for any selection to activate. Selecting a different adjustment cancels the current one in progress. When the seat backrest and cushion are both active, the massage alternates between zones.

ADJUSTING THE MESSAGE SEAT SETTINGS

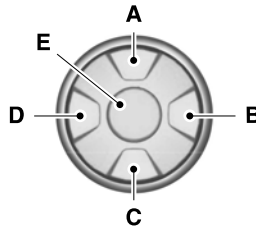

E156301

- A Select the previous massage pattern or lumbar area.
- B Decrease the massage or lumbar Intensity.
- C Select the next massage pattern or lumbar area.
- D Increase the massage or lumbar Intensity.
- E Select the massage or lumbar mode.

Front Seats

You can also adjust this feature through the touchscreen.

HEATED SEATS (IF EQUIPPED)

HEATED SEAT PRECAUTIONS



WARNING: Use caution when using the heated seat if you are unable to feel pain to your skin because of advanced age, chronic illness, diabetes, spinal cord injury, medication, alcohol use, exhaustion or other physical conditions. The heated seat could cause burns even at low temperatures, especially if used for long periods of time. Failure to follow this instruction could result in personal injury.



WARNING: Do not poke sharp objects into the seat cushion or seat backrest. This could damage the heated seat element and cause it to overheat. Failure to follow this instruction could result in personal injury.



WARNING: Do not place anything on the seat that blocks the heat, for example a seat cover or a cushion. This could cause the seat to overheat. Failure to follow this instruction could result in personal injury.

Do not:

- Place heavy objects on the seat.
- Operate the heated seat if water or any other liquid spills on the seat. Allow the seat to dry.

SWITCHING THE HEATED SEATS ON AND OFF

The vehicle must be running to use this feature.



Press the seat symbol on the touchscreen to switch on the heated seats. The more indicators that display, the warmer the temperature of the seat.

Note: *The heated seats may remain on after you remote start your vehicle, based on your remote start settings.*

Note: *The heated seats may turn on when you start your vehicle if they were on when you switched your vehicle off.*

Note: *Select Auto to heat your seat based on your climate control settings, humidity and air temperature.*

VENTILATED SEATS (IF EQUIPPED)

VENTILATED SEAT PRECAUTIONS

Do not:

- Spill liquid on the front seats. This may cause the air vent holes to become blocked and not work properly.
- Place cargo or objects under the seats. They may block the air intake causing the air vents to not work properly.

SWITCHING THE VENTILATED SEATS ON AND OFF

The vehicle must be running to use this feature.

Front Seats



Press the seat symbol on the touchscreen to switch on the cooled seats. More indicator lights indicate higher fan speeds.

Note: *The ventilated seats switch on during a remote start if they are enabled.*

Note: *The ventilated seats may switch on when you start your vehicle if they were on when you previously switched your vehicle off.*

Note: *Select Auto to ventilate your seat based on your climate control settings, humidity and air temperature.*

Rear Seats

MANUAL SEATS

HEADRESTRAINT COMPONENTS

Second Row Center Head Restraint

(If Equipped)

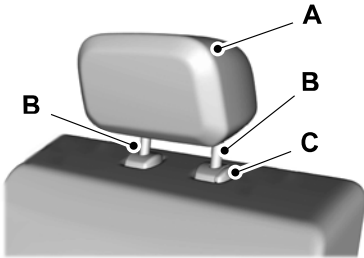

The head restraints consist of:

- A An energy absorbing head restraint.
- B Two steel stems.
- C Guide sleeve adjust and release button.

Second Row Outermost Head Restraints

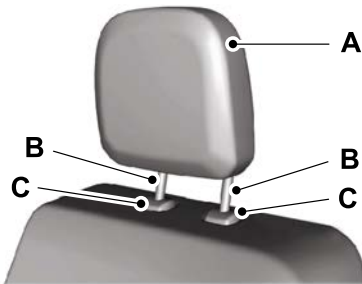

The head restraints consist of:

- A An energy absorbing head restraint.
- B Two steel stems.
- C Guide sleeve unlock and remove buttons.

Third Row Head Restraints

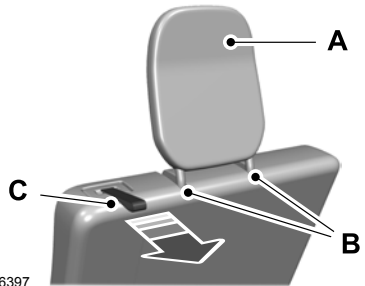

E286397

The head restraints consist of:

- A An energy absorbing head restraint.
- B Two steel stems.
- C Fold strap.

ADJUSTING THE HEAD RESTRAINT

To fold the third row head restraints, pull the fold strap. Pull the head restraint back up to reset.

Note: Press the stow or fold button on the power folding seats to fold the head restraint.

REMOVING THE HEADRESTRAINT

For the second row head restraints:

Rear Seats

1. Press and hold the unlock and remove buttons.
2. Raise the head restraint.

INSTALLING THE HEAD RESTRAINT

Align the steel stems into the guide sleeves and push the head restraint down until it locks.

MOVING THE SEAT BACKWARD AND FORWARD

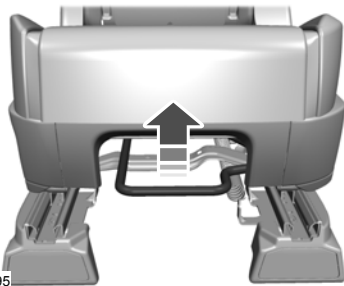

E286395

Lift the handle and move the seat forward or rearward.

ADJUSTING THE SEAT BACKREST



WARNING: Always drive and ride with your seatback upright and the lap belt snug and low across the hips.



WARNING: Do not recline the seat backrest too far. This can cause an occupant to slide under the seatbelt in the event of a sudden stop or crash. Failure to follow this instruction can result in personal injury or death.



Lift the handle and adjust the seat backrest rearward or forward.

FOLDING THE SEAT BACKREST

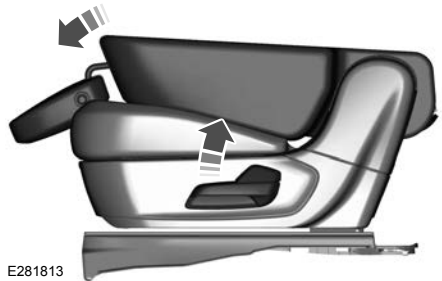

E281813

Lift the handle and fold the seat backrest forward until it is flat.

Note: For bench seats, make sure you unbuckle the center seatbelt before folding the seat backrest.

Rear Seats

Folding the Second Row Center Seat



E281821

Pull the strap to fold the seat backrest flat. To return the seat to the upright position, rotate the seat backrest until it locks.

FOLDING THE SEATS

1. For the third row seats, remove all objects from the seat.

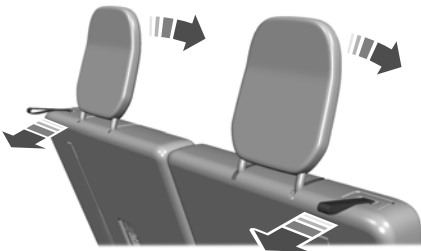

E286398

2. Fold the head restraints by pulling the head restraint release strap.
3. From the rear of the vehicle, fold the seat backrest by pulling and holding the strap while pushing the seat backrest forward. Release the strap once the seat backrest starts rotating forward.

Note: Do not use the seat anchors as cargo tie downs.

Note: Make sure that the area under the seat is free of objects before stowing it.

UNFOLDING THE SEATS



WARNING: Do not place cargo or any objects behind the seat backrest before returning it to the original position. Pull on the seat backrest to make sure that it has fully latched after returning the seat backrest to its original position. An unlatched seat may become dangerous if you stop suddenly or have a crash.

Note: Make sure that there are no objects such as books, purses or briefcases on the load floor before unstowing the seat. Failure to remove all objects from the top of the load floor prior to unstowing it may cause damage to the seat.

Note: Make sure the area under the load floor is free of objects before unstowing it.

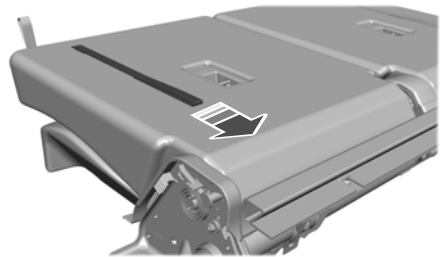

E286399

1. To return the third row seat backrest to the upright position, pull the long strap until the seat backrest locks.
2. Pull the head restraints up to their normal positions.

Rear Seats

ACCESSING THE THIRD ROW SEATS

WARNING: Make sure that the seats and the seat backrests are secure and fully locked. Failure to follow this instruction could result in personal injury or death in a sudden stop or crash.

WARNING: Do not place cargo or any objects behind the seat backrest before returning it to the original position. Pull on the seat backrest to make sure that it has fully latched after returning the seat backrest to its original position. An unlatched seat may become dangerous if you stop suddenly or have a crash.

WARNING: Do not adjust a seat or release a seat floor latch when the vehicle is moving. Failure to follow this instruction could result in personal injury or death in a sudden stop or crash.

Note: You may have to move the front row seat forward to allow the second row seat to be fully folded.

This feature allows for easier entry and exit to and from the third row seat.



E281814

1. Lift the handle on top of the seat backrest. The seat backrest folds forward and engages the seat track.

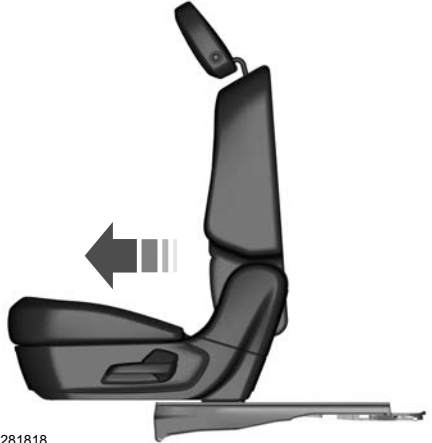

E281818

2. Push the seat forward.
3. To return the seat to the seating position, push the seat backrest and move the track rearward. Make sure the seat backrest locks in the upright position.

POWER SEATS

FOLDING THE SEATS

Note: The power rear seat functions disable 10 minutes after you switch the ignition off. The transmission must be in park (P) and the liftgate must be open to operate the seats.

The buttons are inside the liftgate area.

Rear Seats

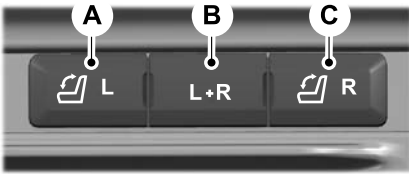

- A Press to fold the left-hand third row seat.
- B Press to fold and unfold both third row seats.
- C Press to fold the right-hand third row seat.

To return the third-row seat backrest to the original position, press the corresponding control again.

If the seats are inoperable, do the following:

1. Make sure that the engine is running and the tailgate is open.
2. Make sure that there are no objects on the seats that would prevent them from completely folding.
3. Press and hold button B for one minute. Continue pressing the button for a few seconds after both seats have stopped moving.
4. Press button A and button C to confirm each seat is operational.

If the power rear seat disables after 10 minutes, you can enable the seat by:

- Opening any door.
- Pressing the unlock button on the key fob.
- Switching the ignition on.

ACCESSING THE THIRD ROW SEATS

 **WARNING:** Do not fold a seat if it is occupied. Failure to follow this instruction could result in personal injury.

The easy entry seat allows for easier entry and exit to and from the third row seat.

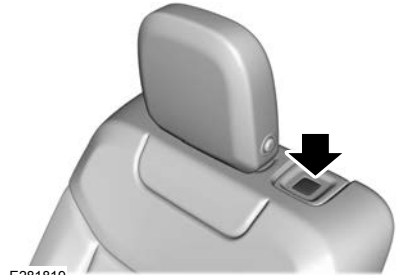

E281819

1. Press the button on top of the second row seat backrest.



E281818

2. Push the seat forward.

Rear Seats

- To return the seat to the seating position, push the seat backrest rearward until it latches.

HEATED SEATS (IF EQUIPPED)

HEATED SEAT PRECAUTIONS



WARNING: Use caution when using the heated seat if you are unable to feel pain to your skin because of advanced age, chronic illness, diabetes, spinal cord injury, medication, alcohol use, exhaustion or other physical conditions. The heated seat could cause burns even at low temperatures, especially if used for long periods of time. Failure to follow this instruction could result in personal injury.



WARNING: Do not poke sharp objects into the seat cushion or seat backrest. This could damage the heated seat element and cause it to overheat. Failure to follow this instruction could result in personal injury.



WARNING: Do not place anything on the seat that blocks the heat, for example a seat cover or a cushion. This could cause the seat to overheat. Failure to follow this instruction could result in personal injury.

Do not:

- Place heavy objects on the seat.
- Operate the heated seat if water or any other liquid spills on the seat. Allow the seat to dry.

SWITCHING THE HEATED SEATS ON AND OFF

The vehicle must be running to use this feature.

The rear seat heat controls are on the rear of the center console.



Press the heated seat symbol to cycle through the various heat settings and off. More indicator lights indicate warmer settings.

Note: *The heated seats may remain on after you remote start your vehicle, based on your remote start settings. The heated seats may also turn on when you start your vehicle if they were on when you switched your vehicle off.*

Automatic Climate Controlled Seats (If Equipped)

When you switch the auto setting on, the climate controlled seats switch between the heated seats and ventilated seats to match your climate control setting.

Rear Occupant Alert System

WHAT IS THE REAR OCCUPANT ALERT SYSTEM

The rear occupant alert system monitors vehicle conditions and notifies you to check for rear seat occupants when you switch the ignition off. The notifications can be in the form of warnings inside the vehicle and sounding of the horn if activated for a short period of time.

HOW DOES THE REAR OCCUPANT ALERT SYSTEM WORK

The system monitors the activity of the buckle on the rear seatbelt and the opening and closing of the rear doors to indicate the potential presence of an occupant in the rear seat.

When Child Seat Installed is selected, the system monitors only the opening and closing of the rear doors to indicate the potential presence of an occupant in the rear seat.

When Child Seat Installed is not selected, the system monitors the rear seatbelt buckle activity and the opening and closing of the rear doors to indicate the potential presence of an occupant in the rear seat.

A message displays in the touchscreen and an audible warning sounds when you switch the ignition off after any of the following conditions have been met:

- A rear door is opened or closed while the ignition is on.
- You switch the ignition on within 15 minutes of a rear door opening and closing.
- You switch the ignition on within 15 minutes of the alert having displayed or sounded.

If you do not open a rear door within a short period of time of the message appearing in the center display, the first audible warning sounding and driver door open to close, the horn sounds for a short period of time.

Note: *Horn sounds only when the Rear Occupant Alert is set to Alert & Horn. If you change the setting, then there is no horn sound.*

REAR OCCUPANT ALERT SYSTEM PRECAUTIONS



WARNING: On hot days, the temperature inside the vehicle can rise very quickly. Exposure of people or animals to these high temperatures for even a short time can cause death or serious heat related injuries, including brain damage. Small children are particularly at risk.



WARNING: Do not leave children or pets unattended in your vehicle. Failure to follow this instruction could result in personal injury or death.

REAR OCCUPANT ALERT SYSTEM LIMITATIONS

The system does not detect the presence of objects or passengers in the rear seat. It monitors the activity of the buckle on the rear seatbelt and the opening and closing of the rear doors.

Note: *It is possible to receive an alert when there is no rear seat occupant, but alert conditions are met.*

Rear Occupant Alert System

Note: It is possible to receive no alert when there is an occupant in the rear seat, if alert conditions are not met. For example, if a rear seat occupant does not enter the vehicle through a rear door.

REAR OCCUPANT ALERT SYSTEM SETTINGS

1. From the settings menu, press Vehicle. See **Center Display** (page 467).
2. Press Rear Occupant Alert.
3. Select Alert & Horn or Alert Only or Off.

Note: The default setting is Alert Only.

Note: If you choose Alert only, the horn does not sound even when the alert conditions are met.

Note: You may also be able to switch the system off through the alert when it appears.

Note: Performing a system reset causes the system to switch on again.

Switching Child Seat Installed On and Off

When the system is switched on, it monitors the opening and closing of the rear doors to indicate the potential presence of an occupant in the rear seat.

1. From the settings menu, press Vehicle. See **Center Display** (page 467).
2. Press Rear Occupant Alert.
3. Switch Child Seat Installed on or off.

Note: The default setting is on.

Switch the system on when the child restraint is mounted on any of the following:

- Forward facing seat.
- Rear facing seat.
- Toddler in a LATCH system child seat.

Switch the system off when the child is using any of the following:

- Seatbelt.
- Booster seat.

Semiannual Reminder

When you switch the system off, a message appears every six months as a reminder that the system is off. You can switch the system back on or leave it off.

REAR OCCUPANT ALERT SYSTEM INDICATORS

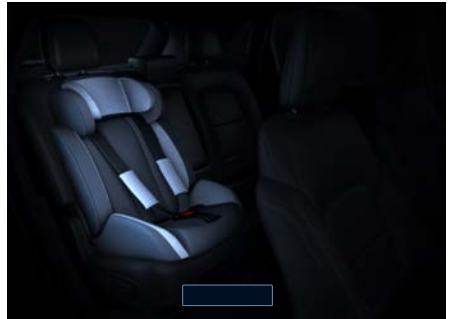

Message

Check rear seat for occupants.

Displays when you switch the power off after the alert conditions are met.

The message displays for a short period of time. Press Close to acknowledge and remove the message.

Note: Depending on your center display system version, the graphic may look different from what you see here.

Rear Occupant Alert System

REAR OCCUPANT ALERT SYSTEM AUDIBLE WARNINGS

The first audible warning is an alert tone within the vehicle, which sounds when you switch your vehicle off after the alert conditions are met. The warning sounds for a short period of time.

The second audible warning is from the horn. It sounds when you do not open a rear door within a short period of time of the message appearing in the center display, the first audible warning sounding, and driver door open to close. The warning sounds for a short period of time.

Memory Function (If Equipped)

HOW DOES THE MEMORY FUNCTION WORK

The memory function recalls the position of these features:

- Memory driver seat.
- Memory power side mirrors.
- Memory steering column.

MEMORY FUNCTION PRECAUTIONS



WARNING: Before activating the memory seat, make sure that the area immediately surrounding the seat is clear of obstructions and that all occupants are clear of moving parts.



WARNING: Do not use the memory function when your vehicle is moving.

LOCATING THE MEMORY FUNCTION BUTTONS



The memory function buttons are on the driver door.

SAVING A PRESET POSITION

1. Switch the ignition on.
2. Adjust the memory features to your preferred position.
3. Press and hold the preferred preset button until you hear a single tone.

A confirmation message appears in the information cluster display.

You can save up to three preset memory positions at any time.

RECALLING A PRESET POSITION

Press and release a preset button.

Note: You can only recall a preset memory position when the ignition is off, or when you place the transmission in park (P) or neutral (N) if the ignition is on and the vehicle is not moving.

Note: Pressing any of the memory feature controls during a memory recall cancels the operation.

You can also recall a preset memory position by:

- Pressing the unlock button on your remote control if you linked it to a preset position.
- Unlocking the intelligent driver door handle if a linked remote control is present.

Note: Using a linked remote control to recall your memory position when the ignition is off moves the seat and steering column to the easy entry position.

Linking a preset position to your remote control. See **Linking or Unlinking a Personal Profile** (page 478).

Garage Door Opener (If Equipped)

GARAGE DOOR OPENER INTRODUCTION

HomeLink Wireless Control System

The universal garage door opener replaces the common handheld garage door opener with a three-button transmitter integrated into the driver-side sun visor.



How Does The Garage Door Opener Work

The system includes two primary features, a garage door opener and a platform for remote activation of devices within the home. You can program garage doors as well as entry gate operators, security systems, entry door locks and home or office lighting.

Additional assistance can be found online at <https://www.homelink.com/Ford> by scanning the code below or by calling the toll-free help line at 1-800-355-3515.



Garage Door Opener Limitations

Canadian radio-frequency laws require transmitter signals to time out, or quit, after several seconds – which may not be long enough for HomeLink to pick up the signal. U.S. gate operators time-out in the same manner.

GARAGE DOOR OPENER PRECAUTIONS AND FREQUENCIES

Garage Door Opener Precautions

WARNING: Do not use the system with any garage door opener that does not have the safety stop and reverse feature as required by U.S. Federal Safety Standards (this includes any garage door opener manufactured before April 1, 1982). A garage door opener which cannot detect an object, signaling the door to stop and reverse, does not meet current federal safety standards. Using a garage door opener without these features increases the risk of serious injury or death.

FCC and RSS-210 Industry Canada Compliance

WARNING: Changes or modifications not expressly approved by the party responsible for compliance could void the user's authority to operate the equipment. The term "IC:" before the radio certification number only signifies that Industry Canada technical specifications were met.

Garage Door Opener (If Equipped)

This device complies with Part 15 of the FCC Rules and with RSS-210 of Industry Canada. Operation is subject to the following two conditions: (1) this device may not cause harmful interference, and (2) this device must accept any interference received, including interference that may cause undesired operation.

This equipment complies with FCC radiation exposure limits set forth for an uncontrolled environment. End Users must follow the specific operating instructions for satisfying RF exposure compliance. This transmitter must be at least 8 in (20 cm) from the user and must not be co-located or operating in conjunction with any other antenna or transmitter.

PROGRAMMING THE GARAGE DOOR OPENER

To clear all stored codes in the garage door opener in your vehicle, use the **clear** function. To override one button, use the **reprogram** function.

Note: Make sure that the garage door and security device are free from obstruction when you are programming. Do not program the system with the vehicle in the garage.

Clearing the Garage Door Opener

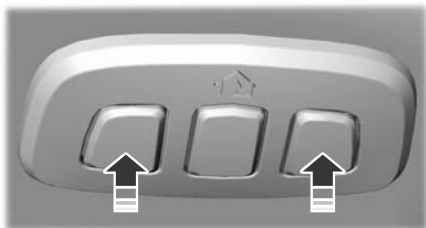

To clear all stored codes in the garage door opener in the vehicle:

1. Press and hold the outer two function buttons simultaneously for approximately 10 seconds until the indicator above the buttons flashes rapidly.
2. When the indicator flashes, release the buttons.

Note: This clears all stored codes. You cannot erase individual buttons.

Note: You can program a maximum of three devices. To change or replace any of the three devices after they have been initially programmed, you must either clear all codes, or reprogram each individual button.

Note: We recommend that upon the sale or lease termination of your vehicle, you erase the programmed function buttons for security reasons.

Reprogramming the Garage Door Opener

If a button on your garage door opener has already been programmed, you can override it. To program a device to a previously trained button:

1. Press and hold the desired button for approximately 20 seconds until the indicator begins to flash.
2. Without releasing the button, proceed to Step 3 of **Programming the Garage Door Opener to your Handheld Transmitter**.

Garage Door Opener (If Equipped)

Programming the Garage Door Opener to your Handheld Transmitter

Note: The programming steps below assume you are programming a HomeLink that was not previously programmed. If your HomeLink was previously programmed, you may need to **clear** or **reprogram** your HomeLink buttons.

Note: Put a new battery in the handheld transmitter. This allows for quicker training and accurate transmission of the radio-frequency signal.

Note: Make sure that the garage door and security device are free from obstruction when you are programming. Do not program the system with the vehicle in the garage.

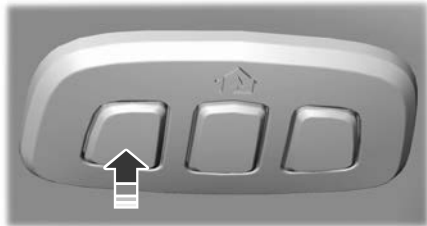

To program your in-vehicle HomeLink function button with your handheld transmitter:

1. With your vehicle parked outside of the garage, switch your vehicle on, but do not start your vehicle.
2. Press and release one of the three HomeLink function buttons that you would like to program.

Note: The indicator should begin to flash. If the indicator does not flash, press and hold the function button for 20 seconds until the indicator begins to flash.

3. Hold your handheld garage door transmitter 1–3 in (2–8 cm.) away from the HomeLink button you want to program.
4. Press and hold the handheld transmitter button you want to program while watching the indicator on HomeLink. Continue to hold the handheld button until the HomeLink indicator flashes rapidly or is continuously on.

Note: You may need to use a different method if you live in Canada or have difficulties programming your gate operator or garage door opener.

5. Press and hold the HomeLink button you programmed for two seconds, then release. You may need to do this twice to activate the door.

Note: If the indicator stays on, the programming is complete.

Note: If the HomeLink indicator flashes rapidly, repeat Step 5.

Note: If your device still does not operate, you must program your garage door.

6. To program additional buttons, repeat Steps 1–4.

Note: Make sure you keep the original remote control transmitter for use in other vehicles as well as for future system programming.

Programming the Garage Door Opener to your Garage Door Opener Motor

Note: Make sure that the garage door and security device are free from obstruction when you are programming. Do not program the system with the vehicle in the garage.

Garage Door Opener (If Equipped)



Programming the Garage Door Opener to your Gate Opener Motor

Gate Operator / Canadian Programming

Canadian radio-frequency laws require transmitter signals to time-out (or quit) after several seconds of transmission – which may not be long enough for HomeLink to pick up the signal during programming. Similar to this Canadian law, some U.S. gate operators are designed to time-out in the same manner.

Note: *If programming a garage door opener or gate operator, it is advised that you unplug the device during the **cycling** process to prevent possible overheating.*

1. Press and release your handheld transmitter, **every two seconds**, until the HomeLink indicator flashes rapidly or is continuously on.
2. Release the handheld transmitter button.
3. Press and hold the HomeLink function button you want to program for two seconds, then release. You may need to do this twice to activate the door.

Note: *If the indicator stays on, the programming is complete.*

Note: *If the HomeLink indicator flashes rapidly, repeat Step 3.*

4. To program additional buttons, repeat Steps 1–4.

Additional assistance can be found online at <https://www.homelink.com/Ford> or by calling the toll-free help line at 1-800-355-3515.

1. Press the learn button on the garage door opener motor and then you have 30 seconds to complete the next two steps.
2. Return to your vehicle.

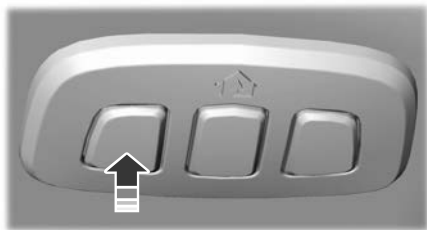

3. Press and hold one of the three HomeLink function buttons you want to program for two seconds, then release.
4. Repeat Step 3. Depending on your brand of garage door opener, you may need to repeat this sequence a third time.

Additional assistance can be found online at <https://www.homelink.com/Ford> by scanning the code below or by calling the toll-free help line at 1-800-355-3515.

USB Ports

LOCATING THE USB PORTS

Data Transfer USB Ports



The USB ports could be in the following locations:

- On the lower instrument panel.
- Inside the center console.

Note: These USB ports can also charge devices.

Note: Not all USB ports in your vehicle have data transfer capabilities.

Note: We recommend using only USB-IF certified cables and adapters. Non-certified cables and adapters may not work.

Charge Only USB Ports



The USB ports could be in the following locations:

- On the lower instrument panel.
- On the upper instrument panel.
- Inside the media bin.
- Inside the center console.
- On the rear of the center console.
- On the rearview mirror bracket.
- Behind the first row seats.
- On the rear interior trim.
- In the cargo area.

PLAYING MEDIA USING THE USB PORT

 **WARNING:** Driving while distracted can result in loss of vehicle control, crash and injury. We strongly recommend that you use extreme caution when using any device that may take your focus off the road. Your primary responsibility is the safe operation of your vehicle. We recommend against the use of any hand-held device while driving and encourage the use of voice-operated systems when possible. Make sure you are aware of all applicable local laws that may affect the use of electronic devices while driving.

Connect your device to the USB port.

-  Press the button on the status bar to open the application drawer.

-  Press the USB option.

-  Press the button to play a track. Press the button again to pause the track.

-  Press the button to skip to the next track.
Press and hold the button to fast forward through the track.

-  Press the button once to return to the beginning of a track. Repeatedly press the button to return to previous tracks.

Press and hold the button to fast rewind.

CHARGING A DEVICE

Connect your device to the USB port.

USB Ports

Data Transfer USB Ports



You can charge your device through the data transfer USB port when the touchscreen is on.

Charge Only USB Ports



You can charge your device through the charge only USB port when the vehicle is in accessory mode or when the vehicle is running.

Power Outlet - Vehicles With: 110V Power Outlet/230V Power Outlet

WHAT IS THE POWER OUTLET

The power outlet is a socket that connects an electrical device to your vehicle's power supply.

POWER OUTLET PRECAUTIONS



WARNING: Do not keep electrical devices plugged into the power outlet whenever the device is not in use. The outlet provides power when the vehicle is on. Failure to follow this instruction could result in personal injury.



WARNING: Do not use an extension cord or connect multiple devices to the power outlet. Doing so could result in overloading the power outlet. Failure to follow this instruction could result in fire, personal injury or property damage.

Note: *The power outlet turns off when you switch off the ignition, or when the battery voltage drops below 11 volts.*

POWER OUTLET LIMITATIONS

Do not use the power outlet for these types of devices:

- Cathode ray tube type televisions.
- Motor loads, for example vacuum cleaners, electric saws and other electric power tools, or compressor-driven refrigerators.

- Measuring devices which process precise data, for example medical equipment or measuring equipment.
- Other appliances requiring an extremely stable power supply, for example microcomputer-controlled electric blankets or touch sensor lamps.

LOCATING THE POWER OUTLETS

The power outlet is on the instrument panel or the rear of the center console.



POWER OUTLET INDICATORS

The power outlet indicator illuminates to indicate system status.

Power Outlet - Vehicles With: 110V Power Outlet/230V Power Outlet

Indicator Status	Description
On	When the indicator is on, the outlet is providing power.
Off	When the indicator is off, there is no power to the outlet.
Flashing	When the indicator is flashing, the outlet is in a fault mode.

Fault mode

If the device exceeds 150 Watts, the power outlet turns off after five attempts to remain active and the indicator flashes. If during the five attempts you reduce the connected load below 150 Watts, the inverter provides power to the load and the indicator turns on. If the overload condition continues after five attempts, reset the system as follows:

1. Unplug your device.
2. Switch your vehicle off to let the system cool and reset the fault mode.
3. Switch your vehicle back on, but do not plug your device back in.
4. With your vehicle on, make sure the indicator remains on.
5. Make sure your device does not exceed the power limits.
6. Plug in your device.

Power Outlet - Vehicles With: 12V Power Outlet

WHAT IS THE POWER OUTLET

The power outlet can power devices using a 12 V outlet adapter.

POWER OUTLET PRECAUTIONS



WARNING: Do not plug electrical devices into the power outlets that exceed the maximum power rating. Incorrect use of the power outlets can cause damage not covered by the vehicle warranty, and can result in fire or personal injury.



WARNING: Do not keep electrical devices plugged into the power outlet whenever the device is not in use. The outlet provides power when the vehicle is on. Failure to follow this instruction could result in personal injury.

When you switch the vehicle on, you can use the power outlets to power 12 V appliances with a maximum current rating of 15 A.

To prevent damage to the vehicle's battery:

- Do not use the power outlets over the vehicle capacity of 12 V DC 180 W or a fuse could blow.
- Do not plug in any device that supplies power to the vehicle through the power outlets. This could result in damage to vehicle systems.
- Do not hang any accessory from the accessory plug. Always keep the power outlets caps closed when not in use.
- Do not insert objects other than an accessory plug into the power outlets.

To prevent the battery from running out of charge:

- Do not use the power outlets longer than necessary when the vehicle is off.
- Do not leave devices plugged in overnight or when you park your vehicle for extended periods.
- Using devices for extended periods may require starting and running the engine to recharge the battery.

LOCATING THE POWER OUTLETS

Power outlets may be in the following locations:

- On the lower instrument panel.
- Inside the center console.
- On the rear of the center console.
- Inside the luggage compartment.

Storage

GLOVE COMPARTMENT

OPENING THE GLOVE COMPARTMENT

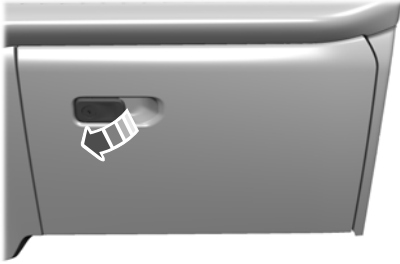

Pull the latch toward the driver side to open.

LOCKING THE GLOVE COMPARTMENT

You can lock the glove compartment using the key.

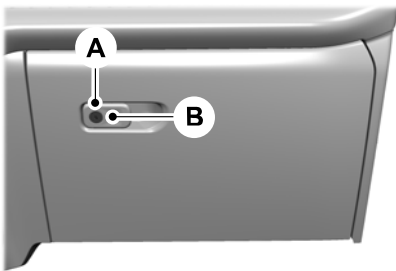

- A Unlock.
- B Lock.

CENTER CONSOLE - EXCLUDING: POLICE

OPENING THE CENTER CONSOLE

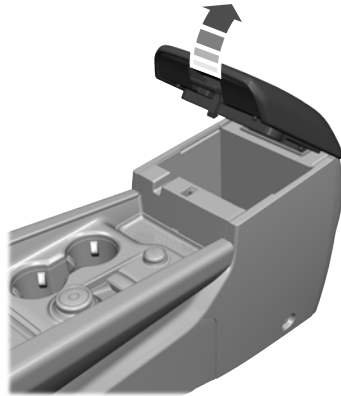

Pull the latch to open the center console.

Storage

UNDER FLOOR STORAGE

LOCATING THE REAR UNDER FLOOR STORAGE

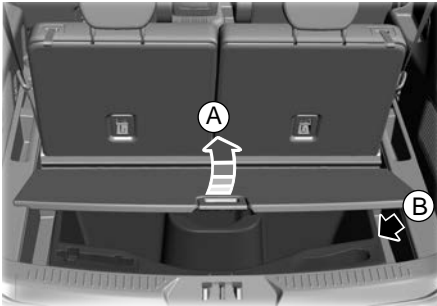

- A Floor cover
- B Storage bin

The storage bin and temporary mobility kit are located under the cargo area floor.

Lift the handle and open the floor cover to access these items.

Note: *The storage bin can be fully removed at any time and replaced with the spare, spare wheel, and jack if required.*

GLASSES HOLDER

LOCATING THE GLASSES HOLDER

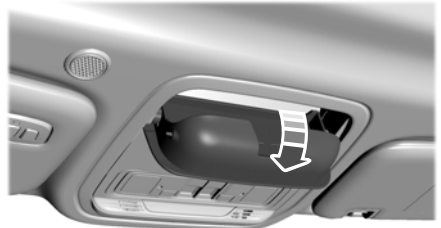

The glasses holder is in the overhead console.

Press near the rear edge of the door to open it.

Starting and Stopping the Engine

STARTING AND STOPPING THE ENGINE – PRECAUTIONS

WARNING: Extended idling at high engine speeds can produce very high temperatures in the engine and exhaust system, creating the risk of fire or other damage.

WARNING: Do not park, idle or drive your vehicle on dry grass or other dry ground cover. The emission system heats up the engine compartment and exhaust system, creating the risk of fire.

WARNING: Do not start the engine in a closed garage or in other enclosed areas. Exhaust fumes are toxic. Always open the garage door before you start the engine. Failure to follow this instruction could result in personal injury or death.

WARNING: Do not use starting fluid, for example ether, in the air intake system. Such fluid could cause immediate explosive damage to the engine and possible personal injury.

WARNING: Exhaust leaks may result in entry of harmful and potentially lethal fumes into the passenger compartment. If you smell exhaust fumes inside your vehicle, have your vehicle inspected immediately. Do not drive if you smell exhaust fumes.

The powertrain control system meets all Canadian interference-causing equipment standard requirements regulating the impulse electrical field or radio noise.

If you stop your vehicle and leave the engine idling for long periods, we recommend that you do one of the following:

- Open the windows at least 1 in (2.5 cm).
- Set your climate control to outside air.

IGNITION SWITCH - POLICE, VEHICLES WITH: KEYED IGNITION



Note: Make sure the key is clean before inserting it into any lock cylinder.

Note: Do not leave the key in the ignition for an extended period of time when the engine is not running. This is to prevent the vehicle battery from losing charge.

Switching the Ignition Off

Turn the key to position **0**.

Starting and Stopping the Engine

Switching the Ignition to Accessory Mode

Turn the key to position **I**. Electrical accessories, for example the radio, operate without the engine running.

Switching the Ignition On

Turn the key to position **II**. All electrical circuits and accessories are operational and the warning lamps and indicators illuminate.

PUSH BUTTON IGNITION SWITCH - VEHICLES WITH: PUSH BUTTON START



Switching the Ignition Off

When the ignition is on or in accessory mode, press the push button ignition switch once without your foot on the brake pedal.

Switching the Ignition to Accessory Mode

When the ignition is off, press the push button ignition switch once without your foot on the brake pedal.

All electrical circuits and accessories are operational and the warning lamps and indicators illuminate.

Note: *Your vehicle has a battery saver feature that shuts your vehicle off when it detects a certain amount of battery drain, or after approximately 30 minutes of inactivity in accessory mode.*

Note: *The system may not function if the passive key is close to metal objects or electronic devices, for example keys or a cell phone.*

Note: *You need a valid passive key inside your vehicle to switch the ignition on and start the engine.*

STARTING THE ENGINE

STARTING A GASOLINE ENGINE - VEHICLES WITH: PUSH BUTTON START

Before starting your vehicle, check the following:

- Make sure that the parking brake is on.
 - Make sure that the transmission is in park (P) for automatic transmissions or neutral (N) for manual transmissions.
1. Fully press the brake pedal for automatic transmissions or clutch pedal for manual transmissions.

Note: *Do not touch the accelerator pedal.*

2. Press the push button ignition switch. See **Push Button Ignition Switch** (page 175).

Note: *The engine may continue cranking for up to 15 seconds or until it starts.*

Note: *The engine takes longer to start at lower temperatures. It may crank for several seconds when very cold.*

Starting and Stopping the Engine

STARTING A HYBRID ELECTRIC VEHICLE SYSTEM - POLICE, VEHICLES WITHOUT: PUSH BUTTON START

Before starting your vehicle, check the following:

- Make sure that the parking brake is on.
 - Make sure that the transmission is in park (P) for automatic transmissions or neutral (N) for manual transmissions.
1. Fully press the brake pedal for automatic transmissions or clutch pedal for manual transmissions.

Note: Do not touch the accelerator pedal.



2. Turn the key to position III.

READY

When you start your vehicle, a green indicator illuminates in the instrument cluster letting you know that your vehicle is ready for driving. Since your vehicle is equipped with a silent key start, the engine may not start when your vehicle starts.

When the engine starts for the first time, the idle speed increases to help warm up the engine. If the idle speed does not decrease, have your vehicle checked by an authorized dealer.

RESTARTING THE ENGINE AFTER STOPPING IT - VEHICLES WITH: PUSH BUTTON START

The system allows you to start the engine within 10 seconds of switching it off, even if it does not detect a valid passive key. After 10 seconds, you can no longer start the engine if the system does not detect a valid passive key.

Within 10 seconds of switching the engine off, fully press the brake pedal for automatic transmissions or clutch pedal for manual transmissions and press the push button ignition switch.

When you start the engine, it remains running until you press the push button ignition switch, even if your vehicle does not detect a valid passive key. If you open and close a door when the engine is running, the system searches for a valid passive key.

ENGINE BLOCK HEATER - VEHICLES WITH: BLOCK HEATER

ENGINE BLOCK HEATER PRECAUTIONS



WARNING: Failure to follow engine block heater instructions could result in property damage or serious personal injury.



WARNING: Do not use your heater with ungrounded electrical systems or two-pronged adapters. There is a risk of electrical shock.

Starting and Stopping the Engine



WARNING: Do not fully close the hood, or allow it to drop under its own weight when using the engine block heater. This could damage the power cable and may cause an electrical short resulting in fire, injury and property damage.

We recommend that you do the following for a safe and correct operation:

- Use a 16-gauge outdoor extension cord that is product certified by Underwriter's Laboratory (UL) or Canadian Standards Association (CSA). This extension cord must be suitable for use outdoors, in cold temperatures, and be clearly marked Suitable for Use with Outdoor Appliances. Do not use an indoor extension cord outdoors. This could result in an electric shock or become a fire hazard.
- Use as short an extension cord as possible.
- Do not use multiple extension cords.
- Make sure that when in operation, the extension cord plug and heater cord plug connections are free and clear of water. This could cause an electric shock or fire.
- If the block heater cord is under the hood, do not remove the wiring from its original location. Do not close the hood on the extension wiring.
- Make sure your vehicle is parked in a clean area, clear of combustibles.
- Make sure the heater, heater cord and extension cord are firmly connected.
- Check for heat anywhere in the electrical hookup once the system has been operating for about 30 minutes.

- Make sure the system is unplugged and properly stowed before starting and driving your vehicle. Make sure the protective cover seals the prongs of the block heater cord plug when not in use.
- Make sure the heater system is checked for proper operation before winter.

HOW DOES THE ENGINE BLOCK HEATER WORK

The engine block heater warms the engine coolant. This allows the climate control system to quickly respond. The equipment includes a heater element installed in the engine block and a wire harness. You can connect the system to a grounded 110 volt AC electrical source.

Note: *The engine block heater is most effective when outdoor temperatures are below 0°F (-18°C). We recommend the use of engine block heater to improve engine cold start performance.*

USING THE ENGINE BLOCK HEATER

1. Make sure the engine is off.
2. Locate the engine block heater cord plug in any one of the following locations: under the hood, in the front fog lamp bezel, or in the front lower grille.
3. Open the protective cover and make sure the receptacle terminals are clean and dry prior to use. Clean them with a dry cloth if necessary.
4. Check the engine block heater cord and extension cord for any damage. If it is damaged, do not use it.
5. Connect the engine block heater cord plug to an extension cord plug.

Starting and Stopping the Engine

6. Plug the extension cord into a grounded 110 volt AC outlet that is protected by a ground fault detection function.

Note: The heater uses 0.4 to 1.0 kilowatt-hours of energy per hour of use. The system does not have a thermostat. It achieves maximum temperature after approximately three hours of operation.

Note: To prevent damage to your vehicle and reduce electrical consumption, do not operate the engine block heater for more than three hours.

7. Before starting the engine, unplug the extension cord from the power outlet and the engine block heater cord plug.

Note: Make sure the protective cover seals the receptacle terminals when not in use.

STOPPING THE ENGINE

STOPPING THE ENGINE WHEN YOUR VEHICLE IS STATIONARY - POLICE, VEHICLES WITHOUT: PUSH BUTTON START

1. Make sure that the transmission is in park (P) for automatic transmissions or neutral (N) for manual transmissions.
2. Apply the parking brake.
3. Wait until the engine reaches idle speed.

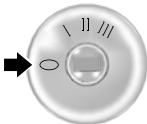

4. Turn the key to position **O**.

STOPPING THE ENGINE WHEN YOUR VEHICLE IS STATIONARY - VEHICLES WITH: PUSH BUTTON START

1. Make sure that the transmission is in park (P) for automatic transmissions or neutral (N) for manual transmissions.
2. Apply the parking brake.
3. Wait until the engine reaches idle speed.
4. Press the push button ignition switch. See **Push Button Ignition Switch** (page 175).

STOPPING THE ENGINE WHEN YOUR VEHICLE IS MOVING - POLICE, VEHICLES WITHOUT: PUSH BUTTON START



WARNING: Switching off the engine when your vehicle is still moving results in a significant decrease in braking assistance. Higher effort is required to apply the brakes and to stop your vehicle. A significant decrease in steering assistance could also occur. The steering does not lock, but higher effort could be required to steer your vehicle. When you switch the ignition off, some electrical circuits, for example airbags, also turn off. If you unintentionally switch the ignition off, shift into neutral (N) and restart the engine.

Only in case of emergency, do the following.

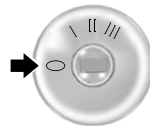

Starting and Stopping the Engine

1. Turn the key to position **0**.
2. Shift into neutral (N) and use the brakes to safely bring your vehicle to a complete stop.
3. Make sure that the transmission is in park (P) for automatic transmissions or neutral (N) for manual transmissions.
4. Apply the parking brake.

STOPPING THE ENGINE WHEN YOUR VEHICLE IS MOVING - VEHICLES WITH: PUSH BUTTON START



WARNING: Switching off the engine when your vehicle is still moving results in a significant decrease in braking assistance. Higher effort is required to apply the brakes and to stop your vehicle. A significant decrease in steering assistance could also occur. The steering does not lock, but higher effort could be required to steer your vehicle. When you switch the ignition off, some electrical circuits, for example airbags, also turn off. If you unintentionally switch the ignition off, shift into neutral (N) and restart the engine.

Only in case of emergency, do the following.

1. Press and hold the push button ignition switch until the engine stops, or press it three times within two seconds. See **Push Button Ignition Switch** (page 175).
2. Shift into neutral (N) and use the brakes to safely bring your vehicle to a complete stop.
3. Make sure that the transmission is in park (P) for automatic transmissions or neutral (N) for manual transmissions.

4. Apply the parking brake.

POLICE ENGINE IDLE - POLICE

WHAT IS POLICE ENGINE IDLE

This allows you to leave the engine running and prevents your vehicle from unauthorized use when you are outside of your vehicle.

HOW DOES POLICE ENGINE IDLE WORK

When you remove the key from the ignition, the engine remains idling.

Switching the System On



1. With your vehicle running and the transmission in park (P), press the police idle button on the instrument panel. An indicator lamp illuminates to confirm the system is on.
2. Switch the ignition off and remove the key.

Starting and Stopping the Engine

When the system is on:

- The power window switches turn off and the windows remain in their current state.
- The interior liftgate unlock button is disabled and will not unlock the rear liftgate.

Note: *When the system is on, you can use the key blade or the remote control to lock and unlock your vehicle.*

Switching the System Off

- To disable police idle and keep the engine running, insert the key and turn to the run position.
- To disable police idle and turn the engine off, press the police idle button on the instrument panel.

Note: *If you switch the system off before switching the ignition to the run position, your vehicle shuts down.*

AUTOMATIC ENGINE STOP - VEHICLES WITH: PUSH BUTTON START

WHAT IS AUTOMATIC ENGINE STOP

Automatic engine stop switches the engine off if it has been idling for an extended period to help you save fuel.

HOW DOES AUTOMATIC ENGINE STOP WORK

Automatic engine stop turns the engine off. The ignition also turns off to save battery power. Before the engine shuts down, a message appears in the instrument cluster display showing a timer counting down. If you do not intervene within 30 seconds, the engine shuts down. Another message appears in the instrument cluster display to inform you that the engine has shut down to save fuel. Start your vehicle as you normally do.

SWITCHING AUTOMATIC ENGINE STOP ON AND OFF

1. From the settings menu, press Vehicle. See **Center Display** (page 467).
2. Switch 30min Max Idle on or off.

Note: *You cannot permanently switch off the automatic engine stop feature. If you switch it off, it turns on automatically at the next ignition cycle.*

OVERRIDING AUTOMATIC ENGINE STOP

You can stop the engine shutdown, or reset the timer, at any point before the 30-second countdown has expired by doing any of the following:

- Pressing the brake pedal or accelerator pedal.
- Pressing the **OK** or **RESET** button during the countdown.

Note: *You cannot permanently switch off the automatic engine stop feature. If you switch it off, it turns on automatically at the next ignition cycle.*

Starting and Stopping the Engine

ACCESSING THE PASSIVE KEY BACKUP POSITION - VEHICLES WITH: PUSH BUTTON START

If you are unable to start your vehicle:

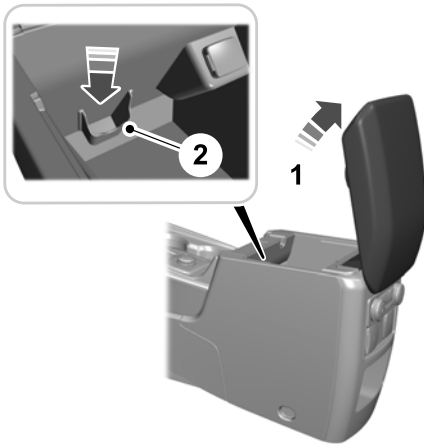

1. Raise the center console storage lid.
2. Place the remote control in the backup slot with the buttons facing toward the rear of the vehicle.
3. Press the brake pedal.
4. Press the push button ignition switch to start the vehicle.

STARTING AND STOPPING THE ENGINE – TROUBLESHOOTING

STARTING AND STOPPING THE ENGINE – WARNING LAMPS

Malfunction Indicator Lamp



If it illuminates when the engine is running, the on-board diagnostics system is detecting a malfunction of the vehicle emission control system.

If it flashes, engine misfire could be occurring. Increased exhaust gas temperatures could damage the catalytic converter or other vehicle components. Avoid heavy acceleration and deceleration, and have your vehicle checked as soon as possible.

Powertrain Warning Lamp



If it illuminates when the engine is running, this indicates a powertrain or four-wheel drive fault. If it flashes when you are driving, immediately reduce the vehicle speed. Avoid heavy acceleration and deceleration, and have your vehicle checked as soon as possible.

If both lamps illuminate when the engine is running, stop your vehicle as soon as it is safe to do so. Continuing to drive your vehicle could cause reduced power or the engine to stop. Switch the ignition off and attempt to restart the engine. Have your vehicle checked as soon as possible.

Starting and Stopping the Engine

Oil Pressure Warning Lamp



It illuminates when you switch the ignition on. If it illuminates when the engine is running, this

indicates a malfunction. Stop your vehicle and switch the engine off. Check the engine oil level. If the oil level is sufficient, this indicates a system malfunction. Have your vehicle checked as soon as possible.

STARTING AND STOPPING THE ENGINE – INFORMATION MESSAGES

Message	Details
Cranking time exceeded	Displays if you exceed the starting time limit. You cannot attempt to start the engine for 15 minutes. If you cannot start the engine after 15 minutes passes, have your vehicle immediately checked.
Starting system fault	Displays if you are unable to start your vehicle with a correctly coded key. The system has detected a fault that requires service. Have your vehicle checked as soon as possible.
No key detected	Displays if the system does not detect a valid passive key.

Starting and Stopping the Engine

STARTING AND STOPPING THE ENGINE – FREQUENTLY ASKED QUESTIONS - GASOLINE, VEHICLES WITH: PUSH BUTTON START

Why is the engine idle speed high when I start the engine?

- The speed the engine idles immediately after starting is optimized to minimize vehicle emissions and maximize cabin comfort and fuel economy.

Why is the engine not cranking?

The engine does not crank if:

- The system does not detect a valid passive key.
- The passive key battery has no charge.
- The vehicle battery does not have sufficient charge.
- The brake pedal is not pressed for automatic transmissions or the clutch pedal is not pressed for manual transmissions.
- The transmission is not in the park (P) or neutral (N) for automatic transmissions.
- The starting system has been disabled after multiple attempts of starting the engine.

What should I do if the starting system is disabled?

- You can only attempt to start the engine for a set number of times before the starting system temporarily disables. If you exceed the limit, a message may appear and you need to wait at least 15 minutes to start the engine again.

What should I do if the engine does not start?

- If you cannot start the engine after three attempts, wait 10 seconds and do the following:
 1. Fully press the brake pedal for automatic transmissions or clutch pedal for manual transmissions.

Note: Make sure that the parking brake is applied.

Note: Make sure that the transmission is in park (P) or neutral (N) for automatic transmissions.

2. Fully press and hold the accelerator pedal.
3. Press the push button ignition switch. See **Push Button Ignition Switch** (page 175).

Note: The engine cranks for a short period of time and then stops.

4. Release the accelerator pedal.
5. Press the push button ignition switch. See **Push Button Ignition Switch** (page 175).

Why do I experience different driving characteristics?

- If you disconnect the battery, your vehicle may exhibit some unusual driving characteristics for about 5 mi (8 km) after you reconnect it. This is because the engine management system must realign itself with the engine. You can disregard any unusual driving characteristics during this period.

Starting and Stopping the Engine

What happens if the system does not detect a valid passive key?

- If the system does not detect a valid passive key, the engine does not start and a warning message displays in the instrument cluster display. To start the engine insert the passive key into the backup position and press the push button ignition switch to start the engine. See **Accessing the Passive Key Backup Position** (page 181).

What happens when driving the vehicle without a valid key?

- When you drive the vehicle without a valid passive key and reach a speed of 3 mph (5 km/h) for the first time after starting the engine, a warning message displays in the instrument cluster display.
- When the ignition is on or in accessory mode and you exit your vehicle with a valid passive key and close all of the doors, a warning message displays in the instrument cluster display.
- A horn sounds in addition to the warning message in the instrument cluster display, when the ignition is on and you exit your vehicle with a valid passive key and close any one of the front doors, and the following conditions are met:
 - Key detection alert is turned on in the center display. See **Keyless Entry Settings** (page 86).
 - A vehicle speed of 16 mph (25 km/h) is reached at least once in the current drive cycle.

Note: A valid passive key is required to start the engine again if you turned the engine off when the warning message was present in the instrument cluster display.

STARTING AND STOPPING THE ENGINE – FREQUENTLY ASKED QUESTIONS - HYBRID ELECTRIC VEHICLE (HEV), VEHICLES WITHOUT: PUSH BUTTON START

Why does the engine not crank?

- When you start your vehicle, a green indicator light appears in the instrument cluster letting you know that your vehicle is ready for driving. Since your vehicle is equipped with a silent key start, the engine may not start when your vehicle starts.

Why is the engine speed high when the engine first starts?

- When the engine starts for the first time on your drive, the idle speed increases, this helps to warm up the engine. If the engine idle speed does not slow down, have your vehicle checked by an authorized dealer.

Why can I not start my vehicle when the high voltage battery is charged?

- Your vehicle has a high voltage to low voltage energy transfer feature that keeps the 12-volt battery charged by the high voltage battery. However 12-volt battery depletion can still occur, and in such case you are unable to start your vehicle. See **12V Battery** (page 385).

Hybrid Electric Vehicle Information - Full Hybrid Electric Vehicle (FHEV)

HYBRID ELECTRIC VEHICLE INFORMATION

A hybrid vehicle has an electric motor and a high voltage battery combined with a gasoline engine. The hybrid vehicle combines electric and gasoline propulsion to provide optimal performance and improved efficiency.

Hybrid Electric Vehicle Driving Characteristics

The gasoline engine starts and stops to provide power when required and to save fuel when not needed. When coasting at low speeds, coming to a stop or standing, the gas engine normally shuts down and your vehicle operates in electric-only mode.

Conditions that may cause the gasoline engine to start or remain running include:

- Considerable vehicle acceleration.
- Driving uphill.
- The high voltage battery charge level is low.
- Heating or cooling the vehicle interior in high or low outside temperatures.
- The gasoline engine is below normal operating temperature.
- Towing a trailer.
- Certain selectable drive modes could cause the engine to run. See **Selecting a Drive Mode** (page 223).

Your hybrid vehicle also comes with standard hydraulic braking and regenerative braking. Regenerative braking is performed by your transmission and captures brake energy and stores it in the high voltage battery.

You could also notice that your engine continues to run instead of shutting off during extended downhill driving. The engine stays on during this engine braking but is not using any fuel.

You could also hear a slight whine or whistle when operating your vehicle. This is the normal operation of the electric motor in the hybrid system.

Note: *Having your engine running is not always an indication of inefficiency. In some cases, it is actually more efficient than driving in electric mode.*

Hybrid Electric Vehicle Indicators

READY When you start your vehicle, a green READY indicator light appears in the instrument cluster letting you know that your vehicle is ready for driving.

The engine may not start because your vehicle has a silent key start feature. This fuel saving feature allows your vehicle to be ready to drive without requiring the gas engine to be running.

The indicator remains on when your vehicle is on, whether the engine is running or not, to indicate your vehicle is capable of movement using the electric motor, gas engine or both.

Typically, the engine does not start unless the vehicle is cold, a climate control change is requested or you press the accelerator pedal.

Hybrid Electric Vehicle Information – Warning Lamps



Illuminates if your vehicle has an electrical component fault or failure that causes your vehicle to shut down or enter a limited operating mode. A message may appear in the instrument cluster display.

Hybrid Electric Vehicle Information - Full Hybrid Electric Vehicle (FHEV)

Hybrid Electric Vehicle Information – Information Messages

Message	Details
Stop safely now	Displays when a malfunction occurs in the high voltage electric system. Stop your vehicle as soon as it is safe to do so. Have your vehicle checked as soon as possible.

What should I do if the vehicle runs out of fuel and the high voltage battery is out of charge?

- Refuel and start your vehicle normally. The engine will recharge the high voltage battery.

Why does the engine sometimes start at key-on?

- The vehicle's computer determines if an engine start is required at key-on. It starts the engine when necessary for cabin heating, windshield defrost, if the high voltage battery is low, or if the outside temperature is low.

Can I put E15 or E85 in my vehicle, and how will it affect my fuel economy?

- Your hybrid vehicle can use E15 (15% ethanol, 85% gasoline) fuel, but you may notice slightly reduced fuel economy because ethanol contains less energy per gallon than gasoline. Your hybrid vehicle is not designed to use E85 (85% ethanol).

Why does it take a long time before the engine shuts down?

- There are several reasons the engine stays on for an extended amount of time when you first start it. One common reason is to make sure that the emissions components are warm enough to minimize tailpipe emission. As the climate gets cooler, the engine-on time is extended.

Why does my engine stay on when it is extremely cold outside?

- In order to make sure that the climate control system can begin heating the cabin or defrosting the windshield as soon as a driver requests it, the engine coolant temperature has to be kept sufficiently hot. Keeping the engine on is required to maintain the correct coolant temperature.

POWER FLOW

The power flow shows how power is being used in the vehicle and also displays reasons for engine operation.



The power flow information for your hybrid vehicle is available through the Home screen or under Apps.

Vehicle Operational States

Power flows to or from the front and rear wheels depending on operational state and driving conditions.

- Idling: The vehicle is running and in park (P). The engine and, or the high voltage battery are on.
- Electric driving: The vehicle is running and in drive (D) or neutral (N) or reverse (R). The high voltage battery provides power to the wheels.

Hybrid Electric Vehicle Information - Full Hybrid Electric Vehicle (FHEV)

- **Hybrid driving:** The vehicle is running and in drive (D) or neutral (N) or reverse (R). The engine and the high voltage battery provide power to the wheels.
- **Regenerative braking:** The vehicle is running in drive (D) and is slowing down. The regenerative braking system captures power and sends it back to the high voltage battery.
- **Engine braking active:** The engine is on to provide increased powertrain braking. This can occur when you turn on the grade assist feature, when speed control is on or when driving with your foot off the accelerator pedal. Turning off grade assist or speed control may allow the vehicle to return to electric operation.

Engine On Due To

The following conditions help explain why the engine is on and what you can do to allow all electric operation.

- **Drive power:** The engine is on due to accelerator pedal pressure or speed control activation. Reduce pressure on the accelerator pedal or switch off the speed control to return to full electric mode.
- **High speed:** The engine is on because the vehicle speed exceeds the level for full electric operation. Reduce the speed to return to electric operation.
- **Heater setting:** The engine is on because of the heater setting. Reduce or switch off the heater setting to return to electric operation.
- **Engine cold:** The engine is on because it is cold. The vehicle returns to electric operation once the engine is sufficiently warm.
- **Battery charging:** The engine is on to charge the high voltage battery. The vehicle returns to electric operation once the battery is sufficiently charged.
- **Low gear:** The engine is on because the vehicle is in low (L). Shift out of low (L) to return to electric operation.
- **Normal operation:** The engine is on to optimize vehicle operation. The vehicle returns to electric operation when possible.
- **Battery temperature:** The engine is on due to high or low high voltage battery temperature. This is a normal operating condition. The vehicle returns to electric operation when possible.
- **Drive mode:** The engine is on due to the drive mode selection. Select an appropriate drive mode for electric only operation.

Auto-Start-Stop - Excluding: Full Hybrid Electric Vehicle (FHEV)

WHAT IS AUTO-START-STOP

The system is designed to help reduce fuel consumption and CO₂ emissions by stopping the engine when it is idling, for example at traffic lights.

AUTO-START-STOP PRECAUTIONS



WARNING: Apply the parking brake, shift into park (P), switch the ignition off and remove the key before you leave your vehicle. Failure to follow this instruction could result in personal injury or death.



WARNING: Apply the parking brake, shift into park (P), switch the ignition off and remove the key before you open the hood or have any service or repair work completed. If you do not switch the ignition off, the engine could restart at any time. Failure to follow this instruction could result in personal injury or death.

SWITCHING AUTO-START-STOP ON AND OFF

The system turns on when you switch the ignition on.



Press the button to switch the system off.

Note: **OFF** illuminates in the switch.

Note: Deactivating the system using the button lasts only one key cycle.

Press the button again to switch the system back on.

Note: The system turns off if it detects a malfunction. If the system malfunctions, have your vehicle checked as soon as possible.

STOPPING THE ENGINE

Stop your vehicle, keep your foot on the brake pedal and the transmission in drive (D).

RESTARTING THE ENGINE

Release the brake pedal or press the accelerator pedal.

A message appears in the instrument cluster display if the system requires you to take action.

AUTO-START-STOP INDICATORS



WARNING: The system may require the engine to automatically restart when the auto-start-stop indicator illuminates green or flashes amber. Failure to follow this instruction could result in personal injury.



The auto-start-stop indicator illuminates green when the engine stops. It flashes amber and a message appears when you need to take action.



The auto-start-stop indicator illuminates gray with a strikethrough when the system is not available.

Auto-Start-Stop - Excluding: Full Hybrid Electric Vehicle (FHEV)

AUTO-START-STOP – TROUBLESHOOTING

AUTO-START-STOP – INFORMATION MESSAGES

A message appears in the instrument cluster display if the system requires you to take action.

Message	Condition	Action
Auto StartStop Press Brake to Start Engine	The system needs to restart the engine but requires your confirmation.	Press the brake pedal to restart the engine.
Auto StartStop Press a Pedal to Start Engine	The system needs to restart the engine but requires your confirmation.	Press the brake pedal or the accelerator pedal to restart the engine.

Auto-Start-Stop - Excluding: Full Hybrid Electric Vehicle (FHEV)

AUTO-START-STOP – FREQUENTLY ASKED QUESTIONS

Why does the engine not always stop when I expect it to?

The system is designed to work in a way that complements other vehicle systems, allowing them to operate at optimum performance.

The system does not stop the engine if:

- The driver door is open.
- Your vehicle is at high altitude.
- The heated windshield is on.
- The engine is warming up.
- The outside temperature is too low or too high.
- The battery charge is low.
- The battery temperature is outside the optimal operating range.
- The engine is required to run to maintain interior climate and reduce fogging.

Why does the engine sometimes restart when I do not expect it to?

The system is designed to work in a way that complements other vehicle systems, allowing them to operate at optimum performance.

The system restarts the engine if:

- You switch the heated windshield on.
- You switch maximum defrost on.
- Your vehicle starts to roll downhill in neutral.
- The engine is required to run to maintain adequate brake system assistance.
- The engine is required to run to maintain interior climate and reduce fogging.

Can I permanently switch the system off?

No. The system plays an important role in reducing the fuel consumption and the CO₂ emissions.

Will the frequent engine starts cause parts to wear out?

Your vehicle has an enhanced battery and starter motor that are designed for the increased number of engine starts.

Fuel and Refueling

FUEL AND REFUELING PRECAUTIONS

 **WARNING:** Fuels can cause serious injury or death if misused or mishandled.

 **WARNING:** Fuel may contain benzene, which is a cancer-causing agent.

 **WARNING:** Read and follow all the instructions on the pump island.

 **WARNING:** When refueling always shut the engine off and never allow sparks or open flames near the fuel tank filler valve. Never smoke or use a cell phone while refueling. Fuel vapor is extremely hazardous under certain conditions. Avoid inhaling excess fumes.

Follow these guidelines when refueling:

- Extinguish all smoking materials and any open flames before refueling your vehicle.
- Switch the engine off before refueling.
- Automotive fuels can be harmful or fatal if swallowed. Fuel is highly toxic and if swallowed can cause death or permanent injury. If fuel is swallowed immediately call a physician, even if no symptoms are immediately apparent. The toxic effects of fuel may not be apparent for hours.
- Avoid inhaling fuel vapors. Inhaling fuel vapor can lead to eye and respiratory tract irritation. In severe cases, excessive or prolonged breathing of fuel vapor can cause serious illness and permanent injury.

- Avoid getting fuel in your eyes. If you splash fuel in your eyes, immediately remove contact lenses, if worn, flush with water for 15 minutes and seek medical attention. Failure to seek proper medical attention could lead to permanent injury.
- Fuels can be harmful if absorbed through the skin. If you splash fuel on your skin, clothing or both, promptly remove contaminated clothing and thoroughly wash your skin with soap and water. Repeated or prolonged skin contact causes skin irritation.
- Be particularly careful if you are taking Antabuse or other forms of Disulfiram for the treatment of alcoholism. Breathing fuel vapors could cause an adverse reaction, serious personal injury or sickness. Immediately call a physician if you experience any adverse reactions.

FUEL QUALITY

SELECTING THE CORRECT FUEL

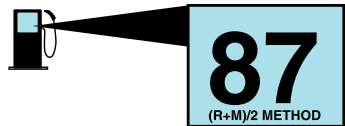

Your vehicle operates on regular unleaded gasoline with a minimum pump (R+M)/2 octane rating of 87.

Some fuel stations, particularly those in high altitude areas, offer fuels posted as regular unleaded gasoline with an octane rating below 87. The use of these fuels could result in engine damage that will not be covered by the vehicle Warranty.

Fuel and Refueling

For best overall vehicle and engine performance, premium fuel with an octane rating of 91 or higher is recommended. The performance gained by using premium fuel is most noticeable in hot weather as well as other conditions, for example when towing a trailer. See **Towing a Trailer** (page 333).

Do not be concerned if the engine sometimes knocks lightly. However, if the engine knocks heavily while using fuel with the recommended octane rating, contact an authorized dealer to prevent any engine damage.

We recommend Top Tier detergent gasolines, where available to help minimize engine deposits and maintain optimal vehicle and engine performance.

For additional information, visit <https://www.toptiergas.com>.



Note: *Use of any fuel for which the vehicle was not designed can impair the emission control system, cause loss of vehicle performance, and cause damage to the engine which may not be covered by the vehicle Warranty.*

Do not use:

- Diesel fuel.
- Fuels containing kerosene or paraffin.
- Fuel containing more than 15% ethanol (E15) or E85 fuel.
- Fuels containing methanol.
- Fuels containing metallic-based additives, including manganese-based compounds.

- Fuels containing the octane booster additive, methylcyclopentadienyl manganese tricarbonyl (MMT).
- Leaded fuel, using leaded fuel is prohibited by law.

The use of fuels with metallic compounds such as methylcyclopentadienyl manganese tricarbonyl, which is a manganese-based fuel additive, will impair engine performance and affect the emission control system.

LOCATING THE FUEL FILLER FUNNEL

The fuel filler funnel is in the spare wheel storage tray.

RUNNING OUT OF FUEL

FILLING A PORTABLE FUEL CONTAINER



WARNING: Flow of fuel through a fuel pump nozzle can produce static electricity. This can cause a fire if you are filling an ungrounded fuel container.

Use the following guidelines to avoid electrostatic charge build-up, which can produce a spark, when filling an ungrounded fuel container:

- Only use an approved fuel container to transfer fuel to your vehicle. Place the container on the ground when filling it.
- Do not fill a fuel container when it is inside your vehicle (including the cargo area).
- Keep the fuel pump nozzle in contact with the fuel container when filling it.
- Do not use a device that holds the fuel pump nozzle lever in the fill position.

Fuel and Refueling

ADDING FUEL FROM A PORTABLE FUEL CONTAINER

WARNING: Do not insert the nozzle of a fuel container or an aftermarket funnel into the fuel filler neck. This may damage the fuel system filler neck or its seal and cause fuel to run onto the ground.

WARNING: Do not pry open the fuel tank filler valve. This could damage the fuel system. Failure to follow this instruction could result in fire, personal injury or death.

WARNING: Do not dispose of fuel in the household refuse or the public sewage system. Use an authorized waste disposal facility.

When refueling the vehicle fuel tank from a fuel container, use the fuel filler funnel included with your vehicle. See **Locating the Fuel Filler Funnel** (page 192).

Note: Do not use aftermarket funnels as they may not work with the capless fuel system and can damage it.

When refueling the vehicle fuel tank from a fuel container, do the following:

1. Fully open the fuel filler door.



2. Fully insert the fuel filler funnel into the fuel filler inlet.
3. Add fuel to your vehicle from the fuel container.
4. Remove the fuel filler funnel.
5. Fully close the fuel filler door.
6. Clean the fuel filler funnel and place it back in your vehicle or correctly dispose of it.

Note: If your vehicle runs out of fuel add a minimum of 1.0 gal (3.8 L) of fuel to restart the engine.

Note: You may need to switch the ignition from off to on several times after refueling to allow the fuel system to pump the fuel from the tank to the engine. When restarting, cranking time takes a few seconds longer than normal.

Note: Extra funnels can be purchased from an authorized dealer if you choose to dispose of the funnel.

Fuel and Refueling

REFUELING

REFUELING SYSTEM OVERVIEW

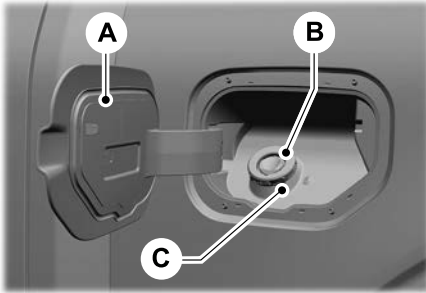

- A Fuel filler door.
- B Fuel filler inlet.
- C Fuel tank filler pipe.

REFUELING YOUR VEHICLE - EXCLUDING: FULL HYBRID ELECTRIC VEHICLE (FHEV)

WARNING: When refueling always shut the engine off and never allow sparks or open flames near the fuel tank filler valve. Never smoke or use a cell phone while refueling. Fuel vapor is extremely hazardous under certain conditions. Avoid inhaling excess fumes.

WARNING: Fuel vapor burns violently and a fuel fire can cause severe injuries.

WARNING: The fuel system may be under pressure. If you hear a hissing sound near the fuel filler inlet, do not refuel until the sound stops. Otherwise, fuel may spray out, which could cause serious personal injury.

WARNING: Keep children away from the fuel pump. Never let children pump fuel.

WARNING: Do not pry open the fuel tank filler valve. This could damage the fuel system. Failure to follow this instruction could result in fire, personal injury or death.

WARNING: Stay outside your vehicle and do not leave the fuel pump unattended when refueling your vehicle.

WARNING: Do not remove the fuel pump nozzle from its fully inserted position when refueling.

WARNING: Stop refueling when the fuel pump nozzle automatically shuts off for the first time. Failure to follow this will fill the expansion space in the fuel tank and could lead to fuel overflowing.

WARNING: Do not overfill the fuel tank. The pressure in an overfilled tank may cause leakage and lead to fuel spray and fire.

WARNING: Wait at least five seconds before removing the fuel pump nozzle to allow any residual fuel to drain into the fuel tank.

1. Fully open the fuel filler door.
2. Select the correct fuel pump nozzle for your vehicle.

Fuel and Refueling

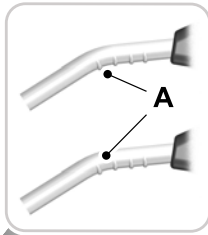

3. Insert the fuel pump nozzle up to the first notch. Keep the fuel pump nozzle resting on the fuel tank filler pipe.

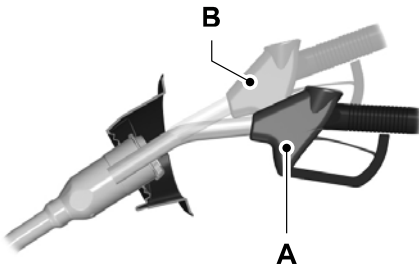

4. Hold the fuel pump nozzle in position A when refueling. Holding the fuel pump nozzle in position B can affect the flow of fuel and shut off the fuel pump nozzle before the fuel tank is full.

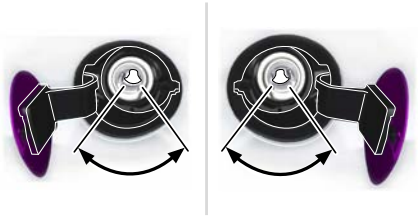

5. Operate the fuel pump nozzle within the area shown.

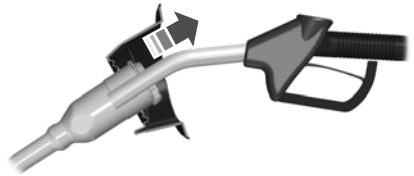

6. When the pump shuts off, wait five seconds, then raise the fuel pump nozzle and slowly remove it.
7. Fully close the fuel filler door.

Note: Do not attempt to start the engine if you have filled the fuel tank with incorrect fuel. Incorrect fuel use could cause damage not covered by the vehicle Warranty. Have your vehicle immediately checked.

REFUELING YOUR VEHICLE - FULL HYBRID ELECTRIC VEHICLE (FHEV)

WARNING: When refueling always shut the engine off and never allow sparks or open flames near the fuel tank filler valve. Never smoke or use a cell phone while refueling. Fuel vapor is extremely hazardous under certain conditions. Avoid inhaling excess fumes.

Fuel and Refueling

WARNING: The fuel system may be under pressure. If you hear a hissing sound near the fuel filler inlet, do not refuel until the sound stops. Otherwise, fuel may spray out, which could cause serious personal injury.

WARNING: Fuel vapor burns violently and a fuel fire can cause severe injuries.

WARNING: Keep children away from the fuel pump. Never let children pump fuel.

WARNING: Stay outside your vehicle and do not leave the fuel pump unattended when refueling your vehicle.

WARNING: Do not pry open the fuel tank filler valve. This could damage the fuel system. Failure to follow this instruction could result in fire, personal injury or death.

WARNING: Do not remove the fuel pump nozzle from its fully inserted position when refueling.

WARNING: Stop refueling when the fuel pump nozzle automatically shuts off for the first time. Failure to follow this will fill the expansion space in the fuel tank and could lead to fuel overflowing.

WARNING: Do not overfill the fuel tank. The pressure in an overfilled tank may cause leakage and lead to fuel spray and fire.

WARNING: Wait at least five seconds before removing the fuel pump nozzle to allow any residual fuel to drain into the fuel tank.

1. When you stop your vehicle, shift into park (P) and switch the ignition off.



2. Press the button on the instrument panel next to the headlamp switch to open the fuel filler door. The fuel filler door can take up to 15 seconds to open before you can insert a fuel filler nozzle.

Note: Avoid pressing the button and blocking the fuel filler door at the same time. If an issue occurs, press the fuel filler door open button again to reset the fuel filler door lock mechanism.

3. Select the correct fuel pump nozzle for your vehicle.

Fuel and Refueling

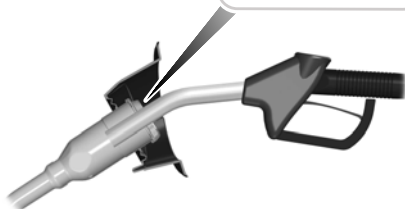
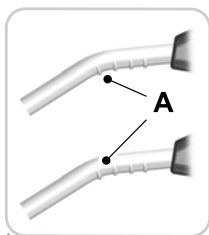

4. Insert the fuel pump nozzle up to the first notch. Keep the fuel pump nozzle resting on the fuel tank filler pipe.

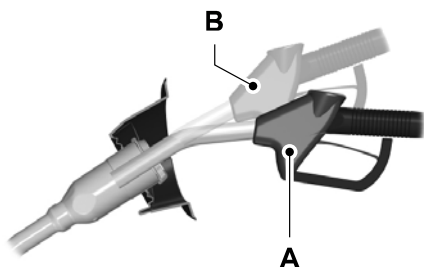

5. Hold the fuel pump nozzle in position A when refueling. Holding the fuel pump nozzle in position B can affect the flow of fuel and shut off the fuel pump nozzle before the fuel tank is full.

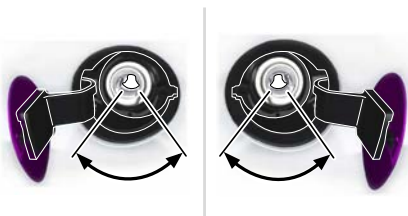

6. Operate the fuel pump nozzle within the area shown.

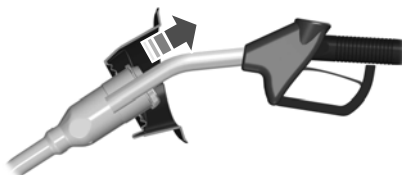

7. When the pump shuts off, wait 5 seconds, then raise the fuel pump nozzle and slowly remove it.
8. Close the fuel filler door.

Note: To close the fuel filler door, press and release the center rear edge of the fuel filler door.

Complete the refueling process within 20 minutes. If 20 minutes elapses, press the button on the instrument panel again. Fuel pump nozzle automatic shut off could occur if you do not press the button on instrument panel.

Note: Do not attempt to start the engine if you have filled the fuel tank with incorrect fuel. Incorrect fuel use could cause damage not covered by the vehicle warranty. Have your vehicle immediately checked.

Fuel and Refueling

MANUALLY OPENING THE FUEL FILLER DOOR - FULL HYBRID ELECTRIC VEHICLE (FHEV)



WARNING: The fuel system may be under pressure. If you hear a hissing sound near the fuel filler inlet, do not refuel until the sound stops. Otherwise, fuel may spray out, which could cause serious personal injury.

Note: The transmission must be in park (P) or neutral (N).

When using the manual override cable do the following:

1. Switch the ignition on.

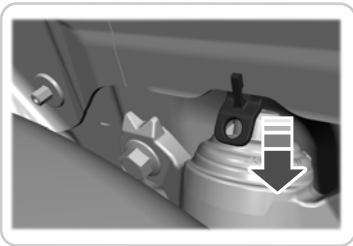

Note: The manual override cable is in the left side rear wheel well area.

2. Pull the manual override cable down.

Note: Pull the manual override cable once. Repeated pulls can damage the manual override cable.

Note: Make sure the manual override cable moves freely without any obstructions.

3. Switch the ignition off.
4. Complete the refueling process within 20 minutes.
5. Return the manual override cable to its original position.

Note: Only follow this procedure if the fuel filler door fails to open. If the problem remains, have your vehicle checked as soon as possible.

Fuel and Refueling

FUEL TANK CAPACITY - EXCLUDING: FULL HYBRID ELECTRIC VEHICLE (FHEV)

Capacities

Variant	Quantity
2.3L.	17.9 gal (67.8 L)
3.0L, 3.3L.	20.2 gal (76.5 L)

Advertised Capacity

The advertised capacity is the maximum amount of fuel that you can add to the fuel tank when the fuel gauge indicates empty.

In addition, the fuel tank contains an empty reserve. The empty reserve is an unspecified amount of fuel that remains in the fuel tank when the fuel gauge indicates empty.

Note: *When refueling your vehicle after the fuel gauge indicates empty, you might not be able to refuel the full amount of the advertised capacity due to the empty reserve still present in the fuel tank.*

FUEL TANK CAPACITY - FULL HYBRID ELECTRIC VEHICLE (FHEV)

Capacities

Variant	Quantity
All.	18.0 gal (68.1 L)

Advertised Capacity

The advertised capacity is the maximum amount of fuel that you can add to the fuel tank when the fuel gauge indicates empty.

In addition, the fuel tank contains an empty reserve. The empty reserve is an unspecified amount of fuel that remains in the fuel tank when the fuel gauge indicates empty.

Note: *When refueling your vehicle after the fuel gauge indicates empty, you might not be able to refuel the full amount of the advertised capacity due to the empty reserve still present in the fuel tank.*

FUEL AND REFUELING – TROUBLESHOOTING

FUEL AND REFUELING – WARNING LAMPS



If it illuminates when you are driving, refuel as soon as possible.

Fuel and Refueling

FUELANDREFUELING – INFORMATION MESSAGES - EXCLUDING: FULL HYBRID ELECTRIC VEHICLE (FHEV)

Message	Action
Fuel level low	An early reminder of a low fuel condition. Refill your vehicle.
Check Fuel Fill Inlet	Check to make sure the fuel fill inlet is fully closed.

Fuel and Refueling

FUEL AND REFUELING – INFORMATION MESSAGES - FULL HYBRID ELECTRIC VEHICLE (FHEV)

Message	Action
Fuel level low	An early reminder of a low fuel condition.
Check Fuel Fill Inlet	The fuel fill inlet may not be properly closed.
Please wait for fuel door to open	Appears while the fuel system is depressurizing with the fuel filler door closed. Wait for the fuel system to depressurize and for the fuel filler door to unlatch.
Fuel Door Open	Appears when the fuel system has depressurized and opened the fuel filler door. Open the fuel filler door to refuel and close the fuel filler door when refueling is complete.
Fuel door ajar Close fully to avoid Check Engine light	Your vehicle is equipped with a sealed fuel system that requires the fuel filler door to be closed after refueling. This warning message appears when the fuel filler door is ajar. Close the fuel filler door to avoid the Check Engine light. If you see this message and the Check Engine light illuminates, close the fuel filler door. The Check Engine light should clear within five seconds. If the Check Engine light persists, see your dealer.
Refuel Error See Manual	Appears when the fuel system fails to depressurize, or the fuel filler door fails to open. You have to use the fuel filler door manual override cable when opening the fuel door.

Catalytic Converter

WHAT IS THE CATALYTIC CONVERTER

The catalytic converter is part of your vehicle's emissions system and filters harmful pollutants from the exhaust gas.

CATALYTIC CONVERTER PRECAUTIONS



WARNING: Do not park, idle or drive your vehicle on dry grass or other dry ground cover. The emission system heats up the engine compartment and exhaust system, creating the risk of fire.



WARNING: The normal operating temperature of the exhaust system is very high. Never work around or attempt to repair any part of the exhaust system until it has cooled. Use special care when working around the catalytic converter. The catalytic converter heats up to a very high temperature after only a short period of engine operation and stays hot after the engine is switched off.



WARNING: Exhaust leaks may result in entry of harmful and potentially lethal fumes into the passenger compartment. If you smell exhaust fumes inside your vehicle, have your vehicle inspected immediately. Do not drive if you smell exhaust fumes.

To avoid damaging the catalytic converter:

- Do not crank the engine for more than 10 seconds at a time.
- Do not run the engine with a spark plug lead disconnected.
- Do not push-start or tow-start your vehicle. Use booster cables. See **Jump Starting the Vehicle** (page 346).

- Use the correct fuel. See **Fuel and Refueling** (page 191).
- Do not switch the ignition off when your vehicle is moving.
- Avoid running out of fuel.
- Have the items listed in scheduled maintenance information performed according to the specified schedule.

Note: Do not make any unauthorized changes to your vehicle or engine. By law, vehicle owners and anyone who manufactures, repairs, or services a fleet of vehicles are not permitted to intentionally remove an emission control device or prevent it from working.

CATALYTIC CONVERTER – TROUBLESHOOTING

CATALYTIC CONVERTER – WARNING LAMPS

Your vehicle has an on-board diagnostics system that monitors the emission control system. If any of the following warning lamps illuminate, this may indicate that the on-board diagnostics system has detected an emission control system malfunction.



Continuing to drive your vehicle may cause reduced power or the engine to stop. Failure to respond to a warning lamp may cause damage that your vehicle Warranty may not cover. Have your vehicle checked as soon as possible.

High Voltage Battery - Full Hybrid Electric Vehicle (FHEV)/ Police

WHAT IS THE HIGH VOLTAGE BATTERY

The high voltage battery is a highly sophisticated lithium ion battery system, used to store electric energy to power your vehicle.

HIGH VOLTAGE BATTERY PRECAUTIONS



WARNING: This battery pack should only be serviced by an authorized electric vehicle technician. Improper handling can result in personal injury or death.



WARNING: Keep your hands and clothing clear of the cooling fan.



WARNING: Apply the parking brake, shift into park (P), switch the ignition off and remove the key before you open the hood or have any service or repair work completed. If you do not switch the ignition off, the engine could restart at any time. Failure to follow this instruction could result in personal injury or death.



WARNING: Do not touch the electronic ignition system parts after you have switched the ignition on or when the engine is running. The system operates at high voltage. Failure to adhere to this warning could result in serious personal injury or death.

Your vehicle consists of various high-voltage components and wiring. All of the high-voltage power flows through specific wiring assemblies labeled as such or covered with a solid orange convolute, or orange striped tape, or both. Do not come in contact with these components.

RECYCLING AND DISPOSING OF THE HIGH VOLTAGE BATTERY

Please recycle in accordance with local regulations.

HIGH VOLTAGE BATTERY – TROUBLESHOOTING

HIGH VOLTAGE BATTERY – INFORMATION MESSAGES

Message	Details
Stop safely now Exit vehicle in safe area	Safely stop and exit your vehicle as soon as possible, then call for emergency assistance.

Automatic Transmission

AUTOMATIC TRANSMISSION PRECAUTIONS



WARNING: When your vehicle is stationary, keep the brake pedal fully pressed when shifting gears. Failure to follow this instruction could result in personal injury, death or property damage.



WARNING: Do not apply the brake pedal and accelerator pedal simultaneously. Applying both pedals simultaneously for more than a few seconds limits vehicle performance, which may result in difficulty maintaining speed in traffic and could lead to serious injury.



WARNING: Apply the parking brake, shift into park (P), switch the vehicle off and remove the key or remote control before you leave your vehicle. Failure to follow this instruction could result in personal injury or death.

AUTOMATIC TRANSMISSION POSITIONS

PARK (P) - EXCLUDING: POLICE



WARNING: Shift into park (P) only when your vehicle is stationary.

In park (P) power is not transmitted to the driven wheels.

Note: A tone sounds if you attempt to exit your vehicle without the vehicle in park (P).

Note: Your vehicle may not shift out of park (P) if the 12V battery has run out of charge.

Note: Your vehicle may not shift out of park (P) if a fuse is blown.

Note: Your vehicle may not shift out of park (P) unless the key or remote control is inside your vehicle.

Note: The electronic parking brake could apply when you power your vehicle on with the selector in park (P).

Note: The electronic parking brake could apply if you shift to park (P) without fully pressing the brake pedal.

Note: The electronic parking brake could apply if you shift to park (P) on a slope.

Note: Do not manually release the parking brake when the selector is in park (P). See **Automatically Releasing the Electric Parking Brake** (page 233).

Note: Your vehicle could shift into park (P) if you attempt to exit your vehicle without the transmission in park (P). See **Automatic Return to Park (P)** (page 208).

Note: A tone could sound when you select park (P).

PARK (P) - POLICE



WARNING: Shift into park (P) only when your vehicle is stationary.

In park (P) power is not transmitted to the driven wheels.

Note: A tone sounds if you attempt to exit your vehicle without the vehicle in park (P).

Note: Your vehicle may not shift out of park (P) if the 12V battery has run out of charge.

Note: Your vehicle may not shift out of park (P) if a fuse is blown.

Note: Your vehicle may not shift out of park (P) unless the key or remote control is inside your vehicle.

Automatic Transmission

Note: The electronic parking brake could apply when you power your vehicle on with the selector in park (P).

Note: The electronic parking brake could apply if you shift to park (P) without fully pressing the brake pedal.

Note: The electronic parking brake could apply if you shift to park (P) on a slope.

Note: Do not manually release the parking brake when the selector is in park (P). See **Automatically Releasing the Electric Parking Brake** (page 233).

REVERSE (R)



WARNING: Shift into reverse (R) only when your vehicle is stationary.

In reverse (R) power is transmitted to the driven wheels.

NEUTRAL (N)



WARNING: In neutral (N) your vehicle is free to roll.

In neutral (N) power is not transmitted to the driven wheels.

DRIVE (D)

In drive (D) power is transmitted to the driven wheels.

LOW (L) - POLICE

In low (L) your vehicle decelerates more noticeably than in drive (D) when the accelerator pedal is released.

Note: We recommend using this mode for driving on hilly or mountainous roads or when towing a trailer. See **Towing a Trailer** (page 333).

MANUAL (M) - EXCLUDING: POLICE

In manual (M) you can select a specific gear. See **Manually Shifting Gears** (page 206).

Note: We recommend using this mode for driving on hilly or mountainous roads or when towing a trailer. See **Towing a Trailer** (page 333).

SHIFTING YOUR VEHICLE INTO GEAR - EXCLUDING: POLICE



The selector is on the center console.

1. Press and hold the brake pedal.
2. Rotate the outer ring to select a position.

Note: Your vehicle cannot shift from drive (D) to park (P) with a clockwise rotation. Your vehicle cannot shift from park (P) to drive (D) with a counterclockwise rotation.

3. Press the low (L) or manual (M) or sport (S) button when your vehicle is in drive (D) to enter or exit mode.

Automatic Transmission

SHIFTING YOUR VEHICLE INTO GEAR - POLICE

The transmission selector is on the steering column.



1. Press and hold the brake pedal.
2. Move the lever to select a position.

Press the low (L) button when your vehicle is in drive (D) to enter or exit mode.

AUTOMATIC TRANSMISSION POSITION INDICATORS - EXCLUDING: POLICE

The instrument cluster displays the current position.



Note: The position could illuminate on the selector.

AUTOMATIC TRANSMISSION POSITION INDICATORS - POLICE

The instrument cluster displays the current position.



Note: The position could illuminate on the selector.

MANUALLY SHIFTING GEARS - EXCLUDING: POLICE

Shifting Using the Paddle Shifters

The instrument cluster displays the current gear. The current gear flashes when your vehicle cannot shift into the requested gear. Your vehicle will not shift if the requested gear raises or lowers the engine speed beyond the limit.

Your vehicle could shift when you fully press the accelerator or brake pedal.

Note: Prolonged driving with high engine speed could cause vehicle damage not covered by vehicle warranty.

Note: Drive modes could affect when the vehicle shifts into the requested gear.



Manually Shifting in Drive (D)

Use this feature to temporarily change gear.

Note: We recommend using this feature for engine braking or driving on hilly or mountainous roads.

- Pull any paddle to switch the feature on.
- Pull the right (+) paddle to upshift.

Automatic Transmission

- Pull the left (-) paddle to downshift.
- Hold the (+) paddle for a few seconds to switch the feature off.

Note: *The feature switches off after a short period of time if neither paddle is pulled.*

Manually Shifting in Sport (S)

Use this feature to select a specific gear.

Note: *We recommend using this feature for engine braking, driving on hilly or mountainous roads, or when towing a trailer. See **Towing a Trailer** (page 333).*

- Pull any paddle to switch the feature on.
- Pull the right (+) paddle to upshift.
- Pull the left (-) paddle to downshift.
- Hold the (+) paddle for a few seconds to switch the feature off.

TEMPORARY NEUTRAL MODE

How Does Temporary Neutral Mode Work

Use this mode to keep your vehicle in neutral (N), for a limited time, when you exit your vehicle or switch your vehicle off. For example, if you exit your vehicle before an automatic car wash.

Note: *You do not need to use this mode at an automatic car wash if you shift into neutral (N) and stay in your vehicle with power on.*

Note: *Do not tow your vehicle in this mode.*

Note: *Automatic return to park (P) is delayed when your vehicle is in this mode. See **Automatic Return to Park (P)** (page 208).*

Temporary Neutral Mode Limitations

This mode could be unavailable if your 12 V battery charge level is low. Connect an external power source and attempt the procedure again.

Your vehicle could shift to park (P) after 30 minutes, or when the vehicle battery charge level is low. Prolonged use of this mode can cause the 12 V battery to run out of charge.

This mode could be unavailable if your vehicle is below operating temperature. Warm up your vehicle and attempt the procedure again.

Do not tow your vehicle in this mode. Failure to follow these instructions could result in vehicle damage not covered by the vehicle warranty.

Entering Temporary Neutral Mode

1. Bring your vehicle to a complete stop.
2. Press and hold the brake pedal.
3. Power your vehicle on.
4. Shift into neutral (N).

Note: *An instructional message appears.*

5. Press the manual (M) button.

Note: *A confirmation message appears when your vehicle enters the mode.*

6. Release the brake pedal.

Note: *Your vehicle is free to roll.*

7. Switch your vehicle off.

Note: *Do not tow your vehicle in this mode.*

Note: *The neutral (N) indicator on the transmission selector may flash in this mode.*

Exiting Temporary Neutral Mode

1. Press the brake pedal.

Automatic Transmission

- Shift into park (P), or power your vehicle on and shift into drive (D) or reverse (R).

AUTOMATIC RETURN TO PARK (P) - EXCLUDING: POLICE

How Does Automatic Return to Park (P) Work

Your vehicle shifts into park (P) when your vehicle is stationary and any of the following occur:

- You switch the vehicle off.
- You open the driver door with your seatbelt unfastened.
- You unfasten the driver seatbelt when the driver door is open.

Note: Do not use automatic return to park (P) when your vehicle is moving, except in an emergency. See **Stopping the Engine When Your Vehicle is Moving** (page 178).

Automatic Return to Park (P) Limitations

Automatic return to park (P) may not work if any of the following occur:

- The driver door ajar sensor is malfunctioning.
- The driver seatbelt sensor is malfunctioning.

See an authorized dealer if any of the following occur:

- Seatbelt indicator illuminates or tone sounds with the driver seatbelt fastened.
- Door ajar indicator does not illuminate with the driver door open.

- Door ajar indicator illuminates with the driver door closed.
- Transmission not in park message appears, with the driver door closed, after you shift out of park (P).

GRADE ASSIST

How Does Grade Assist Work

This feature helps maintain vehicle speed when driving down a slope. The system uses a combination of engine motoring and regenerative braking to maintain vehicle speed.

Note: You could hear engine speed increasing and decreasing. This is normal operation.

The system activates when all the following occur:

- Your vehicle is on a downhill slope.
- The selector is in drive (D).
- You release the accelerator pedal.

SHIFTING YOUR IMMOBILE VEHICLE OUT OF PARK (P) - EXCLUDING: POLICE



WARNING: When doing this procedure, you need to take the transmission out of park (P) which means your vehicle can roll freely. To avoid unwanted vehicle movement, apply the parking brake prior to doing this procedure. Use wheel chocks if appropriate.



WARNING: Do not drive your vehicle until you verify that the stoplamps are working.

Automatic Transmission

Use this procedure to shift your vehicle out of park (P) in the event of an electrical malfunction or emergency.

Activating Manual Park Release

1. Apply the parking brake.

Note: If the 12V battery has run out of charge, use an external power source to apply the parking brake.

2. Remove the access cover located within the center console using a screwdriver.

Note: Do not pull the lever.

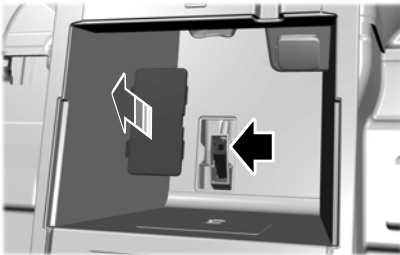

3. Sit in the driver seat.
4. Power your vehicle on without your foot on the brake pedal.

Note: Do not attempt this procedure when the engine is running. Failure to follow this instruction could result in vehicle damage not covered by the vehicle warranty.

5. Press and hold the brake pedal.
6. Insert the tool into the lever slot. Pull the lever towards the rear of the vehicle until it engages.

Note: The lever clicks as it engages.

Note: A tool longer than 5 in (120 mm) could hit the underside of the armrest console before the lever engages.

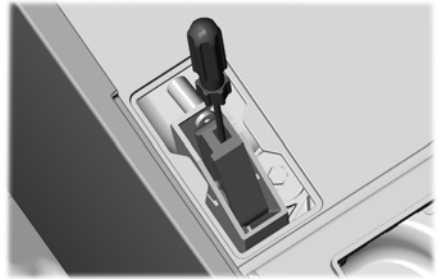

Note: Do not use excessive force. Failure to follow this instruction could result in vehicle damage not covered by the vehicle warranty.

Note: A message appears when your vehicle is out of park (P). If you do not receive a message attempt the procedure again.

Note: A warning lamp could illuminate.

7. Release the parking brake.
8. Switch your vehicle off.
9. Release the brake pedal.
10. Disconnect the negative battery cable from the 12V battery as soon as it is safe to do so.

Note: If your vehicle detects wheel speed when the 12V battery is connected, the electronic parking brake could apply.

Returning Your Vehicle to Normal Mode

1. Connect the negative battery cable to the 12V battery as soon as it is safe to do so.

Note: If your vehicle detects wheel speed when the 12V battery is connected, the electronic parking brake could apply.

2. Apply the parking brake.

Automatic Transmission

Note: If the 12V battery has run out of charge, use an external power source to apply the parking brake.

3. Sit in the driver seat.
4. Press and hold the brake pedal.

Note: Do not start your vehicle.

5. Insert the tool into the lever slot. Push the tool down and pull towards the rear of the vehicle to release the lever. Remove the tool. The lever returns to the stowed position automatically.
6. Start your vehicle.
7. Confirm the instrument cluster displays park (P).

Note: If the instrument cluster does not display park (P), the warning lamp remains illuminated, or a message persists contact an authorized dealer for service.

8. Switch your vehicle off.
9. Release the brake pedal.
10. Install the access cover.

SHIFTING YOUR IMMOBILE VEHICLE OUT OF PARK (P) - POLICE



WARNING: When doing this procedure, you need to take your vehicle out of park (P) which means your vehicle can roll freely. To avoid unwanted vehicle movement, apply the parking brake prior to doing this procedure. Use wheels chocks if appropriate.

Use this procedure to shift your vehicle out of park (P) in the event of an electrical malfunction or emergency.

Overriding the Brake Shift Interlock Actuator

You must turn the ignition on and press the brake pedal to shift your vehicle out of park (P). If you still cannot shift out of park (P) with the ignition on and the brake pedal pressed, perform the following steps:

1. Apply the parking brake.

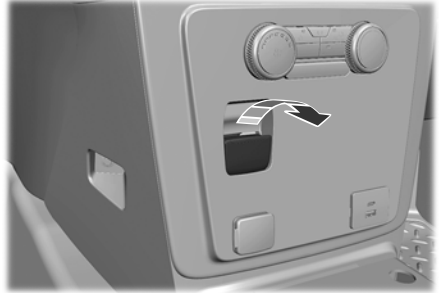

2. Fully extend and lower the steering column.

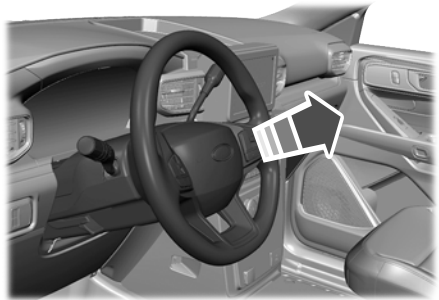

3. Release the upper steering column shroud clips.

Automatic Transmission

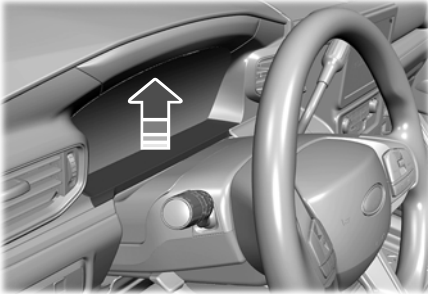

- Using a screwdriver, turn the steering wheel to the left 90 degrees to release the left clip, then to the right 180 degrees to release the right clip.

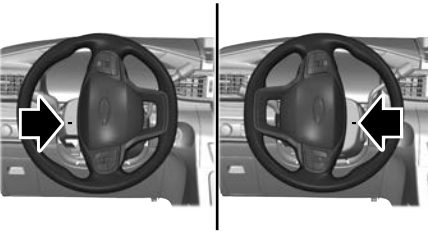

- Remove the upper steering column shroud. Release the upper steering column shroud tabs.

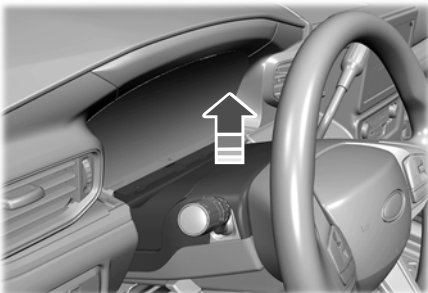

- Remove the lower underside bolts and lower the steering column cover.

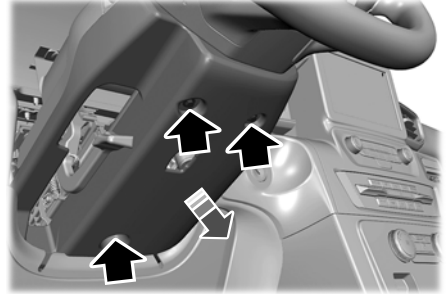

- Move the brake shift interlock actuator spindle inward, apply the brake pedal and position the selector lever into neutral (N).

Note: Use a screwdriver to move the plunger.

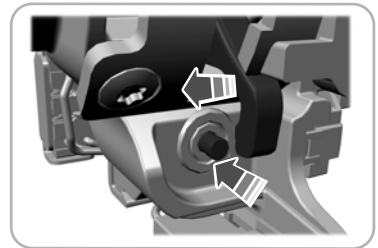

- Start the vehicle.

Returning Your Vehicle to Normal Mode

- Reverse the removal steps to return to normal mode.

Automatic Transmission

AUTOMATIC TRANSMISSION AUDIBLE WARNINGS - EXCLUDING: POLICE

Transmission Not In Park (P) Audible Warning

Sounds if you open the driver door before shifting into park (P).

AUTOMATIC TRANSMISSION AUDIBLE WARNINGS - POLICE

Transmission Not In Park (P) Audible Warning

Sounds if any of the following occur:

- You switch your vehicle off before shifting into park (P).
- You open the driver door before shifting into park (P).

AUTOMATIC TRANSMISSION FLUID CAPACITY AND SPECIFICATION

Materials

Name	Specification
Motorcraft® MERCON® ULV Automatic Transmission Fluid(U.S.) Motorcraft® MERCON® ULV Automatic Transmission Fluid / MERCON® ULV huile pour boîtes automatique Motorcraft®(Canada) XT-12-QULV(U.S. & Canada)	WSS-M2C949-A,

Note: Only use transmission fluid that conforms to the defined specification. Use of other fluids could result in vehicle damage not covered by the vehicle warranty.

Automatic Transmission

AUTOMATIC TRANSMISSION – INFORMATION MESSAGES

Message	Description
Park brake not applied	The electric parking brake is not fully applied.
Transmission not in Park	A reminder to shift into park. In addition, this message typically appears after reconnecting or recharging the battery until you cycle the ignition to the on mode.
Shift system fault Confirm park brake Apply before exiting the vehicle	Displays when there is a system fault and the park brake needs to be pressed before exiting the vehicle. Have your vehicle checked as soon as possible.
Transmission Malfunction Service Now	The system has detected a fault that requires service. Have your vehicle checked as soon as possible.
Select L To Confirm Stay In Neutral Mode	Displays when you shift into neutral (N).

Message	Description
Select M To Confirm Stay In Neutral Mode	Displays when you shift into neutral (N).
Stay in Neutral Mode Engaged	Displays to confirm that your vehicle has entered Stay in Neutral Mode.
Select N To Confirm Stay In Neutral Mode	Displays when you shift into neutral (N).

All-Wheel Drive

HOW DOES ALL-WHEEL DRIVE WORK



WARNING: Vehicles with a higher center of gravity (utility and four-wheel drive vehicles) handle differently than vehicles with a lower center of gravity (passenger cars). Avoid sharp turns, excessive speed and abrupt steering in these vehicles. Failure to drive cautiously increases the risk of losing control of your vehicle, vehicle rollover, personal injury and death.

This system is a proactive system. It has the ability to anticipate wheel slip and transfer torque to the front wheels before slip occurs. Even when wheel slip is not present, the system is continuously adjusting to the torque distribution, in an attempt to improve straight line and cornering behavior, both on and off road.

The system automatically turns on every time you switch the ignition on.

If any component requires maintenance, a message appears in the information display.

The all-wheel drive system is designed to continuously monitor and adjust power delivery to the front and rear wheels to optimize both traction and handling. The AWD system turns on when needed and does not require input from you.

Your all-wheel drive vehicle is not intended for off-road use. The AWD feature gives your vehicle some limited off-road capabilities in which driving surfaces are relatively level, obstruction-free and otherwise similar to normal on-road driving conditions. Operating your vehicle in conditions other than those, could subject the vehicle to excess stress that might result in damage that is not covered under your warranty.

Note: *The transfer case and front axle in police vehicles does not require any normal scheduled maintenance. The system is electronically monitored and notifies you of required service in the instrument cluster display. The front axle lube is more likely to require a fluid change if the vehicle has experienced extended periods of extreme/severe duty cycle driving. Severe duty cycle driving such as Driver Training or EVOC. See **General Maintenance Information** (page 492). Do not check or change the transfer case and front axle lubricant unless the unit shows signs of leakage or displays a message indicating required service. Contact an authorized dealer for service if the front driveline was submerged in water and to reset any driveline temperature lube life monitors.*

When an AWD system fault is present, and the system is overheated or if service is required, a message appears in the instrument cluster display. The display messages, along with the triggering actions and description of the message, are shown in the following table:

ALL-WHEEL DRIVE LIMITATIONS

Operating All-Wheel Drive (AWD) Vehicles With Spare Tires

Do not use a different size spare tire other than the tire provided. If the mini-spare tire is installed, the AWD system will disable and enter rear-wheel drive only mode to protect driveline components. Some limited AWD traction could be provided if the mini-spare is installed on one of the front wheels. If you are in driving conditions where limited AWD traction is needed while the mini-spare is installed, it is recommended the mini-spare be installed on the front axle.

All-Wheel Drive

If the mini-spare is installed, this condition is indicated by a warning in the information display. If there is a warning message in the information display from using the spare tire, this indicator should turn off after reinstalling or replacing the normal road tire and cycling the ignition off and on. We recommended reinstalling or replacing the normal road tire as soon as possible. Major dissimilar tire sizes between the front and rear axles could cause the AWD system to stop functioning and default to rear-wheel drive or damage the AWD system.

The AWD system can still activate if the mini spare is installed on a front wheel. If the mini spare is installed on a rear wheel the AWD system will fully disable. In situations where there is a wintery mix or an off road situation and you need to use a mini spare, you must install the mini spare in the front tire position and move a full size tire to the rear tire position for the AWD system to function.

Operating AWD Vehicles With Mismatched Tires



WARNING: Only use replacement tires and wheels that are the same size, as those originally provided for your vehicle. The required tire and wheel sizes, along with the minimum required Load and Speed Index, can be found on the Tire Label on the driver side door frame or the edge of the driver door. If this information is not found in those locations, or for additional options, contact your authorized dealer. Use of any tire or wheel not recommended, could affect the safety and performance of your vehicle, which could result in an increased risk of loss of vehicle control, vehicle rollover, personal injury and death.

Major dissimilar tire sizes between the front and rear axles (for example, 17 inch low profile tires on the front axle and 22 inch high profile tires on the rear axle) could cause the AWD system to stop functioning and default to rear-wheel drive or damage the AWD system. For optimum AWD Performance, it is recommended to follow the tire rotation maintenance schedule. To avoid potential AWD malfunction or AWD system damage, it is recommended to replace all four tires rather than mixing significantly worn tires with new tires. Using 3 worn tread tires and 1 new tread tire all of the same original tire size/brand, can be tolerated by the AWD system as long as the worn tires still have usable tread depth.

How Utility Vehicles Differ from Other Vehicles

Truck and utility vehicles can differ from some other vehicles. Your vehicle may be higher to allow it to travel over rough terrain without getting hung up or damaging underbody components.

The differences that make your vehicle so versatile also make it handle differently than an ordinary passenger car.

Maintain steering wheel control at all times, especially in rough terrain. Since sudden changes in terrain can result in abrupt steering wheel motion, make sure you grip the steering wheel from the outside. Do not grip the spokes.

Drive cautiously to avoid vehicle damage from concealed objects such as rocks and stumps.

You should either know the terrain or examine maps of the area before driving. Map out your route before driving in the area. To maintain steering and braking control of your vehicle, you must have all four wheels on the ground and they must be rolling, not sliding or spinning.

All-Wheel Drive

ALL-WHEEL DRIVE – INFORMATION MESSAGES

AWD Messages	Action / Description
AWD Off	Displays when the all-wheel drive system automatically disables to protect itself. This may be caused by operating the vehicle with a temporary spare tire installed, or if the system detects dissimilar size tires, or if there is an issue with another vehicle system preventing AWD operation. The system will resume normal operation and clear this message after you cycle the ignition off and on and drive a short distance with the road tire re-installed, or after the other vehicle system issues are resolved.
AWD Restored	Displays once the all-wheel drive system resumes normal operation after the system cools.
AWD Temporarily Disabled	Displays when the all-wheel drive system has temporarily turned off to protect itself from overheating.
AWD Temporarily Locked	Displays when the all-wheel drive system is locking up the torque transfer clutch to help reduce clutch temperature.
AWD Fault Service Required	Displays if the all-wheel drive system is not operating properly. Displays in conjunction with the powertrain fault indicator light. If the warning stays illuminated or continues to illuminate, contact an authorized dealer as soon as possible.

Four-Wheel Drive

HOW DOES FOUR-WHEEL DRIVE WORK



WARNING: Vehicles with a higher center of gravity (utility and four-wheel drive vehicles) handle differently than vehicles with a lower center of gravity (passenger cars). Avoid sharp turns, excessive speed and abrupt steering in these vehicles. Failure to drive cautiously increases the risk of losing control of your vehicle, vehicle rollover, personal injury and death.

This system is a proactive system. It has the ability to anticipate wheel slip and transfer torque to the front wheels before slip occurs. Even when wheel slip is not present, the system is continuously adjusting to the torque distribution, in an attempt to improve straight line and cornering behavior, both on and off road.

The system automatically turns on every time you switch the ignition on.

If any component requires maintenance, a message appears in the information display.

The intelligent 4WD system continuously monitors vehicle conditions and adjusts the power distribution between the front and rear wheels. It combines transparent all-surface operation with highly capable four-wheel drive.

The 4WD system is always active and requires no driver input. It is capable of handling all road conditions including street and highway driving as well as off-road and winter driving. You can optimize more 4WD control by selecting different drive modes. See **What Is Drive Mode Control** (page 223).

Note: A warning message displays in the instrument cluster display when a 4WD system fault is present. See **Four-Wheel Drive – Information Messages** (page 220). A 4WD system fault causes the 4WD system to default to rear-wheel drive only mode. When this warning message is displayed, have your vehicle serviced at an authorized dealer.

Note: A warning message displays in the instrument cluster display if the 4WD system overheats. See **Four-Wheel Drive – Warning Lamps** (page 219). This condition could occur if the vehicle is operated in extreme conditions with excessive wheel slip, such as deep sand. To resume normal 4WD function as soon as possible, stop the vehicle in a safe location and stop the engine for at least 10 minutes. After the engine is restarted and the 4WD system is adequately cooled, the warning message turns off and normal 4WD function returns.

FOUR-WHEEL DRIVE LIMITATIONS

Using different size tires other than the provided spare could cause system damage or disable the 4WD system.

Operating Four-Wheel Drive (4WD) Vehicles With Spare Tires

Do not use a different size spare tire other than the tire provided. If the mini-spare tire is installed, the 4WD system will disable and enter rear-wheel drive only mode to protect driveline components. Some limited 4WD traction could be provided if the mini-spare is installed on one of the front wheels. If you are in driving conditions where limited 4WD traction is needed while the mini-spare is installed, we recommended the mini-spare be installed on the front axle. See **Four-Wheel Drive – Information Messages** (page 220).

Four-Wheel Drive

If the mini-spare is installed, this condition is indicated by a warning in the information display. If there is a warning message in the information display from using the spare tire, this indicator should turn off after reinstalling or replacing the normal road tire and cycling the ignition off and on. We recommended reinstalling or replacing the normal road tire as soon as possible. Major dissimilar tire sizes between the front and rear axles could cause the 4WD system to stop functioning and default to rear-wheel drive or damage the 4WD system.

The 4WD system can still activate if the mini spare is installed on a front wheel. If the mini spare is installed on a rear wheel the 4WD system will fully disable. In situations where there is a wintery mix or an off road situation and you need to use a mini spare, you must install the mini spare in the front tire position and move a full size tire to the rear tire position for the 4WD system to function.

Operating Four-Wheel drive (4WD) Vehicles with Mismatched Tires



WARNING: Only use replacement tires and wheels that are the same size, as those originally provided for your vehicle. The required tire and wheel sizes, along with the minimum required Load and Speed Index, can be found on the Tire Label on the driver side door frame or the edge of the driver door. If this information is not found in those locations, or for additional options, contact your authorized dealer. Use of any tire or wheel not recommended, could affect the safety and performance of your vehicle, which could result in an increased risk of loss of vehicle control, vehicle rollover, personal injury and death.



WARNING: Vehicles with a higher center of gravity (utility and four-wheel drive vehicles) handle differently than vehicles with a lower center of gravity (passenger cars). Avoid sharp turns, excessive speed and abrupt steering in these vehicles. Failure to drive cautiously increases the risk of losing control of your vehicle, vehicle rollover, personal injury and death.

Major dissimilar tire sizes between the front and rear axles (for example, 17 inch low profile tires on the front axle and 22 inch high profile tires on the rear axle) could cause the 4WD system to stop functioning and default to rear-wheel drive or damage the 4WD system.

For optimum 4WD Performance, we recommend that you to follow the tire rotation maintenance schedule. To avoid potential 4WD malfunction or 4WD system damage, we recommend that you replace all four tires rather than mixing significantly worn tires with new tires. Using three worn tread tires and one new tread tire all of the same original tire size/brand, can be tolerated by the 4WD system as long as the worn tires still have usable tread depth.

How Your Vehicle Differs from Other Vehicles

Truck and utility vehicles can differ from some other vehicles. Your vehicle could be higher to allow it to travel over rough terrain without getting hung up or damaging underbody components.

The differences that make your vehicle so versatile also make it handle differently than an ordinary passenger car.

Four-Wheel Drive

Maintain steering wheel control at all times, especially in rough terrain. Since sudden changes in terrain can result in abrupt steering wheel motion, make sure you grip the steering wheel from the outside. Do not grip the spokes.

Drive cautiously to avoid vehicle damage from concealed objects such as rocks and stumps.

You should either know the terrain or examine maps of the area before driving. Map out your route before driving in the area. To maintain steering and braking control of your vehicle, you must have all four wheels on the ground and they must be rolling, not sliding or spinning.

Capacities

Variant	Quantity
Four-wheel drive.	1.1 qt (1 L)

Materials

Name	Specification
Motorcraft® MERCON® LV Automatic Transmission Fluid (U.S.) Motorcraft® MERCON® LV Automatic Transmission Fluid / Huile pour boîte automatique MERCON® LV Motorcraft® (Canada) XT-10-QLVC (U.S.) CXT-10-LV6 (Canada)	WSS-M2C938-A

FOUR-WHEEL DRIVE – TROUBLESHOOTING

FOUR-WHEEL DRIVE – WARNING LAMPS



Illuminates when a four-wheel drive or power train fault is present.

TRANSFER CASE FLUID CAPACITY AND SPECIFICATION

Use fluid that meets the defined specification and viscosity grade.

If you do not use fluid that meets the defined specification and viscosity grade, it could result in:

- Component damage that your vehicle warranty does not cover.
- Reduced vehicle performance.

Note: When a system fault is present, the system can typically remain in whichever mode was selected prior to the fault condition occurring. It does not default to two-wheel drive in all circumstances. When this warning displays, have your vehicle serviced by an authorized dealer.

Four-Wheel Drive

FOUR-WHEEL DRIVE – INFORMATION MESSAGES

Message	Action / Description
4WD Off	Displays when the four-wheel drive system automatically disables to protect itself. This can happen when you operate your vehicle after temporarily installing a spare tire, or if the system detects dissimilar size tires, or if there is an issue with another vehicle system preventing 4WD operation. The system resumes normal operation and clears this message after you re-install the road tire, cycle the ignition off and on and drive a short distance, or after you resolve the other vehicle system issues.
4WD Restored	Displays when the four-wheel drive system resumes normal operation after the system cools.
4WD Temporarily Disabled	Displays when the four-wheel drive system temporarily turns off to protect itself from overheating.
4WD temporarily locked	Displays when the four-wheel drive system locks up the torque transfer clutch to help reduce clutch temperature.
4WD fault Service required	Displays if the four-wheel drive system does not properly operate. Displays in conjunction with the powertrain fault indicator light. If the warning stays illuminated or continues to illuminate, contact an authorized dealer as soon as possible.

Front Axle

FRONT AXLE FLUID CAPACITY AND SPECIFICATION

Use fluid that meets the defined specification and viscosity grade.

If you do not use fluid that meets the defined specification and viscosity grade, it could result in:

- Component damage that your vehicle warranty does not cover.
- Reduced vehicle performance.

Capacities

Variant	Quantity
Four-wheel drive.	0.6 qt (0.6 L)

Materials

Name	Specification
Motorcraft® SAE 75W-140 Synthetic Rear Axle Lubricant (U.S.) Motorcraft® SAE 75W-140 Synthetic Rear Axle Lubricant / Lubrifiant synthétique pour pont arrière SAE 75W-140 Motorcraft® (Canada) XY-75W140-QL (U.S.) CXY-75W140-IL (Canada)	WSL-M2C192-A

Rear Axle

LIMITED SLIP DIFFERENTIAL - VEHICLES WITH: LIMITED-SLIP DIFFERENTIAL

This axle provides added traction on slippery surfaces, particularly when one wheel is on a poor traction surface. Under normal conditions, the limited-slip axle functions like a standard rear axle. The axle may exhibit a slight noise or vibration during tight turns with low vehicle speed. This is normal behavior and indicates the axle is working.

Capacities

2.3L Gas Engine	Quantity
Non-Tremor.	54.1 fl oz (1.6 L)
Tremor. ¹	60.9 fl oz (1.8 L)

¹Limited Slip Differential also requires 3 oz (90 mL) of EST-M2C118-A Friction Modifier in addition to the lubricant.

All Other Engine Configurations	Quantity
All drive types.	60.9 fl oz (1.8 L)

Materials

Name	Specification
Motorcraft® SAE 75W-85 Premium Synthetic Hypoid Gear Lubricant (U.S.) Motorcraft® SAE 75W-85 Premium Synthetic Hypoid Gear Lubricant / Huile synthétique de haute qualité pour engrenages hypoides SAE 75W-85 Motorcraft® (Canada) XY-75W85-QL (U.S. & Canada)	WSS-M2C942-A

REAR AXLE FLUID CAPACITY AND SPECIFICATION

Use fluid that meets the defined specification and viscosity grade.

If you do not use fluid that meets the defined specification and viscosity grade, it could result in:

- Component damage that your vehicle warranty does not cover.
- Reduced vehicle performance.

Drive Mode Control

WHAT IS DRIVE MODE CONTROL

This feature connects multiple vehicle systems through a single interface, providing you with enhanced vehicle control and driving dynamics for different driving scenarios, terrains, weather, or various road conditions.

HOW DOES DRIVE MODE CONTROL WORK

When a drive mode is selected it changes various electrical and mechanical systems within the vehicle to a predetermined configuration. The systems change and features available depend on which mode is selected.

Note: *Off-road drive modes automatically disable the brake over accelerator system to allow for two-footed driving in off-road environments. See **Brake Over Accelerator** (page 228).*

Note: *The drive mode system reverts to normal mode each time you start your vehicle.*

SELECTING A DRIVE MODE - EXCLUDING: POLICE



Rotate the controller located on the center console. Rotate the drive mode controller once to activate the drive mode selection menu in the display. Rotate the controller a second time to select and engage the drive mode.

Note: *Button icons vary depending on the vehicle's configuration.*

SELECTING A DRIVE MODE - POLICE



Press the mode button located on steering wheel. The first press activates the drive mode selection menu in the display. Subsequent presses change the selected drive mode.

Drive Mode Control

DRIVE MODES

DEEP SNOW/SAND - POLICE



For off-road driving on soft dry sand or deep snow. This mode optimizes accelerator pedal response, traction settings, and stability controls to help maintain forward momentum when driving through deep sand or snow. If your vehicle becomes stuck in deep conditions, using this mode may help it become unstuck.

Note: *Using deep snow/sand mode on dry, hard surfaces could produce some vibration, driveline bind up, and potential excessive tire wear.*

ECO



This mode decreases accelerator pedal responsiveness to soften driver inputs and encourage efficient driving. Depending on your vehicle's options, adaptive cruise control is slower to return to the set speed and auto start-stop engages more often. The system decreases air conditioning output to conserve energy when set to auto mode. Use this mode for fuel efficient driving which allows for an extended vehicle range.

NORMAL



This mode adjusts all systems to their base settings and balances vehicle performance for all around drivability. Each time you switch your vehicle off it defaults to this mode. Use this mode for everyday driving, such as city and highway routes or commuting.

OFF-ROAD (If Equipped)



This mode lowers accelerator pedal responsiveness and delays transmission upshifts for improved vehicle control in low speed off-road environments. Traction and stability controls allow the wheels to spin to maintain vehicle momentum and clear debris from the tires for improved traction. Depending on your vehicle's options, the system deactivates auto-start-stop. Use this mode for driving through mud, sand, and rough, uneven off-road terrains.

Note: *This mode is for off-road use only. Do not use this mode when driving on pavement or packed snow.*

PURSUIT - POLICE

Automatic Pursuit Mode



Automatic Pursuit mode does not use a switch. This system is a temporary driving enhancement that senses the driver is demanding high performance from the vehicle. On all Police Interceptor applications, the transmission holds lower gears and the engine holds higher engine speeds longer than normal driving. The mode terminates when the vehicle senses the driver is no longer in high performance demand. The vehicle then returns to normal operation. Indicated by a blue telltale.

Note: *Drive mode changes may not be available when the ignition is off or when the engine is not running.*

Drive Mode Control

Manual Pursuit Mode



Manual Pursuit mode can be selected by the driver to activate some of the features of Automatic Pursuit mode. The feature improves engine response, provides more aggressive shifting, improves gear selection and maintains a lower gear for more responsive acceleration. Indicated by a white telltale.

SLIPPERY



This mode lowers accelerator pedal responsiveness, adjusts transmission shift points, and optimizes traction and stability controls to help mitigate wheel spin and maintain vehicle control in slick driving conditions. Depending on your vehicle's options, this feature adjusts all-wheel drive control to provide optimum traction for slippery surfaces. Use this mode for less than ideal road conditions such as snow and ice covered roads or for firm surfaces that are covered with loose or slippery materials.

Note: Do not use this mode when driving on dry pavement.

SPORT



This mode increases accelerator pedal responsiveness and holds the transmission in lower gears longer for enhanced acceleration. The system switches the chassis controls to their sport settings.

Depending on your vehicle's options, the system increases the tone of the exhaust, increases steering effort, and adjusts the suspension for enhanced driver connectivity and responsive driving dynamics.

Use this mode for a sportier and engaging driving experience.

TOW/HAUL



For improved vehicle operation when towing a trailer or hauling a heavy load. This mode moves upshifts to higher engine speeds to reduce the frequency of transmission shifting. It also provides downshift engine braking to assist in maintaining vehicle speed when descending a slope. Depending on your vehicle's options, the system enhances steering response to assist in controlling the vehicle when towing or hauling and auto-start stop is inhibited.

TRAIL (If Equipped)



This mode lowers accelerator pedal responsiveness and delays transmission upshifts for improved vehicle control in low speed off-road environments. The system optimizes the traction and stability controls for improved traction and to help maintain forward momentum through loose deformable terrains.

Depending on your vehicle's options, the system disables auto-start-stop and optimizes the all-wheel drive system for enhanced traction.

Use this mode for driving on two-track trails, loose gravel and mixed uneven terrain.

Note: The brake over accelerator system is on in this mode. See **Brake Over Accelerator** (page 228).

Drive Mode Control

DRIVE MODE CONTROL – TROUBLESHOOTING

DRIVE MODE CONTROL – WARNING LAMPS



Some drive modes reduce traction and stability control performance and the indicator illuminates in the instrument cluster.

Note: *The system has diagnostic checks that continuously monitor the system for proper operation. If a mode is unavailable due to a system fault, the drive mode system defaults to normal.*

DRIVE MODE CONTROL – INFORMATION MESSAGES

Message	Details
Drive mode not available	The system is not available. If it is still not available the next time you switch the ignition on, the system has malfunctioned. Have your vehicle checked as soon as possible.

Drive Mode Control

DRIVE MODE CONTROL – FREQUENTLY ASKED QUESTIONS

Why did the system default to normal mode?

- If a mode is unavailable due to a system fault, it defaults to normal mode.

Can I switch drive modes while I am driving?

- In most instances, you can switch drive modes while you are driving (if you maintain attention on the road), or while the vehicle is stationary. However, you should not switch the vehicle into a drive mode intended for off-road or track use while driving on paved, public roads. For example, while driving on a paved highway, it would be acceptable to switch from normal mode to eco mode, but not to off-road mode.

How long does it take for the vehicle to switch modes after I make a selection?

- After switching modes, the new drive mode activates within several seconds, if all the preconditions are met.

How should I decide which drive mode to use?

- Selecting a drive mode usually depends on the driving experience you would like to have, and the driving conditions. For example, if you want to have a more exciting on-road driving experience, you could switch into sport mode. If you find yourself driving on slick roads, you could switch into slippery mode.

Will drive modes impact my vehicle's fuel consumption?

- Drive modes can have an impact on your vehicle's fuel consumption. In addition to the active mode, your driving style also affects the fuel consumption.

Brakes

BRAKE PRECAUTIONS

Wet brakes result in reduced braking efficiency. Gently press the brake pedal a few times when leaving a car wash or driving from standing water to dry the brakes.

Note: *Depending on applicable laws and regulations in the country for which your vehicle was originally built, your brake lamps may flash during heavy braking. Following this, your hazard lights may also flash when your vehicle comes to a stop.*

ANTI-LOCK BRAKING SYSTEM

ANTI-LOCK BRAKING SYSTEM LIMITATIONS

The anti-lock braking system does not eliminate the risk of crash when:

- You drive too closely to the vehicle in front of you.
- Your vehicle is hydroplaning.
- You take corners too fast.
- The road surface is poor.

Note: *If the system activates, the brake pedal could pulse and travel further. Maintain pressure on the brake pedal.*

ANTI-LOCK BRAKING SYSTEM INDICATORS

This system helps you maintain steering control during emergency stops by keeping the brakes from locking.



If the warning lamp illuminates when you are driving, this indicates a malfunction. Your vehicle continues to have normal braking without the anti-lock brake system function. Have your vehicle checked as soon as possible.

The warning lamp also momentarily illuminates when you switch the ignition on to confirm the lamp is functional. If it does not illuminate when you switch the ignition on, or begins to flash at any time, have the system checked by an authorized dealer.

BRAKE OVER ACCELERATOR

In the event the accelerator pedal becomes stuck or entrapped, apply steady and firm pressure to the brake pedal to slow the vehicle and reduce engine power. If you experience this condition, apply the brakes and bring your vehicle to a safe stop. Move the transmission to park (P), switch the engine off and apply the parking brake. Inspect the accelerator pedal for any interference. If none are found and the condition persists, have your vehicle towed to the nearest authorized dealer.

LOCATING THE BRAKE FLUID RESERVOIR

See **Under Hood Overview** (page 368).

CHECKING THE BRAKE FLUID



WARNING: Do not use any fluid other than the recommended brake fluid as this will reduce brake efficiency. Use of incorrect fluid could result in the loss of vehicle control, serious personal injury or death.

Brakes

 **WARNING:** Only use brake fluid from a sealed container. Contamination with dirt, water, petroleum products or other materials may result in brake system damage or failure. Failure to adhere to this warning could result in the loss of vehicle control, serious personal injury or death.

 **WARNING:** Do not allow the fluid to touch your skin or eyes. If this happens, rinse the affected areas immediately with plenty of water and contact your physician.

 **WARNING:** The brake system could be affected if the brake fluid level is below the **MIN** mark or above the **MAX** mark on the brake fluid reservoir.

1. Park your vehicle on a level surface.



2. Look at the brake fluid reservoir to see where the brake fluid level is relative to the **MIN** and the **MAX** marks on the reservoir.

Note: To avoid fluid contamination, the reservoir cap must remain in place and fully tight, unless you are adding fluid.

Only use fluid that meets our specifications. See **Brake Fluid Specification** (page 229).

BRAKE FLUID SPECIFICATION

Use fluid that meets the defined specification and viscosity grade.

If you do not use fluid that meets the defined specification and viscosity grade, it could result in:

- Component damage that your vehicle warranty does not cover.
- Reduced brake performance.

Note: We recommend you to use Dot 4 Low Viscosity (LV) High Performance Brake Fluid meeting WSS-M6C65-A2 specifications or ISO 4925 Class 6 standards. If you use any fluid other than the recommended fluid, it could cause reduced brake performance and not meet our performance standards. Keep brake fluid clean and dry. Contamination with dirt, water, petroleum products or other materials could result in brake system damage and possible failure.

Brakes

Capacities

Variant	Quantity
All.	Fill as required.

Materials

Name	Specification
Motorcraft® DOT 4 LV High Performance Motor Vehicle Brake Fluid(U.S.) Motorcraft® DOT 4 LV High Performance Motor Vehicle Brake Fluid / Liquide de frein automobile haute performance DOT 4 LV Motorcraft®(Canada) PM-20(U.S. & Canada)	WSS-M6C65-A2

BRAKES – TROUBLESHOOTING

BRAKES – WARNING LAMPS



WARNING: Driving your vehicle with the warning lamp on is dangerous. A significant decrease in braking performance may occur. It may take you longer to stop your vehicle. Have your vehicle checked as soon as possible. Driving extended distances with the parking brake engaged can cause brake failure and the risk of personal injury.



If the ABS indicator illuminates when you are driving, this indicates a malfunction. Your vehicle continues to have normal braking without the anti-lock braking system function. See an authorized dealer.

It also momentarily illuminates when you switch the ignition on to confirm the lamp is functional. If it does not illuminate when you switch the ignition on, or begins to flash at any time, have the system checked by an authorized dealer.



The brake indicator momentarily illuminates when you switch the ignition on to confirm the lamp is functional. It may also illuminate when you apply the parking brake and the ignition is on. If it illuminates when your vehicle is moving, make sure the parking brake is disengaged. If the parking brake is disengaged, this indicates low brake fluid level or a brake system fault. See an authorized dealer.

Note: Lamps may vary depending on region.

Brakes

BRAKES – INFORMATION MESSAGES

Brake fluid level low	The brake fluid level is low and the brake system should be inspected immediately. See Checking the Brake Fluid (page 228).
Check brake system	The brake system needs servicing. Stop the vehicle in a safe place. Contact an authorized dealer.

BRAKES – FREQUENTLY ASKED QUESTIONS

Is brake dust on the wheels normal?

Brake dust could accumulate on the wheels, even under normal driving conditions. Some dust is inevitable as the brakes wear and does not contribute to brake noise. See **Cleaning Wheels** (page 402).

Will wet driving conditions effect my braking abilities?

Wet brakes result in reduced braking efficiency. Gently press the brake pedal a few times when driving from a car wash or standing water to dry the brakes.

Is brake noise considered normal?

Occasional brake noise is normal. If a metal-to-metal, continuous grinding or continuous squeal sound is present, the brake linings may be worn-out and an authorized dealer should check them. If the vehicle has continuous vibration or shudder in the steering wheel while braking, an authorized dealer should check your vehicle.

When should you replace the brake fluid?

Brake fluid absorbs water over time which degrades the effectiveness of the brake fluid. Change the brake fluid at the specified intervals to prevent degraded braking performance.

Electric Parking Brake

WHAT IS THE ELECTRIC PARKING BRAKE

The electric parking brake is used to hold your vehicle on slopes and flat roads.

APPLYING THE ELECTRIC PARKING BRAKE



WARNING: Apply the parking brake and make sure your vehicle is in park (P). Power the vehicle off and remove the keys or remote control whenever you leave your vehicle. Failure to follow this instruction could result in personal injury or death.



WARNING: If you drive extended distances with the parking brake applied, you could cause damage to the brake system.



WARNING: The electric parking brake does not operate if the vehicle battery has run out of charge.



WARNING: If the parking brake is fully released, but the brake warning lamp remains illuminated, the brakes may not be working properly. Have your vehicle checked as soon as possible.



The electric parking brake switch is on the center console.

1. Pull the switch up.

The red warning lamp flashes during operation and illuminates when the parking brake is applied.

Note: You can apply the electric parking brake when the ignition is off.

Note: The electric parking brake could apply when you shift into park (P). See **Park (P)** (page 204).

APPLYING THE ELECTRIC PARKING BRAKE IN AN EMERGENCY

You can use the electric parking brake to slow or stop your vehicle in an emergency.

Pull the switch up and hold it.

The red warning lamp illuminates, a tone sounds and the stoplamps turn on when you use the electric parking brake in an emergency.

The electric parking brake continues to slow your vehicle down unless you release the switch.

Note: Do not apply the electric parking brake when your vehicle is moving, except in an emergency. If you repeatedly use the electric parking brake to slow or stop your vehicle, you could cause damage to the brake system.

MANUALLY RELEASING THE ELECTRIC PARKING BRAKE

1. Switch the ignition on.
2. Press and hold the brake pedal.
3. Push the switch down.

The red warning lamp turns off.

Pulling Away When Towing a Trailer Uphill

1. Press and hold the brake pedal.
2. Pull the switch upward and hold it.
3. Shift into gear.

Electric Parking Brake

4. Press the accelerator pedal until engine has developed sufficient torque to prevent your vehicle from rolling down the hill.
5. Release the switch and pull away in a normal manner.

AUTOMATICALLY RELEASING THE ELECTRIC PARKING BRAKE

1. Close the driver door.
2. Shift into gear.
3. Press the accelerator pedal and pull away in a normal manner.

ELECTRIC PARKING BRAKE AUDIBLE WARNING

Sounds when the parking brake is on and your vehicle is moving with at least 5 km/h. If the warning tone continues after you have released the parking brake, this indicates a malfunction. Have your vehicle checked as soon as possible.

RELEASING THE ELECTRIC PARKING BRAKE IF THE VEHICLE BATTERY HAS RUN OUT OF CHARGE



WARNING: The electric parking brake does not operate if the vehicle battery has run out of charge.

Connect a booster battery to the vehicle battery to release the electric parking brake if the vehicle battery has run out of charge. See **Jump Starting the Vehicle** (page 346).

ELECTRIC PARKING BRAKE – TROUBLESHOOTING

ELECTRIC PARKING BRAKE – WARNING LAMPS

Brake System



It illuminates red when you apply the parking brake and your vehicle is on. If the lamp flashes when the parking brake has been released, this indicates the parking brake system requires service. Have your vehicle checked as soon as possible.

Note: Lamps may vary depending on region.

Electric Parking Brake



When the lamp illuminates yellow, it indicates a malfunction in the electric parking brake. Have your vehicle checked as soon as possible.

Note: Lamps may vary depending on region.

Electric Parking Brake

ELECTRIC PARKING BRAKE – INFORMATION MESSAGES

Park Brake

Message	Action
Park brake applied	The electric parking brake is set, the engine is running and you drive your vehicle more than 3 mph (5 km/h). If the warning stays on after the electric parking brake is released, have the system checked as soon as possible.
To release: Press brake and switch	The electric parking brake is set and a manual release is attempted without the brake pedal being pressed.
Park brake Use switch to release	The electric parking brake is set and an automatic release is attempted but cannot be performed. Perform a manual release.
Release park brake	The electric parking brake is set and your vehicle speed exceeds 3 mph (5 km/h). Release the electric parking brake before continuing to drive.
Park brake not applied	The electric parking brake is not fully applied.
Park brake not released	The electric parking brake is not fully released.
Brake maintenance mode	The electric parking brake system has been put into a special mode to allow brake service. Have the system checked as soon as possible.
Park brake Limited function Service required	The electric parking brake system has detected a condition that requires service. Some functionality may still be available. Have the system checked as soon as possible.
Park brake fault Service now	The electric parking brake system has detected a condition that requires service. Have the system checked as soon as possible.
Park brake system overheated	Numerous electric parking brake applies have overheated the system. Wait 2 minutes before attempting to apply again.

Reverse Brake Assist (If Equipped)

HOW DOES REVERSE BRAKE ASSIST WORK

Reverse brake assist is designed to reduce impact damage or assist in avoiding a collision while in reverse (R). It functions when in reverse (R) and traveling at a speed of 1–7 mph (2–12 km/h).

If the system detects an obstacle behind your vehicle, it provides a warning through the rear parking aid or cross traffic alert system. Using sensors on the rear of the vehicle, it can detect a possible collision and apply the brakes. If full braking occurs, the system attempts to stop the vehicle a safe distance from the obstacle.

REVERSE BRAKE ASSIST PRECAUTIONS

 **WARNING:** You are responsible for controlling your vehicle at all times. The system is designed to be an aid and does not relieve you of your responsibility to drive with due care and attention. Failure to follow this instruction could result in the loss of control of your vehicle, personal injury or death.

 **WARNING:** To help avoid personal injury, always use caution when in reverse (R) and when using the sensing system.

 **WARNING:** The system may not operate properly during severe weather conditions, for example snow, ice, heavy rain and spray. Always drive with due care and attention. Failure to take care may result in a crash.

 **WARNING:** Traffic control systems, fluorescent lamps, inclement weather, air brakes, external motors and fans may affect the correct operation of the sensing system. This may cause reduced performance or false alerts.

 **WARNING:** Some situations and objects prevent hazard detection. For example low or direct sunlight, inclement weather, unconventional vehicle types, and pedestrians. Apply the brakes when necessary. Failure to follow this instruction could result in the loss of control of your vehicle, personal injury or death.

 **WARNING:** Do not use the system with accessories that extend beyond the front or rear of your vehicle, for example a trailer hitch or bike rack. The system is not able to make corrections for the additional length of the accessories.

The system only applies the brakes for a short period of time when an event occurs. Act as soon as you notice the brakes apply to remain in control of the vehicle. If you do not intervene the vehicle may start to move again.

Note: *Certain add-on devices around the bumper or fascia may create false alerts. For example, large trailer hitches, bicycle or surfboard racks, license plate brackets, bumper covers or any other device that may block the normal detection zone of the system. Remove the add-on device to prevent false alerts.*

Note: *The system does not react to small or moving objects, particularly those close to the ground.*

Note: *The system does not operate during hard acceleration or steering.*

Reverse Brake Assist (If Equipped)

Note: If your vehicle sustains damage to the bumper or fascia leaving it misaligned or bent, it could alter the sensing zone causing inaccurate measurement of obstacles or false alerts.

Note: Vehicle loading and suspension changes can impact the angle of the sensors and may change the normal detection zone of the system resulting in inaccurate measurement of obstacles or false alerts.

Note: When you connect a trailer, the system may detect the trailer and provide an alert, or the system turns off. If the system does not turn off, manually switch the system off after you connect the trailer.

Note: You may experience reduced system performance on road surfaces that limit deceleration. For example, roads with ice, loose gravel, mud or sand.

SWITCHING REVERSE BRAKE ASSIST ON AND OFF

1. From the driver assistance menu, press Reverse Brake Assist.
2. Switch the feature on or off.

Note: The system is unavailable when the rear parking aid or cross traffic alert is off.

Note: If your vehicle is not equipped with cross traffic alert, the reverse brake assist relies on input from only the rear parking aid and rear camera sensors.

OVERRIDING REVERSE BRAKE ASSIST

There could be instances when unexpected or unwanted braking occurs. Firmly pressing the accelerator pedal or switching the feature off overrides the system.

REVERSE BRAKE ASSIST INDICATORS

If the system determines that a collision with an obstacle may occur, full braking may apply.



A message and warning indicator appear when the system applies the brakes.

Reverse Brake Assist (If Equipped)

REVERSE BRAKE ASSIST – TROUBLESHOOTING

REVERSE BRAKE ASSIST – INFORMATION MESSAGES

Message	Details
Reverse Brake Assist	Displays for a few seconds when the system applies the brakes.
Reverse Brake Assist not available See manual	<p>Make sure the rear parking aid and cross traffic alert systems are switched on. Make sure that all doors, liftgate or tailgate and hood are closed and no vehicle add-on devices or modifications are interfering with the system.</p> <p>Make sure the rear view camera is clear and the mirrors are not folded while in reverse if 360 degree cameras are installed.</p> <p>Drive the vehicle on a straight road for a short period. If the message remains, have the system checked as soon as possible.</p>
Reverse Brake Assist Off	Displays when reverse brake assist is off.

Reverse Brake Assist (If Equipped)

REVERSE BRAKE ASSIST – FREQUENTLY ASKED QUESTIONS

What are the precautions to be followed when using the reverse brake assist system?

- The system uses a combination of rear parking aid cameras and parking sensors for operation. Poor visibility or low lighting conditions can impact performance. Make sure the rear parking aid cameras and parking sensors are not dirty or obstructed.
- Reverse your vehicle slowly. On rare occasions, detection issues can occur due to road infrastructure, for example sloped driveways and textured surfaces behind the vehicle or objects close to the reversing path.

Why is reverse brake assist unavailable?

- Make sure you switch the system on. See **Switching Reverse Brake Assist On and Off** (page 236).
- Make sure that the liftgate or tailgate, hood and all doors are closed.
- Make sure the cross traffic alert system is on. See **What Is Cross Traffic Alert** (page 307).
- Make sure the rear parking aid system is on. See **What is the Rear Parking Aid** (page 252).
- Make sure that traction control is on. See **Switching Traction Control On and Off** (page 242).
- Your vehicle may have sustained a rear end impact. Have the sensors checked for proper coverage and operation.

- Make sure the exterior cameras are not dirty or obstructed. If dirty, clean the cameras. If the reverse brake assist unavailable message still appears after cleaning the cameras, wait a short time for the message to clear. If the message does not clear, drive the vehicle on a straight road for a short period. If the message remains, have the system checked.
- Make sure the sensors are not blocked or faulted. See **Locating the Rear Parking Aid Sensors** (page 252). See **Locating the Cross Traffic Alert Sensors** (page 309).
- You recently had your vehicle serviced, or the battery disconnected. Drive your vehicle a short distance to resume system operation.
- The system does not function when you connect a trailer. Operation resumes when you disconnect the trailer.

Note: *If you are still having problems with reverse brake assist, have the system checked as soon as possible.*

Hill Start Assist

WHAT IS HILL START ASSIST

Hill Start Assist applies the brakes to hold your vehicle after you bring it to a stop on a slope. This makes it easier for you to pull away without using the parking brake.

HOW DOES HILL START ASSIST WORK

When the system activates, your vehicle remains stationary for a few seconds after you release the brake pedal. This gives you time to move your foot from the brake pedal to the accelerator pedal. The brakes release when you apply the accelerator pedal and the vehicle begins to move forward, or the system exceeds the time allowed for automatically applying the brakes.

The system activates when your vehicle is in any forward gear and facing uphill, or when your vehicle is in reverse (R) and facing downhill.

HILL START ASSIST PRECAUTIONS



WARNING: The system does not replace the parking brake. When you leave your vehicle, always apply the parking brake.



WARNING: You must remain in your vehicle when the system turns on. At all times you are responsible for controlling your vehicle, supervising the system, and intervening if required. Failure to follow this instruction could result in the loss of control of your vehicle, personal injury or death.



WARNING: The system turns off if there is a malfunction.

HILL START ASSIST – TROUBLESHOOTING

HILL START ASSIST – INFORMATION MESSAGES

Message	Details
Hill Start Assist not available	Displays when system is not available. Have your vehicle checked as soon as possible.

Auto Hold

HOW DOES AUTO HOLD WORK

Auto hold applies the brakes to hold your vehicle after you bring the vehicle to a stop. This can help when waiting on a hill or in traffic.

SWITCHING AUTO HOLD ON AND OFF



WARNING: The system does not replace the parking brake. When you leave your vehicle, always apply the parking brake.



WARNING: You must remain in your vehicle when the system turns on. At all times you are responsible for controlling your vehicle, supervising the system, and intervening if required. Failure to follow this instruction could result in the loss of control of your vehicle, personal injury or death.



WARNING: The system will turn off if a malfunction is apparent. Failure to take care may result in the loss of control of your vehicle, serious personal injury or death.



Press the button on the instrument panel. The button illuminates when you switch the system on.

Note: You can only switch the system on after you close the driver door.

Note: The system remembers the last setting when you start your vehicle.

Note: When using an automatic car wash, make sure to switch auto hold off or shift to neutral (N) with the brake pedal applied to make sure auto hold is not active.

USING AUTO HOLD

1. Bring your vehicle to a complete stop. The auto hold active indicator illuminates in the instrument cluster display.
2. Release the brake pedal. The system holds your vehicle at a standstill. The auto hold active indicator remains illuminated in the instrument cluster display.
3. Apply the accelerator and drive off in a normal manner. The system releases the brakes and the auto hold active indicator switches off.

Note: The system only activates if you bring the vehicle to a complete stop.

Note: Under certain conditions, the system could apply the electric parking brake. The brake system warning lamp illuminates. The electric parking brake releases when you press the accelerator pedal. See **Automatically Releasing the Electric Parking Brake** (page 233).

Note: While auto hold is applying the brakes, if you shift into reverse (R) or neutral (N) with your foot on the brake pedal, auto hold releases the brake. However, while auto hold is applying the brakes, if you shift into reverse (R) or neutral (N) without your foot on the brake pedal, auto hold continues to apply the brakes. In this case, the driver pressing the brake pedal causes auto hold to release the brake.

The following situations can cause auto hold to not work:

- Your vehicle is in temporary neutral mode.
- The driver door is open.
- You shift into reverse (R) or neutral (N) before the system is active.

Auto Hold

AUTO HOLD INDICATORS



Illuminates when the system is active.



Illuminates when the system is on but cannot hold your vehicle at a standstill at this particular time.

Traction Control

WHAT IS TRACTION CONTROL

The traction control system helps to avoid drive wheel spin and loss of traction.

HOW DOES TRACTION CONTROL WORK

If your wheels begin to spin, the loss of traction can compromise steering control and stability of the vehicle. The traction control system applies the brakes to individual wheels and when needed, reduces engine power at the same time to increase traction.

SWITCHING TRACTION CONTROL ON AND OFF



WARNING: Operating your vehicle with the traction control disabled could lead to an increased risk of loss of vehicle control, vehicle rollover, personal injury and death.



The traction control system turns on each time you switch the ignition on.

The button for the stability and traction control system is on the instrument panel.

Press and release the button to switch traction control off. The stability control system remains fully active, to switch it off, press and hold the button for a few seconds, then release.

When you switch traction control off, a message and an illuminated icon appear on the instrument cluster.

Press the switch again to turn the traction control system back on to normal operation.

If your vehicle is stuck in mud or snow, switching traction control off may be beneficial as this allows the wheels to spin.

TRACTION CONTROL INDICATOR

Stability and Traction Control Indicator



If the indicator does not illuminate when you switch the ignition on, or remains on when the engine is running, this indicates a malfunction. Have your vehicle checked by an authorized dealer as soon as possible.



The traction control off indicator illuminates when you switch the traction control system off, or when an alternative stability control mode is selected that requires the traction control off depending on the drive mode selected.

Traction Control

TRACTION CONTROL – TROUBLESHOOTING

TRACTION CONTROL – INFORMATION MESSAGES

Message	Details
Service AdvanceTrac	The system detects a condition that requires service. Contact an authorized dealer as soon as possible.
AdvanceTrac Off	The status of the AdvanceTrac system after you switched it off.
AdvanceTrac On	The status of the AdvanceTrac system after you switched it on.
Traction Control Off	The status of the traction control system after you switched it off.
Traction Control On	The status of the traction control system after you switched it on.

Stability Control

HOW DOES STABILITY CONTROL WORK



WARNING: Vehicle modifications involving braking system, aftermarket roof racks, suspension, steering system, tire construction and wheel and tire size may change the handling characteristics of your vehicle and may adversely affect the performance of the electronic stability control system. In addition, installing any stereo speakers may interfere with and adversely affect the electronic stability control system. Reducing the effectiveness of the electronic stability control system could lead to an increased risk of loss of vehicle control, vehicle rollover, personal injury and death.



WARNING: Remember that even advanced technology cannot defy the laws of physics. It's always possible to lose control of a vehicle due to inappropriate driver input for the conditions. Aggressive driving on any road condition can cause you to lose control of your vehicle increasing the risk of personal injury or property damage. Activation of the electronic stability control system is an indication that at least some of the tires have exceeded their ability to grip the road; this could reduce the operator's ability to control the vehicle potentially resulting in a loss of vehicle control, vehicle rollover, personal injury and death.



WARNING: You are responsible for controlling your vehicle at all times. The system is designed to be an aid and does not relieve you of your responsibility to drive with due care and attention. Failure to follow this instruction could result in the loss of control of your vehicle, personal injury or death.

If a driving condition activates either the stability control or traction control you may experience the following conditions:

- The stability and traction control light flashes.
- Your vehicle slows down.
- Reduced engine power.

The stability control system has several features built into it to help you maintain control of your vehicle:

Electronic Stability Control

Electronic stability control enhances your vehicle's ability to prevent skids or lateral slides by applying brakes to one or more of the wheels individually and, if necessary, reducing engine power.

Roll Stability Control

Roll stability control enhances your vehicle's ability to prevent rollovers by detecting your vehicle's roll motion and the rate at which it changes by applying the brakes to one or more wheels individually.

Curve Control

Curve control enhances your vehicle's ability to follow the road when cornering severely or avoiding objects in the roadway. Curve control operates by reducing engine power and, if necessary, applying brakes to one or more of the wheels individually.

Stability Control

Side Wind Stabilization

Side wind stabilization is an advanced feature that works by carefully applying the brakes on one side of the vehicle to reduce the effect of a side wind gust on the vehicle's path.

Traction Control

Traction control enhances your vehicle's ability to maintain traction of the wheels by detecting and controlling wheel spin. See **What Is Traction Control** (page 242).

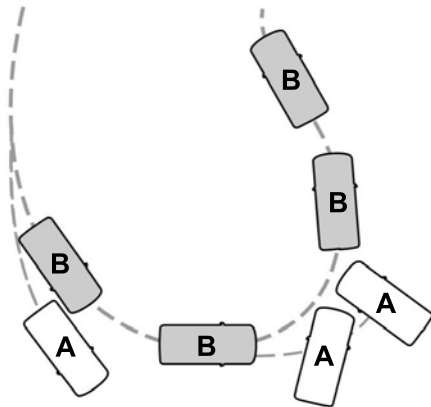

- A Vehicle without stability control skidding off its intended route.
- B Vehicle with stability control maintaining control on a slippery surface.

SWITCHING STABILITY CONTROL ON AND OFF - EXCLUDING: POLICE

Stability Control turns on each time you switch the ignition on.

Switch the stability control off by pressing and holding the stability and traction control button off for 5-15 seconds, or you can press the button again to switch the system on.

Shifting the transmission into reverse (R) will disable the system.

You can switch the traction control system off or on independently. See **Switching Traction Control On and Off** (page 242).

Stability Control

Stability Control and Traction Control with Roll Stability Control

	Stability Control OFF Light	Roll Stability Control³	Electronic Stability Control³	Traction Control System³
Default at start-up	Illuminated during bulb check	Enabled	Enabled ³	Enabled
Button pressed momentarily	Illuminated	Enabled	Enabled ³	Disabled ¹
Button pressed and held for 5 - 15 seconds	Illuminated	Enabled	Disabled	Disabled
Button not pressed and transfer case is switched to 4x4 Low or put into Trail.	Illuminated	Disabled	Disabled	Disabled ¹

¹ The Traction Control system can still be enabled but with tighter or looser thresholds.

² When you press and hold the button, a progress bar will display to show the button hold time progress.

³ Functions can vary depending on what selectable drive mode the vehicle is currently in.

SWITCHING STABILITY CONTROL ON AND OFF - POLICE

Stability Control turns on each time you switch the ignition on.

Shifting the transmission into reverse (R) will disable the system.

You can switch the traction control system off or on independently. See **Switching Traction Control On and Off** (page 242).

Stability Control

Stability Control and Traction Control with Roll Stability Control

	Stability Control OFF Light	Roll Stability Control²	Electronic Stability Control²	Traction Control System²
Default at start-up	Illuminated during bulb check	Enabled	Enabled ²	Enabled
Button pressed momentarily	Illuminated	Enabled	Enabled ²	Disabled ¹
Button not pressed and transfer case is switched to 4x4 Low or put into Trail or Deep Snow/Sand mode.	Illuminated	Disabled	Disabled	Disabled ¹

¹The Traction Control system can still be enabled but with tighter or looser thresholds.

²Functions can vary depending on what selectable drive mode the vehicle is currently in.

STABILITY CONTROL INDICATOR

Stability and Traction Control Indicator



If the indicator does not illuminate when you switch the power on, or remains on, this indicates a malfunction. Have your vehicle checked by an authorized dealer as soon as possible.

Hill Descent Control (If Equipped)

WHAT IS HILL DESCENT CONTROL



WARNING: Hill descent control cannot control descent in all surface conditions and circumstances, such as ice or extremely steep grades. Hill descent control is a driver assist system and cannot substitute for good judgment by the driver. Failure to do so may result in loss of vehicle control, crash or serious injury.



WARNING: The system does not replace the parking brake. When you leave your vehicle, always apply the parking brake.

Note: *The system does not function below 3 mph (5 km/h).*

Hill descent control allows the driver to set and maintain vehicle speed while descending steep slopes in various surface conditions.

The system can maintain vehicle speeds on downhill slopes between 3–20 mph (5–32 km/h). Above 20 mph (32 km/h), the system remains on but the descent speed cannot be set or maintained.

The system requires a cool down interval after a period of sustained use. The amount of time that the system can remain active before cooling varies with conditions. The system provides a warning in the message center and a tone sounds when the system is about to disengage for cooling. At this time, manually apply the brakes as needed to maintain descent speed.

SWITCHING HILL DESCENT CONTROL ON AND OFF

1. From the controls menu, switch Hill Descent Control on or off. See **Center Display** (page 467).

Note: *A message appears in the instrument cluster display when the system is active.*

SETTING THE HILL DESCENT SPEED



WARNING: The system does not replace the parking brake. When you leave your vehicle, always apply the parking brake.



WARNING: The system does not control speed in low traction conditions or extremely steep slopes. The system is designed to be an aid and does not relieve you of your responsibility to drive with due care and attention. Failure to follow this instruction could result in personal injury.

To increase or decrease the descent speed, press the accelerator, brake pedal, or use the SET + and SET - buttons on the steering wheel. Once you reach the preferred speed remove your foot from the pedal.

HILL DESCENT CONTROL INDICATOR



Illuminates when you switch hill descent control on.

Steering

ELECTRIC POWER STEERING

HOW DOES ELECTRIC POWER STEERING WORK

The electric power steering system uses an electric motor to provide assistance when turning the steering wheel to steer your vehicle. If your vehicle detects a steering concern when you are driving, a warning message appears and the system reduces steering assistance. If your vehicle loses electrical power, the steering system still operates and you can manually steer your vehicle. Manually steering your vehicle requires more effort.

Note: *When the battery is disconnected or a new battery is installed, you must drive your vehicle a short distance before the system relearns the strategy and reactivates all systems.*

Steering Tips

If the steering wanders or pulls, check for:

- An improperly inflated tire.
- Uneven tire wear.
- Loose or worn suspension components.
- Improper vehicle alignment.

Note: *A high crown in the road or high crosswinds could also make the steering wander or pull.*

ELECTRIC POWER STEERING PRECAUTIONS



WARNING: The electric power steering system has diagnostic checks that continuously monitor the system. If a fault is detected, a message displays in the information display. Stop your vehicle as soon as it is safe to do so.

Switch the vehicle off. After at least 10 seconds, switch the vehicle on and watch the information display for a steering system warning message. If a steering system warning message returns, have the system checked as soon as possible.



WARNING: If the system detects an error, you may not feel a difference in the steering, however a serious condition may exist. Have your vehicle checked as soon as possible. Failure to do so may result in loss of steering control.

Adapt your speed and driving behavior according to reduced steering assist.

Extreme continuous steering may increase the effort to steer. This occurs to prevent internal overheating and damage to the steering system. If this occurs, you will not lose the ability to steer your vehicle manually nor will it cause damage to the system. Normal steering and driving allows the system to cool down and steering assist returns to normal.

Note: *There is no fluid reservoir to check or fill.*

When your vehicle is still moving, a significant decrease in steering assistance or a loss of steering assistance could occur if:

- You switch your vehicle off.
- Your vehicle loses electrical power.
- Your vehicle detects a concern.

When your vehicle is off and your vehicle begins moving, there is no steering assistance.

Steering

STEERING – TROUBLESHOOTING

STEERING – INFORMATION MESSAGES

Message	Details
Steering fault Service now	The power steering system has detected a condition that requires service. Have your vehicle checked as soon as possible.
Steering loss Stop safely	The power steering system is not working. Stop your vehicle in a safe place. Have your vehicle checked as soon as possible.
Steering assist fault Service required	The power steering system has detected a condition that requires service. Have your vehicle checked as soon as possible.

Parking Aids

PARKING AID PRECAUTIONS



WARNING: To help avoid personal injury, always use caution when in reverse (R) and when using the sensing system.



WARNING: The system may not detect objects with surfaces that absorb reflection. Always drive with due care and attention. Failure to take care may result in a crash.



WARNING: Traffic control systems, fluorescent lamps, inclement weather, air brakes, external motors and fans may affect the correct operation of the sensing system. This may cause reduced performance or false alerts.



WARNING: The system may not detect small or moving objects, particularly those close to the ground.



WARNING: The parking aid system can only assist you to detect objects when your vehicle is moving at parking speeds. To help avoid personal injury you must take care when using the parking aid system.



WARNING: The system may not function if the sensor is blocked.



WARNING: In cold and severe weather conditions the system may not function. Rain, snow and spray can all limit sensor performance.



WARNING: If damage occurs in the immediate area surrounding the sensor, have your vehicle checked as soon as possible.

Note: If your vehicle sustains damage leaving the sensors misaligned, this will cause inaccurate measurements or false alerts.

When you connect a trailer to your vehicle, the rear parking aid detects the trailer and provides an alert. Disable the parking aid when you connect a trailer to prevent the alert.

Note: Connected trailers might be detected by the vehicle and parking aid turns off automatically in those instances.

Note: Certain add-on devices installed around the bumper or fascia may create false alerts. For example, large trailer hitches, bike or surfboard racks, license plate brackets, bumper covers or any other device could block the normal detection zone of the parking aid system. Aftermarket spare tires or spare tire covers mounted to the rear tailgate could cause false alerts from the park aid system. Remove the add-on device to prevent false alerts.

Note: Keep the sensors free from snow, ice and large accumulations of dirt. If the sensors are covered, the system's accuracy can be affected.

Use water to thoroughly clean mud, ice, or debris from the inner and outer surfaces of the bumper and parking sensors. Do not clean the sensors with sharp objects.

SWITCHING PARKING AID ON AND OFF

Parking aids remain on at all times. You can only mute the audible tone.

Muting the Audible Tone



Press the parking aid button and use the menu to switch the system's audible tone on and off.

Parking Aids



You can also switch the tone on and off by shifting into reverse (R) and pressing the button on the rear view camera display screen.

REAR PARKING AID

WHAT IS THE REAR PARKING AID

Rear parking sensors detect objects behind your vehicle when in reverse (R).

REAR PARKING AID LIMITATIONS

There is a decreased coverage area at the outer corners.

The rear parking aid sensors are active when your vehicle is in reverse (R) and the vehicle speed is less than 5 mph (8 km/h).

The sensor coverage area is up to 71 in (180 cm) from the rear bumper.

The rear parking aid detects large objects when you shift into reverse (R) and any of the following occur:

- Your vehicle is moving backward at a low speed.
- Your vehicle is stationary but an object is approaching the rear of your vehicle at a low speed.
- Your vehicle is moving backward at a low speed and an object is moving towards your vehicle, for example another vehicle at a low speed.

The system shall provide no audible warning for the object behind the vehicle when in neutral (N) gear.

LOCATING THE REAR PARKING AID SENSORS



The rear parking aid sensors are in the rear bumper.

REAR PARKING AID AUDIBLE WARNINGS

A warning tone sounds when your vehicle approaches an object. As your vehicle moves closer to an object, the rate of the tone increases. The warning tone continuously sounds when an object is 12 in (30 cm) or less from the rear bumper.

If your vehicle remains stationary for a few seconds, the audible warning turns off. If your vehicle moves backward the tone sounds again.

Note: *When the parking aid system sounds a tone, the audio system may reduce the set volume.*

FRONT PARKING AID (IF EQUIPPED)

WHAT IS THE FRONT PARKING AID

Front parking sensors detect objects in front of your vehicle.

Parking Aids

FRONT PARKING AID LIMITATIONS

The front parking aid sensors are active when your vehicle is in any position other than park (P) and the vehicle speed is less than 5 mph (8 km/h).

The sensor coverage area is up to 28 in (70 cm) from the front bumper.

If your vehicle is in reverse (R), the front parking aid detects objects and provides an audible warning when your vehicle is moving at a low speed and when an object is moving toward your vehicle, for example, another vehicle at a low speed. If your vehicle remains stationary for a few seconds, the audible warning turns off. Visual indication is always active in reverse (R).

If your vehicle is in any forward gear, the front parking aid provides audible warnings and a visual indication when your vehicle is moving at a speed of 5 mph (8 km/h) or below and the system detects an object within the detection zone. If your vehicle remains stationary for a few seconds, the visual indication and audible warning turns off.

If your vehicle is in neutral (N), the front and rear sensors provide a visual indication only when your vehicle is moving below a speed of 5 mph (8 km/h) and the system detects obstacles inside the detection areas. Once your vehicle stops, the visual indication and audible warning stops after a few seconds.

LOCATING THE FRONT PARKING AID SENSORS



The front parking aid sensors are in the front bumper.

FRONT PARKING AID AUDIBLE WARNINGS

A warning tone sounds when there is an object within 28 in (70 cm) from the front bumper. As your vehicle moves closer to an object, the rate of the tone increases.

The warning tone continuously sounds when an object is 12 in (30 cm) or less from the front bumper.

Note: *If the detected object is 12 in (30 cm) or less from your vehicle, visual indication remains on.*

Parking Aids

PARKING AID INDICATORS

Parking Aid Indicators Shown When 360 Degree Camera Views are not Available



The system provides object distance indication through the touchscreen.

- As the distance to an object decreases, the indicators change color. The indicators for closer objects appear closer to the vehicle icon.
- The indicators are green when the object is at the farthest detection point. As the object gets closer, the indicators turn amber. When the object is at the closest detection point, the indicators turn red.
- If there is no object detected, the distance indicators are not activated.

The activated visual indicators continue displaying when your vehicle is stopped in reverse (R). If stopped in drive (D) or neutral (N), the activated visual indicators disappear after four seconds.

Note: *If stopped in drive (D) or neutral (N) with rear camera delay mode showing the rear camera view, the activated visual indicators continue displaying.*

Parking aids are not available in the following situations:

- The system is switched off.
- A trailer is connected.
- Sensors are blocked.
- A system fault occurs.

Note: *If the parking aids are not available, the distance indicators do not display. See **Parking Aids – Troubleshooting** (page 255).*

Note: *Front park aid indicators may not be available.*

Parking Aid Indicators Shown in 360 Degree Camera Views (If Equipped)

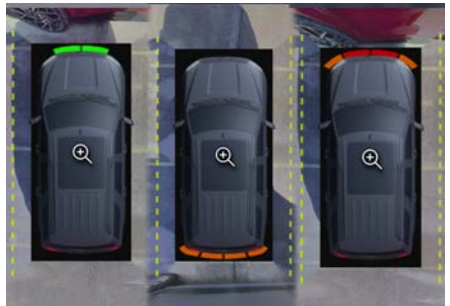

The system provides object distance indication through the touchscreen.

- As the distance to an object decreases, the indicators change color.
- The indicators are green when the object is at the farthest detection point. As the object gets closer, the indicators turn amber. When the object is at the closest detection point, the indicators turn red.
- If there is no object detected, the distance indicators are not activated.

The activated visual indicators continue displaying when your vehicle is stopped in reverse (R). If stopped in drive (D) or neutral (N), the activated visual indicators disappear after four seconds.

Parking Aids

Note: If stopped in drive (D) or neutral (N) with rear camera delay mode showing the rear camera view, the activated visual indicators continue displaying.

Parking aids are not available in the following situations:

- The system is switched off.
- A trailer is connected.
- Sensors are blocked. The distance indicators appear white.
- A system fault occurs.

Note: If the parking aids are not available, the distance indicators do not display. See **Parking Aids – Troubleshooting** (page 255).

PARKING AIDS – TROUBLESHOOTING

PARKING AIDS – INFORMATION MESSAGES

If a fault is present in the parking aids, a warning message appears in the instrument cluster or the touchscreen.

Message	Details
Parking Sensors fault	You may be able to resolve by cleaning the sensors and restarting your vehicle. If this does not resolve the condition, have your vehicle checked as soon as possible.
Parking Sensors not available Sensor blocked See manual Press OK to close	Inclement weather, ice, mud, or water is blocking the sensor, causing the system to become unavailable. You can typically clean the sensor to resolve.
Parking Sensors not available Sensor blocked See manual Press OK to close	Certain add-on devices installed around the bumper or fascia are blocking the sensor. Remove add-on devices to resolve.
Parking Sensors not available Sensor blocked See manual Press OK to close	This message may appear when you drive slowly at a constant distance from a stationary object. It disappears once the distance from the object changes. This may happen when driving slowly close to something like a wall.
Rear Park Aid Deactivated Trailer attached	The system senses an electrical trailer connection during a given ignition cycle.

Rear View Camera

WHAT IS THE REAR VIEW CAMERA

The rear view camera provides a video image of the area behind your vehicle when the transmission is in reverse (R).

Rear View Camera On Demand (if Equipped)



Press the camera button on the overhead console to bring up the rear camera view in the display.

Your vehicle must be on and the transmission should not be in reverse (R).

REAR VIEW CAMERA PRECAUTIONS



WARNING: The rear view camera system is a reverse aid supplement device that still requires the driver to use it in conjunction with the interior and exterior mirrors for maximum coverage.



WARNING: Objects that are close to either corner of the bumper or under the bumper, might not be seen on the screen due to the limited coverage of the camera system.



WARNING: Reverse your vehicle slowly. Failure to follow this instruction could result in the loss of control of your vehicle, personal injury or death.



WARNING: Use caution when the liftgate is ajar. If the liftgate is ajar, the camera is out of position and the video image could be incorrect. All guide lines disappear when the liftgate is ajar. Failure to follow this instruction could result in personal injury.



WARNING: Use caution when turning camera features on or off when the transmission is not in park (P). Make sure your vehicle is not moving.

Note: *When towing, the camera only sees what you are towing. This might not provide adequate coverage and you might not see some objects. In some vehicles, the guide lines may disappear when you connect the trailer tow connector.*

LOCATING THE REAR VIEW CAMERA

The rear view camera is on the liftgate or tailgate. It provides a view of the area behind your vehicle.

Rear View Camera

REAR VIEW CAMERA GUIDE LINES

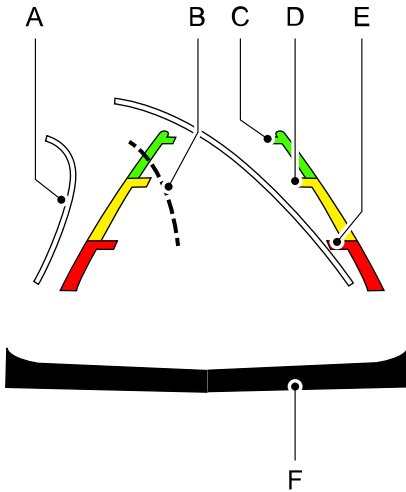

- A Active guide lines.
- B Centerline.
- C Fixed guide line: Green zone.
- D Fixed guide line: Yellow zone.
- E Fixed guide line: Red zone.
- F Rear bumper.

Active guide lines only show with fixed guide lines. To use active guide lines, turn the steering wheel to point the guide lines toward an intended path. If the steering wheel position changes while reversing, your vehicle might deviate from the intended path.

The fixed and active guide lines fade in and out depending on the steering wheel position. The active guide lines do not display when the steering wheel position is straight.

Use caution while reversing. Objects in the red zone are closest to your vehicle and objects in the green zone are farther away. Objects get closer to your vehicle as they move from the green zone to the yellow or red zones. Use the side view mirrors and rear view mirror to get better coverage on both sides and rear of your vehicle.

Note: Active guide lines and fixed guide lines are only available when the transmission is in reverse (R).

Note: The centerline is only available if the active or fixed guide lines are on.

Note: Not all camera modes work properly without an auxiliary camera.

REAR VIEW CAMERA SETTINGS

ZOOMING THE REAR VIEW CAMERA IN AND OUT

 **WARNING:** When manual zoom is on, the full area behind your vehicle may not show. Be aware of your surroundings when using the manual zoom feature.

Selectable settings for this feature are zoom in (+) and zoom out (-). Press the symbol on the camera screen to change the view. The default setting is zoom off.

This allows you to get a closer view of an object behind your vehicle. The zoomed image keeps the bumper in the image to provide a reference. The zoom is only active while the transmission is in reverse (R).

Rear View Camera

Note: Zooming in also engages park hold which applies the electric park brake when you shift to park (P). When you press the zoom button, the electronic park hold button illuminates on the touchscreen. See **Connecting a Trailer** (page 331).

Note: Manual zoom is only available when the transmission is in reverse (R).

Note: Only the centerline shows when you enable manual zoom.



The hitch view provides a wide-angle view of the area around the tow hitch. This view is available at all speeds in reverse (R), drive (D) and neutral (N).



Zooms in on the view and park hold is activated when your vehicle is in park (P). See **Connecting a Trailer** (page 331).

SWITCHING REAR VIEW CAMERA DELAY ON AND OFF

1. From the driver assistance menu, press Rear View Camera. See **Driver Assistance Menu** (page 469).
2. Switch rear view camera delay on or off.

When shifting the transmission out of reverse (R) and into any gear other than park (P), the camera image remains in the display until:

- Your vehicle speed reaches approximately 5 mph (8 km/h).
- You shift your vehicle into park (P).

SWITCHING THE REAR VIEW CAMERA VIEW



Rear normal view provides a view of what is directly behind your vehicle. This view is available at all speeds in reverse (R), drive (D) and neutral (N). When your vehicle is not in reverse (R), this view may be displayed with different text or graphics.



Rear split view provides a wide-angle view of what is behind your vehicle.

360 Degree Camera (If Equipped)

HOW DOES THE 360 DEGREE CAMERA WORK

The 360 degree camera system consists of front, side and rear cameras.

The 360 Degree Camera system:

- Allows you to see what is directly in front of or behind your vehicle.
- Provides a cross traffic view in front of and behind your vehicle.
- Allows you to see a top-down view of the area outside your vehicle, including the blind spots and obstacles near your vehicle.

360 DEGREE CAMERA PRECAUTIONS



WARNING: The 360 degree camera system still requires the driver to use it in conjunction with looking out of the windows, and checking the interior and exterior mirrors for maximum coverage.



WARNING: Objects that are close to either corner of the bumper or under the bumper, might not be seen on the screen due to the limited coverage of the camera system.



WARNING: Use caution when turning camera features on or off when the transmission is not in park (P). Make sure your vehicle is not moving.



WARNING: You are responsible for controlling your vehicle at all times. The system is designed to be an aid and does not relieve you of your responsibility to drive with due care and attention. Failure to follow this instruction could result in the loss of control of your vehicle, personal injury or death.



WARNING: Use caution when the rear cargo door is ajar. If the rear cargo door is ajar, the camera will be out of position and the video image could be incorrect. All guide lines disappear when the rear cargo door is ajar. Failure to follow this instruction could result in personal injury.



WARNING: When manual zoom is on, the full area behind your vehicle may not show. Be aware of your surroundings when using the manual zoom feature.

LOCATING THE 360 DEGREE CAMERAS

Rear View Camera

The rear view camera is on the liftgate. It provides a video image of the area behind your vehicle.

Front View Camera

The front view camera is in the grille. It provides a video image of the area in front of your vehicle.

Side View Camera

The side view camera is on the outside mirror. It provides a video image of the area on the sides of your vehicle to aid you when parking.

360 Degree Camera (If Equipped)

360 DEGREE CAMERA GUIDE LINES

Note: Active guide lines are only available when the transmission is in reverse (R).

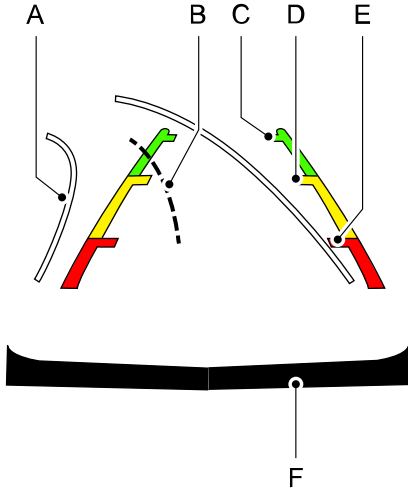

- A Active guide lines.
- B Centerline.
- C Fixed guide line: Green zone.
- D Fixed guide line: Yellow zone.
- E Fixed guide line: Red zone.
- F Rear bumper.

Active guide lines only show with fixed guide lines. Turn the steering wheel to point the guide lines toward an intended path. If the steering wheel position changes when reversing, your vehicle could deviate from the intended path.

The fixed and active guide lines fade in and out depending on the steering wheel position. The active guide lines do not display when the steering wheel position is straight.

Objects in the red zone are closest to your vehicle and objects in the green zone are farther away. Objects get closer to your vehicle as they move from the green zone to the yellow or red zones. Use the side view mirrors and rear view mirror to get better coverage on both sides and rear of your vehicle.

Side Mirror Clearance Guide Lines

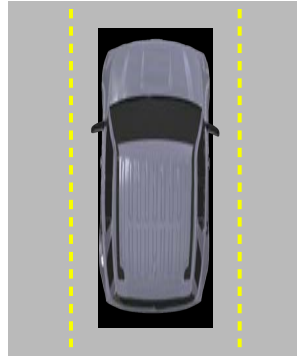

The yellow dotted guide lines running parallel to your vehicle represent the side mirror clearance zone. These lines are to help protect the mirrors when you park or maneuver in tight spaces.

360 Degree Camera (If Equipped)

360 DEGREE CAMERA SETTINGS

SWITCHING THE 360 DEGREE CAMERA ON AND OFF



The 360 degree camera system button is on the instrument panel and allows you to toggle the front camera on or off. The front and rear cameras have multiple screens which consist of:

- Normal view.
- Normal view with 360.
- Split view.

Note: *The rear view camera activates when you switch into reverse (R). Additional views are then accessible on the touchscreen.*

When in park (P), neutral (N) or drive (D), only the front images display when you press the button. When in reverse (R), only the rear images display when you press the button.

Note: *The 360 degree camera system remains on when your vehicle is in motion at low speed. The rear camera views remain on at all speeds when in reverse (R).*

SWITCHING THE 360 DEGREE CAMERA VIEW



Front normal view provides an image of what is directly in front of your vehicle.



Front split view provides an extended view of what is in front of your vehicle.



Normal + 360 degree view contains the normal camera view next to a 360 degree camera view.



Rear normal view provides an image of what is directly behind your vehicle. This view is available at all speeds in reverse (R), drive (D) and neutral (N). When your vehicle is not in reverse (R), this view may display with different text or graphics.



Rear split view provides an extended view of what is behind your vehicle.



The hitch view provides an image of the area around the tow hitch. This view is available at all speeds in reverse (R), drive (D) and neutral (N).



Zooms in on the rear normal view and park hold activates when you shift your vehicle to park (P). See **Connecting a Trailer** (page 331).



Provides access to multiple zoom options by touching the zoom button on the 360 degree camera view. View options include the ability to zoom to your vehicle corners or to the front or rear of your vehicle. Depending on what gear and which drive mode you select, guidelines may be available. See **360 Degree Camera Guide Lines** (page 260).

Note: *The hitch view and rear camera view are available at all speeds.*

Cruise Control - Police

WHAT IS CRUISE CONTROL

Cruise control lets you maintain a set speed without keeping your foot on the accelerator pedal.

Requirements

Use cruise control when the vehicle speed is greater than 20 km/h in metric units or 15 mph in imperial units.

SWITCHING CRUISE CONTROL ON AND OFF



WARNING: Do not use cruise control on winding roads, in heavy traffic or when the road surface is slippery. This could result in loss of vehicle control, serious injury or death.

The cruise controls are on the steering wheel.

Switching Cruise Control On



Press the button to activate the system. When the system activates, the set speed is equal to the current vehicle speed or 20 km/h (15 mph), whichever is greater. If the speed is too low, or other conditions are not correct for cruise control activation, the system enters standby mode.

Switching Cruise Control Off



Press the button when the system is active or switch the ignition off.

Note: When you switch cruise control off, the set speed clears.

SETTING THE CRUISE CONTROL SPEED



WARNING: When you are going downhill, your vehicle speed could increase above the set speed. The system does not apply the brakes.

Drive to the speed you prefer.

SET+

Press the toggle button upward or downward to set the current speed.

SET-

Take your foot off the accelerator pedal.

Note: The indicator changes color in the information display.

Changing the Set Speed

SET+

Press and release the toggle button upward to increase the set speed in small increments.

Press and hold the toggle button upward to accelerate. Release the button when you have reached your preferred speed.

SET-

Press and release the toggle button downward to decrease the set speed in small increments.

Press and hold the toggle button downward to decelerate. Release the button when you have reached your preferred speed.

Note: If you accelerate by pressing the accelerator pedal, the set speed does not change. When you release the accelerator pedal, your vehicle returns to the speed that you previously set.

Cruise Control - Police

CANCELING THE SET SPEED



Press the button, or tap the brake pedal to cancel the set speed.

Note: *The system remembers the set speed.*

Note: *The system cancels if the vehicle speed drops below 10 mph (16 km/h) under the set speed when driving uphill.*

RESUMING THE SET SPEED



Press the button.

CRUISE CONTROL INDICATORS



Illuminates when you switch the system on.

Adaptive Cruise Control - Excluding: Police

HOW DOES ADAPTIVE CRUISE CONTROL WITH STOP AND GO WORK

Adaptive cruise control with stop and go uses radar and camera sensors to maintain a set gap between your vehicle and the vehicle in front of you while following it to a complete stop. Stop and go can also be set to follow a vehicle directly in front of you and adjust the set speed, while you are at a complete stop.

ADAPTIVE CRUISE CONTROL PRECAUTIONS

 **WARNING:** You are responsible for controlling your vehicle at all times. The system is designed to be an aid and does not relieve you of your responsibility to drive with due care and attention. Failure to follow this instruction could result in the loss of control of your vehicle, personal injury or death.

 **WARNING:** Do not use adaptive cruise control on winding roads, in heavy traffic or when the road surface is slippery. This could result in loss of vehicle control, serious injury or death.

 **WARNING:** Pay close attention to changing road conditions such as entering or leaving a highway, on roads with intersections or roundabouts, roads without visible lanes of travel, roads that are unpaved, or steep slopes. Failure to follow this instruction could result in the loss of control of your vehicle, personal injury or death.

 **WARNING:** The system is not a crash warning or avoidance system.

 **WARNING:** Do not use the system when towing a trailer that has aftermarket electronic trailer brake controls. Failure to follow this instruction could result in the loss of control of your vehicle, personal injury or death.

 **WARNING:** Do not use tire sizes other than those recommended because this can affect the normal operation of the system. Failure to do so may result in a loss of vehicle control, which could result in serious injury.

 **WARNING:** Do not use the system with a snow plow blade installed.

 **WARNING:** In situations with poor visibility, such as fog, heavy rain or other inclement weather, you may need to override or completely switch off the system.

When Following a Vehicle

 **WARNING:** When following a vehicle that is braking, your vehicle does not always decelerate quickly enough to avoid a crash without driver intervention. Apply the brakes when necessary. Failure to follow this instruction could result in personal injury or death.

Hilly Condition Usage

Select a lower gear when the system is active in situations such as prolonged downhill driving on steep slopes, for example in mountainous areas.

Adaptive Cruise Control - Excluding: Police

ADAPTIVE CRUISE CONTROL LIMITATIONS

Sensor Limitations

WARNING: On rare occasions, detection issues can occur due to the road infrastructures, for example bridges, tunnels and safety barriers. In these cases, the system may brake late or unexpectedly. At all times, you are responsible for controlling your vehicle, supervising the system and intervening, if required.

WARNING: If the system malfunctions, have your vehicle checked as soon as possible.

WARNING: Large contrasts in outside lighting can limit sensor performance.

WARNING: The system only warns of vehicles detected by the radar sensor. In some cases there may be no warning or a delayed warning. Apply the brakes when necessary. Failure to follow this instruction could result in personal injury or death.

WARNING: The system may not detect stationary or slow moving vehicles below 6 mph (10 km/h).

WARNING: The system does not detect pedestrians or objects in the road.

WARNING: The system does not detect oncoming vehicles in the same lane.

WARNING: The system may not operate properly if the sensor is blocked. Keep the windshield free from obstruction.

WARNING: The system may incorrectly track lane markings as other structures or objects. This can result in a false or missed warning.

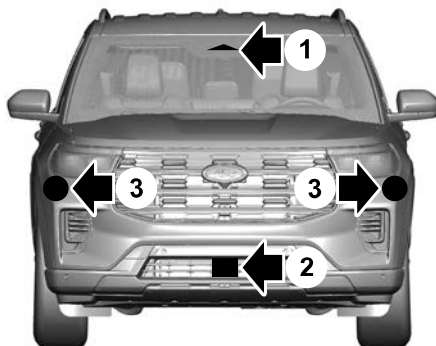

1. Camera.
2. Radar sensor (if equipped).
3. Corner radar (if equipped).

The system detects and tracks the road lane markings using a camera mounted behind the interior mirror.

The radar sensor is in the lower grille.

Note: You cannot see the sensor. It is behind a fascia panel.

Note: Keep the front of your vehicle free of dirt, metal badges or objects. Vehicle front protectors, aftermarket lights, additional paint or plastic coatings could also degrade sensor performance.

A message displays if something obstructs the camera or the sensor. When something blocks the sensor, the system cannot detect a vehicle ahead and does not function. See **Adaptive Cruise Control – Information Messages** (page 277).

Adaptive Cruise Control - Excluding: Police

The radar sensor has a limited field of view. It may not detect vehicles at all or detect a vehicle later than expected in some situations. The lead vehicle image does not illuminate if the system does not detect a vehicle in front of you.

Detection Issues Can Occur:

A

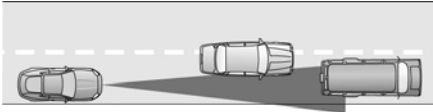

B

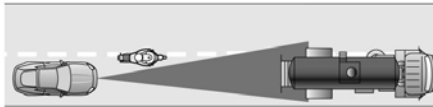

C

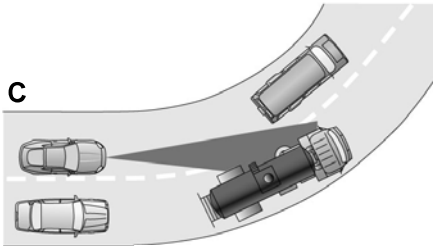

- A When driving on a different line than the vehicle in front.
- B With vehicles that edge into your lane. The system can only detect these vehicles once they move fully into your lane.
- C There may be issues with the detection of vehicles in front when driving into and coming out of a bend or curve in the road.

In these cases, the system may brake late or unexpectedly.

If something hits the front end of your vehicle or damage occurs, the radar-sensing zone may change. This could cause missed or false vehicle detections. Have your vehicle checked for proper coverage and operation as soon as possible.

Optimal system performance requires a clear view of the road by the windshield camera.

Optimal performance may not occur if:

- The camera is blocked.
- There is poor visibility or lighting conditions.
- There are bad weather conditions.

SWITCHING ADAPTIVE CRUISE CONTROL ON AND OFF

The cruise controls are on the steering wheel.

Switching Adaptive Cruise Control On



Press the button to activate the system. When the system activates, the set speed is equal to whichever is greater, the current vehicle speed, or 15 mph when in imperial units or 20 km/h when in metric units. If the speed is too low, or other conditions are not correct for adaptive cruise control activation, the system enters standby mode. When you are below 15 mph when in imperial units or 20 km/h when in metric units, adaptive cruise control does not activate unless you are following another vehicle.

The indicator, current gap setting and set speed appear in the instrument cluster display.

Adaptive Cruise Control - Excluding: Police

Switching Adaptive Cruise Control Off



Press the button when the system is in standby mode or switch your vehicle off.

Note: When you switch the system off, the set speed clears.

ADAPTIVE CRUISE CONTROL AUTOMATIC CANCELLATION

The system may cancel if:

- The tires lose traction.
- You apply the parking brake.

The system may cancel and set the parking brake if:

- You unbuckle the seatbelt and open the driver door after adaptive cruise control stops your vehicle.
- Adaptive cruise control holds your vehicle at a stop continuously for more than three minutes.

The system may deactivate or prevent activating when requested if:

- The vehicle has a blocked sensor.
- The brake temperature is too high.
- There is a failure in the system or a related system.

SETTING THE ADAPTIVE CRUISE CONTROL SPEED

Drive to the speed you prefer.

SET+

Press the SET+ or SET- buttons to set the current speed.

SET-

Take your foot off the accelerator pedal.

The indicator, current gap setting and set speed appear in the instrument cluster display when initially activating adaptive cruise control.

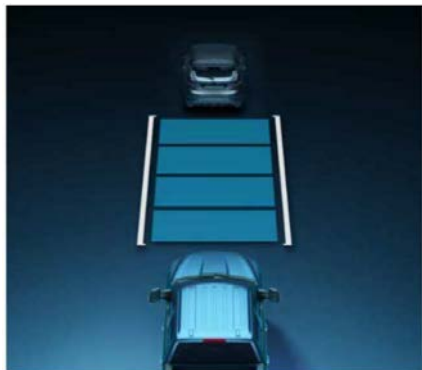

After a few seconds, the graphic in the instrument cluster display changes to show that adaptive cruise control is active.



A vehicle image illuminates if there is a vehicle detected in front of you.

Note: When adaptive cruise control is active, the speedometer may vary slightly from the set speed displayed in the instrument cluster display.

Adaptive Cruise Control - Excluding: Police

Setting the Adaptive Cruise Speed from a Complete Stop

SET+ Press the SET+ or SET- buttons while keeping the brake pedal fully depressed.

SET-

The set speed adjusts to 20 km/h when in metric units or 15 mph when in imperial units.

The indicator, current gap setting and set speed appear in the instrument cluster display.

Note: *The system activates from a complete stop only when it detects a lead vehicle in close proximity.*

Manually Changing the Set Speed

SET+ Press the SET+ button to increase the set speed in small increments. Press and hold the SET+ button to increase set speed in large increments. Release the button when the indicated set speed reaches the preferred speed.

SET- Press the SET- button to decrease the set speed in small increments. Press and hold the SET- button to decrease the set speed in large increments. Release the button when the indicated set speed reaches the preferred speed.

You can also press the accelerator or brake pedal until you reach the speed you prefer. Press the SET+ or SET- button to select the current speed as the set speed.

The system may apply the brakes to slow the vehicle to the new set speed. The set speed continuously displays in the instrument cluster display when the system is active.

SETTING THE ADAPTIVE CRUISE CONTROL GAP

 Press the button to cycle through the four gap settings.



The selected gap appears in the instrument cluster display as shown by the bars in the image.

Note: *The gap setting is time dependent and therefore, the distance adjusts with your vehicle speed.*

Note: *It is your responsibility to select a gap appropriate to the driving conditions.*

Adaptive Cruise Control Gap Settings

Graphic Display, Bars Indicated Between Vehicles	Gap Distance	Dynamic Behavior
1	Closest.	Sport.
2	Close.	Normal.
3	Medium.	Normal.
4	Far.	Comfort.

Each time you switch the system on, it selects the last chosen gap setting.

Adaptive Cruise Control - Excluding: Police

Following a Vehicle

When a vehicle ahead of you enters the same lane or a slower vehicle is ahead in the same lane, the vehicle speed adjusts to maintain the gap setting.

Note: When you are following a vehicle and you switch on a turn signal lamp, adaptive cruise control may provide a small, temporary acceleration to help you pass.

Your vehicle maintains a consistent gap from the vehicle ahead until:

- The vehicle in front of you accelerates to a speed above the set speed.
- The vehicle in front of you moves out of the lane you are in.
- You set a new gap distance.

The system applies the brakes to slow down your vehicle to maintain a safe gap distance from the vehicle in front of you. The system only applies limited braking. You can override the system by applying the brakes.

Note: The brakes may emit noise when applied by the system.

If the system determines that its maximum braking level is not sufficient, an audible warning sounds, a message appears in the instrument cluster display and an indicator flashes when the system continues to brake. Take immediate action.

CANCELING THE SET SPEED



Press the button or tap the brake pedal.

The set speed does not erase.

RESUMING THE SET SPEED



Press the button.

The vehicle speed returns to the previously set speed and gap setting. The set speed displays continuously in the instrument cluster display when the system is active.

Note: Only use resume if you are aware of the set speed and intend to return to it.

Resuming the Set Speed from a Complete Stop

Without an Active BlueCruise Subscription:

If your vehicle follows a vehicle to a complete stop and remains stationary for less than a few seconds, your vehicle accelerates from a stationary position to follow the vehicle ahead.

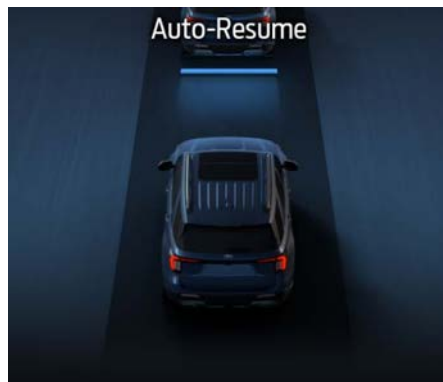

With an Active BlueCruise Subscription:

If your vehicle follows a vehicle to a complete stop and remains stationary for less than approximately three minutes, your vehicle accelerates from a stationary position to follow the vehicle ahead.

The following conditions must be met before your vehicle auto-resumes:

Adaptive Cruise Control - Excluding: Police

- You are facing forward and paying attention to the road ahead.
- The road is clear of obstacles such as pedestrians or other vehicles crossing your path.

If your vehicle follows a vehicle to a complete stop and remains stationary for more than a few seconds, an indicator and message displays.

Information Messages

Message	Details
Auto-Resume	(Only available with an active BlueCruise subscription). The vehicle is stopped behind a lead vehicle and all conditions are met for the vehicle to accelerate with the lead vehicle once the lead vehicle begins to accelerate.
Press button to resume	If the lead vehicle begins to move and all of the auto-resume conditions are not met, you are prompted to press the resume button. Pay attention to the road ahead and surroundings to make sure that it is safe to resume. Press and release the button or use the accelerator pedal to resume following the lead vehicle.
Stopped	Cruise control does not automatically resume when this display is active. Use the accelerator pedal to resume.

Note: *If approximately three minutes at a stop is exceeded, the vehicle cancels adaptive cruise control and the electric parking brake is set. The driver is required to resume control of the vehicle and release the electric parking brake.*

OVERRIDING THE SET SPEED



WARNING: If you override the system by pressing the accelerator pedal, it does not automatically apply the brakes to maintain a gap from any vehicle ahead.

When you press the accelerator pedal, you override the set speed and gap distance.

Use the accelerator pedal to intentionally exceed the set speed limit.

When you override the system, the indicator remains blue, the set speed is dimmed and the lead vehicle icon does not appear in the instrument cluster display.

The system resumes operation when you release the accelerator pedal. The vehicle speed decreases to the set speed, or a lower speed if following a slower vehicle.

Adaptive Cruise Control - Excluding: Police

ADAPTIVE CRUISE CONTROL INDICATORS



Illuminates when you switch adaptive cruise control on. The color of the indicator changes to indicate the system status.

White indicates the system is on but inactive.

Blue indicates that you set the speed and the system is active.

SWITCHING FROM ADAPTIVE CRUISE CONTROL TO CRUISE CONTROL



WARNING: Normal cruise control will not brake when your vehicle is approaching slower vehicles. Always be aware of which mode you have selected and apply the brakes when necessary.

1. From the driver assistance menu, press Cruise Control. See **Driver Assistance Menu** (page 469).
2. Press Normal Cruise Control.



When you select normal cruise control the cruise control indicator replaces the adaptive cruise control indicator. The gap setting does not display, and the system does not respond to lead vehicles. Automatic braking remains active to maintain the set speed. The system remembers the last setting when you start your vehicle.

LANE CENTERING

HOW DOES LANE CENTERING WORK

Adaptive cruise control with lane centering uses the vehicle's front radar sensor and front windshield camera sensor, together with the steering sensor to operate.

Using these sensors, the system applies continuous steering assistance towards driving in the middle of the lane.

Note: *The gap setting for adaptive cruise control with lane centering, operates in the same way as normal adaptive cruise control.*

LANE CENTERING PRECAUTIONS



WARNING: Do not use the system when towing a trailer or when the vehicle is loaded to near or over maximum payload. Failure to follow this instruction could result in the loss of control of your vehicle, personal injury or death.



WARNING: Do not use the system if any changes or modifications to the steering, suspension system or wheels and tires have been made. Any changes or modifications to the steering, suspension system or wheels and tires could affect the functionality and performance of the system. Failure to follow this instruction could result in the loss of control of your vehicle, personal injury or death.

Adaptive cruise control precautions apply to lane centering unless stated otherwise or contradicted by a lane centering precaution. See **Adaptive Cruise Control Precautions** (page 264).

Adaptive Cruise Control - Excluding: Police

LANE CENTERING REQUIREMENTS

You must keep your hands on the steering wheel at all times.

Lane centering only activates when all of the following occur:

- Adaptive cruise control with lane centering is enabled in the touchscreen. See **Switching Lane Centering On and Off** (page 272).
- You have adaptive cruise control enabled and set.
- The steering system detects your hands on the steering wheel.
- The system detects both lane markings when driving on a straight road.
- Your vehicle is initially centered in the lane between two visible line markings.
- Automatic Emergency Braking is switched on. See **Switching Automatic Emergency Braking On and Off** (page 315).
- The driver seatbelt is fastened.
- A trailer is not detected.

Note: *If the system does not detect valid lane line markings, the system remains in standby until valid line markings are available.*

Note: *If the system does not detect your hands on the steering wheel, apply a slight force to the steering wheel.*

LANE CENTERING LIMITATIONS

Adaptive cruise control limitations apply to lane centering unless stated otherwise or contradicted by a lane centering limitation. See **Lane Centering Requirements** (page 272).

Lane Centering may not be able to center your vehicle in the lane in any of the following conditions:

- The lane is too narrow or wide.
- The curve in the road is too tight.
- The system does not detect the minimum required lane markings or when lanes merge or split.
- When the required steering effort to maintain lane center exceeds the lane centering system limit.
- When driving in areas that are under construction or when road work is in progress.
- If the front windshield camera and/or the front radar are blocked.
- When using a spare tire.
- Inclement weather conditions including, but not limited to, high wind, heavy rain, and fog.
- Driving into direct sunlight.
- When modification to the steering system has been made, including alterations to the steering wheel.
- When a trailer is detected, the system disables lane centering. See **Lane Centering Precautions** (page 271).

Note: *The system steering assistance is limited and may not have sufficient effort for all driving situations and/or conditions, such as driving through tight curves or driving through curves at high speeds.*

Note: *In exceptional conditions, the system may deviate from the lane center.*

SWITCHING LANE CENTERING ON AND OFF

You must keep your hands on the steering wheel at all times.

The controls are on the steering wheel.

Adaptive Cruise Control - Excluding: Police



Press the button.

The indicator appears in the instrument cluster. When the lane centering system is on, the color of the indicator changes to indicate the system status.

You can override the system at any time by steering your vehicle.

Note: *The lane centering requirements must be met before you can enable the feature. See **Lane Centering Requirements** (page 272).*

Enabling and Disabling Lane Centering

1. From the driver assistance menu, press Cruise Control. See **Driver Assistance Menu** (page 469).
2. Press Adaptive Cruise Control.
3. Switch Lane Centering on or off.

LANE CENTERING ALERTS

You must keep your hands on the steering wheel at all times.

When the system is active and detects no steering activity for a period of time, the system alerts you to put your hands on the steering wheel. If you do not react to the warnings the system quickly applies and releases the brakes, activates the hazard lights, and slows your vehicle to a stop within the lane of travel while maintaining steering control. See **Lane Centering Automatic Cancellation** (page 273).

The system also alerts you if your vehicle crosses lane markings without detected steering activity.

Note: *If a keep hands on the wheel message appears on the instrument cluster display, the system may not detect a light grip or touch on the steering wheel. Slight steering wheel input may be required to cancel the message.*

LANE CENTERING AUTOMATIC CANCELLATION

When an external condition cancels the system, for example, no lane markings available, an audible warning sounds and a message appears in the instrument cluster display.

When an external condition cancels the system, and your hands are not on the steering wheel, the system immediately alerts you to take control of the vehicle.

If this alert is ignored, the system quickly applies and releases the brakes, activates the hazard lights, and slows your vehicle to a stop within the lane of travel.

If your vehicle slows down or stops and you resume control, a message appears to prompt you to press the accelerator pedal to allow the system to resume.

Note: *If the system detects significant inactivity, a 'Lane Centering Unavailable' message displays in the instrument cluster and lane centering is disabled until the next time you start your vehicle.*

Automatic cancellation can also occur if:

- The lane becomes too wide or too narrow.
- The system cannot detect valid lane markings.
- Lane markings cross over one another.
- The curve of the road is too sharp.

Adaptive Cruise Control - Excluding: Police

LANE CENTERING MANUAL CANCELLATION

When you perform the following actions, adaptive cruise control with lane centering will cancel:

- The brake pedal is pressed.
- Adaptive cruise control button on the steering wheel is switched off .

The lane centering system is momentarily suppressed when either of the following actions are performed:

- Turn signal indicator is latched or tapped with added steering input.
- You steer the vehicle out of lane.

LANE CENTERING INDICATORS



Illuminates when you switch lane centering on. The color of the indicator changes to indicate the system status.

Gray indicates the system is on but in standby mode.

Blue indicates the system is enabled and applying steering assistance to keep the vehicle in the center of the lane.

Amber with an audible tone, that then changes to gray, indicates a system automatic cancellation.

LANE CENTERING – TROUBLESHOOTING

LANE CENTERING – INFORMATION MESSAGES

Note: *Depending on your vehicle options and instrument cluster type, some messages can appear different or not at all.*

Message	Details
Keep hands on steering wheel	You must return your hands to the steering wheel and provide steering input to cancel the message.
Lane Centering not available	Lane centering is currently not available, due to conditions that prevent the system from becoming active. To reset the system, when the vehicle is stationary, return the gear selector to park (P) and turn the vehicle off. Then, restart the vehicle with your foot on the brake pedal.
Resume control	Adaptive cruise control with lane centering is about to cancel. You must immediately take full control of the vehicle.
Press accelerator pedal to resume	Adaptive cruise control with lane centering is in standby mode. When safe to do so, you can resume adaptive cruise control with lane centering by applying pressure on the accelerator pedal. Alternatively, you can also re-enable adaptive cruise control with lane centering by pressing the resume button on the steering wheel.

Adaptive Cruise Control - Excluding: Police

PREDICTIVE SPEED ASSIST

HOW DOES PREDICTIVE SPEED ASSIST WORK

Predictive Speed Assist works with adaptive cruise control and adjusts the vehicle speed to the road geometry and to the speed limit detected by the speed sign recognition system. As the system identifies curves and highway exits, the vehicle speed temporarily decreases ahead of and during the changing road geometry. When passing new speed signs, the set speed updates. See **Predictive Speed Assist Precautions** (page 275).

There are limitations that affect the accuracy of the speed sign recognition system and its ability to determine the current speed limit. Predictive speed assist and its ability to determine the current speed limit shares these limitations. See **Speed Sign Recognition** (page 318).

Note: *The adaptive cruise control gap setting operates normally when the feature is enabled.*

PREDICTIVE SPEED ASSIST PRECAUTIONS



WARNING: You are responsible for controlling your vehicle at all times. The system is designed to be an aid and does not relieve you of your responsibility to drive with due care and attention. Failure to follow this instruction could result in the loss of control of your vehicle, personal injury or death.



WARNING: Pay close attention to changing road conditions. You may need to override the system by pressing the brake or accelerator pedal if the adjusted speed becomes higher or lower than necessary.



WARNING: The system only provides limited braking. Your vehicle may not always decelerate quickly enough to avoid a crash without driver intervention. Apply the brakes when necessary.



WARNING: The system does not activate the turn signal.

Adaptive cruise control precautions apply to predictive speed assist unless stated otherwise or contradicted by a predictive speed assist precaution. See **Adaptive Cruise Control Precautions** (page 264).

The system only applies limited braking. You can override the system with the accelerator pedal or cancel the system by applying the brakes.

The system may adapt to various drive modes. See **Drive Mode Control** (page 223). This could influence speed adjustments and accelerations.

PREDICTIVE SPEED ASSIST LIMITATIONS



WARNING: The system may not always adjust vehicle speed in certain road or weather conditions such as crossing traffic, yield or stop signs, right of way, traffic lights, speed bumps, rain, snow, fog. You must always apply the brake or accelerator pedal when necessary.

Adaptive Cruise Control - Excluding: Police

The road geometry and speed limit information provided by the navigation map data could be inaccurate or out of date.

The system may not detect and read speed limit signs with conditional information, for example, when a sign is flashing, during specific time ranges, or when children are present.

Note: *The system does not set the vehicle speed to speed limits shown with a supplementary traffic sign.*

Under certain conditions, the system may not adjust the vehicle speed until after your vehicle passes the speed limit.

Detection of road geometry operates only where related information is available. Road geometry information may not be available in some areas.

SWITCHING PREDICTIVE SPEED ASSIST MODE ON AND OFF

1. From the driver assistance menu, press Cruise Control. See **Driver Assistance Menu** (page 469).
2. Press Adaptive Cruise Control.
3. Switch Predictive Speed Assist on or off.

ADJUSTING THE SET SPEED TOLERANCE

1. From the driver assistance menu, press Cruise Control. See **Driver Assistance Menu** (page 469).
2. Press Adaptive Cruise Control.
3. Switch Predictive Speed Assist on.
4. Press Speed Adjustment.
5. Press the + and - buttons to adjust the tolerance.

Note: *You can set the tolerance for vehicle speed adjustment based on speed sign recognition only.*

PREDICTIVE SPEED ASSIST ALERTS

If the speed sign recognition system detects a speed limit below the minimum adaptive cruise control set speed, a tone sounds and the system returns to standby mode.

PREDICTIVE SPEED ASSIST INDICATORS

A blue marker around the speed sign and a blue arrow next to the set speed indicates that the system is active.

Speed sign indicator



When the system detects a new speed sign, a gray indicator appears above the speed limit icon while the system adjusts the vehicle speed to the speed limit. When the speed limit is reached, the set speed updates and the gray indicator disappears.

Adaptive Cruise Control - Excluding: Police

Road geometry indicator

When the system detects a curve or highway exit, the vehicle starts to decelerate, and the indicator appears and changes color.

Road geometry indicator symbols



Left curve.



Right curve.

PREDICTIVE SPEED ASSIST – TROUBLESHOOTING

PREDICTIVE SPEED ASSIST – INFORMATION MESSAGES

Message	Details
Adaptive Cruise Control Predictive Speed Assist not available	Navigation system based speed limit information is not available. If the message continues to appear, have your vehicle checked as soon as possible.
Adaptive Cruise Control Driver resume control	The system is going to cancel and you must take control.

ADAPTIVE CRUISE CONTROL – TROUBLESHOOTING

Note: *The system could abbreviate or shorten certain messages depending upon which cluster type you have.*

ADAPTIVE CRUISE CONTROL – INFORMATION MESSAGES

Note: *Depending on your vehicle options and instrument cluster type, not all messages display or are available.*

Adaptive Cruise Control - Excluding: Police

Message	Details
Front sensor not aligned	Contact an authorized dealer to have the radar checked for proper coverage and operation.
Cruise Control not available	Conditions exist preventing the system from being available.
Adaptive Cruise Control not available Sensor blocked See manual	<p>You have a blocked radar because of poor radar visibility due to inclement weather or ice, mud, or water in front of the sensor. You can typically clean the sensor to resolve this issue.</p> <p>Due to the nature of sensor technology, it is possible to get a blockage warning with no actual block. This happens, for example, when driving in sparse rural or desert environments. A false blocked condition either self clears, or clears after you restart your vehicle.</p>
Normal Cruise Control active Adaptive Braking off	You have selected normal cruise control. The system does not brake or react to traffic.
Resume control	Displays when the adaptive cruise control is going to cancel and you must take control.
Cruise Control Speed too low to activate	Displays when the vehicle speed is too slow to activate the adaptive cruise control and there is no lead vehicle in range.

BlueCruise (If Equipped)

HOW DOES BLUECRUISE WORK

BlueCruise is a driver assistance system that allows your hands to be off the steering wheel in certain situations on compatible roads (blue zones) when using adaptive cruise control. When adaptive cruise control is active, the BlueCruise system steers the vehicle to maintain lane position. While using BlueCruise, even if your hands are off the steering wheel and your foot is not applying the accelerator or brake pedal, you must constantly supervise all driving tasks so that you are prepared to immediately steer, brake or accelerate if needed to maintain the safe operation of your vehicle. The system is designed to be an aid and does not relieve you of your responsibility to always remain alert.

BlueCruise uses cameras to monitor your vehicle position within a lane and applies steering support to keep your vehicle centered in the lane.

Using the cameras and location information, BlueCruise allows you to remove your hands from the steering wheel and offers a hands-free driving mode in certain areas.

When active, BlueCruise uses a driver facing camera and infrared lighting to monitor your eyes and head position to detect if you are distracted. If the system determines you are distracted, it alerts you to return your eyes to the road.

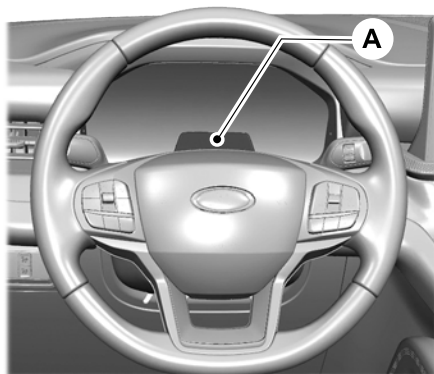

A Lighting and camera area.

Note: When BlueCruise is active, in certain crash or near crash-like situations, such as an air bag deployment or hitting a road obstacle, camera data may record through the vehicle event data recorder. See **Event Data** (page 26).

Note: No data records under normal driving conditions.

BLUECRUISE PRECAUTIONS





WARNING: You are responsible for keeping your eyes on the road at all times. The system is designed to be an aid and does not relieve you of your responsibility to drive with due care and attention. Failure to follow this instruction could result in the loss of control of your vehicle, personal injury or death.

BlueCruise (If Equipped)

 **WARNING:** You are responsible for controlling your vehicle at all times. The system is designed to be an aid and does not relieve you of your responsibility to drive with due care and attention. Failure to follow this instruction could result in the loss of control of your vehicle, personal injury or death.

 **WARNING:** Do not use the system when towing a trailer. Failure to follow this instruction could result in the loss of control of your vehicle, personal injury or death.

 **WARNING:** Obstructions to the driver facing camera or infrared lighting could prevent the system from properly operating. Keep the camera and lighting areas free from obstruction. Failure to follow this instruction could result in the loss of control of your vehicle, personal injury or death.

 **WARNING:** Do not use the system if any changes or modifications to the steering wheel have been made. Any changes or modifications to the steering wheel could affect the functionality or performance of the system. Failure to follow this instruction could result in the loss of control of your vehicle, personal injury or death.

 **WARNING:** The system may not function if the sensor is blocked.

 **WARNING:** Pay close attention to changing road conditions such as entering or leaving a highway, on roads with intersections or roundabouts, roads without visible lanes of travel, roads that are unpaved, or steep slopes, railroad crossings, pedestrian crossings, and school zones. Failure to follow this instruction could result in the loss of control of your vehicle, personal injury or death.

 **WARNING:** The system is not a crash warning or avoidance system.

 **WARNING:** Large contrasts in outside lighting can limit sensor performance.

 **WARNING:** The system attempts to keep your vehicle in the center of the lane as well as maintain speed and gap control. The system may not be able to perform these tasks in all situations. Do not use the system in complex or uncertain driving conditions. Failure to follow this instruction could result in the loss of control of your vehicle, personal injury or death.

 **WARNING:** Your vehicle could drift out of the lane of travel. Always be prepared to manually steer your vehicle. Failure to follow this instruction could result in the loss of control of your vehicle, personal injury or death.

 **WARNING:** The system will not operate if the sensor cannot track the road lane markings.

BlueCruise (If Equipped)

BLUECRUISE REQUIREMENTS

BlueCruise only activates when all of the following occur:

- BlueCruise subscription is active. See Ford.com (<https://www.ford.com/connectedservices/>) or the FordPass app for details.
- Modem is enabled. See **Connecting the Vehicle to a Mobile Network** (page 452).
- BlueCruise is enabled in your center display screen. See **BlueCruise Settings** (page 282).
- Adaptive cruise control is switched on.
- Automatic Emergency Braking is switched on. See **Switching Automatic Emergency Braking On and Off** (page 315).
- The driver seatbelt is fastened.
- The system detects both lane markings.
- Your hands are on the steering wheel.
- Your eyes are on the road.

Note: For hands-free mode to work, your vehicle must be on certain limited access divided freeways.

Note: The system may require updated software for hands-free mode. See **Vehicle Software Updates** (page 481).

Note: Without an active BlueCruise subscription, your vehicle is still capable of lane centering. This system requires you to keep your hands on the steering wheel at all times. See **Lane Centering Requirements** (page 272).

BLUECRUISE LIMITATIONS

BlueCruise is a driver assistance system that allows your hands to be off the steering wheel in certain situations on compatible roads (blue zones) when using adaptive cruise control. It is not a crash avoidance system. The BlueCruise feature utilizes other driver assistance technologies. Refer to the Owner's Manual for information pertaining to each driver assistance system.

Before using BlueCruise, it is important to understand the limitations of:

- Adaptive Cruise Control. See **Adaptive Cruise Control** (page 264).
- Lane Centering Assist. See **Lane Keeping System** (page 290).
- Pre-Collision Assist, including Automatic Emergency Braking. See **Pre-Collision Assist** (page 311).

Any of the following conditions could result in BlueCruise not correctly operating:

- You do not have your vehicle centered in the lane.
- The lane is too narrow or too wide.
- The curve in the road is too small.
- The system does not detect the minimum required lane marking or when lanes merge or split.
- When the required steering effort to maintain lane center exceeds the lane centering system limit.
- You are applying a low amount of steering input.
- Curve of the road is too sharp.
- You are using the system in areas under construction.
- If you make any aftermarket modifications to the steering system.
- You are using a spare tire.

BlueCruise (If Equipped)

The driver facing camera may not operate correctly due to any of the following:

- You have visual impairment, such as an eye misalignment, or have had eye surgery.
- You cover your facial features by a mask, hat or other items.
- The lighting conditions significantly change.
- You are not in the camera's field of view.
- You position or tilt yourself to one side.
- You are moving around a lot.
- You are wearing glasses or sunglasses that are too dark or reflective.

Note: *The system has limited steering assistance and may not be sufficient for all driving situations.*

Note: *In conditions such as inclement weather or direct sunlight, the system could deviate from the center line.*

Note: *The information provided by the navigation map data could be inaccurate or out of date.*

BLUECRUISE SETTINGS

Enabling BlueCruise

1. From the driver assistance menu, press Cruise Control. See **Driver Assistance Menu** (page 469).
2. Press Adaptive Cruise Control.
3. Press Lane Centering with Hands-Free.

Enabling Activation Prompts

1. From the driver assistance menu, press Cruise Control. See **Driver Assistance Menu** (page 469).
2. Press Adaptive Cruise Control.
3. Press Activation Prompts.

Switching Lane Change Assist On And Off

1. From the driver assistance menu, press Cruise Control. See **Driver Assistance Menu** (page 469).
2. Press Adaptive Cruise Control.
3. Press Lane Change Assist to toggle the system on and off.

Switching In-Lane Repositioning On And Off

1. From the driver assistance menu, press Cruise Control. See **Driver Assistance Menu** (page 469).
2. Press Adaptive Cruise Control.
3. Press Lane Centering with Hands-Free.
4. Press In-Lane Repositioning to toggle the system on and off.

Switching Automatic Lane Change On and Off

1. From the driver assistance menu, press Cruise Control. See **Driver Assistance Menu** (page 469).
2. Press Adaptive Cruise Control.
3. Press Automatic Lane Change to toggle the system on and off.

Note: *If automatic lane change is switched off, lane change assist remains active. See **Lane Change Assist** (page 284).*

SWITCHING BLUECRUISE ON AND OFF

Switching BlueCruise On

The controls are on the steering wheel.

Using Activation Prompts



When the prompt appears, press the button to switch BlueCruise on.

BlueCruise (If Equipped)

The indicator appears in the instrument cluster display. When the system is on, the color of the indicator changes to indicate the system status.

Note: You must enable activation prompts in the touchscreen.

Using Steering Wheel Controls



Using the adaptive cruise control and lane keeping buttons, make sure both systems are active. BlueCruise activates.



Switching BlueCruise Off



Press either the lane keeping or adaptive cruise control button when system is active or in standby mode.



BlueCruise turns off through each ignition cycle.

BLUECRUISE ALERTS

When BlueCruise is providing hands-on driving or transitioning to hands-on driving from hands-free driving and detects no steering activity for a certain period of time, the system alerts you with an audible warning and a message in the instrument cluster display to put your hands on the steering wheel.

When BlueCruise is providing hands-on or hands-free driving and detects you are not looking at the road for a certain period of time, the system alerts you to return your eyes to the road. Depending on where you are looking, the alert can be a message in the instrument cluster and an audible warning.

If you do not react to the warnings, the system alerts you to take control of your vehicle, quickly applies and releases the brakes, activates the hazard lights, and slows your vehicle to a stop within the lane of travel while maintaining steering control.

If your vehicle slows down or stops and you resume control, a message appears to prompt you to press the accelerator pedal to allow the system to resume.

Note: If the system detects significant inactivity, it disables until the next time you start your vehicle.

BLUECRUISE AUTOMATIC CANCELLATION

When an external condition cancels BlueCruise, for example, no lane markings available, a message appears in the instrument cluster, and an audible warning sounds.

RES If your vehicle starts to slow down, you must take control by returning your attention to the road and your hands to the steering wheel. Then press and release the button to reactivate BlueCruise.

System cancellation can also occur if:

- The lane becomes too narrow.
- The system cannot detect valid lane markings.
- Lane markings cross.
- Curve of the road is too sharp.
- Your eyes are not on the road or your hands are not on the steering wheel.

If you have your hands on the steering wheel and your eyes are on the road when the feature is active and a cancellation occurs, the system displays a canceled graphic in the instrument cluster and sounds an audible warning.

BlueCruise (If Equipped)

If you are not paying attention to the road or your hands are not on the steering wheel and a cancellation occurs, the system displays a message in the instrument cluster, and sounds an audible warning until you resume control.

If you do not resume control in time, BlueCruise quickly activates and releases the brakes, activates the hazard lights, and slows your vehicle to a stop within the lane of travel while maintaining steering control.

If your vehicle slows down or stops and you resume control, a message appears to prompt you to press the accelerator pedal to allow the system to resume.

Note: *If the system detects repeated inactivity, it disables until the next time you start your vehicle.*

BLUECRUISE INDICATORS



When on, the color of the indicator changes to indicate the status.

Gray: system is on but not active.

Blue: system is active and applying continuous assistance with steering support.

Hands-On Driving Support Available



The graphic in the instrument cluster changes to a wheel with hands indicating hands-on driving mode is active.

When this indicator is present, you must keep your hands on the steering wheel.

Hands-Free Driving Support Available



A graphic in the instrument cluster of a steering wheel without hands indicates the hands-free driving mode is available.

When this indicator is present, you can remove your hands from the steering wheel.

LANE CHANGE ASSIST



WARNING: You are responsible for controlling your vehicle at all times. The system is designed to be an aid and does not relieve you of your responsibility to drive with due care and attention. Failure to follow this instruction could result in the loss of control of your vehicle, personal injury or death.

BlueCruise (If Equipped)



WARNING: Do not use the lane change assist system as a replacement for using the interior and exterior mirrors or looking over your shoulder before changing lanes. The lane change assist system is not a replacement for careful driving.



Lane change assist can automatically perform a single lane change when you request the lane change using the turn signal lever. This feature is available above 40 mph (65 km/h).

1. Make sure the lane you are requesting is clear of traffic or obstacles.
2. Tap or latch the lever in the direction of your planned lane change.
3. Once the lane change is complete, move the turn signal lever back to the middle position if necessary.

Note: When using lane change assist you can tap or latch the turn signal lever.

Lane Change Suggestion

If you are approaching or have been following a slower moving vehicle, the system may suggest a lane change to pass that vehicle using an available passing lane.

Lane Change Assist Limitations

Lane change assist does not perform the requested maneuver if traffic is detected in the selected lane.

Lane Change Assist Cancellation

To cancel lane change assist, manually steer your vehicle or use the turn signal lever. If the turn signal lever is latched, return to the middle position. If not latched, tap the lever in the opposite direction.

Lane Change Assist Information Messages

Message	Details
Lane busy	The lane you have selected to enter has a vehicle or obstacle.
No lane seen	A lane is not recognized or available to perform the requested maneuver.
Changing lanes	The requested lane change is being performed.
Lane change possible	If desired, press the turn signal lever in the direction indicated by the lane change suggestion to initiate the lane change.

Note: *The instrument cluster display may abbreviate or shorten certain messages.*

AUTOMATIC LANE CHANGE



WARNING: You are responsible for controlling your vehicle at all times. The system is designed to be an aid and does not relieve you of your responsibility to drive with due care and attention. Failure to follow this instruction could result in the loss of control of your vehicle, personal injury or death.

The system performs an automatic lane change if a slower moving vehicle ahead in your lane is detected. If a lane exists and there is space available in that lane, the system makes a single lane change into the adjacent left lane. Automatic lane change is an extension of lane change assist.

If you are in the left lane, the system returns your vehicle to the adjacent lane to the right when space becomes available to move you out of the passing lane.

Automatic lane change does not operate when the system identifies the following target lane conditions:

- Highway entry.
- Highway exit.
- Lane ending.
- Construction zone.

This feature is available above 40 mph (65 km/h).

Note: *Automatic lane change does not move your vehicle to the next lane if traffic is identified in the selected lane. If traffic is identified after the lane change is initiated, it cancels.*

Note: *Automatic lane change operates independently from the planned navigation route.*

Note: *An automatic lane change may occur when a high occupancy vehicle lane is open. It is your responsibility to know the laws and drive in the appropriate lane.*

Overriding Automatic Lane Change

Hold the steering wheel or tap the turn signal lever in the opposite direction to cancel an automatic lane change.

BlueCruise (If Equipped)

Automatic Lane Change Indicators



A message and lane change path are shown in the instrument cluster display.

IN-LANE REPOSITIONING

BlueCruise with in-lane repositioning uses the vehicle's front and corner radar sensors together with the front windshield camera sensor to operate.

Using these sensors, the system automatically adjusts your vehicle's position in the lane based on the current driving situation.

Note: *In-lane repositioning is active only when BlueCruise is enabled while traveling on divided highways and when any of the following occur:*

- Passing or being passed by adjacent lane vehicles in close proximity.
- In a curve.
- Driving in outer lanes.

Note: *In certain situations, the vehicle may shift slightly away from the center of the lane without showing the indicators.*

Note: *Keep the front of your vehicle free of dirt, metal badges or objects. Vehicle front protectors, aftermarket lights, additional paint or plastic coatings could also degrade sensor performance.*

Note: *The radar sensor has a limited field of view. It may not detect vehicles at all or detect a vehicle later than expected in some situations.*

In-Lane Repositioning Indicators



Shifted towards the right-hand side of the lane.

BlueCruise (If Equipped)



Shifted towards the left-hand side of the lane.

BLUECRUISE – INFORMATION MESSAGES

Depending on your vehicle options and instrument cluster type, not all messages display or are available.

Message	Details
Keep hands on steering wheel	Make sure you return your hands to the steering wheel and provide steering input.
Resume control	The system is going to cancel and you must take control by returning your attention to the road and your hands to the steering wheel.
Watch the road	Return your attention to the road.
BlueCruise not available	Conditions exist preventing the system from being available. If the message continues to display, have the system checked as soon as possible.
Press accelerator pedal to resume	Press the accelerator pedal and follow the prompts.
Driver monitor camera cannot detect face See manual	Make sure your facial features are visible and in the field of view of the driver facing camera.
Driver monitor camera is blocked See manual	Make sure your hands, arms or other objects are not obscuring the camera.
Driver monitor camera fault See manual	Conditions exist preventing the system from being available. If the message continues to display, have the system checked as soon as possible.

BlueCruise (If Equipped)

Message	Details
BlueCruise On Watch the road Be prepared to resume control	BlueCruise is active, keep your attention on the road.
Canceled Lane Conditions	Invalid lane conditions caused the system to cancel.
Canceled Sharp Curve	A sharp curve in the road caused the system to cancel.
Hands on Steering Wheel in This Area	The vehicle entered an area not supported by the system to provide hands-free driving.
Speed Too High	The vehicle speed exceeded the maximum allowable limit for system to provide hands-free driving
Apply Light Steering Keep Hands on Wheel	The system requires light steering input to confirm that your hands are on the steering wheel. You must keep your hands on the steering wheel.
Ensure face can be detected to continue using BlueCruise	Make sure your facial features are visible and in the field of view of the driver facing camera for continuous hands-free driving support.
Ensure face can be detected to continue using Lane Centering	Make sure your facial features are visible and in the field of view of the driver facing camera for continuous hands-on driving support.
BlueCruise available Press {ICON} to activate	The system is in standby mode, press the button on the steering wheel to activate.

Note: *The instrument cluster display may abbreviate or shorten certain messages.*

Lane Keeping System (If Equipped)

WHAT IS THE LANE KEEPING SYSTEM

The lane keeping system alerts you by providing temporary steering assistance or steering wheel vibration when it detects an unintended lane or road departure.

HOW DOES THE LANE KEEPING SYSTEM WORK

The lane keeping system uses a forward looking camera mounted on the windshield to monitor vehicle movement within the lane of travel.

When the camera detects a drift out of the lane of travel, the lane keeping system alerts the driver by vibrating the steering wheel, or aids the driver by providing a small steering input to move the vehicle back into the lane of travel.

The driver can select one of three modes:

- Alert (if equipped)
- Aid
- Alert + Aid

LANE KEEPING SYSTEM PRECAUTIONS

 **WARNING:** You are responsible for controlling your vehicle at all times. The system is designed to be an aid and does not relieve you of your responsibility to drive with due care and attention. Failure to follow this instruction could result in the loss of control of your vehicle, personal injury or death.

 **WARNING:** The system will not operate if the sensor cannot track the road lane markings.

 **WARNING:** The sensor may incorrectly track lane markings as other structures or objects. This can result in a false or missed warning.

 **WARNING:** In cold and severe weather conditions the system may not function. Rain, snow and spray can all limit sensor performance.

 **WARNING:** The system may not operate properly if the sensor is blocked. Keep the windshield free from obstruction.

 **WARNING:** If damage occurs in the immediate area surrounding the sensor, have your vehicle checked as soon as possible.

 **WARNING:** The system may not function properly if your vehicle is fitted with a replacement windshield not approved by us.

 **WARNING:** Large contrasts in outside lighting can limit sensor performance.

 **WARNING:** The system may not correctly operate if your vehicle is fitted with a suspension kit not approved by Ford.

LANE KEEPING SYSTEM LIMITATIONS

The lane keeping system only operates when the vehicle speed is greater than 40 mph (64 km/h).

The system works when the camera can detect at least one lane marking or the edge of the road.

Lane Keeping System (If Equipped)

Note: When you select Aid or Alert and Aid mode and the system detects no steering activity for a short period of time, the system alerts you to put your hands on the steering wheel. The system may detect a light grip or touch on the steering wheel as hands-off driving.

The lane keeping system may not correctly operate in any of the following conditions:

- The lane keeping system does not detect at least one lane marking or the edge of the road.
- You switch the turn signal on.
- You apply direct steering, accelerate fast or brake hard.
- The vehicle speed is less than 40 mph (64 km/h).
- The anti-lock brake, stability control or traction control system activates.
- The lane is too narrow.
- Something is obscuring the camera or it is unable to detect the lane markings due to environment, traffic or vehicle conditions.
- Entering or exiting a tight curve when driving at high speeds.

The lane keeping system may not correct lane positioning in any of the following conditions:

- High winds.
- Uneven road surfaces.
- Heavy or uneven loads.
- Incorrect tire pressure.

SWITCHING THE LANE KEEPING SYSTEM ON AND OFF



To activate the lane keeping system, press the button on the steering wheel.

To deactivate the lane keeping system, press the button again.

Note: When switching the system on or off a message appears in the instrument cluster display to show the status.

Note: The system stores the on or off setting until manually changed by you.

SWITCHING THE LANE KEEPING SYSTEM MODE

1. From the settings menu, press Driver Assistance. See **Center Display** (page 467).
2. Press Lane-Keeping System.
3. Press Lane-Keeping Mode.
4. Select a mode.

Note: The system stores the on or off setting until manually changed. For some markets, the system defaults to the ON setting at every Ignition cycle.

ALERT MODE

WHAT IS ALERT MODE

Alert mode vibrates the steering wheel when it detects an unintended lane departure.

Lane Keeping System (If Equipped)

HOW DOES ALERT MODE WORK

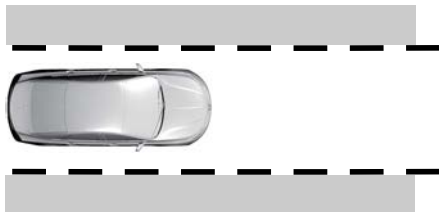

When in alert mode, the lane keeping system alerts you by vibrating the steering wheel. The intensity of the vibration is set through the lane keeping system menu.

ADJUSTING THE STEERING WHEEL VIBRATION INTENSITY

1. From the settings menu, press Driver Assistance. See **Center Display** (page 467).
2. Press Lane-Keeping System.
3. Press Alert Intensity.
4. Select an intensity setting.

AID MODE

WHAT IS AID MODE

Aid mode provides temporary steering assistance toward the center of the lane.

HOW DOES AID MODE WORK

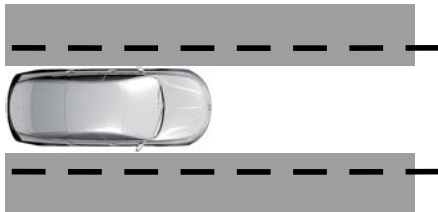

The lane keeping system aids you when an unintentional lane departure occurs. The system provides a small steering input to move the vehicle towards the center of the lane.

ALERT AND AID MODE

WHAT IS ALERT AND AID MODE

Alert and aid mode uses multiple features to keep you in your lane. The system first provides a small steering input to bring your vehicle back towards the center of the lane. If your vehicle moves too far from the center of the lane the system alerts you with vibration in the steering wheel.

Lane Keeping System (If Equipped)

HOW DOES ALERT AND AID MODE WORK

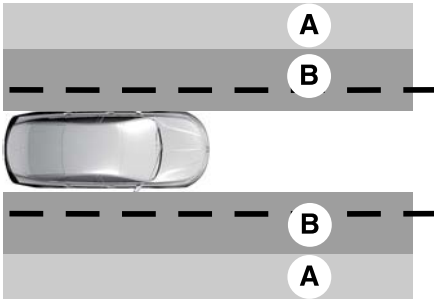

- A Alert.
- B Aid.

The lane keeping system detects a lane departure and provides aid when the vehicle enters **B** and applies the additional alert warning if **A** is entered.

LANE KEEPING SYSTEM INDICATORS

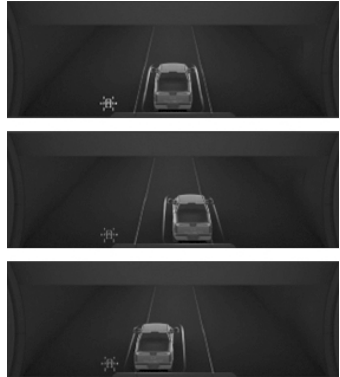

If you switch the lane keeping system on, a graphic with lane markings appears in the instrument cluster display.

When you switch the system off, the lane marking graphics do not display.

Note: *The overhead vehicle graphic may still display if adaptive cruise control is enabled.*

While the lane keeping system is on, the color of the lane markings change to indicate the system status.

Gray	Green or White	Orange	Red
Indicates that the system is temporarily unavailable to provide a warning or intervention on the indicated side.	Indicates that the system is available or ready to provide a warning or intervention on the indicated side.	Indicates that the system is providing or has just provided a lane keeping aid intervention.	Indicates that the system is providing or has just provided a lane keeping alert warning.

Lane Keeping System (If Equipped)

BLIND SPOT ASSIST (IF EQUIPPED)

WHAT IS BLIND SPOT ASSIST

Blind spot assist is an extension of the lane keeping system.

It helps you identify adjacent vehicles in your blind spot during a lane change.

The system provides a blind spot alert and steering assistance to help you steer away from detected adjacent vehicles.

HOW DOES BLIND SPOT ASSIST WORK



Activate and deactivate the system using the lane keeping system button on the steering wheel.

The blind spot assist feature is enabled whenever you select Aid or Alert +Aid from the lane keeping system.

During lane changes, the blind spot assist feature detects vehicles in, or approaching your blind spot and provides a warning plus steering assistance to direct your vehicle back into your lane.

When active, this system functions with or without the use of turn signals and hazard flashers.

You must keep your hands on the steering wheel at all times.

BLIND SPOT ASSIST LIMITATIONS

All system limitations present in the basic lane keeping system also apply to blind spot assist.

Blind spot assist does not function under the following conditions:

- No lane markings are detected.
- One or both rear radar sensors become blocked or faulty.
- Attaching bike or cargo racks could cause false alerts due to obstruction of the sensor.

Blind spot assist may have difficulty detecting hazards under the following conditions:

- If a vehicle is approaching in an adjacent lane at a speed higher than your vehicle.
- Bad weather obstructing the sensors.

BLIND SPOT ASSIST WITH TRAILER COVERAGE (IF EQUIPPED)

WHAT IS BLIND SPOT ASSIST WITH TRAILER COVERAGE

Blind spot assist with trailer coverage is an extension of the lane keeping system.

It may help you identify adjacent vehicles during a lane change.

Blind spot assist provides a blind spot warning and steering assistance to help you become aware of and steer away from vehicles in your blind spot during lane changes.

When attaching a trailer, ensure you have properly set up the trailer coverage settings. See **Blind Spot Information System With Trailer Coverage** (page 300).

HOW DOES BLIND SPOT ASSIST WITH TRAILER COVERAGE WORK



Activate and deactivate the system using the lane keeping system button on the steering wheel.

Lane Keeping System (If Equipped)

The blind spot assist feature is enabled whenever you select Aid or Alert +Aid from the lane keeping system.

During lane changes, the design of the blind spot assist feature detects vehicles in, or approaching, your blind spot and provides a warning, plus steering assistance to direct your vehicle back into your lane.

If you connect a supported trailer, the system reduces the function to only detect vehicles on both sides of the vehicle and trailer, extending rearward from the exterior mirrors to the end of your trailer. See **Blind Spot Information System With Trailer Coverage** (page 300).

When active, this system functions with or without the use of turn signals and hazard flashers.

You must keep your hands on the steering wheel at all times.

BLIND SPOT ASSIST WITH TRAILER COVERAGE LIMITATIONS

All system limitations present in the basic lane keeping system also apply to blind spot assist.

Blind spot assist does not function under the following conditions:

- No lane markings are detected.
- One or both rear radar sensors become blocked or faulty.
- You have not configured the attached trailer correctly in the trailer tow menus or you attached an unsupported trailer. The system only supports certain trailer shapes and dimensions.

Note: *Blind spot assist with trailer coverage could have reduced performance if any of the above limitations are present.*

Blind spot assist may have difficulty detecting hazards under the following conditions:

- If a vehicle is approaching in an adjacent lane at a relative speed much higher than your vehicle.
- Bad weather conditions are present that obstruct the sensors.
- Attaching bike or cargo racks could cause false alerts due to obstruction of the sensor.

Lane Keeping System (If Equipped)

BLIND SPOT ASSIST WITH TRAILER COVERAGE INDICATORS

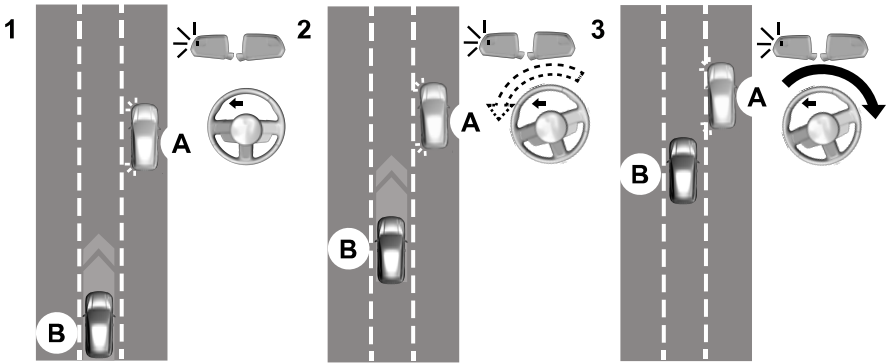

Diagram 1: Vehicle A uses its left turn signal preparing to change from the right lane to the middle lane. Vehicle B is already in the middle lane and just entered Vehicle A's blind spot causing the blind spot information system alert indicator to flash on the exterior mirror.

Diagram 2: The driver of Vehicle A begins to steer into the center lane not aware of Vehicle B.

Diagram 3: Blind spot assist counter steers to help alert the driver of Vehicle A to direct their vehicle back into the right lane to help avoid a possible collision with Vehicle B.

The lane keeping aid warning lamp or yellow lane marking in your instrument cluster display indicate blind spot assist activation. In addition, the blind spot information system alert indicator flashes on the exterior mirror on the same side as the detection. See **Blind Spot Information System** (page 299).

Blind Spot Assist Information Messages

Message	Action
Blind Spot Assist Not Available Trailer Attached	Displays if you attach a trailer to your vehicle with the blind spot information system switched off or you have not configured the trailer.
Blind Spot Assist Not Available Side Sensor Blocked	Displays if your blind spot information system sensors are blocked.
Blind Spot Assist System Fault	The system has detected a fault that requires service. Have your vehicle checked as soon as possible.

Lane Keeping System (If Equipped)

Message	Action
Trailer Brake Module Fault	Lost communication with the trailer module. Blind spot assist is disabled until the failure is fixed.
Trailer Lighting Module Fault See Manual	Lost communication with the trailer module. Blind spot assist is disabled until the failure is fixed.
Front Camera Fault Service Required	Front camera fault. Blind spot assist is disabled until the failure is fixed.

LANE KEEPING SYSTEM – TROUBLESHOOTING

LANE KEEPING SYSTEM – INFORMATION MESSAGES

Message	Action
Lane Keeping Sys. Malfunction Service Required	The system has malfunctioned. Have your vehicle checked as soon as possible.
Front Camera Temporarily Not Available	The system has detected a condition that has caused the system to be temporarily unavailable.
Front Camera Low Visibility Clean Screen	The system has detected a condition that requires you to clean the windshield in order for it to operate properly.
Front Camera Malfunction Service Required	The system has malfunctioned. Have your vehicle checked as soon as possible.
Keep Hands on Steering Wheel	The system requests that you keep your hands on the steering wheel.

Lane Keeping System (If Equipped)

LANE KEEPING SYSTEM – FREQUENTLY ASKED QUESTIONS

Why is the feature not available (lane markings are gray) when I can see the lane markings on the road?

- Your vehicle speed is less than 40 mph (65 km/h).
- The sun is shining directly into the camera lens.
- A quick intentional lane change has occurred.
- You are driving your vehicle too close to the lane markings for an extended interval of time.
- Driving at high speeds in curves.
- The last alert warning or aid intervention occurred a short time ago.
- Ambiguous lane markings, for example, in construction zones.
- Rapid transition from light to dark, or from dark to light.
- Sudden offset in lane markings.
- ABS or AdvanceTrac™ is active.
- There is a camera blockage due to dirt, grime, fog, frost or water on the windshield.
- You are driving too close to the vehicle in front of you.
- Transitioning between no lane markings to lane markings, or vice versa.
- There is standing water on the road.
- Faint lane markings, for example, partial yellow lane markings on concrete roads.
- Lane width is too narrow or too wide.

- The windshield camera was not properly calibrated after a windshield replacement.
- Driving on roads with tight curves or uneven surfaces.

Why does the vehicle not come back toward the middle of the lane, as expected, in the Aid, or Aid + Alert mode?

- High cross winds are present.
- There is a large road crown.
- Rough roads, grooves or shoulder drop-offs.
- Heavy, uneven loading of the vehicle or improper tire inflation pressure.
- The tires or suspension has been modified from what your vehicle was designed to use.

Blind Spot Information System

WHAT IS BLIND SPOT INFORMATION SYSTEM

Blind spot information system detects vehicles that may have entered the blind spot zone.

HOW DOES BLIND SPOT INFORMATION SYSTEM WORK

Blind spot information system uses sensors on both sides of your vehicle, detecting rearward from the exterior mirrors to approximately 13 ft (4 m) beyond the rear bumper. The detection area extends to approximately 59 ft (18 m) beyond the rear bumper when the vehicle speed is greater than 30 mph (48 km/h) to alert you of faster approaching vehicles.

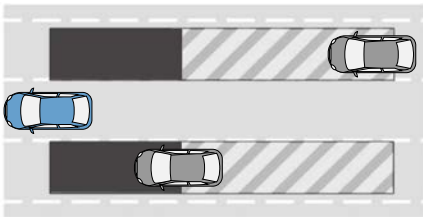

BLIND SPOT INFORMATION SYSTEM PRECAUTIONS



WARNING: Do not use the blind spot information system as a replacement for using the interior and exterior mirrors or looking over your shoulder before changing lanes. The blind spot information system is not a replacement for careful driving.



WARNING: The system may not operate properly during severe weather conditions, for example snow, ice, heavy rain and spray. Always drive with due care and attention. Failure to take care may result in a crash.

Note: *Blind spot information system does not prevent contact with other vehicles. It does not detect parked vehicles, pedestrians, animals or other infrastructure.*

BLIND SPOT INFORMATION SYSTEM LIMITATIONS

Blind spot information system does not operate in park (P) or reverse (R).

The system may not alert you if a vehicle quickly passes through the detection zone while overtaking.

Note: *For vehicles without the trailer coverage feature, we recommend that you switch the blind spot information system off when you attach a trailer.*

BLIND SPOT INFORMATION SYSTEM REQUIREMENTS

Blind spot information system turns on when all the following occur:

- You start your vehicle.
- You shift into drive (D).
- The vehicle speed is greater than 6 mph (10 km/h).

Blind Spot Information System

SWITCHING BLIND SPOT INFORMATION SYSTEM ON AND OFF

1. From the driver assistance menu, press Blind Spot Information System. See **Driver Assistance Menu** (page 469).
2. Switch Blind Spot Information System on or off.

When you switch blind spot information system off, a warning lamp illuminates. When you switch the system on or off, the alert indicators flash twice. A telltale remains illuminated in the instrument cluster when the blind spot information system is switched off in the settings menu.

Note: The system remembers the last setting when you start your vehicle.

LOCATING THE BLIND SPOT INFORMATION SYSTEM SENSORS

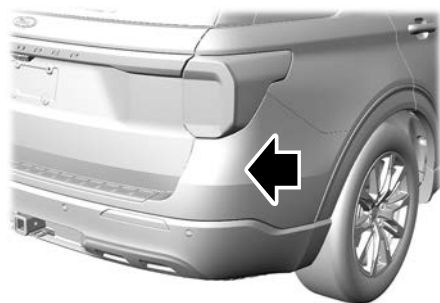

The sensors are behind the rear bumper on both sides of your vehicle.

Note: Keep the sensors free from snow, ice and large accumulations of dirt.

Note: Do not cover the sensors with bumper stickers, repair compound or other objects.

Note: Bike and cargo racks could cause false alerts due to obstruction of the sensor. Switch the feature off when using a bike or cargo rack.

Note: Blocked sensors may affect system accuracy.

If the sensors become blocked, a message appears in the instrument cluster display. See **Blind Spot Information System – Information Messages** (page 303). The alert indicators illuminate but the system does not alert you.

BLIND SPOT INFORMATION SYSTEM WITH TRAILER COVERAGE

WHAT IS BLIND SPOT INFORMATION SYSTEM WITH TRAILER COVERAGE

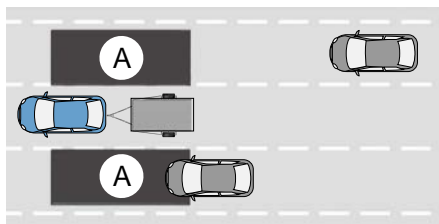

A. Trailer coverage detection zone.

Blind spot information system detects vehicles that may have entered the blind spot zone. The detection area is on both sides your vehicle and trailer, extending rearward from the exterior mirrors to the end of your trailer.

Blind Spot Information System

BLIND SPOT INFORMATION SYSTEM WITH TRAILER COVERAGE LIMITATIONS

Trailer coverage only supports conventional trailers. The system turns off if you select a fifth wheel or gooseneck trailer type.

Make sure the trailer width is less than or equal to 8 ft (2.4 m) and the length is less than 33 ft (10.1 m). If you input values higher, the system turns off.

Some trailers could cause a slight change in system performance:

- Large box trailers could cause false alerts to occur when driving next to infrastructures or near parked cars. A false alert could also occur while making a 90-degree turn.
- Trailers that have a width greater than 8 ft (2.4 m) at the front and have a total length greater than 20 ft (6 m) could cause delayed alerts when a vehicle is passing at high speeds.
- Box trailers that have a width greater than 8 ft (2.4 m) at the front could cause early alerts when you pass a vehicle.
- Clamshell or V-nose box trailers with a width greater than 8 ft (2.4 m) at the front could cause delayed alerts when a vehicle traveling the same speed as your vehicle merges lanes.

SETTING A TRAILER LENGTH

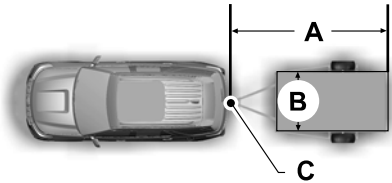

- A Trailer length.
- B Trailer width.
- C Trailer hitch ball.

You can set up a trailer to work with the blind spot information system through the touchscreen by using the add trailer menu.

1. Input the trailer name, then save to continue trailer setup.

Note: *The system only supports conventional trailers.*

2. Trailer length measurement. The trailer length is the distance between the trailer hitch ball and the rear of the trailer. The maximum length the system can support is 33 ft (10.1 m).
3. Trailer width measurement. Measure the width at the front of the trailer. It is not measured at the widest point of the trailer. The maximum width at the front of the trailer the system can support is 8 ft (2.4 m).

Note: *If the trailer is a bike rack or cargo rack with electrical lighting, enter a length of around 3 ft (1 m). Cross traffic alert remains on for trailers with a length of 3 ft (1 m) or less.*

Note: *The system requires proper measurement and measure entry to properly function.*

Blind Spot Information System

SELECTING A TRAILER

When you connect a trailer to your vehicle, the trailer set up menu appears in the touchscreen. This menu allows you to set up a new trailer or choose from a previously set up trailer. A warning message appears and the system turns off if you do not choose or add a new trailer.

Note: *The warning message may not appear until your vehicle reaches 22 mph (35 km/h).*

BLIND SPOT INFORMATION SYSTEM INDICATORS



When blind spot information system detects a vehicle, an alert indicator illuminates in the exterior mirror on the side from which the vehicle is approaching. If you turn the turn signal on for that side of your vehicle, the alert indicator flashes.

Blind Spot Information System

BLIND SPOT INFORMATION SYSTEM – TROUBLESHOOTING

BLIND SPOT INFORMATION SYSTEM – INFORMATION MESSAGES

Message	Action
Blind Spot System fault	A fault with the system has occurred. Have your vehicle checked as soon as possible.
Blind Spot not available Sensor blocked See manual	Something is blocking the sensors. Clean the sensors.
Blind Spot Alert deactivated Trailer attached	The system automatically turns off and displays this message when you connect a trailer to your vehicle under any of the following conditions: <ul style="list-style-type: none">- Your vehicle does not have blind spot information system with trailer coverage.- You switch the blind spot information system off through the touchscreen.- Your trailer exceeds the limits for the system. See Setting a Trailer Length (page 301). Only appears if your vehicle has blind spot information system with trailer coverage.

Note: *When connecting a trailer, the system may detect the trailer and turn the system OFF. If the system does not automatically turn OFF, manually switch the blind spot information system OFF. If your vehicle has the blind spot information system with trailer coverage, the system prompts you to set up a trailer that allows the feature to function, if your trailer meets the requirements of the system.*

Exit Warning

WHAT IS EXIT WARNING

Exit warning provides a visual and audible alert when a vehicle occupant opens a door into approaching traffic. It uses radar sensors to alert you to traffic objects.

HOW DOES EXIT WARNING WORK

Exit warning detects traffic objects such as vehicles, cyclists, scooters and motorcycles that approach your vehicle from the rear and cross into the exit warning zone. The exit warning zones are along the left and right sides of your vehicle and extend slightly past a fully open door. The exit warning system becomes active once you have started your vehicle and the vehicle is not moving. Exit warning operates in any gear position.

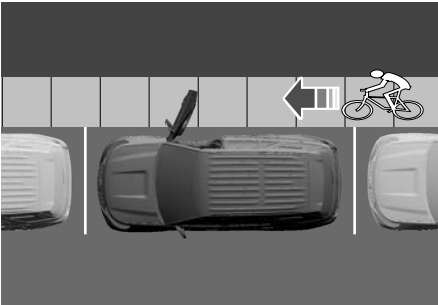

Note: The system cannot detect animals, slow moving pedestrians or any type of stationary object.

EXIT WARNING PRECAUTIONS



WARNING: The system is not a crash warning or avoidance system.



WARNING: Always pay attention to the traffic situation and the area around the vehicle.



WARNING: In cold and severe weather conditions the system may not function. Rain, snow and spray can all limit sensor performance.



WARNING: If damage occurs in the immediate area surrounding the sensor, have your vehicle checked as soon as possible.



WARNING: You are responsible for controlling your vehicle at all times. The system is designed to be an aid and does not relieve you of your responsibility to drive, stop and park with due care and attention. Failure to follow this instruction could result in the loss of control of your vehicle, personal injury or death.



WARNING: Exit Warning may not detect objects with surfaces that absorb reflection. Always open doors with due care and attention. Failure to follow this instruction may result in personal injury or property damage.

EXIT WARNING LIMITATIONS

The exit warning system is operational in any gear position once you start your vehicle and anytime the vehicle is not moving. The exit warning system remains on for about 3 minutes after turning your vehicle off. The system immediately turns off when locking the doors. Exit warning informs you when it turns off.

Note: Do not use exit warning as a replacement for paying attention when exiting your vehicle.

Exit Warning

Note: The system does not prevent contact with other vehicles by automatically closing the doors.

Note: The system may not inform and/or alert you if a traffic object is approaching too quickly or if the parking position prevents detection.

Exit Warning Alert

Note: Exit warning is designed to provide a visual alert during an exit when an occupant opens any door and a traffic object is approaching on the same side.

EXIT WARNING INDICATORS



When exit warning detects an approaching traffic object on one side, the corresponding alert indicator in the exterior mirror illuminates. If you activate additional exit warning alerts, the same alert indicator flashes. See **Blind Spot Information System Indicators** (page 302).

In addition to the mirror indicator there is also visual indication in the information display noting on which side a traffic object has been detected.

SWITCHING EXIT WARNING ON AND OFF

1. From the driver assistance menu, press Exit Warning. See **Driver Assistance Menu** (page 469).
2. Switch the feature on or off.

Note: The system remembers the last setting when you start your vehicle.

LOCATING THE EXIT WARNING SENSORS

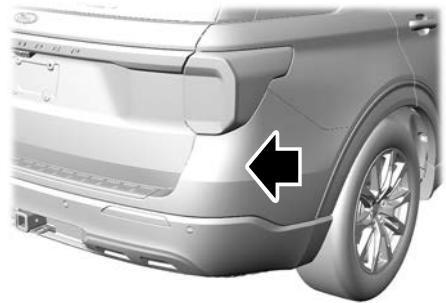

The sensors for exit warning are mounted behind the rear bumper on both sides of your vehicle.

Note: Keep the sensors free from snow, ice and large accumulations of dirt.

Note: Do not cover the sensors with bumper stickers, repair compound or other objects.

Note: Blocked sensors may affect system accuracy.

Note: The system may not correctly operate when towing a trailer or bike rack.

Exit Warning

EXIT WARNING – TROUBLESHOOTING

EXIT WARNING – INFORMATION MESSAGES

Message	Reason
Left/Right Side Check surroundings before exiting	Left/Right exit warning alert or exit warning prevention is active.
Exit Warning turning off. Exit safely	Displays when the exit warning system turns off or shuts down.
Exit Warning System Fault	Displays when the exit warning system detects any system error.

If exit warning detects a fault, the system deactivates and a **System Fault** message appears in the instrument cluster display.

Cross Traffic Alert

WHAT IS CROSS TRAFFIC ALERT

The system is designed to alert you of road users and traffic objects approaching from the rear sides and from behind your vehicle when you shift into reverse (R).

If you continue to reverse at a speed equal or higher than 1 mph (2 km/h) after the system alerts you, the system is designed to apply the brakes if it still detects approaching road users or traffic objects. If the system applies the brakes, a message appears in the instrument cluster display.

Note: *There could be instances when unexpected or unwanted braking occurs. You can override this by firmly pressing the accelerator pedal.*

HOW DOES CROSS TRAFFIC ALERT WORK

Cross Traffic Alert is designed to detect road users or traffic objects approaching above a minimum speed of 5 mph (8 km/h). Coverage can decrease when the sensors are partially, mostly or fully obstructed.

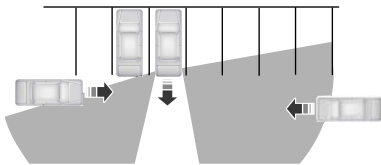

The sensor on the left-hand side is only partially obstructed and zone coverage on the right-hand side is maximized.

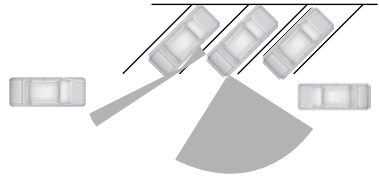

Zone coverage also decreases when parking at narrow angles. The sensor on the left-hand side is mostly obstructed and zone coverage on that side is severely reduced.

Note: *Slowly reversing helps increase the coverage area and effectiveness.*

The system only applies the brakes for a short period of time when an event occurs. Take action as soon as you notice the system applying the brakes in order to remain in control of your vehicle, the system does not do this for you.

CROSS TRAFFIC ALERT PRECAUTIONS

WARNING: You are responsible for controlling your vehicle at all times. The system is designed to be an aid and does not relieve you of your responsibility to drive with due care and attention. Failure to follow this instruction could result in the loss of control of your vehicle, personal injury or death.

WARNING: If damage occurs in the immediate area surrounding the sensor, have your vehicle checked as soon as possible.

Cross Traffic Alert

 **WARNING:** To help avoid personal injury, always use caution when in reverse (R) and when using the sensing system.

 **WARNING:** The system may not operate properly during severe weather conditions, for example snow, ice, heavy rain and spray. Always drive with due care and attention. Failure to take care may result in a crash.

 **WARNING:** The system may not detect objects with surfaces that absorb reflection. Always drive with due care and attention. Failure to take care may result in a crash.

 **WARNING:** Traffic control systems, fluorescent lamps, inclement weather, air brakes, external motors and fans may affect the correct operation of the sensing system. This may cause reduced performance or false alerts.

 **WARNING:** Some situations and objects prevent hazard detection, for example, inclement weather, unconventional vehicle types and pedestrians. Apply the brakes when necessary. Failure to follow this instruction could result in the loss of control of your vehicle, personal injury or death.

 **WARNING:** Do not use the system with accessories that extend beyond the front or rear of your vehicle, for example a trailer hitch or bike rack. The system is not able to make corrections for the additional length of the accessories.

 **WARNING:** Do not use the cross traffic alert system as a replacement for using the interior and exterior mirrors or looking over your shoulder before reversing out of a parking space. The cross traffic alert system is not a replacement for careful driving.

Note: *Certain add-on devices around the bumper or fascia may cause unexpected system behavior. For example, large trailer hitches, bicycle or surfboard racks, license plate brackets, fuel containers, bumper covers or any other device may block the normal detection zone of the system. Remove the add-on device to prevent unexpected system behavior.*

Note: *If your vehicle sustains damage to the bumper or fascia leaving it misaligned or bent, it could alter the sensing zone causing inaccurate measurement of obstacles or false alerts.*

Note: *Vehicle loading and suspension changes can impact the angle of the sensors and may change the normal detection zone of the system resulting in inaccurate measurement of obstacles or false alerts.*

Note: *You may experience reduced system performance on road surfaces that limit deceleration. For example, roads with ice, loose gravel, mud or sand.*

CROSS TRAFFIC ALERT LIMITATIONS

The system may not correctly operate when any of the following occur:

- Something is blocking the sensors.
- Adjacently parked vehicles or objects are obstructing the sensors.
- Traffic objects approach at speeds less than 5 mph (8 km/h) or greater than 37 mph (60 km/h).

Cross Traffic Alert

- Your vehicle speed is greater than 7 mph (12 km/h).
- You reverse out of an angled parking space.

Note: The system does not alert for small stationary and moving objects.

Cross Traffic Alert Limitations with a Trailer Attached

The system remains on when you attach a trailer to vehicles with blind spot information system with trailer coverage under the following conditions:

- You connect a bike rack or cargo rack with a maximum length of 3 ft (1 m).
- You set the trailer length to 3 ft (1 m) in the touchscreen.

Note: The system may not correctly operate when towing a trailer. For vehicles with an approved trailer tow module and tow bar, the system turns off when you attach a trailer greater than 3 ft (1 m). For vehicles with an aftermarket trailer tow module or tow bar, we recommend that you switch the system off when you attach a trailer.

SWITCHING CROSS TRAFFIC ALERT ON AND OFF

1. From the driver assistance menu, press Cross Traffic Alert. See **Driver Assistance Menu** (page 469).
2. Switch Cross Traffic Alert on or off.

When you switch the system on or off, the alert indicators flash twice.

Note: The system switches on every time you switch the ignition on.

Switching Cross Traffic Braking On and Off

1. From the driver assistance menu, press Cross Traffic Braking. See **Driver Assistance Menu** (page 469).

2. Switch Cross Traffic Braking on and off.

Note: The system remembers the last setting when you start your vehicle.

Note: If your vehicle does not have a cross traffic braking menu item, this functionality is included in reverse brake assist. See **Reverse Brake Assist** (page 235).

LOCATING THE CROSS TRAFFIC ALERT SENSORS

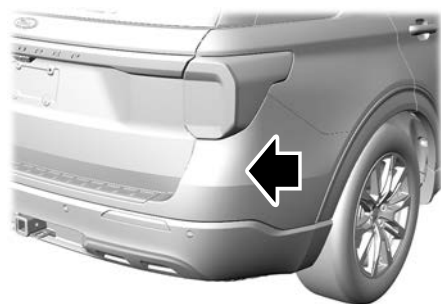

The sensors are behind the rear bumper on both sides of your vehicle.

Note: Keep the sensors free from snow, ice and large accumulations of dirt.

Note: Do not cover the sensors with bumper stickers, repair compound or other objects.

Note: Blocked sensors may affect system accuracy.

If something is blocking the sensors, a message may appear in the instrument cluster display when you shift into reverse (R).

Note: Bike and cargo racks could cause false alerts due to obstruction of the sensor. Switch the feature off when using a bike or cargo rack.

Cross Traffic Alert

CROSS TRAFFIC ALERT INDICATORS

When the system detects an approaching vehicle, a tone sounds, a pop-up message appears in the instrument cluster display, an alert indicator illuminates in the relevant exterior mirror and arrows appear in the touchscreen to show from which side the

vehicle is approaching.

If the system malfunctions, a message appears. Have your vehicle checked as soon as possible.

Note: *In exceptional conditions, the system could alert you or apply the brakes, even when there is nothing in the detection zone, for example a vehicle passing further away from your vehicle.*

CROSS TRAFFIC ALERT – TROUBLESHOOTING

CROSS TRAFFIC ALERT – INFORMATION MESSAGES

Message	Details
Cross Traffic Alert	Displays when the system detects a vehicle. Check for approaching traffic.
Cross Traffic Not Available Sensor Blocked See Manual	Displays if the cross traffic alert system sensors are blocked. Clean the sensors. If the message continues to appear, have your vehicle checked as soon as possible.
Cross Traffic System Fault	The system has malfunctioned. Have your vehicle checked as soon as possible.
Cross Traffic Alert Deactivated Trailer Attached	Displays if you attach a trailer to your vehicle.
Cross Traffic Alert Applying Brakes	Displays if the system applies the brakes. Check for approaching traffic.

Note: *If your vehicle has reverse brake assist See **Reverse Brake Assist – Information Messages** (page 237).*

Pre-Collision Assist

WHAT IS PRE-COLLISION ASSIST

Pre-collision assist detects and warns of approaching hazards in the roadway. The system provides multiple levels of assistance to help avoid a collision if your vehicle is rapidly approaching another stationary vehicle, a vehicle traveling in the same direction as yours, or a pedestrian or cyclist within your driving path.

HOW DOES PRE-COLLISION ASSIST WORK

The system warns the driver of potential hazards by providing three levels of assistance.

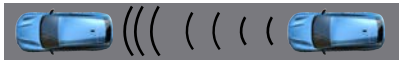

If your vehicle is rapidly approaching potential hazards the system provides the following levels of functionality:

1. Alert.
2. Brake support.
3. Automatic emergency braking.



Alert: When active, a flashing visual warning appears and an audible warning tone sounds.

Brake Support: The system helps reduce the impact speed by preparing the brakes for rapid braking. The system does not automatically apply the brakes. If you press the brake pedal, the system may apply additional braking up to maximum braking force, even if you lightly press the brake pedal.

Automatic Emergency Braking: Automatic emergency braking may activate if the system determines that a collision is imminent.

Note: If the pre-collision assist alerts are too frequent or disturbing, you can reduce the alert sensitivity. Setting the low sensitivity results in fewer and later warnings of a potential forward collision. The manufacturer recommends using the high sensitivity setting where possible.

Note: Automatic emergency braking performance is not affected by the sensitivity setting.

Each system has various levels of detection capabilities. See **Pre-Collision Assist Limitations** (page 312).

PRE-COLLISION ASSIST PRECAUTIONS



WARNING: You are responsible for controlling your vehicle at all times. The system is designed to be an aid and does not relieve you of your responsibility to drive with due care and attention. Failure to follow this instruction could result in the loss of control of your vehicle, personal injury or death.





WARNING: The system only provides limited braking. Your vehicle may not always decelerate quickly enough to avoid a crash without driver intervention. Apply the brakes when necessary.





WARNING: The system does not operate during hard acceleration or steering. Failure to take care may lead to a crash or personal injury.

Pre-Collision Assist

 **WARNING:** The system may operate with reduced function during cold and inclement weather conditions. Snow, ice, rain, spray and fog can adversely affect the system. Keep the front camera and radar free of snow and ice. Failure to follow this instruction may result in the loss of control of your vehicle, serious personal injury or death.

 **WARNING:** The system may not function properly if your vehicle is fitted with a replacement windshield not approved by us.

 **WARNING:** Do not perform windshield repairs around the rear-view mirror. Failure to follow this instruction could limit sensor performance.

 **WARNING:** System performance could be reduced in situations where the vehicle camera has limited detection capability. These situations include but are not limited to direct or low sunlight, vehicles at night without tail lights, unconventional vehicle types, pedestrians or cyclists with complex backgrounds, running pedestrians or fast moving cyclists, partly obscured pedestrians or cyclists, pedestrians or cyclists that the system cannot distinguish from a group. Failure to take care may result in the loss of control of your vehicle, personal injury or death.

 **WARNING:** The system cannot help prevent all crashes. Do not rely on this system to replace driver judgment and the need to maintain a safe distance and speed.

 **WARNING:** Take additional care if your vehicle is heavily loaded or you are towing a trailer. These conditions could result in reduced performance of this system. Failure to follow this instruction could result in the loss of control of your vehicle, personal injury or death.

Note: *Automatic emergency braking may activate when a collision is imminent. The system cannot prevent all crashes, but may reduce crash severity. Do not test automatic emergency braking or forward collision warning. Testing this system must only be conducted by authorized test facilities using specialized equipment. Do not use automatic emergency braking to replace normal braking for any reason. Relying on automatic emergency braking to stop your vehicle may cause an unexpected accident which could lead to serious injury or death.*

Note: *The system does not detect animals.*

PRE-COLLISION ASSIST LIMITATIONS

Pre-collision assist depends on the detection ability of its camera and sensors. Any obstructions or damage to these areas can limit detection or prevent the system from functioning. See **Locating the Pre-Collision Assist Sensors** (page 314).

The system is active at 3 mph (5 km/h) and above.

Note: *The pre-collision assist system automatically disables if your vehicle has the following drive modes and you select four-wheel drive low or manually disable AdvanceTrac™.*

Note: *Brake support and automatic emergency braking can detect other vehicles up to the maximum speed of your vehicle.*

Pre-Collision Assist

Pedestrian Detection Limitations

Pedestrian detection is active at speeds up to 50 mph (80 km/h).

Pedestrian detection operates optimally when detected hazards are clearly identifiable. The system can have reduced performance in situations where pedestrians are running, partly obscured, have a complex background, or when the system cannot distinguish them from a group.

Cyclist Detection Limitations

Cyclist detection is active at speeds up to 50 mph (80 km/h).

Cyclist detection functions optimally when detected hazards are clearly identifiable. The system can have reduced performance in situations where cyclists are fast-moving, partly obscured, have a complex background, or where the system cannot distinguish them from a group.

Intersection Assist

The system operates when you turn across the path of an oncoming vehicle, or a pedestrian or cyclist crossing the road. Detection of oncoming vehicles is active if you are driving your vehicle at speeds up to 19 mph (30 km/h). Detection of crossing pedestrians or cyclists at an intersection is active if you are driving your vehicle at speeds up to 19 mph (30 km/h). The system also operates when you approach the path of a crossing vehicle. Detection of crossing vehicles is active if you are driving your vehicle at speeds up to 40 mph (65 km/h).

Note: *In the following intersection scenarios, your vehicle is represented in yellow.*

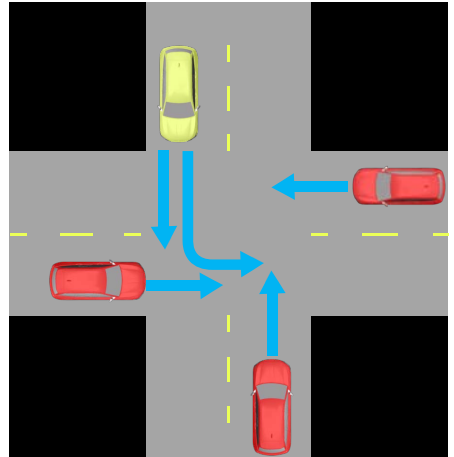

The previous image shows potential intersection scenarios from the perspective of the yellow vehicle. The system may detect the red vehicles if you encounter them within the appropriate detection range.

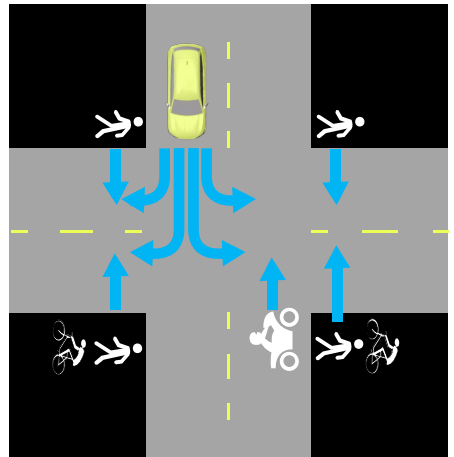

Pre-Collision Assist

The previous image shows potential motorcycle, bicycle, and pedestrian intersection scenarios from the perspective of the yellow vehicle. The system may detect these threats if you encounter them within the appropriate detection speed.

Pre-Collision Assist - Oncoming Vehicles

This feature expands the function of pre-collision assist to oncoming vehicles within your same lane. The system can help to reduce the severity of a crash by providing a warning to you as well as automatically applying the brakes. Detection of oncoming vehicles is active if you are driving your vehicle above 19 mph (30 km/h).

SWITCHING PRE-COLLISION ASSIST ON AND OFF - EXCLUDING: POLICE

You cannot switch the system off.

Adjusting the Pre-Collision Assist Settings

You can adjust the following settings by using the touchscreen controls in the pre-collision assist menu:

- Change alert sensitivity to one of three possible settings.
- If required, switch automatic emergency braking on or off.
- If required, switch evasive steering assist on or off.

Note: Automatic emergency braking and evasive steering assist automatically turn on every time you start your vehicle.

Note: If you switch automatic emergency braking off, evasive steering assist switches off.

SWITCHING PRE-COLLISION ASSIST ON AND OFF - POLICE

You can switch the entire system off at any time by pressing the button next to the display screen.

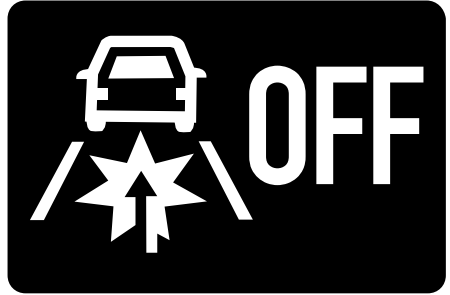

LOCATING THE PRE-COLLISION ASSIST SENSORS

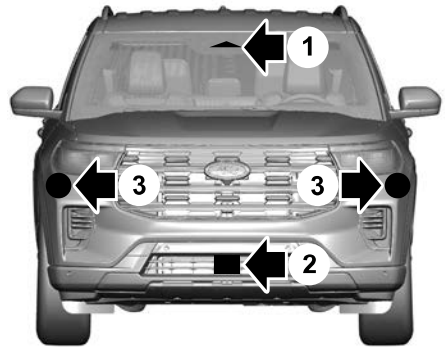

1. Camera.
2. Radar sensor (if equipped).
3. Corner radar (if equipped).

Pre-Collision Assist

If a message regarding a blocked sensor or camera appears in the instrument cluster display, something is obstructing the radar or front windshield camera. The radar sensor is behind the bumper in the center of the lower grille. With a blocked sensor or camera, the system may not function, or performance may reduce. See **Pre-Collision Assist – Information Messages** (page 316).

Note: *Proper system operation requires a clear view of the road by the camera. Have any windshield damage in the area of the camera's field of view repaired.*

Note: *If something hits the front end of your vehicle or damage occurs and your vehicle has a radar sensor, the radar sensing zone could change. This could cause missed or false vehicle detections. Have your vehicle serviced to have the radar checked for proper coverage and operation.*

Note: *If your vehicle detects excessive heat at the camera or a potential misalignment condition, a message could display in the instrument cluster display indicating temporary sensor unavailability. When operational conditions are correct, the message deactivates. For example, when the ambient temperature around the sensor decreases or the sensor successfully recalibrates.*

AUTOMATIC EMERGENCY BRAKING

WHAT IS AUTOMATIC EMERGENCY BRAKING

Automatic emergency braking may activate if the system determines that a collision is imminent. The system may help to reduce impact damage or completely avoid the crash.

SWITCHING AUTOMATIC EMERGENCY BRAKING ON AND OFF

1. From the Driver Assistance menu, press Pre-Collision Assist. See **Driver Assistance Menu** (page 469).
2. Press Auto Emergency Braking.
3. Switch the feature on or off.

Note: *A telltale remains illuminated in the instrument cluster when automatic emergency braking is switched off using the settings menu.*

Note: *Automatic emergency braking turns on each time you switch the ignition on.*

Note: *If you turn automatic emergency braking off, evasive steering assist also turns off.*

EVASIVE STEERING ASSIST

WHAT IS EVASIVE STEERING ASSIST

If your vehicle is rapidly approaching a road user, evasive steering assist helps you steer around the road user.

After you turn the steering wheel in an attempt to avoid a crash with the road user, the system applies additional steering torque to help you steer around the road user. After you pass the road user, the system applies steering torque when you turn the steering wheel to steer back into the lane. The system deactivates after you fully pass the road user.

Note: *Road users are defined as pedestrians or bicyclists in your vehicle's path or another stationary vehicle in the same lane or a vehicle traveling in the same lane in the same direction as you. See **Pre-Collision Assist Precautions** (page 311).*

Pre-Collision Assist

EVASIVE STEERING ASSIST LIMITATIONS

Evasive steering assist only activates when all the following occur:

- Automatic emergency braking and evasive steering assist are on.
- The system detects a road user ahead and starts to apply the brakes.
- You significantly turn the steering wheel to steer around a road user.

Note: Evasive steering assist does not automatically steer around a road user. If you do not turn the steering wheel, evasive steering assist does not activate.

Note: Evasive steering assist does not activate if the distance to the road user ahead is too small and the system cannot avoid a crash.

SWITCHING EVASIVE STEERING ASSIST ON AND OFF

1. From Driver Assistance menu, press Pre-Collision Assist. See **Driver Assistance Menu** (page 469).
2. Press Evasive Steering Assist.

3. Switch the feature on or off.

Note: If you switch automatic emergency braking off, evasive steering assist turns off.

Note: Automatic emergency braking and evasive steering assist turn on every time you start your vehicle.

PRE-COLLISION ASSIST – TROUBLESHOOTING

PRE-COLLISION ASSIST – WARNING LAMPS



A telltale illuminates in the instrument cluster display to indicate if the system is disabled, unavailable, or temporarily degraded due to external environmental conditions.

Note: If the telltale illuminates without a corresponding information message, make sure the setting for automatic emergency braking is switched on. See **Switching Automatic Emergency Braking On and Off** (page 315). No action is needed unless an information message appears. See **Pre-Collision Assist Precautions** (page 311).

PRE-COLLISION ASSIST – INFORMATION MESSAGES

Message	Details
Pre-Collision Assist not available Sensor blocked	You have a blocked sensor due to bad weather, ice, mud or water in front of the radar sensor. You can typically clean the sensor to resolve.
Pre-Collision Assist not available	A fault with the system has occurred. Have your vehicle checked as soon as possible.

Pre-Collision Assist

PRE-COLLISION ASSIST – FREQUENTLY ASKED QUESTIONS

Camera Troubleshooting

What should I do if the windshield in front of the camera is dirty or obstructed?

- Clean the outside of the windshield in front of the camera.

What if the windshield in front of the camera is clean, but the message remains in the instrument cluster display?

- Wait a short time. It could take several minutes for the camera to detect that there is no obstruction.

Radar Troubleshooting (If Equipped)

What should I do if the surface of the radar in the grille is dirty or obstructed?

- Clean the grille surface in front of the radar or remove the object causing the obstruction.

What if the surface of the radar in the grille is clean, but the message remains in the instrument cluster display?

- Wait a short time. It could take several minutes for the radar to detect that there is no obstruction.

Can weather or road conditions interfere with the radar signals?

- Yes, weather such as heavy rain, spray or fog as well as water, snow or ice on the surface of the road can interfere with the radar signals. In these situations, the system temporarily disables this feature. Pre-collision assist reactivates a short time after the weather conditions improve.

What if the radar is out of alignment due to a front end impact?

- Have your vehicle serviced to have the radar checked for proper coverage and operation.

Speed Sign Recognition (If Equipped)

WHAT IS SPEED SIGN RECOGNITION

Speed sign recognition detects speed limit signs to inform you of the current speed limit. Detected speed signs appear in the instrument cluster display.

HOW DOES SPEED SIGN RECOGNITION WORK

Speed sign recognition uses the front windshield camera to detect speed signs.

If your vehicle has speed sign recognition with Map Data, stored speed sign data may influence the indicated speed limit value.

SPEED SIGN RECOGNITION PRECAUTIONS

 **WARNING:** You are responsible for controlling your vehicle at all times. The system is designed to be an aid and does not relieve you of your responsibility to drive with due care and attention. Failure to follow this instruction could result in the loss of control of your vehicle, personal injury or death.

 **WARNING:** In cold and severe weather conditions the system may not function. Rain, snow and spray can all limit sensor performance.

 **WARNING:** The system may not operate properly if the sensor is blocked. Keep the windshield free from obstruction.

 **WARNING:** Do not perform windshield repairs around the rear-view mirror. Failure to follow this instruction could limit sensor performance.

 **WARNING:** The system may not function properly if your vehicle is fitted with a replacement windshield not approved by us.

 **WARNING:** The system may not correctly operate if your vehicle is fitted with a suspension kit not approved by Ford.

 **WARNING:** Not all traffic signs can be recognized by the system and displayed correctly.

Note: Use original parts when replacing headlamp bulbs. Other bulbs may reduce system performance.

SPEED SIGN RECOGNITION LIMITATIONS

Speed sign recognition may not detect the correct speed due to:

- Construction zones.
- Outdated map data.
- Incorrect recognition of speed limits by the sensor of signs on parallel roads or exit ramps.
- Missed recognition of faded, dirty, or distorted signs.

Note: The system may not detect all speed signs and may incorrectly read signs.

Speed Sign Recognition (If Equipped)

SPEED SIGN RECOGNITION INDICATORS



When the system detects a speed limit sign, it appears in the instrument cluster display.

Note: Sign indicator image may vary based on your vehicle's display type.

SPEED SIGN RECOGNITION SETTINGS

From the driver assistance menu, press Speed Limit Assist. See **Driver Assistance Menu** (page 469).

You can adjust the following settings:

- Switch the speed warning on or off.
- Set the speed limit tolerance (if equipped).



If you see this icon next to a menu option, press it for more information.

SPEED SIGN RECOGNITION – TROUBLESHOOTING

SPEED SIGN RECOGNITION – FREQUENTLY ASKED QUESTIONS

Why does the speed limit change without any sign on the road?

- The speed limit changes due to the speed limit data stored in the map data.

Why does speed sign recognition show a wrong speed limit?

- The system shows a wrong speed limit due to incorrect and outdated map data or due to incorrect recognition of the speed limits by the camera.

Driver Alert (If Equipped)

WHAT IS DRIVER ALERT

Driver alert alerts you if it determines that you are becoming drowsy or if your driving deteriorates.

HOW DOES DRIVER ALERT WORK

Driver alert determines your alertness level based on your driving behavior in relation to the lane markings and other factors using the front windshield camera.

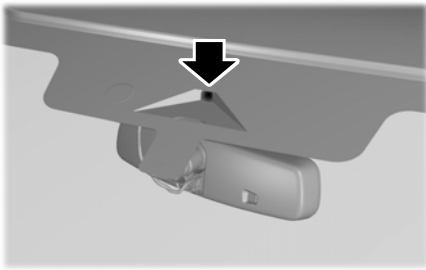

DRIVER ALERT PRECAUTIONS

WARNING: You are responsible for controlling your vehicle at all times. The system is designed to be an aid and does not relieve you of your responsibility to drive with due care and attention. Failure to follow this instruction could result in the loss of control of your vehicle, personal injury or death.

WARNING: Take regular rest breaks if you feel tired. Do not wait for the system to warn you.

WARNING: Certain driving styles may result in the system warning you even if you are not feeling tired.

WARNING: In cold and severe weather conditions the system may not function. Rain, snow and spray can all limit sensor performance.

WARNING: The system will not operate if the sensor cannot track the road lane markings.

WARNING: If damage occurs in the immediate area surrounding the sensor, have your vehicle checked as soon as possible.

WARNING: The system may not correctly operate if your vehicle is fitted with a suspension kit not approved by us.

WARNING: The system may not operate properly if the sensor is blocked. Keep the windshield free from obstruction.

WARNING: The system may not function properly if your vehicle is fitted with a replacement windshield not approved by us.

Note: If something is blocking the camera or damaged the windshield, Driver Alert may not function.

DRIVER ALERT LIMITATIONS

Driver alert may not function correctly if:

- The sensor cannot track the road lane markings.
- Your vehicle's speed is less than the required activation speed.

Driver Alert (If Equipped)

SWITCHING DRIVER ALERT ON AND OFF

1. From the driver assistance menu, press Driver Alert. See **Driver Assistance Menu** (page 469).
2. Switch the feature on or off.

DRIVER ALERT – TROUBLESHOOTING

DRIVER ALERT – INFORMATION MESSAGES

Message	Details
Driver Alert Rest now	Stop and rest as soon as it is safe to do so.
Driver Alert Rest suggested	Take a rest soon.

Load Carrying

LOAD CARRYING PRECAUTIONS

Keep your loaded vehicle weight within its design rating capability, with or without a trailer. Properly loading your vehicle provides maximum return of vehicle design performance. Before you load your vehicle, become familiar with the following terms for determining your vehicle's weight rating, with or without a trailer, from the vehicle's Tire and Loading Information label or Safety Compliance Certification label.



WARNING: The appropriate loading capacity of your vehicle can be limited either by volume capacity (how much space is available) or by payload capacity (how much weight the vehicle should carry). Once you have reached the maximum payload of your vehicle, do not add more cargo, even if there is space available. Overloading or improperly loading your vehicle can contribute to loss of vehicle control and vehicle rollover.



WARNING: Exceeding the Safety Compliance Certification label vehicle weight limits can adversely affect the performance and handling of your vehicle, cause vehicle damage and can result in the loss of control of your vehicle, serious personal injury or death.



WARNING: Do not use replacement tires with lower load carrying capacities than the original tires because they may lower your vehicle's Gross Vehicle Weight Rating and Gross Axle Weight Rating limitations. Replacement tires with a higher limit than the original tires do not increase the Gross Vehicle Weight Rating and Gross Axle Weight Rating limitations.



WARNING: Do not exceed the GVWR or the GAWR specified on the certification label.



WARNING: Exceeding any vehicle weight rating can adversely affect the performance and handling of your vehicle, cause vehicle damage and can result in the loss of control of your vehicle, serious personal injury or death.

Load Carrying



WARNING: When loading the roof racks, we recommend you evenly distribute the load, as well as maintain a low center of gravity. Loaded vehicles, with higher centers of gravity, may handle differently than unloaded vehicles. Take extra precautions, such as slower speeds and increased stopping distance, when driving a heavily loaded vehicle.

Load carrying can also impact other systems present in your vehicle. See **Lane Centering Precautions** (page 271). See **BlueCruise Precautions** (page 279). See **Adaptive Cruise Control Precautions** (page 264).

The gross combined weight must never exceed the Gross Combined Weight Rating.

LOCATING THE SAFETY COMPLIANCE CERTIFICATION LABELS

Safety Compliance Certification Label Example:

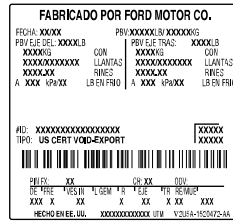
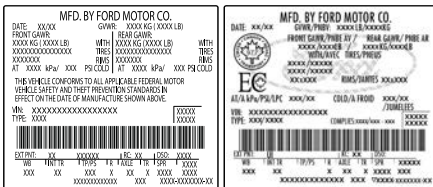

The Safety Compliance Certification label is located on the door pillar, door latch post, or the door edge that meets the door latch post, next to the driver seat.

WHAT IS THE GROSS AXLE WEIGHT RATING

GAWR (Gross Axle Weight Rating)

GAWR is the maximum allowable weight that a single axle (front or rear) can carry. These numbers are on the Safety Compliance Certification label.

WHAT IS THE GROSS VEHICLE WEIGHT RATING

GVWR is the maximum allowable weight of the fully loaded vehicle. This includes all options, equipment, passengers and cargo. It appears on the Safety Compliance Certification label.

Load Carrying

WHAT IS THE GROSS COMBINED WEIGHT RATING

Gross Combined Weight Rating (GCWR) is the maximum allowable weight of the vehicle and the loaded trailer, including all cargo and passengers, that the vehicle can handle without risking damage. (Important: The towing vehicle's braking system is rated for operation at Gross Vehicle Weight Rating, not at Gross Combined Weight Rating.) Separate functional brakes should be used for safe control of towed vehicles and for trailers where the Gross Combined Weight of the towing vehicle plus the trailer exceed the Gross Vehicle Weight Rating of the towing vehicle. See **Recommended Towing Weights** (page 336).

CALCULATING PAYLOAD

Tire and Loading Label Information

Example:



TIRE AND LOADING INFORMATION

SEATING CAPACITY TOTAL : 5 FRONT: 2 REAR: 3

The combined weight of occupants and cargo should never exceed **385 kg or 850 lbs.**

TIRE	SIZE	COLD TIRE PRESSURE
FRONT	235/45R18 94V	235 KPA, 34 PSI
REAR	235/45R18 94V	235 KPA, 34 PSI
SPARE	NONE	NONE

SEE OWNERS
MANUAL FOR
ADDITIONAL
INFORMATION



TIRE AND LOADING INFORMATION RENSEIGNEMENTS SUR LES PNEUS ET LE CHARGEMENT

SEATING CAPACITY NOMBRE DE PLACES TOTAL 5 FRONT AVANT 2 REAR ARRIERE 3

The combined weight of occupants and cargo should never exceed **396 kg or 875 lbs.**
Le poids total des occupants et du chargement ne doit jamais dépasser **396 kg ou 875 lb.**

TIRE PNEU	SIZE DIMENSIONS	COLD TIRE PRESSURE PRESSION DES PNEUS A FROID
FRONT AVANT	235/40R19 96V	255 KPA, 37 PSI
REAR ARRIERE	235/40R19 96V	255 KPA, 37 PSI
SPARE DE SECOURS	T125/80R16 97M	415 KPA, 60 PSI

SEE OWNER'S
MANUAL FOR
ADDITIONAL
INFORMATION
VOIR LE MANUEL
DE L'USAGER
POUR PLUS DE
RENSEIGNEMENTS

Payload is the combined weight of cargo and passengers that your vehicle is carrying. The maximum payload for your vehicle appears on the Tire and Loading label. The label is either on the B-pillar or the edge of the driver door. Vehicles exported outside the US and Canada may not have a tire and loading label. Look for "The combined weight of occupants and cargo should never exceed XXX kg or XXX lb" for maximum payload. The payload listed on the Tire and Loading Information label

Load Carrying

is the maximum payload for your vehicle as built by the assembly plant. If you install any additional equipment on your vehicle, you must determine the new payload. Subtract the weight of the equipment from the payload listed on the Tire and Loading label. When towing, trailer tongue weight or king pin weight is also part of payload.

CALCULATING THE LOAD LIMIT

Steps for determining the correct load limit:

1. Locate the statement "The combined weight of occupants and cargo should never exceed XXX kg or XXX lb." on your vehicle's placard.
2. Determine the combined weight of the driver and passengers that will be riding in your vehicle.
3. Subtract the combined weight of the driver and passengers from XXX kg or XXX lb.
4. The resulting figure equals the available amount of cargo and luggage load capacity. For example, if the "XXX" amount equals 1,400 lb. and there will be five 150 lb. passengers in your vehicle, the amount of available cargo and luggage load capacity is 650 lb. $(1400 - 750 (5 \times 150) = 650 \text{ lb.})$
5. Determine the combined weight of luggage and cargo being loaded on the vehicle. That weight may not safely exceed the available cargo and luggage load capacity calculated in Step 4.
6. If your vehicle will be towing a trailer, load from your trailer will be transferred to your vehicle. Consult this manual to determine how this reduces the available cargo and luggage load capacity of your vehicle.

Helpful examples for calculating the available amount of cargo and luggage load capacity

Suppose your vehicle has a 1400-pound (635-kilogram) cargo and luggage capacity. You decide to go golfing. Is there enough load capacity to carry you, four of your friends and all the golf bags? You and four friends average 220 pounds (99 kilograms) each and the golf bags weigh approximately 30 pounds (13.5 kilograms) each. The calculation would be: $1400 - (5 \times 220) - (5 \times 30) = 1400 - 1100 - 150 = 150$ pounds. Yes, you have enough load capacity in your vehicle to transport four friends and your golf bags. In metric units, the calculation would be: $635 \text{ kilograms} - (5 \times 99 \text{ kilograms}) - (5 \times 13.5 \text{ kilograms}) = 635 - 495 - 67.5 = 72.5$ kilograms.

Load Carrying

Suppose your vehicle has a 1400-pound (635-kilogram) cargo and luggage capacity. You and one of your friends decide to pick up cement from the local home improvement store to finish that patio you have been planning for the past two years. Measuring the inside of the vehicle with the rear seat folded down, you have room for twelve 100-pound (45-kilogram) bags of cement. Do you have enough load capacity to transport the cement to your home? If you and your friend each weigh 220 pounds (99 kilograms), the calculation would be: $1400 - (2 \times 220) - (12 \times 100) = 1400 - 440 - 1200 = -240$ pounds. No, you do not have enough cargo capacity to carry that much weight. In metric units, the calculation would be: $635 \text{ kilograms} - (2 \times 99 \text{ kilograms}) - (12 \times 45 \text{ kilograms}) = 635 - 198 - 540 = -103$ kilograms. You will need to reduce the load weight by at least 240 pounds (104 kilograms). If you remove three 100-pound (45-kilogram) cement bags, then the load calculation would be: $1400 - (2 \times 220) - (9 \times 100) = 1400 - 440 - 900 = 60$ pounds. Now you have the load capacity to transport the cement and your friend home. In metric units, the calculation would be: $635 \text{ kilograms} - (2 \times 99 \text{ kilograms}) - (9 \times 45 \text{ kilograms}) = 635 - 198 - 405 = 32$ kilograms.

The above calculations also assume that the loads are positioned in your vehicle in a manner that does not overload the front or the rear gross axle weight rating specified for your vehicle on the Safety Compliance Certification label.

ROOF RACK (IF EQUIPPED)

ROOF RACK PRECAUTIONS



WARNING: Read and follow the manufacturer's instructions when you are fitting a roof rack.



WARNING: When loading the roof racks, we recommend you evenly distribute the load, as well as maintain a low center of gravity. Loaded vehicles, with higher centers of gravity, may handle differently than unloaded vehicles. Take extra precautions, such as slower speeds and increased stopping distance, when driving a heavily loaded vehicle.

Note: *If you use a roof rack, the fuel consumption of your vehicle will be higher and you may experience different driving characteristics.*

Note: *Never place loads directly on the roof panel. The roof panel is not designed to directly carry a load.*

You must place loads directly on the crossbars fitted to the roof rack side rails. When using the roof rack system, we recommend that you use genuine Ford accessory crossbars specifically designed for your vehicle.

Load Carrying

Make sure that you securely fasten the load. Check the tightness of the load

before driving and at each fuel stop.

ROOF RACK LOAD CAPACITIES

Description	Maximum Recommended Load
Vehicles without roof rack side rails.	0 lb (0 kg)
Vehicles with a glass roof.	75 lb (35 kg)
Vehicles without a glass roof.	165 lb (75 kg)

Note: *The maximum roof load is based on evenly distributing the load on the crossbars.*

Note: *When using a roof rack system, you must subtract the weight of the roof rack system from the maximum recommended load to determine your actual maximum cargo load. See the roof rack system manufacturer for more information.*

Luggage Compartment

LUGGAGE COMPARTMENT PRECAUTIONS

WARNING: Make sure that you properly secure objects in the luggage compartment. Failure to follow this instruction could result in personal injury in the event of a sudden stop or crash.

WARNING: Do not place objects on the luggage cover. Failure to follow this instruction could result in personal injury or death in the event of a sudden stop or crash.

WARNING: The appropriate loading capacity of your vehicle can be limited either by volume capacity (how much space is available) or by payload capacity (how much weight the vehicle should carry). Once you have reached the maximum payload of your vehicle, do not add more cargo, even if there is space available. Overloading or improperly loading your vehicle can contribute to loss of vehicle control and vehicle rollover.

WARNING: Make sure that you fully close the liftgate to prevent exhaust fumes from entering your vehicle. If you are unable to fully close the liftgate, open the air vents or the windows to allow fresh air to enter your vehicle. Failure to follow this instruction could result in personal injury or death.

WARNING: Do not exceed the maximum front and rear axle loads for your vehicle.

Note: When loading long objects into your vehicle, for example pipes, timber or furniture, be careful not to damage the interior trim.

INSTALLING AND REMOVING THE LUGGAGE COMPARTMENT CARGO NET

(IF EQUIPPED)

WARNING: This net is not designed to restrain objects during a collision or heavy braking.

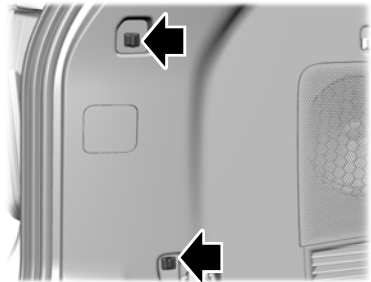

1. Locate the upper and lower cargo hooks on the rear quarter trim panel.

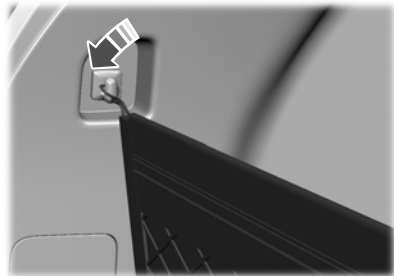

2. Attach the upper loop end of the net to the upper hook.

Luggage Compartment

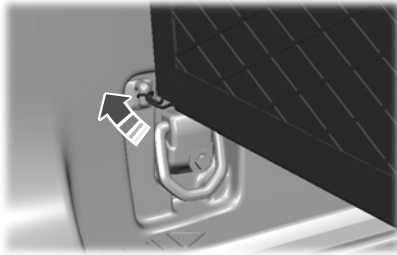

3. Attach the lower loop end of the net to the lower hook.



4. Repeat this procedure on the other side of your vehicle.

INSTALLING AND REMOVING THE LUGGAGE COMPARTMENT COVER (IF EQUIPPED)



WARNING: Make sure that you properly secure the luggage cover. Failure to follow this instruction could result in personal injury in the event of a sudden stop or crash.

Installing the Luggage Cover

1. Insert the luggage cover.

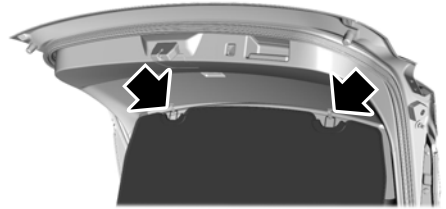

2. Insert the retaining clips into the liftgate trim panel.

Note: Make sure to support the luggage cover when inserting the retaining clips.

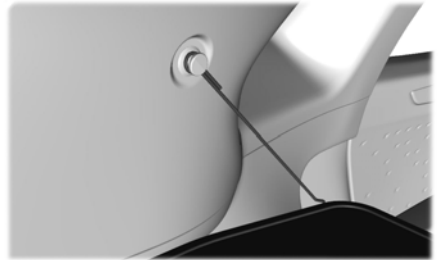

3. Attach the retaining cord to the luggage compartment trim panel.

Removing the Luggage Cover

1. Open the liftgate.

Luggage Compartment

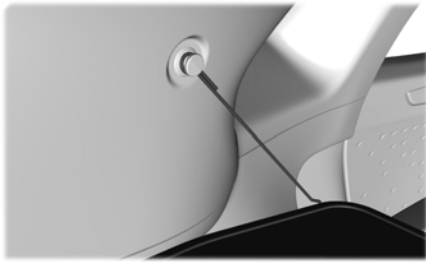

2. Detach the retaining cord on the luggage compartment trim panel.

Note: Support the luggage cover when detaching the retaining cord.

LUGGAGE COMPARTMENT ANCHOR POINTS

LOCATING THE LUGGAGE COMPARTMENT ANCHOR POINTS

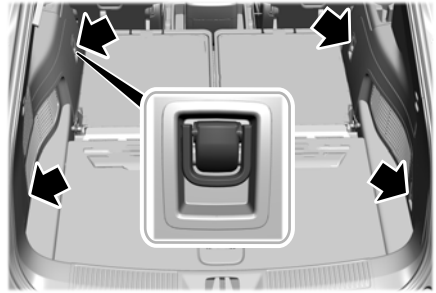

The anchor points for the luggage compartment are located behind the rear seats.

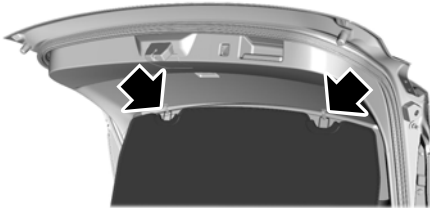

3. Detach the retaining clips on the liftgate trim panel.
4. Lift the luggage cover out of the liftgate.

The luggage cover can be stowed in the luggage compartment.

Connecting a Trailer

CONNECTING A TRAILER PRECAUTIONS

Do not tow a trailer until you drive your vehicle at least 1,000 mi (1,600 km).

Consult your local motor vehicle laws for towing a trailer.

See the instructions included with towing accessories for the proper installation and adjustment specifications.

Service your vehicle more frequently if you tow a trailer. See **General Maintenance Information** (page 492).

If you use a rental trailer, follow the instructions the rental agency gives you.

When attaching the trailer wiring connector to your vehicle, only use a proper fitting connector that works with the vehicle and trailer functions.

Account for the trailer coupler weight as part of your vehicle load when calculating the total vehicle weight.

Do not exceed the load limits. See **Calculating the Load Limit** (page 325).

CONNECTING A TRAILER

Trailer Towing Connector



When attaching the trailer wiring connector to your vehicle, only use a proper fitting connector that works with the vehicle and trailer functions.

Trailer Lamps

WARNING: Never connect any trailer lamp wiring to the vehicle's tail lamp wiring; this may damage the electrical system resulting in fire. Contact your authorized dealer as soon as possible for assistance in proper trailer tow wiring installation. Additional electrical equipment may be required.

Most towed vehicles require trailer lamps. Make sure all running lights, brake lights, turn signals and hazard lights are working.

Safety Chains

Install trailer safety chains to the trailer hitch as recommended by the manufacturer. Cross the chains under the trailer coupler and allow enough slack for turning tight corners. Do not allow the chains to drag on the ground.

Note: Do not attach safety chains to the bumper. Always connect the safety chains to the frame or hook retainers of your trailer hitch.

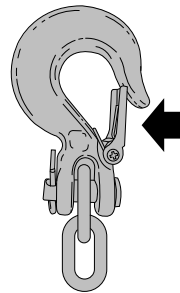

Connecting a Trailer

If the trailer safety chain hook has a latch, make sure to fully close the latch.

TRAILER BATTERY CHARGE/ TRAILER POWER FEED

This feature allows the trailer's battery to charge under the following situations:

- Your vehicle is in the accessory or engine run position.
- If the vehicle's battery voltage is in optimum condition, above 12.5 volts, and the trailer's battery can still hold a charge, or is not too old.

The trailer power feed feature allows for a 12 volt power output on a 7-pin connector when your vehicle is in the accessory or engine run position.

Note: *Trailer power feed can provide a maximum output rate of 15 amps.*

Note: *Never place more demand than 15 amps of power on the trailer power feed, this may damage the trailer lighting.*

CONNECTING A TRAILER – TROUBLESHOOTING

CONNECTING A TRAILER – INFORMATION MESSAGES

Message	Description
Trailer disconnected	The system senses a trailer connection disconnecting, either intentionally or unintentionally, during a given ignition cycle.
Trailer wiring fault	There are certain faults in your vehicle wiring and trailer wiring or brake system.
Trailer Left Turn Lamps Fault Check Lamps	The left-hand trailer turn lamps require service.
Trailer right turn lamps fault Check lamps	The right-hand trailer turn lamps require service.
Trailer battery not charging See manual	The vehicle battery voltage is low or there is a fault with your trailer battery, your trailer battery voltage is below 8 volts, or your trailer battery is connected in reverse polarity.
Trailer Lighting Module Fault See Manual	The system detects a short created by the trailer lamps. Inspect and repair the trailer wiring, or have the system checked as soon as possible.

Towing a Trailer

TOWING A TRAILER PRECAUTIONS

 **WARNING:** Do not exceed the GVWR or the GAWR specified on the certification label.

 **WARNING:** Towing trailers beyond the maximum recommended gross trailer weight exceeds the limit of your vehicle and could result in engine damage, transmission damage, structural damage, loss of vehicle control, vehicle rollover and personal injury.

 **WARNING:** Do not exceed the lowest rating capacity for your vehicle or trailer hitch. Overloading your vehicle or trailer hitch can impair your vehicle stability and handling. Failure to follow this instruction could result in the loss of control of your vehicle, personal injury or death.

 **WARNING:** Make sure that the vertical load on the tow ball is between the minimum and maximum recommended weight at all times. Failure to follow this instruction could result in the loss of control of your vehicle, personal injury or death.

 **WARNING:** Do not cut, drill, weld or modify the trailer hitch. Modifying the trailer hitch could reduce the hitch rating.

 **WARNING:** The anti-lock brake system does not control the trailer brakes.

TRAILER BRAKE PRECAUTIONS

 **WARNING:** Do not connect a trailer's hydraulic brake system directly to your vehicle's brake system. Your vehicle may not have enough braking power and your chances of having a collision greatly increase.

 **WARNING:** Do not tow a trailer fitted with electric trailer brakes unless your vehicle is fitted with a compatible aftermarket electronic trailer brake controller. Failure to follow this instruction could result in the loss of control of your vehicle, personal injury or death. For additional information and assistance, we recommend that you contact an authorized dealer.

Electric brakes and manual, automatic or surge-type trailer brakes are safe if you install them properly and adjust them to the manufacturer's specifications. The trailer brakes must meet local and federal regulations.

The rating for the tow vehicle's braking system operation is at the gross vehicle weight rating, not the gross combined weight rating.

Towing a Trailer

Certain states require functioning trailer brakes for trailers over a specified weight. Be sure to check state regulations for this specified weight.

Ford Motor Company recommends separate functioning brake systems for trailers weighing more than 1,500 lb (680 kg) when loaded.

TOWING A TRAILER LIMITATIONS

Your vehicle's load capacity designation is by weight, not by volume, so you cannot necessarily use all available space when loading a vehicle or trailer.

Towing a trailer also requires your understanding of how and when to use or not use additional systems present in your vehicle. The following systems referenced are to be used as a guide and are not a complete list. See **Lane Centering Precautions** (page 271). See **BlueCruise Precautions** (page 279). See **Adaptive Cruise Control Precautions** (page 264).

Note: *Your vehicle could have reduced performance when operating at high altitudes and when heavily loaded or towing a trailer. When driving at elevation, to match driving performance as perceived at sea level, reduce gross vehicle weight and gross combination weight by 2% per 1,000 ft (300 m) elevation.*

LOADING YOUR TRAILER

To help minimize how trailer movement affects your vehicle when driving:

- Load the heaviest items closest to the trailer floor.
- Load the heaviest items centered between the left and right side trailer tires.
- Load the heaviest items above the trailer axles or just slightly forward toward the trailer tongue. Do not allow the final trailer tongue weight to go above or below 10-15% of the loaded trailer weight. The trailer tongue weight should never exceed 10% of the maximum towing capacity.
- Select a ball mount with the correct rise or drop. When both the loaded vehicle and trailer are connected, the trailer frame should be level, or slightly angled down toward your vehicle, when viewed from the side.

TRAILER TOWING HINTS

Towing a trailer places an extra load on your vehicle's engine, transmission, axle, brakes, tires and suspension. Periodically inspect these components during and after any towing operation.

When driving with a trailer or payload, a slight takeoff vibration or shudder may be present due to the increased payload weight.

Towing a Trailer

Your vehicle may have a temporary or conventional spare tire. A temporary spare tire is different in diameter or width, tread-type, or is from a different manufacturer than the road tires on your vehicle. Consult information on the tire label or Safety Compliance label for limitations when using.

When towing a trailer:

- Obey country specific regulations for towing a trailer.
- Do not drive faster than 70 mph (113 km/h) during the first 500 mi (800 km).
- Do not make full-throttle starts.
- Check your hitch, electrical connections and trailer wheel lug nuts thoroughly after you have traveled 50 mi (80 km).
- When stopped in congested or heavy traffic during hot weather, place the transmission in park (P) to aid engine and transmission cooling and to help A/C performance.
- Turn off the speed control with heavy loads or in hilly terrain. The speed control may turn off when you are towing on long, steep slopes.
- Shift to a lower gear when driving down a long or steep hill. Do not continuously apply the brakes, as they may overheat and become less effective.
- If your transmission has Grade Assist or Tow/Haul, use this feature when towing. This provides engine braking and helps eliminate excessive transmission shifting for optimum fuel economy and transmission cooling.

- Your vehicle has AdvanceTrac with roll stability control. When towing a trailer, additional loads could cause the AdvanceTrac system to engage during cornering maneuvers. Reduce cornering speeds to make sure that you can maintain control of the vehicle and trailer if the AdvanceTrac system engages.
- Allow more distance for stopping with a trailer attached. Anticipate stops and gradually brake.
- Avoid parking on a slope. However, if you must park on a slope, turn the steering wheel to point your vehicle tires away from traffic flow, set the parking brake, place the transmission in park (P) and place wheel chocks in front and back of the trailer wheels.

Note: *Chocks are not included with your vehicle.*

LAUNCHING OR RETRIEVING A BOAT OR PERSONAL WATERCRAFT

When backing down a ramp during boat launching or retrieval:

- Do not allow the static water level to rise above the bottom edge of the rear bumper.
- Do not allow waves to break higher than 6 in (15 cm) above the bottom edge of the rear bumper.

Exceeding 6 in (15 cm) could allow water to enter vehicle components, causing internal damage to the components and affecting driveability, emissions and reliability.

Note: *Replace the rear axle lubricant anytime the rear axle has been submerged in water.*

Towing a Trailer

Note: Disconnect the trailer wiring connector before backing the trailer into the water.

Note: Reconnect the trailer wiring connector after removing the trailer from the water.

TOWING WEIGHTS AND DIMENSIONS

RECOMMENDED TOWING WEIGHTS

United States of America



<https://www.fordpro.com/en-us/fleet-vehicles/manuals-and-guides/>

Canada (English)



<https://www.fordpro.ca/en-ca/fleet-vehicles/manuals-and-guides/>

Canada (French)



<https://www.fordpro.ca/fr-ca/fleet-vehicles/manuals-and-guides/>

WHAT IS THE MAXIMUM LOADED TRAILER WEIGHT

The maximum loaded trailer weight is the highest possible weight of a fully loaded trailer the vehicle can tow.

CALCULATING THE MAXIMUM LOADED TRAILER WEIGHT FOR YOUR VEHICLE

1. Start with the gross combined weight rating for your vehicle model and axle ratio.
2. Subtract all of the following that apply to your vehicle:
 - Vehicle curb weight.
 - Hitch hardware weight, for example a draw bar, ball, locks or weight distributing hardware.
 - Driver weight.
 - Passenger weight.
 - Payload, cargo and luggage weight.
 - Aftermarket equipment weight.

This equals the maximum loaded trailer weight for this combination.

Note: *The trailer tongue load is considered part of the payload for your vehicle. Reduce the total payload by the final trailer tongue weight.*

Towing a Trailer

Note: Consult an authorized dealer to determine the maximum trailer weight allowed for your vehicle if you are not sure.

TOWING A TRAILER – TROUBLESHOOTING

TOWING A TRAILER – INFORMATION MESSAGES

Message	Details
Trailer Sway Control Reduce speed	The trailer sway control detects trailer sway. Reduce the vehicle's speed.
Trailer brake system fault See manual	Verify the trailer brake connections are secure and that the aftermarket trailer brake controller device is correctly installed. Perform a trailer brake and trailer light check if possible. If the message persists, have your vehicle checked as soon as possible.
Trailer brake module fault	Perform a trailer brake and trailer light check if possible. If the message persists, have your vehicle checked as soon as possible.

Trailer Sway Control (If Equipped)

HOW DOES TRAILER SWAY CONTROL WORK

The system applies the brakes to the individual wheels and reduces engine torque to aid vehicle stability.

If the trailer begins to sway, the stability control lamp flashes and the message **Trailer Sway Reduce Speed** appears in the information display.

Stop your vehicle as soon as it is safe to do so. Check the vertical weight on the tow ball and trailer load distribution.

TRAILER SWAY CONTROL PRECAUTIONS



WARNING: Turning off trailer sway control increases the risk of loss of vehicle control, serious injury or death. Ford does not recommend disabling this feature except in situations where speed reduction may be detrimental (such as hill climbing), the driver has significant trailer towing experience, and can control trailer sway and maintain safe operation.

Note: *This feature only activates when significant trailer sway occurs.*

Note: *This feature does not prevent trailer sway, but reduces it once it begins.*

Note: *This feature cannot stop all trailers from swaying.*

Note: *In some cases, if vehicle speed is too high, the system may activate multiple times, gradually reducing vehicle speed.*

Driving Hints

BREAKING-IN

Your vehicle requires a break-in period. For the first 1,000 mi (1,600 km), avoid driving at high speeds, heavy braking, aggressive shifting or using your vehicle to tow. During this time, your vehicle may exhibit some unusual driving characteristics.

DRIVING ECONOMICALLY

The following helps to improve fuel consumption:

- Drive smoothly, accelerate gently and anticipate the road ahead to avoid heavy braking.
- Regularly check your tire pressures and make sure that they are inflated to the correct pressure.
- Follow the recommended maintenance schedule and carry out the recommended checks.
- Plan your journey and check the traffic before you set off. It is more efficient to combine errands into a single trip whenever possible.
- Avoid idling the engine in cold weather or for extended periods. Start the engine only when you are ready to set off.
- Do not carry unnecessary weight in your vehicle as extra weight wastes fuel.
- Do not add unnecessary accessories to the exterior of your vehicle, for example running boards. If you use a roof rack, remember to fold it down or remove it when not in use.
- Do not shift into neutral when you are braking or when your vehicle is slowing down.

- Shut all windows when driving at high speeds.
- Switch off all electric systems when not in use, for example air conditioning. Make sure that you unplug any accessories from the auxiliary power points when not in use.

DRIVING IN COLD WEATHER

The functional operation of some components and systems can be affected at temperatures below approximately -13°F (-25°C).

Driving on Snow and Ice



WARNING: If you are driving in slippery conditions that require tire chains or cables, then it is critical that you drive cautiously. Keep speeds down, allow for longer stopping distances and avoid aggressive steering to reduce the chances of a loss of vehicle control which can lead to serious injury or death. If the rear end of your vehicle slides while cornering, steer in the direction of the slide until you regain control of your vehicle.

On ice and snow, you should drive more slowly than usual. Your vehicle has a four wheel anti-lock brake system, do not pump the brake pedal. See **Anti-Lock Braking System Limitations** (page 228).

In snow and ice, all-wheel drive vehicles have advantages over two-wheel drive vehicles but can still skid. When driving on snowy or icy roads, should you start to slide, turn the steering wheel in the direction of the slide until you regain control.

Driving Hints

On snow and ice, avoid suddenly applying power and avoid quick change of direction. Apply the accelerator slowly and steadily when starting from a stop.

Avoid sudden braking. An all-wheel drive vehicle may accelerate better than a two-wheel drive vehicle in snow and ice. However, an all-wheel drive vehicle will not stop any faster, as braking occurs at all four wheels. Do not become overconfident to road conditions.

DRIVING THROUGH MUD AND WATER

Mud

Be cautious of sudden changes in vehicle speed or direction when you are driving in mud. Even all-wheel drive and four-wheel drive vehicles can lose traction in mud. If your vehicle slides, steer in the direction of the slide until you regain control of your vehicle. After driving through mud, clean off residue stuck to rotating driveshafts and tires. Excess residue can cause an imbalance that could damage drive components.

Note: *If your vehicle gets stuck in mud, it could be rocked out by shifting between forward and reverse gears, stopping between shifts in a steady pattern. Press lightly on the accelerator in each gear.*

Water

If you must drive through water approach it cautiously. See **Driving Through Shallow Water** (page 341).

DRIVING ON HILLY OR SLOPING TERRAIN



WARNING: Extreme care should be used when steering the vehicle in reverse down a slope so as not to cause the vehicle to swerve out of control.

Although natural obstacles could make it necessary to travel diagonally up or down a hill or steep incline, you should try to drive straight up or straight down.

Note: *Avoid turning on steep slopes or hills. A danger lies in losing traction, slipping sideways and possible vehicle roll over. Whenever driving on a hill, determine beforehand the route you can use. Do not drive over the crest of a hill without seeing what conditions are on the other side. Do not drive in reverse over a hill without the aid of an observer.*

Apply just enough power to the wheels to climb the hill. Too much power causes the tires to slip, spin or lose traction, and you could lose control of your vehicle. When descending a steep hill, do not descend the hill in neutral. Avoid sudden hard braking to keep the front wheels rolling and to maintain your vehicle's steering.

Note: *Your vehicle has an anti-lock braking system, apply the brake pedal steadily. Do not pump the brake pedal.*

Note: *If your vehicle gets stuck driving on hilly or sloping terrain, it could be rocked out by shifting between forward and reverse gears, stopping between shifts in a steady pattern. Press lightly on the accelerator in each gear.*

Note: *Do not rock your vehicle if the engine is not at normal operating temperature, as damage to the transmission could occur.*

Driving Hints

Note: Do not rock your vehicle for more than a minute, as damage to the transmission and tires could occur or the engine could overheat.

DRIVING IN SAND

When driving in sand, keep all four wheels on the most solid area of the trail and drive steadily. Accelerate slowly and avoid excessive wheel slip. Do not drive in deep sand for too long, as this can overheat the system, causing a warning message to appear in the instrument cluster display.

Note: If you get stuck, gently rock your vehicle out by shifting between drive (D) and reverse (R), lightly apply the accelerator. Pause each time before shifting.

Note: Avoid rocking your vehicle until the engine reaches normal operating temperature. This helps prevent transmission damage.

Note: Avoid rocking your vehicle for more than a minute. Damage to the transmission and tires could occur or the engine could overheat.

DRIVING THROUGH SHALLOW WATER



WARNING: Do not attempt to cross a deep or flowing body of water. Failure to follow this instruction could result in the loss of control of your vehicle, personal injury or death.

Note: Driving through standing water can cause vehicle damage.

Note: Engine damage can occur if water enters the air filter.

Before driving through standing water, check the depth. Never drive through water that is higher than the bottom of the front rocker area of your vehicle.



When driving through standing water, drive very slowly and do not stop your vehicle. Your brake performance and traction could be limited. After driving through water and as soon as it is safe to do so:

- Lightly press the brake pedal to dry the brakes and to check that they work.
- Turn the steering wheel to check that the steering power assist works.

Check the function of the following:

- Horn
- Exterior lights

FLOOR MATS



WARNING: Use a floor mat designed to fit the footwell of your vehicle that does not obstruct the pedal area. Failure to follow this instruction could result in the loss of control of your vehicle, personal injury or death.



WARNING: Pedals that cannot move freely can cause loss of vehicle control and increase the risk of serious personal injury.

Driving Hints

WARNING: Secure the floor mat to both retention devices so that it cannot slip out of position and interfere with the pedals. Failure to follow this instruction could result in the loss of control of your vehicle, personal injury or death.

WARNING: Do not place additional floor mats or any other covering on top of the original floor mats. This could result in the floor mat interfering with the operation of the pedals. Failure to follow this instruction could result in the loss of control of your vehicle, personal injury or death.

WARNING: Always make sure that objects cannot fall into the driver foot well while your vehicle is moving. Objects that are loose can become trapped under the pedals causing a loss of vehicle control.

To remove the floor mats, reverse the installation procedure.

Note: *Regularly check the floor mats to make sure they are secure.*



To install floor mats that have eyelets, position the floor mat eyelet over the retention post and press down to lock in position. Repeat for all eyelets on the floor mat.

If the driver side floor mat is not securely fastened, remove it, and contact an authorized dealer as soon as possible. Do not drive with a loose floor mat.

Crash and Breakdown Information

ROADSIDE ASSISTANCE

Vehicles Sold in the United States: Getting Roadside Assistance

If you have a vehicle concern, Ford Motor Company offers a complimentary roadside assistance program. This program is separate from the New Vehicle Limited Warranty.

The service is available:

- 24 hours a day, seven days a week.
- For the coverage period supplied with your vehicle.

Knowing your vehicle's VIN, mileage and your specific location allows help to get to you faster.

Roadside Assistance covers:

- A flat tire change with a good spare (except vehicles supplied with a tire inflation kit).
- Battery jump start.
- Lock-out assistance (key replacement cost is the customer's responsibility).
- Fuel delivery — independent service contractors, if not prohibited by state, local or municipal law, shall deliver up to 2 gal (8 L) of gasoline or 5 gal (20 L) of diesel fuel to a disabled vehicle. Roadside assistance limits fuel delivery service to two no-charge occurrences within a 12-month period.
- Winch out — available within 100 ft (30 m) of a paved or county maintained road, no recoveries.

- Towing — independent service contractors, if not prohibited by state, local or municipal law, shall tow Ford eligible vehicles to an authorized dealer within 50 mi (80 km) of the disablement location or to the nearest authorized dealer. If a member requests a tow to an authorized dealer that is more than 50 mi (80 km) from the disablement location, the member shall be responsible for any mileage costs in excess of 50 mi (80 km). Warranty towing, non-warranty towing and collision towing are available.
- Roadside Assistance includes up to \$200 for a towed trailer if the disabled eligible vehicle requires service at the nearest authorized dealer. If the towing vehicle is operational but the trailer is not, then the trailer does not qualify for any roadside services.

Vehicles Sold in the United States: Using Roadside Assistance

United States vehicle customers who require Roadside Assistance, call 1-800-241-3673.

If you need to arrange roadside assistance on your own, Ford Motor Company reimburses a reasonable amount for towing to the nearest dealership within 50 mi (80 km). To obtain reimbursement information, United States vehicle customers call 1-800-241-3673. Customers need to submit their original receipts.

Vehicles Sold in Canada: Getting Roadside Assistance

If you have a vehicle concern, Ford Motor Company of Canada, Limited offers a complimentary roadside assistance program. This program is eligible within Canada or the continental United States.

The service is available 24 hours a day, seven days a week.

Crash and Breakdown Information

This program is separate from the New Vehicle Limited Warranty, but the coverage is concurrent with the powertrain coverage period of your vehicle. Canadian roadside coverage and benefits may differ from the U.S. coverage. For complete details, see your Warranty Guide at

www.ford.ca/support/owner-manuals



Download the Sykes4Ford Roadside Assistance App for access to your roadside assistance services. For more information, scan here:



If you require more information, please call us in Canada at 1-800-665-2006, or visit our website at www.ford.ca.



Ford Motor Company of Canada, Limited reserves the right to modify or discontinue Roadside Assistance at any time. Certain restrictions apply to Roadside Assistance benefits.

For further details, call
1-800-665-2006

HIGH VOLTAGE BATTERY VEHICLE PRECAUTIONS - FULL HYBRID ELECTRIC VEHICLE (FHEV)

In the event of damage or fire involving an electric vehicle or hybrid-electric vehicle:

- Assume the high-voltage battery and associated components are energized and fully charged.
- Exposed electrical components, wires and high-voltage batteries present potential high-voltage shock hazards.
- Venting high-voltage battery vapors are potentially toxic and flammable.
- Physical damage to the vehicle or high-voltage battery could result in immediate or delayed release of toxic, flammable gases and fire.

Vehicle information and general safety practices include reviewing the owner's manual and becoming familiar with your vehicle's safety information and recommended safety practices.

Crashes

A crash or impact significant enough to require an emergency response for conventional vehicles would also require the same response for an electric or hybrid-electric vehicle.

If Possible:

1. Move your vehicle to a safe, nearby location and remain on the scene.
2. Roll down the windows before you switch your vehicle off.
3. Place your vehicle in park (P), set the parking brake, switch off the vehicle, activate the hazard flashers and move your key(s) at least 16 ft (5 m) away from the vehicle.

Crash and Breakdown Information

Always:

- Call emergency assistance if needed and advise that an electric or hybrid-electric vehicle is involved.
- Avoid contact with leaking fluids and gases, and remain out of the way of oncoming traffic until emergency responders arrive.
- When emergency responders arrive, tell them that the vehicle involved is an electric vehicle or hybrid-electric vehicle.

Fires

As with any vehicle, call emergency assistance immediately if you see sparks, smoke or flames coming from the vehicle. Remain a safe distance from the vehicle and try to stay clear of the smoke.

1. Exit the vehicle immediately.
2. Advise emergency assistance that an electric or hybrid-electric vehicle is involved.
3. Never attempt to extinguish an electric vehicle fire or move a vehicle that is on fire.
4. As with any vehicle fire, do not inhale smoke, vapors or gas from the vehicle, as they may be hazardous.

Post-Incident

1. Do not store a severely damaged vehicle with a lithium-ion battery inside a structure or within 49 ft (15 m) of any structure or vehicle.
2. Make sure that passenger and luggage compartments remain ventilated.
3. Call emergency assistance if you observe leaking fluids, sparks, smoke or flames, or hear gurgling or bubbling from the high-voltage battery.

SWITCHING THE HAZARD FLASHERS ON AND OFF



The hazard flasher button is on the instrument panel. Press the button to switch the hazard flashers on if your vehicle is creating a safety hazard for other road users.

When you switch the hazard flashers on, all front and rear direction indicators flash.

Note: *The hazard flashers operate when the ignition is in any position, or if the key is not in the ignition. The battery loses charge and could have insufficient power to restart your vehicle.*

Press the button again to switch them off.

JUMP STARTING THE VEHICLE

JUMP STARTING PRECAUTIONS



WARNING: Batteries normally produce explosive gases which can cause personal injury. Therefore, do not allow flames, sparks or lighted substances to come near the battery. When working near the battery, always shield your face and protect your eyes. Always provide correct ventilation.



WARNING: Keep batteries out of reach of children. Batteries contain sulfuric acid. Avoid contact with skin, eyes or clothing. Shield your eyes when working near the battery to protect against possible splashing of acid solution. In case of acid contact with skin or eyes, flush immediately with water for a minimum of 15 minutes and get prompt medical attention. If acid is swallowed, call a physician immediately.

Crash and Breakdown Information

 **WARNING:** Use only adequately sized cables with insulated clamps.

 **WARNING:** Make sure that the cables are clear of any moving parts and fuel delivery system parts.

 **WARNING:** Connect batteries with only the same nominal voltage.

 **WARNING:** Using the jump leads incorrectly or completing the jump start procedure incorrectly can cause the battery to explode, which can lead to severe injuries.

 **WARNING:** All work on the vehicle battery and the electrical system can cause serious chemical burns, fire or electric shocks. Always read the warnings and safety information before carrying out any kind of work on the battery.

 **WARNING:** Never charge a 12-volt vehicle battery once it has been frozen. Discharged 12-volt vehicle batteries can even freeze at temperatures of approximately 0°C (+32°F).

 **WARNING:** The battery should be replaced if it is or has ever been frozen.

 **WARNING:** A highly explosive mixture of gases is given off when the vehicle battery is jump started. Always keep fire, sparks, naked flames and lit cigarettes away from the vehicle battery. Never use a mobile telephone when the jump leads are being connected or disconnected.

 **WARNING:** Only charge the battery in a well-ventilated space as the battery emits a highly explosive mixture of gases when the vehicle is being jump started.

 **WARNING:** Never confuse the negative and positive terminals or connect the jump leads incorrectly.

 **WARNING:** Observe the jump lead manufacturer's instructions.

 **WARNING:** If the engine is running while the hood is open, stay clear of moving engine components. Failure to follow this warning could result in serious personal injury or death.

Do not attempt to push-start an automatic transmission vehicle. This could cause transmission damage.

Do not disconnect the battery of the disabled vehicle. This could damage your vehicle's electrical system.

PREPARING THE VEHICLE

Use only a 12 volt supply to start your vehicle.

Park the booster vehicle close to the hood of the disabled vehicle, making sure the two vehicles do not touch.

JUMP STARTING THE VEHICLE

Locating the Jump Start Connection Points

1. Open the hood. See **Opening and Closing the Hood** (page 364).
2. Remove the access cover.
3. Remove the red protective cover from the positive (+) jump connection point.
4. Locate the negative (-) jump connection point on the rear mounting bolt for the cross brace, as shown in the following illustration.

Crash and Breakdown Information

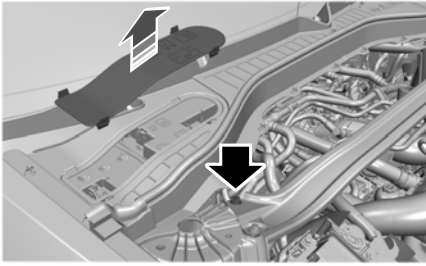

E288229

Connecting the Jumper Cables



WARNING: Do not connect the negative jumper cable to any other part of your vehicle. Use the ground point.

Note: If you are using a jump pack or booster box, follow the manufacturer's instructions.

Note: In the illustration that follows, the bottom vehicle represents the booster vehicle.

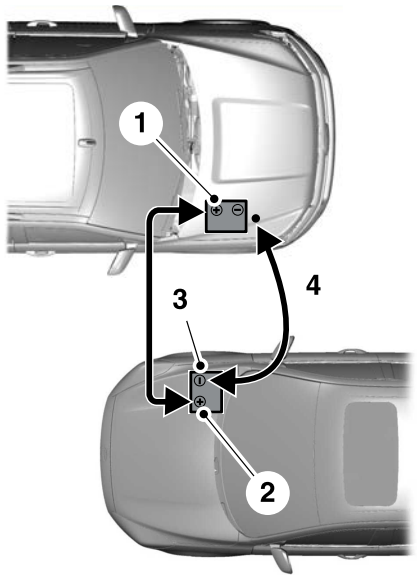

1. Connect the positive (+) jumper cable to the positive (+) terminal of the discharged battery.
2. Connect the other end of the positive (+) jumper cable to the positive (+) terminal of the booster vehicle battery.
3. Connect the negative (-) jumper cable to the negative (-) terminal of the booster vehicle battery.
4. Make the final connection of the negative (-) jumper cable to an exposed metal part of the disabled vehicle's engine, away from the battery and fuel injection system, or connect the negative (-) jumper cable to a ground connection point if available.

Crash and Breakdown Information

Starting the Engine

1. Start the engine of the booster vehicle and moderately rev the engine, or gently press the accelerator to keep the engine speed between 2000 RPM and 3000 RPM, as shown in your tachometer.
2. Start the engine of the disabled vehicle.
3. Once you start the disabled vehicle, run both vehicle engines for an additional three minutes before disconnecting the jumper cables.

Removing the Jumper Cables

Remove the jumper cables in the reverse order that they were connected.

Note: Do not switch the headlamps on when disconnecting the cables. The peak voltage could blow the bulbs.

POST-CRASH ALERT SYSTEM

WHAT IS THE POST-CRASH ALERT SYSTEM

The system helps draw attention to your vehicle in the event of a serious impact.

HOW DOES THE POST-CRASH ALERT SYSTEM WORK

The system is designed to turn the hazard flashers on, turn the courtesy lamps on and unlock all doors in the event of a serious impact that deploys an airbag or the seatbelt pretensioners.

SWITCHING THE POST-CRASH ALERT SYSTEM OFF

Press the hazard flasher switch, or the unlock button on the remote control, or the panic button on the remote control or turn your vehicle off and on twice to switch the system off.

Note: The alert turns off when the vehicle battery runs out of charge.

POST-COLLISION BRAKING - EXCLUDING: POLICE

How Does Post-Collision Braking Work

In the event of a moderate to severe crash, the braking system reduces the vehicle's speed to prevent or reduce the impact of a potential secondary crash.

Post-Collision Braking Limitations

Post-collision braking does not activate if any of the following occur:

- The anti-lock braking system is damaged during the collision.
- Electronic stability control is disabled.

Overriding Post-Collision Braking

You can override post-collision braking by pressing the brake or accelerator pedal.

Post-Collision Braking Indicators



It flashes when a post-collision braking event is occurring.

Crash and Breakdown Information

AUTOMATIC CRASH SHUTOFF

WHAT IS AUTOMATIC CRASH SHUTOFF

The automatic crash shutoff is designed to stop the fuel going to the engine in the event of a moderate or severe crash.

Note: *Not every impact causes a shutoff.*

AUTOMATIC CRASH SHUTOFF PRECAUTIONS



WARNING: If your vehicle has been involved in a crash, have the fuel system checked. Failure to follow this instruction could result in fire, personal injury or death.

RE-ENABLING YOUR VEHICLE

1. Switch the ignition off.
2. Attempt to start your vehicle.
3. Switch the ignition off.
4. Attempt to start your vehicle.

Note: *If your vehicle does not start after the third attempt, have your vehicle checked as soon as possible.*

TRANSPORTING THE VEHICLE

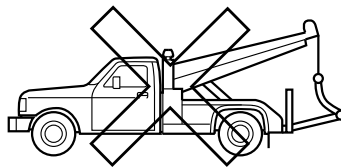
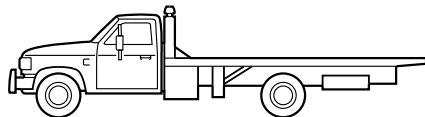
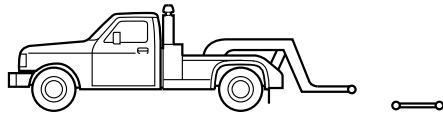

If you need to tow your vehicle, contact a professional towing service or your roadside assistance service provider.

Your manufacturer produces a towing manual for all authorized tow truck operators. Have your tow truck operator refer to this manual for proper hook-up and towing procedures.

We recommend the use of a wheel lift and dollies or flatbed equipment to tow your vehicle. Vehicle damage could occur if towed incorrectly, or by any other means.

Front-wheel and rear-wheel drive vehicles must have their designated drive wheels off the ground regardless of towing direction. Use tow dollies to prevent damage to the transmission.

Crash and Breakdown Information

All-wheel or four-wheel drive vehicles require that all wheels be off the ground using a wheel lift and dollies or flatbed equipment. This prevents damage to the transmission and drive system.

Note: You need to switch on the ignition to unlock the steering.

Note: Make sure you check the steering column before towing. It could lock if the battery is dead.

FAIL-SAFE COOLING

WHAT IS FAIL-SAFE COOLING

Fail-safe cooling allows you to temporarily drive your vehicle before any incremental component damage occurs due to overheating.

The fail-safe distance depends on outside temperature, vehicle load and terrain.

HOW DOES FAIL-SAFE COOLING WORK

If the engine reaches a preset over-temperature condition, the engine automatically switches to alternating cylinder operation. Each disabled cylinder acts as an air pump and cools the engine.

When this occurs, your vehicle still operates, however:

- Engine power is limited.
- The air conditioning system turns off.

Continued operation increases the engine temperature, causing the engine to completely shut down. Your steering and braking effort increases in this situation.

When the engine temperature cools, you can re-start the engine.

Note: Have your vehicle checked as soon as possible to minimize engine damage.

DRIVING WHEN FAIL-SAFE MODE IS ACTIVATED



WARNING: Fail-safe mode is for use during emergencies only. Operate your vehicle in fail-safe mode only as long as necessary to bring your vehicle to rest in a safe location and seek immediate repairs. When in fail-safe mode, your vehicle will have limited power, will not be able to maintain high-speed operation, and may completely shut down without warning, potentially losing engine power, power steering assist, and power brake assist, which may increase the possibility of a crash resulting in serious injury.



WARNING: Do not remove the coolant reservoir cap when the engine is on or the cooling system is hot. Wait 10 minutes for the cooling system to cool down. Cover the coolant reservoir cap with a thick cloth to prevent the possibility of scalding and slowly remove the cap. Failure to follow this instruction could result in personal injury.

Continued operation increases the engine temperature, causing the engine to completely shut down. Your steering and braking effort increases in this situation.

When the engine temperature cools, you can re-start the engine. Have your vehicle checked as soon as possible to minimize engine damage.

Your vehicle has limited engine power when in the fail-safe mode, drive your vehicle with caution. Your vehicle does not maintain high-speed operation and the engine may operate poorly.

Remember that the engine is capable of automatically shutting down to prevent engine damage. In this situation:

Crash and Breakdown Information

1. Pull off the road as soon as safely possible and switch the engine off.
2. If you are a member of a roadside assistance program, we recommend that you contact your roadside assistance service provider.
3. If this is not possible, wait for a short period of time for the engine to cool.
4. Check the coolant level. If the coolant level is at or below the minimum mark, add prediluted coolant immediately.
5. When the engine temperature cools, you can re-start the engine. Have your vehicle checked as soon as possible to minimize engine damage.

Note: *Driving your vehicle without repair increases the chance of engine damage.*

FAIL-SAFE COOLING INDICATORS



If the engine begins to overheat, the coolant temperature gauge moves toward the red zone.



A warning lamp illuminates and a message may appear in the instrument cluster display.

Towing Your Vehicle

TOWING YOUR VEHICLE PRECAUTIONS

Use the following guidelines when towing your vehicle. Failure to follow this instruction could result in vehicle damage not covered by the vehicle warranty.

Note: Make sure you properly secure your vehicle to the tow vehicle.

Note: If you are unsure of the vehicle's configuration, contact an authorized dealer.

RECREATIONALLY TOWING YOUR VEHICLE

You cannot recreational tow your vehicle with all wheels on the ground because vehicle or transmission damage could occur. You must recreational tow your vehicle with all four wheels off the ground, such as when using a car-hauling trailer. Otherwise, you cannot recreational tow your vehicle.

EMERGENCY TOWING - POLICE

If your vehicle becomes inoperable without access to wheel dollies or a vehicle transport trailer, it can be flat-towed with all wheels on the ground, regardless of the powertrain and transmission configuration, under the following conditions:

- Your vehicle is facing forward for towing in a forward direction.
- Place the transmission in neutral (N). If you cannot move the transmission into neutral (N), you may need to override it. See **Shifting Your Immobile Vehicle Out of Park (P)** (page 210). Failure to do so may result in damage to the transmission

- Maximum speed is 35 mph (55 km/h).
- Maximum distance is 50 mi (80 km).

EMERGENCY TOWING - EXCLUDING: POLICE

If your vehicle becomes inoperable without access to wheel dollies or a vehicle transport trailer, it can be flat towed with all wheels on the ground, regardless of the powertrain and transmission configuration, under the following conditions:

- Your vehicle is facing forward for towing in a forward direction.
- Use the manual park release procedure. See **Shifting Your Immobile Vehicle Out of Park (P)** (page 208). Failure to do so may result in damage to the transmission.
- Maximum speed is 35 mph (56 km/h).
- Maximum distance is 50 mi (80 km).

Fuses

FUSE PRECAUTIONS

⚠ WARNING: Always disconnect the battery before servicing high current fuses.

⚠ WARNING: To reduce risk of electrical shock, always replace the cover to the power distribution box before reconnecting the battery or refilling fluid reservoirs.

⚠ WARNING: Always replace a fuse with one that has the specified amperage rating. Using a fuse with a higher amperage rating can cause severe wire damage and could start a fire.

UNDER HOOD FUSE BOX

LOCATING THE UNDER HOOD FUSE BOX

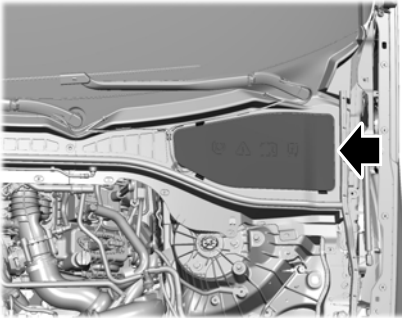

ACCESSING THE UNDER HOOD FUSE BOX

Remove the top cover to get to the fuse box and then remove the fuse box cover to access the fuses.

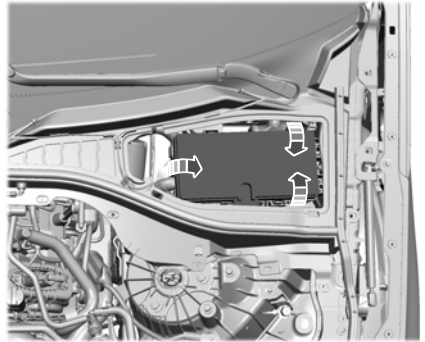

Fuses

IDENTIFYING THE FUSES IN THE UNDER HOOD FUSE BOX

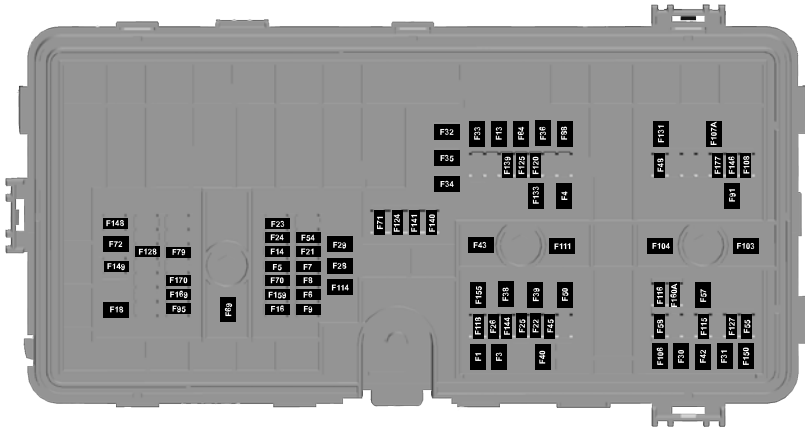

Item	Fuse Rating	Protected Component
1	30 A	Body control module feed 1.
3	30 A	Body control module feed 2.
4	30 A	Fuel pump feed.
5	5 A	Live power.
6	20 A	Powertrain control module - vehicle power 1.
7	20 A	Powertrain control module - vehicle power 2.
8	20 A	Powertrain control module - vehicle power 3.
9	20 A	Powertrain control module - vehicle power 4.
13	40 A	Blower motor.
14	15 A	Powertrain control module - auxiliary vehicle power 3.

Fuses

Item	Fuse Rating	Protected Component
16	15 A	Rear windshield washer.
18	30 A	Starter motor solenoid.
21	10 A	Not used (spare).
22	5 A	Run-start signal - electronic power assist steering.
23	5 A	Run-start signal - anti-lock brake system.
24	5 A	Run-start signal - power-train control module.
25	10 A	Air quality sensor. Not used (police).
26	15 A	Run-start power - transmission oil pump. Not used (police).
28	40 A	Anti-lock brake system valves.
29	60 A	Anti-lock brake system pump.
30	50 A	Upfitter interface module power feed 1 (police).
31	50 A	Upfitter interface module power feed 2 (police).
32	20 A	Power outlet 1 - front bin.
33	20 A	Power outlet 2 - cargo area.
34	20 A	Power outlet 3 - main bin (police).
35	20 A	Power outlet 4 - back of console.
36	40 A	110 V inverter. Not used (police).
38	30 A	Climate controlled front seats. Not used (police).

Fuses

Item	Fuse Rating	Protected Component
39	30 A	Not used (spare).
40	60 A	Not used (spare).
42	30 A	Trailer tow brake control.
43	40 A	Body control module feed 3.
45	15 A	Run-start power - interior power distribution box.
48	5 A	Police accessory independent timed-release output.
50	40 A	Heated rear window.
54	20 A	Run-start power - heated steering wheel. Run-start power 1 - police tap-in (police). Run-start power - visor control module (police).
55	20 A	Trailer tow park lamps.
57	30 A	Trailer tow battery charge.
58	10 A	Trailer tow back up lamps.
64	40 A	Driveline control module.
69	30 A	Front wiper motor.
70	10 A	Onboard diagnostics connector.
71	15 A	Rear wiper motor.
72	20 A	Not used (spare).
79	5 A	Headlamp control module.
88	20 A	Rear blower motor.
91	20 A	Trailer tow lighting module.
95	15 A	Hybrid powertrain control module (FHEV only).

Fuses

Item	Fuse Rating	Protected Component
103	50 A	Cargo area power feed 2 (police).
104	50 A	Cargo area power feed 1 (police).
106	40 A	Police 6-way inline power feed 2.
107	40 A	Police 6-way inline power feed 1.
108	20 A	Police spot lamps.
111	30 A	Body control module feed 4.
114	50 A	Not used (spare).
115	20 A	Audio amplifier power feed 1. Police tap-in power feed 2.
116	5 A	Start signal - police tap-in.
118	30 A	Rear heated seats.
	20 A	Run-start power 2 - police tap-in.
120	15 A	Fuel injectors.
124	5 A	Rain sensors. Not used (police).
125	5 A	Not used (spare).
127	20 A	Audio amplifier power feed 2. Police tap-in power feed 1.
128	5 A	Not used (spare).
131	40 A	Power folding seats. Not used (police).
133	15 A	Not used (spare).
139	5 A	USB power outlet - back of console. Not used (police).

Fuses

Item	Fuse Rating	Protected Component
140	5 A	USB power outlet - main bin. Not used (police).
141	5 A	USB power outlet - third row. USB power outlet - cargo area (police).
144	15 A	Not used (spare).
146	5 A	Hybrid battery energy control module (FHEV only).
148	30 A	Left LED headlamp.
149	30 A	Right LED headlamp.
150	40 A	Police 6-way inline power feed 3.
155	25 A	Transmission oil pump (FHEV only).
159	15 A	DC/DC converter (police).
160	10 A	Police tap-in power feed 3.
169	10 A	Motor electric cooling pump (FHEV only).
170	10 A	Traction battery cooling pump (FHEV only).
177	10 A	Not used (spare).

Fuses

INTERIOR FUSE BOX

LOCATING THE INTERIOR FUSE BOX

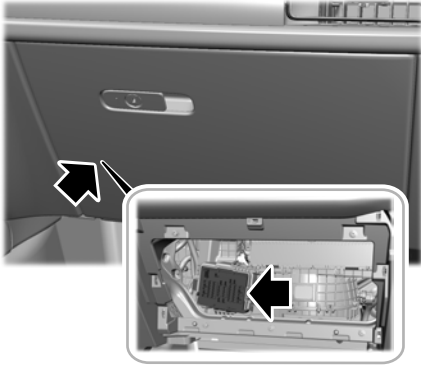

ACCESSING THE INTERIOR FUSE BOX

1. Open the glove compartment.

2. Push the tabs inward to release the detent and fully lower the glove compartment.

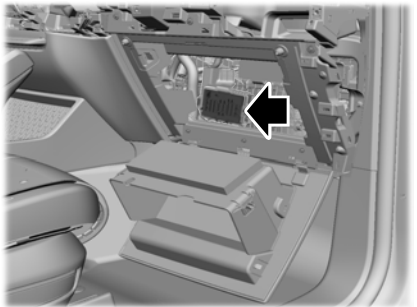
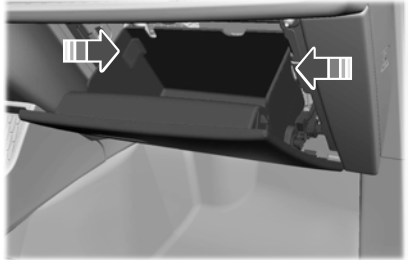

Fuses

IDENTIFYING THE FUSES IN THE INTERIOR FUSE BOX

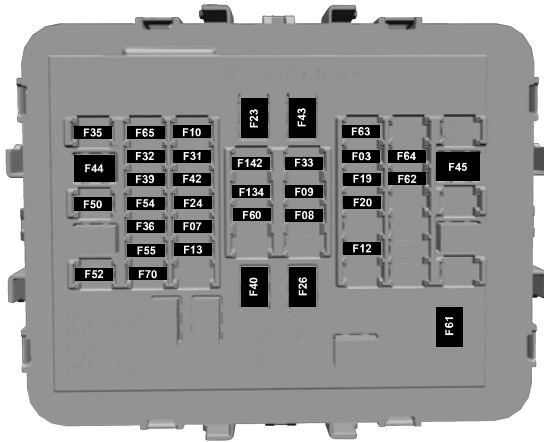

Item	Fuse Rating	Protected Component
3	7.5 A	Wireless accessory charging module. Driver seat switch. Lumbar motor.
7	7.5 A	Gear shift module. Not used (police).
8	7.5 A	Embedded modem.
9	5 A	Driver keypad. Rear climate control module.
10	15 A	Driver multi-contour seat module. Passenger multi-contour seat module. Not used (police).
12	5 A	Climate control module.
13	7.5 A	Steering column control module.

Fuses

Item	Fuse Rating	Protected Component
19	7.5 A	Not used (spare).
20	5 A	Headlamp switch. Ignition switch (police). Key inhibit solenoid (police).
23	60 A	Driver door module.
24	30 A	Glass roof. Not used (police).
26	60 A	Passenger door module.
31	10 A	Terrain management switch. Enhanced central gateway. Radio transceiver module.
32	20 A	Radio.
33	7.5 A	Instrument cluster.
35	15 A	Center display. Integrated computer screen (police).
36	5 A	Not used (spare).
39	5 A	Power liftgate module. Driver status monitor camera. Not used (police).
40	60 A	Not used (spare).
42	15 A	Phoenix module. Not used (spare). Integrated control panel.
43	30 A	Power liftgate module. Not used (police).
44	30 A	Driver seat motors.
45	30 A	Passenger seat motors.
50	10 A	Rear wig-wag module (police).
52	5 A	All wheel drive module.
54	5 A	Low gear select (police).

Fuses

Item	Fuse Rating	Protected Component
55	5 A	Auto dimming rear view mirror. Not used (police).
60	10 A	Glass roof. Power inverter. Police tap-in (delayed accessory).
61	30 A	Rear power windows.
62	20 A	Not used (spare).
63	20 A	Not used (spare).
64	20 A	Not used (spare).
65	20 A	Not used (spare).
70	20 A	Advanced driver assistance system.
134	10 A	Not used (spare).
142	5 A	Not used (spare).

IDENTIFYING FUSE TYPES

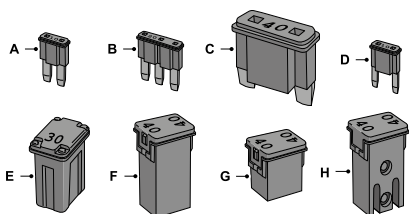

- A Micro 2.
- B Micro 3.
- C Maxi.
- D Mini.
- E M Case.

- F J Case.
- G J Case Low Profile.
- H Slotted M Case.

FUSES – TROUBLESHOOTING

FUSES – FREQUENTLY ASKED QUESTIONS

When do I need to check a fuse?

- If electrical components in the vehicle are not working.

When do I need to replace a fuse?

- If a fuse has blown.

Fuses

How do I identify a blown fuse?

- You can identify a blown fuse by a broken wire within the fuse.

Maintenance

MAINTENANCE PRECAUTIONS

Service your vehicle regularly to help maintain its roadworthiness and resale value. There is a large network of authorized dealers that are there to help you with their professional servicing expertise. We believe that their specially trained technicians are best qualified to service your vehicle properly and expertly. They are supported by a wide range of highly specialized tools developed specifically for servicing your vehicle.

If your vehicle requires professional service, an authorized dealer can provide the necessary parts and service. Check your warranty information to find out which parts and services are covered.

Use only recommended fuels, lubricants, fluids and service parts conforming to specifications. See **Vehicle Specifications** (page 394).

- Do not work on a hot engine.
- Make sure that nothing gets caught in moving parts.
- Do not work on a vehicle with the engine running in an enclosed space, unless you are sure you have enough ventilation.
- Keep all open flames and other burning material, such as cigarettes, away from the battery and all fuel related parts.
- Set the parking brake, shift the transmission to park (P) and block the wheels.

OPENING AND CLOSING THE HOOD

Opening the Hood

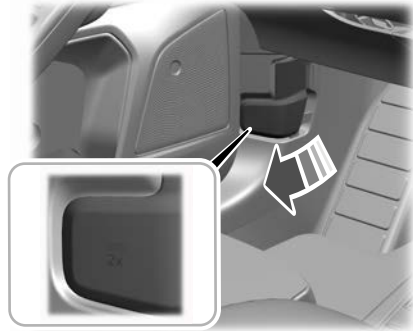

1. Open the driver door.
2. Fully pull the hood release lever and let it completely retract.
3. Fully pull the hood release lever for a second time.

Note: *This action releases the hood latch.*

Note: *This action fully releases the hood.*

4. Open the hood.

Note: *There is no secondary latch under the hood.*

Maintenance

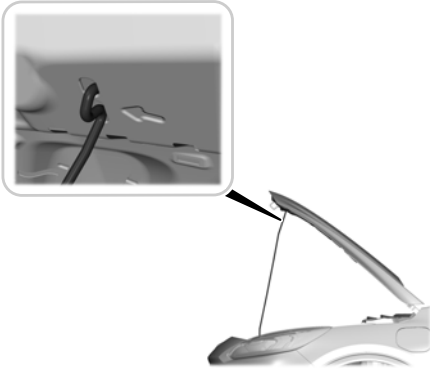

5. Support the hood with the prop rod.

Closing the Hood

 **WARNING:** Make sure that you fully latch the hood before driving. Failure to follow this instruction could result in personal injury or death.

1. Remove the prop rod from the catch and secure it correctly in the clip.
2. Lower the hood and allow it to drop under its own weight for the last 10–14 in (25–35 cm).

Note: Make sure that the hood is correctly closed.

Warning Lamps and Indicators

Hood Ajar



It illuminates when the ignition is on and the hood is not completely closed.

Maintenance

UNDER HOOD OVERVIEW - 2.3L

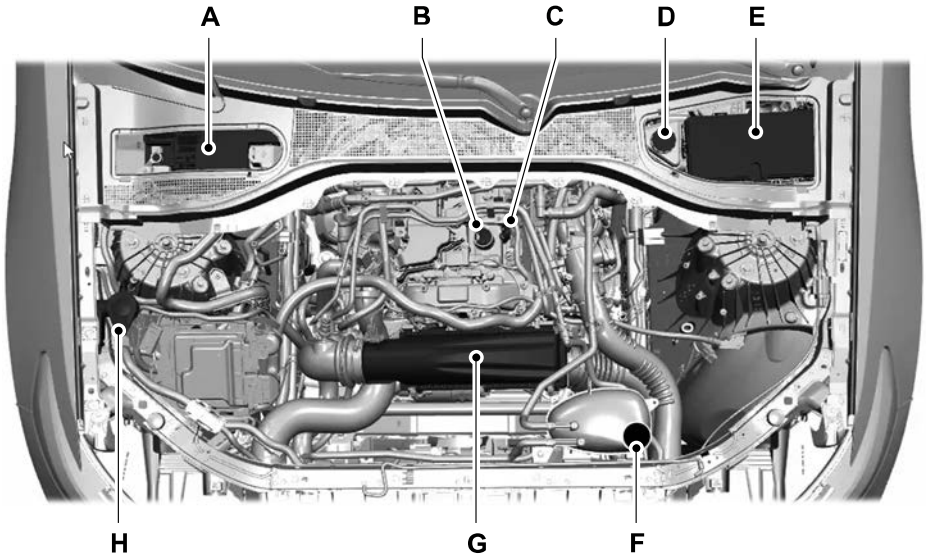

- A Battery. See **Changing the 12V Battery** (page 387).
- B Engine oil filler cap. See **Checking the Engine Oil Level** (page 369).
- C Engine oil dipstick. See **Engine Oil Dipstick Overview** (page 369).
- D Brake fluid reservoir. See **Checking the Brake Fluid** (page 228).
- E Engine compartment fuse box. See **Fuse Precautions** (page 353).
- F Engine coolant reservoir. See **Checking the Coolant Level** (page 379).
- G Air filter assembly. See **Changing the Engine Air Filter** (page 376).
- H Windshield washer fluid reservoir. See **Adding Washer Fluid** (page 110).

Maintenance

UNDER HOOD OVERVIEW - 3.0L

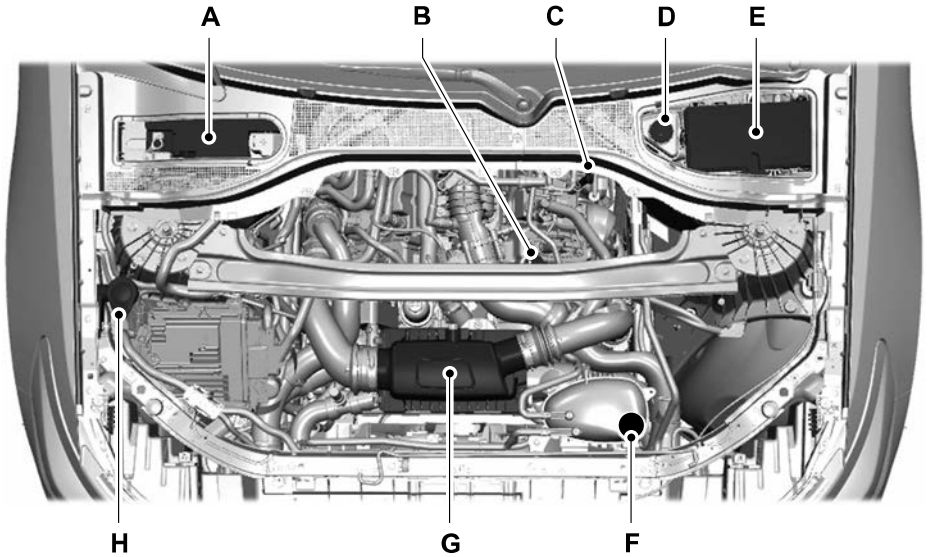

- A Battery. See **Changing the 12V Battery** (page 387).
- B Engine oil filler cap. See **Checking the Engine Oil Level** (page 369).
- C Engine oil dipstick. See **Engine Oil Dipstick Overview** (page 369).
- D Brake fluid reservoir. See **Checking the Brake Fluid** (page 228).
- E Engine compartment fuse box. See **Opening and Closing the Hood** (page 364).
- F Engine coolant reservoir. See **Checking the Coolant Level** (page 379).
- G Air filter assembly. See **Changing the Engine Air Filter** (page 377).
- H Washer fluid reservoir. See **Adding Washer Fluid** (page 110).

Maintenance

UNDER HOOD OVERVIEW - 3.3L

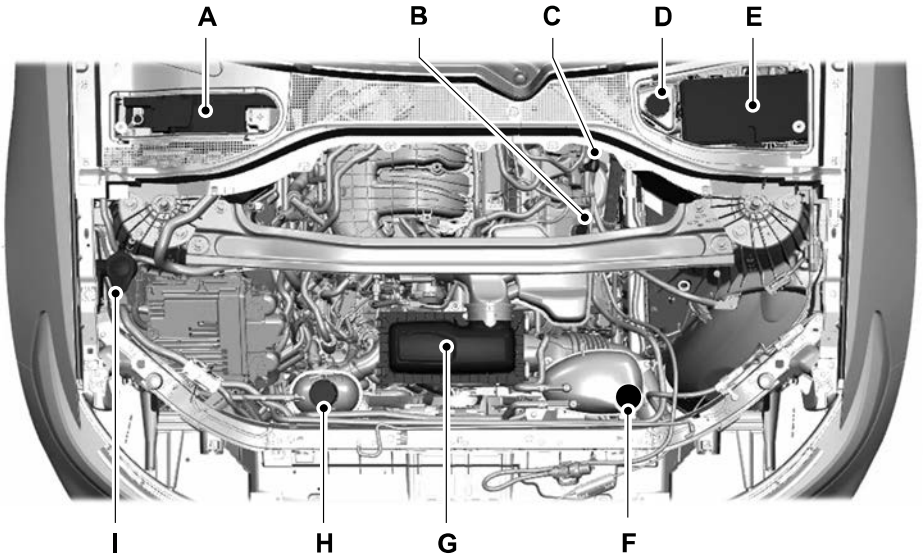

- A Battery. See **Changing the 12V Battery** (page 388).
- B Engine oil filler cap. See **Checking the Engine Oil Level** (page 369).
- C Engine oil dipstick. See **Engine Oil Dipstick Overview** (page 369).
- D Brake fluid reservoir. See **Checking the Brake Fluid** (page 228).
- E Engine compartment fuse box. See **Fuses** (page 353).
- F Engine coolant reservoir cap. See **Checking the Coolant Level** (page 379).
- G Air filter assembly. See **Changing the Engine Air Filter** (page 376).
- H Inverter system controller coolant reservoir cap - HEV only.
- I Washer fluid reservoir. See **Adding Washer Fluid** (page 110).

Maintenance

ENGINE OIL

ENGINE OIL DIPSTICK OVERVIEW - 2.3L

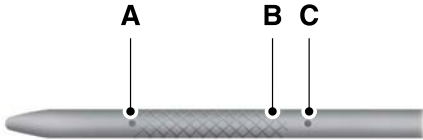

- A Minimum.
- B Nominal.
- C Maximum

ENGINE OIL DIPSTICK OVERVIEW - 3.0L

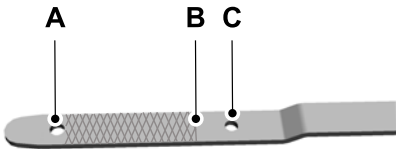

- A Minimum.
- B Nominal.
- C Maximum.

ENGINE OIL DIPSTICK OVERVIEW - 3.3L

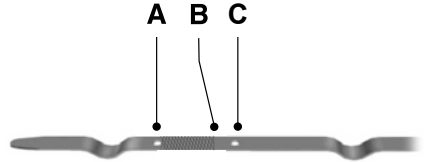

- A Minimum.
- B Nominal.
- C Maximum.

CHECKING THE ENGINE OIL LEVEL

1. Make sure that your vehicle is on level ground.
2. Check the oil level before starting the engine, or switch the engine off after warm up and wait 15 minutes for the oil to drain into the oil pan.

Note: *Checking the oil level too soon could result in an inaccurate reading.*

3. Remove the dipstick and wipe it with a clean, lint-free cloth.
4. Reinstall the dipstick and make sure it is fully seated.
5. Remove the dipstick again to check the oil level.

Note: *Read both sides of the dipstick and use the lowest oil level as the correct reading.*

Note: *If the oil level is between the maximum and minimum marks, the oil level is acceptable. Do not add oil.*

Maintenance

- If the oil level is at the minimum mark, immediately add oil.
- Reinstall the dipstick. Make sure it is fully seated.

Note: *The oil consumption of new engines reaches its normal level after approximately 3,000 mi (5,000 km).*

Note: *Increases in oil level can occur from frequent short trips that do not allow the engine to get to operating temperature, as well as frequent idling or low speed driving for long periods of time.*

Note: *If oil levels are continuously noted above the maximum mark, have your vehicle checked as soon as possible.*

ADDING ENGINE OIL



WARNING: Do not remove the filler cap when the engine is running.



WARNING: Do not add engine oil when the engine is hot. Failure to follow this instruction could result in personal injury.

Do not use supplemental engine oil additives because they are unnecessary and could lead to engine damage that the vehicle warranty may not cover.

- Clean the area surrounding the engine oil filler cap before you remove it.
- Remove the engine oil filler cap.
- Add engine oil that meets our specifications. See **Engine Oil** (page 374).
- Reinstall the engine oil filler cap. Turn it clockwise until you feel a strong resistance.

Note: *Do not add oil further than the maximum mark. Oil levels above the maximum mark may cause engine damage.*

Note: *Immediately soak up any oil spillage with an absorbent cloth.*

INTELLIGENT OIL LIFE MONITOR

Under certain conditions the vehicle's intelligent oil life monitor may determine your oil requires replacement prior to your general service. Should this occur it is recommended you replace your oil within two weeks or 500 mi (800 km) of being alerted.

Your authorized dealer will be able to advise you whether only an engine oil and filter change is recommended or whether you should complete your general service inclusive of oil and oil filter.

RESETTING THE INTELLIGENT OIL LIFE MONITOR

- Press **Settings** on the touchscreen.
- Select **Vehicle Maintenance**.
- Select **Oil Life**.
- Press and hold the **OK** button until the system reset confirmation appears.

ENGINE OIL CAPACITY AND SPECIFICATION - 2.3L

Use oil that meets the defined specification and viscosity grade.

If you do not use oil that meets the defined specification and viscosity grade, it could result in:

- Component damage that your vehicle warranty does not cover.
- Longer engine cranking periods.
- Increased emission levels.
- Reduced vehicle performance.
- Reduced fuel economy.

Maintenance



An oil that displays this symbol conforms to current engine, emission system and fuel economy performance standards of ILSAC.

We recommend Motorcraft motor oil for your vehicle. If Motorcraft oil is not available, use motor oils of the recommended viscosity grade that display the API Certification Mark for gasoline engines.

Do not use supplemental engine oil additives because they are unnecessary and could lead to engine damage that your vehicle warranty does not cover.

Capacities

Variant	Including the Oil Filter
All.	5 qt (4.8 L)

Materials

Name	Specification
Motorcraft® SAE 5W-30 Motor Oil (U.S.) Motorcraft® SAE 5W-30 Motor Oil / Huile moteur SAE 5W-30 Motorcraft® (Canada) XO-5W30-Q1SP, XO-5W30-Q1FS (U.S.) CXO-5W30-LSP6, CXO-5W30-LFS6 (Canada)	WSS-M2C971-A1

Alternative Engine Oil for Extremely Cold Climates

To improve engine cold start performance, we recommend that you use the following alternative engine oil in extremely cold climates, where the ambient temperature reaches -22.0°F (-30°C) or below.

Materials

Name	Specification
Engine Oil - SAE 0W-30	WSS-M2C973-A1

Maintenance

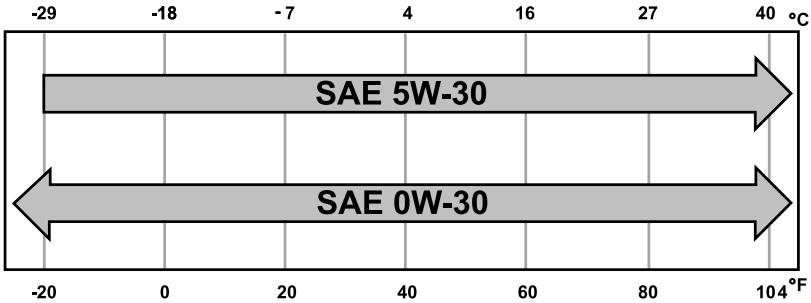

Note: If you use your vehicle regularly above the altitude of 5,000 ft (1,524 m) and under the temperature of -4.0°F (-20°C), it is recommended to use the alternative engine oil.

ENGINE OIL CAPACITY AND SPECIFICATION - 3.0L

Use oil that meets the defined specification and viscosity grade.

If you do not use oil that meets the defined specification and viscosity grade, it could result in:

- Component damage that your vehicle warranty does not cover.
- Longer engine cranking periods.
- Increased emission levels.
- Reduced vehicle performance.
- Reduced fuel economy.



An oil that displays this symbol conforms to current engine, emission system and fuel economy performance standards of ILSAC.

We recommend Motorcraft motor oil for your vehicle. If Motorcraft oil is not available, use motor oils of the recommended viscosity grade that display the API Certification Mark for gasoline engines.

Do not use supplemental engine oil additives because they are unnecessary and could lead to engine damage that your vehicle warranty does not cover.

Maintenance

Capacities

Variant	Including the Oil Filter
All.	6.0 qt (5.7 L)

Materials

Name	Specification
Motorcraft® SAE 5W-30 Motor Oil(U.S.) Motorcraft® SAE 5W-30 Motor Oil / Huile moteur SAE 5W-30 Motorcraft®(Canada) XO-5W30-Q1SP, XO-5W30-Q1FS(U.S.) CXO-5W30-LSP6, CXO-5W30-LFS6(Canada)	WSS-M2C971-A1

Alternative Engine Oil for Extremely Cold Climates

To improve engine cold start performance, we recommend that you use the following alternative engine oil in extremely cold climates, where the ambient temperature reaches -22.0°F (-30°C) or below.

Materials

Name	Specification
Engine Oil - SAE 0W-30	WSS-M2C973-A1

Maintenance

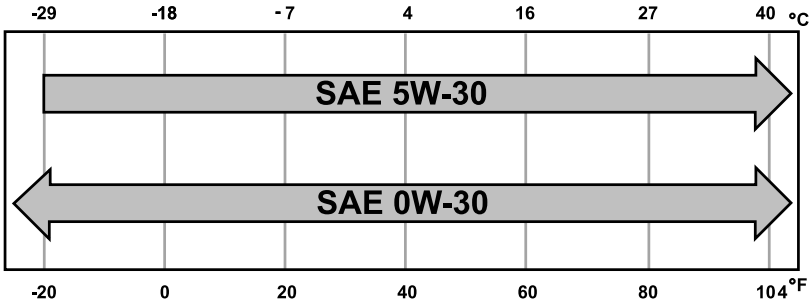

Note: If you use your vehicle regularly above the altitude of 5,000 ft (1,524 m) and under the temperature of -4.0°F (-20°C), it is recommended to use the alternative engine oil.

ENGINE OIL CAPACITY AND SPECIFICATION - 3.3L

Use oil that meets the defined specification and viscosity grade.

If you do not use oil that meets the defined specification and viscosity grade, it could result in:

- Component damage that your vehicle warranty does not cover.
- Longer engine cranking periods.
- Increased emission levels.
- Reduced vehicle performance.
- Reduced fuel economy.



An oil that displays this symbol conforms to current engine, emission system and fuel economy performance standards of ILSAC.

We recommend Motorcraft® motor oil for your vehicle. If Motorcraft® oil is not available, use motor oils of the recommended viscosity grade that display the API Certification Mark for gasoline engines.

Do not use supplemental engine oil additives because they are unnecessary and could lead to engine damage that your vehicle warranty does not cover.

Maintenance

Capacities

Variant	Including the Oil Filter
All.	6.0 qt (5.7 L)

Materials

Name	Specification
Motorcraft® SAE 5W-30 Motor Oil (U.S.) Motorcraft® SAE 5W-30 Motor Oil / Huile moteur SAE 5W-30 Motorcraft® (Canada) XO-5W30-Q1SP, XO-5W30-Q1FS (U.S.) CXO-5W30-LSP6, CXO-5W30-LFS6 (Canada)	WSS-M2C971-A1

Alternative Engine Oil for Extremely Cold Climates

To improve engine cold start performance, use the following engine oil in climates where the ambient temperature reaches -22.0°F (-30°C) or below.

Materials

Name	Specification
Engine Oil - SAE 0W-30	WSS-M2C973-A1

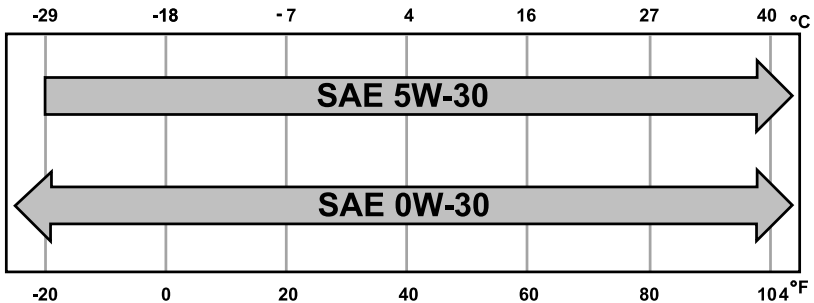

Maintenance

Note: If you use your vehicle regularly above the altitude of 5,000 ft (1,524 m) and under the temperature of -4.0°F (-20°C), it is recommended to use the alternative engine oil.

ENGINE AIR FILTER

CHANGING THE ENGINE AIR FILTER - 2.3L



WARNING: To reduce the risk of vehicle damage and personal burn injuries, do not start your engine with the air cleaner removed and do not remove it while the engine is running.

When changing the engine air filter, do not allow debris or foreign material to enter the air induction system. Engine components are susceptible to damage not covered by the vehicle warranty.

Change the air filter element at the correct interval. See **General Maintenance Information** (page 492).

Incorrect component use can cause damage not covered by the vehicle warranty.

To replace the air filter element do the following:

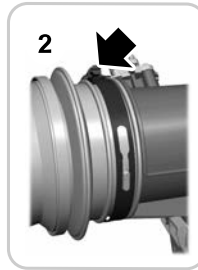
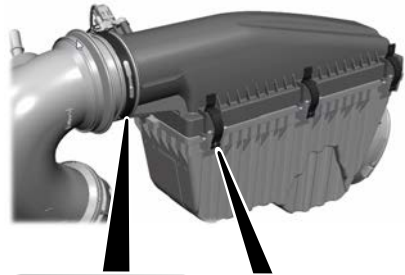

1. Remove the clips that secure the air filter housing cover.
2. Using a screwdriver, loosen the clamp of the air filter housing cover.
3. Gently pull the boot back away from the air filter housing cover.
4. Carefully lift the air filter housing cover from the air filter housing assembly.
5. Remove the air filter element from the air filter housing.
6. Wipe any dirt or debris from the air filter housing and cover to make sure no dirt gets in the engine and that you have a good seal.

Maintenance

7. Install a new air filter element. Be careful not to crimp the filter element edges between the air filter housing and cover. This could cause filter damage and allow unfiltered air to enter the engine if it is not properly seated.
8. Install the air filter housing cover.
9. Engage the clips to secure the air filter housing cover to the air filter housing.
10. Reconnect the boot on the air filter housing cover and torque to 3.54 lb.ft (4.8 Nm).

CHANGING THE ENGINE AIR FILTER - 3.0L



WARNING: To reduce the risk of vehicle damage and personal burn injuries, do not start your engine with the air cleaner removed and do not remove it while the engine is running.

When changing the engine air filter, do not allow debris or foreign material to enter the air induction system. Engine components are susceptible to damage not covered by the vehicle Warranty.

Incorrect component use can cause damage not covered by the vehicle Warranty.

To replace the air filter element do the following:

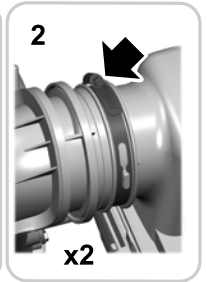
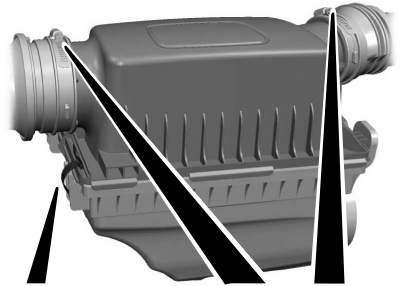

1. Remove the clips that secure the air filter housing cover.
2. Using a screwdriver, loosen two clamps on either side of the air filter housing cover.
3. Gently pull the two boots back away from the air filter housing cover.
4. Carefully lift the air filter housing cover.
5. Remove the air filter element from the air filter housing.
6. Wipe any dirt or debris from the air filter housing and cover to make sure no dirt gets in the engine and that you have a good seal.

Maintenance

7. Install a new air filter element. Be careful not to crimp the filter element edges between the air filter housing and cover. This could cause filter damage and allow unfiltered air to enter the engine if it is not properly seated.
8. Install the air filter housing cover.
9. Engage the clips to secure the air filter housing cover to the air filter housing.
10. Reconnect the two boots on the air filter housing cover and torque to 3.69 lb.ft (5 Nm).

CHANGING THE ENGINE AIR FILTER - 3.3L



WARNING: To reduce the risk of vehicle damage and personal burn injuries, do not start your engine with the air cleaner removed and do not remove it while the engine is running.

Note: Failure to use the correct air filter element may result in severe engine damage. Resulting component damage may not be covered by the vehicle Warranty.

Note: When servicing the air cleaner, do not allow foreign material to enter the air induction system. The engine is susceptible to damage from even small particles.

When changing the air filter element, use only the air filter element listed. See **Vehicle Specifications** (page 394).

Change the air filter element at the proper intervals. See **Scheduled Maintenance** (page 488).

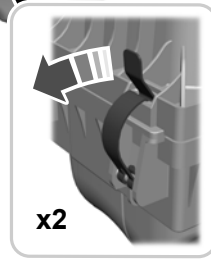
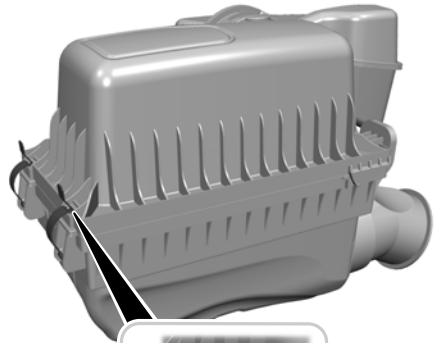

1. Release the clamps that secure the air filter cover to the housing.
2. Using a screwdriver, loosen the clamp on the air filter housing cover.
3. Gently pull the boot back away from the air filter housing cover.
4. Carefully lift the air filter housing cover.
5. Remove the air filter element from the air filter housing.
6. Wipe any dirt or debris from the air filter housing and cover to make sure no dirt gets in the engine and that you have a good seal.
7. Install a new air filter element. Be careful not to crimp the filter element edges between the air filter housing and cover. This could cause filter damage and allow unfiltered air to enter the engine if it is not properly seated.

Maintenance

8. Install the air filter housing cover.
9. Engage the clips to secure the air filter housing cover to the air filter housing.
10. Reconnect the boot to the air filter housing cover and torque to 3.69 lb.ft (5 Nm).

COOLANT

CHECKING THE COOLANT LEVEL



WARNING: Do not remove the coolant reservoir cap when the engine is on or the cooling system is hot. Wait 10 minutes for the cooling system to cool down. Cover the coolant reservoir cap with a thick cloth to prevent the possibility of scalding and slowly remove the cap. Failure to follow this instruction could result in personal injury.



WARNING: To reduce the risk of personal injury, make sure the engine is cool before unscrewing the coolant pressure relief cap. The cooling system is under pressure. Steam and hot liquid can come out forcefully when you loosen the cap slightly.

When the engine is cold, check the concentration and level of the coolant at the intervals listed in the scheduled maintenance information. See **Scheduled Maintenance** (page 488).

Note: Make sure that the coolant level is between the **MIN** and the **MAX** marks on the coolant reservoir.

Note: Coolant expands when it is hot. The level may extend beyond the **MAX** mark. This is normal.

Maintain coolant concentration within 48% to 50%, which equates to a freeze point between -29°F (-34°C) and -35°F (-37°C). Coolant concentration should be checked using a refractometer. We do not recommend the use of hydrometers or coolant test strips for measuring coolant concentration.

ADDING COOLANT



WARNING: Do not add coolant when the vehicle is on or the cooling system is hot. Failure to follow this instruction could result in personal injury.



WARNING: Do not remove the coolant reservoir cap when the engine is on or the cooling system is hot. Wait 10 minutes for the cooling system to cool down. Cover the coolant reservoir cap with a thick cloth to prevent the possibility of scalding and slowly remove the cap. Failure to follow this instruction could result in personal injury.



WARNING: Do not allow the fluid to touch your skin or eyes. If this happens, rinse the affected areas immediately with plenty of water and contact your physician.



WARNING: Do not put coolant in the windshield washer reservoir. If sprayed on the windshield, coolant could make it difficult to see through the windshield.



WARNING: Do not add coolant further than the **MAX** mark.

Maintenance

Note: Do not use stop leak pellets, cooling system sealants, or non-specified additives as they can cause damage to the engine cooling or heating systems. Resulting component damage may not be covered by the vehicle Warranty.

Note: Automotive fluids are not interchangeable.

It is very important to use prediluted coolant approved to the correct specification in order to avoid plugging the small passageways in the engine cooling system. See **Coolant** (page 381). Do not mix different colors or types of coolant in your vehicle. Mixing of engine coolants or using an incorrect coolant may harm the engine or cooling system components and may not be covered by the vehicle Warranty.

Note: If prediluted coolant is not available, use the approved concentrated coolant diluting it to 50/50 with deionised or distilled water. See **Coolant** (page 381). Using water that has not been deionised may contribute to deposit formation, corrosion and plugging of the small cooling system passageways.

Note: Coolants marketed for all makes and models may not be approved to our specifications and may cause damage to the cooling system. Resulting component damage may not be covered by the vehicle Warranty.

If the coolant level is at or below the minimum mark, add prediluted coolant immediately.

To top up the coolant level do the following:

1. Unscrew the cap slowly. Any pressure escapes as you unscrew the cap.
2. Add prediluted coolant approved to the correct specification. See **Coolant** (page 381).

3. Add enough prediluted coolant to reach the correct level.
4. Replace the coolant reservoir cap. Turn the cap clockwise until it contacts the hard stop.
5. Check the coolant level in the coolant reservoir the next few times you drive your vehicle. If necessary, add enough prediluted engine coolant to bring the coolant level to the correct level.

If you have to add more than 1.1 qt (1 L) of engine coolant per month, have your vehicle checked as soon as possible. Operating an engine with a low level of coolant can result in engine overheating and possible engine damage.

In case of emergency, you can add a large amount of water without engine coolant in order to reach a vehicle service location.

Water alone, without engine coolant, can cause engine damage from corrosion, overheating or freezing.

Do not use the following as a coolant substitute:

- Alcohol.
- Methanol.
- Brine.
- Any coolant mixed with alcohol or methanol antifreeze.

Alcohol and other liquids can cause engine damage from overheating or freezing.

Do not add extra inhibitors or additives to the coolant. These can be harmful and compromise the corrosion protection of the coolant.

CHANGING THE COOLANT

For coolant change, see your authorized dealer.

Maintenance

Changing the coolant is necessary at specific mileage intervals listed in the scheduled maintenance information. See **Scheduled Maintenance** (page 488).

MANAGING THE COOLANT TEMPERATURE

If you tow a trailer with your vehicle, the engine may temporarily reach a higher temperature during severe operating conditions, for example ascending a long or steep grade in high ambient temperatures.

At this time, you may notice the coolant temperature gauge moves toward the red zone and a message may appear in the information display.



WARNING: To reduce the risk of crash and injury, be prepared that the vehicle speed may reduce and the vehicle may not be able to accelerate with full power until the coolant temperature reduces.



WARNING: If you continue to drive your vehicle when the engine is overheating, the engine could stop without warning. Failure to follow this instruction could result in the loss of control of your vehicle.

You may notice a reduction in vehicle speed caused by reduced engine power in order to manage the engine coolant temperature. Your vehicle may enter this mode if certain high-temperature and high-load conditions take place. The amount of speed reduction depends on vehicle loading, grade and outside temperature. If this occurs, there is no need to stop your vehicle. You can continue to drive. See **Fail-Safe Cooling** (page 350).

The air conditioning may automatically turn on and off during severe operating conditions to protect the engine from overheating. When the coolant temperature decreases to the normal operating temperature, the air conditioning turns on.

If the coolant temperature gauge moves fully into the red zone, or if the coolant temperature warning or service engine soon messages appear in your information display, do the following:

1. Stop your vehicle as soon as it is safe to do so. Fully apply the parking brake, shift into park (P) or neutral (N).
2. Leave the engine running until the coolant temperature gauge needle returns to the normal position. If the temperature does not drop after several minutes, follow the remaining steps.
3. Switch the engine off and wait for it to cool. Check the coolant level.
4. If the coolant level is at or below the minimum mark, add prediluted coolant immediately.
5. If the coolant level is normal, restart the engine and continue.

COOLING SYSTEM CAPACITY AND SPECIFICATION - 2.3L

Use coolant that meets the defined specification.

If you do not use coolant that meets the defined specification, it could result in:

- Component damage that your vehicle warranty does not cover.
- Reduced vehicle performance.

Maintenance

Capacities

Variant	Quantity
All.	14.3 qt (13.5 L)

Materials

Name	Specification
Motorcraft® Yellow Prediluted Antifreeze/ Coolant(U.S.) Motorcraft® Yellow Prediluted Antifreeze/Coolant / Antigel/liquide de refroidissement prédilué jaune Motorcraft®(Canada) VC-13DL-G(U.S.) CVC-13DL-G(Canada)	WSS-M97B57-A2

Note: *Yellow coolant may become darker over time. This is normal.*

If you do not use coolant that meets the defined specification, it could result in:

- Component damage that your vehicle warranty does not cover.
- Reduced vehicle performance.

COOLING SYSTEM CAPACITY AND SPECIFICATION - 3.0L

Use coolant that meets the defined specification.

Capacities

Variant	Quantity
With rear heat.	18.0 qt (17 L)
Without rear heat.	15.5 qt (14.7 L)

Materials

Name	Specification
Motorcraft® Yellow Prediluted Antifreeze/ Coolant(U.S.) Motorcraft® Yellow Prediluted Antifreeze/Coolant / Antigel/liquide de refroidissement prédilué jaune Motorcraft®(Canada) VC-13DL-G(U.S.) CVC-13DL-G(Canada)	WSS-M97B57-A2

Maintenance

Note: *Yellow coolant may become darker over time. This is normal.*

If you do not use coolant that meets the defined specification, it could result in:

COOLING SYSTEM CAPACITY AND SPECIFICATION - 3.3L

- Component damage that your vehicle warranty does not cover.
- Reduced vehicle performance.

Use coolant that meets the defined specification.

Capacities

Variant	Quantity
With rear heat.	15.2 qt (14.4 L)
Without rear heat.	12.9 qt (12.2 L)

Materials

Name	Specification
Motorcraft® Yellow Prediluted Antifreeze/Coolant (U.S.) Motorcraft® Yellow Prediluted Antifreeze/Coolant / Antigel/liquide de refroidissement prédilué jaune Motorcraft® (Canada) VC-13DL-G (U.S.) CVC-13DL-G (Canada)	WSS-M97B57-A2

Note: *Yellow coolant may become darker over time. This is normal.*



A warning lamp illuminates and a message may appear in the information display.

COOLANT – WARNING LAMPS



If the engine begins to overheat, the coolant temperature gauge moves toward the red zone.

Maintenance

COOLANT – INFORMATION MESSAGES

Message	Description and Action
High engine temperature Stop safely	Displays when the engine temperature is too high. Stop your vehicle as soon as it is safe to do so, switch the engine off and allow it to cool. If the problem persists, have your vehicle checked as soon as possible. See Checking the Coolant Level (page 379).

CHANGING THE FUEL FILTER

Your vehicle has a lifetime fuel filter that integrates with the fuel tank. It does not need regular maintenance or replacement.

DRIVE BELT ROUTING OVERVIEW - 2.3L

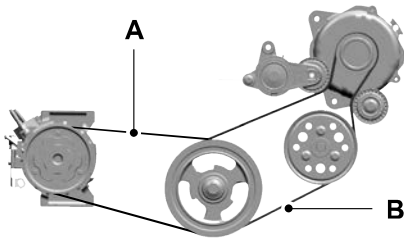

- A Short drive belt is on the second pulley groove farthest from engine.
- B Long drive belt is on the first pulley groove closest to engine.

DRIVE BELT ROUTING OVERVIEW - 3.0L

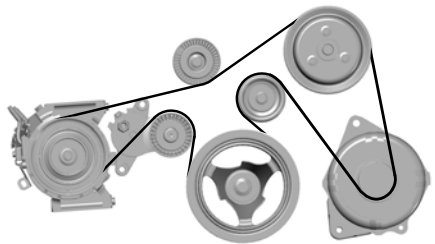

Maintenance

DRIVE BELT ROUTING OVERVIEW - 3.3L, GASOLINE

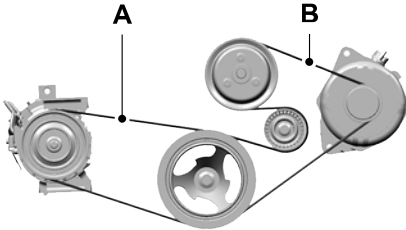

- A Short drive belt is on the first pulley groove closest to engine.
- B Long drive belt is on the second pulley groove farthest from engine.

DRIVE BELT ROUTING OVERVIEW - 3.3L, HYBRID ELECTRIC VEHICLE (HEV)

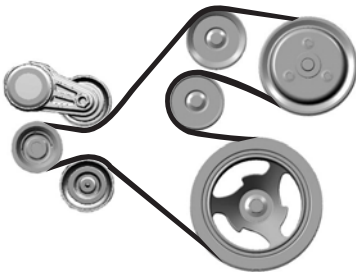

12V BATTERY

12V BATTERY PRECAUTIONS

WARNING: Batteries normally produce explosive gases which can cause personal injury. Therefore, do not allow flames, sparks or lighted substances to come near the battery. When working near the battery, always shield your face and protect your eyes. Always provide correct ventilation.

WARNING: When lifting a plastic-cased battery, excessive pressure on the end walls could cause acid to flow through the vent caps, resulting in personal injury and damage to the vehicle or battery. Lift the battery with a battery carrier or with your hands on opposite corners.

WARNING: Keep batteries out of reach of children. Batteries contain sulfuric acid. Avoid contact with skin, eyes or clothing. Shield your eyes when working near the battery to protect against possible splashing of acid solution. In case of acid contact with skin or eyes, flush immediately with water for a minimum of 15 minutes and get prompt medical attention. If acid is swallowed, call a physician immediately.

WARNING: Battery posts, terminals and related accessories contain lead and lead compounds, chemicals known to the State of California to cause cancer and reproductive harm. **Wash your hands after handling.**

Maintenance



WARNING: This vehicle may have more than one battery. Removing the battery cables from only one battery does not disconnect your vehicle electrical system. Make sure you disconnect the battery cables from all batteries when disconnecting power. Failure to do so may cause serious personal injury or property damage.



WARNING: For vehicles with Auto-Start-Stop the battery requirement is different. You must replace the battery with one of exactly the same specification.



WARNING: For vehicles equipped with a 12V battery vent tube, always properly reconnect the vent tube to the battery after disconnecting. Failure to follow this instruction could allow harmful gasses to enter the vehicle cabin, which could cause personal injury or death.

WHAT IS THE BATTERY MANAGEMENT SYSTEM

The battery management system monitors battery conditions and takes actions to extend battery life.

HOW DOES THE BATTERY MANAGEMENT SYSTEM WORK

If excessive battery drain is detected, the system temporarily disables some electrical systems to protect the battery.

Systems included are:

- Heated rear window.
- Heated seats.
- Climate control.
- Heated steering wheel.

- Audio unit.
- Navigation system.

A message could appear in the information display to alert you that battery protection actions are active. This message is only for notification that an action is taking place, and not intended to indicate an electrical problem or that the battery requires replacement.

BATTERY MANAGEMENT SYSTEM LIMITATIONS

After battery replacement, or in some cases after charging the battery with an external charger, the battery management system requires eight hours of vehicle sleep time to relearn the battery state of charge. During this time, your vehicle must remain fully locked with the ignition switched off.

Note: *Prior to relearning the battery state of charge, the battery management system could temporarily disable some electrical systems.*

Electrical Accessory Installation

To make sure the battery management system works correctly, do not connect an electrical device ground connection directly to the battery negative post. This can cause inaccurate measurements of the battery condition and potential incorrect system operation.

Note: *If you add electrical accessories or components to the vehicle, it could adversely affect battery performance and durability. This could also affect the performance of other electrical systems in the vehicle.*

Maintenance

CHANGING THE 12V BATTERY - EXCLUDING: HYBRID ELECTRIC VEHICLE (HEV)

The battery is in the engine compartment. See **Maintenance** (page 364).

Your vehicle has a maintenance-free battery. It does not require additional water during service.

Note: *There may be additional components that need to be removed or disconnected before you can safely remove the battery from your vehicle. For specific guidance on which components may need to be addressed, it is best to contact your dealer for detailed information.*

If the vehicle battery has a cover and vent hose, make sure you correctly install it after cleaning or replacing the battery.

For longer, trouble-free operation, keep the top of the battery clean and dry and the battery cables tightly fastened to the battery terminals. If any corrosion is present on the battery or terminals, remove the cables from the terminals and clean with a wire brush. You can neutralize the acid with a solution of baking soda and water.

We recommend that you disconnect the negative battery cable terminal from the battery if you plan to store your vehicle for an extended period.

Note: *If you only disconnect the negative battery cable terminal, make sure it is isolated or placed away from the battery terminal to avoid unintended connection or arcing.*

If you disconnect or replace the battery and your vehicle has an automatic transmission, it must relearn its adaptive strategy. Because of this, the transmission may shift firmly when first driven. This is normal operation while the transmission fully updates its operation to optimum shift feel.

Removing the Battery

1. Apply the parking brake and switch the ignition off.
2. Switch all electrical equipment off, for example lights and radio.
3. Wait a minimum of two minutes before disconnecting the battery.

Note: *The engine management system has a power hold function and remains powered for a period of time after you switch the ignition off. This is to allow diagnostic and adaptive tables to be stored. Disconnecting the battery without waiting can cause damage not covered by the vehicle Warranty.*

4. Disconnect and isolate the negative battery cable terminal.
5. Disconnect and isolate the positive battery cable terminal.
6. Remove the battery securing clamp.
7. Remove the battery.

If you disconnect or replace the vehicle battery, you must reset the following features:

- Window bounce-back. See **What Is Window Bounce-Back** (page 127).
- Clock Settings.
- Pre-set radio stations.

Replacing the Battery

Note: *Before reconnecting the battery, make sure the ignition remains switched off.*

You must replace the battery with one of exactly the same specification.

To install, reverse the removal procedure.

Note: *Make sure that you correctly install the battery cable terminals, battery terminal covers, vent hose, and battery cover.*

Maintenance

CHANGING THE 12V BATTERY - HYBRIDELECTRIC VEHICLE (HEV)

The primary battery is in the engine compartment. See **Under Hood Overview** (page 366).

The secondary battery is located behind the trim panel in the luggage compartment.

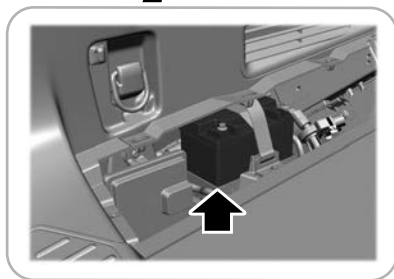
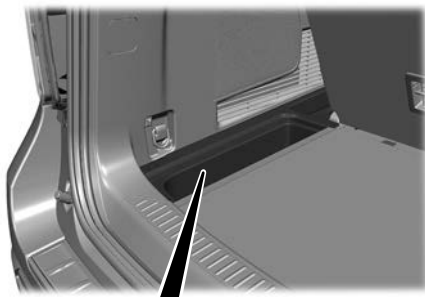

Your vehicle has a maintenance-free battery. It does not require additional water during service.

If the vehicle battery has a cover and vent hose, make sure you correctly install it after cleaning or replacing the battery.

For longer, trouble-free operation, keep the top of the battery clean and dry and the battery cables tightly fastened to the battery terminals. If any corrosion is present on the battery or terminals, remove the cables from the terminals and clean with a wire brush. You can neutralize the acid with a solution of baking soda and water.

We recommend that you disconnect the negative battery cable terminal from the battery if you plan to store your vehicle for an extended period.

Note: *If you only disconnect the negative battery cable terminal, make sure it is isolated or placed away from the battery terminal to avoid unintended connection or arcing.*

If you replace the battery make sure it matches the electrical requirements of your vehicle.

If you disconnect or replace the battery and your vehicle has an automatic transmission, it must relearn its adaptive strategy. Because of this, the transmission may shift firmly when first driven. This is normal operation while the transmission fully updates its operation to optimum shift feel.

Battery Sensor Reset

When you install a new battery, reset the battery sensor by doing the following:

1. Switch the ignition on, and leave the engine off.

Note: *Complete Steps 2 and 3 within 10 seconds.*

2. Flash the high beam headlamps five times, ending with the high beams off.
3. Press and release the brake pedal three times.

Maintenance

The battery warning lamp flashes three times to confirm that the reset is successful.

Battery Management System (if Equipped)

The system monitors battery conditions and takes actions to extend battery life. If excessive battery drain is detected, the system temporarily disables some electrical systems to protect the battery.

Systems included are:

- Heated rear window.
- Heated seats.
- Climate control.
- Heated steering wheel.
- Audio unit.
- Navigation system.

A message may appear in the information display to alert you that battery protection actions are active. This message is only for notification that an action is taking place, and not intended to indicate an electrical problem or that the battery requires replacement.

After battery replacement, or in some cases after charging the battery with an external charger, the battery management system requires eight hours of vehicle sleep time to relearn the battery state of charge. During this time, your vehicle must remain fully locked with the ignition switched off.

Note: *Prior to relearning the battery state of charge, the battery management system may temporarily disable some electrical systems.*

Electrical Accessory Installation

To make sure the battery management system works correctly, do not connect an electrical device ground connection directly to the battery negative post. This can cause inaccurate measurements of the battery condition and potential incorrect system operation.

Note: *If you add electrical accessories or components to the vehicle, it may adversely affect battery performance and durability. This may also affect the performance of other electrical systems in the vehicle.*

Remove and Reinstall the Battery

Install a battery approved for use by our specifications. See **Vehicle Specifications** (page 394).

To disconnect or remove the battery, do the following:

1. Apply the parking brake and switch the ignition off.
2. Switch all electrical equipment off, for example lights and radio.
3. Wait a minimum of two minutes before disconnecting the battery.

Note: *The engine management system has a power hold function and remains powered for a period of time after you switch the ignition off. This is to allow the system to store diagnostic and adaptive tables. Disconnecting the battery without waiting can cause damage not covered by the vehicle warranty.*

4. Disconnect the negative battery cable terminal.
5. Disconnect the positive battery cable terminal.
6. Remove the battery securing clamp.
7. Remove the battery.
8. To install, reverse the removal procedure.

Maintenance

Note: Before reconnecting the battery, make sure the ignition remains switched off.

Note: Make sure to fully tighten the battery cables.

If you disconnect or replace the vehicle battery, you must reset the following features:

- Window bounce-back. See **Opening and Closing the Windows** (page 126).
- Clock Settings.
- Pre-set radio stations.

Battery Disposal



Make sure that you dispose of old batteries in an environmentally friendly way.

Seek advice from your local authority about recycling old batteries.

RESETTING THE BATTERY SENSOR

When you install a new battery, reset the battery sensor by doing the following:

1. Switch the ignition on, and leave the engine off.

Note: Complete Steps 2 and 3 within 10 seconds.

2. Flash the high beam headlamps five times, ending with the high beams off.
3. Press and release the brake pedal three times.

The battery warning lamp flashes three times to confirm that the reset is successful.

RECYCLING AND DISPOSING OF THE 12V BATTERY



Make sure that you dispose of old batteries in an environmentally friendly way.

Seek advice from your local authority about recycling old batteries.

12V BATTERY – TROUBLESHOOTING

12V BATTERY – WARNING LAMPS



If it illuminates while driving, it indicates a charging system error. Switch off all unnecessary electrical equipment and have your vehicle immediately checked.

Maintenance

12V BATTERY – INFORMATION MESSAGES

Message	Details
Electrical system fault Service soon Steering and brake assist limited	The charging system needs servicing. If the warning stays on or continues to come on, have your vehicle checked as soon as possible. ¹
Electrical system fault Service now Steering and brake assist limited	The charging system needs servicing. Have your vehicle immediately checked. ¹
Turn power off to save battery	The battery management system determines that the battery is at a low state of charge. Turn the ignition off as soon as possible to protect the battery. The system clears this message once you start your vehicle and the battery state of charge recovers. Turning off unnecessary electrical loads allows for a faster battery state-of-charge recovery.
Electrical power saver active Some features turned off See manual	Displays when the battery management system detects an extended low-voltage condition. The system disables various vehicle features to help preserve the battery. Turn off as many of the electrical loads as soon as possible to improve system voltage. If the system voltage recovers, the disabled features will operate again as normal. ¹
12V battery low Charge by driving Steering and brake assist limited	The battery management system determines that the 12V battery is at a low state of charge. Start the engine to charge the battery or charge the battery using an aftermarket battery charger. Always use the vehicle ground point when connecting the negative cable of the external battery charger. See Jump Starting the Vehicle (page 346). This message clears once you restart your vehicle and the battery state of charge has recovered. Do not switch on the ignition when a battery charger is in use to charge the battery. To resolve the issue after the battery reset, start and stop the vehicle three times. See Starting and Stopping the Engine (page 174). ²

¹ Check Brake System message may also display.

² Check Brake System message may also display. Start and stop the vehicle three times or charge the battery to clear the message. If the message still appears, have the system checked as soon as possible.

Maintenance

ADJUSTING THE HEADLAMPS

Vertical Aim Adjustment

If your vehicle has been involved in a crash, have the aim of the headlamp beam checked by an authorized dealer.

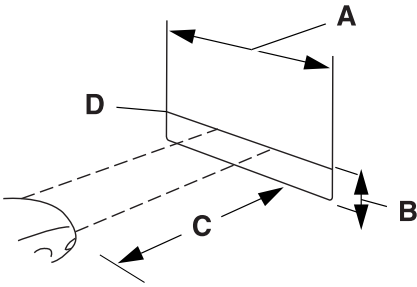

- A 8 ft (2.4 m).
- B Center height of lamp to ground (measurement B is relative to vehicle height).
- C 25 ft (7.6 m).
- D Horizontal reference line.

Vertical Aim Adjustment Procedure

1. Park your vehicle on level ground approximately 25 ft (7.6 m) from a wall or screen.
2. Measure the distance from the ground to the center of the headlamp and mark an 8 ft (2.4 m) long horizontal reference line on the wall or screen at this height.

Note: There may be an identifying mark on the lens to help you locate the center line of the headlamp.

Note: To see a clearer light pattern for adjusting, you may want to block the light from one headlamp while adjusting the other.

3. Switch on the low beam headlamps and open the hood.



4. On the wall or screen you will observe a flat zone of high intensity light located at the top of the beam pattern. If the top edge of the flat zone of high intensity light is not on the horizontal reference line, adjust the aim of the headlamp beam.



Maintenance

5. Use a suitable tool, for example a screwdriver or socket wrench, to turn the adjuster clockwise or counterclockwise to adjust the vertical aim of the headlamp. The horizontal edge of the brighter light should touch the horizontal reference line.
6. Close the hood and switch off the lamps.

EXTERIOR BULBS

EXTERIOR BULB SPECIFICATION CHART

Your vehicle has LED lamps. These are not serviceable items. See an authorized dealer if they fail.

INTERIOR BULBS

INTERIOR BULB SPECIFICATION CHART

Your vehicle has LED lamps. These are not serviceable items. See an authorized dealer if they fail.

Vehicle Specifications

ENGINE SPECIFICATIONS - 2.3L

Engine	2.3L EcoBoost
Compression ratio.	10.634:1
Displacement.	138 in ³ (2,261 cm ³)
Firing order.	1-3-4-2
Ignition system.	Coil on plug
Spark plug gap.	0.026–0.030 in (0.65–0.75 mm)

Vehicle Specifications

ENGINE SPECIFICATIONS - 3.0L

Engine	3.0L
Compression ratio.	10.5:1
Displacement.	180 in ³ (2,956 cm ³)
Firing order.	1-4-2-5-3-6
Ignition system.	Coil on plug
Spark plug gap.	0.028–0.031 in (0.7–0.8 mm)

Vehicle Specifications

ENGINE SPECIFICATIONS - 3.3L, GASOLINE

Engine	3.3L
Compression ratio.	12.0:1
Displacement.	204 in ³ (3,340 cm ³)
Firing order.	1-4-2-5-3-6
Ignition system.	Coil on plug
Spark plug gap.	0.049–0.053 in (1.25–1.35 mm)

Vehicle Specifications

ENGINE SPECIFICATIONS - 3.3L, HYBRID ELECTRIC VEHICLE (HEV)

Engine	3.3L HEV
Compression ratio.	12.0:1
Displacement.	204 in ³ (3,340 cm ³)
Firing order.	1-4-2-5-3-6
Ignition system.	Coil on plug
Spark plug gap.	0.049–0.053 in (1.25–1.35 mm)

Vehicle Specifications

MOTORCRAFT PARTS - 2.3L

Component	Motorcraft Part Number
Air filter element.	FA-2067
Battery. ¹	See note below. ²
Cabin air filter.	FP-100-A
Engine oil filter. ³	FL-2127
Spark plug.	SP-597-X
Rear window wiper blade.	WW-1110-A
Windshield wiper blade.	WW-2616-A (driver side) WW-2113-A (passenger side)

¹Configure your vehicle's battery management system to match the replacement battery. Failure to use an appropriate configuration for your battery management system could result in shortened battery life, features not working correctly, or your vehicle not starting. Consult your local dealer or service provider for further details.

²See your dealer for the most current part number.

³If a Motorcraft oil filter is not available, use an oil filter that aligns to SAE/USCAR – 36 Performance Specifications. Filter Type B.

We recommend Motorcraft parts that are available at your authorized dealer or at www.fordparts.com. We engineer these parts for your vehicle to meet or exceed our specifications. Use of other parts could impact vehicle performance, emissions and durability. Your warranty could be void for any damage related to use of other parts.

MOTORCRAFT PARTS - 3.0L

Component	Motorcraft Part Number
Air filter element.	FA-1884
Battery. ¹	See note below. ²
Cabin air filter.	FP-100-A

Vehicle Specifications

Component	Motorcraft Part Number
Engine oil filter. ³	FL-2062-A
Spark plug.	SP-594
Rear window wiper blade.	WW-1110-A
Windshield wiper blade.	WW-2616-A (driver side) WW-2113-A (passenger side)

¹Configure your vehicle's battery management system to match the replacement battery. Failure to use an appropriate configuration for your battery management system could result in shortened battery life, features not working correctly, or your vehicle not starting. Consult your local dealer or service provider for further details.

²See your dealer for the most current part number.

³If a Motorcraft oil filter is not available, use an oil filter that meets industry performance specification SAE/USCAR-36.

We recommend Motorcraft parts that are available at your authorized dealer or at www.fordparts.com. We engineer these parts for your vehicle to meet or exceed our specifications. Use of other parts could impact vehicle performance, emissions and durability. Your warranty could be void for any damage related to use of other parts.

MOTORCRAFT PARTS - 3.3L

Component	Part Number
Air filter.	FA-1947
Oil filter. ³	FL-500-S
Battery. ¹	See note below. ²
Spark plugs.	SP-589
Cabin air filter.	FP-100-A
Windshield wiper blade.	WW-2616-A (driver side)

Vehicle Specifications

Component	Part Number
	WW-2113-A (passenger side)
Rear window wiper blade.	WW-1110-A

¹ Configure your vehicle's battery management system to match the replacement battery. Failure to use an appropriate configuration for your battery management system could result in shortened battery life, features not working correctly, or your vehicle not starting. Consult your local dealer or service provider for further details.

² See your dealer for the most current part number.

³ If a Motorcraft oil filter is not available, use an oil filter that aligns to SAE/USCAR – 36 Performance Specifications. Filter Type C.

We recommend Motorcraft replacement parts available at your authorized dealer or at fordparts.com for scheduled maintenance. These parts engineered for your vehicle meet or exceed our specifications. Use of other parts could impact vehicle performance, emissions and durability. Your warranty could be void for any damage related to use of other parts.

Vehicle Care

CLEANING PRODUCTS

Materials

For best results, use the following products

or products of equivalent quality:

For additional information and assistance, we recommend that you contact an authorized dealer.

Name	Specification
Motorcraft® Bug and Tar Remover, ZC-42 (U.S. & Canada)	
Motorcraft® Custom Bright Metal Cleaner, ZC-15 (U.S. & Canada)	ESR-M5B194-B
Motorcraft® Detail Wash, ZC-3-A (U.S. & Canada)	ESR-M14P4-A
Motorcraft® Engine Shampoo and Degreaser, ZC-20 (U.S.)	ESR-M14P3-A
Motorcraft® Engine Shampoo, CXC-66-A (Canada)	
Motorcraft® Premium Leather and Vinyl Cleaner, ZC-56 (U.S. & Canada)	
Motorcraft® Multi-Purpose Cleaner, CXC-101 (Canada)	
Motorcraft® Premium Windshield Wash Concentrate with Bitterant, ZC-32-B2 (U.S.)	WSS-M14P19-A
Motorcraft® Premium Quality Windshield Washer Fluid, CXC-37-F/M (Canada)	WSS-M14P19-A
Motorcraft® Professional Strength Carpet & Upholstery Cleaner, ZC-54 (U.S. & Canada)	
Motorcraft® Premium Glass Cleaner, CXC-100 (Canada)	ESR-M14P5-A
Motorcraft® Spot and Stain Remover, ZC-14 (U.S.)	
Motorcraft® Ultra-Clear Spray Glass Cleaner, ZC-23 (U.S.)	ESR-M14P5-A
Motorcraft® Wheel and Tire Cleaner, ZC-37-A (U.S. & Canada)	

Vehicle Care

CLEANING THE EXTERIOR

CLEANING THE EXTERIOR PRECAUTIONS

Immediately remove fuel spillages, additive residuals, bird droppings, insect deposits and road tar. These may damage your vehicle's paintwork or trim over time. Remove any exterior accessories, for example antennas, before entering a car wash.

Note: *If you intend to park your vehicle for an extended period after cleaning, drive it for few minutes before parking. This reduces the risk of corrosion of the brake discs, brake pads and linings.*

CLEANING HEADLAMPS AND REAR LAMPS

We recommend that you only use cold or lukewarm water containing car shampoo to clean the headlamps and the rear lamps.

Do not scrape the lamps.

Do not wipe lamps when they are dry.

CLEANING WINDOWS AND WIPER BLADES

To clean the windshield and wiper blades:

- Clean the windshield with a non-abrasive glass cleaner.

Note: *When cleaning the interior of the windshield, avoid getting any glass cleaner on the instrument panel or door panels. Wipe any glass cleaner off these surfaces immediately.*

- Clean the wiper blades with washer fluid or water applied with a soft sponge or cloth.

Note: *Do not use razor blades or other sharp objects to clean or remove decals from the inside of the heated rear window. This can cause damage not covered by the vehicle Warranty.*

Note: *Do not use chemicals or corrosive products, as they can compromise surfaces and damage critical systems of your vehicle.*

CLEANING CHROME, ALUMINIUM OR STAINLESS STEEL

We recommend that you only use a car shampoo, a soft cloth and water on bumpers and other chrome, aluminium or stainless steel parts.

Note: *For additional information and assistance, we recommend that you contact an authorized dealer.*

Note: *Rinse the area well after cleaning.*

Note: *Do not use abrasive materials, for example steel wool or plastic pads, as they can scratch these surfaces.*

Note: *Do not use chrome cleaner, metal cleaner or polish on wheels or wheel covers.*

CLEANING WHEELS

Only use a recommended wheel and tire cleaner to clean the wheels. For additional information and assistance, contact an authorized dealer.

1. Use a sponge to remove heavy deposits of dirt and brake dust.
2. Rinse well after cleaning.

Note: *Do not apply a cleaning chemical to hot wheel rims, wheel covers, and wheel ornaments.*

If you intend to park your vehicle for an extended period after cleaning the wheels, drive it for few minutes before parking. This reduces the risk of corrosion of the brake discs, brake pads and linings.

Vehicle Care

Do not clean hot wheel rims, wheel covers and wheel ornaments.

Note: *Some car washes could damage wheel rims, wheel covers, and wheel ornaments.*

Note: *Using non-recommended cleaners, harsh acidic cleaning products, chrome wheel cleaners or abrasive materials could damage wheel rims and covers.*

Note: *Failure to properly clean the stainless steel lug nuts may result in a white, hazy finish, pitting, or an orange/brown rust appearance. Such damage is not covered by your vehicle warranty.*

CLEANING THE ENGINE COMPARTMENT

Use a vacuum cleaner to remove debris from the screen area below the windshield.

Note: *If you are not familiar with the parts around the engine do not wash the engine compartment. Avoid frequent engine washes.*

When washing the engine compartment:

- Never wash or rinse the engine while it is hot or running.
- Never wash or rinse any ignition coil, spark plug wire or spark plug well.
- Cover the battery, power distribution box, and air filter assembly to prevent water damage.

Note: *If your vehicle has an engine cover remove the cover before application of shampoo and degreaser.*

- Spray an approved engine shampoo and degreaser on all parts that require cleaning and rinse with water.

Note: *Follow the manufacturer's instructions for using engine shampoo and degreaser.*

CLEANING STRIPES OR GRAPHICS

It is recommended to wash your vehicle by hand however, pressure washing may be used under the following conditions:

- Use a spray with a minimum of 40° wide spray angle pattern.
- Keep the nozzle 12 in (30 cm) and at a 90° angle to your vehicle.
- Do not use water pressure higher than 1,000 psi (6,895 kPa).
- Do not use water hotter than 73°F (23°C).

Note: *Holding the pressure washer nozzle at an angle to the vehicle's surface may damage graphics and cause the edges to peel away.*

CLEANING CAMERA LENSES AND SENSORS

We recommend that you only use lukewarm or cold water and a soft cloth to clean the camera lens and sensors.

Note: *Do not pressure wash camera lens and sensors.*

CLEANING THE UNDERBODY

Flush the complete underside of your vehicle frequently. Keep the body and door drain holes free of packed dirt.

Rear suspension components and the complete underbody require regular cleaning with a power washer or a thorough rinse with a strong stream of water if the vehicle is operated in coastal areas, dusty or muddy environments. Rear leaf springs or other suspension components may emit squeaking or popping noises while operating the vehicle if particles, such as dirt, rocks, or other debris, are present in the components.

Vehicle Care

Note: *If you intend to park your vehicle for an extended period after cleaning the underbody, drive it for few minutes before parking. This reduces the risk of corrosion of the brake discs, brake pads and linings.*

CLEANING THE INTERIOR

CLEANING THE INSTRUMENT PANEL



WARNING: Do not use chemical solvents or strong detergents when cleaning the steering wheel or instrument panel to avoid contamination of the airbag system.

We recommend that you only clean the instrument panel and cluster lens with a damp soft cloth. Dry the area with a clean, soft cloth.

For additional information and assistance, we recommend that you contact an authorized dealer.

Note: *Avoid cleaners or polishes that increase the gloss of the upper portion of the instrument panel. The dull finish in this area helps protect you from undesirable windshield reflection.*

CLEANING PLASTIC

We recommend that you only use a mild soap and water solution on a soft cloth. Dry the area with a clean, soft cloth.

Note: *Do not allow air fresheners and hand sanitizers to spill onto interior surfaces. If a spill occurs, wipe off immediately. Your warranty may not cover these damages.*

CLEANING DISPLAYS AND SCREENS

We recommend that you only use a microfiber cloth in a circular motion to clean off the fingerprint or dust.

Note: *Do not pour or spray alcohol onto the touchscreen.*

Note: *Do not use detergent or any type of solvent to clean the touchscreen.*

CLEANING FABRIC



WARNING: On vehicles equipped with seat-mounted airbags, do not use chemical solvents or strong detergents. Such products could contaminate the side airbag system and affect performance of the side airbag in a crash.

We recommend that you only clean fabric in the following way:

1. Remove dust and loose dirt with a vacuum cleaner.
2. Wipe the surface with a soft, damp cloth and a mild soap and water solution. Dry the area with a clean, soft cloth.
3. For additional information and assistance, we recommend that you contact an authorized dealer.

For heavy stains, spot clean the area. If a ring forms on the fabric, clean the entire area immediately, but do not oversaturate or the ring could set.

Vehicle Care

CLEANING LEATHER



WARNING: On vehicles equipped with seat-mounted airbags, do not use chemical solvents or strong detergents. Such products could contaminate the side airbag system and affect performance of the side airbag in a crash.

We recommend that you only clean the leather surfaces in the following way:

1. Remove dust and loose dirt with a vacuum cleaner.
2. Wipe the surface with a soft, damp cloth and a mild soap and water solution. Dry the area with a clean, soft cloth.
3. Make sure the leather is dry, then apply a small amount of conditioner to a clean, dry cloth.
4. Rub the conditioner into the leather until it disappears. Allow the conditioner to dry, then repeat the process for the entire interior. If a film appears, wipe it off with a dry, clean cloth.
5. For additional information and assistance, we recommend that you contact an authorized dealer.

CLEANING VINYL



WARNING: On vehicles equipped with seat-mounted airbags, do not use chemical solvents or strong detergents. Such products could contaminate the side airbag system and affect performance of the side airbag in a crash.

We recommend that you only clean vinyl surfaces in the following way:

1. Remove dust and loose dirt with a vacuum cleaner.
2. Wipe the surface with a soft, damp cloth and a mild soap and water solution. Dry the area with a clean, soft cloth.
3. For additional information and assistance, we recommend that you contact an authorized dealer.

CLEANING CARPETS AND FLOOR MATS

We recommend that you only clean your carpets in the following way:

1. Remove dust and loose dirt with a vacuum cleaner.
2. Wipe the surface with a soft, damp cloth and a mild soap and water solution. Dry the area with a clean, soft cloth.
3. For additional information and assistance, we recommend that you contact an authorized dealer.

For heavy stains, spot clean the area. If a ring forms on the fabric, clean the entire area immediately, but do not oversaturate or the ring could set.

We recommend that you only clean your floor mats in the following way:

1. Remove dust and loose dirt with a vacuum cleaner.
2. Wash rubber floor mats using mild soap and lukewarm or cold water.
3. Completely dry the floor mat before placing them back in your vehicle.

Vehicle Care

CLEANING SEATBELTS



WARNING: Do not use cleaning solvents, bleach or dye on the vehicle's seatbelts, as these actions may weaken the belt webbing.

1. Wipe the surface with a soft, damp cloth and a mild soap and water solution. Dry the area with a clean, soft cloth.

CLEANING STORAGE COMPARTMENTS

1. Remove dust and loose dirt with a vacuum cleaner.
2. Wipe the surface with a soft, damp cloth and a mild soap and water solution. Dry the area with a clean, soft cloth.

REPAIRING MINOR PAINT DAMAGE

We recommend that you contact an authorized dealer to identify your vehicle color code. Authorized dealers have touch-up paint to match your vehicle's color.

Before repairing minor paint damage, use a cleaner to remove particles such as bird droppings, tree sap, insect deposits, tar spots, road salt and industrial fallout.

Read the instructions before using cleaning products.

WAXING YOUR VEHICLE

Wax the high-gloss painted surface of your prewashed vehicle once or twice a year.

We recommend that you only use an approved quality wax that does not contain abrasives. Follow the manufacturer's instructions to apply and remove the wax. For additional information and assistance, we recommend that you contact an authorized dealer.

When washing and waxing, park your vehicle in a shaded area out of direct sunlight.

Note: *Avoid waxing unpainted or low-gloss black colored parts, they discolor over time.*

Storing Your Vehicle

PREPARING YOUR VEHICLE FOR STORAGE

If you plan on storing your vehicle for 30 days or more, the following maintenance recommendations makes sure your vehicle stays in good operating condition.

Under various conditions, long-term storage may lead to degraded engine performance or failure unless you use specific precautions to preserve your vehicle.

General

- Store all vehicles in a dry, ventilated place.
- If vehicles are stored outside, they require regular maintenance to protect against rust and weather damage.
- Make sure all linkages, cables, levers and pins under your vehicle are covered with grease to prevent rust.
- Move vehicles at least 25 ft (7.5 m) every 15 days to lubricate working parts and prevent corrosion.
- Fill the fuel tank with high-quality fuel until the first automatic shutoff of the fuel pump nozzle.

Engine

- Change the engine oil and filter prior to storage because used engine oil contains contaminants which may cause engine damage.
- Start the engine every 15 days for a minimum of 15 minutes. Run at fast idle with the climate controls set to defrost until the engine reaches normal operating temperature.
- With your foot on the brake, shift through all the gears while the engine is running.

Body

- Wash your vehicle thoroughly to remove dirt, grease, oil, tar or mud from exterior surfaces, rear wheel housings and the underside of front fenders.
- Periodically wash your vehicle if it is stored in exposed locations.
- Touch-up exposed or primed metal to prevent rust.
- Cover chrome and stainless steel parts with a thick coat of auto wax to prevent discoloration. Rewax as necessary when you wash your vehicle.
- Lubricate all hood, door and luggage compartment hinges and latches with a light grade oil.
- Cover interior trim to prevent fading.
- Keep all rubber parts free from oil and solvents.

12 Volt Battery

- When storing your vehicle for longer than 30 days the battery state of charge should be approximately 50%. Additionally, we recommend to disconnect the 12v battery to reduce system loads on the battery, or you can use a trickle charger for longer storage periods.
- Check and recharge as necessary. Keep connections clean.

Note: *It is necessary to reset memory features if you disconnect the battery cables.*

Storing Your Vehicle

Tires

- Maintain recommended air pressure.
- To minimize flat spots on the tires, inflate all four tires to the recommended cold pressures listed on the Safety Compliance Certification label or Tire Label affixed to your vehicle. When the vehicle is taken out of storage, reset the tire pressures as necessary to the recommended levels listed on the Safety Compliance Certification label or Tire Label affixed to your vehicle.

Note: *If you store your vehicle in a location with low ambient temperatures, follow the instructions for care of summer tires.*

Brakes

Make sure the brakes and parking brake fully release.

Note: *If you intend to park your vehicle for an extended period after cleaning, drive it for few minutes before parking. This reduces the risk of corrosion of the brake discs, brake pads and linings.*

REMOVING YOUR VEHICLE FROM STORAGE

When your vehicle is ready to come out of storage, do the following:

- We recommend that you change the engine oil before you use your vehicle again.
- Wash your vehicle to remove any dirt or grease film build-up on window surfaces.
- Check windshield wipers for any deterioration.
- Check the underhood for any foreign materials such as mice or squirrel nests.

- Check the exhaust for any foreign materials.
- Check tire pressures and set tire inflation per the Tire Label.
- Check brake pedal operation. Corroded brake rotors could cause brake noise. Drive your vehicle and gently apply and release the brakes repeatedly over a 10-minute drive to reduce the corrosion from the brakes.
- Check fluid levels (including coolant, oil and gas) to make sure there are no leaks, and fluids are at recommended levels.
- If you remove the battery, clean the battery cable ends and check for damage.

Contact an authorized dealer if you have any concerns or issues.

Wheel and Tire Information

LOCATING THE TIRE LABEL

The tire label or safety certification label is on the driver side B-pillar or the edge of the driver door. It contains information on the recommended front and rear tire inflation pressures. See **Locating the Safety Compliance Certification Labels** (page 323).

DEPARTMENT OF TRANSPORTATION UNIFORM TIRE QUALITY GRADES



Tire Quality Grades apply to new pneumatic passenger car tires. The Quality grades can be found where applicable on the tire sidewall between tread shoulder and maximum section width. For example: **Treadwear 200 Traction AA Temperature A.**

These Tire Quality Grades are determined by standards that the United States Department of Transportation has set.

Tire Quality Grades apply to new pneumatic passenger car tires. They do not apply to deep tread, winter-type snow tires, space-saver or temporary use spare tires, light truck or LT type tires, tires with nominal rim diameters of 10 to 12 inches or limited production tires as defined in Title 49 Code of Federal Regulations Part 575.104 (c)(2).

U.S. Department of Transportation Tire quality grades: The U.S. Department of Transportation requires us to give you the following information about tire grades exactly as the government has written it.

Treadwear

The treadwear grade is a comparative rating based on the wear rate of the tire when tested under controlled conditions on a specified government test course. For example, a tire graded 150 would wear 1½ times as well on the government course as a tire graded 100. The relative performance of tires depends upon the actual conditions of their use, however, and may depart significantly from the norm due to variations in driving habits, service practices, and differences in road characteristics and climate.

Wheel and Tire Information

Traction AA A B C



WARNING: The traction grade assigned to this tire is based on straight-ahead braking traction tests, and does not include acceleration, cornering, hydroplaning or peak traction characteristics.

The traction grades, from highest to lowest are AA, A, B, and C. The grades represent the tire's ability to stop on wet pavement as measured under controlled conditions on specified government test surfaces of asphalt and concrete. A tire marked C may have poor traction performance.

Temperature A B C



WARNING: The temperature grade for this tire is established for a tire that is properly inflated and not overloaded. Excessive speed, underinflation, or excessive loading, either separately or in combination, can cause heat buildup and possible tire failure.

The temperature grades are A (the highest), B and C, representing the tire's resistance to the generation of heat and its ability to dissipate heat when tested under controlled conditions on a specified indoor laboratory

test wheel. Sustained high temperature can cause the material of the tire to degenerate and reduce tire life, and excessive temperature can lead to sudden tire failure. The grade C corresponds to a level of performance which all passenger car tires must meet under the Federal Motor Vehicle Safety Standard No. 139. Grades B and A represent higher levels of performance on the laboratory test wheel than the minimum required by law.

INFORMATION ON THE TIRE SIDEWALL

Both United States and Canada Federal regulations require tire manufacturers to place standardized information on the sidewall of all tires. This information identifies and describes the fundamental characteristics of the tire and also provides a U.S. DOT Tire Identification Number for safety standard certification and in case of a recall.

Wheel and Tire Information

Information on P Type Tires

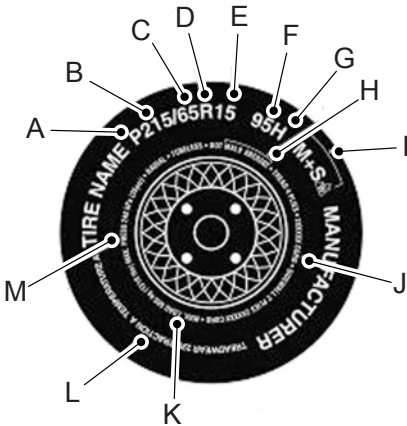

P215/65R15 95H is an example of a tire size, load index and speed rating. The definitions of these items are listed below. (Note that the tire size, load index and speed rating for your vehicle may be different from this example.)

A. P: Indicates a tire, designated by the Tire and Rim Association, that may be used for service on cars, sport utility vehicles, minivans and light trucks. **Note:** If your tire size does not begin with a letter this may mean it is designated by either the European Tire and Rim Technical Organization or the Japan Tire Manufacturing Association.

B. 215: Indicates the nominal width of the tire in millimeters from sidewall edge to sidewall edge. In general, the larger the number, the wider the tire.

C. 65: Indicates the aspect ratio which gives the tire's ratio of height to width.

D. R: Indicates a radial type tire.

E. 15: Indicates the wheel or rim diameter in inches. If you change your wheel size, you will have to purchase new tires to match the new wheel diameter.

F. 95: Indicates the tire's load index. It is an index that relates to how much weight a tire can carry. You may find this information in your owner's manual. If not, contact a local tire dealer.

Note: *You may not find this information on all tires because it is not required by federal law.*

G. H: Indicates the tire's speed rating. The speed rating denotes the speed at which a tire is designed to be driven for extended periods of time under a standard condition of load and inflation pressure. The tires on your vehicle may operate at different conditions for load and inflation pressure. These speed ratings may need to be adjusted for the difference in conditions. The ratings range from 81 mph (130 km/h) to 186 mph (300 km/h). These ratings are listed in the following chart.

Wheel and Tire Information

Note: You may not find this information on all tires because it is not required by federal law.

Letter rating	Speed rating
M	81 mph (130 km/h)
N	87 mph (140 km/h)
Q	99 mph (160 km/h)
R	106 mph (170 km/h)
S	112 mph (180 km/h)
T	118 mph (190 km/h)
U	124 mph (200 km/h)
H	130 mph (210 km/h)
V	149 mph (240 km/h)
W	168 mph (270 km/h)
Y	186 mph (300 km/h)

Note: For tires with a maximum speed capability over 149 mph (240 km/h), tire manufacturers sometimes use the letters ZR. For those with a maximum speed capability over 186 mph (300 km/h), tire manufacturers always use the letters ZR.

H. U.S. DOT Tire Identification Number (TIN): This begins with the letters DOT and indicates that the tire meets all federal standards. The next three numbers or letters are the plant code designating where it was manufactured, the next two are

the tire size code and the last four numbers represent the week and year the tire was built. For example, the numbers 317 mean the 31st week of 1997. After 2000, the numbers go to four digits. For example, 2501 means the 25th week of 2001. The numbers in between are identification codes used for traceability. This information is used to contact customers if a tire defect requires a recall.

I. M+S or M/S: Mud and Snow, or
AT: All Terrain, or
AS: All Season.

J. Tire Ply Composition and Material Used: Indicates the number of plies or the number of layers of rubber-coated fabric in the tire tread and sidewall. Tire manufacturers also must indicate the ply materials in the tire and the sidewall, which include steel, nylon, polyester, and others.

K. Maximum Load: Indicates the maximum load in kilograms and pounds that can be carried by the tire. See the Safety Compliance Certification Label (affixed to either the door hinge pillar, door-latch post, or the door edge that meets the door-latch post, next to the driver's seating position), for the correct tire pressure for your vehicle.

L. Treadwear, Traction and Temperature Grades:

Wheel and Tire Information

***Treadwear** The treadwear grade is a comparative rating based on the wear rate of the tire when tested under controlled conditions on a specified government test course. For example, a tire graded 150 would wear one and one-half times as well on the government course as a tire graded 100.

***Traction:** The traction grades, from highest to lowest are AA, A, B, and C. The grades represent the tire's ability to stop on wet pavement as measured under controlled conditions on specified government test surfaces of asphalt and concrete. A tire marked C may have poor traction performance.

***Temperature:** The temperature grades are A (the highest), B and C, representing the tire's resistance to the generation of heat and its ability to dissipate heat when tested under controlled conditions on a specified indoor laboratory test wheel.

M. Maximum Inflation

Pressure: Indicates the tire manufacturers' maximum permissible pressure or the pressure at which the maximum load can be carried by the tire. This pressure is normally higher than the vehicle manufacturer's recommended cold inflation pressure which can be found on the Safety Compliance Certification Label (affixed to either the door hinge pillar, door-latch post, or the door edge

that meets the door-latch post, next to the driver's seating position), or Tire Label which is located on the B-Pillar or the edge of the driver's door. The cold inflation pressure should never be set lower than the recommended pressure on the vehicle label.

The tire suppliers may have additional markings, notes or warnings such as standard load or radial tubeless.

Additional Information Contained on the Tire Sidewall for LT Type Tires

Note: *Tire Quality Grades do not apply to this type of tire.*

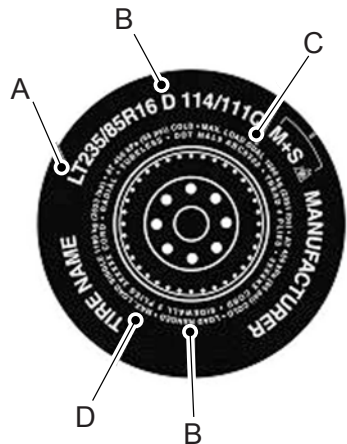

LT type tires have some additional information beyond those of P type tires; these differences are described below.

Wheel and Tire Information

A. **LT:** Indicates a tire, designated by the Tire and Rim Association, that is intended for service on light trucks.

B. **Load Range and Load Inflation Limits:** Indicates the tire's load-carrying capabilities and its inflation limits.

C. **Maximum Load Dual lb (kg) at psi (kPa) cold:** Indicates the maximum load and tire pressure when the tire is used as a dual, defined as four tires on the rear axle (a total of six or more tires on the vehicle).

D. **Maximum Load Single lb (kg) at psi (kPa) cold:** Indicates the maximum load and tire pressure when the tire is used as a single, defined as two tires (total) on the rear axle.

Information on T Type Tires

T145/80D16 is an example of a tire size.

Note: *The temporary tire size for your vehicle may be different from this example. Tire Quality Grades do not apply to this type of tire.*

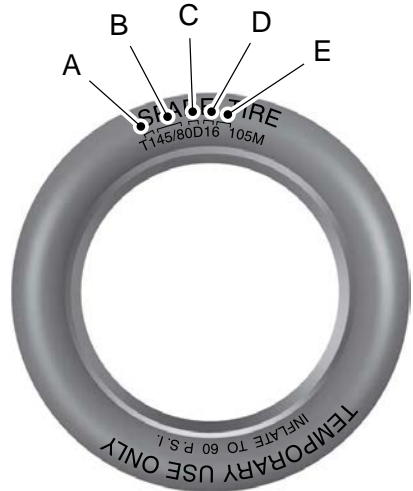

T type tires have some additional information beyond those of P type tires; these differences are described below:

A. **T:** Indicates a type of tire, designated by the Tire and Rim Association, that is intended for temporary service on cars, sport utility vehicles, minivans and light trucks.

B. **145:** Indicates the nominal width of the tire in millimeters from sidewall edge to sidewall edge. In general, the larger the number, the wider the tire.

Wheel and Tire Information

C. **80:** Indicates the aspect ratio which gives the tire's ratio of height to width. Numbers of 70 or lower indicate a short sidewall.

D. **D:** Indicates a diagonal type tire.

R: Indicates a radial type tire.

E. **16:** Indicates the wheel or rim diameter in inches. If you change your wheel size, you will have to purchase new tires to match the new wheel diameter.

GLOSSARY OF TIRE TERMINOLOGY

***Tire label:** A label showing the original equipment tire sizes, recommended inflation pressure and the maximum weight the vehicle can carry.

***Tire Identification Number (TIN):** A number on the sidewall of each tire providing information about the tire brand and manufacturing plant, tire size and date of manufacture. Also referred to as DOT code.

***Inflation pressure:** A measure of the amount of air in a tire.

***Standard load:** A class of P-metric or Metric tires designed to carry a maximum load at set pressure. For example: For P-metric tires 35 psi (2.4 bar) and for Metric tires 36 psi (2.5 bar). Increasing the inflation pressure beyond this pressure will not increase the tire's load carrying capability.

***Extra load:** A class of P-metric or Metric tires designed to carry a heavier maximum load at 42 psi (2.9 bar). Increasing the inflation pressure beyond this pressure will not increase the tire's load carrying capability.

***kPa:** Kilopascal, a metric unit of air pressure.

***PSI:** Pounds per square inch, a standard unit of air pressure.

***Cold tire pressure:** The tire pressure when the vehicle has been stationary and out of direct sunlight for an hour or more and prior to the vehicle being driven for 1 mi (1.6 km).

***Recommended inflation pressure:** The cold inflation pressure found on the Safety Compliance Certification Label (affixed to either the door hinge pillar, door-latch post, or the door edge that meets the door-latch post, next to the driver's seating position), or Tire Label located on the B-Pillar or the edge of the driver door.

* **B-pillar:** The structural member at the side of the vehicle behind the front door.

***Bead area of the tire:** Area of the tire next to the rim.

* **Sidewall of the tire:** Area between the bead area and the tread.

Wheel and Tire Information

***Tread area of the tire:** Area of the perimeter of the tire that contacts the road when mounted on the vehicle.

***Rim:** The metal support (wheel) for a tire or a tire and tube assembly upon which the tire beads are seated.

TIRE REPLACEMENT REQUIREMENTS

Your vehicle is equipped with tires designed to provide a safe ride and handling capability.



WARNING: Only use replacement tires and wheels that are the same size, as those originally provided for your vehicle. The required tire and wheel sizes, along with the minimum required Load and Speed Index, can be found on the Tire Label on the driver side door frame or the edge of the driver door. If this information is not found in those locations, or for additional options, contact your authorized dealer. Use of any tire or wheel not recommended, could affect the safety and performance of your vehicle, which could result in an increased risk of loss of vehicle control, vehicle rollover, personal injury and death.



WARNING: To reduce the risk of serious injury, when mounting replacement tires and wheels, you should not exceed the maximum pressure indicated on the sidewall of the tire to set the beads without additional precautions listed below. If the beads do not seat at the maximum pressure indicated, re-lubricate and try again.



WARNING: For a mounting pressure more than 20 psi (1.38 bar) greater than the maximum pressure, a Ford dealer or other tire service professional should do the mounting.



WARNING: Always inflate steel carcass tires with a remote air fill with the person inflating standing at a minimum of 12 ft (3.66 m) away from the wheel and tire assembly.



WARNING: Only use the specified jacking points. If you use any other locations you could damage vehicle components, such as brake lines.

Wheel and Tire Information



WARNING: When inflating the tire for mounting pressures up to 20 psi (1.38 bar) greater than the maximum pressure on the tire sidewall, the following precautions must be taken to protect the person mounting the tire:

- Make sure that you have the correct tire and wheel size.
- Lubricate the tire bead and wheel bead seat area again.
- Stand at a minimum of 12 ft (3.66 m) away from the wheel and tire assembly.
- Use both eye and ear protection.

Important: Remember to replace the wheel valve stems when the road tires are replaced on your vehicle.

It is recommended that the two front tires or two rear tires generally be replaced as a pair if the worn tires still have usable depth.

To avoid potential All-Wheel Drive (AWD) malfunction or (AWD) system damage, it is recommended to replace all four tires rather than mixing significantly worn tires with new tires.

The tire pressure sensors mounted in the wheels (originally installed on your vehicle) are not designed to be used in aftermarket wheels.

The use of wheels or tires not recommended may affect the operation of your tire pressure monitoring system.

If the tire pressure monitoring system indicator is flashing, your system is malfunctioning. Your replacement tire might be incompatible with your tire pressure monitoring system, or some component of the system may be damaged.

Age



WARNING: Tires degrade over time depending on many factors such as weather, storage conditions, and conditions of use (load, speed, inflation pressure) the tires experience throughout their lives.

In general, tires should be replaced after six years regardless of tread wear.

However, heat caused by hot climates or frequent high loading conditions can accelerate the aging process and may require tires to be replaced more frequently.

You should replace your spare tire when you replace the road tires or after six years due to aging even if it has not been used.

Wheel and Tire Information

U.S. DOT Tire Identification Number

Both United States and Canada Federal regulations require tire manufacturers to place standardized information on the sidewall of all tires. This information identifies and describes the fundamental characteristics of the tire and also provides a U.S. DOT Tire Identification Number for safety standard certification and in case of a recall.

This begins with the letters DOT and indicates that the tire meets all federal standards. The next three numbers or letters are the plant code designating where it was manufactured, the next two are the tire size code and the last four numbers represent the week and year the tire was built. For example, the numbers 317 mean the 31st week of 1997. After 2000, the numbers go to four digits. For example, 2501 means the 25th week of 2001. The numbers in between are identification codes used for traceability. This information is used to contact customers if a tire defect requires a recall.

USING SNOW CHAINS

 **WARNING:** Do not exceed 30 mph (50 km/h). Failure to follow this instruction could result in the loss of control of your vehicle, personal injury or death.

 **WARNING:** Do not use snow chains on snow-free roads.

 **WARNING:** Only fit snow chains to specified tires.

 **WARNING:** If your vehicle is fitted with wheel trims, remove them before fitting snow chains.

 **WARNING:** If you choose to install snow tires on your vehicle, they must be the same size, construction, and load range as the original tires listed on the tire placard, and they must be installed on all four wheels. Mixing tires of different size or construction on your vehicle can adversely affect your vehicle's handling and braking, and may lead to loss of vehicle control.

Only use snow chains on rear wheels. Install snow chains in pairs. Do not use self-tensioning snow chains.

Only use snow chains on the following specified tire sizes:

- 255/60R18
 - Only install chains that are 10 mm or less.
- 255/65R18
 - Only install chains that are 10 mm or less.

Wheel and Tire Information

- 265/60R18
 - Only install chains that are 10 mm or less.
- 255/55R20
 - Only install chains that are 10 mm or less.

We recommend you use steel wheels of the same size and specification if snow chains are required because chains may chip aluminum wheels.

Follow these guidelines when using snow tires and traction devices:

- If possible, avoid fully loading your vehicle.
- Purchase snow chains from a manufacturer that clearly labels body to tire dimension restrictions.
- When driving with snow chains do not exceed 30 mph (50 km/h) or the maximum speed recommended by the chain manufacturer, whichever is less.
- Drive cautiously. If you hear the snow chains rub or bang against the vehicle, stop and tighten them. If this does not work, remove the snow chains to prevent vehicle damage.
- Remove the snow chains when they are no longer needed. Do not use snow chains on dry roads.
- If a temporary spare wheel is mounted on your vehicle, do not use snow chains on the axle with the temporary spare wheel.
- Use snow chains that fit against the sidewall of the tire to prevent the chains from touching the wheel rims or suspension, see following illustration.

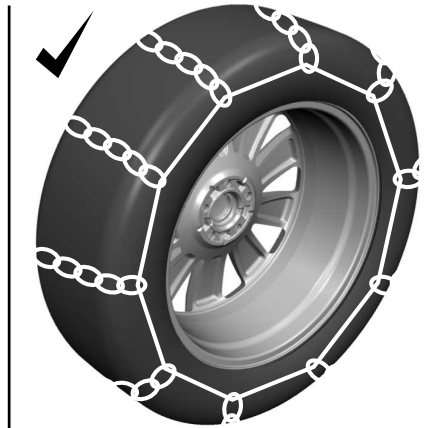
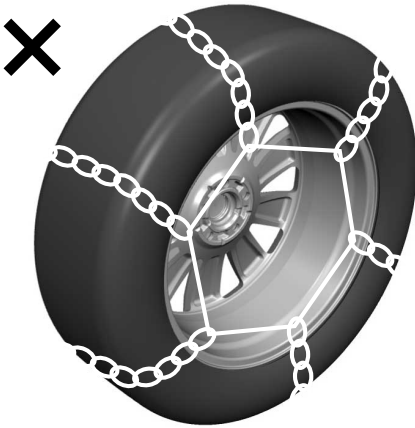

If you have any questions regarding snow chains, please contact your authorized dealer.

Tire Care

CHECKING THE TIRE PRESSURES

Safe operation of your vehicle requires that your tires are properly inflated. Every day before you drive, check your tires.

At least once a month and before long trips, inspect each tire and check the tire pressure with a tire gauge. Inflate all tires to the recommended inflation pressure. See **Inflating the Tires** (page 420).

INFLATING THE TIRES



WARNING: Under-inflation is the most common cause of tire failures and may result in severe tire cracking, tread separation or blowout, with unexpected loss of vehicle control and increased risk of injury. Under-inflation increases sidewall flexing and rolling resistance, resulting in heat buildup and internal damage to the tire. It also may result in unnecessary tire stress, irregular wear, loss of vehicle control and accidents. A tire can lose up to half of its air pressure and not appear to be flat!



WARNING: Do not use the tire pressure displayed in the information display as a tire pressure gauge. Failure to follow this instruction could result in personal injury or death.

Use the recommended cold inflation pressure for optimum tire performance and wear. Under-inflation or over-inflation may cause uneven treadwear patterns.

Inflate your tires to the recommended inflation pressure even if it is less than the maximum inflation pressure information found on the tire. You can find the tire label with the recommended tire inflation pressure next to the tire size on the B-Pillar or the edge of the driver door.

The recommended tire inflation pressure is also found on the Safety Compliance Certification Label, affixed to either the door hinge pillar, door-latch post, or the door edge that meets the door-latch on the B-pillar, or on the edge of the driver door.

Failure to follow the tire pressure recommendations can cause uneven treadwear patterns and adversely affect the way your vehicle handles.

Tire Care

Checking Pressure when tires are hot:

If pressures are checked after tires have been driven for more than three minutes or more than 1 mile, (2 km) the tires become hot and the pressures will increase by approximately 4 psi (27.6 kPa). Therefore when the tire pressure is adjusted under these conditions, it should be increased to a gauge reading of 4 psi (27.6 kPa) greater than the recommended cold inflation pressure.

After inflating the tires while hot, make sure to recheck tire pressure later once the tires are cold.

For Example Only

Gauge reading of hot tire	33 psi (230 kPa)
If recommended, cold inflation pressure is	32 psi (220 kPa)

The hot tire pressure is only 1 psi (10 kPa) greater than the recommended cold inflation pressure. Therefore, add 3 psi (20 kPa) more to increase the hot pressure to 4 psi (30 kPa) over the recommended cold inflation pressure.

New hot pressure	36 psi (250 kPa)
------------------	------------------

INSPECTING THE TIRE FOR WEAR

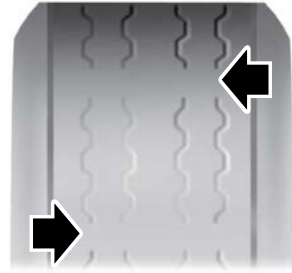

When the tread is worn down to 2/32 inch (1.6 mm), tires must be replaced to help prevent your vehicle from skidding and hydroplaning. Built-in treadwear indicators, or wear bars, which look like narrow strips of smooth rubber across the tread will appear on the tire when the tread is worn down to 2/32 inch (1.6 mm).

When the tire tread wears down to the same height as these wear bars, the tire is worn out and must be replaced.

The tires should also be balanced periodically. An unbalanced tire and wheel assembly may result in irregular tire wear.

Tire Care

Periodically inspect the tire treads for uneven or excessive wear and remove objects such as stones, nails or glass that may be wedged in the tread grooves.

INSPECTING THE TIRE FOR DAMAGE

Inspect the tire sidewalls for cracking, cuts, bruises and other signs of damage or excessive wear. If internal damage to the tire is suspected, have the tire dismantled and inspected in case it needs to be repaired or replaced. For your safety, tires that are damaged or show signs of excessive wear should not be used because they are more likely to blow out or fail.

Periodically inspect the tire treads and sidewalls for damage, such as bulges in the tread or sidewalls, cracks in the tread groove and separation in the tread or sidewall. If damage is observed or suspected, have the tire inspected by a tire professional.

Safety Practices



WARNING: If your vehicle is stuck in snow, mud or sand, do not rapidly spin the tires; spinning the tires can tear the tire and cause an explosion. A tire can explode in as little as three to five seconds.



WARNING: Do not spin the wheels at over 34 mph (55 km/h). The tires may fail and injure a passenger or bystander.

HIGH SPEED DRIVING CAN BE DANGEROUS

Correct inflation pressure is especially important. However, at high speeds, even with the correct inflation pressure, a road hazard for example is more difficult to avoid and if contact is made, has a greater chance of causing tire damage than at a lower speed. Moreover, driving at high speed reduces the reaction time available to avoid accidents and bring your vehicle to a safe stop.

If you see any damage to a tire or wheel, replace it with the spare at once and visit a participating Tire Retailer.

Exceeding the maximum speeds shown on the following page for each type of tire will cause the tire to build up excessive heat which can cause tire damage that could result in sudden tire destruction and rapid air loss. Failure to control a vehicle when one or more tires experience a sudden air loss can lead to an accident.

In any case, you should not exceed reasonable speeds as indicated by the legal limits and driving conditions.

Tire Care

DO NOT OVERLOAD: DRIVING ON ANY OVERLOADED TIRE IS DANGEROUS

The maximum load rating of your tires is molded on the tire sidewall. Do not exceed this rating. Follow the loading instructions of the manufacturer of your vehicle and this will ensure that your tires are not overloaded. Tires which are loaded beyond their maximum allowable loads for the particular application will build up excessive heat that may result in sudden tire destruction. Do not exceed the gross axle weight rating for any axle on your vehicle.

TIRE ALTERATIONS

Do not make or allow to be made any alterations on your tires. Alterations may prevent proper performance, leading to tire damage which can result in an accident. Tires which become unserviceable due to alterations such as truing, whitewall inlays, addition of balancing or sealant liquids, or the use of tire dressing containing petroleum distillates are excluded from warranty coverage.

REPAIRS - WHEREVER POSSIBLE, SEE YOUR TIRE RETAILER AT ONCE

If any tire sustains a puncture, have the tire demounted and thoroughly inspected by a tire retailer for possible damage that may have occurred. A tread area puncture in any passenger or light truck tire can be repaired provided that the puncture hole is not more than 1/4" in diameter, not more than one radial cable per casing ply is damaged, and the tire has not been damaged further by the puncturing object or by running underinflated. Tire punctures consistent with these guidelines should only be repaired by following the US Tire Manufacturers Association (USTMA) recommended repair procedures. Plug-only repairs done on-the-wheel are considered improper and therefore, not recommended. Such repairs are not reliable and may cause further damage to the tire.

STORAGE

Tires contain waxes and emollients to protect their outer surfaces from ozone and weather checking. As the tire rolls and flexes, the waxes and emollients continually migrate to the surface, replenishing this protection throughout the normal use of the tire. Consequently, when tires sit unused for long periods of time (a month or more) their surfaces

Tire Care

become dry and more susceptible to ozone and weather checking and the casing becomes susceptible to flat spotting. **For this reason, tires should always be stored in a cool, dry, clean, indoor environment. If storage is for one month or more, eliminate the weight from the tires by raising the vehicle or by removing the tires from the vehicle. Failure to store tires in accordance with these instructions could result in damage to your tires or premature aging of the tires and sudden tire failure.**

When tires are stored, be sure they are placed away from sources of heat and ozone such as direct sunlight, hot pipes and electric generators. Be sure that surfaces on which tires are stored are clean and free from grease, gasoline or other substances, which could deteriorate the rubber. Failure to store tires in accordance with these instructions could result in damage to your tires or premature aging of the tires and sudden tire failure.

FOLLOW THESE MOUNTING RECOMMENDATIONS

Tire changing can be dangerous and must be done by professionally trained persons using proper tools and procedures as specified by the US Tire Manufacturers Association (USTMA). Single or dual assemblies must be completely deflated before demounting.

Your tires should be mounted on wheels of correct size and type and which are in good, clean condition. Wheels that are bent, chipped, rusted (steel wheels) or corroded (alloy wheels) may cause tire damage. The inside of the tire must be free from foreign material. Have your retailer check the wheels before mounting new tires. Mismatched tires and rims can explode during mounting. Also, mismatched tires and rims can result in dangerous tire failure on the road. If a tire is mounted by error on the wrong-sized rim, do not remount it on the proper rim – scrap it. It may have been damaged internally (which is not externally visible) by having been dangerously stretched and could fail on the highway.

Tire Care

Old valves may leak. When new tubeless tires are mounted, have new valves of the correct type installed. Tubeless tires must only be mounted on wheels designed for tubeless tires i.e., wheels which have safety humps or ledges.

It is recommended that you have your tires and wheels balanced. Tires and wheels, which are not balanced, may cause steering difficulties, a bumpy ride, and irregular tire wear.

Be sure that all your valves have suitable valve caps. The valve cap is the primary seal against air loss.

TEMPORARY SPARE TIRES

When using any temporary spare tire, be sure to follow the vehicle manufacturer's instructions.

REMEMBER... TO AVOID DAMAGE TO YOUR TIRES AND POSSIBLE ACCIDENT:

- CHECK TIRE PRESSURE AT LEAST ONCE EACH MONTH WHEN TIRES ARE COLD AND BEFORE LONG TRIPS.
- DO NOT UNDERINFLATE/OVERINFLATE.
- DO NOT OVERLOAD.
- DRIVE AT MODERATE SPEEDS, OBSERVE LEGAL LIMITS.

- AVOID DRIVING OVER POTHOLES, OBSTACLES, CURBS OR EDGES OF PAVEMENT.
- AVOID EXCESSIVE WHEEL SPINNING.
- IF YOU SEE ANY DAMAGE TO A TIRE, REPLACE WITH THE SPARE AND VISIT ANY AUTHORIZED RETAILER AT ONCE.
- IF YOU HAVE ANY QUESTIONS, CONTACT YOUR AUTHORIZED RETAILER.

Highway Hazards

No matter how carefully you drive, there is always the possibility that you could eventually have a flat tire on the highway. Drive slowly to the closest safe area out of traffic. This could further damage the flat tire, but your safety is more important.

If you feel a sudden vibration or ride disturbance while driving, or you suspect your tire or vehicle has been damaged, immediately reduce your speed. Drive with caution until you can safely pull off the road. Stop and inspect the tires for damage. If a tire is under-inflated or damaged, deflate it, remove the wheel and replace it with your spare tire and wheel. If you cannot detect a cause, have the vehicle towed to the nearest repair facility or tire dealer to have the vehicle inspected.

Tire Care

Tire and Wheel Alignment

A bad jolt from hitting a curb or pothole can cause the front end of your vehicle to become misaligned or cause damage to your tires. If your vehicle seems to pull to one side when you are driving, the wheels could be out of alignment. Have an authorized dealer check the wheel alignment periodically.

Wheel misalignment in the front or the rear can cause uneven and rapid treadwear of your tires and should be corrected by an authorized dealer.

INSPECTING THE WHEEL VALVE STEMS

Check the valve stems for holes, cracks, or cuts that could permit air leakage.

TIRE ROTATION



WARNING: If the tire label shows different tire pressures for the front and rear tires and the vehicle has a tire pressure monitoring system, then you need to update the settings for the system sensors. Always

perform the system reset procedure after tire rotation. If you do not reset the system, it may not provide a low tire pressure warning when necessary.

Rotating your tires at the recommended interval will help your tires wear more evenly, providing better tire performance and longer tire life.

Note: *If your tires show any uneven wear have the alignment checked by an authorized dealer before rotating tires.*

Note: *If you have a dissimilar spare wheel and tire assembly, it is intended for temporary use only and should not be used in a tire rotation.*

Note: *After having your tires rotated, inflation pressure must be checked and adjusted to the vehicle requirements.*

Tire Rotation Diagram

Follow the diagram indicating the correct tire locations for rotating the tires.

Tire Care

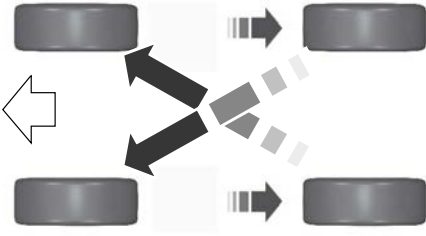

Tire Sealant and Inflator Kit

WHAT IS THE TIRE SEALANT AND INFLATOR KIT

The kit consists of an air compressor to re-inflate the tire and a canister of sealing compound that effectively seals most punctures. This kit provides a temporary tire repair allowing you to drive your vehicle up to 120 mi (200 km) at a maximum speed of 50 mph (80 km/h) to reach a tire service location.

Note: *The temporary mobility kit contains enough sealant compound in the canister for one tire repair only. See an authorized dealer for replacement sealant canisters.*

TIRE SEALANT AND INFLATOR KIT PRECAUTIONS



WARNING: Depending on the type and extent of tire damage, some tires can only be partially sealed or not sealed at all. Loss of tire pressure can affect vehicle handling, leading to loss of vehicle control.



WARNING: Do not use the kit on a previously damaged tire, for example when it has been driven under inflated. This could cause loss of vehicle control, personal injury or death.



WARNING: Do not run the engine when operating the air compressor unless the vehicle is outdoors or in a well-ventilated area.

Do not attempt to repair punctures larger than 0.24 in (6 mm) or damage to the tire's sidewall.

Only punctures located within the tire tread can be sealed with the kit.

Only use the kit supplied with your vehicle.

The temporary mobility kit contains enough sealant compound in the canister for one tire repair only.

After using the sealant, an authorized dealer needs to replace the tire pressure monitoring system sensor and valve stem on the wheel.

LOCATING THE TIRE SEALANT AND INFLATOR KIT

The tire sealant and inflator kit is located under the load floor in the rear of the vehicle.

Tire Sealant and Inflator Kit

TIRE SEALANT AND INFLATOR KIT COMPONENTS

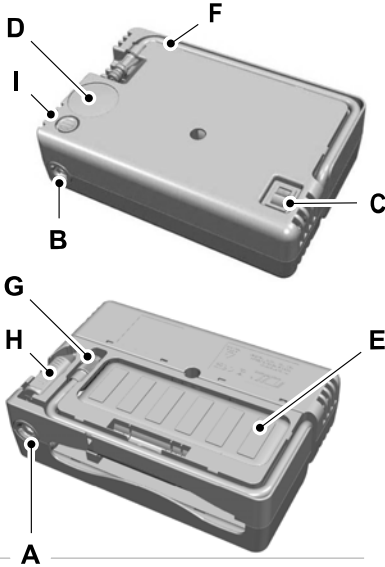

- A Air compressor (inside)
- B Air Hose port (1 of 2)
- C On and Off button
- D Air pressure gauge
- E Sealant bottle and canister
- F Dual purpose hose: air and repair
- G Tire valve connector
- H Accessory power plug
- I Casing/housing

USING THE TIRE SEALANT AND INFLATOR KIT

To make sure the kit operates safely and properly, observe the following:

- Before operating the kit, make sure your vehicle is safely off the road and away from moving traffic.
- Do not remove any foreign objects, such as nails or screws, from the tire.
- Do not allow the compressor to operate continuously for more than 15 minutes. This prevents the compressor from overheating.
- Only use the kit when the ambient temperature is between -22°F (-30°C) and 158°F (70°C).
- Only use the sealing compound before the use by date. The use by date is on the sealant canister label and can be seen through the rectangular viewing window on the bottom of the compressor. Check the use by date regularly and replace the canister when the sealant expires.

Note: Sealant compound contains latex. Use appropriate precautions to avoid any allergic reactions.



The tire sealant and inflator kit can be for regular tire pressure maintenance and inflating other objects by plugging the air supply hose into the port identified by a tire pump icon as indicated by the gray portion of the instruction label.

What to do when a tire is punctured

A tire puncture within the tire's tread area can be repaired in two stages with the kit:

Tire Sealant and Inflator Kit

- In the first stage, the tire is reinflated with a sealing compound and air. After the tire has been inflated, drive the vehicle 4 mi (6 km) to distribute the sealant in the tire.
- In the second stage, check the tire pressure and adjust, if necessary, to the vehicle's specified tire inflation pressure.

First Stage: Reinflating the Tire with sealing compound and air



WARNING: Do not stand directly over the kit while inflating the tire. If you notice any unusual bulges or deformations in the tire's sidewall during inflation, stop and call roadside assistance.



WARNING: If the tire does not inflate to the recommended tire pressure within 15 minutes, stop and call roadside assistance.

Park the vehicle in a safe, level and secure area, away from moving traffic.

Turn the hazard lights on. Apply the parking brake and power off the vehicle. Inspect the flat tire for visible damage.

If a puncture is located in the tire sidewall, stop and call roadside assistance.

1. The dual-purpose hose (black tube) for air and sealant is pressed into a groove on the compressor housing. Remove the dual-purpose hose from the compressor housing.
2. Insert the air supply hose into the port as identified by the punctured tire icon and indicated by the blue portion of the instruction label for temporary repair of a tire puncture.

Note: Note the winged twist connector on the instruction label side of the housing.

3. Follow the arrow on the blue, puncture repair portion of the label to find the port for the winged twist connector on the side of the compressor housing. It is labeled "A" with a printed icon of a punctured tire.

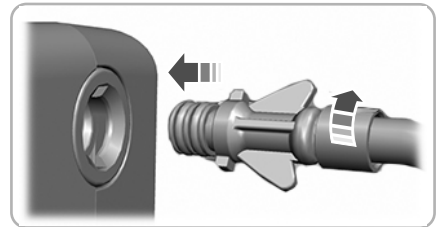
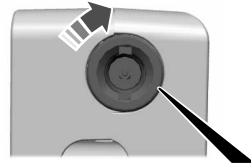
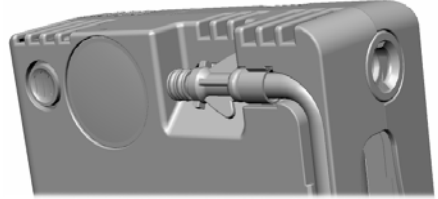

4. Insert the connector and twist it clockwise until the connector wing aligns with the marking on the compressor housing and it is locked in position.
5. Remove the valve cap from the tire valve.

Tire Sealant and Inflator Kit

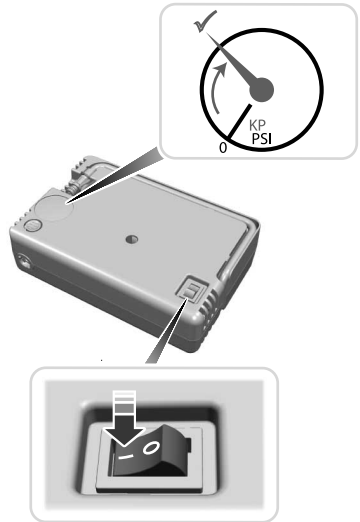
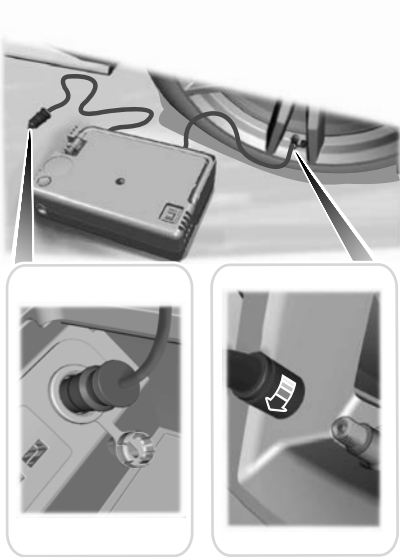

6. Fasten the hose to the tire valve by turning the threaded connector clockwise. Tighten the connection securely.
7. Plug the power cable into the 12-volt power point in the vehicle.
8. Turn the tire inflator kit on by pressing the on/off button.
9. Inflate the tire to the pressure listed on the tire label located on the driver door or the door jamb area. Check the final tire pressure with the compressor turned off to get an accurate pressure reading.

Tire Sealant and Inflator Kit

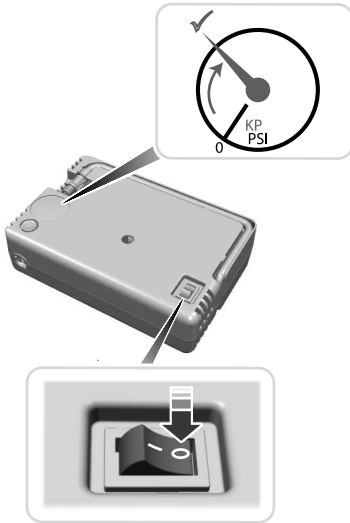

Note: If you experience any unusual vibration, ride disturbance or noise while driving, reduce your speed until you can safely pull off to the side of the road to call for roadside assistance. Do not proceed to the second stage of this operation.

Second Stage: Checking the tire pressure with the inflator kit

WARNING: If the tire does not inflate to the recommended tire pressure within 15 minutes, stop and call roadside assistance.

WARNING: The power plug may get hot after use and should be handled carefully when unplugging.

Check the air pressure of your tires as follows:



10. When the recommended tire pressure is reached, turn off the kit, unplug the power cable, and disconnect the hose from the tire valve. Re-install the valve cap on the tire valve and return the kit to the rear of the vehicle.
11. Remove the red warning sticker found on the casing/housing and place it on top of the instrument panel or the center of the dash.
12. Drive the vehicle 4 mi (6 km) to evenly distribute the sealant inside the tire. Do not exceed 50 mph (80 km/h).
13. After 4 mi (6 km), stop and check the tire pressure. See Second Stage: Checking Tire Pressure.

1. Remove the valve cap from the tire valve.
2. Attach the air compressor hose onto the valve stem by turning clockwise.
3. Push and turn the dial clockwise to the air position.
4. If required, turn on the compressor and adjust the tire to the recommended inflation pressure.

Tire Sealant and Inflator Kit

5. Remove the hoses, re-install the valve cap on the tire valve and return the kit to the rear of the vehicle.

What to do after the tire has been sealed

After using the kit to seal your tire, replace the sealant canister. Sealant canisters and spare parts can be obtained at an authorized dealer. Empty sealant canisters may be disposed of at home. However, canisters still containing liquid sealant should be disposed of in accordance with local waste disposal regulation.

Removal of the sealant canister from the kit



1. Unwrap the dual purpose hose (black tube) from the compressor housing and discard.
2. Unwrap the power cord.

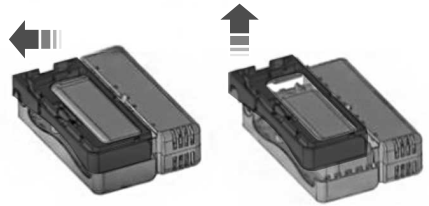

3. Unlatch the sealant bottle cover by sliding it outward, then lift and remove the cover.

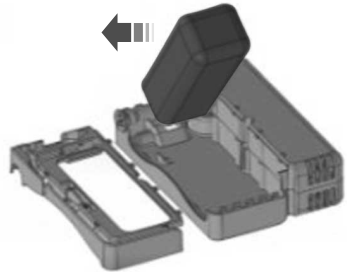

4. Rotate the sealant canister up 60 degrees and slide it outward from the case/housing to remove.

Tire Sealant and Inflator Kit

Installation of the sealant canister to the kit

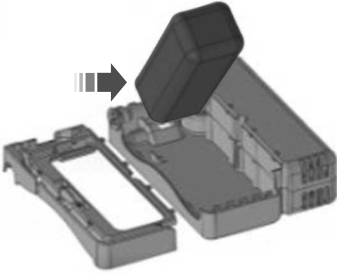

1. With the canister held at an angle to the housing, insert the canister nozzle into the connector and push until seated.
2. Rotate the canister 90 degrees down into the housing/case.
3. Slide the back cover over the cannister until it snaps back into place.
4. Wrap the new dual-purpose hose (black tube) into the channel around the housing/case.
5. Stow the power cord in the side compartment of the housing and stow the accessory power cord into its storage slot on the back cover.

Note: *If you experience any difficulties with the removal or installation of the sealant canister, contact your authorized dealer for assistance. Make sure the sealant compound use by date is on the sealant canister label and can be seen through the rectangular viewing window on the bottom of the kit. Replace the sealant canister after four years of non-use.*

Tire Pressure Monitoring System

WHAT IS THE TIRE PRESSURE MONITORING SYSTEM



The tire pressure monitoring system measures the vehicle's tire pressures. A warning lamp illuminates if one or more tires are significantly underinflated or if there is a system malfunction.

TIRE PRESSURE MONITORING SYSTEM OVERVIEW



WARNING: Under-inflation is the most common cause of tire failures and may result in severe tire cracking, tread separation or blowout, with unexpected loss of vehicle control and increased risk of injury. Under-inflation increases sidewall flexing and rolling resistance, resulting in heat buildup and internal damage to the tire. It also may result in unnecessary tire stress, irregular wear, loss of vehicle control and accidents. A tire can lose up to half of its air pressure and not appear to be flat!



WARNING: To determine the required pressure(s) for your vehicle, see the Safety Compliance Certification Label (on the door hinge pillar, door-latch post or the door edge that meets the door-latch post, next to the driver seat) or the Tire Label on the B-Pillar or the edge of the driver door.

Each tire, including the spare (if provided), should be checked monthly when cold and inflated to the inflation pressure recommended by the vehicle manufacturer on the vehicle placard or tire inflation pressure label. (If your vehicle has tires of a different size than the size indicated on the vehicle placard or tire inflation pressure label, you should determine the proper tire inflation pressure for those tires).

As an added safety feature, your vehicle has been equipped with a Tire Pressure Monitoring System (TPMS) that illuminates a low tire pressure telltale when one or more of your tires is significantly under-inflated. Accordingly, when the low tire pressure telltale illuminates, you should stop and check your tires as soon as possible, and inflate them to the proper pressure. Driving on a significantly under-inflated tire causes the tire to overheat and can lead to tire failure. Under-inflation also reduces fuel efficiency and tire tread life, and may affect the vehicle's handling and stopping ability.

Please note that the TPMS is not a substitute for proper tire maintenance, and it is the driver's responsibility to maintain correct tire pressure, even if under-inflation has not reached the level to trigger illumination of the TPMS low tire pressure telltale.

Your vehicle has also been equipped with a TPMS malfunction indicator to indicate when the system is not operating properly. The TPMS malfunction indicator is combined with the low tire pressure telltale. When the system detects a malfunction, the telltale will flash for approximately one minute and then remain continuously illuminated. This sequence will continue upon subsequent vehicle start-ups as long as the malfunction exists.

Tire Pressure Monitoring System

When the malfunction indicator is illuminated, the system may not be able to detect or signal low tire pressure as intended. TPMS malfunctions may occur for a variety of reasons, including the installation of replacement or alternate tires or wheels on the vehicle that prevent the TPMS from functioning properly. Always check the TPMS malfunction telltale after replacing one or more tires or wheels on your vehicle to ensure that the replacement or alternate tires and wheels allow the TPMS to continue to function properly.



WARNING: Changes or modifications not expressly approved by the party responsible for compliance could void the user's authority to operate the equipment. The term "IC:" before the radio certification number only signifies that Industry Canada technical specifications were met.

This device complies with Part 15 of the FCC Rules and with License exempt RSS Standards of Industry Canada. Operation is subject to the following two conditions:

1. This device may not cause harmful interference, and
2. This device must accept any interference received, including interference that may cause undesired operation.

TIRE PRESSURE MONITORING SYSTEM PRECAUTIONS



WARNING: The tire pressure monitoring system is not a substitute for manually checking tire pressures. You should periodically check tire pressures using a pressure gauge. Failure to correctly maintain tire pressures could increase the risk of tire failure, loss of control, vehicle rollover and personal injury.



WARNING: Do not use the tire pressure displayed in the information display as a tire pressure gauge. Failure to follow this instruction could result in personal injury or death.

Note: *The use of tire sealants can damage the tire pressure monitoring system.*

Note: *If the tire pressure monitor sensor becomes damaged it may not function.*

TIRE PRESSURE MONITORING SYSTEM LIMITATIONS

When the outside temperature drops significantly, the tire pressure could decrease and activate the low tire pressure warning lamp.

The warning lamp could also illuminate when you use a spare wheel, or tire sealant from the inflator kit.

Note: *Regularly checking the vehicle tire pressures can reduce the possibility for the warning lamp to illuminate due to outside air temperature changes.*

Note: *After you inflate the tires to the recommended pressure it could take up to two minutes of driving over 20 mph (32 km/h) for the warning indicator to turn off.*

Tire Pressure Monitoring System

VIEWING THE TIRE PRESSURES

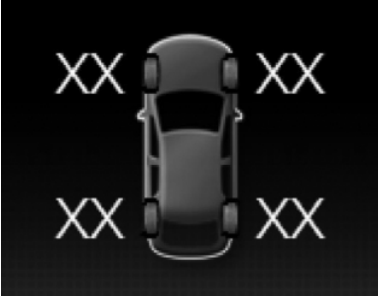

To view the current tire pressures, use the information display or touchscreen.

TIRE PRESSURE MONITORING SYSTEM – TROUBLESHOOTING

TIRE PRESSURE MONITORING SYSTEM – WARNING LAMPS



The low tire pressure warning lamp has combined functions, as it warns you when your tires need air, and when the system is no longer capable of functioning as intended.

Warning Lamp	Possible Cause	Action Required
Solid warning lamp	One or more tires are significantly under inflated	After inflating your tires to the manufacturer's recommended pressure as shown on the tire label, on the edge of driver door or the B-pillar, drive your vehicle for at least two minutes over 20 mph (32 km/h) before the light turns off.
Solid warning lamp or flashing warning lamp	Temporary spare wheel in use	Repair the damaged road wheel and tire and refit it to your vehicle to restore operation of the system.
	Tire pressure monitoring system malfunction	If the tires are inflated to the recommended tire pressures and the temporary spare wheel is not in use, the system detected a fault that requires service. Have your vehicle checked as soon as possible.

Tire Pressure Monitoring System

TIRE PRESSURE MONITORING SYSTEM – INFORMATION MESSAGES

Message	Details
Tire pressure low	After inflating your tires to the manufacturer's recommended pressure as shown on the tire label, on the edge of the driver door or the B-pillar, drive your vehicle for at least two minutes over 20 mph (32 km/h) before the light turns off.
Tire pressure monitor fault	The system has detected a fault that requires service. Have your vehicle checked as soon as possible.
Tire pressure Sensor fault	The system has detected a fault that requires service or a spare tire is in use. Have your vehicle checked as soon as possible.

Changing a Road Wheel

CHANGING A FLAT TIRE - EXCLUDING: POLICE (IF EQUIPPED)

If you get a flat tire while driving, do not apply the brake heavily. Instead, gradually decrease your speed, hold the steering wheel firmly and slowly move to a safe place on the side of the road.

Have a flat serviced by an authorized dealer in order to prevent damage to the tire pressure monitoring system sensors. See **Tire Pressure Monitoring System Overview** (page 435). Replace the spare tire with a road tire as soon as possible. During repairing or replacing of the flat tire, have an authorized dealer inspect the tire pressure monitoring system sensor for damage.

Note: Only use tire sealants in roadside emergencies as they may damage the tire pressure monitoring system sensor. If you must use a sealant, use the Tire Mobility Kit sealant. Replace the tire pressure monitoring system sensor and valve stem on the wheel by an authorized dealer after use of the sealant.

Note: The tire pressure monitoring system indicator illuminates when the spare tire is in use. To restore the full functionality of the tire pressure monitoring system, all road wheels equipped with tire pressure monitoring sensors must be mounted on the vehicle.

Dissimilar Spare Wheel and Tire Assembly Information



WARNING: Failure to follow these guidelines could result in an increased risk of loss of vehicle control, injury or death.

If you have a dissimilar spare wheel and tire, then it is intended for temporary use only. This means that if you need to use it, you should replace it as soon as possible with a road wheel and tire assembly that is the same size and type as the road tires and wheels that were originally provided on your vehicle. If the dissimilar spare tire or wheel is damaged, replace it instead of repairing it.

A dissimilar spare wheel and tire assembly is defined as a spare wheel and tire assembly that is different in brand, size or appearance from the road tires and wheels and can be one of three types:

1. **T-type mini-spare:** This spare tire begins with the letter T for tire size and could have Temporary Use Only molded in the sidewall.
2. **Full-size dissimilar spare with label on wheel:** This spare tire has a label on the wheel that states: THIS WHEEL AND TIRE ASSEMBLY FOR TEMPORARY USE ONLY.

When driving with one of the dissimilar spare tires listed above, do not:

- Exceed 50 mph (80 km/h).
- Load the vehicle beyond maximum vehicle load rating listed on the Safety Compliance Label.
- Tow a trailer.
- Use snow chains on the end of the vehicle with the dissimilar spare tire.
- Use more than one dissimilar spare tire at a time.
- Use commercial car washing equipment.
- Try to repair the dissimilar spare tire.

Changing a Road Wheel

Use of one of the dissimilar spare tires listed above at any one wheel location can compromise any of the following:

- Handling, stability and braking performance.
- Comfort and noise.
- Ground clearance and parking at curbs.
- Winter weather driving capability.
- Wet weather driving capability.
- All-wheel driving capability, if applicable.

3. Full-size dissimilar spare without label on wheel

When driving with the full-size dissimilar spare wheel and tire assembly, do not:

- Exceed 70 mph (113 km/h).
- Use more than one dissimilar spare wheel and tire assembly at a time.
- Use commercial car washing equipment.
- Use snow chains on the end of the vehicle with the dissimilar spare wheel and tire assembly.

Using a full-size dissimilar spare wheel and tire assembly can compromise the effectiveness of the following:

- Handling, stability and braking performance.
- Comfort and noise.
- Ground clearance and parking at curbs.
- Winter weather driving capability.
- Wet weather driving capability.
- All-wheel driving capability.

When driving with the full-size dissimilar spare wheel and tire assembly additional caution should be given to:

- Towing a trailer.
- Driving vehicles equipped with a camper body.
- Driving vehicles with a load on the cargo rack.

Drive cautiously when using a full-size dissimilar spare wheel and tire assembly and seek service as soon as possible.

Tire Change Procedure



WARNING: The jack supplied with this vehicle is only intended for changing a flat tire in an emergency. Do not attempt to do any other work on your vehicle when it is supported by the jack, as your vehicle could slip off the jack. Failure to follow this instruction could result in personal injury or death.



WARNING: To help prevent your vehicle from moving when changing a wheel, shift the transmission into park (P), set the parking brake and use an appropriate block or wheel chock to secure the wheel diagonally opposite to the wheel being changed. For example, when changing the front left wheel, place an appropriate block or wheel chock on the right rear wheel.



WARNING: Never place anything between the vehicle jack and your vehicle.





WARNING: Never place anything between the vehicle jack and the ground.

Changing a Road Wheel

 **WARNING:** Do not attempt to change a tire on the side of the vehicle close to moving traffic. Pull far enough off the road to not obstruct the flow of traffic and avoid the danger of being hit when operating the jack or changing the wheel.

 **WARNING:** Do not get under a vehicle that is supported by a jack.

 **WARNING:** Only use the specified jacking points. If you use any other locations you could damage vehicle components, such as brake lines.

 **WARNING:** Only use the jack provided as original equipment with your vehicle.

 **WARNING:** Make sure there is no grease or oil on the threads or the surface between the wheel studs and the wheel nuts. This can cause the wheel nuts to loosen while driving.

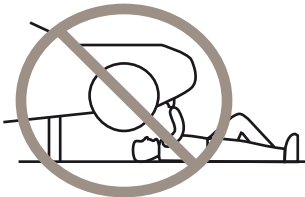

Note: The jack does not require maintenance or additional lubrication over the service life of your vehicle.

Note: Passengers should not remain in your vehicle when the vehicle is being jacked.

1. Park on a level surface, set the parking brake and activate the hazard flashers.
2. Place the transmission in park (P) and turn the engine off.

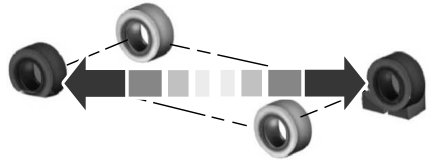

3. Block both the front and rear of the wheel diagonally opposite the flat tire. For example, if the left front tire is flat, block the right rear wheel.



4. Unfold the third row seat if it is in the stowed position, then remove the carpeted cargo area to access the spare tire and jack storage compartment.
5. Turn the wing nut securing the spare tire counterclockwise, remove the wing nut.

Changing a Road Wheel

6. Remove the spare tire, jack and wrench from the spare tire storage compartment.

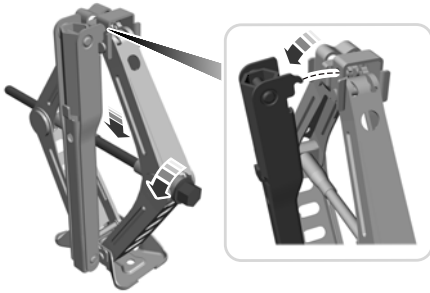

7. Turn the hex nut on the jack counterclockwise to remove the lug wrench from jack. This lowers the jack and loosens the mechanical lock.

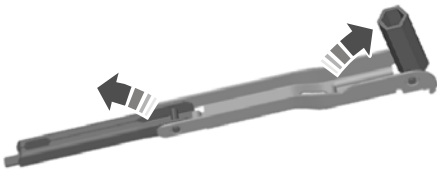

8. Unfold the wrench for use.

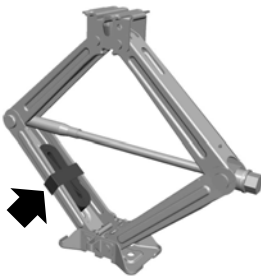

9. Remove the strap from the jack.

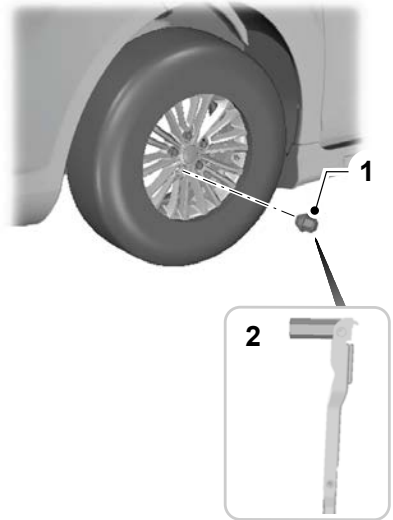

10. Loosen each wheel lug nut one-half turn counterclockwise. Do not remove them until the flat tire is raised off the ground.



11. Find the jacking points shown here, small arrow-shaped marks on the sills show the location of the jacking points.

Changing a Road Wheel

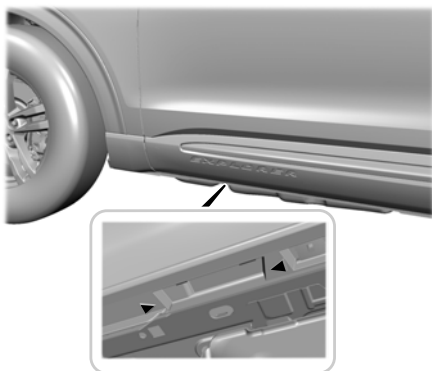

12. Place the jack at the jacking point next to the tire which you are changing. Turn the lug wrench handle clockwise until the flat tire is completely off the ground.



13. Remove the lug nuts with the lug wrench.
14. Replace the flat tire with the spare tire, making sure the valve stem is facing outward.
15. Install the lug nuts snug against the hub. Do not fully tighten the lug nuts until the vehicle is lowered.
16. Turn the wrench handle counterclockwise to lower the vehicle completely.

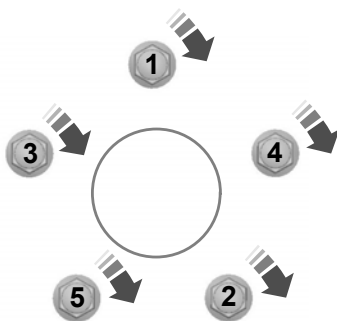

17. Remove the jack and fully tighten the lug nuts in the order shown. See **Wheel Nuts** (page 449).
18. Remove the wheel blocks.

Stowing the Jack

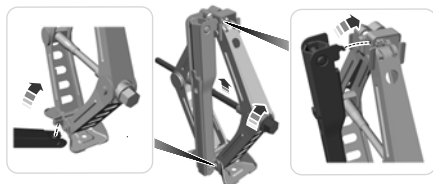

1. To store the folded wrench on the jack, engage the bracket of the jack base and the lug wrench pin, swing the wrench upwards, adjust jack height until the wrench hook engages the hole on jack. Tighten the hex nut clockwise by hand until secure.
2. Place the jack in the spare tire compartment, install the wing nut and tighten clockwise by hand until secure.

Changing a Road Wheel

Stowing the flat tire

You cannot store the full-sized road wheel in the temporary spare tire well.

1. Find the flat tire retainer strap tucked inside the jack channel. Lower the carpeted load floor.
2. Stow the flat tire in the cargo area on the load floor with the wheel facing up. Secure the flat tire with the retainer strap by following the next steps.



3. Locate the rear left side and right side cargo tie-down rings. Push the loop end of the retainer strap through one cargo tie-down ring. Thread the non-loop end through the loop.
4. Weave the retainer strap through the wheel openings.

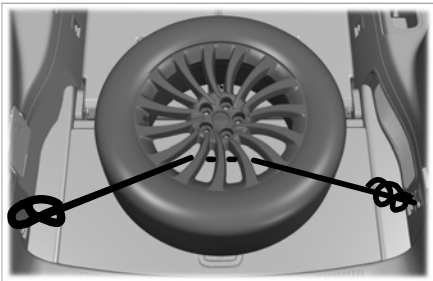

5. Locate the front cargo tie-down in the opposite rear corner of the cargo area. Thread the retainer strap through the tie-down and pull tight.

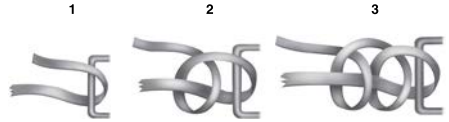

6. Secure the flat tire by tying two half hitch knots.

CHANGING A FLAT TIRE - POLICE

If you get a flat tire while driving, do not apply the brake heavily. Instead, gradually decrease your speed, hold the steering wheel firmly and slowly move to a safe place on the side of the road.

Have a flat serviced by an authorized dealer in order to prevent damage to the tire pressure monitoring system sensors. See **Tire Pressure Monitoring System Overview** (page 435). Replace the spare tire with a road tire as soon as possible. During repairing or replacing of the flat tire, have an authorized dealer inspect the tire pressure monitoring system sensor for damage.

Note: Only use tire sealants in roadside emergencies as they may damage the tire pressure monitoring system sensor. If you must use a sealant, use the Tire Mobility Kit sealant. Replace the tire pressure monitoring system sensor and valve stem on the wheel by an authorized dealer after use of the sealant.

Changing a Road Wheel

Note: *The tire pressure monitoring system indicator illuminates when the spare tire is in use. To restore the full functionality of the tire pressure monitoring system, all road wheels equipped with tire pressure monitoring sensors must be mounted on the vehicle.*

Dissimilar Spare Wheel and Tire Assembly Information



WARNING: Failure to follow these guidelines could result in an increased risk of loss of vehicle control, injury or death.

If you have a dissimilar spare wheel and tire, then it is intended for temporary use only. This means that if you need to use it, you should replace it as soon as possible with a road wheel and tire assembly that is the same size and type as the road tires and wheels that were originally provided on your vehicle. If the dissimilar spare tire or wheel is damaged, replace it instead of repairing it.

A dissimilar spare wheel and tire assembly is defined as a spare wheel and tire assembly that is different in brand, size or appearance from the road tires and wheels and can be one of two types:

2. Full-size dissimilar spare with label on wheel: This spare tire has a label on the wheel that states: THIS WHEEL AND TIRE ASSEMBLY FOR TEMPORARY USE ONLY.

When driving with one of the dissimilar spare tires listed above, do not:

- Exceed 50 mph (80 km/h).
- Load the vehicle beyond maximum vehicle load rating listed on the Safety Compliance Label.
- Tow a trailer.

- Use snow chains on the end of the vehicle with the dissimilar spare tire.
- Use more than one dissimilar spare tire at a time.
- Use commercial car washing equipment.
- Try to repair the dissimilar spare tire.

Use of one of the dissimilar spare tires listed above at any one wheel location can compromise any of the following:

- Handling, stability and braking performance.
- Comfort and noise.
- Ground clearance and parking at curbs.
- Winter weather driving capability.
- Wet weather driving capability.
- All-wheel driving capability, if applicable.

3. Full-size dissimilar spare without label on wheel

When driving with the full-size dissimilar spare wheel and tire assembly, do not:

- Exceed 70 mph (113 km/h).
- Use more than one dissimilar spare wheel and tire assembly at a time.
- Use commercial car washing equipment.
- Use snow chains on the end of the vehicle with the dissimilar spare wheel and tire assembly.

Using a full-size dissimilar spare wheel and tire assembly can compromise the effectiveness of the following:

- Handling, stability and braking performance.
- Comfort and noise.
- Ground clearance and parking at curbs.
- Winter weather driving capability.
- Wet weather driving capability.
- All-wheel driving capability.

Changing a Road Wheel

When driving with the full-size dissimilar spare wheel and tire assembly additional caution should be given to:

- Towing a trailer.
- Driving vehicles equipped with a camper body.
- Driving vehicles with a load on the cargo rack.

Drive cautiously when using a full-size dissimilar spare wheel and tire assembly and seek service as soon as possible.

Tire Change Procedure

WARNING: The jack supplied with this vehicle is only intended for changing a flat tire in an emergency. Do not attempt to do any other work on your vehicle when it is supported by the jack, as your vehicle could slip off the jack. Failure to follow this instruction could result in personal injury or death.

WARNING: To help prevent your vehicle from moving when changing a wheel, shift the transmission into park (P), set the parking brake and use an appropriate block or wheel chock to secure the wheel diagonally opposite to the wheel being changed. For example, when changing the front left wheel, place an appropriate block or wheel chock on the right rear wheel.

WARNING: Never place anything between the vehicle jack and your vehicle.

WARNING: Never place anything between the vehicle jack and the ground.

WARNING: Do not attempt to change a tire on the side of the vehicle close to moving traffic. Pull far enough off the road to not obstruct the flow of traffic and avoid the danger of being hit when operating the jack or changing the wheel.

WARNING: Do not get under a vehicle that is supported by a jack.

WARNING: Only use the specified jacking points. If you use any other locations you could damage vehicle components, such as brake lines.

WARNING: Only use the jack provided as original equipment with your vehicle.

WARNING: Make sure there is no grease or oil on the threads or the surface between the wheel studs and the wheel nuts. This can cause the wheel nuts to loosen while driving.

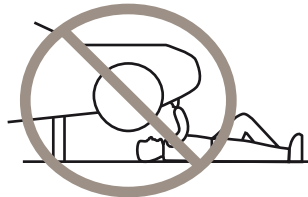

Note: The jack does not require maintenance or additional lubrication over the service life of your vehicle.

Note: Passengers should not remain in your vehicle when the vehicle is being jacked.

1. Park on a level surface, set the parking brake and activate the hazard flashers.
2. Place the transmission in park (P) and turn the engine off.

Changing a Road Wheel

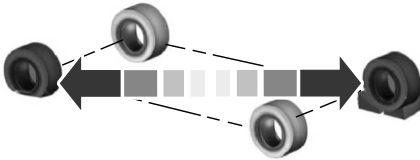

3. Block both the front and rear of the wheel diagonally opposite the flat tire. For example, if the left front tire is flat, block the right rear wheel.



4. Turn the wing nut securing the spare tire counterclockwise, remove the wing nut.
5. Remove the spare tire, jack and wrench from the spare tire storage compartment.

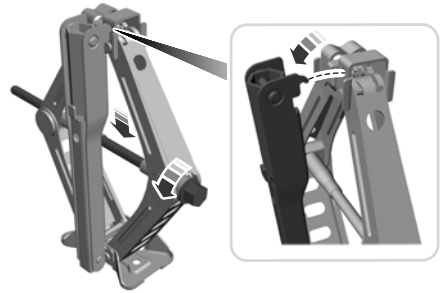

6. Turn the hex nut on the jack counterclockwise to remove the lug wrench from jack. This lowers the jack and loosens the mechanical lock.



7. Unfold the wrench for use.



8. Remove the strap from the jack.

Changing a Road Wheel

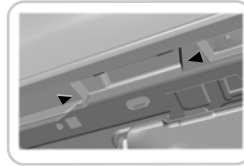
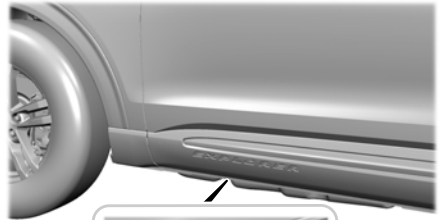
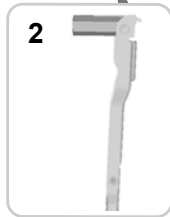
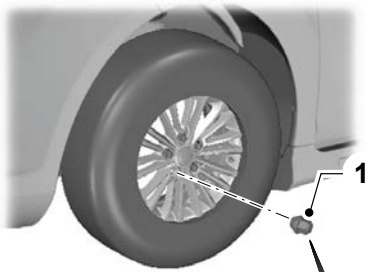

9. Loosen each wheel lug nut one-half turn counterclockwise. Do not remove them until the flat tire is raised off the ground.



10. Find the jacking points shown here, small arrow-shaped marks on the sills show the location of the jacking points.

11. Place the jack at the jacking point next to the tire which you are changing. Turn the lug wrench handle clockwise until the flat tire is completely off the ground.



12. Remove the lug nuts with the lug wrench.
13. Replace the flat tire with the spare tire, making sure the valve stem is facing outward.
14. Install the lug nuts snug against the hub. Do not fully tighten the lug nuts until the vehicle is lowered.
15. Turn the wrench handle counterclockwise to lower the vehicle completely.

Changing a Road Wheel

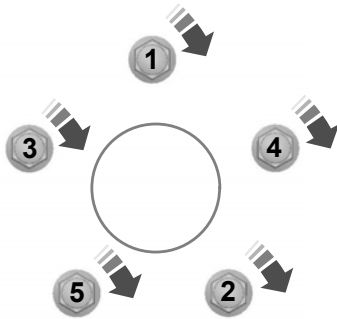

16. Remove the jack and fully tighten the lug nuts in the order shown. See **Wheel Nuts** (page 449).
17. Remove the wheel blocks.

Stowing the Jack

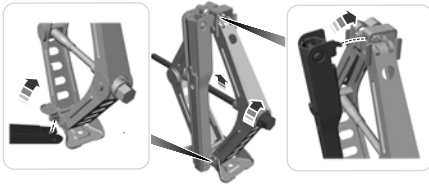

1. To store the folded wrench on the jack, engage the bracket of the jack base and the lug wrench pin, swing the wrench upwards, adjust jack height until the wrench hook engages the hole on jack. Tighten the hex nut clockwise by hand until secure.
2. Place the jack in the spare tire compartment, install the wing nut and tighten clockwise by hand until secure.

Stowing the flat tire

1. Secure the flat road wheel and tire in the spare tire storage compartment under the trunk load floor. Place the flat road wheel and tire over the stowed jack and secure with the wing nut.

WHEEL NUTS

WARNING: When you install a wheel, remove any corrosion, dirt or foreign materials present on the mounting surfaces of the wheel or the surface of the wheel hub, brake drum or brake disc that contacts the wheel. Make sure to secure any fasteners that attach the rotor to the hub so they do not interfere with the mounting surfaces of the wheel. Installing wheels without following these steps can cause the wheel nuts to loosen and the wheel to come off while your vehicle is in motion, resulting in loss of vehicle control, personal injury or death.

Bolt Size	lb.ft (Nm) ¹
M14 x 1.5	150 lb.ft (204 Nm)

¹Torque specifications are for nut and bolt threads free of dirt and rust. Use only our recommended replacement wheel nuts and or wheel bolts.

Retighten the wheel nuts to the specified torque within 100 mi (160 km) after any wheel disturbance, such as tire rotation, changing a flat tire or wheel removal.

Changing a Road Wheel



A Wheel pilot bore.

Inspect the wheel pilot hole and mounting surface prior to installation. Remove any visible corrosion or loose particles.

Vehicle Identification

VEHICLE IDENTIFICATION NUMBER

LOCATING THE VEHICLE IDENTIFICATION NUMBER

The vehicle identification number is on the left-hand side of the instrument panel.

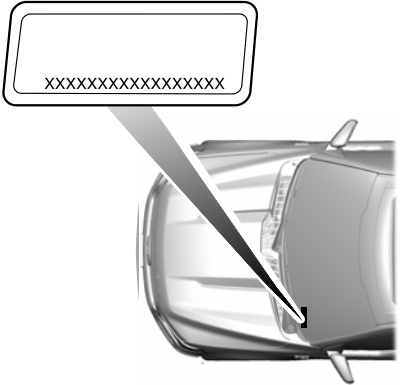

Note: In the illustration, XXXX is representative of your vehicle identification number.

VEHICLE IDENTIFICATION NUMBER OVERVIEW

The vehicle identification number contains the following information:

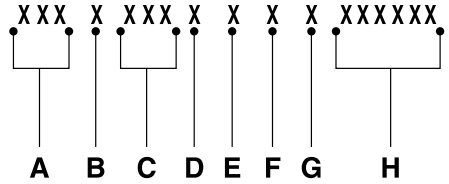

- A World manufacturer identifier.
- B Brake system, gross vehicle weight rating, restraint devices and their locations.
- C Make, vehicle line, series, body type.
- D Engine or motor type.
- E Check digit.
- F Model year.
- G Assembly plant.
- H Production sequence number.

Connected Vehicle

WHAT IS A CONNECTED VEHICLE

A connected vehicle has technology that allows your vehicle to connect to a mobile network and for you to access a range of features. When used in conjunction with the FordPass app, it could allow you to monitor and control your vehicle further, for example checking the tire pressures, the fuel level and the vehicle location. For additional information, refer to the local Ford website.

CONNECTED VEHICLE REQUIREMENTS

Connected service and related feature functionality requires a compatible vehicle network.

Some remote features require additional service activation. Log in to your Ford account for details. Some restrictions, third party terms and message or data rates may apply.

CONNECTED VEHICLE LIMITATIONS

Evolving technology, cellular networks, or regulations could affect functionality and availability, or continued provision of some features. These changes could even stop some features from functioning.

CONNECTING THE VEHICLE TO A MOBILE NETWORK

WHAT IS THE MODEM



The modem allows access to a range of features built into your vehicle.

ENABLING AND DISABLING THE MODEM

1. From the settings menu, press Network & Internet. See **Center Display** (page 467).
2. Switch Vehicle Connectivity on or off.

CONNECTING FORDPASS TO THE MODEM

1. Make sure that the modem is enabled using the vehicle settings menu.
2. Open the FordPass app on your device and log in.
3. Add your vehicle or select your vehicle if already added.
4. Select the option to activate your vehicle.
5. Make sure that the name on the screen matches the name shown in your FordPass account.
6. Confirm that FordPass account is connected to the modem.

CONNECTING THE VEHICLE TO A WI-FI NETWORK

1. From the settings menu, press Network & Internet. See **Center Display** (page 467).
2. Press Wi-Fi.
3. Switch Wi-Fi on.
4. Select an available Wi-Fi network.

Note: Enter the network password to connect to a secure network.

CONNECTED VEHICLE SETTINGS

From the settings menu, press Privacy and Data Sharing.

Connected Vehicle

You can adjust several settings, such as:

- Share vehicle data.
- Share vehicle location.
- Share driving data.

Note: Depending on your vehicle, different options may be available.

Note: Editing connectivity settings could result in some features not operating correctly or at all. When you edit connectivity settings, pop-up messages may appear to notify you that services will not work without that setting. If you switch a feature on, pop-up messages could appear informing you of the settings that will be turned on. Some features, for example driver assistance features, use map data. We recommend having all connected vehicle settings enabled to allow the map content to be updated to the latest version.



Press the button next to a menu option for more information.

CONNECTED VEHICLE – TROUBLESHOOTING

CONNECTED VEHICLE – FREQUENTLY ASKED QUESTIONS

Why is my FordPass app not connecting to my vehicle?

- The modem is not enabled. Switch vehicle connectivity on.
- The network signal is weak. Move your vehicle closer to a place where the network signal is not obstructed.
- The modem or gateway may need to be reset. Reboot the touchscreen to reset the modem or gateway. See **Rebooting the Displays** (page 469).

Why can I not connect to a Wi-Fi network?

- You entered the wrong network password. Enter the correct password.
- The network signal is weak. Move your vehicle closer to the Wi-Fi router or to a place where the network signal is not obstructed.
- There are multiple access points in range with the same network name. Choose a unique name for your network. Do not use the default name unless it contains a unique identifier, for example as part of the MAC address.

Why does the Wi-Fi connection disconnect after successful connection?

- The network signal is weak. Move your vehicle closer to the Wi-Fi router or to a place where the network signal is not obstructed.

What can I do if I am close to a Wi-Fi router but the network signal strength is weak?

- If your vehicle has a heated windshield, position your vehicle so that the windshield is not facing the Wi-Fi router.
- If your vehicle has metallic tinting on the windows but not on the windshield, position your vehicle so that the windshield is facing the Wi-Fi router or open the windows that are facing the router.
- If your vehicle has metallic tinting on the windows and the windshield, open the windows that are facing the router.
- If your vehicle is in a garage and you have the garage door closed, open the garage door as it could block the signal.

Connected Vehicle

Why can I not see a network I expect to see in the list of available networks?

- The network is hidden. Make the network visible and try again, or manually add a network in the Wi-Fi settings menu.
- Some network security types are not supported, for example WEP.

Why do software downloads take too long?

- The network signal is weak. Move your vehicle closer to the Wi-Fi router or to a place where the network signal is not obstructed.
- Wi-Fi network is in high demand or has a slow Internet connection. Use a more reliable Wi-Fi network.

Why does the software not update when the system seems to connect to a Wi-Fi network and the signal strength is excellent?

- No software update is available at this time.
- Select automatic updates option in the settings menu to enable automatic software update or contact an authorized dealer.
- There could be a connection problem. Test the network using another device.

Why is a cloud-based feature not connecting to my vehicle?

- The modem or gateway may need to be reset. Reboot the touchscreen to reset the modem or gateway. See **Rebooting the Displays** (page 469).

Vehicle Hotspot

SETTING UP A VEHICLE HOTSPOT

With a data plan, your hotspot can provide devices in and around your vehicle with Wi-Fi data.

Note: *A mobile device is required to complete hotspot setup.*

1. From the apps menu, press Hotspot. See **Center Display** (page 467).
2. Connect your device to the vehicle hotspot by scanning the code on the touchscreen with your device or following the text instructions on the touchscreen.

Activating a Trial or Purchasing a Data Plan

1. Connect a device to your vehicle hotspot. The vehicle network carrier's service activation website opens on your device.

Note: *If the website does not open, open a new website and it redirects to the vehicle network carrier's website.*

2. Follow the instructions on the carrier portal to purchase a plan or start a trial.

Note: *Visit the vehicle network carrier's website to purchase more data.*

Note: *Hotspot services are subject to your vehicle network carrier agreement, coverage and availability.*

VEHICLE HOTSPOT SETTINGS

You can change the following in the vehicle hotspot settings menu:

- Vehicle hotspot name or password.
- Vehicle hotspot frequency.

Changing the Vehicle Hotspot Name or Password

The hotspot information can only be updated once you activate the hotspot.

1. From the apps menu, press Hotspot. See **Center Display** (page 467).
2. Press settings.
3. Press Network name.
4. Enter your required network name.
5. Press Enter.
6. Press Password.
7. Enter your required password.
8. Press Enter.

Changing the Vehicle Hotspot Frequency

The vehicle hotspot frequency band is selectable depending upon your device capabilities. You cannot connect your device to the vehicle hotspot if it does not support the selected frequency band.

1. From the apps menu, press Hotspot. See **Center Display** (page 467).
2. Press settings.
3. Press Frequency.
4. Select a frequency.

Vehicle Hotspot

VEHICLE HOTSPOT – TROUBLESHOOTING

VEHICLE HOTSPOT – FREQUENTLY ASKED QUESTIONS

Why can I not see the vehicle hotspot name when I search for Wi-Fi networks on my cell phone or other device?

- Make sure the vehicle hotspot is switched on.
- Make sure hidden network is switched off under the hotspot security menu.
- Check what frequency the hotspot is transmitting in the vehicle hotspot settings menu. If the frequency is 5 GHz and your device cannot see the network, change the frequency to 2.4 GHz.

What should I do if my phone shows "No internet connection" when connecting to the vehicle hotspot?

- Check the status of your data plan.
- If your subscription is active, try moving the vehicle to an open area to improve reception.

What should I do if my phone shows "This network is operating on Wi-Fi channels in use by several other nearby networks" when connecting to the vehicle hotspot?

- Restart your vehicle.
- Move your vehicle to a different location.
- In the vehicle hotspot settings, switch between the 2.4 GHz and 5 GHz frequency.

How do I remove the vehicle from the vehicle network carrier's account?

- Contact your vehicle network carrier.

Audio System

AUDIO SYSTEM PRECAUTIONS



WARNING: Driving while distracted can result in loss of vehicle control, crash and injury. We strongly recommend that you use extreme caution when using any device that may take your focus off the road. Your primary responsibility is the safe operation of your vehicle. We recommend against the use of any hand-held device while driving and encourage the use of voice-operated systems when possible. Make sure you are aware of all applicable local laws that may affect the use of electronic devices while driving.

Listening to loud audio for long periods of time could damage your hearing.

SWITCHING THE AUDIO UNIT ON AND OFF



Press the button on the volume control.

SELECTING THE AUDIO SOURCE

Home Screen View

From the apps menu, press your preferred audio source.

Note: Available audio sources are listed on the Apps menu.

Now Playing View

Press the Audio Source dropdown menu and scroll through the audio sources.

MEDIA CONTROL BUTTONS



Press to play a track. Press again to pause the track.

Note: Not all sources can be paused.

Note: In case the source is not paused audio is muted.



Press the button to skip to the next track.

Press and hold the button to fast forward through the track.



Press the button once to return to the beginning of a track.

Repeatedly press the button to return to previous tracks.

Press and hold the button to fast rewind through the track.



Press the button on the touchscreen to switch shuffle mode on or off.

Note: Not all sources have shuffle mode.



Press the button on the touchscreen to change repeat mode.

Note: Not all sources have repeat mode.

Audio System

ADJUSTING THE VOLUME



E391071

Turn to adjust the volume.

Some vehicles may be able to adjust the volume using buttons on the steering wheel.

SETTING A MEMORY PRESET

1. Select a station or channel.
2. Press and hold a memory preset button on the touchscreen.

Note: *The audio mutes briefly while the system saves the preset and returns once it is stored.*

Note: *You can save presets from multiple sources to the memory preset bar.*

ADJUSTING THE SOUND SETTINGS

1. From the settings menu, press Sound. See **Center Display** (page 467).

From the menu, you can adjust the following:

- Tone.
- Balance and fade.
- Speed compensated volume.
- Occupancy mode/Sound mode.
- Volume settings.

Note: *Depending on your vehicle options, not all settings are available and your vehicle may be equipped with additional tone settings.*

SETTING THE CLOCK AND DATE

Clock Settings

To access clock settings:

1. From the settings menu, press System. See **Center Display** (page 467).
2. Press Time.

From the menu you can do the following:

- Have the system automatically set the time zone.
- Manually select a time zone.
- Switch the displayed time between 12 or 24-hour formats.

Note: *Manual time zone selection is only available if automatic time zone is switched off.*

AM/FM RADIO

AM/FM RADIO LIMITATIONS

The further you travel from an AM or FM station, the weaker the signal and the weaker the reception.

Audio System

Hills, mountains, tall buildings, bridges, tunnels, freeway overpasses, parking garages, dense tree foliage and thunderstorms can interfere with the reception.

When you pass a ground-based broadcast repeating tower, a stronger signal may overtake a weaker one and result in the audio system muting.

SELECTING AN AM/FM RADIO STATION

Manually Selecting a Radio Station



Press the button on the radio tuner to go up the frequency band.



Press the button on the radio tuner to go down the frequency band.

Using Seek



Press to seek the next station up the frequency band.

Press and hold to quickly seek up the frequency band.



Press to seek the next station down the frequency band.

Press and hold to quickly seek down the frequency band.

DIGITAL RADIO (IF EQUIPPED)

WHAT IS DIGITAL RADIO

HD Radio™ technology is the digital evolution of analog AM/FM radio.

For additional information, visit www.HDRadio.com.

HD Radio Technology is manufactured under license from iBiquity Digital Corporation and foreign patents. HD Radio and the HD and HD Radio logos are proprietary trademarks of XPERI. The vehicle manufacturer and XPERI are not responsible for the content sent using HD Radio technology. Content may be changed, added or deleted at any time at the station owner's discretion.

HOW DOES DIGITAL RADIO WORK

Your system has a special receiver that allows it to receive digital broadcasts in addition to analog broadcasts.

HD1 signifies the main programming status and is available in both analog and digital broadcasts. Other multicast stations are only available digitally and could contain new or different content.

Note: *When the system first receives an HD1 station, it plays the station in the analog version until it verifies the station is an HD Radio station. Then it shifts to the digital version.*

Note: *There is an audio mute delay when switching to an HD2 or HD3 station because the system has to reacquire and decode the digital signal.*

DIGITAL RADIO LIMITATIONS

If you are outside the reception area, the system could not work.

If you are on the fringe of the reception area, the station could mute due to weak signal strength.

Note: *If you are listening to HD1, the system changes back to the analog broadcast until the digital broadcast is available again. If you are listening to any other multicast channels, the station mutes and stays muted unless it is able to connect to the digital signal again.*

Audio System

Depending on the station quality, you could hear a slight sound change when the station changes between analog and digital audio.

You cannot access a saved HD station if your vehicle is outside the station's reception area.

SWITCHING DIGITAL RADIO RECEPTION ON AND OFF

1. From the apps menu, press AM or FM. See **Center Display** (page 467).
2. Press Settings.
3. Switch HD radio on or off.

DIGITAL RADIO INDICATORS

HD Radio Indicator

The indicator appears when HD Radio is on and you tune to a station broadcasting HD Radio technology.



The color of the indicator changes to indicate the system status.

Gray indicates the system is acquiring a digital station.

Orange indicates digital audio is playing.

Multicast Indicator

The multicast indicator appears if the current station is broadcasting multiple digital broadcasts. The highlighted numbers indicate additional digital channels available.

Note: For stations that have more than one HD multicast, the HD indicator and radio text appears as a button. Press the button to cycle through all of the HD stations on that specific frequency.

SATELLITE RADIO (IF EQUIPPED)

WHAT IS SATELLITE RADIO

Your factory-installed SiriusXM radio system includes a limited subscription term, which begins on the date of sale or lease of your vehicle. See an authorized dealer for availability.

For additional information about extended subscription terms, visit <https://www.SiriusXM.com> in the United States, <https://www.SiriusXM.ca> in Canada, or call SiriusXM at 1-888-539-7474.

Note: SiriusXM reserves the unrestricted right to change, rearrange, add or delete programming including canceling, moving or adding particular channels, and its prices, at any time, with or without notice to you. Neither SiriusXM and its affiliates nor Ford Motor Company and its affiliates will be liable to you or any third party for any such modification, suspension or termination.

SATELLITE RADIO LIMITATIONS

For optimal reception performance, keep the antenna clear of snow and ice build-up and keep luggage and other material as far away from the antenna as possible. Placing luggage over the antenna may reduce performance. Factory-installed and aftermarket vehicle structures including, but not limited to, roof racks and soft top roofs in a partially open position could reduce reception performance.

Audio System

Hills, mountains, tall buildings, bridges, tunnels, freeway overpasses, parking garages, dense tree foliage and thunderstorms can interfere with your reception.

When you pass a ground-based broadcast-repeating tower, a stronger signal may overtake a weaker one and could result in the audio system muting. Your display could show an error message to indicate the interference.

LOCATING THE SATELLITE RADIO IDENTIFICATION NUMBER

1. Select SiriusXM as the audio source.
2. Tune to channel 0.

SELECTING A CHANNEL

Manually Selecting a Channel

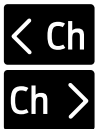

Press the button to find the previous or next available radio channel.

Linear Tuner

The linear tuner is displayed when manually selecting a channel. You can swipe left or right on the linear tuner carousel to navigate through the channel list. Tap on a channel title to listen to it.

Using Direct Tune

1. Press the channel up or down button to open the linear tuner screen.
2. Press Direct Tune to open the number pad.
3. Enter the channel you prefer.

Using Seek



Press either button.



Using the Channel List

1. Press Browse.
2. Select a channel.

SATELLITE RADIO SETTINGS

Subscription

Your subscription status is displayed. You can subscribe or manage your subscription directly from the touchscreen.

SiriusXM Favorites

While you are listening to SiriusXM, you can save favorites by:

- Tapping the currently tuned channel or show logo on the SiriusXM audio screen.
- Tuning to a channel or show you want to save as a favorite. Navigate to the SiriusXM Favorites screen and press the Add Current button. The currently tuned channel or show is saved as a favorite.
- Saving a radio preset. This saves the currently tuned SiriusXM channel or show as a favorite

Note: *Requires a trial or active subscription to use.*

Listening History

Listening history is a list of recently listened to SiriusXM content. You can view, manage and reset the listening history using the controls on the touchscreen.

Audio System

Note: Requires a trial or active subscription to use.

Help and Support

You can contact SiriusXM Customer Care directly from the operating system and view information required to manage your SiriusXM account.

SETTING AN ALERT



Set a notification for the current song, artist, or sports team by pressing the icon. The system alerts you when it plays again on any channel. Selecting this button allows you to enable and edit alerts.

Note: Notifications can be switched on or off and edited in the satellite radio settings.

Audio System

AUDIO SYSTEM – TROUBLESHOOTING

AUDIO SYSTEM – INFORMATION MESSAGES

Satellite Radio Troubleshooting

Error Message	Potential Effects	Recommended Action
Connectivity Disabled	Internet streaming and On Demand shows are unavailable and some SiriusXM features are disabled.	Internet connectivity is turned off. See Connected Vehicle (page 452).
No Internet	Audio system may mute. Switch to Satellite button may be displayed on the SiriusXM audio screen if the channel is also available via satellite.	Operating system attempts to connect. See Satellite Radio Limitations (page 460). Switch to a satellite connection for the current channel if the option is available.
No Satellite Signal	Audio system may mute. Switch to Internet button may be displayed on the SiriusXM audio screen if the channel is also available via streaming.	Antenna may be obstructed or satellite reception is weak in your location. See Satellite Radio Limitations (page 460). Switch to an internet connection for the current channel if the option is available.
Slow Network Connection	Audio system may mute while the audio attempts to load.	Allow some time for the audio to load or tune to a different channel.
Channel Unavailable	Audio system may mute. Radio may tune to a different channel.	A temporary update may be in progress. Allow some time before retrying to tune to the channel. If the issue continues, the channel may no longer be available.
Episode Unavailable	Audio system may mute. Radio may tune to a different channel.	A temporary update may be in progress. Allow some time before retrying to play the episode. If the issue continues, the episode may no longer be available.

Audio System

Error Message	Potential Effects	Recommended Action
Something went wrong	Audio system may mute. Radio may tune to a different channel.	Allow some time and retry the action.
Subscribe to Listen	Cannot listen to selected content. Content may appear grayed out and some features may be disabled.	<p>Your subscription has expired or you have not yet subscribed for access to the listed content. Navigate to Subscription under the Satellite Radio Settings menu. If you have an active subscription which includes the listed channel or content and you see this error, you may need to refresh your radio. To refresh your SiriusXM radio, visit www.siriusxm.com/refresh in the US, or www.siriusxm.ca/refresh in Canada.</p> <p>You may need to provide your SiriusXM Radio identification number. See Locating the Satellite Radio Identification Number (page 461).</p>

Audio System

Error Message	Potential Effects	Recommended Action
Upgrade to Listen	Cannot listen to selected content. Content may appear grayed out and some features may be disabled.	<p>Your subscription does not include access to the listed content. You may need to upgrade your subscription. Navigate to Subscription under the Satellite Radio Settings menu. If you have an active subscription which includes the listed channel or content and you see this error, you may need to refresh your radio. To refresh your SiriusXM radio, visit www.siriusxm.com/refresh in the US, or www.siriusxm.ca/refresh in Canada. You may need to provide your SiriusXM Radio identification number. See Locating the Satellite Radio Identification Number (page 461).</p>
Location Restricted Content	Audio may mute. Not available in your location or Unable to determine your location may be displayed.	Content is not available in your location or SiriusXM is unable to determine your location. Tuning to a different channel may resolve the issue.
Channel Blocked	Audio may mute. Radio may tune to a different channel.	<p>The Block Explicit Content filter is turned on. Navigate to Listener Settings under the Satellite Radio Settings menu to access the Block Explicit Content filter. Navigate to Listener Settings. See Satellite Radio Settings (page 461).</p>
Antenna Problem or Hardware Problem	Audio may mute. Access to SiriusXM features may be unavailable.	If issue persists, have the system checked as soon as possible.

Audio System

Error Message	Potential Effects	Recommended Action
SiriusXM Updating...	Audio may mute.	Allow SiriusXM some time to complete updating.
Loading...	Audio may mute. Content may be temporarily unavailable while loading.	No action necessary. If loading time is longer than usual, See Satellite Radio Settings (page 461).
SiriusXM Loading...	Audio may mute. Content and controls may be temporarily unavailable.	No action necessary. Allow SiriusXM some time to finish loading.

Center Display

CENTER DISPLAY OVERVIEW



WARNING: Driving while distracted can result in loss of vehicle control, crash and injury. We strongly recommend that you use extreme caution when using any device that may take your focus off the road. Your primary responsibility is the safe operation of your vehicle. We recommend against the use of any hand-held device while driving and encourage the use of voice-operated systems when possible. Make sure you are aware of all applicable local laws that may affect the use of electronic devices while driving.

For your safety, features that are not critical while driving are not available when the vehicle is moving at or above 5 mph (8 km/h).

Note: Illustrations are provided for conceptual understanding only and may appear differently on your vehicle.

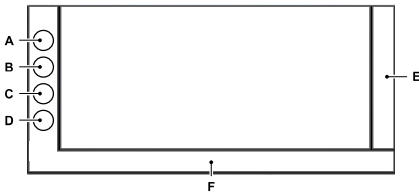

- A Home screen.
- B Controls. See **Controls** (page 468).
- C Apps. See **Apps** (page 468).
- D Android Auto or Apple CarPlay. See **Switching Android Auto™ On and Off** (page 475). See **Switching Apple CarPlay On and Off** (page 475).

- E Status bar. See **Status Bar** (page 467).
- F Climate control. See **Climate Control** (page 139).



If you see this icon, press it for more information.



If you see this icon, press it to open the settings menu for the app or feature.



If you see this icon, press it to search within that app or feature.

STATUS BAR

The following icons can appear in the status bar.

Notification Center



Press to view notifications.



Unread notifications available. Press to view notifications.

Device Signal



Device signal strength.



Device signal roaming.



Device signal not available.

Vehicle Signal



Data unavailable or disabled.

Center Display



Wi-Fi connected.



Wi-Fi not connected.



Wi-Fi connected, internet unavailable.



Vehicle signal strength.



Vehicle signal roaming.



Vehicle signal not available.

Privacy



Vehicle location sharing on.



Microphone active.

APPS



Press to see a list of apps. To open an app, select the app.

You can download additional apps on your vehicle through Google Play. To download additional apps, make sure your vehicle is in park (P), connected to the internet and signed in to an active personal Google Account.

When you start an app through the system for the first time, you could be asked to grant certain permissions. You can review and change the permissions at any time when your vehicle is not moving. We recommend that you check the app provider's terms and conditions and privacy policy before using their app. Make

sure that you have an active account for apps that you want to use through the system. Some apps work with no setup. Others require you to configure personal settings and enable data connectivity before you can use them.

Customizing the Apps Screen

1. Press and hold an app.
2. Drag the app to a new location.

CONTROLS



Press to open the controls screen where you can turn common features off and on.

Customizing the Controls Screen

1. Press and hold a control tile.
2. Drag the control tile to a new location.

SETTINGS



From the apps menu, press to open the settings app.

You can change the display language and other measurement units under the System menu.



If you see this icon next to a menu option, press it for more information.



If you see this icon in the top corner, press it to open the settings for that app or feature.

Display Settings

From the display menu you can do the following:

Center Display

- Switch the calm screen on.
- Manually adjust the screen brightness.
- Set the display mode.

Touchscreen Brightness

To manually adjust the screen brightness, use the plus or minus buttons.

Note: *The display brightness is limited if the settings of the instrument panel lighting brightness are set to the highest or lowest setting.*

DRIVER ASSISTANCE MENU

To access the driver assistance menu:

1.  From the apps menu, press to open the settings app.
2. Press Driver Assistance.

REBOOTING THE DISPLAYS

If the center display or instrument cluster screens go blank or appear to not be functioning correctly, you can reboot it by following the below procedure.

Quickly press the audio system power button 5 times.

Contact an authorized dealer if the screens do not reboot properly.

Voice Interaction

WHAT IS VOICE INTERACTION

Voice Interaction allows you to control vehicle features using conversational requests.

SETTING YOUR DEFAULT ASSISTANT

Google Assistant is set as your default assistant, but you can change it using the following steps.

1. From the settings menu, press Assistant & voice. See **Center Display** (page 467).
2. Press Digital assistant app.
3. Select the digital assistant you prefer.

GOOGLE ASSISTANT

Google Assistant allows you to use your voice to perform everyday tasks. You can make calls, get directions, play music, and control certain functions of your vehicle.

Google, Android, Android Auto, Google Maps word mark and logos are registered trademarks owned by Google LLC.

Signing In to Your Account

Signing in to Google Assistant can be done in a number of ways, but the setup wizard on first boot is the most convenient way.

1. From the settings menu, press Driver profile settings. See **Center Display** (page 467).
2. Press Accounts.
3. Press Add.
4. Select Google Account under associate accounts.

Note: You can use Google Assistant without signing into a Google Account, but signing in unlocks greater functionality such as smart home functionality and productivity features.

Signing Out of Your Account

1. From the settings menu, press Driver profile settings. See **Center Display** (page 467).
2. Press Accounts.
3. Press Remove.
4. Select Google Account under associate accounts.

Using Google Assistant

Google Assistant can be used in three ways:

1. Say Hey Google.

Note: Google Assistant must be set as your default assistant and the wake word must be enabled.

2.  Press the voice interaction button on the steering wheel and then say Hey Google to invoke Google Assistant to start listening.

Note: Press the voice interaction button again to interrupt a voice prompt and begin speaking.

Note: Google Assistant must be set as your default assistant.

3.  From the app menu, press the Google Assistant button.

You can use Google Assistant for the following and more:

- Entertainment.
- Hands-free calling.
- Traffic and navigation.

Voice Interaction

- Vehicle controls.
- Managing your schedule.
- Looking up answers.
- Smart home device control.
- Weather and news information.

You can adjust the following settings in the touchscreen:

- Adjust the language of your voice assistant.
- Enable or disable the wake word.
- Allow personal results in this car.
- Allow suggestions from your voice assistant.
- Get notifications from your voice assistant.
- Read and respond to vehicle notifications.



Voice Command Examples

Below are a few examples of voice commands you can use with Google Assistant:

Command	Result
Call Henry.	The system calls Henry using your connected device.
Navigate to 125 Main Street, New York.	The system begins guided navigation to the address.
Tune to FM 88.5.	The system tunes the radio to 88.5 FM.
Set the temperature to 72°F (22°C).	The system sets the temperature to 72°F (22°C).

For additional information and settings about Google Assistant, scan the code.

Phone

PHONE PRECAUTIONS



WARNING: Driving while distracted can result in loss of vehicle control, crash and injury. We strongly recommend that you use extreme caution when using any device that may take your focus off the road. Your primary responsibility is the safe operation of your vehicle. We recommend against the use of any hand-held device while driving and encourage the use of voice-operated systems when possible. Make sure you are aware of all applicable local laws that may affect the use of electronic devices while driving.

CONNECTING YOUR PHONE

1. From the settings menu, press Bluetooth. See **Center Display** (page 467).

2. Press Add device.

Note: A prompt alerts you to search for your vehicle on your cell phone.

3. Select your vehicle on your cell phone.

Note: A number appears on your cell phone and on the touchscreen.

4. Confirm the number on your cell phone matches the number on the touchscreen.

Note: The touchscreen indicates that you have successfully paired your cell phone.

5. Approve phonebook download request on your cell phone.

PHONE MENU

This menu becomes available after pairing a phone.

Recent Call List

Display and select an entry from a list of previous calls.

Contacts

Displays a smart search form to look up your contacts. Use the List button to alphabetically sort your contacts.

Favorites

Displays the list of favorite contacts that are set up on your phone.

SMS app

Displays the list of text messages to read, listen to, or respond to.

Phone List

Displays the list of paired or connected devices that you can select.

Note: Up to 12 devices can be stored.

Do Not Disturb

Reject incoming calls and switch ring tones and alerts off.

Phone Keypad

Directly dial a number.

Voice Control

Press the button and say a command to use the Google Assistant or Siri voice assistant available on your connected phone to access supported features.

Note: Some features under the phone menu may not be available if the feature is not supported through the phone.

Phone

MAKING AND RECEIVING A PHONE CALL

Making Calls

To call a number in your contacts, select:

Menu Item	Action and Description
Contacts	Select the name of the contact you want to call. Any numbers stored for that contact display along with any stored contact photos. Select the number that you want to call. The system begins the call.

To call a number from your recent calls, select:

Menu Item	Action and Description
Recent Call List	Select an entry that you want to call. The system begins the call.

To call a number from your favorites, select:

Menu Item	Action and Description
Favorites	Select an entry that you want to call. The system begins the call.

To call a number that is not stored in your phone, select:

Menu Item	Action and Description
Phone Keypad	Select the digits of the number you wish to call.
Call	The system begins the call.

Pressing the backspace button deletes the last digit you typed.

Receiving Calls

During an incoming call, an audible tone sounds. Caller information appears in the display if it is available.

To accept the call, select:

Menu Item
Accept

Note: *You can also accept the call by pressing the phone button on the steering wheel.*

To reject the call, select:

Menu Item
Reject

Ignore the call by doing nothing. The system logs it as a missed call.

During a Phone Call

During a phone call, the contacts name and number display on the screen along with the call duration.

The phone status items are also visible:

- Signal Strength.
- Battery.

You can select any of the following during an active phone call:

Phone

Item	
End Call	Immediately end a phone call. You can also press the button on the steering wheel.
Keypad	Press this to access the phone keypad.
Mute	You can switch the microphone off so the caller does not hear you.

Item	
Privacy	Transfer the phone call audio to the cell phone or back to the touchscreen.
Hold	This feature allows you to put the active call on hold, to either make another call or answer an incoming call.

SENDING AND RECEIVING A TEXT MESSAGE

Menu Item	Description
Hear It	Hear the text message.
View	View the text message.
Call	Call the sender.
Reply	Reply to the text message with a standard text message.

Phone

SWITCHING TEXT MESSAGE NOTIFICATION ON AND OFF

The settings on your device must be enabled to receive text message notifications on the center display. Check your device settings to enable these features.

SWITCHING APPLE CARPLAY ON AND OFF

The operating system is compatible with wireless Apple CarPlay on iPhone 6s or later. Make sure your iPhone has been updated to the latest version of iOS.

Enabling Wireless Apple CarPlay

1. Pair your device to **Bluetooth**. See **Connecting Your Phone** (page 472).
2. Follow the instructions on your device and the touchscreen.

Disabling Wireless Apple CarPlay

While Apple CarPlay is connected:

1. From the settings menu, press Bluetooth. See **Center Display** (page 467).
2. Find your device in the list.
3. Press the Apple CarPlay button.

Re-Enabling Wireless Apple CarPlay

1. From the settings menu, press Bluetooth. See **Center Display** (page 467).
2. Select your device from the list.
3. Press the Apple CarPlay button.

SWITCHING ANDROID AUTO™ ON AND OFF

Enabling Android Auto with USB

(If Equipped)

1. Connect your device to a USB port.
2. Follow the instructions on your device and the touchscreen.

Enabling Android Auto with Wireless

1. Pair your device to **Bluetooth®**.
2. Follow the instructions on your device and the touchscreen.

Note: A compatible Android phone and active data plan are required to use Android Auto.

Note: Android Auto Wireless is not supported on certain **Android™** devices.

For more information, scan here.



Disabling Android Auto

While Android Auto is connected:

1. From the settings menu, press Bluetooth. See **Center Display** (page 467).
2. Find your device in the list.
3. Press the Android Auto button.

Re-Enabling Android Auto

1. From the settings menu, press Bluetooth. See **Center Display** (page 467).
2. Find your device in the list.
3. Press the Android Auto button.

Note: *While using Android Auto/Apple CarPlay, some vehicle data such as speed and location is shared with your phone. This data does not identify you. Vehicle manufacturer is not responsible for the way this data is handled and may disable Android Auto/Apple CarPlay at any time.*

CONNECTING A BLUETOOTH® DEVICE

1. From the Settings menu, press Bluetooth. See **Center Display** (page 467).
2. Press Add Device.

Note: A prompt alerts you to search for your vehicle on your device.

1. Select your vehicle on your device.

Note: A number appears on your device and on the touchscreen.

2. Confirm that the number on your device matches the number on the touchscreen.

Note: The touchscreen indicates that you have successfully paired your device.

The **Bluetooth®** word mark and logos are registered trademarks owned by **Bluetooth SIG, Inc.** and any use of such marks by Ford Motor Company is under license. Other trademarks and trade names are those of their respective owners.

PLAYING MEDIA USING BLUETOOTH®



WARNING: Driving while distracted can result in loss of vehicle control, crash and injury. We strongly recommend that you use extreme caution when using any device that may take your focus off the road. Your primary responsibility is the safe operation of your vehicle. We recommend against the use of any hand-held device while driving and encourage the use of voice-operated systems when possible. Make sure you are aware of all applicable local laws that may affect the use of electronic devices while driving.

Connect your device.

From the Apps menu, press Bluetooth audio. See **Center Display** (page 467).



Press to play a track. Press again to pause the track.



Press to skip to the next track.

Press and hold to fast forward through the track.



Press once to return to the beginning of a track. Repeatedly press to return to previous

tracks.

Press and hold to fast rewind through the track.

Personal Profiles

HOW DO PERSONAL PROFILES WORK

This feature allows you to create multiple personal profiles enabling users to personalize the vehicle's settings such as seats and mirrors, as well as non-positional settings like radio, navigation and driver assist. Non-positional settings are saved when you change a setting while a profile is active.

ENABLING OR DISABLING PERSONAL PROFILES

The vehicle does not allow the user to disable personal profiles.

CREATING A PERSONAL PROFILE

1. Switch the vehicle on and leave it in park (P).
2. From the settings menu, press Profile. See **Center Display** (page 467).
3. Follow the instructions on the display.

Note: You can also access profiles by pressing the profiles icon from the Home screen.

Note: The guest profile is auto created with its own memory settings.

Note: You cannot link a personalized name to a guest profile.

LINKING OR UNLINKING A PERSONAL PROFILE

You can link your profile to a remote control so that your settings are activated when you use the remote control to turn on the vehicle.

Remote Control

You can save a personal profile, including saved memory positions for up to three remote controls by assigning a remote control to a profile using the touchscreen.

1. From the settings menu, press Profile. See **Center Display Overview** (page 467).
2. Press Edit.
3. Press Link profile.
4. Press Key fob label .
5. Follow the instructions on the touchscreen.

Note: You can also access profiles by pressing the profiles icon from the Home screen.

Note: If more than one linked remote control is in range, the memory function moves to the settings of the first key to initiate a memory recall.

Note: Each remote can be linked to only one personal profile.

Note: You cannot link a remote control to a guest profile.

Locking a personal profile

Profile lock allows you to lock your profile and prevent others from accessing the profile.

1. From the settings menu, press Profile. See **Center Display Overview** (page 467).
2. Press Edit.
3. Press Security.
4. Press Profile lock.
5. Press to choose your preferable lock type.
6. Follow the onscreen instructions to create a profile lock.

Personal Profiles

Note: *You can also access profiles by pressing the profiles icon from the Home screen.*

Note: *If all user profiles are passcode protected, and the passcodes are unknown, take your vehicle to an authorized dealer to reset the system.*

Navigation (If Equipped)

Google Maps provides the navigation software on your vehicle. For more information scan here:



Vehicle Software Updates

This introduces new features and provides updates to the vehicle's software systems. Make sure to switch Automatic Updates on, set a recurring update schedule and connect your vehicle to Wi-Fi. Updates could take longer when not connected to Wi-Fi or could not download at all. See **Connecting the Vehicle to a Wi-Fi Network** (page 452).

Your vehicle may be able to receive drivable software updates, non-drivable software updates or both. Drivable software updates happen during normal vehicle usage and require limited input from you. You are notified on your touchscreen and connected device prior to a non-drivable update.

Most non-drivable updates complete in less than 30 minutes, although some updates could take up to a few hours.

You are notified of vehicle software update status on to the top left of touchscreen. You can also see the notifications in your connected device. See **Software Update Indicators** (page 482).

Vehicle Software Update Requirements

Non-drivable software updates do not install if any of the following occur:

- Your vehicle is running.
- Your vehicle is switched on.
- Your vehicle is not parked.
- The 12 V battery charge is too low.
- The hazard indicators are switched on.
- The alarm is sounding.
- The doors are open.
- The parking lamps are switched on.
- You are pressing the brake pedal.
- An emergency call is in process.
- Your vehicle is in limp home mode.

Vehicle Software Update Limitations

Once you begin a non-drivable software update, you cannot:

- Cancel the update.
- Enter your vehicle unless you have a key blade.
 - You can open the doors using the mechanical latch if child locks are not on.
- Use the remote control to lock, unlock or start your vehicle.
- Drive your vehicle.
- Charge your vehicle.
 - Charging resumes once the update completes.

SOFTWARE UPDATE SETTINGS

To access the Software Updates menu:

1. Press Settings on the touchscreen.
2. Press System.
3. Press Software Updates.

You can do the following in the Software Updates menu:

- Switch Automatic Updates on and off.
- Schedule and install software updates.
- View software update details.



Press the button next to a menu option for more information.

Vehicle Software Updates

Switching Automatic Updates On and Off

Your vehicle may come with Automatic Updates switched on. To make sure your vehicle always has the latest software, which could include security or other enhancements, we do not recommend switching Automatic Updates off.

Note: *Software updates require approval to download or install with Automatic Updates switched off.*

Scheduling and Installing Software Updates

Scheduling Software Updates

From the Software Updates menu:

1. Press Recurring Schedule.
2. Select the days and time for updates.

The more days that updates are scheduled, the more frequently your vehicle may install new updates. We recommend selecting a time you normally do not need your vehicle, such as overnight.

Some updates require your vehicle to be switched off during the scheduled time.

Note: *The schedule you set is recurring. If Automatic Updates is on, every time a scheduled update is available, it installs on this schedule unless you change it. You are notified on your touchscreen and connected device prior to a scheduled update, with an option to reschedule it.*

Installing Software Updates

Using the Notification Center

1. Press a Software Update indicator on your touchscreen when it appears.
2. Follow the instructions on the touchscreen.

Using the Touchscreen

From the Software Updates menu:

1. Press Update Details.
2. Press Update Now.

Viewing Software Update Details

From the Software Updates menu, press Update Details.

SOFTWARE UPDATE INDICATORS



Vehicle software update reminder, schedule required, confirmation of default schedule required, or consent required.



Vehicle software update canceled, update not successful, or precondition not met.



Vehicle software update successful.

Vehicle System Reset

PERFORMING A SYSTEM RESET

To perform any reset:

1. Press Settings from the Apps menu.
2. Press System.
3. Press Reset options.
4. Select the reset you prefer.
5. Follow the prompts on screen to complete the reset.



There are multiple resets available, press the button next to each for more information.

Accessories

For a complete listing of the accessories that are available for your vehicle, please contact your authorized dealer or visit the online store web site:

United States of America



For more information scan here or visit:

<https://www.ford.com/accessories>

Canada



For more information scan here or visit:

<https://accessories.ford.ca>

We will repair or replace any properly authorized dealer-installed Ford Original Accessory found to be defective in factory-supplied materials or workmanship during the warranty period, as well as any component damaged by the defective accessories.

We will warrant your Ford Original Accessory through the warranty that provides the greatest benefit:

- 24 months, unlimited mileage.
- The remainder of your new vehicle limited warranty.

Contact an authorized dealer for details and a copy of the warranty.

Ford Licensed Accessories are the accessory manufacturer's designs. The manufacturer develops and therefore warrants Ford Licensed Accessories, and does not design or test these accessories to Ford Motor Company engineering requirements. Contact an authorized Ford dealer for the manufacturer's limited warranty details, and request a copy of the Ford Licensed Accessories product limited warranty from the accessory manufacturer.

For maximum vehicle performance, keep the following information in mind when adding accessories or equipment to your vehicle:

- When adding accessories, equipment, passengers and luggage to your vehicle, do not exceed the total weight capacity of the vehicle or of the front or rear axle (GVWR or GAWR as indicated on the Safety Compliance Certification label). Ask an authorized dealer for specific weight information.
- The Federal Communications Commission (FCC) and Canadian Radio Telecommunications Commission (CRTC) regulate the use of mobile communications systems that are equipped with radio transmitters, for example two-way radios, telephones and theft alarms. Any such equipment installed in your vehicle should comply with Federal Communications Commission (FCC) and Canadian Radio Telecommunications Commission (CRTC) regulations and should be installed only by an authorized dealer.

Accessories

- An authorized dealer needs to install mobile communications systems. Improper installation may harm the operation of your vehicle, particularly if the manufacturer did not design the mobile communication system specifically for automotive use.
- If you or an authorized Ford dealer add any non-Ford electrical or electronic accessories or components to your vehicle, you may adversely affect battery performance and durability. In addition, you may also adversely affect the performance of other electrical systems in the vehicle.

Ford Protect

WHAT IS FORD PROTECT

Ford Protect vehicle service contracts are the only service contracts 100% backed by Ford Motor Company. Protect yourself from unforeseen covered repairs with a Ford Protect extended service plan.

Ford Protect Extended Service Plans - United States Only

You can drive on with confidence as Ford Protect extended service plans provide more protection beyond the New Vehicle Limited Warranty. When you visit your Ford Dealer, insist on a Ford Protect extended service plan.

Ford Protect Can Quickly Pay for Itself

One repair bill can easily exceed the price of your Ford Protect extended service plan. With the Ford Protect extended service plan, you have peace of mind from unforeseen covered repairs.

Up to 1,000+ Covered Vehicle Components

There are four mechanical Ford Protect extended service plans with different levels of coverage to fit your individual needs. Ask your Ford dealer for details.

1. PremiumCARE - Our most comprehensive coverage. With over 1,000 covered components, this plan is so complete it is probably easier to list what is not covered.
2. ExtraCARE - Covers 113 components, and includes many high-tech items.
3. BaseCARE - Covers 84 components.
4. PowertrainCARE - Covers 29 critical components.

Ford Protect extended service plans are honored by all authorized Ford dealers in the United States, Canada and Mexico.

That means you get:

- Ford-authorized parts used for covered repairs.
- Factory-trained and certified technicians.
- Rental vehicle benefits for up to 10 days for covered repairs.

24-Hour Roadside Assistance

Roadside assistance includes:

- Tire change, lockout, out-of-fuel and battery jump-start assistance.
- Towing Assistance.
- Emergency Travel Expense.
- Destination Assistance.

Transferable Coverage

If you sell your vehicle before your Ford Protect extended service plan coverage expires, you can transfer any remaining coverage to the new owner.

Premium Maintenance Plan

It is more than just a routine oil change. Keep your vehicle running at its optimum performance with a Ford Protect Premium Maintenance extended service plan. The coverage is prepaid, so you never have to worry about the future cost of your vehicle's maintenance.

Premium Maintenance covers these important maintenance items:

- Engine oil and filter changes.
- Multi-point inspections.
- Tire rotations.
- Brake pads and linings.
- Shock absorbers and struts.
- Spark plugs.
- Clutch discs-if equipped.

Ford Protect

- Engine belts, coolant hoses and clamps.
- Wiper blades.

This information is subject to change. Visit your local Ford of Canada dealer or www.ford.ca to find the Ford Protect extended service plan that is right for you.

More Information

To learn more about Ford Protect plans and financing options, please contact your selling Ford Dealer.

Ford Protect Extended Service Plan - Canada Only

You can get more protection for your vehicle by purchasing a Ford Protect extended service plan. Ford Protect extended service plan is the only service contract backed by Ford Motor Company of Canada, Limited. Depending on the plan you purchase, Ford Protect extended service plan provides benefits such as:

- Rental reimbursement.
- Coverage for certain maintenance and wear items.
- Protection against repair costs after your New Vehicle Limited Warranty Coverage expires.
- Roadside Assistance benefits.

There are several Ford Protect extended service plans available in various time, distance and deductible combinations. Each plan is tailored to fit your own driving needs, including reimbursement for towing and rental. When you purchase a Ford Protect extended service plan, you receive added peace-of-mind protection throughout Canada, the United States and Mexico, provided by a network of participating authorized Ford Motor Company dealers.

Note: *Repairs performed outside of Canada and the United States are not eligible for Ford Protect extended service plan coverage.*

Scheduled Maintenance

Intelligent Oil-Life Monitor™

Your vehicle has an Intelligent Oil-Life Monitor that determines when you should change the engine oil based on how you use your vehicle. By using several important factors in its calculations, the monitor helps reduce the cost of owning your vehicle and reduces environmental waste at the same time.

This means you do not have to remember to change the oil on a mileage-based schedule. Your vehicle lets you know when an oil change is due by displaying a message in the instrument cluster display.

The following table provides examples of vehicle use and its impact on oil change intervals. It is a guideline only. Actual oil change intervals depend on several factors and generally decrease with severity of use.

Maintenance Intervals

At Every Oil Change Interval as Indicated by the Instrument Cluster Display¹
Change the engine oil and filter. ²
Rotate the tires.
Perform a multi-point inspection, recommended.
Inspect the brake pads, rotors, hoses and parking brake.
Inspect the engine cooling system strength and hoses.
Inspect the exhaust system and heat shields.
Inspect the front axle.
Inspect the rear axle and U-joints.
Inspect the halfshaft boots.
Inspect the steering linkage, ball joints, suspension and the tie-rod ends.
Inspect the tires, tire wear and measure the tread depth.
Inspect the wheels and related components for abnormal noise, wear, looseness or drag.
Inspect cabin air filter if equipped, service as required.
Inspect engine air filter, service as required.

¹ Do not exceed one year or 10,000 mi (16,000 km) between service intervals.

² Reset the Intelligent Oil-Life Monitor after engine oil and filter changes. See **Resetting the Intelligent Oil Life Monitor** (page 370).

Scheduled Maintenance

Brake Fluid Maintenance¹	
Every Three Years.	Change the brake fluid. ²

¹ Perform this maintenance item every three years. Do not exceed the designated time for the interval.

² Brake fluid servicing requires special equipment available at your authorized dealer.

Other Maintenance Items¹	
Every 20,000 mi (32,000 km)	Replace the cabin air filter.
Every 30,000 mi (48,000 km)	Replace the engine air filter.
Every 60,000 mi (96,000 km)	For severe service, replace the spark plugs.
At 200,000 mi (322,000 km)	Change the engine coolant and motor electronics coolant. ²
Every 100,000 mi (160,000 km)	Replace the spark plugs.
Every 100,000 mi (160,000 km)	Inspect the accessory drive belt or belts. ³
Every 150,000 mi (240,000 km)	Change the automatic transmission fluid.
	Replace the accessory drive belt or belts. ⁴

¹ Perform these maintenance items within 3,000 mi (4,800 km) of the last engine oil and filter change. Do not exceed the designated distance for the interval.

² Initial replacement at 10 years or 200,000 mi (322,000 km), then every 5 years or 100,000 mi (160,000 km).

³ After initial inspection, inspect every other oil change until replaced.

⁴ If not replaced within the last 100,000 mi (160,000 km).

Scheduled Maintenance

Driver Training/EVOC	
As required	Replace engine oil and filter as indicated by the instrument cluster display and perform services listed in the Extreme Usage Scheduled Maintenance chart.
	Inspect brake pads, rotors, calipers hoses, and service as required.
Inspect vehicle every day prior to starting training	Inspect engine oil level.
	Set tire pressure. Refer to driver door placard for cold tire pressure information.
	Inspect tire quality for wear.
	Set wheel lug nut torque. The cold wheel lug nut torque is 150 lb.ft (204 Nm). If wheels are torqued while they are hot (after 15 minutes of EVOC driving), torque may be checked to hot wheel lug nut torque of 70 lb.ft (95 Nm).
	Proper functioning of safety devices (seat belts, no air bag lights, and the like.)
25 hours of training use	Front differential/axle fluid.
100 hours of training use	Rear differential/axle fluid.
Annually	Change transmission and transfer case fluids.

Note: Follow base owner guide direction for 1,000-mile vehicle break-in prior to using vehicle for training purposes.

Note: Incorporate vehicle cool-down after hard driving.

Note: Perform Training / EVOC service according to the Extreme Usage Scheduled Maintenance chart.

Note: Use Police Interceptor part numbers for replacement parts.

Flex Fuel Vehicles (If Equipped)

Exclusive Use of E85 - Flex Fuel Vehicles Only	
Every oil change interval.	If ran exclusively on E85, fill the fuel tank full of regular unleaded fuel.

Scheduled Maintenance

Engine Idle Hour Meter

Your vehicle may have an idle meter to indicate how much time the vehicle has been sitting in park (P) or neutral (N). The meter is incorporated with the vehicle odometer. Pressing the odometer-reset button once displays the trip odometer (miles [kilometers] following by a "T" for trip odometer). Pressing the odometer-reset button a second time displays the idle meter (hours following by an "H" for hours). The idle meter only accumulates time while the vehicle is in park (P) or neutral (N). Displayed time is cumulative for the vehicle and cannot be reset to zero. Police vehicles often experience long periods of idling, during which engine oil continues to break down but distance is not accumulated on the odometer. Engine Idle Hours have been incorporated into the Intelligent Oil-Life Monitor.

Exceptions

There are several exceptions to the schedule:

Axle and Transfer Case Maintenance

The transfer case, front and rear axles in your vehicle do not require scheduled maintenance. The transfer case, front and rear axles are more likely to require a fluid change if the vehicle has experienced extended periods of extreme or severe duty cycle driving. Changing or checking the transfer case, front and/or rear axle lubricant is not necessary unless the unit has been submerged in water, shows signs of leakage. Contact your authorized dealer for service.

California Fuel Filter Replacement

If you register your vehicle in California, the California Air Resources Board has determined that the failure to perform this maintenance item does not nullify the emission warranty or limit recall liability before the completion of your vehicle's useful life. Ford Motor Company, however, urges you to have all recommended maintenance services performed at the specified intervals and to record all vehicle service.

Hot Climate Oil Change Intervals

Vehicles operating in the Middle East, North Africa, Sub-Saharan Africa or locations with similar climates using an American Petroleum Institute (API) Certified for Gasoline Engines (Certification mark) oil of SM or SN quality, the oil change interval is 5,000 mi (8,000 km).

If the available API SM or SN oils are not available, then the oil change interval is 3,000 mi (4,800 km).

Engine Air Filter and Cabin Air Filter Replacement

The life of the engine air filter and cabin air filter is dependent on exposure to dusty and dirty conditions. Vehicles operated in these conditions require frequent inspection and replacement of the engine air filter and cabin air filter.

Scheduled Maintenance

What Are Considered Severe Driving Conditions

A vehicle that is driven for short trips of less than 5–10 mi (8–16 km), driving in temperatures well below or above average, driving in any dusty conditions, idling more than recommended such as in traffic, and driving with a heavy load or while towing a load are considered severe driving conditions. If the vehicle is driven in any of these conditions, follow the severe service maintenance items listed in the scheduled maintenance chart.

GENERAL MAINTENANCE INFORMATION

Why Maintain Your Vehicle?

Carefully following the maintenance schedule helps protect against major repair expenses resulting from neglect or inadequate maintenance and may help to increase the value of your vehicle when you sell or trade it. Keep all receipts for completed maintenance with your vehicle.

It is important that you have your vehicle serviced at the proper times. These intervals serve two purposes: first is to maintain the reliability of your vehicle and the second is to keep the cost of owning your vehicle down.

It is your responsibility to have all scheduled maintenance performed and to make sure that the materials used meet the specifications identified in this owner's manual. See **Vehicle Specifications** (page 394).

Failure to perform scheduled maintenance and regularly inspect your vehicle may result in vehicle damage not covered by the vehicle Warranty.

Why Maintain Your Vehicle at Your Dealership?

Our Genuine Replacement Parts

Dealerships stock our parts and our authorized branded remanufactured replacement parts. These parts meet or exceed our specifications. Parts installed at your dealership carry a nationwide 24-month or unlimited mile (kilometer) parts and labor limited warranty.

If you do not use our authorized parts, they may not meet our specifications and could affect emissions compliance.

Protecting Your Investment

Maintenance is an investment that pays dividends in the form of improved reliability, durability and resale value. To maintain the proper performance of your vehicle and its emission control systems, make sure you have scheduled maintenance performed at the designated intervals.

Your vehicle comes with the Intelligent Oil-Life Monitor system, a message appears in the instrument cluster display at the proper oil change interval. This interval may be up to one year or 10,000 mi (16,000 km), hybrid vehicles could exceed 10,000 mi (16,000 km).

When the oil change message appears in the instrument cluster display, it is time for an oil change. Make sure you perform the oil change within two weeks or 500 mi (800 km) of the message appearing. Make sure to reset the Intelligent Oil-Life Monitor after each oil change. See **Resetting the Intelligent Oil Life Monitor** (page 370).

Scheduled Maintenance

If your instrument cluster display resets prematurely or becomes inoperative, you should perform the oil change interval at six months or 5,000 mi (8,000 km) from your last oil change. Never exceed one year or 10,000 mi (16,000 km) between oil change intervals.

You can drive your vehicle in such a way that may lead to higher oil consumption including extended time at high engine speeds, high loads, engine braking, hard cornering maneuvers, track and off-road usage. Under these conditions, oil consumption of approximately 1 quart per 500 miles (1 liter per 800 km) is possible. Check the engine oil level at every refueling and adjust to maintain proper levels to avoid engine damage.

You can also drive your vehicle in such a way that dilutes and increases the level of oil by frequent short trips that do not allow the engine to get to operating temperature, extended idling and low speed driving for long periods of time.

It is important to rely upon your dealership to properly diagnose and repair your vehicle.

We strongly recommend only using our genuine or our authorized re-manufactured replacement parts engineered for your vehicle.

Additives and Chemicals

We do not recommend using chemicals or additives not approved by us as part of your vehicle's normal maintenance. Please consult your warranty information.

Oils, Fluids and Flushing

In many cases, fluid discoloration is a normal operating characteristic and, by itself, does not necessarily indicate a concern or that the fluid needs to be changed. Have discolored fluids that also show signs of overheating or foreign material contamination immediately checked.

Make sure to change the vehicle's oils and fluids at the specified intervals or in conjunction with a repair. Flushing is a viable way to change fluid for many vehicle sub-systems during scheduled maintenance. It is critical that systems are flushed only with new fluid that is the same as that required to fill and operate the system or using our approved flushing chemical.

Scheduled Maintenance Service Intervals

For your scheduled maintenance service intervals, visit <https://www.ford.com/support/maintenance-schedule>.



Owner Checks and Services

Make sure you perform the following basic maintenance checks and inspections.

Scheduled Maintenance

Check Every Month
The engine oil level.
Function of all interior and the exterior lights.
The tires including the spare for wear and proper pressure.
The windshield washer fluid level.

Check Every Six Months
The battery connections. Clean if necessary.
The body and door drain holes for obstructions. Clean if necessary.
The cooling system fluid level and the coolant system strength.
The door weatherstrips for wear. Lubricate if necessary.
The hinges, latches and outside locks for proper operation. Lubricate if necessary.
The parking brake for proper operation.
The seatbelts and seat latches for wear and function.
Safety warning lamps, brake, ABS, airbag and seatbelt for operation.
The washer spray and wiper operation. Clean or replace blades as necessary.

Multi-Point Inspection

It is important to have the systems on your vehicle regularly checked. This can help identify potential issues and prevent major problems. We recommend having the following multi-point inspection performed at every scheduled maintenance interval to help make sure your vehicle keeps running great.

Scheduled Maintenance

Multi-Point Inspection	
Accessory drive belt or belts	Hazard warning system operation
Battery performance	Horn operation
Engine air filter	Radiator, cooler, heater and air conditioning hoses
Exhaust system	Suspension components for leaks or damage
Exterior lamps operation	Steering and linkage
Fluid levels ¹ ; fill if necessary	Tires including the spare for wear and proper pressure ²
For oil and fluid leaks	Windshield for cracks, chips or pits
Halfshaft dust boots	Washer spray and wiper operation

¹ Brake, coolant recovery reservoir, automatic transmission and window washer.

² If your vehicle has a temporary mobility kit, check the tire sealant expiration Use By date on the canister. Replace as needed.

Be sure to ask your dealership service advisor or technician about the multi-point vehicle inspection. It is a comprehensive way to perform a thorough inspection of your vehicle. Your checklist gives you immediate feedback on the overall condition of your vehicle.

Severe Driving Conditions

A vehicle that is driven for short trips of less than 5–10 mi (8–16 km), driving in temperatures greatly below or above average, driving in any dusty conditions, idling more than recommended such as in traffic, and driving with a heavy load or while towing a load are considered severe driving conditions. If you drive your vehicle in any of these conditions, follow the severe service maintenance items listed in the scheduled maintenance chart.

Customer Information

ROLLOVER WARNING



WARNING: Utility vehicles have a significantly higher rollover rate than other types of vehicles.



WARNING: Vehicles with a higher center of gravity (utility and four-wheel drive vehicles) handle differently than vehicles with a lower center of gravity (passenger cars). Avoid sharp turns, excessive speed and abrupt steering in these vehicles. Failure to drive cautiously increases the risk of losing control of your vehicle, vehicle rollover, personal injury and death.



WARNING: In a rollover crash, an unbelted person is significantly more likely to die than a person wearing a seatbelt.



WARNING: Do not become overconfident in the ability of four-wheel drive vehicles. Although a four-wheel drive vehicle may accelerate better than a two-wheel drive vehicle in low traction situations, it won't stop any faster than two-wheel drive vehicles. Always drive at a safe speed.

Utility vehicles and trucks handle differently than passenger cars in the various driving conditions that are encountered on streets, highways and off-road. Utility vehicles and trucks are not designed for cornering at speeds as high as passenger cars any more than low-slung sports cars are designed to perform satisfactorily under off-road conditions.

GETTING THE SERVICES YOU NEED

Warranty repairs to your vehicle must be performed by an authorized dealer. While any authorized dealer handling your vehicle line will provide warranty service, we recommend you return to your selling authorized dealer who wants to ensure your continued satisfaction.

Please note that certain warranty repairs require special training and equipment, so not all authorized dealers are authorized to perform all warranty repairs. This means that, depending on the warranty repair needed, you may have to take your vehicle to another authorized dealer.

Allow a reasonable time to perform a repair after taking your vehicle to the authorized dealer. Repairs will be made using Ford or Motorcraft® parts, or remanufactured or other parts that are authorized by Ford.

Away From Home

If you are away from home when your vehicle needs service, contact the Ford Customer Relationship Center or use the online resources listed below to find the nearest authorized dealer. See **Contacting Us** (page 15).

Additional information and resources are available online:

Market	Website
United States	www.ford.com/support
Canada	www.ford.ca/help/contact

Customer Information

These are some of the items that you can find online:

- U.S. dealer locator by Dealer Name, City/State or Zip Code.
- Owner Manuals.
- Maintenance Schedules.
- Recalls.
- Ford Extended Service Plans.
- Ford Genuine Accessories.
- Service specials and promotions.

Additional Assistance

If you have questions or concerns, or are unsatisfied with the service you are receiving, follow these steps:

1. Contact your Sales Representative or Service Advisor at your selling or servicing authorized dealer.
2. If your inquiry or concern remains unresolved, contact the Sales Manager, Service Manager or Customer Relations Manager.
3. If you require assistance or clarification on Ford Motor Company policies, please contact the Ford Customer Relationship Center. See **Contacting Us** (page 15).

In order to help us serve you better, please have the following information available when contacting a Customer Relationship Center:

- Vehicle Identification Number.
- Your telephone number (home and business).
- The name of the authorized dealer and city where located.
- The vehicle's current odometer reading.

In some states within the United States, you need to directly notify Ford in writing before pursuing remedies under your state's warranty laws, and Ford is also allowed a final repair attempt.

Additionally, in some states within the United States, a consumer has the option of submitting a warranty dispute to the BBB Auto Line before taking action under the Magnuson-Moss Warranty Act, or to the extent allowed by state law, before pursuing replacement or repurchase remedies provided by certain state laws. This dispute handling procedure is not required prior to enforcing state created rights or other rights which are independent of the Magnuson-Moss Warranty Act or state replacement or repurchase laws.

Customer Information

IN CALIFORNIA (U.S. ONLY)

California Civil Code Section 1793.2(d) requires that, if a manufacturer or its representative is unable to repair a motor vehicle to conform to the vehicle's applicable express warranty after a reasonable number of attempts, the manufacturer shall be required to either replace the vehicle with one substantially identical or repurchase the vehicle and reimburse the buyer in an amount equal to the actual price paid or payable by the consumer (less a reasonable allowance for consumer use). The consumer has the right to choose whether to receive a refund or replacement vehicle.

California Civil Code Section 1793.22(b) presumes that the manufacturer has had a reasonable number of attempts to conform the vehicle to its applicable express warranties if, within the first 18 months of ownership of a new vehicle or the first 18,000 mi (29,000 km), whichever occurs first:

1. Two or more repair attempts are made on the same non-conformity likely to cause death or serious bodily injury OR
2. Four or more repair attempts are made on the same nonconformity (a defect or condition that substantially impairs the use, value or safety of the vehicle) OR
3. The vehicle is out of service for repair of nonconformities for a total of more than 30 calendar days (not necessarily all at one time).

In the case of 1 or 2 above, the consumer must also notify the manufacturer of the need for the repair of the nonconformity at the following address:

Ford Motor Company

16800 Executive Plaza Drive

Mail Drop 3NE-B

Dearborn, MI 48126

You are required to submit your warranty dispute to BBB AUTO LINE before asserting in court any rights or remedies conferred by California Civil Code Section 1793.22(b). You are also required to use BBB AUTO LINE before exercising rights or seeking remedies created by the Federal Magnuson-Moss Warranty Act, 15 U.S.C. sec. 2301 et seq. If you choose to seek redress by pursuing rights and remedies not created by California Civil Code Section 1793.22(b) or the Magnuson-Moss Warranty Act, resort to BBB AUTO LINE is not required by those statutes.

Customer Information

California Lemon Law

Notification requirements in California. Ford and your Ford dealer place a high priority on your satisfaction with our performance. If you are not satisfied with our resolution of a warranty concern and you would like to seek a civil penalty from Ford, you must follow these steps under California law (Cal. Code Civ. Proc., §871.24(a)-(d)):

At least 30 days before filing a lawsuit seeking civil penalties (Civ. Code § 1794(c)), you must:

1. Notify Ford of your name and the name(s) of any other vehicle owner(s), the accurate Vehicle Identification Number ("VIN") of your motor vehicle, and a brief summary of the repair history and problems with your motor vehicle, and
2. Demand that Ford repurchase or replace your motor vehicle.

When you submit the notice to Ford, you must have possession of your motor vehicle.

Your notice to Ford must be in writing and must be sent either by email to LLNOTICE@ford.com or by certified or registered mail, return receipt requested, to:

Ford Motor Company

Office of General Counsel

Attn: California LL Notice

One American Road

Dearborn, MI 48126

Customer Information

THE BETTER BUSINESS BUREAU AUTO LINE PROGRAM

Your satisfaction is important to Ford Motor Company and to your dealer. If a warranty concern has not been resolved using the three-step procedure outlined earlier in this chapter in the Getting the Services you need section, you may be eligible to participate in the BBB AUTO LINE program.

The BBB AUTO LINE program consists of two parts – mediation and arbitration. During mediation, a representative of the BBB will contact both you and Ford Motor Company to explore options for settlement of the claim. If an agreement is not reached during mediation or you do not want to participate in mediation, and if your claim is eligible, you may participate in the arbitration process. An arbitration hearing will be scheduled so that you can present your case in an informal setting before an impartial person. The arbitrator considers the testimony provided and makes a decision after the hearing.

Disputes submitted to the BBB AUTO LINE program are usually decided within 40 days after you file your claim with the BBB. You are not bound by the decision, and may reject the decision and proceed to court where all findings of the BBB Auto Line dispute, and decision, are admissible in the court action. Should you choose to accept the BBB AUTO LINE decision, Ford is then bound by the decision, and must comply with the decision within 30 days of receipt of your acceptance letter.

BBB AUTO LINE Application: Using the information that follows, call or write to request a program application. You will be asked for your name and address, general information about your new vehicle, information about your warranty concerns, and any steps you have already taken to

try to resolve them. A Customer Claim Form will be mailed that needs to be completed, signed and returned to the BBB along with proof of ownership. Upon receipt, the BBB reviews the claim for eligibility under the Program Summary Guidelines.

You can get more information by calling BBB AUTO LINE at 1-800-955-5100, or writing to:

**BBB AUTO LINE a Division of BBB National Programs, Inc.
1676 International Drive, Suite 550
McLean, VA 22102**

BBB AUTO LINE applications can also be requested by calling the Ford Motor Company Customer Relationship Center at 1-800-392-3673.

For additional information, refer to the Better Business Bureau website.

Note: *Ford Motor Company reserves the right to change eligibility limitations, modify procedures, or to discontinue this process at any time without notice and without obligation.*

THE MEDIATION AND ARBITRATION PROGRAM

For vehicles delivered to authorized Canadian dealers. In those cases where you continue to feel that the efforts by Ford of Canada and the authorized dealer to resolve a factory-related vehicle service concern have been unsatisfactory, Ford of Canada participates in an impartial third party mediation/arbitration program administered by the Canadian Motor Vehicle Arbitration Plan (CAMVAP).

Customer Information

The CAMVAP program is a straightforward and relatively speedy alternative to resolve a disagreement when all other efforts to produce a settlement have failed. This procedure is without cost to you and is designed to eliminate the need for lengthy and expensive legal proceedings.

In the CAMVAP program, impartial third-party arbitrators conduct hearings at mutually convenient times and places in an informal environment. These impartial arbitrators review the positions of the parties, make decisions and, when appropriate, render awards to resolve disputes. CAMVAP decisions are fast, fair, and final as the arbitrator's award is binding on both you and Ford of Canada.

CAMVAP services are available in all Canadian territories and provinces. For more information, without charge or obligation, call your CAMVAP Provincial Administrator directly at 1-800-207-0685 or visit www.camvap.ca.

GETTING ASSISTANCE OUTSIDE THE U.S. AND CANADA

Before exporting your vehicle to a foreign country, contact the appropriate foreign embassy or consulate. These officials can inform you of local vehicle registration regulations and where to find unleaded fuel or petrol/gas engines or the proper sulfur fuel for diesel engines.

If you cannot find the proper fuel recommended for your vehicle, contact our Customer Relationship Center.

The use of improper fuels in your vehicle without proper conversion may damage the effectiveness of your emission control system and may cause engine knocking or serious engine damage. Ford Motor Company or Ford of Canada is not responsible for any damage caused by use of improper fuel. Using improper fuels may also result in difficulty importing your vehicle back into the United States.

If your vehicle must be serviced while you are traveling or living in Asia-Pacific Region, Sub-Saharan Africa, U.S. Virgin Islands and/or Puerto Rico, Central America, the Caribbean, and Israel and the Middle East, contact the nearest authorized dealer. If the authorized dealer cannot help you, contact the corresponding Ford Relationship Center or Lincoln Client Relationship. See **Contacting Us** (page 15).

If you buy your vehicle in North America and then relocate to any of the above locations, register your vehicle identification number (VIN) and new address with Ford Global Trade Services by emailing, expcso@ford.com.

If you are in another foreign country, contact the nearest authorized dealer. In the event your inquiry is unresolved, communicate your concern with the dealership's Sales Manager, Service Manager or Customer Relations Manager. If you require additional assistance or clarification, please contact the respective Customer Relationship Center as previously mentioned.

Customer Information

REPORTING SAFETY DEFECTS IN THE UNITED STATES

If you believe that your vehicle has a defect which could cause a crash or could cause injury or death, you should immediately inform the National Highway Traffic Safety Administration (NHTSA) in addition to notifying Ford Motor Company.

If NHTSA receives similar complaints, it may open an investigation, and if it finds that a safety defect exists in a group of vehicles, it may order a recall and remedy campaign. However, NHTSA cannot become involved in individual problems between you, your dealer, or Ford Motor Company.

To contact NHTSA, you may call the Vehicle Safety Hotline toll-free at 1-888-327-4236 (TTY: 1-800-424-9153); go to www.safercar.gov; or write to:

Administrator

1200 New Jersey Avenue,
Southeast

Washington, D.C. 20590

You can also obtain other information about motor vehicle safety from www.safercar.gov.

REPORTING SAFETY DEFECTS IN CANADA

If you believe that your vehicle has a defect which could cause a crash or could cause injury or death, you should immediately inform Transport Canada and Ford of Canada.

Transport Canada Contact Information	
Website (English)	https://tc.canada.ca/recalls
Website (French)	http://tc.canada.ca/rappels
Phone	1-800-333-0510

Ford of Canada Contact Information	
Website	https://www.ford.ca
Phone	1-800-565-3673

Customer Information

THIRD PARTY SOFTWARE COPYRIGHT ACKNOWLEDGMENT

Your vehicle could have components that use open source software. For additional information, visit [http://
corporate.ford.com/ford-open-source.html](http://corporate.ford.com/ford-open-source.html).

RADIO FREQUENCY CERTIFICATION LABELS

You can locate radio frequency certification labels and declarations of conformity for components on your vehicle at your local Ford or Lincoln website along with your owner information.

For more information scan here:



[https://corporate.ford.com/operations/
locations/global-links.html](https://corporate.ford.com/operations/locations/global-links.html)

PERCHLORATE

Certain components in your vehicle such as airbag modules, seatbelt pretensioners and remote control batteries may contain perchlorate material. Special handling may apply for service or vehicle end of life disposal.

For more information visit:
www.dtsc.ca.gov/hazardouswaste/perchlorate.

REPLACEMENT PARTS RECOMMENDATION

We have built your vehicle to the highest standards using quality parts. We recommend that you demand the use of genuine Ford and Motorcraft parts whenever your vehicle requires scheduled maintenance or repair. You can clearly identify genuine Ford and Motorcraft parts by looking for the Ford, FoMoCo or Motorcraft branding on the parts or their packaging.

Scheduled Maintenance and Mechanical Repairs

One of the best ways for you to make sure that your vehicle provides years of service is to have it maintained in line with our recommendations using parts that conform to the specifications detailed in this Owner's Manual.

Genuine Ford and Motorcraft parts meet or exceed these specifications.

Collision Repairs

We hope that you never experience a collision, but accidents happen sometimes.

Genuine Ford replacement collision parts meet our stringent requirements for fit, finish, structural integrity, corrosion protection and dent resistance. During vehicle development we validate that these parts deliver the intended level of protection as a whole system. A great way to know for sure you are getting this level of protection is to use genuine Ford replacement collision parts.

Warranty on Replacement Parts

Genuine Ford and Motorcraft replacement parts are the only replacement parts that benefit from a Ford Warranty.

Customer Information

The Ford Warranty may not cover damage caused to your vehicle as a result of failed non-Ford parts.

For additional information, refer to the terms and conditions of the Ford Warranty.

MOBILE COMMUNICATIONS EQUIPMENT



WARNING: Driving while distracted can result in loss of vehicle control, crash and injury. We strongly recommend that you use extreme caution when using any device that may take your focus off the road. Your primary responsibility is the safe operation of your vehicle. We recommend against the use of any hand-held device while driving and encourage the use of voice-operated systems when possible. Make sure you are aware of all applicable local laws that may affect the use of electronic devices while driving.

Using mobile communications equipment is becoming increasingly important in the conduct of business and personal affairs. However, you must not compromise your own or others' safety when using such equipment. Mobile communications can enhance personal safety and security when appropriately used, particularly in emergency situations. Safety must be paramount when using mobile communications equipment to avoid negating these benefits. Mobile communication equipment includes, but is not limited to, cellular phones, pagers, portable email devices, text messaging devices and portable two-way radios.

FEDERAL HIGHWAY ADMINISTRATION REGULATION

Regulations such as those issued by the Federal Highway Administration or issued pursuant to the Occupational Safety and Health Act (OSHA), and state and local laws and regulations may require additional equipment for the way you intend to use your vehicle. It is the responsibility of the registered owner to determine the applicability of such laws and regulations to your intended use for the vehicle, and to arrange for the installation of required equipment. The dealer has information about the availability of equipment which can be ordered for your vehicle.

EMISSION LAW



WARNING: Do not remove or alter the original equipment floor covering or insulation between it and the metal floor of the vehicle. The floor covering and insulation protect occupants of the vehicle from the engine and exhaust system heat and noise. On vehicles with no original equipment floor covering insulation, do not carry passengers in a manner that permits prolonged skin contact with the metal floor. Failure to follow these instructions may result in fire or personal injury.

U.S. federal laws and certain state laws prohibit removing or rendering inoperative emission control system components. Similar federal or provincial laws may apply in Canada. We do not approve of any vehicle modification without first determining applicable laws.

Customer Information



Tampering with emissions control systems including related sensors or the Diesel

Exhaust Fluid system can result in reduced engine power and the illumination of the service engine soon light.

Tampering With a Noise Control System

Federal laws prohibit the following acts:

- Removal or rendering inoperative by any person other than for purposes of maintenance.
- Repair or replacement of any device or element of the design incorporated into a new vehicle for the purpose of noise control prior to its sale or delivery to the ultimate purchaser or while it is in use.
- The use of the vehicle after any person removes or renders inoperative any device or element of the design.

The U.S. Environmental Protection Agency may presume to constitute tampering as follows:

- Removal of hood blanket, fender apron absorbers, fender apron barriers, underbody noise shields or acoustically absorptive material.
- Tampering or rendering inoperative the engine speed governor, to allow engine speed to exceed manufacturer specifications.

If the engine does not start, runs rough, experiences a decrease in engine performance, experiences excess fuel consumption or produces excessive exhaust smoke, check for the following:

- A plugged or disconnected air inlet system hose.
- A plugged engine air filter element.
- Water in the fuel filter and water separator.

- A clogged fuel filter.
- Contaminated fuel.
- Air in the fuel system, due to loose connections.
- An open or pinched sensor hose.
- Incorrect engine oil level.
- Incorrect fuel for climatic conditions.
- Incorrect engine oil viscosity for climactic conditions.

Note: *Some vehicles have a lifetime fuel filter that is integrated with the fuel tank. Regular maintenance or replacement is not needed.*

Note: *If these checks do not help you correct the concern, have your vehicle checked as soon as possible.*

Noise Emissions Warranty, Prohibited Tampering Acts and Maintenance

On January 1, 1978, Federal regulation became effective governing the noise emission on trucks over 10,000 lb (4,536 kg) Gross Vehicle Weight Rating (GVWR). The preceding statements concerning prohibited tampering acts and maintenance, and the noise warranty found in the Warranty Guide, are applicable to complete chassis cabs over 10,000 lb (4,536 kg) GVWR.

EXPORT UNIQUE OPTIONS

For your particular global region, your vehicle may be equipped with features and options that are different from the features and options that are described in this Owner's Manual. A market unique supplement may be supplied that complements this book. By referring to the market unique supplement, if provided, you can properly identify those features, recommendations and specifications that are unique to your vehicle. This Owner's

Customer Information

Manual is written primarily for the U.S. and Canadian markets. Features or equipment listed as standard may be different on units built for export. **Refer to this Owner's Manual for all other required information and warnings.**

WARRANTY INFORMATION

The following warranties may apply to your vehicle:

- New vehicle limited warranties.
- Emissions warranties, if applicable.
- Other warranties, if applicable.

Detailed warranty information specific to your vehicle can be found in the Warranty Guide at

www.ford.com/support/owner-manuals

OWNER'S WARRANTY RESPONSIBILITIES:

- As the vehicle owner, you are responsible for getting your vehicle the required maintenance listed in your owner's manual. We recommend that you retain all receipts covering maintenance on your vehicle. However, we cannot deny you of your vehicle warranty solely for the lack of receipts, or for your failure to have all scheduled maintenance performed on your vehicle.

- You are responsible for bringing your vehicle to an authorized dealer as soon as a problem exists. Have the warranty repairs completed in a reasonable amount of time, not to exceed 30 days.

- As the vehicle owner, be aware that we may deny you warranty coverage if your vehicle or a part has failed due to abuse, neglect, improper maintenance or unapproved modifications.

If you have any questions regarding your warranty rights and responsibilities, you should contact Ford Customer Service at 1-800-392-3673.

New Vehicle Limited Warranty

Your vehicle comes with a New Vehicle Limited Warranty. The express warranties of the New Vehicle Limited Warranty are in substitution for and exclude all other liabilities of any kind whether arising under statute, in tort, by implication of law or otherwise including, to the full extent as may be allowed by law, liability for any other representations respecting the vehicle, statutory warranties or implied warranties or conditions as to its merchantability or fitness.

Download a free electronic copy or order one free printed copy of the most up-to-date Warranty Guide by visiting the Owner Manuals section of www.ford.com/support/owner-manuals (United States).

For Canada, visit www.ford.ca/support/owner-manuals

For Limo/Livery/Hearse vehicles: View and download your Warranty Guide by visiting the Warranty Information section of the Fleet website, www.fordpro.com/en-us/fleet-vehicles/livery (United States only).

Decommissioning the Vehicle - Police

DECOMMISSIONING REQUIREMENTS

We have implemented a decommissioning process of manufacturer-provided police features. It is the responsibility of the owner to complete the decommissioning of the vehicle in compliance with any state regulations prior to initial sale to the public sector.

Vehicle Sealing of Aftermarket Equipment

Removing customized equipment from your vehicle can compromise body panels and seals. Thoroughly inspect your vehicle for any signs where the equipment has been removed, for example, holes and damage to body seals.

Any items that remain on your vehicle must be inspected and any sign of damage immediately repaired. Failure to follow this instruction may result in water and exhaust fumes entering the passenger compartment. See your authorized dealer for more information and direction regarding proper sealing procedures.

Dark Car

Authorized personnel must use a diagnostic scan tool to decommission the dark car feature.

Integrated Computer Screen

Remove the audio video extender (AVX) box from the cargo area and sever the CAT6 cables prior to initial sale to the public sector.

OBD-II Split Connector

Remove the OBD-II split connector cable prior to initial sale to the public sector.

Police Engine Idle

Authorized personnel must use a diagnostic scan tool to decommission the police engine idle feature.

Police Perimeter Alert

Authorized personnel must use a diagnostic scan tool to decommission the police perimeter alert feature.

Pre-Collision Assist Disable

Authorized personnel must use a diagnostic scan tool to decommission the pre-collision assist disable feature.

Rear Cross Traffic Braking Disable

Authorized personnel must use a diagnostic scan tool to decommission the rear cross traffic braking disable feature.

Rear Camera On Demand

Authorized personnel must use a diagnostic scan tool to decommission the rear camera on demand feature.

Rear Door Handles and Locks (If Equipped)

Remove the rear door handle trim covers to allow for inside handle function. If your vehicle has the hidden lock knob on the front edge of the rear door, switch the child locks off.

Ballistic Panel Removal (If Equipped)

Doors with factory installed ballistic panels have a modified front door latch. Upon ballistic panel removal, you will need a new front door latch and remote control assembly.

Decommissioning the Vehicle - Police

Headlamp Wig-Wag Feature

Authorized personnel must use a diagnostic scan tool to decommission the headlamp wig-wag feature.

Appendices

ELECTROMAGNETIC COMPATIBILITY



WARNING: Do not place objects or mount equipment on or near the airbag cover, on the side of the front or rear seatbacks, or in areas that may come into contact with a deploying airbag. Failure to follow these instructions may increase the risk of personal injury in the event of a crash.



WARNING: Do not fasten antenna cables to vehicle wiring, pipes, or hoses.



WARNING: Keep antenna and power cables at least 4 in (10 cm) from any electronic modules and airbags.

Note: We test and certify your vehicle to meet electromagnetic compatibility legislation. It is your responsibility to make sure that any equipment an authorized dealer installs on your vehicle complies with applicable local legislation and other requirements. Installation of some aftermarket electronic devices could degrade the performance of vehicle functions, which use radio frequency signals such as broadcast radio receiver, tire pressure monitoring system, push button start, **Bluetooth®** connectivity or satellite navigation.

Note: Any radio frequency transmitter equipment in your vehicle (such as cell phones and amateur radio transmitters) must keep to the parameters in the following illustrations and table. We do not provide any other special provisions or conditions for installations or use.

Car

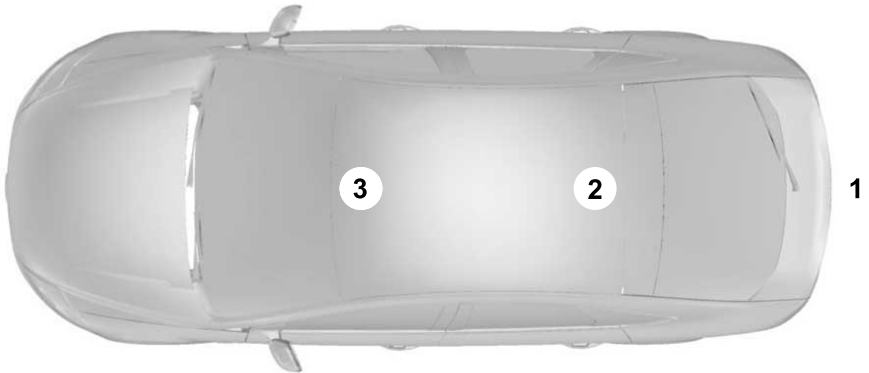

Appendices

Van



Truck

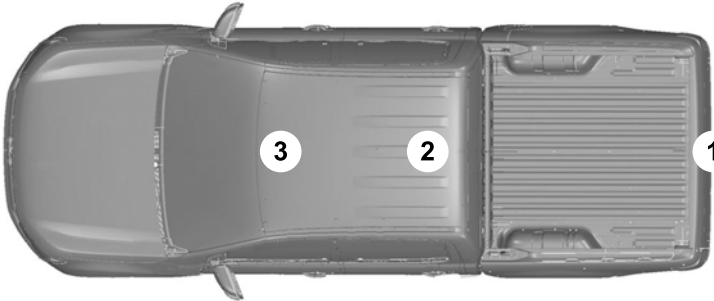

Appendices

Frequency Band MHz	Maximum Output Power Watt (Peak RMS)	Antenna Positions
1-30 ¹	50	1
50-54	50	2, 3
68-87	50	2, 3
144-174	50	2, 3
380-512	50	2, 3
806-870	10	2, 3

¹ For battery electric vehicles and plug-in hybrid vehicles, this frequency is not approved when your vehicle is plugged-in and charging.

Note: *After the installation of radio frequency transmitters, check for disturbances from and to all electrical equipment in your vehicle, both in the standby and transmit modes.*

Check all electrical equipment:

- With the ignition ON.
- With the vehicle running.
- During a road test at various speeds.

Check that electromagnetic fields generated inside your vehicle cabin by the transmitter installed do not exceed applicable human exposure requirements.

Index

1

12V Battery.....	385
12V Battery Precautions.....	385
Battery Management System	
Limitations.....	386
Changing the 12V Battery.....	387
How Does the Battery Management	
System Work.....	386
Recycling and Disposing of the 12V	
Battery.....	390
Resetting the Battery Sensor.....	390
What Is the Battery Management	
System.....	386
12V Battery – Troubleshooting.....	390
12V Battery – Information Messages.....	391
12V Battery – Warning Lamps.....	390

3

360 Degree Camera.....	259
360 Degree Camera Settings.....	261
360 Degree Camera Guide Lines.....	260
360 Degree Camera Precautions.....	259
360 Degree Camera Settings.....	261
Switching the 360 Degree Camera On and	
Off.....	261
Switching the 360 Degree Camera	
View.....	261

4

4WD	
See: Four-Wheel Drive.....	217

9

911 Assist.....	71
-----------------	----

A

A/C	
See: Climate Control.....	139
About This Publication.....	17
ABS	
See: Brakes.....	228

Accessing the Passive Key Backup	
Position - Vehicles With: Push Button	
Start.....	181
Accessing the Trip Computer.....	136
Accessories.....	484
Adaptive Cruise Control.....	264
Adaptive Cruise Control –	
Troubleshooting.....	277
Lane Centering.....	271
Lane Centering – Troubleshooting.....	274
Predictive Speed Assist.....	275
Predictive Speed Assist –	
Troubleshooting.....	277
Adaptive Cruise Control Automatic	
Cancellation.....	267
Adaptive Cruise Control Indicators.....	271
Adaptive Cruise Control	
Limitations.....	265
Adaptive Cruise Control	
Precautions.....	264
Adaptive Cruise Control –	
Troubleshooting.....	277
Adaptive Cruise Control – Information	
Messages.....	277
Adaptive Front Lighting.....	120
How Does Adaptive Front Lighting	
Work.....	120
Adjusting the Exterior Mirrors.....	129
Adjusting the Headlamps.....	392
Adjusting the Instrument Panel Lighting	
Brightness.....	124
Adjusting the Seatbelt Height.....	50
Adjusting the Seatbelts During	
Pregnancy.....	50
Adjusting the Sound Settings.....	458
Adjusting the Steering Wheel.....	104
Adjusting the Volume.....	458
Aid Mode.....	292
How Does Aid Mode Work.....	292
What Is Aid Mode.....	292
Airbag Precautions.....	58
Airbags.....	55
Front Passenger Sensing System.....	59
Air Conditioning	
See: Climate Control.....	139
Air Conditioning System	
Refrigerant.....	141

Index

Alarm	
See: Connecting a Trailer.....	331
Alert and Aid Mode.....	292
How Does Alert and Aid Mode Work.....	293
What Is Alert and Aid Mode.....	292
Alert Mode.....	291
Adjusting the Steering Wheel Vibration Intensity.....	292
How Does Alert Mode Work.....	292
What Is Alert Mode.....	291
All-Wheel Drive.....	214
AM/FM Radio.....	458
AM/FM Radio Limitations.....	458
Selecting an AM/FM Radio Station.....	459
Ambient Lighting.....	124
Anti-Lock Braking System.....	228
Anti-Lock Braking System Indicators.....	228
Anti-Lock Braking System Limitations.....	228
Anti-Theft Alarm System.....	100
Arming the Anti-Theft Alarm System.....	100
Disarming the Anti-Theft Alarm System.....	100
How Does the Anti-Theft Alarm System Work.....	100
What Is the Anti-Theft Alarm System.....	100
What Is the Perimeter Alarm.....	100
Appendices.....	509
Applying the Electric Parking Brake.....	232
Applying the Electric Parking Brake in an Emergency.....	232
Apps.....	468
Audio System.....	457
AM/FM Radio.....	458
Audio System – Troubleshooting.....	463
Digital Radio.....	459
Satellite Radio.....	460
Audio System Precautions.....	457
Audio System – Troubleshooting.....	463
Audio System – Information Messages.....	463
Auto-Dimming Exterior Mirror.....	130
What Is the Auto-Dimming Exterior Mirror.....	130
Auto-Dimming Interior Mirror.....	128
Auto-Dimming Interior Mirror Limitations.....	128
What Is the Auto-Dimming Interior Mirror.....	128
Auto Hold.....	240
Auto Hold Indicators.....	241
Autolamps.....	113
Autolamp Settings.....	113
What Are Autolamps.....	113
Autolock.....	83
Autolock Requirements.....	83
What Is Autolock.....	83
Automatically Releasing the Electric Parking Brake.....	233
Automatic Crash Shutoff.....	349
Automatic Crash Shutoff Precautions.....	349
Re-Enabling Your Vehicle.....	349
What Is Automatic Crash Shutoff.....	349
Automatic Emergency Braking.....	315
Switching Automatic Emergency Braking On and Off.....	315
What Is Automatic Emergency Braking.....	315
Automatic Engine Stop – Vehicles With: Push Button Start.....	180
How Does Automatic Engine Stop Work.....	180
Overriding Automatic Engine Stop.....	180
Switching Automatic Engine Stop On and Off.....	180
What Is Automatic Engine Stop.....	180
Automatic High Beam Control – Excluding: Police.....	117
Automatic High Beam Control Indicators.....	119
Automatic High Beam Control – Information Messages.....	119
Automatic High Beam Control Limitations.....	118
Automatic High Beam Control Precautions.....	118
Automatic High Beam Control Requirements.....	118
How Does Automatic High Beam Control Work.....	117

Index

Overriding Automatic High Beam Control.....	119
Switching Automatic High Beam Control On and Off.....	119
Automatic Lane Change.....	286
Automatic Locking Mode.....	49
Disengaging Automatic Locking Mode.....	49
Engaging Automatic Locking Mode.....	49
What Is Automatic Locking Mode.....	49
When to Use Automatic Locking Mode.....	49
Automatic Return to Park (P) - Excluding: Police.....	208
Automatic Transmission Audible Warnings - Excluding: Police.....	212
Automatic Transmission Audible Warnings - Police.....	212
Automatic Transmission.....	204
Automatic Transmission Positions.....	204
Automatic Transmission Fluid Capacity and Specification.....	212
Automatic Transmission – Information Messages.....	213
Automatic Transmission Position Indicators - Excluding: Police.....	206
Automatic Transmission Position Indicators - Police.....	206
Automatic Transmission Positions.....	204
Drive (D).....	205
Low (L).....	205
Manual (M).....	205
Neutral (N).....	205
Park (P).....	204
Reverse (R).....	205
Automatic Transmission Precautions.....	204
Auto-Start-Stop.....	188
Auto-Start-Stop – Troubleshooting.....	189
Auto-Start-Stop Indicators.....	188
Auto-Start-Stop Precautions.....	188
Auto-Start-Stop – Troubleshooting.....	189
Auto-Start-Stop – Frequently Asked Questions.....	190
Auto-Start-Stop – Information Messages.....	189
Autounlock.....	82
Autounlock Requirements.....	82
Switching Autounlock On and Off.....	82
What Is Autounlock.....	82
Autowipers.....	105
Adjusting the Sensitivity of the Rain Sensor.....	106
Autowipers Settings.....	106
What Are Autowipers.....	105
AWD See: All-Wheel Drive.....	214
B	
Blind Spot Assist.....	294
Blind Spot Assist Limitations.....	294
How Does Blind Spot Assist Work.....	294
What Is Blind Spot Assist.....	294
Blind Spot Assist with Trailer Coverage.....	294
Blind Spot Assist with Trailer Coverage Indicators.....	296
Blind Spot Assist with Trailer Coverage Limitations.....	295
How Does Blind Spot Assist with Trailer Coverage Work.....	294
What Is Blind Spot Assist with Trailer Coverage.....	294
Blind Spot Information System.....	299
Blind Spot Information System – Troubleshooting.....	303
Blind Spot Information System With Trailer Coverage.....	300
Blind Spot Information System Indicators.....	302
Blind Spot Information System Limitations.....	299
Blind Spot Information System Precautions.....	299
Blind Spot Information System Requirements.....	299
Blind Spot Information System – Troubleshooting.....	303
Blind Spot Information System – Information Messages.....	303

Index

Blind Spot Information System With Trailer Coverage.....	300
Blind Spot Information System With Trailer Coverage Limitations.....	301
Selecting a Trailer.....	302
Setting a Trailer Length.....	301
What Is Blind Spot Information System with Trailer Coverage.....	300
BlueCruise Alerts.....	283
BlueCruise Automatic Cancellation.....	283
BlueCruise.....	279
BlueCruise Indicators.....	284
BlueCruise – Information Messages.....	288
BlueCruise Limitations.....	281
BlueCruise Precautions.....	279
BlueCruise Requirements.....	281
BlueCruise Settings.....	282
Bluetooth®.....	477
Bonnet Lock See: Opening and Closing the Hood.....	364
Booster Seats.....	43
Brake Fluid Specification.....	229
Brake Over Accelerator.....	228
Brake Precautions.....	228
Brakes.....	228
Anti-Lock Braking System.....	228
Brakes – Troubleshooting.....	230
Brakes – Troubleshooting.....	230
Brakes – Frequently Asked Questions.....	231
Brakes – Information Messages.....	231
Brakes – Warning Lamps.....	230
Breaking-In.....	339
C	
Calculating Payload.....	324
Calculating the Load Limit.....	325
Canceling the Set Speed.....	263
Catalytic Converter.....	202
Catalytic Converter – Troubleshooting.....	202
Catalytic Converter Precautions.....	202
Catalytic Converter – Troubleshooting.....	202
Catalytic Converter – Warning Lamps.....	202
Center Console – Excluding: Police.....	172
Opening the Center Console.....	172
Center Display.....	467
Center Display Overview.....	467
Changing a Flat Tire – Excluding: Police.....	439
Changing a Flat Tire – Police.....	444
Changing a Road Wheel.....	439
Changing the Fuel Filter.....	384
Changing the Remote Control Battery – Police.....	77
Changing the Remote Control Battery – Vehicles With: Push Button Start, Excluding: Police.....	75
Charging a Device.....	167
Checking the Brake Fluid.....	228
Checking the Seatbelts.....	52
Checking the Tire Pressures.....	420
Checking the Wiper Blades.....	107
Children and Airbags.....	59
Child Restraint Anchor Points.....	35
Locating the Child Restraint Lower Anchor Points.....	35
Locating the Child Restraint Top Tether Anchor Points.....	36
What Are the Child Restraint Anchor Points.....	35
Child Restraints.....	36
Child Restraint Position Information.....	36
Child Restraints Recommendation.....	38
Child Safety.....	34
Child Restraint Anchor Points.....	35
Child Restraints.....	36
Installing Child Restraints.....	38
Child Safety Locks.....	45
Child Safety Precautions.....	34
Cleaning Products.....	401
Cleaning the Exterior.....	402
Cleaning Camera Lenses and Sensors.....	403
Cleaning Chrome, Aluminium or Stainless Steel.....	402
Cleaning Headlamps and Rear Lamps.....	402
Cleaning Stripes or Graphics.....	403
Cleaning the Engine Compartment.....	403
Cleaning the Exterior Precautions.....	402
Cleaning the Underbody.....	403

Index

Cleaning Wheels.....	402	Connecting the Vehicle to a Wi-Fi Network.....	452
Cleaning Windows and Wiper Blades.....	402	Connecting Your Phone.....	472
Cleaning the Interior.....	404	Contacting Us.....	15
Cleaning Carpets and Floor Mats.....	405	Controls.....	468
Cleaning Displays and Screens.....	404	Coolant.....	379
Cleaning Fabric.....	404	Adding Coolant.....	379
Cleaning Leather.....	405	Changing the Coolant.....	380
Cleaning Plastic.....	404	Checking the Coolant Level.....	379
Cleaning Seatbelts.....	406	Coolant – Information Messages.....	384
Cleaning Storage Compartments.....	406	Coolant – Warning Lamps.....	383
Cleaning the Instrument Panel.....	404	Cooling System Capacity and Specification.....	381
Cleaning Vinyl.....	405	Managing the Coolant Temperature.....	381
Climate Control.....	139	Crash and Breakdown Information.....	343
Closing the Liftgate.....	93	Automatic Crash Shutoff.....	349
Closing the Liftgate From Inside Your Vehicle.....	96	Fail-Safe Cooling.....	350
Closing the Liftgate From Outside Your Vehicle.....	93	Jump Starting the Vehicle.....	345
Closing the Liftgate Using the Remote Control.....	97	Post-Crash Alert System.....	348
Connected Vehicle.....	452	Crash Sensors and Airbag Indicator - Excluding: Police.....	62
Connected Vehicle – Troubleshooting.....	453	Crash Sensors and Airbag Indicator - Police.....	63
Connecting the Vehicle to a Mobile Network.....	452	Creating a Personal Profile.....	478
Connected Vehicle Data.....	27	Cross Traffic Alert.....	307
Connected Vehicle Limitations.....	452	Cross Traffic Alert – Troubleshooting.....	310
Connected Vehicle Requirements.....	452	Cross Traffic Alert Indicators.....	310
Connected Vehicle Settings.....	452	Cross Traffic Alert Limitations.....	308
Connected Vehicle – Troubleshooting.....	453	Cross Traffic Alert Precautions.....	307
Connected Vehicle – Frequently Asked Questions.....	453	Cross Traffic Alert – Troubleshooting.....	310
Connecting a Bluetooth® Device.....	477	Cross Traffic Alert – Information Messages.....	310
Connecting a Trailer.....	331	Cruise Control.....	262
Connecting a Trailer – Troubleshooting.....	332	Cruise Control Indicators.....	263
Connecting a Trailer Precautions.....	331	Customer Information.....	496
Connecting a Trailer – Troubleshooting.....	332	Customizing the Instrument Cluster Display.....	134
Connecting a Trailer – Information Messages.....	332	D	
Connecting the Vehicle to a Mobile Network.....	452	Data Privacy.....	25
Connecting FordPass to the Modem.....	452	Decommissioning Requirements.....	507
Enabling and Disabling the Modem.....	452	Decommissioning the Vehicle.....	507
What Is the Modem.....	452	Department of Transportation Uniform Tire Quality Grades.....	409

Index

Digital Radio.....	459	Drive Modes.....	224
Digital Radio Indicators.....	460	Deep Snow/Sand.....	224
Digital Radio Limitations.....	459	Eco.....	224
How Does Digital Radio Work.....	459	Normal.....	224
Switching Digital Radio Reception On and Off.....	460	Off-Road.....	224
What Is Digital Radio.....	459	Pursuit.....	224
Dinghy Tow		Slippery.....	225
See: Recreationally Towing Your Vehicle.....	352	Sport.....	225
Directing the Flow of Air.....	141	Tow/Haul.....	225
Disposing of Airbags.....	69	Trail.....	225
Door Lock Indicators.....	83	Driver Alert.....	320
Doors and Locks Audible Warnings.....	83	Driver Alert – Troubleshooting.....	321
Doors and Locks.....	81	Driver Alert Limitations.....	320
Autolock.....	83	Driver Alert Precautions.....	320
Autounlock.....	82	Driver Alert – Troubleshooting.....	321
Doors and Locks – Troubleshooting.....	83	Driver Alert – Information Messages.....	321
Mislock.....	83	Driver Assistance Menu.....	469
Operating the Doors From Inside Your Vehicle.....	82	Driving Economically.....	339
Operating the Doors From Outside Your Vehicle.....	81	Driving Hints.....	339
Doors and Locks – Troubleshooting.....	83	Driving in Cold Weather.....	339
Doors and Locks – Frequently Asked Questions.....	85	Driving In Sand.....	341
Doors and Locks – Information Messages.....	84	Driving on Hilly or Sloping Terrain.....	340
Doors and Locks – Warning Lamps.....	83	Driving Through Mud and Water.....	340
Drive Belt Routing Overview - 2.3L.....	384	Driving Through Shallow Water.....	341
Drive Belt Routing Overview - 3.0L.....	384	Drowsiness Monitor	
Drive Belt Routing Overview - 3.3L, Gasoline.....	385	See: Driver Alert.....	320
Drive Belt Routing Overview - 3.3L, Hybrid Electric Vehicle (HEV).....	385	E	
Drive Mode Control.....	223	Easy Entry and Exit.....	91
Drive Mode Control – Troubleshooting.....	226	Electric Parking Brake Audible Warning.....	233
Drive Modes.....	224	Electric Parking Brake.....	232
Drive Mode Control – Troubleshooting.....	226	Electric Parking Brake – Troubleshooting.....	233
Drive Mode Control – Frequently Asked Questions.....	227	Electric Parking Brake – Troubleshooting.....	233
Drive Mode Control – Information Messages.....	226	Electric Parking Brake – Information Messages.....	234
Drive Mode Control – Warning Lamps.....	226	Electric Parking Brake – Warning Lamps.....	233
		Electric Power Steering.....	249
		Electric Power Steering Precautions.....	249
		How Does Electric Power Steering Work.....	249
		Electromagnetic Compatibility.....	509
		Emergency Call Limitations.....	72
		Emergency Call Requirements.....	71

Index

Emergency Call System Data.....	28	Exterior Bulbs.....	393
Emergency Towing - Excluding: Police.....	352	Exterior Bulb Specification Chart.....	393
Emergency Towing - Police.....	352	Exterior Lamps.....	114
Emission Law.....	504	Exterior Lamps On Audible Warning.....	117
Enabling or Disabling Personal Profiles.....	478	How Do Cornering Lamps Work.....	114
Engine Air Filter.....	376	Switching the Daytime Running Lamps On and Off.....	115
Changing the Engine Air Filter.....	376	Using the Front Fog Lamps.....	115
Engine Block Heater - Vehicles With: Block Heater.....	176	Using the Off-Road Driving Lamps.....	116
Engine Block Heater Precautions.....	176	Using the Turn Signal Lamps.....	114
How Does the Engine Block Heater Work.....	177	Exterior Lighting Control - Excluding: Police.....	112
Using the Engine Block Heater.....	177	Exterior Lighting Control.....	112
Engine Coolant Temperature Gauge.....	133	Exterior Lighting.....	112
Engine Oil.....	369	Adaptive Front Lighting.....	120
Adding Engine Oil.....	370	Autolamps.....	113
Checking the Engine Oil Level.....	369	Automatic High Beam Control - Excluding: Police.....	117
Engine Oil Capacity and Specification.....	370	Exterior Lamps.....	114
Engine Oil Dipstick Overview.....	369	Headlamps.....	112
Intelligent Oil Life Monitor.....	370	Exterior Lighting – Frequently Asked Questions.....	120
Resetting the Intelligent Oil Life Monitor.....	370	Exterior Mirrors.....	129
Engine Specifications - 2.3L.....	394	Auto-Dimming Exterior Mirror.....	130
Engine Specifications - 3.0L.....	395	Exterior Overview.....	32
Engine Specifications - 3.3L, Gasoline.....	396	F	
Engine Specifications - 3.3L, Hybrid Electric Vehicle (HEV).....	397	Fail-Safe Cooling.....	350
Environment.....	30	Driving When Fail-Safe Mode Is Activated.....	350
Evasive Steering Assist.....	315	Fail-Safe Cooling Indicators.....	351
Evasive Steering Assist Limitations.....	316	How Does Fail-Safe Cooling Work.....	350
Switching Evasive Steering Assist On and Off.....	316	What Is Fail-Safe Cooling.....	350
What Is Evasive Steering Assist.....	315	Fastening and Unfastening the Seatbelts.....	48
Event Data.....	26	Federal Highway Administration Regulation.....	504
Exit Warning.....	304	Flat Tire See: Changing a Flat Tire - Excluding: Police.....	439
Exit Warning – Troubleshooting.....	306	See: Changing a Flat Tire - Police.....	444
Exit Warning Indicators.....	305	Flat Tow See: Recreationally Towing Your Vehicle.....	352
Exit Warning Limitations.....	304	Floor Mats.....	341
Exit Warning Precautions.....	304	Folding the Exterior Mirrors - Vehicles With: Manual Folding Mirrors.....	130
Exit Warning – Troubleshooting.....	306		
Exit Warning – Information Messages.....	306		
Export Unique Options.....	505		

Index

Folding the Exterior Mirrors - Vehicles	
With: Power Folding Mirrors.....	129
Ford Protect.....	486
Four-Wheel Drive.....	217
Four-Wheel Drive – Troubleshooting.....	219
Four-Wheel Drive Limitations.....	217
Four-Wheel Drive –	
Troubleshooting.....	219
Four-Wheel Drive – Information	
Messages.....	220
Four-Wheel Drive – Warning Lamps.....	219
Four Wheels Down Tow	
See: Recreationally Towing Your	
Vehicle.....	352
Front Axle Fluid Capacity and	
Specification.....	221
Front Axle.....	221
Front Parking Aid.....	252
Front Parking Aid Audible Warnings.....	253
Front Parking Aid Limitations.....	253
Locating the Front Parking Aid	
Sensors.....	253
What is the Front Parking Aid.....	252
Front Passenger Sensing System.....	59
Front Passenger Sensing System	
Indicators.....	62
Front Passenger Sensing System	
Precautions.....	61
How Does the Front Passenger Sensing	
System Work.....	59
What Is the Front Passenger Sensing	
System.....	59
Front Seat Precautions.....	145
Front Seats.....	145
Heated Seats.....	151
Manual Seats.....	146
Massage Seats.....	150
Power Seats.....	147
Ventilated Seats.....	151
Fuel and Refueling.....	191
Fuel and Refueling –	
Troubleshooting.....	199
Fuel Quality.....	191
Refueling.....	194
Running Out of Fuel.....	192
Fuel and Refueling Precautions.....	191
Fuel and Refueling –	
Troubleshooting.....	199
Fuel and Refueling – Information	
Messages.....	200
Fuel and Refueling – Warning Lamps.....	199
Fuel Gauge.....	133
Fuel Gauge Limitations.....	133
Locating the Fuel Filler Door.....	133
What Is Distance to Empty.....	133
What Is the Fuel Gauge.....	133
What Is the Low Fuel Reminder.....	133
Fuel Quality.....	191
Selecting the Correct Fuel.....	191
Fuel Tank Capacity - Excluding: Full	
Hybrid Electric Vehicle (FHEV).....	199
Fuel Tank Capacity - Full Hybrid Electric	
Vehicle (FHEV).....	199
Fuse Precautions.....	353
Fuses.....	353
Fuses – Troubleshooting.....	362
Interior Fuse Box.....	359
Under Hood Fuse Box.....	353
Fuses – Troubleshooting.....	362
Fuses – Frequently Asked Questions.....	362

G

Garage Door Opener.....	163
Garage Door Opener Introduction.....	163
Garage Door Opener Precautions and	
Frequencies.....	163
General Maintenance Information.....	492
Getting Assistance Outside the U.S. and	
Canada.....	501
Getting the Services You Need.....	496
Glasses Holder.....	173
Locating the Glasses Holder.....	173
Glass Roof.....	131
Global Opening.....	127
Switching Global Opening On and	
Off.....	127
Using Global Opening.....	127
What Is Global Opening.....	127
Glossary of Tire Terminology.....	415
Glove Compartment.....	172
Locking the Glove Compartment.....	172
Opening the Glove Compartment.....	172
Google Assistant.....	470

Index

Grade Assist.....	208	How Does Cross Traffic Alert Work.....	307
H		How Does Drive Mode Control Work.....	223
Headlamp Adjusting		How Does Driver Alert Work.....	320
See: Adjusting the Headlamps.....	392	How Does Easy Entry and Exit Work.....	91
Headlamps.....	112	How Does Exit Warning Work.....	304
Headlamp Indicators.....	113	How Does Four-Wheel Drive Work.....	217
Switching Headlamp Exit Delay On and Off.....	113	How Does Hill Start Assist Work.....	239
Using the High Beam Headlamps.....	112	How Does Pre-Collision Assist Work.....	311
Heated Seats.....	151	How Does Reverse Brake Assist Work.....	235
Heated Seat Precautions.....	151	How Does Speed Sign Recognition Work.....	318
Switching the Heated Seats On and Off.....	151	How Does Stability Control Work.....	244
Heating		How Does the 360 Degree Camera Work.....	259
See: Climate Control.....	139	How Does the Lane Keeping System Work.....	290
High Voltage Battery.....	203	How Does the Memory Function Work.....	162
High Voltage Battery – Troubleshooting.....	203	How Does the Personal Safety System Work.....	54
High Voltage Battery Precautions.....	203	How Does the Rear Occupant Alert System Work.....	159
High Voltage Battery – Troubleshooting.....	203	How Does the Safety Canopy™ Work.....	57
High Voltage Battery – Information Messages.....	203	How Does Traction Control Work.....	242
High Voltage Battery Vehicle Precautions - Full Hybrid Electric Vehicle (FHEV).....	344	How Does Trailer Sway Control Work.....	338
Hill Descent Control.....	248	How Do Personal Profiles Work.....	478
Hill Descent Control Indicator.....	248	How Do the Front Airbags Work.....	55
Hill Start Assist.....	239	How Do the Knee Airbags Work - Excluding: Police.....	56
Hill Start Assist – Troubleshooting.....	239	How Do the Knee Airbags Work - Police.....	56
Hill Start Assist Precautions.....	239	How Do the Side Airbags Work.....	55
Hill Start Assist – Troubleshooting.....	239	Hybrid Electric Vehicle Information.....	185
Hill Start Assist – Information Messages.....	239		
Hood Lock		I	
See: Opening and Closing the Hood.....	364	Icon Glossary	
Horn.....	104	See: Symbols Glossary.....	20
How Does 911 Assist Work.....	71	Icons	
How Does Adaptive Cruise Control With Stop and Go Work.....	264	See: Symbols Glossary.....	20
How Does All-Wheel Drive Work.....	214	Identifying Fuse Types.....	362
How Does Auto Hold Work.....	240		
How Does Blind Spot Information System Work.....	299		
How Does BlueCruise Work.....	279		

Index

Identifying the Climate Control Unit.....	139
Identifying the Rear Passenger Climate Control Unit.....	142
Ignition Switch - Police, Vehicles With: Keyed Ignition.....	174
In California (U.S. Only).....	498
Inflating the Tires.....	420
Information on the Tire Sidewall.....	410
In-Lane Repositioning.....	287
Inspecting the Tire for Damage.....	422
Inspecting the Tire for Wear.....	421
Inspecting the Wheel Valve Stems.....	426
Installing and Removing the Luggage Compartment Cargo Net.....	328
Installing and Removing the Luggage Compartment Cover.....	329
Installing Child Restraints.....	38
Combining the Seatbelt and Lower Anchors for Attaching Child Restraints.....	42
Installing a Child Restraint in a Center Seat.....	41
Using Lower Anchors and Tethers for Children.....	40
Using Seatbelts.....	38
Using Tether Straps.....	42
Instrument Cluster Display.....	134
Instrument Cluster Display Main Menu.....	134
Instrument Cluster.....	132
Fuel Gauge.....	133
Instrument Cluster Overview.....	132
Interior Air Quality.....	144
Interior Bulbs.....	393
Interior Bulb Specification Chart.....	393
Interior Fuse Box.....	359
Accessing the Interior Fuse Box.....	359
Identifying the Fuses in the Interior Fuse Box.....	360
Locating the Interior Fuse Box.....	359
Interior Lamp Function.....	124
Switching the Interior Lamp Function On and Off.....	124
What Is the Interior Lamp Function.....	124
Interior Lighting.....	122
Interior Lamp Function.....	124
Interior Lighting – Troubleshooting.....	125
Interior Lighting – Troubleshooting.....	125
Interior Lighting – Frequently Asked Questions.....	125
Interior Mirror.....	128
Auto-Dimming Interior Mirror.....	128
Interior Mirror Precautions.....	128
Interior Overview.....	31
Introduction.....	17
J	
Jump Starting the Vehicle.....	345
Jump Starting Precautions.....	345
Jump Starting the Vehicle.....	346
Preparing the Vehicle.....	346
K	
Keyless Entry.....	86
Keyless Entry – Troubleshooting.....	87
Keyless Entry Keypad.....	88
Keyless Entry Keypad – Troubleshooting.....	90
Keyless Entry Keypad Limitations.....	88
Keyless Entry Keypad Master Access Code.....	88
Keyless Entry Keypad Personal Access Codes.....	89
Keyless Entry Keypad – Troubleshooting.....	90
Keyless Entry Keypad – Frequently Asked Questions.....	90
Keyless Entry Limitations.....	86
Keyless Entry Settings.....	86
Keyless Entry – Troubleshooting.....	87
Keyless Entry – Frequently Asked Questions.....	87
Keys and Remote Controls Audible Warnings - Excluding: Police.....	79
Keys and Remote Controls Audible Warnings - Police.....	79
Keys and Remote Controls.....	73
Keys and Remote Controls – Troubleshooting.....	80
Keys and Remote Controls – Troubleshooting.....	80
Keys and Remote Controls – Information Messages.....	80

Index

L

Lane Centering.....	271
How Does Lane Centering Work.....	271
Lane Centering Alerts.....	273
Lane Centering Automatic Cancellation.....	273
Lane Centering Indicators.....	274
Lane Centering Limitations.....	272
Lane Centering Manual Cancellation.....	274
Lane Centering Precautions.....	271
Lane Centering Requirements.....	272
Switching Lane Centering On and Off.....	272
Lane Centering – Troubleshooting.....	274
Lane Centering – Information Messages.....	274
Lane Change Assist.....	284
Lane Keeping System Indicators.....	293
Lane Keeping System.....	290
Aid Mode.....	292
Alert and Aid Mode.....	292
Alert Mode.....	291
Blind Spot Assist.....	294
Blind Spot Assist with Trailer Coverage.....	294
Lane Keeping System – Troubleshooting.....	297
Lane Keeping System Limitations.....	290
Lane Keeping System Precautions.....	290
Lane Keeping System – Troubleshooting.....	297
Lane Keeping System – Frequently Asked Questions.....	298
Lane Keeping System – Information Messages.....	297
Launching or Retrieving a Boat or Personal Watercraft.....	335
Liftgate.....	92
Closing the Liftgate.....	93
Liftgate – Troubleshooting.....	98
Opening the Liftgate.....	92
Liftgate Obstacle Detection.....	97
Liftgate Precautions.....	94
Liftgate – Troubleshooting.....	98
Liftgate – Frequently Asked Questions.....	99
Liftgate – Information Messages.....	98
Liftgate – Warning Lamps.....	98
Limited Slip Differential – Vehicles With: Limited-Slip Differential.....	222
Linking or Unlinking a Personal Profile.....	478
Load Carrying.....	322
Roof Rack.....	326
Load Carrying Precautions.....	322
Loading Your Trailer.....	334
Locating the 360 Degree Cameras.....	259
Locating the Blind Spot Information System Sensors.....	300
Locating the Brake Fluid Reservoir.....	228
Locating the Cabin Air Filter.....	144
Locating the Cross Traffic Alert Sensors.....	309
Locating the Exit Warning Sensors.....	305
Locating the Fuel Filler Funnel.....	192
Locating the Keyless Entry Keypad.....	88
Locating the Memory Function Buttons.....	162
Locating the Power Outlets.....	169
Locating the Pre-Collision Assist Sensors.....	314
Locating the Rear View Camera.....	256
Locating the Safety Compliance Certification Labels.....	323
Locating the Tire label.....	409
Locating the Tire Sealant and Inflator Kit.....	428
Locating the USB Ports.....	167
Locating Your Vehicle.....	75
Locking the Rear Window Controls.....	127
Luggage Compartment Anchor Points.....	330
Locating the Luggage Compartment Anchor Points.....	330
Luggage Compartment.....	328
Luggage Compartment Anchor Points.....	330
Luggage Compartment Precautions.....	328

Index

M	
Maintenance.....	364
12V Battery.....	385
12V Battery – Troubleshooting.....	390
Coolant.....	379
Engine Air Filter.....	376
Engine Oil.....	369
Exterior Bulbs.....	393
Interior Bulbs.....	393
Maintenance Precautions.....	364
Making and Receiving a Phone Call.....	473
Manually Dimming the Interior Mirror.....	128
Manually Releasing the Electric Parking Brake.....	232
Manually Shifting Gears - Excluding: Police.....	206
Manual Seats.....	146
Accessing the Third Row Seats.....	156
Adjusting the Head Restraint.....	146
Adjusting the Seat Backrest.....	147
Folding the Seat Backrest.....	154
Folding the Seats.....	155
Head Restraint Components.....	146
Installing the Head Restraint.....	154
Moving the Seat Backward and Forward.....	147
Removing the Head Restraint.....	153
Unfolding the Seats.....	155
Massage Seats.....	150
Adjusting the Massage Seat Settings.....	150
Massage Seat Limitations.....	150
Media Control Buttons.....	457
Memory Function.....	162
Memory Function Precautions.....	162
Mislock.....	83
How Does Mislock Work.....	83
Mislock Limitations.....	83
Switching Mislock On and Off.....	83
What Is Mislock.....	83
Mobile Communications Equipment.....	504
Mobile Device Data.....	28
Moonroof See: Glass Roof.....	131
Motorcraft Parts - 2.3L.....	398
Motorcraft Parts - 3.0L.....	398
Motorcraft Parts - 3.3L.....	399
N	
Navigation.....	480
Neutral Towing See: Recreationally Towing Your Vehicle.....	352
Neutral Tow See: Recreationally Towing Your Vehicle.....	352
O	
Opening and Closing the Hood.....	364
Opening and Closing the Sunshade.....	131
Opening and Closing the Windows.....	126
Opening the Liftgate.....	92
Opening the Liftgate From Inside Your Vehicle.....	92
Opening the Liftgate From Outside Your Vehicle.....	92
Opening the Liftgate Using the Remote Control.....	92
Opening The Open On Approach Liftgate.....	95
Open On Approach Settings.....	95
Operating the Doors From Inside Your Vehicle.....	82
Opening the Doors From Inside Your Vehicle.....	82
Unlocking and Locking the Doors Using the Central Locking.....	82
Operating the Doors From Outside Your Vehicle.....	81
Unlocking and Locking the Doors Using the Key Blade.....	81
Unlocking and Locking the Doors Using the Remote Control.....	81
OTA See: Software Update Settings.....	481
See: Vehicle Software Updates.....	481
Overriding Reverse Brake Assist.....	236
Overriding the Set Speed.....	270
Over the air See: Software Update Settings.....	481

Index

Over-the-air	
See: Software Update Settings.....	481
See: Vehicle Software Updates.....	481
See: Vehicle Software Updates.....	481
P	
Panorama Roof	
See: Glass Roof.....	131
Panoramic Roof	
See: Glass Roof.....	131
Parking Aid Indicators.....	254
Parking Aid Precautions.....	251
Parking Aids.....	251
Front Parking Aid.....	252
Parking Aids – Troubleshooting.....	255
Rear Parking Aid.....	252
Parking Aids – Troubleshooting.....	255
Parking Aids – Information	
Messages.....	255
Passive Anti-Theft System.....	100
How Does the Passive Anti-Theft System	
Work.....	100
What Is the Passive Anti-Theft	
System.....	100
Pedestrian Alert System.....	70
Perchlorate.....	503
Performing a System Reset.....	483
Personal Profiles.....	478
Personal Safety System	
Components.....	54
Personal Safety System™.....	54
Phone Menu.....	472
Phone.....	472
Phone Precautions.....	472
Playing Media Using Bluetooth®.....	477
Playing Media Using the USB Port.....	167
Police Engine Idle - Police.....	179
How Does Police Engine Idle Work.....	179
What Is Police Engine Idle.....	179
Post-Collision Braking - Excluding:	
Police.....	348
Post-Crash Alert System.....	348
How Does the Post-Crash Alert System	
Work.....	348
Switching the Post-Crash Alert System	
Off.....	348
What Is the Post-Crash Alert	
System.....	348
Power Flow.....	186
Power Outlet Indicators.....	169
Power Outlet Limitations.....	169
Power Outlet.....	169
Power Outlet Precautions.....	169
Power Seats.....	147
Accessing the Third Row Seats.....	157
Adjusting the Lumbar Support.....	150
Adjusting the Seat Backrest.....	148
Adjusting the Seat Cushion.....	148
Adjusting the Seat Height.....	149
Folding the Seats.....	156
Moving the Seat Backward and	
Forward.....	147
Power-Up	
See: Software Update Settings.....	481
See: Vehicle Software Updates.....	481
Pre-Collision Assist Limitations.....	312
Pre-Collision Assist Precautions.....	311
Pre-Collision Assist.....	311
Automatic Emergency Braking.....	315
Evasive Steering Assist.....	315
Pre-Collision Assist –	
Troubleshooting.....	316
Pre-Collision Assist –	
Troubleshooting.....	316
Pre-Collision Assist – Frequently Asked	
Questions.....	317
Pre-Collision Assist – Information	
Messages.....	316
Pre-Collision Assist – Warning	
Lamps.....	316
Predictive Speed Assist.....	275
Adjusting the Set Speed Tolerance.....	276
How Does Predictive Speed Assist	
Work.....	275
Predictive Speed Assist Alerts.....	276
Predictive Speed Assist Indicators.....	276
Predictive Speed Assist Limitations.....	275
Predictive Speed Assist Precautions.....	275
Switching Predictive Speed Assist Mode	
On and Off.....	276
Predictive Speed Assist –	
Troubleshooting.....	277
Predictive Speed Assist – Information	
Messages.....	277

Index

Preparing Your Vehicle for Storage.....	407
Programming the Garage Door Opener.....	164
Programming the Remote Control.....	78
Properly Adjusting the Driver and Front Passenger Seats.....	58
Protecting the Environment.....	30
Puncture	
See: Changing a Flat Tire - Excluding: Police.....	439
See: Changing a Flat Tire - Police.....	444
Push Button Ignition Switch - Vehicles With: Push Button Start.....	175

R

Radio Frequency Certification Labels.....	503
Rear Axle Fluid Capacity and Specification.....	222
Rear Axle.....	222
Rear Occupant Alert System Audible Warnings.....	161
Rear Occupant Alert System Indicators.....	160
Rear Occupant Alert System Limitations.....	159
Rear Occupant Alert System Precautions.....	159
Rear Occupant Alert System Settings.....	160
Rear Parking Aid.....	252
Locating the Rear Parking Aid Sensors.....	252
Rear Parking Aid Audible Warnings.....	252
Rear Parking Aid Limitations.....	252
What is the Rear Parking Aid.....	252
Rear Passenger Climate Control.....	142
Rear Seats.....	153
Heated Seats.....	158
Manual Seats.....	153
Power Seats.....	156
Rear View Camera Guide Lines.....	257
Rear View Camera Precautions.....	256
Rear View Camera.....	256
Rear View Camera Settings.....	257

Rear View Camera Settings.....	257
Switching Rear View Camera Delay On and Off.....	258
Switching the Rear View Camera View.....	258
Zooming the Rear View Camera In and Out.....	257
Rebooting the Displays.....	469
Recalling a Preset Position.....	162
Recreationally Towing Your Vehicle.....	352
Recycling and Disposing of the High Voltage Battery.....	203
Refueling.....	194
Manually Opening the Fuel Filler Door.....	198
Refueling System Overview.....	194
Refueling Your Vehicle.....	194
Releasing the Electric Parking Brake if the Vehicle Battery Has Run Out of Charge.....	233
Remote Control Limitations.....	73
Remote Start.....	137
Remote Start Settings.....	138
Removing the Key Blade.....	74
Removing Your Vehicle From Storage.....	408
Repairing Minor Paint Damage.....	406
Replacement Parts Recommendation.....	503
Replacing a Lost Key or Remote Control.....	78
Replacing the Front Wiper Blades.....	107
Replacing the Rear Wiper Blades.....	108
Reporting Safety Defects in Canada.....	502
Reporting Safety Defects in the United States.....	502
Resetting the Trip Computer.....	136
Restarting the Engine.....	188
Resuming the Set Speed.....	263
Reverse Brake Assist Indicators.....	236
Reverse Brake Assist Precautions.....	235
Reverse Brake Assist.....	235
Reverse Brake Assist – Troubleshooting.....	237

Index

Reverse Brake Assist – Troubleshooting.....	237
Reverse Brake Assist – Frequently Asked Questions.....	238
Reverse Brake Assist – Information Messages.....	237
Reverse Wipe.....	107
Reverse Wipe Settings.....	107
What Is Reverse Wipe.....	107
Roadside Assistance.....	343
Rollover Warning.....	496
Roof Rack.....	326
Roof Rack Load Capacities.....	327
Roof Rack Precautions.....	326
Running-In	
See: Breaking-In.....	339
Running Out of Fuel.....	192
Adding Fuel From a Portable Fuel Container.....	193
Filling a Portable Fuel Container.....	192
S	
Satellite Radio.....	460
Locating the Satellite Radio Identification Number.....	461
Satellite Radio Limitations.....	460
Satellite Radio Settings.....	461
Selecting a Channel.....	461
Setting an Alert.....	462
What Is Satellite Radio.....	460
Saving a Preset Position.....	162
Scheduled Maintenance.....	488
Seatbelt Extensions.....	52
Seatbelt Precautions.....	47
Seatbelt Reminder.....	50
How Does the Seatbelt Reminder Work.....	50
Seatbelt Reminder Audible Warnings.....	51
Seatbelt Reminder Indicators.....	50
Switching the Seatbelt Reminder On and Off.....	52
Seatbelts.....	47
Automatic Locking Mode.....	49
Seatbelt Reminder.....	50
Sensitive Locking Mode.....	49
SecuriCode	
See: Keyless Entry Keypad.....	88
Security.....	100
Anti-Theft Alarm System.....	100
Passive Anti-Theft System.....	100
Security – Troubleshooting.....	102
Security – Troubleshooting.....	102
Security – Frequently Asked Questions.....	103
Security – Information Messages.....	102
Selecting a Drive Mode - Excluding: Police.....	223
Selecting a Drive Mode - Police.....	223
Selecting the Audio Source.....	457
Sending and Receiving a Text Message.....	474
Sensitive Locking Mode.....	49
How Does Sensitive Locking Mode Work.....	49
What is Sensitive Locking Mode.....	49
Service Data.....	26
Setting a Memory Preset.....	458
Settings Data.....	27
Settings.....	468
Setting the Adaptive Cruise Control Gap.....	268
Setting the Adaptive Cruise Control Speed.....	267
Setting the Blower Motor Speed.....	140
Setting the Clock and Date.....	458
Setting the Cruise Control Speed.....	262
Setting the Hill Descent Speed.....	248
Setting the Liftgate Opening Height.....	96
Setting the Temperature.....	140
Setting Up a Vehicle Hotspot.....	455
Setting Your Default Assistant.....	470
Shifting Your Immobile Vehicle Out of Park (P) - Excluding: Police.....	208
Shifting Your Immobile Vehicle Out of Park (P) - Police.....	210
Shifting Your Vehicle Into Gear - Excluding: Police.....	205
Shifting Your Vehicle Into Gear - Police.....	206
Sitting in the Correct Position.....	145
Software Update Indicators.....	482
Software Update Settings.....	481

Index

Software Update	
See: Software Update Settings.....	481
See: Vehicle Software Updates.....	481
Sounding the Panic Alarm - Excluding:	
Police.....	75
Sounding the Panic Alarm - Police.....	75
Speed Control	
See: Cruise Control - Police.....	262
Speedometer.....	132
Speed Sign Recognition Indicators.....	319
Speed Sign Recognition	
Limitations.....	318
Speed Sign Recognition	
Precautions.....	318
Speed Sign Recognition Settings.....	319
Speed Sign Recognition.....	318
Speed Sign Recognition –	
Troubleshooting.....	319
Speed Sign Recognition –	
Troubleshooting.....	319
Speed Sign Recognition – Frequently Asked	
Questions.....	319
Stability Control Indicator.....	247
Stability Control.....	244
Starter Switch	
See: Ignition Switch - Police, Vehicles With:	
Keyed Ignition.....	174
Starting and Stopping the Engine –	
Precautions.....	174
Starting and Stopping the Engine.....	174
Automatic Engine Stop - Vehicles With:	
Push Button Start.....	180
Engine Block Heater - Vehicles With: Block	
Heater.....	176
Police Engine Idle - Police.....	179
Starting and Stopping the Engine –	
Troubleshooting.....	181
Starting the Engine.....	175
Stopping the Engine.....	178
Starting and Stopping the Engine –	
Troubleshooting.....	181
Starting and Stopping the Engine –	
Frequently Asked Questions.....	183
Starting and Stopping the Engine –	
Information Messages.....	182
Starting and Stopping the Engine –	
Warning Lamps.....	181
Starting the Engine.....	175
Restarting the Engine After Stopping	
It.....	176
Starting a Gasoline Engine.....	175
Starting a Hybrid Electric Vehicle	
System.....	176
Status Bar.....	467
Steering.....	249
Electric Power Steering.....	249
Steering – Troubleshooting.....	250
Steering – Troubleshooting.....	250
Steering – Information Messages.....	250
Steering Wheel.....	104
Stopping the Engine.....	188
Stopping the Engine When Your Vehicle is	
Moving.....	178
Stopping the Engine When Your Vehicle is	
Stationary.....	178
Stopping the Liftgate Movement.....	97
Storage.....	172
Center Console - Excluding: Police.....	172
Glasses Holder.....	173
Glove Compartment.....	172
Under Floor Storage.....	173
Storing Your Vehicle.....	407
Sunroof	
See: Glass Roof.....	131
Switching Adaptive Cruise Control On	
and Off.....	266
Switching Air Conditioning On and	
Off.....	139
Switching All of the Interior Lamps On	
and Off - Excluding: Police.....	122
Switching All of the Interior Lamps On	
and Off - Police.....	122
Switching Android Auto™ On and	
Off.....	475
Switching Apple CarPlay On and	
Off.....	475
Switching Auto Hold On and Off.....	240
Switching Auto-Start-Stop On and	
Off.....	188
Switching Blind Spot Information	
System On and Off.....	300
Switching BlueCruise On and Off.....	282
Switching Climate Control On and	
Off.....	139

Index

Switching Cross Traffic Alert On and Off.....	309
Switching Cruise Control On and Off.....	262
Switching Defrost On and Off.....	139
Switching Driver Alert On and Off.....	321
Switching Easy Entry and Exit On and Off.....	91
Switching Exit Warning On and Off.....	305
Switching From Adaptive Cruise Control to Cruise Control.....	271
Switching Hill Descent Control On and Off.....	248
Switching Maximum Cooling On and Off.....	140
Switching Maximum Defrost On and Off.....	139
Switching Parking Aid On and Off.....	251
Switching Pre-Collision Assist On and Off - Excluding: Police.....	314
Switching Pre-Collision Assist On and Off - Police.....	314
Switching Recirculated Air On and Off.....	139
Switching Reverse Brake Assist On and Off.....	236
Switching Stability Control On and Off - Excluding: Police.....	245
Switching Stability Control On and Off - Police.....	246
Switching Text Message Notification On and Off.....	475
Switching the Audio Unit On and Off.....	457
Switching the Front Interior Lamps On and Off - Excluding: Police.....	122
Switching the Front Interior Lamps On and Off - Police.....	123
Switching the Hazard Flashers On and Off.....	345
Switching the Heated Mirrors On and Off.....	140
Switching the Heated Rear Window On and Off.....	140
Switching the Heated Steering Wheel On and Off - Vehicles With: Heated Steering Wheel.....	104
Switching the Lane Keeping System Mode.....	291
Switching the Lane Keeping System On and Off.....	291
Switching the Rear Interior Lamps On and Off - Excluding: Police.....	123
Switching the Rear Interior Lamps On and Off - Police.....	124
Switching the Rear Passenger Climate Controls On and Off.....	142
Switching the Rear Window Wiper On and Off - Excluding: Police.....	106
Switching the Rear Window Wiper On and Off - Police.....	106
Switching Traction Control On and Off.....	242
Symbols Glossary.....	20
Symbols Used On Your Instrument Cluster.....	22
Symbols Used on Your Vehicle.....	20
System Update See: Software Update Settings.....	481
See: Vehicle Software Updates.....	481
T	
Tachometer.....	132
Temporary Neutral Mode.....	207
The Better Business Bureau Auto Line Program.....	500
The Mediation and Arbitration Program.....	500
Third Party Software Copyright Acknowledgment.....	503
Tire Care.....	420
Tire Pressure Monitoring System Limitations.....	436
Tire Pressure Monitoring System Overview.....	435
Tire Pressure Monitoring System Precautions.....	436
Tire Pressure Monitoring System.....	435
Tire Pressure Monitoring System - Troubleshooting.....	437
Tire Pressure Monitoring System - Troubleshooting.....	437
Tire Pressure Monitoring System - Information Messages.....	438

Index

Tire Pressure Monitoring System – Warning Lamps.....	437
Tire Replacement Requirements.....	416
Tire Rotation.....	426
Tire Sealant and Inflator Kit Components.....	429
Tire Sealant and Inflator Kit Precautions.....	428
Tire Sealant and Inflator Kit.....	428
Towing a Trailer Limitations.....	334
Towing a Trailer Precautions.....	333
Towing a Trailer.....	333
Towing a Trailer – Troubleshooting.....	337
Towing Weights and Dimensions.....	336
Towing a Trailer – Troubleshooting.....	337
Towing a Trailer – Information Messages.....	337
Towing Weights and Dimensions.....	336
Calculating the Maximum Loaded Trailer Weight for Your Vehicle.....	336
Recommended Towing Weights.....	336
What Is the Maximum Loaded Trailer Weight.....	336
Towing Your Vehicle Precautions.....	352
Towing Your Vehicle.....	352
Traction Control Indicator.....	242
Traction Control.....	242
Traction Control – Troubleshooting.....	243
Traction Control – Troubleshooting.....	243
Traction Control – Information Messages.....	243
Trailer Brake Precautions.....	333
Trailer Sway Control Precautions.....	338
Trailer Sway Control.....	338
Trailer Towing Hints.....	334
Transfer Case Fluid Capacity and Specification.....	219
Transporting the Vehicle.....	349
Trip Computer.....	136
Trip Data.....	136
U	
Under Floor Storage.....	173
Locating the Rear Under Floor Storage.....	173
Under Hood Fuse Box.....	353
Accessing the Under Hood Fuse Box.....	353
Identifying the Fuses in the Under Hood Fuse Box.....	354
Locating the Under Hood Fuse Box.....	353
Under Hood Overview - 2.3L.....	366
Under Hood Overview - 3.0L.....	367
Under Hood Overview - 3.3L.....	368
USB Ports.....	167
Using Auto Hold.....	240
Using Keyless Entry.....	86
Using Remote Start - Vehicles With: FordPass.....	137
Using Remote Start - Vehicles With: Remote Control.....	137
Using Snow Chains.....	418
Using the Instrument Cluster Display Controls.....	134
Using the Keyless Entry Keypad.....	89
Using the Police Perimeter Alert System - Police.....	101
Using the Remote Control - Excluding: Police.....	73
Using the Remote Control - Police.....	74
Using the Tire Sealant and Inflator Kit.....	429
Using the Valet Mode.....	79
Using This Publication.....	19
V	
Vehicle Care.....	401
Cleaning the Exterior.....	402
Cleaning the Interior.....	404
Vehicle Hotspot Settings.....	455
Vehicle Hotspot – Troubleshooting.....	456
Vehicle Hotspot – Frequently Asked Questions.....	456
Vehicle Hotspot.....	455
Vehicle Hotspot – Troubleshooting.....	456
Vehicle Identification Number.....	451
Locating the Vehicle Identification Number.....	451
Vehicle Identification Number Overview.....	451
Vehicle Identification.....	451
Vehicle Identification Number.....	451

Index

Vehicle Software Updates.....	481
Vehicle Specifications.....	394
Vehicle System Reset.....	483
Ventilated Seats.....	151
Switching the Ventilated Seats On and Off.....	151
Ventilated Seat Precautions.....	151
Ventilation	
See: Climate Control.....	139
Viewing the Tire Pressures.....	437
Visual Search.....	31
Voice Interaction.....	470
W	
Warranty Information.....	506
Washers.....	108
Adding Washer Fluid.....	110
Switching the Courtesy Wipe On and Off.....	109
Using the Rear Window Washer.....	109
Using the Windshield Washer.....	108
Washer Fluid Specification.....	110
Washer Precautions.....	108
Washers	
See: Wipers and Washers.....	105
Waxing Your Vehicle.....	406
What Is 911 Assist.....	71
What Is a Connected Vehicle.....	452
What Is Auto-Start-Stop.....	188
What Is Blind Spot Information System.....	299
What Is Cross Traffic Alert.....	307
What Is Cruise Control.....	262
What Is Drive Mode Control.....	223
What Is Driver Alert.....	320
What Is Exit Warning.....	304
What Is Ford Protect.....	486
What Is Hill Descent Control.....	248
What Is Hill Start Assist.....	239
What Is Keyless Entry.....	86
What Is Pre-Collision Assist.....	311
What Is Speed Sign Recognition.....	318
What Is the Cabin Air Filter.....	144
What Is the Catalytic Converter.....	202
What Is the Electric Parking Brake.....	232
What Is the Gross Axle Weight Rating.....	323
What Is the Gross Combined Weight Rating.....	324
What Is the Gross Vehicle Weight Rating.....	323
What Is the High Voltage Battery.....	203
What Is the Keyless Entry Keypad.....	88
What Is the Lane Keeping System.....	290
What Is the Pedestrian Alert System.....	70
What Is the Personal Safety System.....	54
What Is the Power Outlet.....	169
What Is the Rear Occupant Alert System.....	159
What Is the Rear View Camera.....	256
What Is the Tire Pressure Monitoring System.....	435
What Is the Tire Sealant and Inflator Kit.....	428
What Is Traction Control.....	242
What Is Voice Interaction.....	470
Wheel and Tire Information.....	409
Wheel Nuts.....	449
Wi Fi	
See: Connecting the Vehicle to a Wi-Fi Network.....	452
Window Bounce-Back.....	127
Overriding Window Bounce-Back.....	127
What Is Window Bounce-Back.....	127
Windows.....	126
Global Opening.....	127
Window Bounce-Back.....	127
Wipers and Washers – Troubleshooting.....	111
Wipers and Washers – Frequently Asked Questions.....	111
Wipers and Washers – Warning Lamps.....	111
Wipers and Washers.....	105
Autowipers.....	105
Reverse Wipe.....	107
Washers.....	108
Wipers.....	105
Wipers and Washers – Troubleshooting.....	111
Wipers.....	105
Switching Windshield Wipers On and Off.....	105

Index

Wiper Precautions.....105

