

OWNER'S HANDBOOK

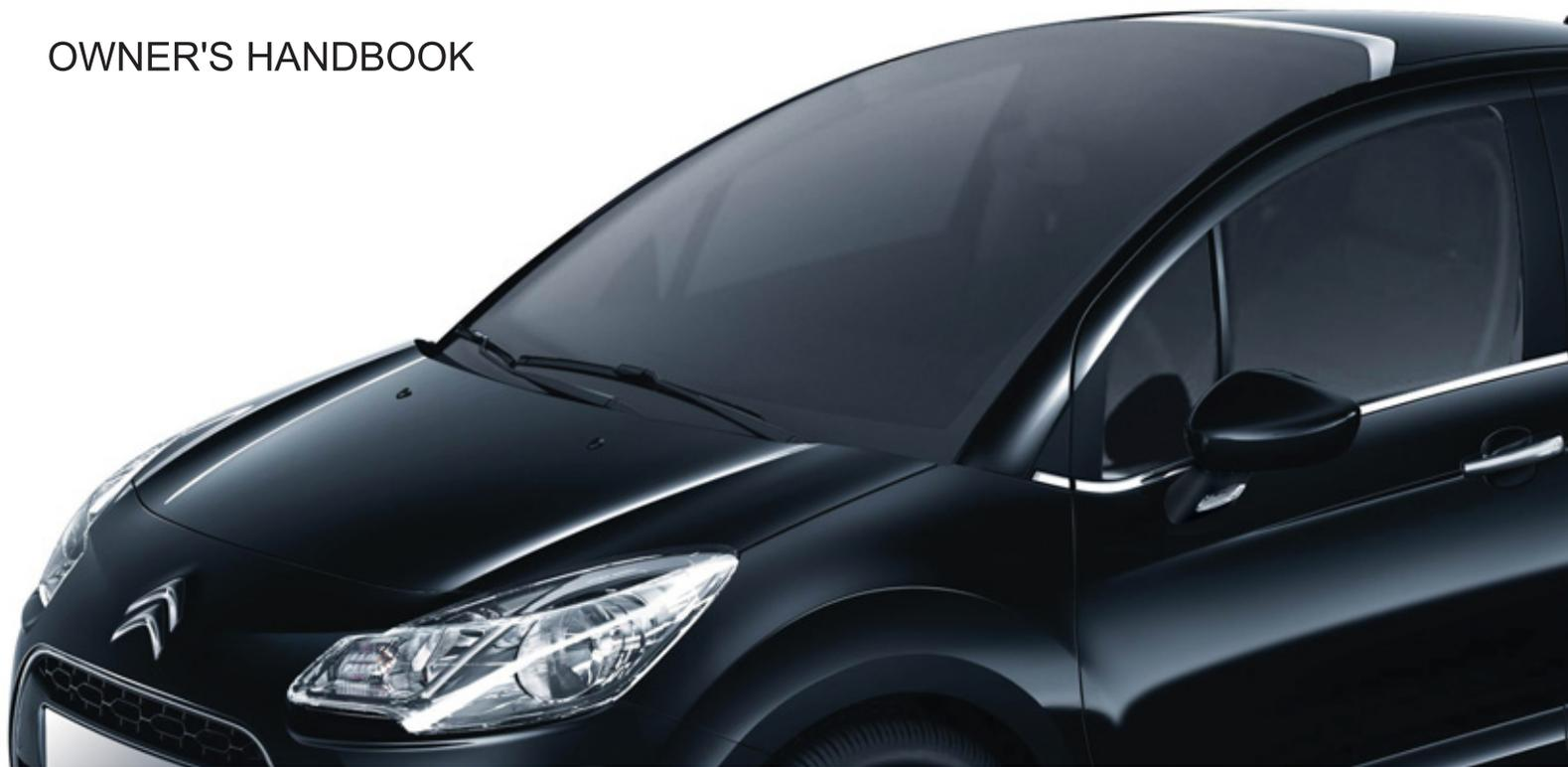

CITROËN C3



YOUR HANDBOOK ON THE INTERNET!

CITROËN lets you view your vehicle's documentation on line, to see earlier versions and the latest information, simply and free of charge.

CITROËN SERVICE
<http://service.citroen.com>

Connect to <http://service.citroen.com>:

- 1 |** Select your language and register,
- 2 |** click on the link in the "Private customer access" zone to consult the vehicle documentation; a window opens providing access to all of the handbooks,
- 3 |** select your vehicle, choose the body type then the date of issue of the handbook,
- 4 |** finally, click on the heading of your choice.

We draw your attention to the following...

Your vehicle is fitted with only some of the equipment described in this document, depending on the trim level, version and the specifications for the country in which it is sold.

The fitting of electrical equipment or accessories which are not recommended by CITROËN may result in a failure of your vehicle's electronic system. Please note this specific warning and contact a CITROËN dealer to be shown the recommended equipment and accessories.

Key

-  safety warning
-  additional information
-  contributes to the protection of the environment
-  refer to the page indicated

CITROËN has a presence on every continent,
a complete product range,
bringing together technology and a permanent spirit of innovation,
for a modern and creative approach to mobility.
We thank you and congratulate you on your choice.

At the wheel of your new vehicle,
getting to know each system,
each control, each setting,
makes your trips, your journeys
more comfortable and more enjoyable.

Happy motoring!

CONTENTS

FAMILIARISATION 4 → 20

ECO-DRIVING 21 → 22

1 - MONITORING 23 → 42

Instrument panels	23
Indicator and warning lamps	25
Indicators	35
Adjustment buttons	38
Trip computer	40

2 - MULTIFUNCTION SCREENS 43 → 49

Monochrome screen A	43
Monochrome screen C	45
16/9 colour screen (MyWay)	48

3 - COMFORT 50 → 63

Ventilation	50
Heating	52
Manual air conditioning	52
Digital air conditioning	55
Rear screen demist - defrost	57
Scented air freshener	58
Front seats	59
Rear seats	61
Mirrors	62
Steering wheel adjustment	63

4 - ACCESS 64 → 76

Remote control key	64
Window controls	68
Doors	70
Boot	73
Fuel tank	74
Misfuel prevention (Diesel)	76

5 - VISIBILITY 77 → 85

Lighting controls	77
Headlamp adjustment	80
Wiper controls	81
Courtesy lamps	84
Interior mood lighting	85
Boot lamp	85

6 - FITTINGS 86 → 91

Interior fittings	86
Boot fittings	90

7 - CHILD SAFETY 92 → 100

Child seats	92
ISOFIX child seats	97
Child lock	100

CONTENTS

8 - SAFETY 101 → 109

Direction indicators	101
Hazard warning lamps	101
Horn	101
Emergency or assistance call	102
Braking assistance systems	102
Trajectory control systems	103
Front seat belts	104
Airbags	106

10 - CHECKS 129 → 135

Bonnet	130
Running out of fuel (Diesel)	130
Petrol engines	131
Diesel engines	132
Checking levels	133
Checks	134

12 - TECHNICAL DATA 167 → 178

Petrol engines	167
Petrol weights	168
LPG engines	170
LPG weights	171
Diesel engines	172
Diesel weights	174
Dimensions	176
Identification markings	177

9 - DRIVING 110 → 128

Parking brake	110
6-speed manual gearbox	110
Gear efficiency indicator	111
Electronic gearbox	112
Automatic gearbox	116
Stop & Start	119
Hill start assist	122
Speed limiter	123
Cruise control	125
Rear parking sensors	127

11 - PRACTICAL INFORMATION 136 → 166

Temporary puncture repair kit	136
Changing a wheel	141
Changing a bulb	145
Changing a fuse	151
Battery	158
Energy economy mode	160
Changing a wiper blade	160
Towing the vehicle	161
Towing a trailer	163
Audio pre-equipment	164
Accessories	165

AUDIO and TELEMATICS 179 → 234

Emergency or assistance	179
MyWay	181
Audio system	213

VISUALSEARCH 235 → 238

ALPHABETICAL INDEX 239 → 242

EXTERIOR

Zenith windscreen

This large windscreen provides incomparable visibility and light in the passenger compartment.

» 6

Temporary puncture repair kit

This kit is a complete system consisting of a compressor and sealant cartridge, to allow the temporary repair of a tyre.

» 136



Stop & Start

This system puts the engine temporarily into standby during stops in the traffic (red lights, traffic jams, etc...). The engine restarts automatically as soon as you want to move off. The Stop & Start system reduces fuel consumption, exhaust emissions and the noise level when stationary.

» 119

Rear parking sensors

This system provides a warning when reversing by detecting obstacles located behind the vehicle.

» 127

ACCESS

Remote control key



- A. Unfolding/Folding the key.
- B. Unlocking the vehicle.

» 64



Other functions...

- C. Normal locking of the vehicle
Vehicle location.

Fuel tank

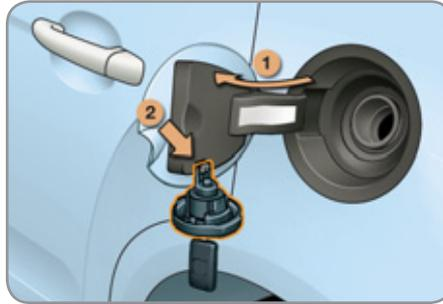

1. Opening the fuel filler flap.
2. Opening and hooking the fuel filler cap.

Tank capacity:

- approximately 50 litres (petrol),
- approximately 46 litres (Diesel),
- (depending on version: approximately 30 litres (petrol or Diesel)).

» 74

Bonnet

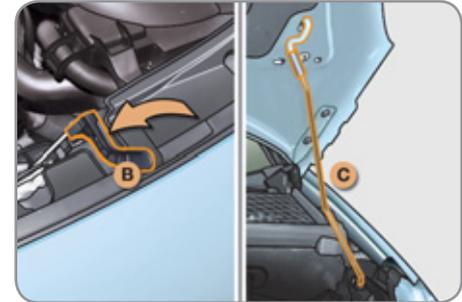
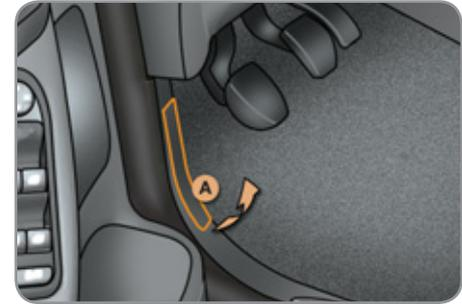

- A. Interior release lever.
- B. Exterior safety catch.
- C. Bonnet stay.

» 130

ZENITH WINDSCREEN



System comprising a panoramic tinted glass area to increase lighting and vision in the cabin.

Fitted with a manual blind to improve thermal comfort and sun visors to avoid dazzle.

Blind

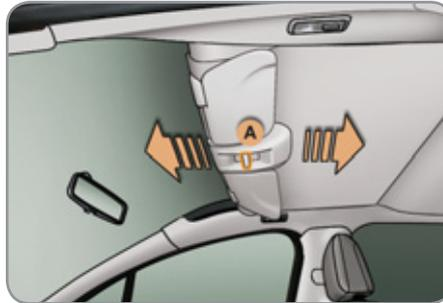

- ☞ To open the blind, take it by its central grip **A**, then pull it backwards and guide it to the desired position.
- ☞ To close the blind, take it by its central grip **A**, then pull it forwards and guide it to the desired position.

Before moving the blind, the sun visors must be in the folded position.

Sun visors



- ☞ Lower the sun visors to avoid dazzle.



Do not attach or hang heavy objects to the blind or its guide rails.

INTERIOR

Interior mood lighting

This subdued passenger compartment lighting improves visibility inside the vehicle in low lighting conditions. It comprises several lamps, located in the automatic day/night mirror support and in the lower dashboard storage compartment.

» 85

Scented air freshener

The scented air freshener diffuses the selected fragrance throughout the passenger compartment from its location in the ventilation system.

» 58

Digital air conditioning

After setting the desired level of comfort, the system then automatically controls this level according to the ambient conditions.

» 55

Audio and communication systems

This equipment benefits from the latest technology: MP3 compatible Audio system, USB port, Bluetooth hands-free system, MyWay with 16/9 colour screen, auxiliary inputs, Hi-Fi audio system.

MyWay

» 181

Audio system

» 213

Gear shift indicator

Associated with the manual gearbox, this system suggests when to change up to obtain optimum fuel consumption.

» 111

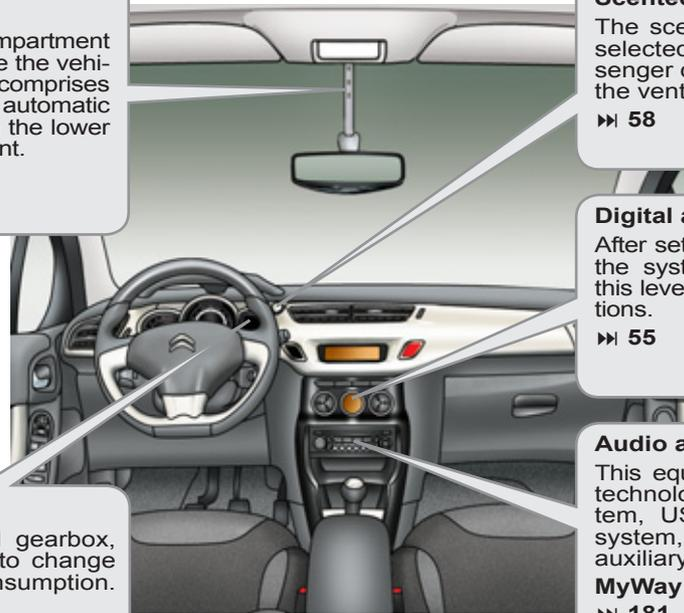

INSTRUMENTS AND CONTROLS

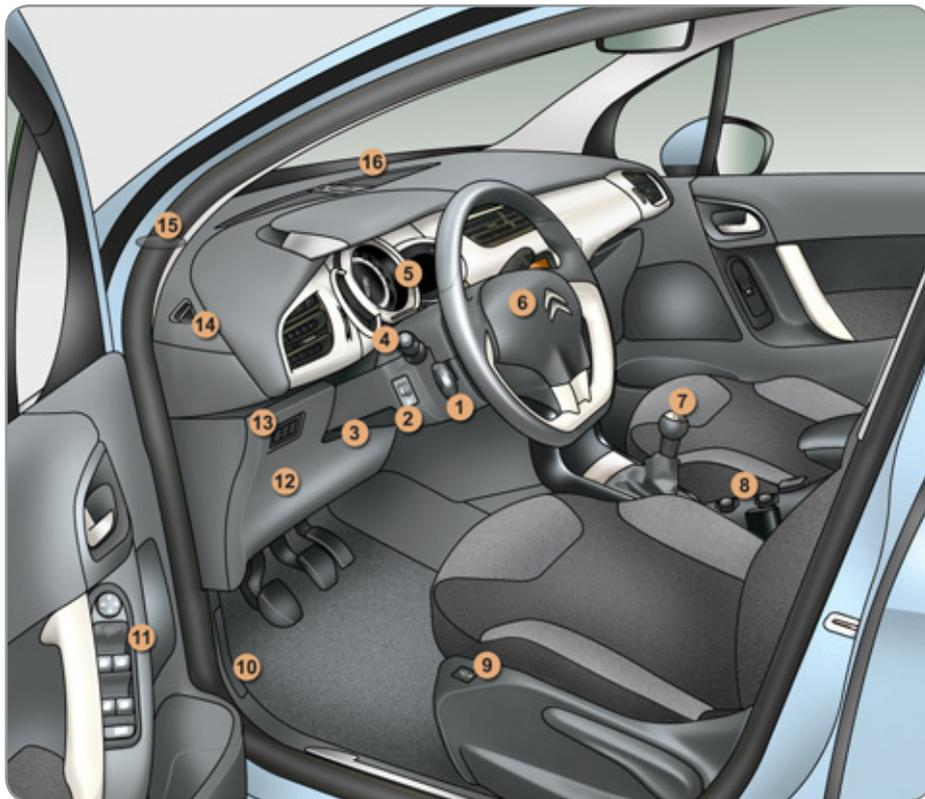

1. Cruise control/speed limiter switches.
2. Headlamp height adjustment.
3. Steering wheel adjustment control.
4. Lighting and direction indicators control stalk.
5. Instrument panel.
6. Driver's airbag.
Horn.
7. Gear lever.
8. 12 V accessory socket
USB port/auxiliary socket.
9. Heated seat control.
10. Bonnet release lever.
11. Door mirror controls.
Electric window controls.
Rear doors and electric windows
deactivation switch.
12. Fusebox.
13. Stop & Start switch
Electronic stability programme
switch (ESP/ASR).
14. Front door window demisting/
defrosting vent.
15. Speaker (tweeter).
16. Windscreen demisting/defrosting
vent.

INSTRUMENTS AND CONTROLS



1. Steering lock and ignition.
2. Audio equipment steering wheel controls.
3. Wipers/screenwash/trip computer control stalk.
4. Microphone.
5. Scented air freshener.
6. Central locking switch.
7. Multifunction screen.
8. Hazard warning lamps switch.
9. Central adjustable air vents.
10. Sunshine sensor
Hi-Fi audio system central speaker.
11. Passenger's airbag.
12. Side adjustable air vent.
13. Glove box/Passenger's airbag deactivation/Audio/video sockets.
14. Parking brake.
15. Central armrest with storage.
16. Upper and lower storage.
17. MyWay or Audio system.
18. Heating/air conditioning controls.

SITTING COMFORTABLY

Front seats



1. Forwards-backwards adjustment.

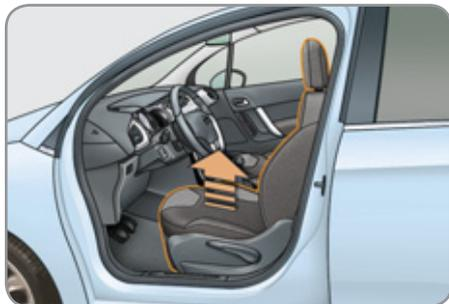

2. Height adjustment.



3. Seat back angle adjustment.

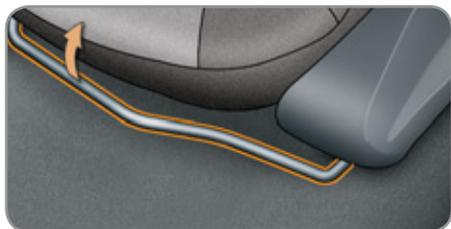

SITTING COMFORTABLY

Other adjustments

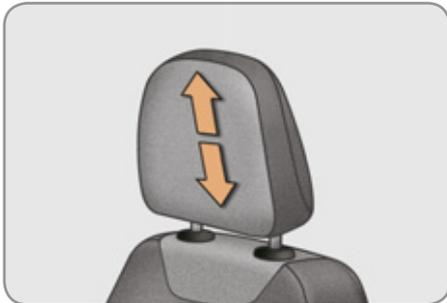

4. Head restraint height adjustment.

» 60



Other functions...
Heated seats.

Steering wheel adjustment

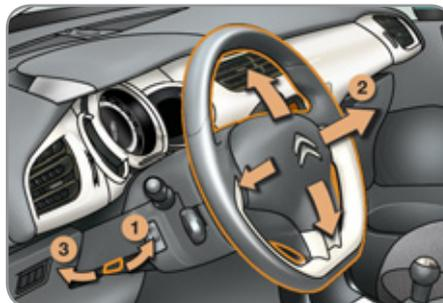

1. Release the adjustment mechanism.
2. Adjust the wheel for height and reach.
3. Lock the adjustment mechanism.



For reasons of safety, these operations must only be carried out with the vehicle stationary.

» 63

SITTING COMFORTABLY

Door mirrors



Adjustment

- A. Selecting the mirror.
- B. Adjusting the position of the mirror.
- C. De-selecting the mirror.

» 62



Other functions...
Folding/Unfolding.

Rear view mirror

Manual day/night type



1. Selecting the "day" position of the mirror.
2. Adjusting the mirror.

» 63

Automatic day/night type



1. Automatic detection of day/night mode.
2. Adjusting the mirror.

» 63

Front seat belts

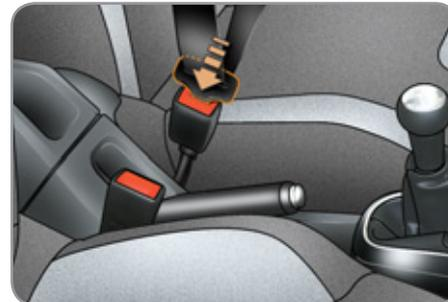

1. Fitting the belt.
2. Fastening.
3. Check that the belt is correctly fastened by pulling on the belt webbing.

» 104

SEEING CLEARLY

Lighting

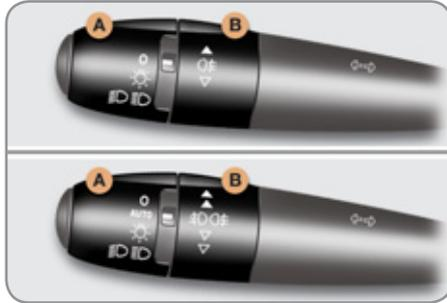

Ring A

- 0** Lighting off.
- AUTO** Automatic illumination of headlamps.
- Sidelamps.
- Dipped/main beam headlamps.

Ring B

- Rear foglamps.
 - or
 - Front and rear foglamps.
- » 77

Wipers

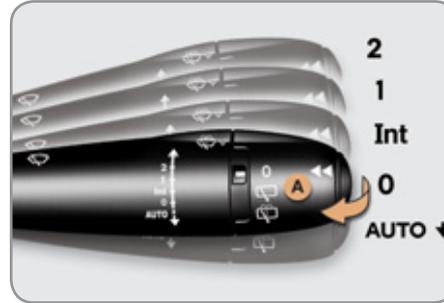

Control stalk A: windscreen wipers

- 2.** Fast wipe.
- 1.** Normal wipe.
- Int.** Intermittent wipe.
- 0.** Park.
- AUTO** ↓ Automatic wiping or single wipe.

Wash-wipe: pull the control stalk towards you.

» 81

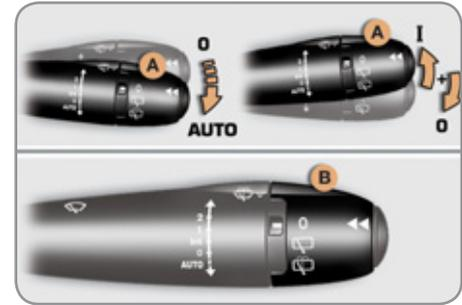

Switching on "AUTO" mode

- ☞ Push the control stalk downwards and release it.

Switching off "AUTO" mode

- ☞ Push the control stalk upwards and return it to position "0".
- » 83

Ring B: rear wiper

- 0** Park.
 - Intermittent wipe.
 - Wash-wipe.
- » 82

VENTILATION

Advice on interior settings

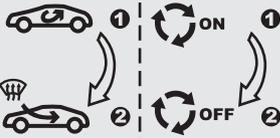
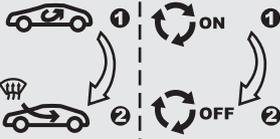
I require...	Heating or Manual air conditioning				
	Air distribution	Air flow	Air recirculation/ Exterior air intake	Temperature	Manual A/C
HEAT					
COOL					ON
DEMISTING DEFROSTING					ON

Digital air conditioning: use of the fully automatic mode by pressing the "AUTO" button is recommended.

MONITORING

Instrument panel



- A. With the ignition on, the fuel gauge bars for the fuel remaining should come on.
- B. With the engine running, the associated low level warning lamp should go off.
- C. With the ignition on, the oil level indicator should display "OIL OK" for a few seconds.

If the levels are not correct, top up the level which is low.

» 23

Warning lamps



1. With the ignition on, the orange and red warning lamps come on.
2. With the engine running, these warning lamps should go off.

If a warning lamp remains on, refer to the page concerned.

» 25, 30

Switch panel



Illumination of the indicator lamp indicates the state of the corresponding system.

- A. ESP/ASR system deactivation.

» 103

- B. Stop & Start system deactivation.

» 120

PASSENGER SAFETY

Front passenger's airbag

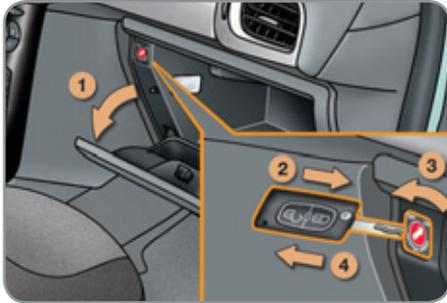

1. Open the glove box.
2. Insert the key.
3. Select position:
"ON" (activation), with front passenger or "forwards facing" child seat,
"OFF" (deactivation), with "rear facing" child seat".
4. Remove the key keeping the switch in the new position.

»» 107

Front seat belts and passenger's front airbag



- A. Front seat belts not fastened or unfastened warning lamp.

»» 104

- B. Front passenger's airbag deactivation indicator lamp.
- C. Front passenger's airbag activation indicator lamp.

»» 107

Electric child lock



Illumination of the lamp A indicates that the rear door and rear electric window controls are deactivated.

»» 100

DRIVING SAFELY

Electronic gearbox

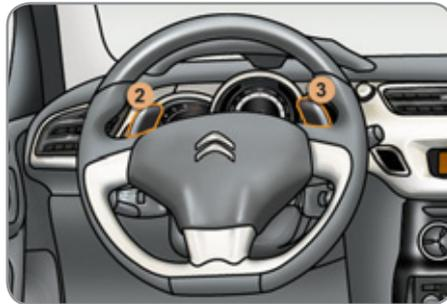

5 or 6-speed electronic gearbox offering the choice of the comfort of automated operation or the pleasure of manual gear changing.

1. Gear lever.
2. Steering-mounted "-" control paddle.
3. Steering-mounted "+" control paddle.

Display in the instrument panel



The gear engaged or the driving mode selected appears in the instrument panel screen.

- N.** Neutral.
- R.** Reverse.
- 1 to 5/6.** Gears engaged.
- AUTO.** Automated mode.

Starting and moving off



- ☞ Select position **N**.
- ☞ Apply the foot brake firmly
- ☞ Start the engine.
- ☞ Select automated mode (position **A**) or manual mode (position **M**) by moving the gear lever **1**, or engage reverse by pushing the gear lever **1** to the position **R**.
- ☞ Release the parking brake.
- ☞ Progressively take your foot off the brake pedal, then move off.

DRIVING SAFELY

Automatic gearbox



This 4-speed gearbox offers the choice of the comfort of automatic operation or the pleasure of manual gear changing.

1. Gear lever.
2. "S" (sport) switch.
3. "❄️" (snow) switch.

Display in the instrument panel



The driving mode selected and/or the gear engaged appear in the instrument panel screen.

- P.** Park.
- R.** Reverse.
- N.** Neutral.
- D.** Drive (Automatic operation).
- S.** **Sport** programme.
- ❄️** **Snow** programme.
- 1 to 4.** Gears engaged.
- .** Invalid value in manual operation.

Starting and moving off

- ☞ Apply the parking brake.
- ☞ Select position **P** or **N**.
- ☞ Start the engine.
- ☞ Apply the foot brake.
- ☞ Release the parking brake.
- ☞ Then select position **R**, **D** or **M**.
- ☞ Progressively remove your foot from the brake pedal: the vehicle moves off on its own.

Stop & Start

Going into engine STOP mode

ECO The "ECO" warning lamp comes on in the instrument panel and the engine goes into standby:

- **with a manual gearbox:** at speeds below 12 mph (20 km/h), when you put the gear lever into neutral and you release the clutch pedal,
- **with a 5 or 6-speed electronic gearbox:** at speeds below 5 mph (8 km/h), when you press the brake pedal or you move the gear lever to position **N**.

In some circumstances, STOP mode may not be available; the "ECO" warning lamp flashes for a few seconds, then goes off.

» 119

Going into engine START mode

ECO The "ECO" warning lamp goes off and the engine restarts:

- **with a manual gearbox:** when you depress the clutch pedal,
- **with a 5 or 6-speed electronic gearbox:**
 - with the gear lever in position **A** or **M**, when you release the brake pedal,
 - or with the gear lever in position **N** and the brake pedal released, when you put the gear lever in position **A** or **M**,
 - or when you engage reverse.

In certain circumstances, START mode may be invoked automatically; the "ECO" warning lamp flashes for a few seconds, then goes off.

» 120



Deactivation/Reactivation

You can deactivate the system at any time by pressing the "ECO OFF" switch; the warning lamp in the button comes on.



The system is reactivated automatically every time the vehicle is started using the key.



Before refueling or doing anything under the bonnet, you must switch off the ignition with the key.

» 120

DRIVING SAFELY

Speed limiter "LIMIT"

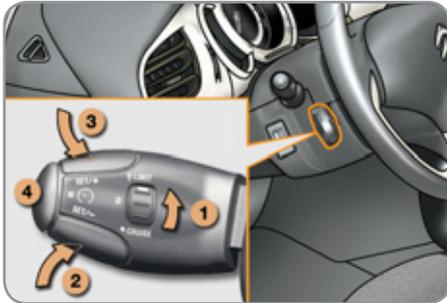

1. Selecting/switching off speed limiter mode.
2. Decrease the programmed value.
3. Increase the programmed value.
4. Speed limiter on/off.

The values must be set with the engine running.

» 123

Cruise control "CRUISE"

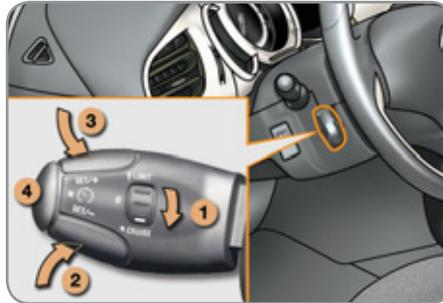

1. Selecting/switching off cruise control mode.
2. Decrease the programmed value.
3. Increase the programmed value.
4. Cruise control Off/Resume.

In order to be programmed or activated, the vehicle speed must be higher than 25 mph (40 km/h), with at least fourth gear engaged on a manual gearbox (second gear on an electronic or automatic gearbox).

» 125

Display in the instrument panel



The cruise control or speed limiter mode appears in the instrument panel when it is selected.

CRUISE  **Cruise control**

LIMIT  **Speed limiter**

ECO-DRIVING

Eco-driving is a range of everyday practices that allow the motorist to optimise their fuel consumption and CO₂ emissions.

Optimise the use of your gearbox

With a manual gearbox, move off gently, change up without waiting and drive by changing up quite soon. If your vehicle has the system, the gear shift indicator invites you to change up; it is displayed in the instrument panel, follow its instructions.

With an automatic or electronic gearbox, stay in Drive "**D**" or Auto "**A**", according to the type of gearbox, without pressing the accelerator pedal heavily or suddenly.

Drive smoothly

Maintain a safe distance between vehicles, use engine braking rather than the brake pedal, and press the accelerator progressively. These practices contribute towards a reduction in fuel consumption and CO₂ emissions and also helps reduce the background traffic noise.

If your vehicle has cruise control, make use of the system at speeds above 25 mph (40 km/h) when the traffic is flowing well.

Control the use of your electrical equipment

Before moving off, if the passenger compartment is too warm, ventilate it by opening the windows and air vents before using the air conditioning.

Above 30 mph (50 km/h), close the windows and leave the air vents open. Remember to make use of equipment that can help keep the temperature in the passenger compartment down (sun roof and window blinds...).

Switch off the air conditioning, unless it has automatic digital regulation, as soon as the desired temperature is attained.

Switch off the demisting and defrosting controls, if not automatic.

Switch off the heated seat as soon as possible.

Switch off the headlamps and front foglamps when the level of light does not require their use.

Avoid running the engine before moving off, particularly in winter; your vehicle will warm up much faster while driving.

As a passenger, if you avoid connecting your multimedia devices (film, music, video game...), you will contribute towards limiting the consumption of electrical energy, and so of fuel.

Disconnect your portable devices before leaving the vehicle.

Limit the causes of excess consumption

Spread loads throughout the vehicle; place the heaviest items in the bottom of the boot, as close as possible to the rear seats.

Limit the loads carried in the vehicle and reduce wind resistance (roof bars, roof rack, bicycle carrier, trailer...). Use a roof box in preference.

Remove roof bars and roof racks after use.

At the end of winter, remove snow tyres and refit your summer tyres.

Observe the recommendations on maintenance

Check the tyre pressures regularly, when cold, referring to the label in the door aperture, driver's side.

Carry out this check in particular:

- before a long journey,
- at each change of season,
- after a long period out of use.

Don't forget the spare wheel and the tyres on any trailer or caravan.

Have your vehicle serviced regularly (engine oil, oil filter, air filter...) and observe the schedule of operations recommended by the manufacturer.

When refuelling, do not continue after the 3rd cut-off of the nozzle to avoid any overflow.

At the wheel of your new vehicle, it is only after the first 1 800 miles (3 000 kilometres) that you will see the fuel consumption settle down to a consistent average.

MONITORING

PETROL - DIESEL MANUAL GEARBOX INSTRUMENT PANELS



Panel grouping together the vehicle operation indication dials and warning lamps.

Dials

1. Rev counter.

Indicates the speed of rotation of the engine (x 1 000 rpm).

2. Vehicle speed.

Indicates the current speed of the moving vehicle (mph or km/h).

3. Fuel level.

Indicates the quantity of fuel remaining in the tank.

4. Screen.

5. Display management button

Servicing information.

Adjust the time and choose units.

Reset the service indicator.

6. Instrument panel lighting button.

Adjusts the brightness of the lighting of the instruments and controls.



For more information, refer to the section on the button or function and its associated display.

Screen



A. Ambient temperature.

(°Celsius or °Fahrenheit)

B. Gear shift indicator.

C. Time.

D. Engine oil level indicator.

Appears a few seconds after switching on the ignition, then disappears.

E. Trip computer.

F. Service indicator.

(miles or km) then,

Total mileage.

These two functions are displayed successively when switching on the ignition.

MONITORING

INSTRUMENT PANELS FOR PETROL - DIESEL, MANUAL, ELECTRONIC OR AUTOMATIC GEARBOXES

1



Panel grouping together the vehicle operation indication dials and warning lamps. Depending on the version, the instrument panel may have permanent back-lighting.

Dials

1. Rev counter.

Indicates the speed of rotation of the engine (x 1 000 rpm).

2. Vehicle speed.

Indicates the current speed of the moving vehicle (mph or km/h).

3. Fuel level.

Indicates the quantity of fuel remaining in the tank.

4. Screen.

5. Display management button

Alternates display between range and trip mileage recorder.

Servicing information.

Resets the selected function to zero (trip distance recorder or service indicator).

6. Instrument panel lighting button.

Adjusts the brightness of the lighting of the instruments and controls.



For more information, refer to the section on the button or function and its associated display.

Screen



A. Speed limiter

(mph or km/h) or

Cruise control.

B. Gear shift indicator.

C. Electronic or automatic gearbox information.

D. Range

(miles or km) or

Trip mileage recorder.

E. Service indicator

(miles or km), then

Total mileage recorder

These two functions are displayed successively when switching on the ignition

F. Engine oil level indicator

Appears a few seconds after switching on the ignition, then disappears.

MONITORING

Indicator and warning lamps

Visual indicators informing the driver that a system is in operation (operation or deactivation indicator lamps) or of the occurrence of a fault (warning lamp).

When the ignition is switched on

Certain warning lamps come on for a few seconds when the vehicle's ignition is switched on.

When the engine is started, these same warning lamps should go off.

If they remain on, before moving off, refer to the information on the warning lamp concerned.

Associated warnings

The illumination of certain warning lamps may be accompanied by an audible signal and a message in the multifunction screen.

Operation indicator lamps

If one of the following indicator lamps comes on, this confirms that the corresponding system has come into operation.



The warning lamps may come on continuously (fixed) or flash.

Certain warning lamps may come on in two different modes. Only by relating the type of illumination to the operating status of the vehicle can it be ascertained whether the situation is normal or whether a fault has occurred.

1

Warning lamp		is on	Cause	Action/Observations
	Left-hand direction indicator	flashing with buzzer.	The lighting stalk is pushed down.	
	Right-hand direction indicator	flashing with buzzer.	The lighting stalk is pushed up.	
	Hazard warning lamps	flashing with audible signal.	The hazard warning lamps switch, located on the dashboard, has been operated.	The left-hand and right-hand direction indicators and their associated indicator lamps flash simultaneously.
	Sidelamps	fixed.	The lighting stalk is in the "Sidelamps" position.	

MONITORING

1

Warning lamp		is on	Cause	Action/Observations
	Dipped beam headlamps	fixed.	The lighting stalk is in the "Dipped beam headlamps" position.	
	Main beam headlamps	fixed.	The lighting stalk is pulled towards you.	Pull the stalk to return to dipped beam headlamps.
	Front foglamps	fixed.	The front foglamps are switched on.	Turn the ring on the stalk rearwards twice to switch off the front foglamps.
	Rear foglamps	fixed.	The rear foglamps are switched on.	Turn the ring on the stalk rearwards to switch off the rear foglamps.
	Diesel engine pre-heating	fixed.	The ignition switch is at the 2nd position (ignition on).	Wait until the warning lamp goes off before starting. The period of illumination of the warning lamp is determined by the climatic conditions (up to about thirty seconds in extreme climatic conditions). If the engine does not start, switch the ignition off and then on, wait until the warning lamp goes off again, then start the engine.
	Parking brake	fixed.	The parking brake is applied or not properly released.	Release the parking brake to switch off the warning lamp, keeping your foot on the brake pedal. Observe the safety recommendations. For further information on the parking brake, refer to the "Driving" section.

MONITORING

1

Warning lamp		is on	Cause	Action/Observations
	Engine coolant temperature	fixed blue.	On starting the engine, it indicates that the engine is cold.	After a few minutes driving, it switches off to indicate that the engine temperature is normal. In order to protect your engine, avoid driving too hard until the warning lamp has switched off.
ECO	Stop & Start	fixed.	When the vehicle stops (red lights, traffic jams, ...) the Stop & Start system has put the engine into STOP mode.	The warning lamp goes off and the engine restarts automatically in START mode, as soon as you want to move off.
		flashes for a few seconds, then goes off.	STOP mode is temporarily unavailable. or START mode is invoked automatically.	Refer to "Driving - § Stop & Start" for special cases with STOP mode and START mode.
	Passenger's airbag system	fixed.	The control switch, located in the glove box, is in the "ON" position. The passenger's front airbag is activated. In this case, do not install a rear-facing child seat.	Turn the control switch to the "OFF" position to deactivate the front passenger's airbag. In this case you can install a rear-facing child seat.

MONITORING

1

Warning lamp		is on	Cause	Action/Observations
	Foot on the brake pedal	fixed.	The brake pedal must be pressed.	<p>With an electronic gearbox, press the brake pedal to start the engine (lever in position N).</p> <p>With an automatic gearbox, with the engine running, press the brake pedal before releasing the parking brake, to unlock the lever and come out of position P.</p> <p>If you wish to release the parking brake without pressing the brake pedal, this warning lamp will remain on.</p>
		flashing.	With an electronic gearbox, if you hold the vehicle on an incline using the accelerator for too long, the clutch overheats.	Use the brake pedal and/or the parking brake.
	Automatic wiper	fixed.	The wiper control is pushed downwards.	Automatic front wiping is activated.

MONITORING

Deactivation indicator lamps

If one of the following indicator lamps comes on, this confirms that the corresponding system has been switched off intentionally. This may be accompanied by an audible signal and a message on the multifunction screen.

1

Warning lamp		is on	Cause	Action/Observations
	Passenger's airbag system	fixed.	The control, located in the glove box, is set to the OFF position. The passenger's front airbag is deactivated. In this case you can install a "rear facing" child seat.	Set the control to the ON position to activate the passenger's front airbag. In this case, do not fit a child seat in the rear-facing position.
	ESP/ASR	fixed.	The button, located at the bottom left of the dashboard, is pressed. Its indicator lamp is on. The ESP/ASR is deactivated. ESP: electronic stability programme. ASR: anti-slip regulation.	Press the button to activate the ESP/ASR. Its indicator lamp goes off. The ESP/ASR system is activated automatically when the vehicle is started. If deactivated, the system is reactivated automatically from around 30 mph (50 km/h).

MONITORING

Warning lamps

When the engine is running or the vehicle is being driven, the illumination of one of the following warning lamps indicates a fault which requires action on the part of the driver.



Any fault resulting in the illumination of a warning lamp must be investigated further by reading the associated message in the multifunction screen.

If you encounter any problems, do not hesitate to contact a CITROËN dealer or a qualified workshop.

Warning lamp		is on	Cause	Action/Observations
STOP	STOP	fixed, alone or associated with another warning lamp, accompanied by an audible signal and a message on the screen.	Illumination of the warning lamp is associated with a serious braking system or engine coolant temperature problem.	Stop as soon as it is safe to do so as the engine may cut out when driving. Park, switch off the ignition and call a CITROËN dealer or a qualified workshop.
		temporarily.	Minor problems have occurred for which there is no specific warning lamp.	Identify the problem by reading the message shown in the screen, such as, for example: <ul style="list-style-type: none"> - the engine oil level, - the screenwash level, - the remote control battery, - saturation of the particle emission filter on Diesel vehicles (see "Checks - § particle emissions filter"). For any other faults, contact a CITROËN dealer or a qualified workshop.
SERVICE	Service	temporarily.	Minor problems have occurred for which there is no specific warning lamp.	Identify the problem by reading the message shown in the screen, such as, for example: <ul style="list-style-type: none"> - the engine oil level, - the screenwash level, - the remote control battery, - saturation of the particle emission filter on Diesel vehicles (see "Checks - § particle emissions filter"). For any other faults, contact a CITROËN dealer or a qualified workshop.
		fixed.	Major problems have occurred for which there is no specific warning lamp.	Identify the problem by reading the message shown in the screen and contact a CITROËN dealer or a qualified workshop.

MONITORING

Warning lamp		is on	Cause	Action/Observations
 	Braking	fixed, associated with the STOP warning lamp.	The braking system fluid level is too low.	You must stop as soon as it is safe to do so. Top up with brake fluid recommended by CITROËN. If the problem persists, have the system checked by a CITROËN dealer or a qualified workshop.
		fixed, associated with the STOP and ABS warning lamp.	The electronic brake force distribution (EBFD) system has a fault.	You must stop as soon as it is safe to do so. Have it checked by a CITROËN or a qualified workshop.
	Anti-lock Braking System (ABS)	fixed.	The anti-lock braking system has a fault.	The vehicle retains conventional braking. Drive carefully at reduced speed and contact a CITROËN dealer or a qualified workshop without delay.
	Dynamic stability control (ESP/ASR)	flashing.	The ESP/ASR regulation is active.	The system optimises traction and improves the directional stability of the vehicle.
		fixed.	Unless it has been deactivated (button pressed and its indicator lamp on) the ESP/ASR system has a fault.	Have it checked by a CITROËN or a qualified workshop.
	Engine autodiagnosis system	flashing.	The engine management system has a fault.	Risk of destruction of the catalytic converter. Have it checked by a CITROËN dealer or a qualified workshop.
		fixed.	The emission control system has a fault.	The warning lamp should go off when the engine is started. If it does not go off, contact a CITROËN dealer or qualified workshop without delay.

MONITORING

1

Warning lamp		is on	Cause	Action/Observations
	Low fuel level	fixed.	When it first comes on there remains approximately 5 litres of fuel in the tank.	<p>You must refuel as soon as possible to avoid running out of fuel.</p> <p>This warning lamp will come on every time the ignition is switched on, until a sufficient addition of fuel is made.</p> <p>Fuel tank capacity: approximately 50 litres (petrol) or 46 litres (Diesel); depending on version: approximately 30 litres (petrol or Diesel).</p> <p>Never continue to drive until you run out of fuel as this could damage the emission control and injection systems.</p>
	Maximum coolant temperature	fixed red.	The temperature of the cooling system is too high.	<p>Stop as soon as it is safe to do so.</p> <p>Wait until the engine has cooled down before topping up the level, if necessary.</p> <p>If the problem persists, contact a CITROËN dealer or qualified workshop.</p>
	Engine oil pressure	fixed.	There is a fault with the engine lubrication system.	<p>You must stop as soon it is safe to do so.</p> <p>Park, switch off the ignition and contact a CITROËN dealer or a qualified workshop.</p>
	Battery charge	fixed.	The battery charging circuit has a fault (dirty or loose terminals, slack or cut alternator belt, ...).	<p>The warning lamp should go off when the engine is started.</p> <p>If it does not go off, contact a CITROËN dealer or a qualified workshop.</p>

MONITORING

1

Warning lamp		is on	Cause	Action/Observations
	Door(s) open	fixed if the speed is below 6 mph (10 km/h).	A door or the boot is still open.	Close the door or boot.
		fixed and accompanied by an audible signal if the speed is above 6 mph (10 km/h).		
	Airbags	temporarily.	This lamp comes on for a few seconds when you turn on the ignition, then goes off.	This lamp should go off when the engine is started. If it does not go off, contact a CITROËN dealer or a qualified workshop.
		fixed.	One of the airbag or seat belt pretensioner systems has a fault.	Have it checked by a CITROËN dealer or a qualified workshop.
	Seat belt not fastened/unfastened	fixed then flashing accompanied by an increasing audible signal.	The driver and/or the front passenger has not fastened or has unfastened their seat belt.	Pull the strap then insert the tongue in the buckle.

MONITORING

1

Warning lamp		is on	Cause	Action/Observations
	Power steering	fixed.	The power steering has a fault.	Drive carefully at reduced speed. Have it checked by a CITROËN dealer or a qualified workshop.
	Water in Diesel	fixed.	The Diesel fuel filter contains water.	Risk of damage to the injection system on Diesel engines. Contact a CITROËN dealer or a qualified workshop without delay.
	Particle emissions filter (Diesel)	fixed, accompanied by an audible signal.	This indicates that the particle emissions filter is starting to become saturated.	As soon as driving conditions allow, regenerate the filter by driving at a speed of at least 35 mph (60 km/h) until the warning lamp goes off (see the "Checks - Particle emissions filter" section).
		fixed, accompanied by an audible signal.	This indicates the low level of the additive reservoir.	Have the reservoir topped up as soon as possible by a CITROËN dealer or a qualified workshop (see the "Checks - Additive level" section).

MONITORING

Service indicator

System which informs the driver when the next service is due, in accordance with the manufacturer's servicing schedule.

The point at which the service is due is calculated from the last indicator zero reset. It is determined by two parameters:

- the distance travelled,
- the time elapsed since the last service.



More than 1 800 miles (3 000 km) remain before the next service is due

When the ignition is switched on, no service information appears in the screen.

Between 600 miles (1 000 km) and 1 800 miles (3 000 km) remain before the next service is due

For a few seconds after the ignition is switched on, the spanner symbolising the service operations comes on. The distance recorder display line indicates the distance remaining before the next service is due.

Example: 1 700 miles (2 800 km) remain before the next service is due.

For a few seconds after the ignition is switched on, the screen indicates:



A few seconds after the ignition is switched on, **the spanner goes off**; the distance recorder resumes its normal operation. The screen then indicates the total and trip distances.



Less than 600 miles (1 000 km) remain before the next service is due

Example: 560 miles (900 km) remain before the next service is due.

For a few seconds after the ignition is switched on, the display indicates:



A few seconds after the ignition is switched on, the distance recorder resumes its normal operation. **The spanner remains on** to indicate that a service must be carried out soon.



MONITORING

1

Service overdue

For a few seconds after the ignition is switched on, **the spanner flashes** to indicate that the service must be carried out as soon as possible.

Example: the service is overdue by 180 miles (300 km).

For a few seconds after the ignition is switched on, the display indicates:



A few seconds after the ignition is switched on, the distance recorder resumes its normal operation. **The spanner remains on.**



The distance remaining may be weighted by the time factor, depending on the driver's driving habits.

Therefore, the spanner may also come on if you have exceeded the two year service interval.

Service indicator zero reset



After each service, the service indicator must be reset to zero.

The procedure for resetting to zero is as follows:

- ☞ switch off the ignition,
- ☞ press and hold the trip distance recorder zero reset button,
- ☞ switch on the ignition; the distance recorder display begins a countdown,
- ☞ when the display indicates "**=0**", release the button; the spanner disappears.



Following this operation, if you wish to disconnect the battery, lock the vehicle and wait at least five minutes for the zero reset to be taken into account.

Retrieving the service information

You can access the service information at any time.

- ☞ Press the trip distance recorder zero reset button.

The service information is displayed for a few seconds, then disappears.

MONITORING

Engine oil level indicator

System which informs the driver whether the engine oil level is correct or not.



This information is indicated for a few seconds when the ignition is switched on, after the service information.



The level shown will only be correct if the vehicle is on level ground and the engine has been off for more than 30 minutes.

Oil level correct



Oil level low



This is indicated by the flashing of "OIL", linked with the service warning lamp, accompanied by an audible signal and a message in the multifunction screen.

If the low oil level is confirmed by a check using the dipstick, the level must be topped up to prevent damage to the engine.

Oil level indicator fault



This is indicated by the flashing of "OIL--". Contact a CITROËN dealer or a qualified workshop.

Dipstick

Refer to the "Checks" section to locate the dipstick and the oil filler cap on your engine.

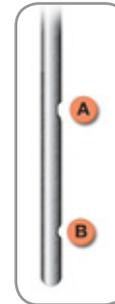

There are 2 marks on the dipstick:

- **A** = max; never exceed this level (risk of damage to the engine),
- **B** = min; top up the level via the oil filler cap, using the grade of oil suited to your engine.

1

MONITORING

Total distance recorder

1 System which measures the total distance travelled by the vehicle during its life.



The total and trip distances are displayed for thirty seconds when the ignition is switched off, when the driver's door is opened and when the vehicle is locked or unlocked.



To conform to legislation in the country you are crossing, change the units of distance (miles or km) via the configuration menu.

Trip distance recorder

System which measures a distance travelled during a day or other period since it was reset to zero by the driver.



With the ignition on, press the button until zeros appear.

Clock



Adjusting the time - Choice of units

To adjust the time of the clock and choose the units used by the screen, use the right-hand button on the instrument panel, carrying out the operations in the following order:

- press the button for more than two seconds: the minutes flash,
- press the button to increase the minutes,
- press the button for more than two seconds: the hours flash,
- press the button to increase the hours,
- press the button for more than two seconds: 24 H or 12 H is displayed,
- press the button to select 24 H or 12 H,
- press the button for more than two seconds: °C or °F is displayed,
- press the button to select °C or °F,
- press the button for more than two seconds to complete the adjustments.

After approximately 30 seconds without any action, the screen returns to the normal display.

MONITORING

Lighting dimmer

System for manual adjustment of the brightness of the instruments and controls in relation to the exterior brightness.



Activation

When the lighting is on:

- ☞ press the button to change the brightness of the instruments and controls,
- ☞ when the level of brightness required is reached, release the button.

Deactivation

When the lighting is off, or in day mode on vehicles fitted with daytime running lamps, pressing the button does not have any effect.

Black panel

System allowing certain displays to be switched off for night driving.

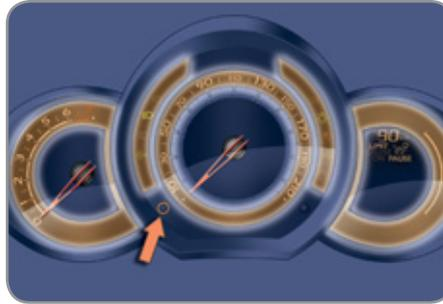

The instrument panel remains illuminated with only the vehicle speed and cruise control or speed limiter information, if in use.

If there is an alert or a change in a function or to a setting, the black panel mode is interrupted.

Activation

- ☞ With the lighting on, press the left hand button of the instrument panel several times to progressively reduce the dashboard lighting level.
- ☞ Press the button again to reduce the lighting to the minimum level and switch off the interior mood lighting.
- ☞ Press the button again to activate the black panel.

MONITORING

TRIP COMPUTER

1 System that gives you current information on your journey (range, fuel consumption...).

Screen in the instrument panel



Monochrome screen A



* Available only with the monochrome screen A.



Information displays

☞ Press the button, located at the end of the **wiper stalk**, to display the various items of trip computer information in succession.

The trip computer provides the following information:

- range,



- current fuel consumption,



- the Stop & Start time counter*,



- distance travelled,



- average fuel consumption,



- average speed.



☞ The next press then returns you to the normal display.

Zero reset



☞ Press the control for more than two seconds to reset to zero the distance travelled, the average fuel consumption and the average speed.

MONITORING

Monochrome screen C



16/9 colour screen (MyWay)



Information displays



☞ Press the button, located at the end of the **wiper stalk**, to display the various trip computer tabs in succession:



- the current information tab with:

- the range,
- the current fuel consumption,
- the distance remaining to be travelled or the Stop & Start time counter,



- the trip "1" tab with:

- the distance travelled,
- the average fuel consumption,
- the average speed, for the first trip.



- the trip "2" tab with:

- the distance travelled,
- the average fuel consumption,
- the average speed, for the second trip.

☞ Pressing the button again returns you to the normal display.

Trip zero reset



☞ When the trip required is displayed, press the button on the end of the wiper stalk for more than two seconds.

Trips "1" and "2" are independent but their use is identical.

For example, trip "1" can be used for daily figures, and trip "2" for monthly figures.

MONITORING

A few definitions...

1



Range

(miles or km)

This indicates the distance which can still be travelled with the fuel remaining in the tank in relation to the average fuel consumption over the last few miles (kilometres) travelled.



This value may vary following a change in the style of driving or the relief, resulting in a significant change in the current fuel consumption.

When the range falls below 20 miles (30 km), dashes are displayed. After filling with at least 5 litres of fuel, the range is recalculated and is displayed when it exceeds 60 miles (100 km).



If dashes are displayed continuously while driving in place of the digits, contact a CITROËN dealer or a qualified workshop.



Current fuel consumption

(mpg or l/100 km or km/l)

This is the average fuel consumption during the last few seconds.



This function is only displayed from 20 mph (30 km/h).



Average fuel consumption

(mpg or l/100 km or km/l)

This is the average fuel consumption since the last trip computer zero reset.



Average speed

(mph or km/h)

This is the average speed calculated since the last trip computer zero reset (ignition on).



Distance travelled

(miles or km)

This indicates the distance travelled since the last trip computer zero reset.



Distance remaining to destination

(miles or km)

This is the distance remaining to be travelled to the final destination. It can be entered by the user.

If the distance is not entered, dashes are displayed in place of the digits.



Stop & Start time counter

(minutes/seconds or hours/minutes)

If your vehicle is fitted with Stop & Start, a time counter calculates the time spent in STOP mode during a journey.

It resets to zero every time the ignition is switched on with the key.

MULTIFUNCTION SCREENS

MONOCHROME SCREEN A



Displays on the screen

This displays the following information:

- time,
- date,
- ambient temperature (this flashes if there is a risk of ice),
- status of the doors and boot,
- audio sources (radio, CD...),
- trip computer (refer to the "Instruments and Controls" section).

Warning messages (e.g.: "Emission control system faulty") or information messages (e.g.: "Boot open") may appear temporarily. These can be cleared by pressing the **"ESC"** button.

Controls



From the control panel of your Audio system, you can:

- ☞ press the **"MENU"** button to gain access to the **main menu**,
- ☞ press the **"▲"** or **"▼"** buttons to scroll through the items on the screen,
- ☞ press the **"MODE"** button to change the permanent application (date, audio source...),
- ☞ press the **"◀"** or **"▶"** buttons to change a setting value,
- ☞ press the **"OK"** button to confirm, or
- ☞ press the **"ESC"** button to abandon the operation in progress.

Main menu



☞ Press the **"MENU"** button to gain access to the **main menu**, then press the **"▲"** or **"▼"** buttons to scroll through the various menus:

- radio-CD,
- vehicle configuration,
- options,
- display settings,
- languages,
- units.

☞ Press the **"OK"** button to select the menu required.

Radio-CD

With the Audio system switched on, once the "Radio-CD" menu has been selected you can activate or deactivate the functions linked with use of the radio (RDS, REG), or the CD (introscan, shuffle, CD repeat).

For more information on the "Radio-CD" application, refer to the Audio system part of the "Audio and Telematics" section.

MULTIFUNCTION SCREENS

2



Vehicle configuration



Once the "Vehicle Configuration" menu has been selected, you can activate or deactivate the following equipment:

- wiper linked with reverse gear (refer to the "Visibility" section),
- guide-me-home lighting (refer to the "Visibility" section),
- parking sensors (refer to the "Driving" section).

Options

Once the "Options" menu has been selected, you can start diagnostics of the status of the equipment (active, not active, faulty).

Display settings

Once the "Display settings" menu has been selected, you can gain access to the following settings:

- year,
- month,
- day,
- hour,
- minutes,
- 12 or 24 hour mode.



☞ Once you have selected a setting, press the "◀" or "▶" buttons to change its value.



☞ Press the "▲" or "▼" buttons to switch respectively to the previous or next setting.

☞ Press the "OK" button to save the change and return to the normal display or press the "ESC" button to cancel.

Languages

Once the "Languages" menu has been selected, you can change the language used by the display (Français, Italiano, Nederlands, Portugues, Portugues-Brasil, Deutsch, English, Espanol).

Units

Once the "Units" menu has been selected, you can change the units of the following parameters:

- temperature (°C or °F),
- fuel consumption (l/100 km, mpg or km/l).



Once the fuel consumption units have been set to mpg, the information in the instrument panel screen on speed and distance will also be in mph and miles.



For safety reasons, configuration by the driver of the multifunction screen must only be done when stationary.

MULTIFUNCTION SCREENS

MONOCHROME SCREEN C



Displays on the screen

This displays the following information:

- time,
- date,
- ambient temperature (this flashes if there is a risk of ice),
- status of doors and boot,
- audio sources (radio, CD, USB port, jack socket etc.),
- trip computer (refer to the "Instruments and controls" section).

Warning messages (E.g. "Emissions control system faulty") or information messages (E.g.: "Automatic headlamps active") may appear temporarily. These can be cleared by pressing the **"ESC"** button.

Controls



From your Audio system control panel, you can:

- ☞ press the **"MENU"** button to gain access to the **main menu**,
- ☞ press the "**▲**" or "**▼**" buttons to scroll through the items on the screen,
- ☞ press the **"MODE"** button to change the permanent application (trip computer, audio source...),
- ☞ press the "**◀**" or "**▶**" buttons to change a setting value,
- ☞ press the **"OK"** button to confirm,
- or
- ☞ press the **"ESC"** button to abandon the operation in progress.

Main menu



- ☞ Press the **"MENU"** button to gain access to the **main menu**:
 - audio functions,
 - the trip computer,
 - personalisation-configuration,
 - telephone (hands-free kit).
- ☞ Press the "**▲**" or "**▼**" buttons to select the menu required, then confirm by pressing the **"OK"** button.



"Audio functions" menu

With the Audio system switched on, once this menu has been selected you can activate or deactivate the functions linked with use of the radio (RDS, REG, RadioText), the CD (intros can, shuffle, CD repeat) or the MP3 player (USB port/jack socket).

For more information on the "Audio functions" application, refer to the Audio system part of the "Audio and Telematics" section.

MULTIFUNCTION SCREENS

2



"Trip computer" menu

Once this menu has been selected, you can consult information concerning the status of the vehicle (warnings log, status of functions, etc.)

Alert log

This summarises the active warning messages, displaying them in succession on the multifunction screen.

Status of functions

This summarises the status (active or inactive) of the vehicle's functions.

Enter distance to destination

This allows you to enter an approximate distance until your final destination.

- Press the **"MENU"** button to gain access to the **general menu**.
- Press the arrows, then the **"OK"** button to select the **"Trip computer"** menu.



- In the **"Trip computer"** menu, select one of the following applications:

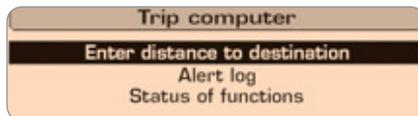

"Personalisation-Configuration" menu

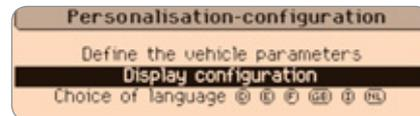

Once this menu has been selected, you can gain access to the following functions:

- define the vehicle parameters,
- display configuration,
- choice of language.

Define the vehicle parameters

Once this menu has been selected, you can activate or deactivate the following equipment:

- wiper linked to reverse gear (refer to the "Visibility" section),
- guide-me-home lighting and duration (see "Visibility" section),
- parking sensors (refer to the "Driving" section).

MULTIFUNCTION SCREENS



Example: setting of the duration of the guide-me-home lighting

Press the "▲" or "▼" buttons, then the "OK" button to select the menu required.

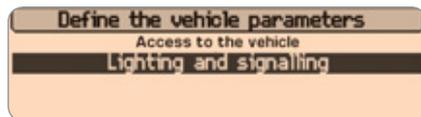

Press the "▲" or "▼" buttons, then the "OK" button to select the "Guide-me-home headlamps" line.

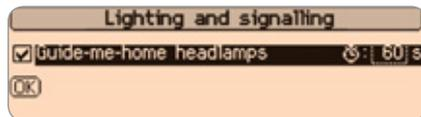

Press the "◀" or "▶" buttons to set the value required (15, 30 or 60 seconds), then press the "OK" button to confirm.

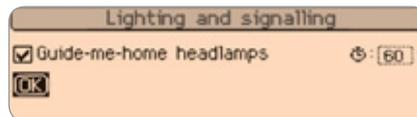

Press the "▲" or "▼" buttons, then the "OK" button to select the "OK" box and confirm or press the "ESC" button to cancel.

Display configuration

Once this menu has been selected, you can gain access to the following settings:

- brightness-video setting,
- date and time setting,
- selection of units.



Once the fuel consumption units have been changed to mpg, the information in the screen relating to speed and distance also changes to mph and miles respectively.

Choice of language

Once this menu has been selected, you can change the language used by the display (Deutsch, English, Espanol, Français, Italiano, Nederlands, Portugues, Portugues-Brasil, Türkçe*).



"Telephone" Menu

With Audio system on, once this menu is selected you can configure your Bluetooth hands-free system (pairing), view the various telephone directories (list of calls, services...) and manage your calls (call, hang up, second call, secret mode...).

For more information on the "Telephone" function, refer to the Audio system part of the "Audio and telematics" section.



For safety reasons, configuration by the driver of the multifunction screen must only be done when stationary.

* According to country of destination.

MULTIFUNCTION SCREENS

16/9 COLOUR SCREEN (MYWAY)

2



Displays on the screen

It displays the following information automatically and directly:

- time,
- date,
- altitude,
- ambient temperature (the value displayed flashes if there is a risk of ice),
- check of the doors,
- warning and vehicle function status messages, displayed temporarily,
- audio functions,
- trip computer information (see the "Monitoring" section),
- satellite navigation system information.

Controls



MyWay To select one of the applications, at the control panel:

- ☞ press the dedicated **"RADIO"**, **"MUSIC"**, **"NAV"**, **"TRAFFIC"**, **"SETUP"** or **"PHONE"** button for access to the corresponding menu,
- ☞ turn the dial to change the selection,
- ☞ press the dial to confirm the selection, or
- ☞ press the **"ESC"** button to abandon the current operation and return to the previous display.

For more information on these applications, refer to the "Audio and Telematics" section or to the specific user guide given to you with the other owner's documents.

"SETUP" menu



☞ Press the **"SETUP"** button to gain access to the **"SETUP"** menu. This allows you to select from the following functions:

- "System language",
- "Date and time",
- "Display",
- "Vehicle",
- "Units",
- "System".

MULTIFUNCTION SCREENS

System language

This menu allows you to select the language used by the display: Deutsch, English, Espanol, Français, Italiano, Nederlands, Polski, Portugues, Türkçe*.

Date and time

This menu allows you to set the date and time, the format of the date and the format of the time (refer to the "Audio and Telematics" section or to the specific user guide given to you with the other owner's documents).

Display

This menu allows you to set the brightness of the screen, the screen colour scheme and the colour of the map (day/night or auto mode).

Vehicle

This menu allows you to activate or deactivate certain driving and comfort equipment:

- wiper linked with reverse gear (refer to the "Visibility" section),
- guide-me-home lighting and duration (refer to the "Visibility" section),
- parking sensors (refer to the "Driving" section).

Units

This menu allows you to select the units: temperature (°C or °F) and fuel consumption (km/l, l/100 or mpg).

System

This menu allows you to restore the factory configuration, display the software version and activate scrolling text.



For safety reasons, configuration of the multifunction screen by the driver must only be done when stationary.

2

* According to country.

COMFORT



3

VENTILATION

Air intake

The air circulating in the passenger compartment is filtered and originates either from the outside via the grille located at the base of the windscreen or from the inside in air recirculation mode.

Air treatment

The incoming air follows various routes depending on the controls selected by the driver:

- direct arrival in the passenger compartment (air intake),
- passage through a heating circuit (heating),
- passage through a cooling circuit (air conditioning).

The temperature control enables you to obtain the level of comfort required by mixing the air of the various circuits.

The air distribution control enables you to diffuse the air in the passenger compartment combining several air vents.

The air flow control enables you to increase or reduce the speed of the ventilation blower.

Control panel

The controls of this system are grouped together on control panel **A** on the centre console. Depending on the model, the functions offered are:

- the level of comfort required,
- air flow,
- air distribution,
- demisting-defrosting,
- manual or digital air conditioning controls.

Air distribution

1. Windscreen demisting-defrosting vents.
2. Front side window demisting-defrosting vents.
3. Side adjustable air vents.
4. Central adjustable air vents.
5. Air outlets to the front footwells.
6. Air outlets to the rear footwells.

COMFORT



RECOMMENDATIONS FOR VENTILATION AND AIR CONDITIONING

In order for these systems to be fully effective, follow the operation and maintenance guidelines below:

- ☞ To obtain an even air distribution, take care not to obstruct the exterior air intake grilles located at the base of the windscreen, the nozzles, the vents and the air outlets, as well as the air extractor located in the boot.
- ☞ Do not cover the sunshine sensor, located on the dashboard; this is used for regulation of the digital air conditioning system.
- ☞ Operate the air conditioning system for at least 5 to 10 minutes, once or twice a month to keep it in perfect working order.
- ☞ Ensure that the passenger compartment filter is in good condition and have the filter elements replaced regularly (refer to the "Checks" section).
We recommend the use of a combined passenger compartment filter. Thanks to its special active additive, it contributes to the purification of the air breathed by the occupants and the cleanliness of the passenger compartment (reduction of allergic symptoms, bad odours and greasy deposits).
- ☞ To ensure correct operation of the air conditioning system, you are also advised to have it checked regularly as recommended in the servicing booklet.
- ☞ If the system does not produce cold air, switch it off and contact a CITROËN dealer or a qualified workshop.

When towing the maximum load on a steep gradient in high temperatures, switching off the air conditioning increases the available engine power and so improves the towing ability.



If after an extended stop in sunshine, the interior temperature is very high, first ventilate the passenger compartment for a few moments.

Put the air flow control at a setting high enough to quickly change the air in the passenger compartment.

The air conditioning system does not contain chlorine and does not present any danger to the ozone layer.

3



The condensation created by the air conditioning results in a discharge of water under the vehicle which is perfectly normal.

COMFORT

HEATING/VENTILATION

Manual control panel



Electric control panel



MANUAL AIR CONDITIONING

Manual control panel



Electric control panel



The heating/ventilation or air conditioning systems operates with the engine running, as well as in STOP mode with Stop & Start.

1. Temperature adjustment



☞ Turn the dial from blue (cold) to red (hot) to adjust the temperature to your requirements.

2. Air flow adjustment



☞ Turn the dial from position 1 to position 5 to obtain a comfortable air flow.



☞ If you place the air flow control in position 0 (deactivation of the system), the temperature is no longer maintained at a comfortable level. However, a slight flow of air, due to the movement of the vehicle, can still be felt.

COMFORT

3. Air distribution adjustment



Windscreen and side windows.



Windscreen, side windows and footwells.



Footwells.



Central and side vents.



The air distribution can be adapted by placing the dial in an intermediate position.

4. Air intake/Air recirculation

The intake of exterior air avoids the formation of mist on the windscreen and side windows.

The recirculation of interior air insulates the passenger compartment from exterior odours and smoke.

Return to exterior air intake as soon as possible to prevent deterioration of the air quality and the formation of mist.

Manual control panel



☞ Move the manual control to the left to be in the "recycling interior air" position.



☞ Move the manual control to the right to return to the "fresh air intake" position.

Electric control panel



☞ Press the button to recirculate the interior air. The indicator lamp comes on to confirm this.

☞ Press the button again to allow fresh air into the passenger compartment. The indicator lamp goes off to confirm this.

5. Air conditioning On/Off



The air conditioning is designed to operate effectively in all seasons, with the windows closed.

It enables you to:

- lower the temperature, in summer,
- increase the effectiveness of the demisting in winter, above 3 °C.

3

Switching on

☞ Press the "**A/C**" button, the button's indicator lamp comes on.



The air conditioning does not operate when the air flow adjustment control **2** is in position "**0**".

To obtain cooled air more quickly, you can use recirculation of interior air for a few moments. Then return to fresh air intake.

Switching off

☞ Press the "**A/C**" button again, the button's indicator lamp goes off.

Switching off may affect comfort levels (humidity, condensation).

FRONT DEMIST - DEFROST



These markings on the control panel indicate the control positions for rapid demisting or defrosting of the windscreen and side windows.

3

With the heating/ventilation system

- ☞ Put the temperature and air flow controls to the dedicated marked position.
- ☞ Put the air intake control to the "Exterior air intake" position (manual control to the right or electric control with indicator lamp off).
- ☞ Put the air distribution control to the "Windscreen" position.



With Stop & Start, when the demisting, air conditioning and air flow functions are activated, STOP mode is not available.

With the manual air conditioning system

- ☞ Put the temperature and air flow controls to the dedicated marked position.
- ☞ Put the air intake control to the "Exterior air intake" position (manual control to the right or electric control with indicator lamp off).
- ☞ Put the air distribution control to the "Windscreen" position.
- ☞ Switch on the air conditioning by pressing the "**A/C**" button; the associated green warning lamp comes on.

COMFORT

DIGITAL AIR CONDITIONING



The air conditioning operates when the engine is running, as well as in STOP mode with Stop & Start.

Automatic operation

1. Automatic "comfort" programme



Press the "AUTO" button. The "AUTO" symbol is displayed.

We recommend that you use this mode. It provides optimised automatic control of all of the following functions: passenger compartment temperature, air flow, air distribution and air intake, in accordance with the comfort value that you have chosen.

This system is designed to operate effectively in all seasons, with the windows closed.



For your comfort, when the engine is switched off, the settings are retained until the engine is switched on again.

To prevent too great a distribution of cold air when the engine is cold, the air flow will only reach its optimum level gradually.

2. Temperature adjustment

The value indicated on the display corresponds to a level of comfort and not to a temperature in degrees Celsius or Fahrenheit.



Press the "▲" and "▼" buttons to change this value. A setting around the value 21 enables optimum comfort to be obtained. However, depending on your requirements, a setting between 18 and 24 is usual.



On entering the vehicle, if the interior is very cold or hot, there is no need to change the value displayed in order to reach the required level of comfort. The system corrects the temperature difference automatically and as quickly as possible.

3. Automatic "visibility" programme



The automatic comfort programme may not be sufficient for rapid demisting or defrosting of the windscreen and side windows (humidity, several passengers, ice, etc.).

3

In this case, select the automatic visibility programme. The button 3 indicator lamp comes on.

The system automatically controls the air conditioning and the flow of air and provides optimum air distribution to the windscreen and side windows. It deactivates air recirculation 5.

To exit this programme, press button 3 again or "AUTO", the indicator lamp on the button goes off and "AUTO" is displayed.

Manual override

It is possible to adjust one or more functions manually while leaving the other functions in automatic mode.

The "AUTO" symbol switches off.

To return to automatic mode, press the "AUTO" button.



Switching to manual mode may not be suitable (temperature, humidity, odour, condensation) and does not provide optimum comfort.

COMFORT

3



For maximum cooling or heating of the cabin, it is possible to go beyond the minimum 14 or maximum 28 values.

Press the blue button **2** until **"LO"** is displayed or the red button **2** until **"HI"** is displayed.

4. Air conditioning on/off



Press this button to switch off the air conditioning.

Stopping the air conditioning may cause some problems (humidity, misting).

Automatic operation of the air conditioning is resumed when the button is pressed again. The symbol **"A/C"** is displayed.

5. Air intake/Air recirculation



Press this button for recirculation of the interior air. The air recirculation symbol **5** is displayed.

Air recirculation enables the passenger compartment to be isolated from exterior odours and smoke.

Press this button again or press the **"AUTO"** button to resume automatic management of the intake of air. The air recirculation symbol **5** goes off.



Avoid prolonged recirculation of interior air (risk of condensation or deterioration of the air quality).

6. Air distribution adjustment



Pressing this button several times in succession enables the air flow to be directed in turn towards:

- the windscreen and the side windows (demisting or defrosting),
- the windscreen, side windows and air vents,
- the windscreen, the side windows, the air vents and the footwells,
- the windscreen, the side windows and the footwells,
- the footwells,
- the air vents and the footwells,
- the air vents.

7. Air flow adjustment



Press the **"full fan"** button to increase the air flow.

The air flow symbol, the fan, fills progressively according to the value requested.



Press the **"empty fan"** button to decrease the air flow.

Switching the system off



Press the air flow **"empty fan"** button **7** until the fan symbol disappears.

This action switches off all of the functions of the air conditioning system.

Thermal comfort is no longer controlled. A slight flow of air resulting from the movement of the vehicle, remains perceptible however.

Pressing the air flow **"full fan"** button **7** or on **"AUTO"** reactivates the system with the values set before it was switched off.



Avoid driving for long periods with the air conditioning switched off (risk of misting and reduction of the air quality in the cabin).

REAR SCREEN DEMIST - DEFROST



The control button is located on the heating or air conditioning system control panel.

Switching on

The rear screen demisting/defrosting can only operate when the engine is running.

- ☞ Press this button to demist/defrost the rear screen and (depending on version) the door mirrors. The indicator lamp associated with the button comes on.

Switching off

The demisting/defrosting switches off automatically to prevent an excessive consumption of current.

- ☞ It is possible to stop the demisting/defrosting operation before it is switched off automatically by pressing the button again. The indicator lamp associated with the button switches off.



With Stop & Start, when demisting has been activated, the STOP mode is not available.



If the engine is switched off before the demisting/defrosting is switched off automatically, demisting/defrosting will resume next time the engine is switched on.



☞ Switch off the demisting/defrosting of the rear screen and door mirrors as soon as appropriate as lower current consumption results in reduced fuel consumption.

COMFORT

SCENTED AIR FRESHENER

System permitting the diffusion of a fragrance in the passenger compartment in accordance with your requirements, by means of the adjustment dial and the various fragrance cartridges available.

3



Adjustment dial

This dial is located on the dashboard. It allows you to adjust the intensity of diffusion of the fragrance.

- ☞ Turn the dial to the right to permit diffusion of the fragrance.
- ☞ Turn the dial to the left to stop diffusion of the fragrance.



Leave the central vents open. The intensity of diffusion of the fragrance may depend on the ventilation or air conditioning settings.

Fragrance cartridge

This cartridge can be removed easily. The first time it is used, replace the plug with a real cartridge.

You can change it at any time and store it in the sealed case which keeps it closed once it has been opened.

You can obtain different fragrance cartridges from a CITROËN dealer or a qualified workshop.



Do not discard the original cartridge as this serves as a plug when no fragrance cartridge is in use.

In order to preserve the service life of the cartridge, turn the dial fully to the left when you no longer wish to diffuse the fragrance in the passenger compartment.



As a safety precaution, do not carry out any action on the cartridge while driving.

Do not dismantle the cartridges. Do not attempt to refill the fragrance diffuser or the cartridges. Avoid all contact with the skin and eyes.

Keep out of reach of children and animals.

Removing the cartridge

- ☞ Press the dial and turn it a quarter of a turn anti-clockwise.
- ☞ Remove the cartridge.
- ☞ Refit its sealing case.

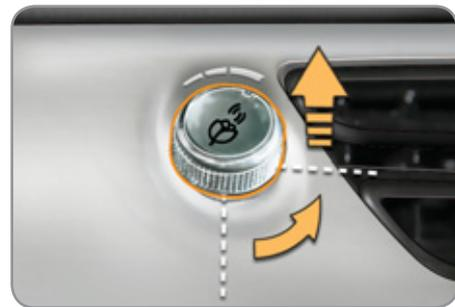

Fitting the cartridge

- ☞ Remove the cartridge from the sealing case.
- ☞ Install the cartridge (flower at top left).
- ☞ Press the dial and turn it a quarter of a turn clockwise.

COMFORT

FRONT SEATS

Seat consisting of a seat cushion, a seat back and a head restraint which can all be adjusted to adapt your position for ease of driving and comfort.

Manual adjustments

Forwards-backwards adjustment

- ☞ Raise the control and slide the seat forwards or backwards.

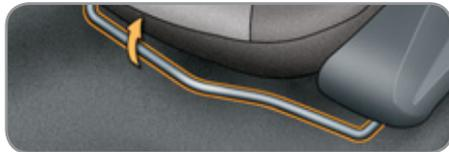

Driver's or passenger's seat height adjustment

- ☞ Pull the control upwards to raise or push it downwards to lower, as many times as necessary, to obtain the position required.



Seat back angle adjustment

- ☞ Push the control rearwards.



COMFORT

Additional adjustments

Head restraint height adjustment

- ☞ To raise the head restraint, pull it forwards and upwards at the same time.
- ☞ To remove the head restraint, press the lug **A** and pull the head restraint upwards.
- ☞ To put the head restraint back in place, engage the head restraint stems in the openings keeping them in line with the seat back.
- ☞ To lower the head restraint, press the lug **A** and the head restraint at the same time.

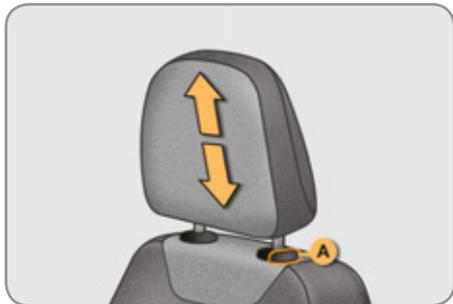

The head restraint is fitted with a frame with notches which prevents it from lowering; this is a safety device in case of impact.

The adjustment is correct when the upper edge of the head restraint is level with the top of the head.

Never drive with the head restraints removed; they must be in place and adjusted correctly.

Heated seats control

With the engine running, the front seats can be heated separately.

- ☞ Use the adjustment dial, placed on the side of each front seat, to switch on and select the level of heating required:

0: Off.

1: Low.

2: Medium.

3: High.

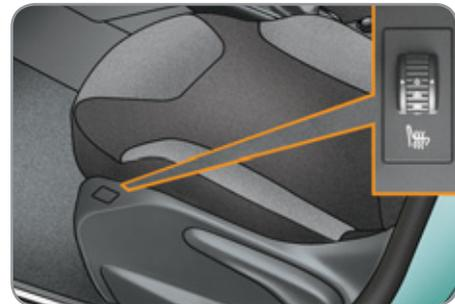

COMFORT

REAR SEATS

Bench seat with fixed one-piece cushion and split backrest (left hand 2/3, right hand 1/3) which can be folded individually to adapt the load space in the boot.

Rear head restraints

These have one position for use (up) and a stowed position (down).

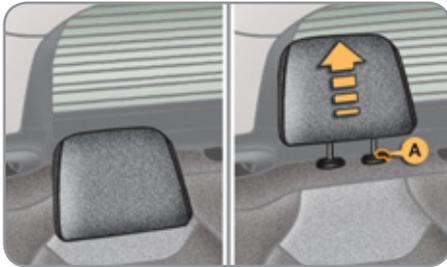

They can also be removed.

To remove a head restraint:

- ☞ release the backrest using control 1,
- ☞ tilt the backrest 2 slightly forwards,
- ☞ pull the head restraint upwards to the stop,
- ☞ then, press the lug A.



Never drive with the head restraints removed; they must be in place and correctly adjusted.

Folding the backrest

- ☞ Move the corresponding front seat forward if necessary.
- ☞ Check that the seat belt is positioned correctly on the side of the seat backrest.
- ☞ Place the head restraints in the low position.



- ☞ Pull control 1 forwards to release the seat backrest 2.
- ☞ Fold the seat backrest 2 on to the cushion.

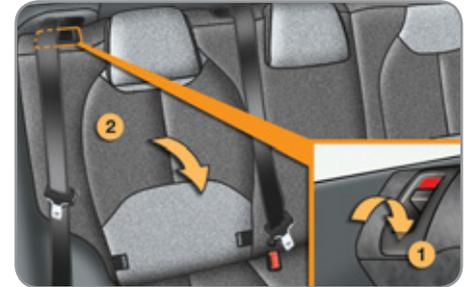

Repositioning the seat backrest

- ☞ Straighten the seat backrest 2 and secure it.
- ☞ Check that the red indicator, located next to the control 1, is no longer visible.



When repositioning the seat backrest, take care not to trap the seat belts.

COMFORT

MIRRORS



Door mirrors

Each fitted with an adjustable mirror glass permitting the lateral rearward vision necessary for overtaking or parking. They can also be folded for parking in confined spaces.

Demisting - Defrosting

If your vehicle is fitted with heated mirrors, the demisting-defrosting operates with the engine running, by switching on the heated rear screen (refer to the "Rear screen demist-defrost" page).

Adjustment



- ☞ Move control **A** to the right or to the left to select the corresponding mirror.
- ☞ Move control **B** in all four directions to adjust.
- ☞ Return control **A** to the central position.



The objects observed are, in reality, closer than they appear. Take this into account in order to correctly judge the distance of vehicles approaching from behind.

Folding

- ☞ From outside: lock the vehicle using the remote control or the key.
- ☞ From inside: with the ignition on, pull the control **A** in the central position downwards.



If the mirrors are folded using control **A**, they will not unfold when the vehicle is unlocked. Pull again on control **A**.

Unfolding

- ☞ From outside: unlock the vehicle using the remote control or the key.
- ☞ From inside: with the ignition on, with the control **A** in the central position, pull it downwards.



The folding and unfolding of the door mirrors using the remote control can be deactivated by a CITROËN dealer or a qualified workshop.

Never fold or unfold the electric folding mirrors manually.

Rear view mirror

Adjustable mirror providing a central rearward view.

Equipped with an anti-dazzle system, which darkens the mirror glass: this reduces the nuisance to the driver caused by the headlamps from following vehicles, low sun...

Manual day/night model



Adjustment

- ☞ Adjust the mirror so that the glass is directed correctly in the "day" position.

Day/night position

- ☞ Pull the lever to change to the "night" anti-dazzle position.
- ☞ Push the lever to change to the normal "day" position.



As a safety measure, the mirrors should be adjusted to reduce the "blind spot".

Automatic day/night model



By means of a sensor, which measures the light from the rear of the vehicle, this system automatically and progressively changes between the day and night uses.



In order to ensure optimum visibility during your manoeuvres, the mirror lightens automatically when reverse gear is engaged.

STEERING WHEEL ADJUSTMENT

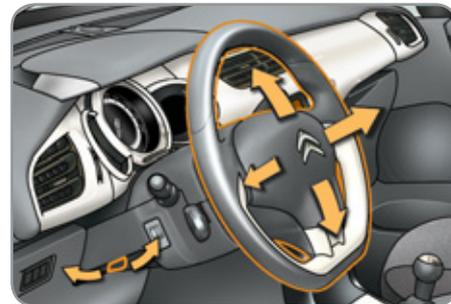

3

- ☞ **When stationary**, pull the control lever to release the adjustment mechanism.
- ☞ Adjust the height and reach to suit your driving position.
- ☞ Push the control lever to lock the adjustment mechanism.



As a safety precaution, these operations should only be carried out while the vehicle is stationary.

ACCESS

REMOTE CONTROL KEY

System which permits central unlocking or locking of the vehicle using the lock or from a distance. It is also used to locate and start the vehicle, as well as providing protection against theft.



Unlocking the vehicle

Unfolding the key

☞ First press this button to unfold the key.

Unlocking using the remote control



☞ Press the open padlock to unlock the vehicle.

Unlocking using the key

☞ Turn the key to the left in the driver's door lock to unlock the vehicle.

Unlocking is confirmed by rapid flashing of the direction indicators for approximately two seconds.

According to version, the door mirrors unfold at the same time.

Locking the vehicle

Locking using the remote control



☞ Press the closed padlock to lock the vehicle.

Locking using the key

☞ Turn the key to the right in the driver's door lock to lock the vehicle completely.

Locking is confirmed by fixed lighting of the direction indicators for approximately two seconds.

According to version, the door mirrors fold at the same time.



If one of the doors or the boot is still open, the central locking does not take place.

When the vehicle is locked, if it is unlocked inadvertently, it will relock automatically after thirty seconds unless a door or the boot is open.



The folding and unfolding of the door mirrors using the remote control can be deactivated by a CITROËN dealer or a qualified workshop.



Folding the key

☞ First press this button to fold the key.

If you do not press the button when folding the key, there is a risk of damage to the mechanism.

Locating your vehicle



- ☞ Press the closed padlock to locate your locked vehicle in a car park.

This is indicated by lighting of the courtesy lamps and flashing of the direction indicators for a few seconds.

Anti-theft protection

Electronic engine immobiliser

The key contains an electronic chip which has a special code. When the ignition is switched on, this code must be recognised in order for starting to be possible.

This electronic engine immobiliser locks the engine management system a few minutes after the ignition is switched off and prevents starting of the engine by anyone who does not have the key.

SERVICE

In the event of a fault, you are informed by illumination of this warning lamp,

an audible signal and a message in the screen.

In this case, your vehicle will not start; contact a CITROËN dealer as soon as possible.

Keep safely the label attached to the keys given to you on acquisition of the vehicle.

Ignition switch

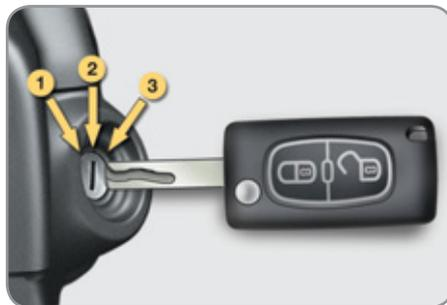

- Position 1: **Stop**
- Position 2: **Ignition**
- Position 3: **Starting**

Starting the vehicle

- ☞ Insert the key in the ignition switch. The system recognises the starting code.
- ☞ Turn the key fully towards the dashboard to position **3 (Starting)**.
- ☞ When the engine starts, release the key.

Switching the vehicle off

- ☞ Immobilise the vehicle.
- ☞ Turn the key fully towards you to position **1 (Stop)**.
- ☞ Remove the key from the ignition switch.



Do not attach any heavy objects to the key as this could weigh down on it when in the ignition switch and cause a fault.



Key reminder

If the key is left in the ignition switch, an audible signal sounds when the driver's door is opened.

Remote control problem

Following disconnection of the vehicle battery, replacement of the remote control battery or in the event of a remote control malfunction, you can no longer unlock, lock or locate your vehicle.

- ☞ First of all, use the key in the lock to unlock or lock your vehicle.
- ☞ Then, reinitialise the remote control.

4 If the problem persists, contact a CITROËN dealer as soon as possible.

Reinitialisation

- ☞ Switch off the ignition.
- ☞ Turn the key to position **2 (Ignition on)**.
- ☞ Press the closed padlock immediately for a few seconds.
- ☞ Switch off the ignition and remove the key from the ignition switch.

The remote control is fully operational again.

Changing the battery



Battery ref.: CR1620/3 volts.

SERVICE If the battery is flat, you are informed by illumination of this warning lamp, an audible signal and a message in the multi-function screen.

- ☞ Unclip the casing using a coin at the notch.
- ☞ Slide the flat battery out of its location.
- ☞ Slide the new battery into its location observing the original direction.
- ☞ Clip the casing.
- ☞ Reinitialise the remote control.



Lost keys

Visit a CITROËN dealer with the vehicle's registration document, your personal identification documents and if possible the key code label.

The CITROËN dealer will be able to find the key code and the transponder code required to order a new key.

Remote control

The high frequency remote control is a sensitive system; do not operate it while it is in your pocket as there is a possibility that it may unlock the vehicle, without you being aware of it.

Do not repeatedly press the buttons of your remote control out of range and out of sight of your vehicle. You run the risk of stopping it from working and the remote control would have to be reinitialised.

The remote control does not operate when the key is in the ignition switch, even when the ignition is switched off, except for reinitialisation.

Locking the vehicle

Driving with the doors locked may make access to the passenger compartment by the emergency services more difficult in an emergency.

As a safety precaution (with children on board), remove the key from the ignition switch when you leave the vehicle, even for a short time.

Anti-theft protection

Do not make any modifications to the electronic engine immobiliser system; this could cause malfunctions.

When purchasing a second-hand vehicle

Have the pairing of all of the keys in your possession checked by a CITROËN dealer, to ensure that only your keys can be used to open and start the vehicle.



Do not throw the remote control batteries away, they contain metals which are harmful to the environment.

Take them to an approved collection point.

WINDOW CONTROLS

System which opens or closes a window manually or automatically. It is fitted with a system which provides protection if an obstacle is detected on the one-touch models and a deactivation system to prevent misuse of the rear switches on all models.

4



1. Driver's electric window switch.
2. Passenger's electric window switch.
3. Rear right electric window switch.
4. Rear left electric window switch.
5. Deactivating the rear electric window and door switches.



The electric window switches remain operational for approximately 45 seconds after the ignition is switched off or until a front door is opened.

During this period of 45 seconds, if you open a door while opening a window, the window stops. The ignition must then be switched on again to operate the windows.

Electric windows



- ☞ Press or pull the switch. The window stops as soon as the switch is released.

One-touch electric windows



- ☞ There are two methods of operation:



- **manual mode**
 - ☞ Press or pull the switch gently. The window stops as soon as the switch is released.
- **automatic mode**
 - ☞ Press or pull the switch fully. The window opens or closes completely when the switch is released.
 - ☞ Pressing the switch again stops the movement of the window.

Safety anti-pinch

The one-touch front electric windows are fitted with a safety anti-pinch function.

When the window rises and meets an obstacle, it stops and partially lowers again.



In the event of unwanted opening of the window on closing (for example in the presence of frost):

- ☞ press the switch beyond the point of resistance and then release it: the window opens completely,
- ☞ then pull it immediately without passing the point of resistance until the window closes completely,
- ☞ continue to hold the switch for approximately one second after the window has closed.

The safety anti-pinch function is not active during these operations.

Deactivating the rear window and door switches



- ☞ For the safety of your children, press switch **5** to prevent operation of the rear windows irrespective of their position.

With the lamp on, the rear controls are deactivated.

With the lamp off, the rear controls are activated.



This control also deactivates the interior rear door controls (see "Child safety - § Electric child lock").

Reinitialisation

In the event of a malfunction you have to reinitialise the operation of the electric windows:

- ☞ release the switch and pull it again until the window closes completely,
- ☞ hold the switch for approximately one second after closing,
- ☞ press the switch to lower the window automatically.

The safety anti-pinch function is not active during these operations.



Always remove the key from the ignition when leaving the vehicle, even for a short time.

In the event of contact during operation of the windows, reverse the movement of the window. To do this, press the switch concerned.

When the driver operates the passenger electric window switches, they should ensure that no one is preventing correct closing of the windows.

The driver should ensure that passengers use the electric windows correctly.

Be aware of children when operating the windows.

ACCESS

DOORS

Opening

From outside

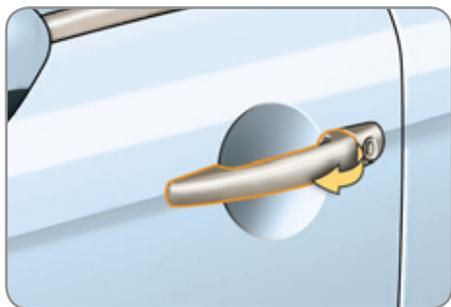

- ☞ After unlocking the vehicle using the remote control or the key, pull the door handle.

From inside

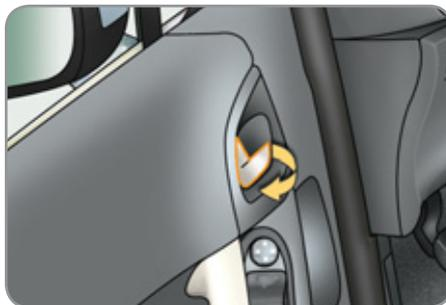

- ☞ Pull the front door control to open the door; this unlocks the vehicle completely.
- ☞ Pull the rear door control to open the door; this unlocks only the door opened.

Closing

When a door is not closed correctly:



- **when the engine is running**, this warning lamp comes on, accompanied by a message in the multifunction screen for a few seconds,
- **when the vehicle is moving** (speed higher than 6 mph (10 km/h)), this warning lamp comes on, accompanied by an audible signal and a message in the multifunction screen for a few seconds.

ACCESS

Manual centralised control

System which provides full manual locking or unlocking of the doors from the inside.



Locking

Press button **A** to lock the vehicle.

The red indicator lamp on the button comes on.



If one of the doors is open, central locking from the inside does not take place.

Unlocking

Press button **A** again to unlock the vehicle.

The red indicator lamp on the button switches off.



If the vehicle is locked from the outside, the red indicator lamp flashes and button **A** is inactive.

In this case, use the remote control or the key to unlock the vehicle.

Automatic centralised control

System which provides full automatic locking or unlocking of the doors and the boot while driving.

You can activate or deactivate this function.

Locking

When the speed exceeds 6 mph (10 km/h), the doors and the boot lock automatically.



If one of the doors is open, the automatic central locking does not take place.

If the boot is open, the automatic central locking of the doors is active.

Unlocking

Above 6 mph (10 km/h), press button **A** to unlock the doors and the boot temporarily.

Activation



Press button **A** for more than two seconds.

A confirmation message appears on the multifunction screen, accompanied by an audible signal.

Deactivation

Press button **A** again for more than two seconds.

A confirmation message appears on the multifunction screen, accompanied by an audible signal.

ACCESS

Emergency control

System allowing the doors to be locked and unlocked manually in the event of a fault with the central locking system or a battery failure.



In the event of failure of the central locking system, the battery must be disconnected to lock the boot and so ensure that the vehicle is locked completely.

4

Locking the driver's door

☞ Insert the key in the lock, then turn it to the right.

Unlocking the driver's door

☞ Insert the key in the lock, then turn it to the left.

Locking the front and rear passenger doors



Check that the rear doors child lock is not on.

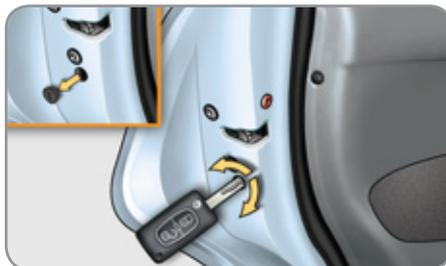

- ☞ Remove the black cap, located on the edge of the door, using the key.
- ☞ Insert the key in the socket, then turn it to the stop.
- ☞ Remove the key and refit the cap.

Unlocking the front and rear passenger doors

☞ Pull the interior door opening control.

ACCESS

BOOT

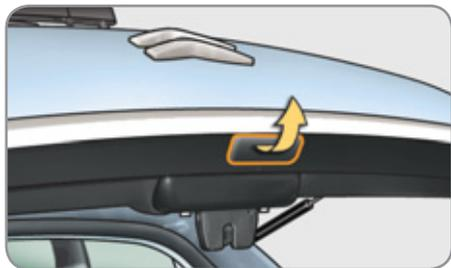

Opening

- ☞ After unlocking the vehicle using the remote control or the key, pull the handle and raise the tailgate.

Closing

- ☞ Lower the tailgate using the interior grab handle.

If the tailgate is not closed correctly:



- **when the engine is running**, this warning lamp comes on, accompanied by a message on the multifunction screen for a few seconds,
- **when the vehicle is moving** (speed above 6 mph (10 km/h)), this warning lamp comes on, accompanied by an audible signal and a message on the multifunction screen for a few seconds.

Tailgate release

System for mechanical unlocking of the boot in the event of a battery or central locking malfunction.



4

Unlocking

- ☞ Fold back the rear benchseat to gain access to the lock from inside the boot.
- ☞ Insert a small screwdriver into hole **A** of the lock to unlock the tailgate.

ACCESS

FUEL TANK

Fuel tank capacity: approximately 50 litres (petrol) or 46 litres (Diesel); (Depending on version: approximately 30 litres (petrol or Diesel)).

Low fuel level



When the fuel tank minimum level is reached this warning lamp comes on on the instrument panel. When it first comes

on there remains **approximately 5 litres** of fuel in the tank.

You must refuel as soon as possible to avoid running out of fuel.

If you run out of fuel (Diesel), refer also to the "Checks" section.

Filling

A label affixed to the inside of the flap reminds you of the type of fuel to be used depending on your engine.

Additions of fuel must be of at least 5 litres, in order to be registered by the fuel gauge.



With Stop & Start, never refuel with the system in STOP mode; you must switch off the ignition with the key.

To fill the tank safely:

- ☞ **the engine must be switched off,**
- ☞ open the fuel filler flap,
- ☞ insert the key in the cap, then turn it to the left,

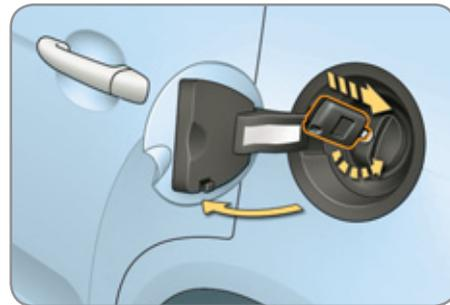

- ☞ remove the cap and hook it onto the clip located on the inside of the flap,
- ☞ fill the tank, **but do not continue after the 3rd cut-off of the pump;** this could cause malfunctions.

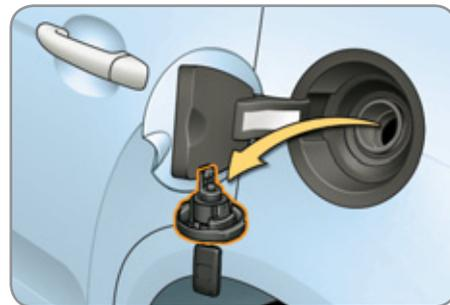

When you have filled the tank:

- ☞ put the cap back in place,
- ☞ turn the key to the right, then remove it from the cap,
- ☞ close the flap.



The key cannot be removed from the lock until the cap is refitted.

Opening the filler cap may create a noise caused by an inrush of air. This vacuum is entirely normal, resulting from the sealing of the fuel system.

Quality of the fuel used for petrol engines

The petrol engines are perfectly compatible with E10 or E24 type petrol biofuels (containing 10 % or 24 % ethanol), conforming to European standards EN 228 and EN 15376.

E85 type fuels (containing up to 85 % ethanol) are reserved exclusively for vehicles marketed for the use of this type of fuel (BioFlex vehicles). The quality of the ethanol must comply with European standard EN 15293.

For Brazil only, special vehicles are marketed to run on fuels containing up to 100 % ethanol (E100 type).

Quality of the fuel used for Diesel engines

The Diesel engines are perfectly compatible with biofuels which conform to current and future European standards (Diesel fuel which complies with standard EN 590 mixed with a biofuel which complies with standard EN 14214) available at the pumps (containing up to 7 % Fatty Acid Methyl Ester).

The B30 biofuel can be used in certain Diesel engines; however, this use is subject to strict application of the special servicing conditions. Contact a CITROËN dealer or a qualified workshop.

The use of any other type of (bio)fuel (vegetable or animal oils, pure or diluted, domestic fuel...) is strictly prohibited (risk of damage to the engine and fuel system).

MISFUEL PREVENTION (DIESEL)*

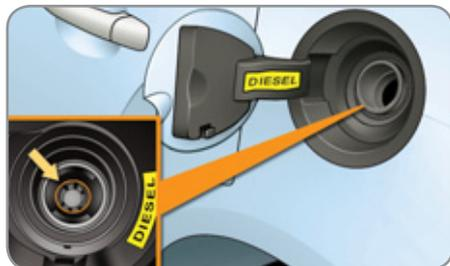

Mechanical device which prevents filling the tank of a Diesel vehicle with petrol. It avoids the risk of engine damage that can result from filling with the wrong fuel.

Located in the filler neck, the misfuel prevention device appears when the filler cap is removed.

Operation

When a petrol filler nozzle is introduced into the fuel filler neck of your Diesel vehicle, it comes into contact with the flap. The system remains closed and prevents filling.

Do not persist but introduce a Diesel type filler nozzle.



It remains possible to use a fuel can to fill the tank.

In order to ensure a good flow of fuel, do not place the nozzle of the fuel can in direct contact with the flap of the misfuel prevention device and pour slowly.



Travelling abroad

As Diesel fuel pump nozzles may be different in other countries, the presence of the misfuel prevention device may make refuelling impossible.

Before travelling abroad, we recommend that you check with the CITROËN dealer network, whether your vehicle is suitable for the fuel pumps in the country in which you want to travel.

Deactivation

Before refuelling using non-standard Diesel fuel nozzles (present in some countries), a tool allows you to temporarily disable the misfuel prevention device.

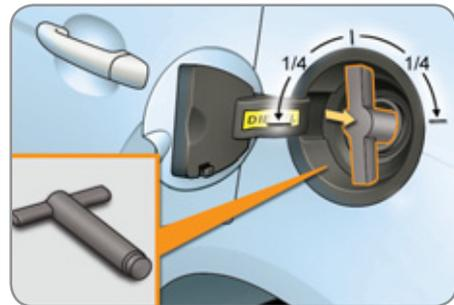

Use

- ☞ With the **handle vertical**, introduce the tool into the filler neck as far as it will go.
- ☞ Turn the tool a quarter turn to the right or left.
- ☞ Remove the tool completely.
- ☞ Fill with fuel.



The misfuel prevention device will be activated the next time a standard nozzle is used.

This tool will become available during the year.

* According to country of sale.

VISIBILITY

LIGHTING CONTROLS

System for selection and control of the various front and rear lamps providing the vehicle's lighting.

Main lighting

The various front and rear lamps of the vehicle are designed to adapt the driver's visibility progressively according to climatic conditions:

- sidelamps, to be seen,
- dipped beam headlamps to see without dazzling other drivers,
- main beam headlamps to see clearly when the road is clear.

Additional lighting

Other lamps are installed to fulfil the requirements of particular conditions of visibility:

- a rear foglamp to be seen from afar,
- front foglamps for even better forward vision.

Programming

Various automatic lighting control modes are also available according to the following options:

- guide-me-home lighting,
- automatic illumination of headlamps.

Manual controls

The lighting is controlled directly by the driver by means of the ring **A** and the stalk **B**.

Model without AUTO lighting



Model with AUTO lighting



- A.** Main lighting mode selection ring: turn it to position the symbol required facing the mark.

O Lamps off.

AUTO Automatic illumination of headlamps.

 Sidelamps only.

 Dipped or main beam headlamps.

- B.** Stalk for switching the headlamp beam: pull the stalk to switch between dipped and main beam headlamps.

In the lamps off and sidelamps modes, the driver can switch on the main beam headlamps temporarily ("headlamp flash") by maintaining a pull on the stalk.

Displays

Lighting of the corresponding indicator lamp on the instrument panel confirms the switching on of the lighting selected.

Depending on version, the instrument panel may have permanent back-lighting. Illumination of the instrument panel is therefore not linked to the exterior lighting.

VISIBILITY

Model with rear foglamp only

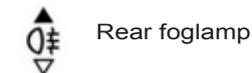

Rear foglamp

- ☞ To switch on the foglamp, turn the ring **C** forwards.

When the lighting is switched off automatically (with AUTO model), the foglamp and the dipped beam headlamps will remain on.

- ☞ To switch off all of the lighting, turn the ring **C** rearwards.

Model with front foglamps and a rear foglamp



Front and rear foglamps

Rotate and release the ring **C**:

- ☞ forwards a first time to switch on the front foglamps,
- ☞ forwards a second time to switch on the rear foglamp,
- ☞ rearwards a first time to switch off the rear foglamp,
- ☞ rearwards a second time to switch off the front fog lamps.

When the lighting is switched off automatically (with AUTO model) or when the dipped headlamps are switched off manually, the foglamps and sidelamps will remain on.

- ☞ Turn the ring rearwards to switch off the foglamps, the sidelamps will then switch off.



In good or rainy weather, by both day and night, the front foglamps and the rear foglamp are prohibited. In these situations, the power of their beams may dazzle other drivers.

Do not forget to switch off the front foglamps and the rear foglamp when they are no longer necessary.



Lighting on audible warning

When the ignition is switched off, all of the lamps switch off automatically, unless guide-me-home lighting is activated.

If the lighting is switched on manually after switching off the ignition, there is an audible signal when a front door is opened to warn the driver that they have forgotten to switch off the vehicle's lighting, with the ignition off.

VISIBILITY



In some weather conditions (e.g. low temperature or humidity), the presence of misting on the internal surface of the glass of the headlamps and rear lamps is normal; it disappears after the lamps have been on for a few minutes.

Daytime running lamps*

On vehicles fitted with daytime running lamps, the dipped beams come on when the vehicle is started.



This warning lamp comes on in the instrument panel.

The instruments and controls (instrument panel, multifunction screen, air conditioning control panel, etc.) are not illuminated, except on switching to the automatic lighting mode or when the lighting is switched on manually.

This function can be activated/deactivated by a CITROËN dealer or a qualified workshop.

* According to country.

Manual guide-me-home lighting

Temporarily keeping the dipped beam headlamps on after the vehicle's ignition has been switched off makes the driver's exit easier when the light is poor.

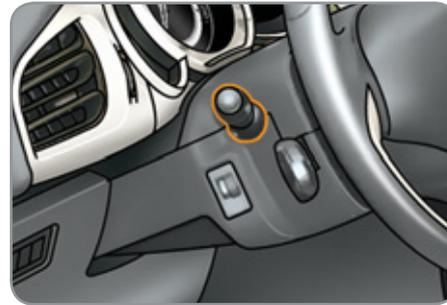

Switching on

- ☞ With the ignition off, "flash" the headlamps using the lighting stalk.
- ☞ A further "headlamp flash" switches the function off.

Switching off

The manual guide-me-home lighting switches off automatically after a set time.

Automatic illumination of headlamps

The sidelamps and dipped beam headlamps are switched on automatically, without any action on the part of the driver, when a low level of external light is detected or in certain cases of activation of the windscreen wipers.

As soon as the brightness returns to a sufficient level or after the windscreen wipers are switched off, the lamps are switched off automatically.



Activation

- ☞ Turn ring to the **"AUTO"** position. The automatic illumination of headlamps is accompanied by a message in the screen.

Deactivation

- ☞ Turn ring to a position other than **"AUTO"**. Deactivation is accompanied by a message in the screen.

VISIBILITY

Association with the automatic "Guide-me-home" lighting

Association with the automatic illumination of headlamps provides "guide-me-home" lighting with the following additional options:

- selection of the lighting duration to 15, 30 or 60 seconds in the functions that can be set in the vehicle configuration menu (except in the case of the monochrome screen A, for which the duration is set: 60 seconds),
- automatic activation of "guide-me-home" lighting when automatic illumination of headlamps is in operation.

5

Operating fault

SERVICE In the event of a fault with the sunshine sensor, the lighting come on, this warning lamp is displayed in the instrument panel and/or a message appears in the screen, accompanied by an audible signal.

Contact a CITROËN dealer or a qualified workshop.



In fog or snow, the sunshine sensor may detect sufficient light. Therefore, the lighting will not come on automatically.

Do not cover the sunshine sensor, coupled with the rain sensor and located in the centre of the windscreen behind the rear view mirror; the associated functions would no longer be controlled.

HEADLAMP ADJUSTMENT



To avoid causing a nuisance to other road users, the height of the headlamps should be adjusted in relation to the load in the vehicle.

0. Driver only or driver + front passenger.
 - Intermediate setting
1. 5 people.
 - 5 people + load in the boot.
2. Driver only + maximum authorised load in the boot.

This position is sufficient to avoid causing dazzle.

Higher settings may limit the spread of light from the headlamps.



The initial setting is position "0".

VISIBILITY

WIPER CONTROLS

System for selection and control of the various front and rear wiping modes for the elimination of rain and cleaning.

The vehicle's front and rear wipers are designed to improve the driver's visibility progressively according to the climatic conditions.

Programming

Various automatic wiper control modes are also available according to the following options:

- automatic rain sensitive windscreen wipers,
- rear wiping on engaging reverse gear.

Model with intermittent wiping



Model with AUTO wiping



Manual controls

The wiper commands are issued directly by the driver by means of the stalk **A** and the ring **B**.

Windscreen wipers

A. Wiping speed selection stalk:

- 2** fast (heavy rain),
- 1** normal (moderate rain),
- I** intermittent (proportional to the speed of the vehicle),
- 0** park,
- ↓** single wipe (press down and release),
- or
- AUTO ↓** automatic, then single wipe (see following page).

VISIBILITY

Rear wiper



5

B. Rear wiper selection ring:

-  park,
-  intermittent wipe,
-  wash-wipe (set duration).

Windscreen wash

Pull the wiper stalk towards you. The windscreen wash, then the windscreen wipers, operate for a pre-determined time.

Reverse gear

When reverse gear is engaged, the rear wiper will come into operation if the windscreen wipers are operating.

Programming

The function is activated or deactivated via the vehicle configuration menu.

This function is activated by default.



If a significant accumulation of snow or ice is present, or when using a tailgate bicycle carrier, deactivate the automatic rear wiper via the multifunction screen configuration menu.

VISIBILITY

Automatic rain sensitive windscreen wipers

The windscreen wipers operate automatically, without any action on the part of the driver, if rain is detected (sensor behind the rear view mirror), adapting their speed to the intensity of the rainfall.

Activation



This is controlled manually by the driver by pushing stalk **A** to the "AUTO" position.



It is accompanied by the illumination of this indicator lamp in the instrument panel and a message in the multifunction screen.

Switching off



This is controlled manually by the driver by moving stalk **A** upwards, returning it to position "0".



It is accompanied by the indicator lamp in the instrument panel going off and a message in the multifunction screen.



The automatic wiping must be re-activated if the ignition has been off for more than one minute, by pushing stalk **A** downwards.

Operating fault

If an automatic wiping fault occurs, the wipers will operate in intermittent mode.

Have it checked by a CITROËN dealer or a qualified workshop.



Do not cover the rain sensor, linked with the sunshine sensor and located in the centre of the windscreen behind the rear view mirror.

Switch off the automatic wiping when using an automatic car wash.

In winter, it is advisable to wait until the windscreen is completely clear of ice before activating the automatic wiping.

Vertical windscreen wiper position



This position allows the wiper blades to be lifted for winter parking, cleaning or replacement without damaging the bonnet.

In the minute following switching off of the ignition, any action on the wiper stalk positions the wipers vertically.

To park the wipers after this has been done, switch on the ignition and operate the wiper stalk.



To retain the effectiveness of the "flat-blade" wiper blades, it is advisable to:

- handle them with care,
- clean them regularly using soapy water,
- not use them to hold a sheet of cardboard against the windscreen,
- replace them at the first signs of wear.

5

VISIBILITY

COURTESY LAMPS

Selection and control of the various passenger compartment lamps.

Version without Zenith windscreen



A. Central courtesy lamp

Version with Zenith windscreen



1. Rear side reading lamps
2. Rear courtesy lamp

Central or rear courtesy lamps



In this position, the courtesy lamp comes on gradually:

- when the vehicle is unlocked,
- when the key is removed from the ignition,
- when a door is opened,
- when the remote control locking button is activated, in order to locate your vehicle.

It switches off gradually:

- when the vehicle is locked,
- when the ignition is switched on,
- 30 seconds after the last door is closed.



Permanently off.



Permanent lighting.



In permanent lighting mode, the lighting duration varies, according to the circumstances:

- with the ignition off, approximately ten minutes,
- in energy economy mode, approximately thirty seconds,
- with the engine running, unlimited.

To switch off the rear courtesy lamp, place it in the "permanently off" position.

Front side reading lamps

- ☞ With the ignition on, the first press of the corresponding switch switches on the reading lamp concerned in permanent lighting mode.
- ☞ Following a second press, it comes on:
 - when the vehicle is unlocked,
 - when the key is removed from the ignition,
 - when a door is opened,
 - when the remote control locking button is pressed, in order to locate your vehicle.

It switches off gradually:

- when the vehicle is locked,
- when the ignition is switched on,
- 30 seconds after the last door is closed.

VISIBILITY

INTERIOR MOOD LIGHTING

The dimmed passenger compartment lighting improves visibility in the vehicle when the light is poor.

Switching on

At night, the illumination of the central dashboard storage compartment comes on automatically when the sidelamps are switched on.

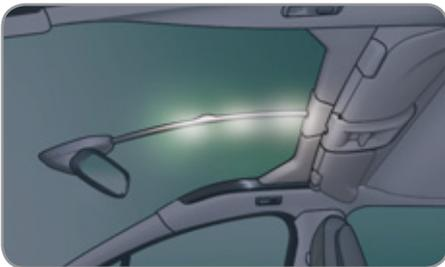

On certain versions, three lamps located in the support between the roof and the automatic day/night interior mirror come on as well.

Switching off

The interior mood lighting switches off automatically when the sidelamps are switched off.

It can be switched off manually using the instrument panel lighting rheostat button.

- ☞ With the lighting on, press several times on the left hand button of the instrument panel to progressively reduce the dashboard lighting level.
- ☞ Press again to reduce the lighting level to the minimum and switch off the interior mood lighting.

BOOT LAMP



This comes on automatically when the boot is opened and switches off automatically when the boot is closed.



The lighting time varies according to the circumstances:

- when the ignition is off, approximately ten minutes,
- in energy economy mode, approximately thirty seconds,
- when the engine is running, no limit.

5

FITTINGS



INTERIOR FITTINGS

1. Sun visor
2. Illuminated glove box
(see details on following page)
3. Door pockets
4. Upper storage compartment
5. Lower storage compartment with non-slip mat
6. USB port/Auxiliary socket
(see details on following page)
or
Coin holder
7. 12 V accessory socket
(see details on following page)
8. Centre armrest with storage
(see details on the following page)
or
Cup/bottle holder

FITTINGS

SUN VISOR

Component which protects against sunlight from the front or the side.

Version without Zenith windscreen

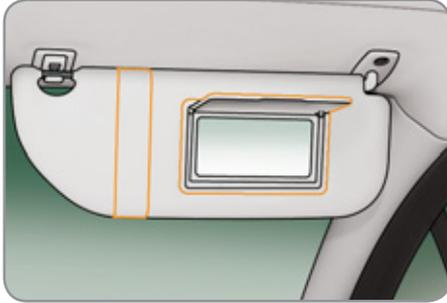

The sun visors are fitted with a courtesy mirror, with concealing flap for the driver and a ticket/card holder.

Version with Zenith windscreen

Refer to the "Familiarisation - § Zenith windscreen" section.

ILLUMINATED GLOVE BOX



This can be used to hold a water bottle. Its lid has a location for storing the vehicle's handbook pack.

☞ To open the glove box, raise the handle.

It is lit when the lid is opened.

It houses the front passenger's airbag deactivation switch **A**.

Depending on your vehicle version, it provides access to the ventilation nozzle **B**, distributing the same conditioned air as the vents in the passenger compartment.

CENTRE ARMREST

Comfort and storage system for the driver and front passenger.



Storage

☞ For access to the closed storage box, lift the lever to open the lid.

☞ For access to the open storage box below the armrest, lift the complete armrest towards the rear.

These can be used for portable devices (mobile phone, MP3 player...) which can be connected to the USB port/auxiliary socket or charged from the 12 V socket in the centre console.

FITTINGS

AUXILIARY SOCKET

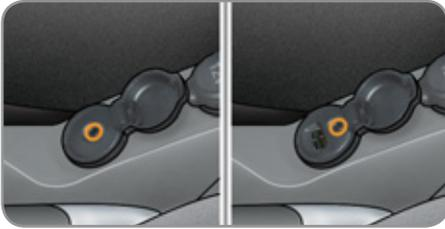

The auxiliary socket is located in the "AUX" box on the centre console.

It permits the connection of a portable device, such as a digital audio player of the iPod® type, to listen to your music files using the vehicle's speakers.

6



The management of the files is done using your portable device.

For more information on the use of this equipment, refer to the MyWay or Audio system part of the "Audio and Telematics" section.

USB PLAYER



The USB port is located in the "AUX" box on the centre console.

It permits the connection of a portable device, such as a digital audio player of the iPod® generation 5 and later type or USB memory stick type.

It reads the audio file formats (mp3, ogg, wma, wav...) which are transmitted to your audio equipment and played via the vehicle's speakers.

You can manage these files using the steering mounted controls or the audio equipment control panel and display them on the multifunction screen.



When it is in use, the portable device charges automatically.

For more information on the use of this equipment, refer to the Audio system part of the "Audio and Telematics" section.

12 V ACCESSORY SOCKET

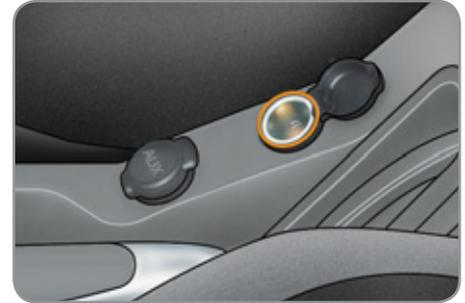

To connect a 12 V accessory (max power: 120 W), lift the cover and connect a suitable adaptor.

FITTINGS

STORAGE DRAWER

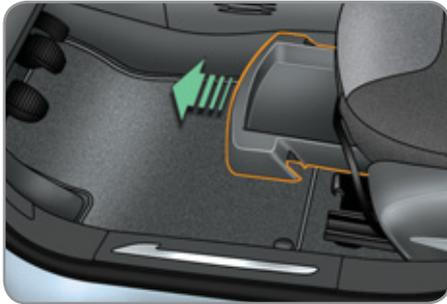

The storage drawer is located under the driver's seat.

Opening

- ☞ Raise the front of the drawer and pull it.

Removal

- ☞ Bring the drawer to the end of its travel.
- ☞ Press the ends of the slides.
- ☞ Raise the drawer and pull it fully.

Refitting

- ☞ Engage the drawer in its slides.
- ☞ At the end of its travel, press on the top of the drawer to secure it.



Do not place heavy objects in the drawer.

MATS

Removable carpet protection.

Fitting

When fitting the mat for the first time, on the driver's side use only the fixings provided in the wallet attached.

The other mats are simply placed on the carpet.

Removal

To remove the mat on the driver's side:

- ☞ move the seat as far back as possible,
- ☞ unclip the fixings,
- ☞ remove the mat.



Refitting

To refit the mat on the driver's side:

- ☞ position the mat correctly,
- ☞ refit the fixings by pressing,
- ☞ check that the mat is secured correctly.



To avoid any risk of jamming of the pedals:

- only use mats which are suited to the fixings already present in the vehicle; these fixings must be used,
- never fit one mat on top of another.

The use of mats not approved by CITROËN may interfere with access to the pedals and hinder the operation of the cruise control/speed limiter.

FITTINGS

BOOT FITTINGS

- 1. Rear parcel shelf**
(see following page for details)
- 2. Hooks**
(see following page for details)
- 3. Location for Hi-Fi amplifier**
- 4. Stowing rings**
- 5. Storage box (version equipped with a temporary puncture repair kit)**
(see following page for details)
or
Tool box (version equipped with a spare wheel)
(refer to section "Practical Information - § Changing a wheel")



FITTINGS

REAR PARCEL SHELF



To remove the shelf:

- ☞ unhook the two cords,
- ☞ raise the shelf slightly, then unclip it on each side.

HOOKS

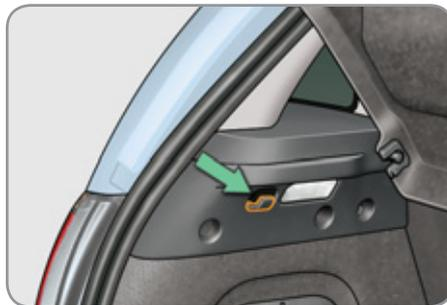

The hooks can be used to hold shopping bags.

STORAGE BOX



- ☞ Raise the boot carpet by pulling the strap upwards to gain access to the storage box.

This has areas for storing a temporary puncture repair kit, a box of spare bulbs, a first aid kit, two warning triangles, ...

6



- ☞ refit the boot floor carpet by folding it slightly in the middle.

CHILD SAFETY

GENERAL POINTS RELATING TO CHILD SEATS

Although one of CITROËN's main criteria when designing your vehicle, the safety of your children also depends on you.

For maximum safety, please observe the following recommendations:

- in accordance with European regulations, **all children under the age of 12 or less than one and a half metres tall must travel in approved child seats suited to their weight**, on seats fitted with a seat belt or ISOFIX mountings*,
- **statistically, the safest seats in your vehicle for carrying children are the rear seats**,
- **a child weighing less than 9 kg must travel in the "rearwards-facing" position both in the front and in the rear.**

7



CITROËN recommends that children should travel in the **rear seats** of your vehicle:

- **"rearwards-facing"** up to the age of 2,
- **"forwards-facing"** over the age of 2.

CHILD SEAT IN THE FRONT

"Rearwards-facing"

When a "rearwards-facing" child seat is installed on the **front passenger seat**, it is essential that the passenger airbag is deactivated. Otherwise, **the child would risk being seriously injured or killed if the airbag were to inflate.**



"Forwards-facing"

When a "forwards-facing" child seat is installed on the **front passenger seat**, adjust the vehicle's seat to the intermediate longitudinal position with the seat back upright and leave the passenger airbag activated.

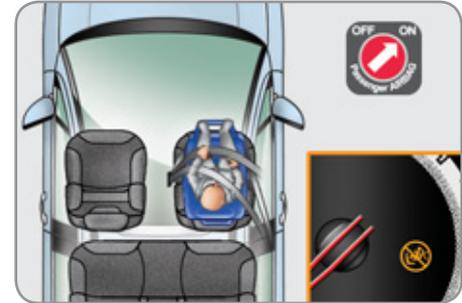

Intermediate longitudinal position

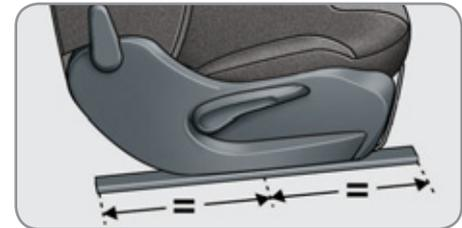

* The rules for carrying children are specific to each country. Refer to the current legislation in your country.

CHILD SAFETY



Passenger airbag OFF



Refer to the advice given on the label present on both sides of the passenger's sun visor.

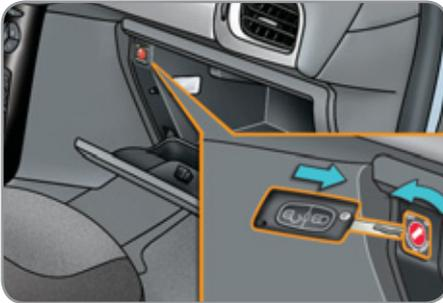

To assure the safety of your child, you must deactivate the passenger's front airbag when you install a child seat in the rearwards facing position on the front passenger's seat.

Otherwise, there is a risk that the child could be seriously injured or killed if the airbag were deployed.

CHILD SAFETY

CHILD SEATS RECOMMENDED BY CITROËN

CITROËN offers a complete range of recommended child seats which are secured using a **three point seat belt**:

Group 0+: from birth to 13 kg	Groups 1, 2 and 3: from 9 to 36 kg
 <p>L1 "RÖMER Baby-Safe Plus" Installed in the rearwards-facing position.</p>	 <p>L2 "KIDDY Comfort Pro" The impact shield must be used for carrying young children (from 9 to 18 kg).</p>
Groups 2 and 3: from 15 to 36 kg	
 <p>L3 "RECARO Start"</p>	 <p>L4 "KLIPPAN Optima" From the age of 6 years (approximately 22 kg), the booster is used on its own.</p>
	<p>L5 "RÖMER KIDFIX" Can be fitted to the vehicle's ISOFIX mountings. The child is restrained by the seat belt.</p>

CHILD SAFETY

INSTALLING CHILD SEATS ATTACHED USING THE SEAT BELT

In accordance with European regulations, this table indicates the options for installing child seats secured using a seat belt and universally approved **(a)** in accordance with the weight of the child and the seat in the vehicle.

Weight of the child and indicative age					
Seat		Under 13 kg (groups 0 (b) and 0+) Up to approx 1 year	From 9 to 18 kg (group 1) 1 to 3 years approx	From 15 to 25 kg (group 2) 3 to 6 years approx	From 22 to 36 kg (group 3) 6 to 10 years approx
Front passenger seat (c)		U	U	U	U
Outer rear seats		U	U	U	U
Centre rear seat		U	U	U	U

(a) Universal child seat: child seat that can be installed in all vehicles using a seat belt.

(b) Group 0: from birth to 10 kg. Shells seats and baby carriers cannot be installed in the front passenger seat.

(c) Consult the legislation in force in your country before installing your child on this seat.

U: Seat suitable for the installation of a child seat secured using a seat belt and universally approved, "rearwards-facing" and/or "forwards-facing".



ADVICE ON CHILD SEATS

The incorrect installation of a child seat in a vehicle compromises the child's protection in the event of an accident.

Remember to fasten the seat belts or the child seat harnesses keeping the slack relative to the child's body to a minimum, even for short journeys.

When installing a child seat using the seat belt, ensure that the seat belt is tightened correctly on the child seat and that it secures the child seat firmly on the seat of your vehicle. If your passenger seat is adjustable, move it forwards if necessary.

For optimum installation of the "forwards-facing" child seat, ensure that the back of the child seat is in contact with the back of the vehicle's seat and that the head restraint does not cause any discomfort.

If the head restraint has to be removed, ensure that it is stored or attached securely to prevent it from being thrown around the vehicle in the event of sharp braking.

Children under the age of 10 must not travel in the "forwards-facing" position on the front passenger seat, unless the rear seats are already occupied by other children, cannot be used or are absent.

Deactivate the passenger airbag when a "rearwards-facing" child seat is installed on the front seat.

Otherwise, the child would risk being seriously injured or killed if the airbag were to inflate.

Installing a booster seat

The chest part of the seat belt must be positioned on the child's shoulder without touching the neck.

Ensure that the lap part of the seat belt passes correctly over the child's thighs.

CITROËN recommends the use of a booster seat which has a back, fitted with a seat belt guide at shoulder level.

As a safety precaution, do not leave:

- a child or children alone and unsupervised in a vehicle,
- a child or an animal in a vehicle which is exposed to the sun, with the windows closed,
- the keys within reach of children inside the vehicle.

To prevent accidental opening of the doors and rear windows, use the "Child lock".

Take care not to open the rear windows by more than one third.

To protect young children from the rays of the sun, fit side blinds on the rear windows.

CHILD SAFETY

"ISOFIX" MOUNTINGS

Your vehicle has been approved in accordance with the **new ISOFIX regulation**.

The seats, represented below, are fitted with regulation ISOFIX mountings:

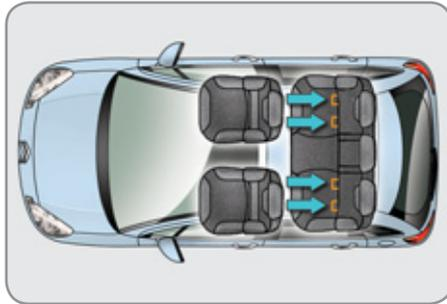

There are three rings for each seat:

- two rings **A**, located between the vehicle seat back and cushion, indicated by a label,

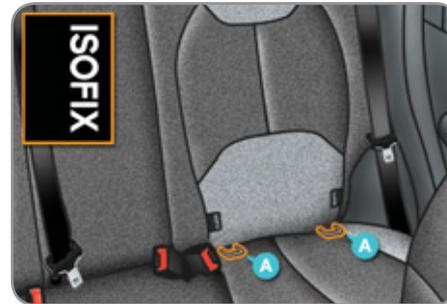

- a ring **B**, behind the seat, referred to as the **TOP TETHER** for fixing the upper strap.



This ISOFIX mounting system provides fast, reliable and safe fitting of the child seat in your vehicle.

The **ISOFIX child seats** are fitted with two latches which are secured on the two rings **A**.

When fitting an ISOFIX child seat to the right hand rear seat, before fixing the seat in place, first move the centre rear seat belt towards the middle of the vehicle so as to not interfere with the operation of the seat belt.

Some seats also have an **upper strap** which is attached to ring **B**.

To attach this strap, raise the vehicle seat's head restraint then pass the hook between its rods. Then fix the hook on ring **B** and tighten the upper strap.



The incorrect installation of a child seat in a vehicle compromises the child's protection in the event of an accident.

For information regarding the ISOFIX child seats which can be installed in your vehicle, refer to the table showing the locations for installing ISOFIX child seats.

CHILD SAFETY

ISOFIX CHILD SEAT RECOMMENDED BY CITROËN AND APPROVED FOR YOUR VEHICLE

RÖMER Duo Plus ISOFIX
(size category **B1**)

Group 1: from 9 to 18 kg



Installed only in the forwards-facing position.

Fitted with an upper strap to be secured on the upper ring **B**, referred to as the **TOP TETHER**.

Three seat body angles: sitting, reclining, lying.

☞ Adjust the front seat of the vehicle so that the child's feet do not touch the back of the seat.

7



This child seat can also be used on seats which are not fitted with ISOFIX mountings. In this case, it must be attached to the vehicle seat using the three point seat belt.

Follow the instructions for fitting the child seat given in the seat manufacturer's installation guide.

CHILD SAFETY

INSTALLING ISOFIX CHILD SEATS

In accordance with European regulations, this table indicates the options for the installation of ISOFIX child seats on the vehicle seats fitted with ISOFIX mountings.

In the case of the universal and semi-universal ISOFIX child seats, the child seat's ISOFIX size category, determined by a letter between **A** and **G**, is indicated on the child seat next to the ISOFIX logo.

	Weight of the child/indicative age									
	Less than 10 kg (group 0) Up to 6 months approx		Less than 10 kg (group 0) Less than 13 kg (group 0+) Up to 1 year approx			From 9 to 18 kg (group 1) From 1 to 3 years approx				
Type of ISOFIX child seat	Infant car seat*		"rear facing"			"rear facing"		"forward facing"		
ISOFIX size category	F	G	C	D	E	C	D	A	B	B1
Universal and semi-universal ISOFIX child seats which can be installed on the outer rear seats	X		X	IL-SU		X	IL-SU	IUF IL-SU		

7

IUF: seat suitable for the installation of an Isofix **U**niversal seat, "**F**orward facing" and secured using the "**T**op Tether" upper strap.

IL-SU: seat suitable for the installation an Isofix **S**emi-**U**niversal seat which is:

- "rear facing" fitted with a "Top Tether" upper strap or a stay,
- "forward facing" fitted with a stay,

For the securing of the "Top Tether" upper strap, refer to the "ISOFIX Mountings" section.

X: seat which is not suitable for the installation of an ISOFIX seat of the size category indicated.

* Infant car seats and "car cots" cannot be installed on the front passenger seat.

SAFETY



For the airbags to be fully effective, observe the following safety rules:

Sit in a normal upright position.

Wear a correctly adjusted seat belt.

Do not leave anything between the occupants and the airbags (a child, pet, object...). This could hamper the operation of the airbags or injure the occupants.

After an accident or if the vehicle has been stolen or broken into, have the airbag systems checked.

All work on the airbag system must be carried out by a CITROËN dealer or a qualified workshop.

Even if all of the precautions mentioned are observed, a risk of injury or of minor burns to the head, chest or arms when an airbag is deployed cannot be ruled out. The bag inflates almost instantly (within a few milliseconds) then deflates within the same time discharging the hot gas via openings provided for this purpose.

Front airbags

Do not drive holding the steering wheel by its spokes or resting your hands on the centre part of the wheel.

Passengers must not place their feet on the dashboard.

If possible, do not smoke as deployment of the airbags can cause burns or the risk of injury from a cigarette or pipe.

Never remove or pierce the steering wheel or hit it violently.

Lateral airbags

Use only approved covers on the seats, compatible with the deployment the lateral airbags. For information on the range of seat covers suitable for your vehicle, you can contact a CITROËN dealer (see "Practical information - § Accessories").

Do not fix or attach anything to the seat backs (clothing...). This could cause injury to the chest or arms if the lateral airbag is deployed.

Do not sit with the upper part of the body any nearer to the door than necessary.

Curtain airbags

Do not fix or attach anything to the roof. This could cause injury to the head if the curtain airbag is deployed.

If fitted on your vehicle, do not remove the grab handles installed on the roof, they play a part in securing the curtain airbags.

DRIVING

PARKING BRAKE



Applying

- ☞ Pull the parking brake lever fully up to immobilise your vehicle.

Releasing

- ☞ Pull the parking brake lever gently, press the release button then lower the lever fully.

9  When the vehicle is being driven, if this warning lamp and the **STOP** warning lamp come on, accompanied by an audible signal and a message on the multifunction screen, this indicates that the parking brake is still on or has not been properly released.

 When parking on a slope, direct your wheels against the pavement, apply the parking brake and engage a gear.

6-SPEED MANUAL GEARBOX

Engaging 5th or 6th gear

- ☞ Move the lever fully to the right to engage 5th or 6th gear.

Engaging reverse gear

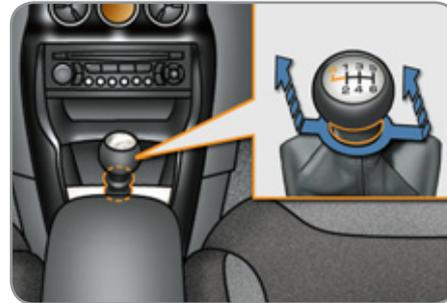

- ☞ Raise the ring under the knob and move the gear lever to the left then forwards.

 Only engage reverse gear when the vehicle is stationary with the engine at idle.

 As a safety precaution and to facilitate starting of the engine:

- always select neutral,
- press the clutch pedal.

DRIVING

GEAR SHIFT INDICATOR*

System which reduces fuel consumption by advising the driver to change up on vehicles fitted with a manual gearbox.

Operation

The system intervenes only when driving economically.

Depending on the driving situation and your vehicle's equipment, the system may advise you to skip one or more gears. You can follow this instruction without engaging the intermediate gears.

The gear recommended should not be considered compulsory. In fact, the configuration of the road, the amount of traffic and safety remain determining factors when choosing the best gear. Therefore, the driver remains responsible for deciding whether or not to follow the advice given by the system.

This function cannot be deactivated.

Example:

- You are in third gear.



- You press the accelerator pedal moderately.

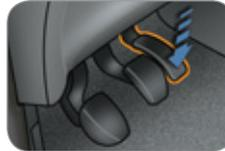

- The system may suggest that you engage a higher gear, if appropriate.



The information appears in the form of an arrow in the instrument panel screen.

Depending on your vehicle's equipment, this arrow may be accompanied by the recommended gear.



In the case of driving which makes particular demands on the performance of the engine (firm pressure on the accelerator pedal, for example, when overtaking...), the system will not recommend a gear change.

The system never suggests:

- engaging first gear,
- engaging reverse gear,
- engaging a lower gear.

* According to engine.

ELECTRONIC GEARBOX

Five or six-speed electronically controlled gearbox which offers a choice between the comfort of automated operation or the pleasure of manual gear changing.

Two driving modes are offered:

- **automated** mode for automatic control of the gears by the gearbox, without any action by the driver,
- **manual** mode for the sequential changing of the gears by the driver, using the gear lever or the steering mounted control paddles,

In automated mode, you can temporarily take control of gear changes at any time, using the steering mounted control paddles.

Gear lever



R. Reverse

- ☞ With your foot on the brake, move the lever forwards to select this position.

N. Neutral.

- ☞ With your foot on the brake, select this position to start the engine.

A. Automated mode.

- ☞ Move the lever backwards to select this mode.

M +/- Manual mode with sequential gear changing.

- ☞ Move the lever backwards, then to the left to select this mode, then:
 - push forwards to change up a gear,
 - or push backwards to change down a gear.

Steering mounted controls

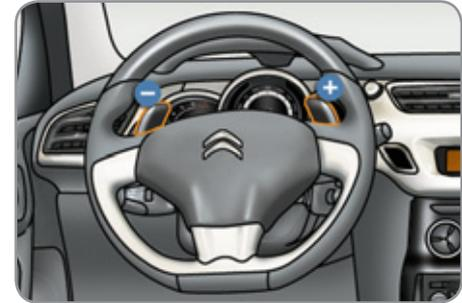

- + Paddle to the right of the steering wheel for changing up.

- ☞ Press the back of the steering mounted "+" paddle to change up a gear.

- Paddle to the left of the steering wheel for changing down.

- ☞ Press the back of the steering mounted "-" paddle to change down a gear.



The steering mounted paddles do not allow neutral to be selected, reverse gear to be engaged or disengaged, or the driving mode to be changed.

DRIVING

Automated mode

☞ Select position **A**.



AUTO and the gear engaged appear in the instrument panel.

The gearbox then operates in auto-adaptive mode, without any action on the part of the driver. It continuously selects the most suitable gear taking account of:

- optimisation of fuel consumption,
- driving style,
- road conditions,
- vehicle load.

For optimum acceleration, when overtaking another vehicle for example, press the accelerator pedal fully down, beyond the point of resistance.



You can change mode at any time by moving the gear lever from **A** to **M** or the other way round.



Never select neutral (position **N**) when moving.

Temporary control of gear changing

You can temporarily take over control of gear changes using the steering mounted "+" and "-" control paddles: if the engine speed allows, the gear change is carried out.

This function allows you to anticipate certain situations such as overtaking another vehicle or approaching a bend. After a few moments without any action on the paddles, the gearbox resumes control of gear changing automatically.

Manual mode

☞ Select position **M**.



The gears engaged appear in succession in the instrument panel.

The gear change requests are only carried out if the engine speed permits.

It is not necessary to release the accelerator pedal during gear changes.

When braking or slowing down, the gearbox changes down automatically so that the vehicle picks up in the right gear.

Under full acceleration, the change up will not take place unless the driver operates the gear lever or steering mounted control paddle (unless the engine is close to its maximum speed).



You can change mode at any time by moving the gear lever from **A** to **M** or the other way round.



Never select neutral (position **N**) when moving.

STOP & START

The Stop & Start system puts the engine temporarily into standby - STOP mode - during stops in the traffic (red lights, traffic jams, or other...). The engine restarts automatically - START mode - as soon as you want to move off. The restart takes place instantly, quickly and silently.

Perfect for urban use, the Stop & Start system reduces fuel consumption and exhaust emissions as well as the noise level when stationary.

Operation

Going into engine STOP mode

ECO The "ECO" warning lamp comes on in the instrument panel and the engine goes into standby:

- **with a manual gearbox**, at speeds below 12 mph (20 km/h), when you put the gear lever into neutral, and you release the clutch pedal.
- **with a 5 or 6-speed electronic gearbox**, at speeds below 5 mph (8 km/h), when you press the brake pedal or put the gear lever in position **N**.



A time counter calculates the sum of the periods in STOP mode during a journey. It rests itself to zero every time the ignition is switched on with the key.



For your comfort, during parking manoeuvres, STOP mode is not available for a few seconds after coming out of reverse gear. STOP mode does not affect the functionality of the vehicle, such as for example, braking, power steering...

Special cases: STOP mode not available

STOP mode is not invoked when:

- the driver's door is open,
- the driver's seat belt is not fastened,
- the vehicle has not exceeded 6 mph (10 km/h) since the last engine start using the key,
- the engine is needed to maintain a comfortable temperature in the passenger compartment,
- demisting is active,
- some special conditions (battery charge, engine temperature, braking assistance, ambient temperature...) where the engine is needed to assure control of a system.

ECO The "ECO" warning lamp flashes for a few seconds then goes off.

This operation is perfectly normal.



Never refuel with the engine in STOP mode; you must switch off the ignition with the key.

DRIVING

Going into engine START mode

ECO The "ECO" warning lamp goes off and the engine starts:

- with a manual gearbox, when you depress the clutch pedal,
- with a 5-speed or 6-speed electronic gearbox:
 - gear lever in position **A** or **M**, when you release the brake pedal,
 - or gear lever in position **N** and the brake pedal released, when you move the gear lever to position **A** or **M**,
 - or when you engage reverse gear.

Special cases: START invoked automatically

For reasons of safety and for your comfort, START mode is invoked automatically when:

- you open the driver's door,
- you unfasten the driver's seat belt,
- the speed of the vehicle exceeds 7 mph (11 km/h) with the electronic gearbox system,
- some special conditions (battery charge, engine temperature, braking assistance, ambient temperature...) where the engine is needed for control of a system.

ECO The "ECO" warning lamp flashes for a few seconds, then goes off.

This operation is perfectly normal.

Deactivation



At any time, press the "ECO OFF" switch to deactivate the system.

This is confirmed by the switch warning lamp coming on accompanied by a message in the screen.



If the system has been deactivated in STOP mode, the engine restarts immediately.

Reactivation

Press the "ECO OFF" switch again.

The system is active again; this is confirmed by the switch warning lamp going off, accompanied by a message in the screen.



The system is reactivated automatically at every new start using the key.



With a manual gearbox in STOP mode, if you engage a gear without fully depressing the clutch pedal, a message is displayed asking you to fully depress the clutch pedal so that the engine can restart.

Operating fault



In the event of a fault with the system, the "ECO OFF" switch warning lamp flashes then comes on continuously.

Have it checked by a CITROËN dealer or a qualified workshop.

In the event of a fault in STOP mode, the vehicle may stall. It is then necessary to switch off the ignition and start the engine again using the key.

Maintenance



Before doing anything under the bonnet, deactivate the Stop & Start system to avoid any risk of injury resulting from automatic operation of START mode.

This system requires a battery with a special specification and technology (reference numbers available from a CITROËN dealer or a qualified workshop).

Fitting a battery not listed by CITROËN introduces the risk of malfunction of the system.

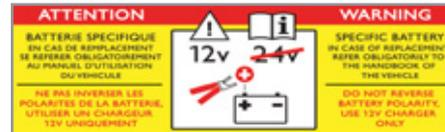

The Stop & Start system makes use of advanced technology. All work on this type of battery must be done by a CITROËN dealer or a qualified workshop.

HILL START ASSIST

System which holds your vehicle temporarily (approximately 2 seconds) when starting on a slope, the time it takes to move your foot from the brake pedal to the accelerator pedal.

This function is only active when:

- the vehicle is completely stationary, with your foot on the brake pedal,
- certain conditions on a slope are met,
- with the driver's door closed.

The hill start assist function cannot be deactivated.

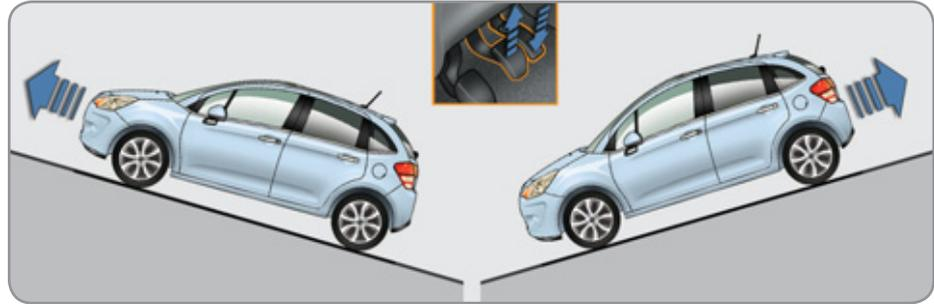

Operation

On an ascending slope, with the vehicle stationary, the vehicle is held momentarily when you release the brake pedal:

- provided you are in automated mode (position **A**) or in manual mode (position **M**) on an electronic gearbox.

On a descending slope, with the vehicle stationary and reverse gear engaged, the vehicle is held momentarily when you release the brake pedal.



Do not leave the vehicle while it is being held in the hill start assist phase.

If you need to leave the vehicle with the engine running, manually apply the parking brake then ensure that the parking brake warning lamp is on (not flashing) in the instrument panel.

Operating fault



SERVICE

If a malfunction of the system occurs, these warning lamps come on. Contact a CITROËN dealer or a qualified workshop to have the system checked.

SPEED LIMITER

System which prevents the vehicle from exceeding the speed programmed by the driver.

When the programmed speed limit is reached, pressing the accelerator pedal in the normal manner no longer has any effect.

The speed limiter is **switched on** manually: it requires a programmed speed of at least 20 mph (30 km/h).

The speed limiter is **switched off** by manual operation of the control.

The programmed speed can be exceeded temporarily by pressing the accelerator firmly.

To return to the programmed speed, simply slow down to a speed below the programmed speed.

The programmed speed remains in the memory when the ignition is switched off.



The speed limiter cannot, in any circumstances, replace the need to respect speed limits, nor can it replace the need for vigilance and responsibility on the part of the driver.

Steering mounted controls

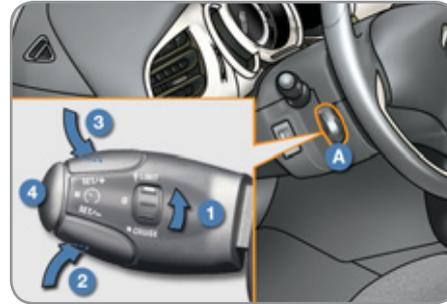

The controls of this system are grouped together on stalk **A**.

1. Speed limiter mode selection thumb wheel.
2. Value decrease button.
3. Value increase button.
4. Speed limiter on/off button.

Displays in the instrument panel



The programmed information is grouped together in the instrument panel screen.

5. Speed limiter on/off indication.
6. Speed limiter mode selection indication.
7. Programmed speed value.

CRUISE CONTROL

System which automatically maintains the speed of the vehicle at the value programmed by the driver, without any action on the accelerator pedal.

The cruise control is **switched on** manually: it requires a minimum vehicle speed of 25 mph (40 km/h), as well as the engagement of:

- fourth gear on a manual gearbox,
- second gear on a or automatic or electronic gearbox, in sequential mode,
- position **A** on an electronic gearbox or position **D** on an automatic gearbox.

The cruise control is **switched off** manually or by pressing the brake or clutch pedal or on triggering of the ESP system for safety reasons.

It is possible to exceed the programmed speed temporarily by pressing the accelerator pedal.

To return to the programmed speed, simply release the accelerator pedal.

Switching off the ignition cancels any programmed speed value.

Steering mounted controls

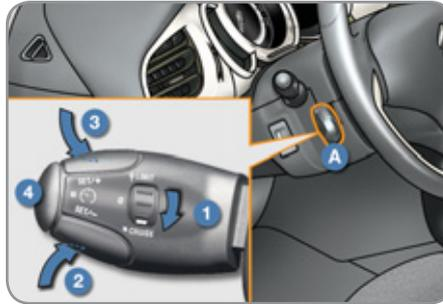

The controls of this system are grouped together on stalk **A**.

1. Cruise control mode selection thumb wheel.
2. Value decrease button.
3. Value increase button.
4. Cruise control off/resume button.

Displays in the instrument panel



The programmed information is grouped together in the instrument panel screen.

5. Cruise control off/resume indication.
6. Cruise control mode selection indication.
7. Programmed speed value.



The cruise control cannot, in any circumstances, replace the need to respect speed limits, nor can it replace the need for vigilance and responsibility on the part of the driver.

REAR PARKING SENSORS

System consisting of four proximity sensors, located in the rear bumper.



This detects any obstacle (person, vehicle, tree, gate, etc.) behind the vehicle, except obstacles located just below the bumper.



An object, such as a stake, a roadworks cone or any other similar object may be detected at the beginning of the manoeuvre, but may no longer be detected when the vehicle comes close to it.

Activation

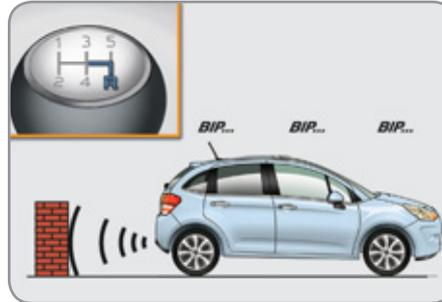

The system is activated as soon as reverse gear is engaged, accompanied by an audible signal.

The proximity information is given by:

- an audible signal, which becomes more rapid as the vehicle approaches the obstacle.
- a graphic (according to version) in the multifunction screen, with blocks which become increasingly closer to the vehicle.

When the distance between the rear of the vehicle and the obstacle is less than thirty centimetres, the audible signal becomes continuous and the "Danger" symbol appears in the multifunction screen.



On completion of the manoeuvre, when you exit reverse gear, the system becomes inactive.



The parking sensor system cannot, in any circumstances, take the place of the vigilance and responsibility of the driver.

Programming

You can activate or deactivate the system by means of the multifunction screen configuration menu. The system state is memorised when switching off the ignition.

For more information on access to the parking sensors menu, refer to "Configuration/Vehicle parameters" in the "Multifunction screens" section corresponding to your screen.



The system will be deactivated automatically when towing a trailer or when a bicycle carrier is fitted (vehicle fitted with a towbar or bicycle carrier recommended by CITROËN).

Operating faults

SERVICE

If there is an operating fault, when reverse gear is engaged this warning lamp comes on in the instrument panel, accompanied by an audible signal (short beep) and a message in the multifunction screen.



In bad or wintry weather, ensure that the sensors are not covered with mud, frost or snow.

TOTAL & CITROËN

Partners in performance and protecting the environment

Innovation in the search for performance

For over 40 years, the TOTAL Research and Development departments have developed for CITROËN, lubricants to match the latest technical innovations on CITROËN vehicles, both for competition and for everyday motoring.

For you, this is an assurance that you will obtain of the best performance for your engine.

Optimum protection for your engine

By having your CITROËN vehicle serviced with TOTAL lubricants, you are contributing towards improving the life and performances of your engine, while also protecting the environment.



CITROËN prefers TOTAL



CHECKS

BONNET

Protects the components of the engine and provides access for checking levels.

Opening



Before doing anything under the bonnet, switch off the Stop & Start system to avoid any risk of injury resulting from an automatic change to START mode.

- ☞ Open the front left door.
- ☞ Pull the interior release lever **A**, located at the bottom of the door aperture.

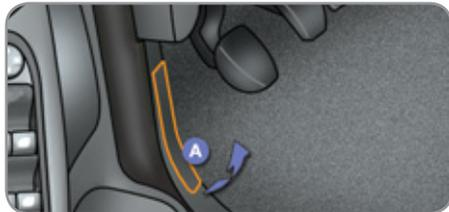

- ☞ Push the exterior safety catch **B** to the left and raise the bonnet.

- ☞ Unclip the bonnet stay **C** from its housing, holding it by its foam protection.
- ☞ Fix the stay in the notch to hold the bonnet open.

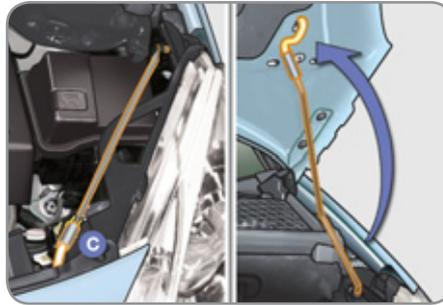

The location of the interior release lever prevents opening of the bonnet while the front left door is closed.



When the engine is hot, handle the exterior safety catch and the stay with care.

Closing

- ☞ Take the stay out of the support notch.
- ☞ Clip the stay in its housing.
- ☞ Lower the bonnet and release it at the end of its travel.
- ☞ Pull on the bonnet to check that it is fully latched.

RUNNING OUT OF FUEL (DIESEL)

If your vehicle is fitted with an HDi engine, the fuel system must be primed if you run out of fuel.

This system consists of a priming pump and a transparent pipe under the bonnet.

- ☞ Fill the fuel tank with at least five litres of Diesel.
- ☞ Open the bonnet.
- ☞ Depending on version, unclip the cover to gain access to the priming pump.
- ☞ Squeeze and release the priming pump until resistance is felt (could be from the first application) and fuel appears in the transparent pipe with the green connector.
- ☞ Operate the starter until the engine starts.
- ☞ Depending on version, put the cover back in position and clip it in place.
- ☞ Close the bonnet.



If the engine does not start at the first attempt, do not try again. Operate the priming pump again, then the starter.

CHECKS



PETROL ENGINES

- | | | |
|--------------------------------|---------------------------|---------------------------|
| 1. Screenwash fluid reservoir. | 4. Brake fluid reservoir. | 7. Engine oil dipstick. |
| 2. Coolant header tank. | 5. Battery. | 8. Engine oil filler cap. |
| 3. Air filter. | 6. Fusebox. | |

CHECKS



DIESEL ENGINES

1. Screenwash fluid reservoir.
2. Coolant header tank.
3. Air filter.
4. Brake fluid reservoir.
5. Battery.
6. Fusebox.
7. Engine oil dipstick.
8. Engine oil filler cap.
9. Priming pump (on fuel filter).

PRACTICAL INFORMATION

TEMPORARY PUNCTURE REPAIR KIT

Complete system consisting of a compressor and a sealant cartridge which permits **temporary repair** of a tyre so that you can drive to the nearest garage.

It is designed to repair most punctures which could affect the tyre, located on the tyre tread or shoulder.

Access to the kit



This kit is installed in the storage box, under the boot floor.

Description of the kit



- A. "Sealant" or "Air" position selector.
- B. On "I"/off "O" switch.
- C. Deflation button.
- D. Pressure gauge (in bar or p.s.i.).
- E. Compartment housing:
 - a cable with adaptor for 12 V socket,
 - various inflation adaptors for accessories, such as balls, bicycle tyres...



- F. Sealant cartridge.
- G. White pipe with cap for repair.
- H. Black pipe for inflation.
- I. Speed limit sticker.



The speed limit sticker I must be affixed to the vehicle's steering wheel to remind you that a wheel is in temporary use.

Do not exceed a speed of 50 mph (80 km/h) when driving with a tyre repaired using this type of kit.

Repair procedure

1. Sealing



- ☞ Switch off the ignition.
- ☞ Turn the selector **A** to the "sealant" position.
- ☞ Check that the switch **B** is in position "O".



- ☞ Uncoil the white pipe **G** fully.
- ☞ Unscrew the cap from the white pipe.
- ☞ Connect the white pipe to the valve of the tyre to be repaired.

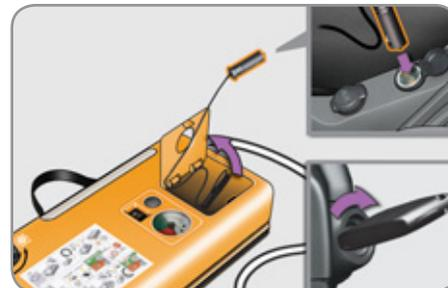

- ☞ Connect the compressor's electric plug to the vehicle's 12 V socket.
- ☞ Start the vehicle and leave the engine running.



Avoid removing any foreign bodies which have penetrated into the tyre.



Take care, this product is harmful (e.g. ethylene-glycol, colophony...) if swallowed and causes irritation to the eyes.
Keep it out of reach of children.



Do not start the compressor before connecting the white pipe to the tyre valve: the sealant product would be expelled through the pipe.

PRACTICAL INFORMATION



- ☞ Switch on the compressor by moving the switch **B** to position "I" until the tyre pressure reaches 2.0 bars. The sealant is injected into the tyre under pressure; do not disconnect the pipe from the valve during this operation (risk of splashing).



If after around 5 to 7 minutes the pressure is not attained, this indicates that the tyre is not repairable; contact a CITROËN dealer or a qualified workshop for assistance.

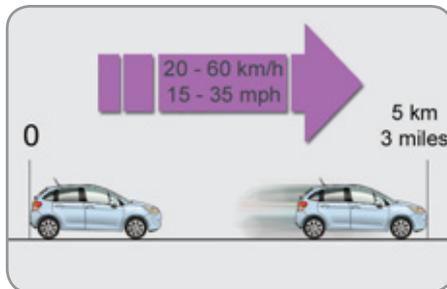

- ☞ Remove the kit and screw the cap back on the white pipe. Take care to avoid staining your vehicle with traces of fluid. Keep the kit to hand.
- ☞ Drive immediately for approximately three miles (five kilometres), at reduced speed (between 15 and 35 mph (20 and 60 km/h)), to plug the puncture.
- ☞ Stop to check the repair and the tyre pressure using the kit.

PRACTICAL INFORMATION

2. Inflation



- ☞ Turn the selector **A** to the "air" position.
- ☞ Uncoil the black pipe **H** fully.
- ☞ Connect the black pipe to the valve of the wheel.

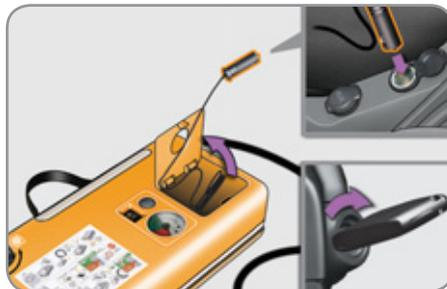

- ☞ Connect the compressor's electric plug to the vehicle's 12 V socket.
- ☞ Start the vehicle again and leave the engine running.



- ☞ Adjust the pressure using the compressor (to inflate: switch **B** in position "I"; to deflate: switch **B** in position "O" and press button **C**), in accordance with the vehicle's tyre pressure label (located on the left hand door aperture).

A loss of pressure indicates that the puncture has not been fully plugged; contact a CITROËN dealer or qualified workshop for assistance.

- ☞ Remove and stow the kit.
- ☞ Drive at reduced speed (50 mph [80 km/h] max) limiting the distance travelled to approximately 120 miles (200 km).



☞ Visit a CITROËN dealer or a qualified workshop as soon as possible.

You must inform the technician that you have used this kit. After inspection, the technician will inform you whether the tyre can be repaired or must be replaced.

Removing the cartridge

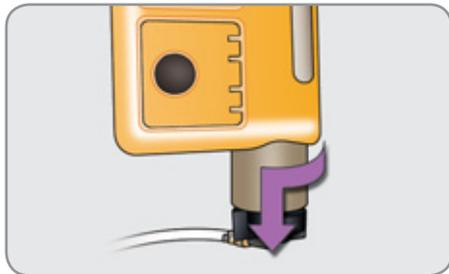

- ☞ Stow the black pipe.
- ☞ Detach the angled base from the white pipe.
- ☞ Support the compressor vertically.
- ☞ Unscrew the cartridge from the bottom.



Beware of discharges of fluid.

The expiry date of the fluid is indicated on the cartridge.

The sealant cartridge is designed for single use; even if only partly used, it must be replaced.

After use, do not discard the cartridge into the environment, take it to an authorised waste disposal site or a CITROËN dealer.

Do not forget to obtain a new sealant cartridge, available from CITROËN dealers or from a qualified workshop.

Checking tyre pressures/ inflating accessories

You can also use the compressor, without injecting any product, to:

- check or adjust the pressure of your tyres,
- inflate other accessories (balls, bicycle tyres...).



- ☞ Turn the selector **A** to the "Air" position.
- ☞ Uncoil the black pipe **H** fully.
- ☞ Connect the black pipe to the valve of the wheel or accessory. If necessary, fit one of the adaptors supplied with the kit first.

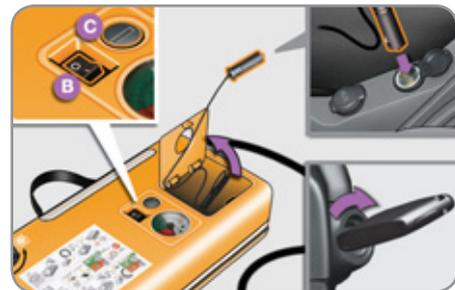

- ☞ Connect the compressor's electrical connector to the vehicle's 12 V socket.
- ☞ Start the vehicle and let the engine run.
- ☞ Adjust the pressure using the compressor (to inflate: switch **B** in position "I"; to deflate: switch **B** in position "O" and press button **C**), according to the vehicle's tyre pressure label or the accessory's pressure label.
- ☞ Remove the kit then stow it.

PRACTICAL INFORMATION

CHANGING A WHEEL

Procedure for changing a faulty wheel for the spare wheel using the tools provided with the vehicle.

Access to the tools



The tools are installed in the boot under the floor.

To gain access to them:

- ☞ open the boot,
- ☞ raise the floor,
- ☞ remove the polystyrene storage box,
- ☞ unclip and remove the box containing the tools.

List of tools

All of these tools are specific to your vehicle. Do not use them for other purposes.

1. Wheelbrace.
For removing the wheel trim and removal of the wheel fixing bolts.
2. Jack with integral handle.
For raising of the vehicle.
3. "Bolt cover" tool.
For removing the bolt protectors (covers) on alloy wheels.
4. Socket for the security wheel bolts (located in the glove box).
For adapting the wheelbrace to the special "security" wheel bolts (if your vehicle has them).



Wheel with trim

When removing the wheel, first detach the trim using the wheelbrace 1 pulling at the valve passage hole.

When refitting the wheel, refit the trim starting by placing its cut-out at the valve and press around its edge with the palm of your hand.

Access to the spare wheel



The spare wheel is installed in the boot under the floor.

According to country, the spare wheel may be steel or of the "space-saver" type.

To gain access to it, refer to the paragraph "Access to the tools" on the previous page.



Fitting the steel or "space-saver" type spare wheel

If your vehicle is fitted with alloy wheels, it is normal to notice, when tightening the bolts on fitting, that the washers do not come into contact with the steel or "space-saver" type spare wheel. The wheel is secured by the conical contact of each bolt.

Taking out the wheel

- ☞ Unscrew the yellow central bolt.
- ☞ Raise the spare wheel towards you from the rear.
- ☞ Take the wheel out of the boot.

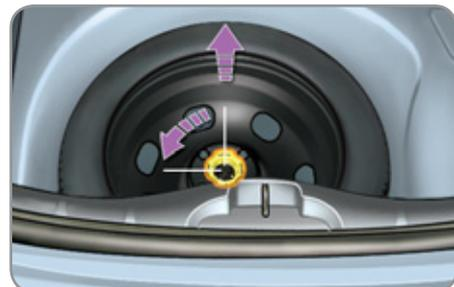

Putting the wheel back in place

- ☞ Put the wheel back in its housing.
- ☞ Unscrew the yellow central bolt by a few turns then put it in place in the centre of the wheel.
- ☞ Tighten fully until the central bolt clicks to retain the wheel correctly.

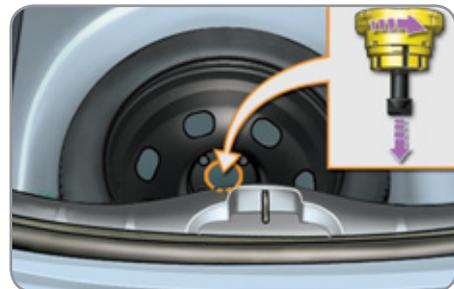

- ☞ Put the box back in place in the centre of the wheel and clip it.
- ☞ Put the polystyrene storage box back in place.
- ☞ Refit the boot floor carpet by lightly folding it in two (refer to the section "Fittings - § Storage box").



On vehicles equipped with a "space-saver" type spare wheel, the punctured wheel cannot be stowed in place of the "space-saver" wheel.

PRACTICAL INFORMATION

Changing the number plate lamp bulbs (W5W)

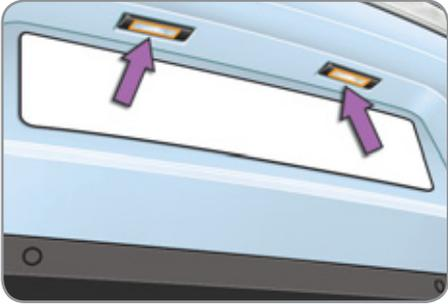

- ☞ Insert a thin screwdriver into one of the outer holes of the lens.
- ☞ Push it outwards to unclip.
- ☞ Remove the lens.
- ☞ Pull the bulb out and change it.

Third brake lamp (4 W5W bulbs)

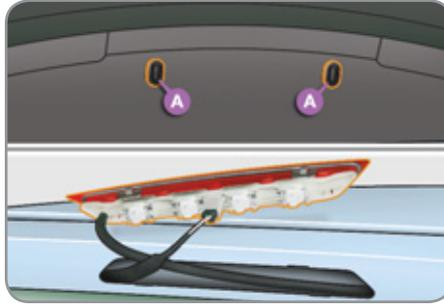

- ☞ Open the boot.
- ☞ Remove the plugs **A** on the inner panel.
- ☞ Push on the centre of the lamp using two screwdrivers to lever it outwards.
- ☞ Disconnect the connector and if necessary the screenwash pipe from the lamp.
- ☞ Turn the bulb holder for the faulty bulb a quarter of a turn.
- ☞ Pull out the bulb and change it.

To refit, carry out these operations in reverse order.

PRACTICAL INFORMATION

Fuse table

Fuse N°	Rating	Functions
F1	20 A	Engine control unit supply, cooling fan unit control relay, multifunction engine control main relay, injection pump (Diesel).
F2	15 A	Horn.
F3	10 A	Front/rear wash-wipe.
F4	20 A	Daytime running lamps.
F5	15 A	Diesel heater (Diesel), particle filter additive pump (Diesel), air flow sensor (Diesel), fuel pump (1.1i and 1.4i), blow-by heater and electrovalves (VTi).
F6	10 A	ABS/ESP control unit, secondary brake lamp switch.
F7	10 A	Electric power steering, automatic gearbox.
F8	25 A	Starter motor control.
F9	10 A	Switching and protection unit (Diesel).
F10	30 A	Fuel heater (Diesel), blow-by heater (1.1i, 1.4i and Diesel), fuel pump (VTi), injectors and ignition coils (petrol), electronic thermostat and canister purge electrovalve (1.1i and 1.4i).
F11	40 A	Heater blower.

PRACTICAL INFORMATION

Table of maxi-fuses

Fuse N°	Rating	Functions
MF1*	60 A	Fan assembly.
MF2*	30 A	ABS/ESP pump.
MF3*	30 A	ABS/ESP electrovalves.
MF4*	60 A	Built-in Systems Interface (BSI) supply.
MF5*	60 A	Built-in Systems Interface (BSI) supply.
MF6*	-	Not used.
MF7*	80 A	Dashboard fusebox.
MF8*	-	Not used.

* The maxi-fuses provide additional protection for the electrical systems. All work on the maxi-fuses must be carried out by a CITROËN dealer or a qualified workshop.

TECHNICAL DATA

DIMENSIONS (IN MM)

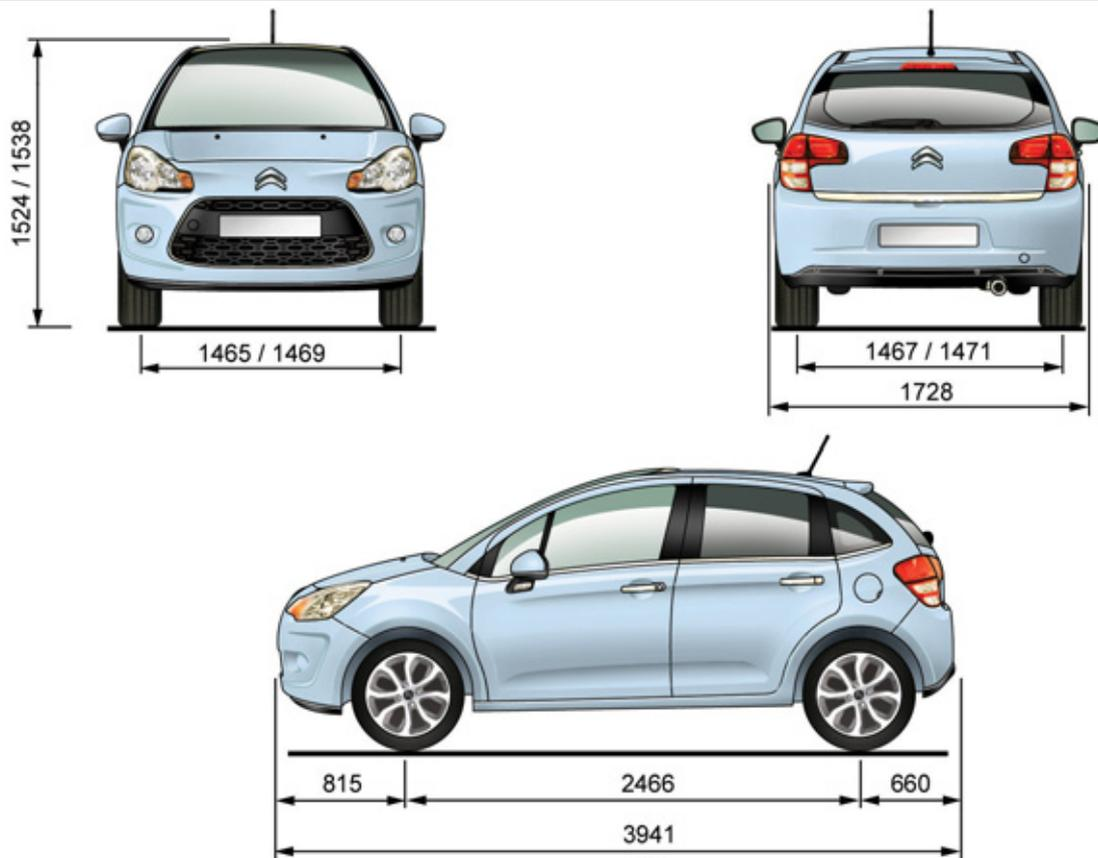



EMERGENCY OR ASSISTANCE CALL

04 NAVIGATION - GUIDANCE

NAVIGATION SETTINGS

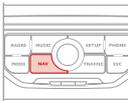
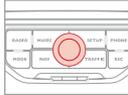
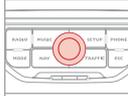
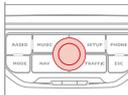
1	 Press the NAV button.	
2	 Press the NAV button again or select the Navigation Menu function and press the dial to confirm.	
3	 Select the "Settings" function and press the dial to confirm.	
4	 Select the "Navi volume" function and turn the dial to set the volume of each voice synthesiser (traffic information, alert messages...).	

i To activate or deactivate vocal guidance, with guidance active and the map displayed in the screen, press the dial and then select or deselect "Voice advice".

Voice advice

 The adjustment of the volume for the Risk Areas POIs is used only during the transmission of an alert.

5  Select the "POI categories on Map" function to select the POIs to be displayed on the map by default.

POI categories on Map

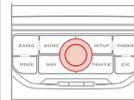

6  Select "Set parameters for risk areas" for access to the "Display on map", "Visual alert" and "Sound alert" functions.

Set parameters for risk areas

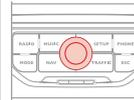

i UPDATING POIs

The detailed procedure for updating POIs is available at the following internet address: citroen.navigation.com. This requires an SDHC (High Capacity) compatible reader.

07 MUSIC MEDIA PLAYERS

CD, MP3/WMA CD INFORMATION AND ADVICE



The MP3 format, an abbreviation of MPEG 1, 2 & 2.5 Audio Layer 3 and the WMA format, an abbreviation of Windows Media Audio and the property of Microsoft, are audio compression standards which permit the recording of several tens of music files on a single disc.



In order to be able to play a recorded CDR or CDRW, when recording it is preferable to select the ISO 9660 level 1, 2 or Joliet standard.

If the disc is recorded in another format it may not be played correctly.

It is recommended that the same recording standard is always used for an individual disc, with as low a speed as possible (4x maximum) for optimum sound quality.

In the particular case of a multi-session CD, the Joliet standard is recommended.



The MyWay will only play audio files with the extension ".mp3" with a speed of between 8 Kbps and 320 Kbps and the extension ".wma" with a speed of between 5 Kbps and 384 Kbps.

It also supports the VBR (Variable Bit Rate) mode.

No other type of file (.mp4, .m3u...) can be played.



It is advisable to restrict file names to 20 characters, without using special characters (e.g.: " ? ; ù) to avoid any play or display problems.

07 MUSIC MEDIA PLAYERS

USING THE EXTERNAL INPUT (AUX)

JACK/USB AUDIO CABLE NOT SUPPLIED

1

Connect the portable device (MP3/WMA player...) to the auxiliary JACK socket or to the USB port, using a suitable audio cable.



2



Press the MUSIC button then press it again or select the Music Menu function and press the dial to confirm.

Music Menu

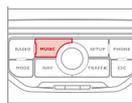

3



Select the "External device" function and press the dial to activate it.

External device

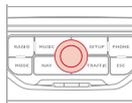

4



Select the AUX music source and press the dial to confirm. Play begins automatically.

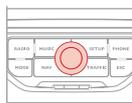

!

The display and management of the controls is via the portable device.

08 BLUETOOTH TELEPHONE

CONNECTING A TELEPHONE

* The services available depend on the network, the SIM card and the compatibility of the Bluetooth telephone used. Check the telephone manual and with your network provider for details of the services available to you.

! For reasons of safety and because they require prolonged attention on the part of the driver, the operations for pairing the Bluetooth mobile telephone to the hands-free system of the MyWay must be carried out with the vehicle stationary. The ignition must be on.

 Visit www.citroen.co.uk for more information (compatibility, more help, ...).

1 Activate the telephone's Bluetooth function and ensure that it is "visible to all" (refer to the telephone instructions).
The last telephone connected is reconnected automatically.
A message confirms the connection.



2  Press the PHONE button.

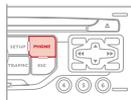

i The list of telephones connected previously (4 maximum) appears on the multifunction screen. Select the telephone required for a new connection.

i Once the telephone has been connected, MyWay can synchronise the address book and the call list. This synchronisation may take a few minutes*.

1



When a telephone is already connected, to change it press the PHONE button, then select Phone Menu and press the dial to confirm.

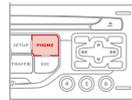

2



Select "Connect phone". Select the telephone and press to confirm.

Connect phone

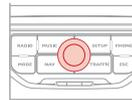

10 SCREEN MENU MAP



MAIN FUNCTION

- 1
- 2 OPTION A
 - 3 option A1
 - 3 option A2
- 2 OPTION B...



"Traffic" Menu

- 1
- 2 Messages on route
- 2 Only warnings on route
- 2 All warning messages
- 2 All messages
- 2 Geo. Filter
 - 3 Within 2 miles (3 km)
 - 3 Within 3 miles (5 km)

- 3 Within 6 miles (10 km)
- 3 Within 30 miles (50 km)
- 3 Within 60 miles (100 km)



"Music" Menu

- 1
- 2 Select music
- 2 Sound settings
 - 3 Balance/Fader
 - 3 Bass/Treble
 - 3 Equalizer
 - 4 Linear
 - 4 Classic
 - 4 Jazz
 - 4 Rock/Pop
 - 4 Techno

- 4 Vocal
- 3 Loudness
- 3 Speed dependent volume
- 3 Reset sound settings



"Radio" Menu

- 1
- 2 Waveband
 - 3 FM
 - 3 AM
- 2 Manual tune
- 2 Sound settings
 - 3 Balance/Fader
 - 3 Bass/Treble
 - 3 Equalizer
 - 4 Linear

- 4 Classic
- 4 Jazz
- 4 Rock/Pop
- 4 Techno
- 4 Vocal
- 3 **Loudness**
- 3 **Speed dependent volume**
- 3 **Reset sound settings**



"Navigation" Menu

- 1
- 2 **Abort guidance/Resume guidance**
- 2 **Destination input**
- 3 **Enter new address**
- 4 Country
- 4 City
- 4 Street
- 4 House number

- 4 Start route guidance
- 4 Postal code
- 4 Save to address book
- 4 Intersection
- 4 City district
- 4 Geo position
- 4 Map

Navigate HOME

- 3 **Choose from address book**
- 3 **Choose from last destinations**
- 3 **TMC station information**
- 2 **Stopovers**
- 3 **Add stopover**
- 4 Address input
- 4 Navigate HOME
- 4 Choose from address book
- 4 Choose from last destinations

- 3 **Rearrange route**
- 3 **Replace stopover**
- 3 **Delete stopover**
- 3 **Recalculate**
- 4 Fast route
- 4 Short route
- 4 Optimized route

POI search

- 2
- 3 **POI nearby**
- 3 **POI near destination**
- 3 **POI in city**
- 3 **POI in country**
- 3 **POI near route**
- 2 **Route options**
- 3 **Route type**
- 4 Fast route
- 4 Short route

- 4 Optimized route
- 3 **Route dynamics**
- 4 Traffic independent
- 4 Semi-dynamic
- 3 **Avoidance criteria**
- 4 Avoid motorways
- 4 Avoid toll roads
- 4 Avoid ferries
- 3 **Recalculate**
- 2 **Settings**
- 3 **Navi volume**
- 3 **POI categories on Map**
- 3 **Set parameters for risk areas**
- 4 Display on map
- 4 Visual alert
- 4 Sound alert



"Phone" Menu

- 1
- 2 **Dial number**
- 2 **Dial from address book**
- 2 **Call lists**
- 2 **Connect phone**
- 3 **Search phone**
- 3 **Phones connected**
- 4 Disconnect phone
- 4 Rename phone
- 4 Delete pairing
- 4 Delete all pairings
- 4 Show details
- 2 **Settings**
- 3 **Select ring tone**
- 3 **Phone/Ring tone volume**
- 3 **Enter mailbox number**



"SETUP" menu

- 1
- 2 **System language***
- 3 **Deutsch**
- 3 **English**
- 3 **Español**
- 3 **Français**
- 3 **Italiano**
- 3 **Nederlands**
- 3 **Polski**
- 3 **Portuguese**
- 2 **Date & Time***
- 3 **Set date & time**
- 3 **Date format**
- 3 **Time format**

* Available according to model.

2 **Display**

3 **Brightness**

3 **Colour**

4 Pop titanium

4 Toffee

4 Blue steel

4 Technogrey

4 Dark blue

3 **Map colour**

4 Day mode for map

4 Night mode for map

4 Auto. Day/Night for map

2 **Vehicle***

3 **Vehicle information**

4 Alert log

4 Status of functions

2 **Units**

3 **Temperature**

4 Celsius

4 Fahrenheit

3 **Metric/Imperial**

4 Kilometres (Consumption: l/100)

4 Kilometres (Consumption: km/l)

4 Miles (Consumption: MPG)

2 **System**

3 **Factory reset**

3 **Software version**

3 **Automatic scrolling**

* Available according to model.

FREQUENTLY ASKED QUESTIONS

QUESTION	ANSWER	SOLUTION
There is a difference in sound quality between the different audio sources (radio, CD...).	For optimum sound quality, the audio settings (Volume, Bass, Treble, Ambience, Loudness) can be adapted to the different sound sources, which may result in audible differences when changing source (radio, CD...).	Check that the audio settings (Volume, Bass, Treble, Ambience, Loudness) are adapted to the sources listened to. It is advisable to set the AUDIO functions (Bass, Treble, Front-Rear Balance, Left-Right Balance) to the middle position, select the Linear musical ambience and set the loudness correction to the "Active" position in CD mode or to the "Inactive" position in radio mode.
The CD is ejected automatically or is not played by the player.	The CD is inserted upside down, is unplayable, does not contain any audio data or contains an audio format which the player cannot play. The CD is protected by an anti-pirating protection system which is not recognised by the audio equipment.	<ul style="list-style-type: none"> - Check that the CD is inserted in the player the right way up. - Check the condition of the CD: the CD cannot be played if it is too damaged. - Check the content in the case of a recorded CD: consult the advice in the Audio section. - The audio equipment's CD player does not play DVDs. - Because of their quality level, certain writeable CDs will not be played by the audio system.
The CD player sound is poor.	The CD used is scratched or of poor quality.	Insert good quality CDs and store them in suitable conditions.
	The audio equipment settings (bass, treble, ambiences) are unsuitable.	Set the treble or bass level to 0, without selecting an ambience.

QUESTION	ANSWER	SOLUTION
The stored stations do not function (no sound, 87.5 Mhz is displayed...).	An incorrect waveband is selected.	Press the BAND AST button to return to the waveband (AM, FM1, FM2, FMAST) on which the stations are stored.
The quality of reception of the radio station listened to gradually deteriorates or the stored stations do not function (no sound, 87.5 Mhz is displayed...).	The vehicle is too far from the transmitter used by the station listened to or there is no transmitter in the geographical area through which the vehicle is travelling.	Activate the RDS function to enable the system to check whether there is a more powerful transmitter in the geographical area.
	The environment (hills, buildings, tunnels, basement car parks...) block reception, including in RDS mode.	This phenomenon is normal and does not indicate a failure of the audio equipment.
	The aerial is absent or has been damaged (for example when going through a car wash or into an underground car park).	Have the aerial checked by a CITROËN dealer.
Sound cut-outs of 1 to 2 seconds in radio mode.	During this brief sound cut-out, the RDS searches for any frequency permitting better reception of the station.	Deactivate the RDS function if the phenomenon is too frequent and always on the same route.
With the engine off, the audio equipment switches off after a few minutes of use.	When the engine is switched off, the audio equipment operating time depends on the battery charge. The switch-off is normal: the audio equipment switches to economy mode and switches off to prevent discharging of the vehicle's battery.	Start the vehicle's engine to increase the battery charge.

QUESTION	ANSWER	SOLUTION
TA is selected. However, certain traffic jams along the route are not indicated in real time.	On starting, it is several minutes before the system begins to receive the traffic information.	Wait until the traffic information is being received correctly (displaying of the traffic information symbols on the map).
	In certain countries, only major routes (motorways...) are listed for the traffic information.	This phenomenon is normal. The system is dependent on the traffic information available.
I receive a speed camera alert for a camera which is not on my route.	The system announces all speed cameras located in a conical zone forward of the vehicle. It may detect speed cameras on nearby or parallel roads.	Zoom the map to view the exact position of the speed camera.
The audible speed camera alert is not working.	Audible alerts are not active.	Activate audible alerts in Navigation Menu, Settings, Set parameters for risk areas.
	The alert volume level is set to minimum.	Increase the speed camera alert volume.
The altitude is not displayed.	On starting, the initialisation of the GPS may take up to 3 minutes to receive more than 3 satellites correctly.	Wait until the system has started up completely. Check that there is a GPS coverage of at least 3 satellites (long press on the SETUP button, then select GPS coverage).
	Depending on the geographical environment (tunnel...) or the weather, the conditions of reception of the GPS signal may vary.	This phenomenon is normal. The system is dependent on the conditions of reception of the GPS signal.
The route is not calculated successfully.	The exclusion criteria may conflict with the current location (exclusion of toll roads on a motorway with tolls).	Check the exclusion criteria.

QUESTION	ANSWER	SOLUTION
There is a long waiting time after inserting a CD.	When a new medium is inserted, the system reads a certain amount of data (directory, title, artist, etc.). This may take a few seconds.	This phenomenon is normal.
I cannot connect my Bluetooth telephone.	The telephone's Bluetooth function may be deactivated or the equipment may not be visible.	<ul style="list-style-type: none"> - Check that your telephone's Bluetooth function is activated. - Check that your telephone is visible.
A telephone connected by Bluetooth is inaudible.	The volume level depends on both the system and the telephone.	Increase the MyWay volume setting, possibly to maximum, and increase the telephone volume level if necessary.

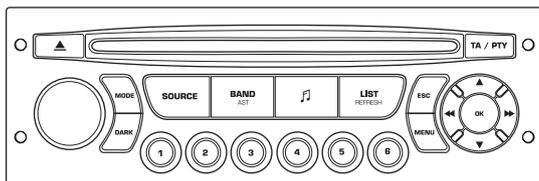

Audio system

AUDIO SYSTEM/BLUETOOTH



Your Audio system is coded in such a way that it will only operate in your vehicle. If it is to be installed in another vehicle, contact your CITROËN dealer for configuration of the system.



For safety reasons, the driver must carry out operations which require prolonged attention while the vehicle is stationary.

When the engine is switched off and to prevent discharging of the battery, the audio equipment may switch off after a few minutes.

CONTENTS

01	First steps	p. 214
02	Steering mounted controls	p. 215
03	Main menu	p. 216
04	Audio	p. 217
05	USB Box	p. 220
06	Bluetooth functions	p. 223
07	Configuration	p. 226
08	Screen menu map	p. 228
	Frequently asked questions	p. 233

01 FIRST STEPS

Select source:
radio, audio CD/MP3 CD, USB,
Jack connection, Streaming,
AUX.

Select wavebands
FM1, FM2, FMast and
AM.

Audio settings: front/
rear fader, left/right
balance, bass/treble,
loudness, audio
ambiences.

Display the list of
local stations.
Long press: CD
tracks or MP3 folders
(CD/USB).

Abandon the current
operation.

Eject CD.

Select the screen display
mode:
Date, audio functions, trip
computer, telephone.

On/off, volume setting.

The DARK button changes the screen display
for improved driving comfort at night.
1st press: upper bar only illuminated.
2nd press: black screen.
3rd press: return to standard display.

Buttons 1 to 6:
Select a pre-set radio station.
Long press: pre-set a station.

Display main menu.

TA (Traffic Announcements)
on/off.
Long press: PTY* (radio
Programme TYpe) mode.

Automatic frequency search
down/up.
Select previous/next CD, MP3
or USB track.

Confirm.

Select next frequency down/up.
Select previous/next MP3 folder.
Select previous/next folder/genre/
artist/playlist (USB).



* Available according to version.

02 STEERING MOUNTED CONTROLS

Radio: select the previous/next pre-set station.

USB: select genre/artist/folder from the classification list.

Select the previous/next item in a menu.

Radio: automatic search for a higher frequency.

CD/MP3/USB: selection of the next track.

CD/USB: continuous press: fast forwards play.

Move in the list.

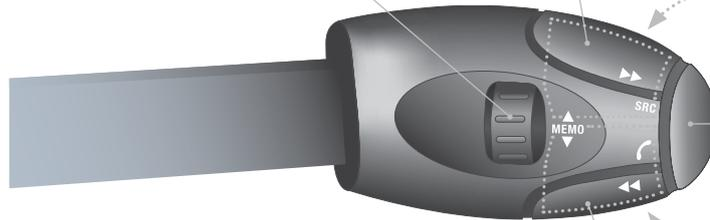

Volume increase.

Change audio source.
Confirm a selection.
Call/end call on the telephone.
Press for more than 2 seconds:
telephone main menu.

Volume decrease.

Mute: press the volume increase and decrease buttons simultaneously.
The sound is restored by pressing one of the two volume buttons.

Radio: automatic search for a lower frequency.

CD/MP3/USB: selection of the previous track.

CD/USB: continuous press: fast reverse.
Move in the list.

03 MAIN MENU

> MONOCHROME SCREEN C

AUDIO FUNCTIONS:
radio, CD, USB, options.

TELEPHONE:
Bluetooth hands-free,
pairing, management
of a call.

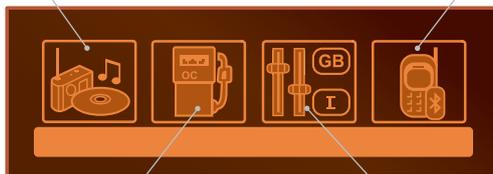

TRIP COMPUTER:
entering of distances,
alerts, status of functions.

**PERSONALISATION-
CONFIGURATION:**
vehicle parameters,
display, languages.

> MONOCHROME SCREEN A



For a detailed global view of the menus available, refer to the "Screen menu map" section.

04 AUDIO



RADIO SELECTING A STATION

1	Press the SOURCE button several times in succession and select the radio.	
2	Press the BAND AST button to select a waveband: FM1, FM2, FMast, AM.	
3	Briefly press one of the buttons to carry out an automatic search of the radio stations.	
4	Press one of the buttons to carry out a manual search up/down for radio frequencies.	
 LIST REFRESH button with a red arrow pointing to it.	Press the LIST REFRESH button to display the list of stations received locally (30 stations maximum). To update this list, press for more than two seconds.	

The external environment (hills, buildings, tunnels, basement car parks, ...) may block reception, including in RDS mode. This is a normal effect of the way in which radio waves are transmitted and does not indicate any failure of the audio system.

RDS

1	Press the MENU button.	
2	Select AUDIO FUNCTIONS then press OK.	
3	Select the FM WAVEBAND PREFERENCES function then press OK.	
4	Select ACTIVATE RDS then press OK. RDS appears on the screen.	
In radio mode, press OK directly to activate/deactivate RDS mode.		
The RDS, if displayed, enables you to continue listening to the same station by automatic retuning to alternative frequencies. However, in certain conditions, coverage of an RDS station may not be assured throughout the country as radio stations do not cover 100 % of the territory. Under conditions of very weak reception, the system may change to a regional station.		

05 USB BOX

USING THE AUXILIARY INPUT (AUX)

JACK socket or USB port (according to vehicle)



The auxiliary input, JACK or USB, allows the connection of a portable device (MP3 player...).



Do not connect a device to both the JACK socket and the USB port at the same time.

1

Connect the portable device (MP3 player...) to the JACK socket or to the USB port, using a suitable cable (not supplied).

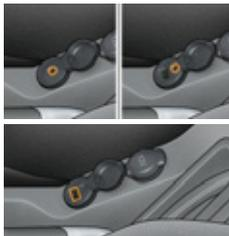

2



Press the SOURCE button several times in succession and select AUX.



ADJUSTING THE VOLUME OF THE AUXILIARY SOURCE

1

First adjust the volume of your portable device.



2



Then adjust the volume of your Audio system.

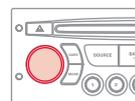

The display and control is via the portable device.



06 BLUETOOTH FUNCTIONS



RECEIVING A CALL

- 1 An incoming call is announced by a ring and a superimposed display in the vehicle's screen.

- 2  Select the YES tab on the display using the buttons and confirm by pressing OK.

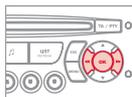

-  Press the steering mounted control to accept the call.

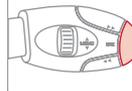

MAKING A CALL

- 1 From the Bluetooth telephone function Audio menu, select Manage the telephone call then Call, Call list or Directory.

- 2 Press the steering mounted control for more than two seconds for access to your directory, then navigate with the thumb wheel.
Or
To dial a number, use your telephone's keypad, with the vehicle stationary.

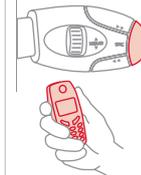

ENDING A CALL

- 1 During a call, press the steering mounted control for more than 2 seconds. Confirm with OK to end the call.

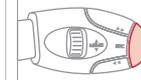

06 BLUETOOTH FUNCTIONS



BLUETOOTH AUDIO STREAMING*



Wireless transmission of the telephone's music files via the audio equipment. The telephone must be able to manage the appropriate Bluetooth profiles (Profiles A2DP/AVRCP).

1

Initiate the pairing between the telephone and the vehicle. This pairing can be initiated from the vehicle's telephone function menu or via the telephone's keypad. See steps 1 to 9 on the previous pages. During the pairing phase, the vehicle must be stationary with the key in the ignition.



2

Select the telephone to be connected from the telephone function menu.
The audio system connects to a newly paired telephone automatically.

3



Activate the streaming source by pressing the SOURCE button**. The tracks to be played can be controlled as usual via the buttons on the audio system control panel and the steering mounted controls***. The contextual information can be displayed on the screen.

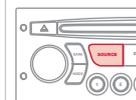

* Depending on the compatibility of the telephone.

** In certain cases, playing of the Audio files must be initiated from the keypad.

*** If the telephone supports the function.

07 CONFIGURATION



SETTING THE DATE AND TIME SCREEN A

1



Press the MENU button.



2



Using the arrows, select DISPLAY CONFIGURATION.

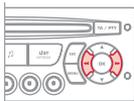

3



Press to confirm the selection.

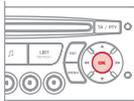

4



Using the arrows, select YEAR.

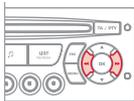

5



Press to confirm the selection.

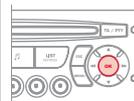

6



Adjust the setting.

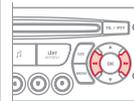

7



Press to confirm the selection.

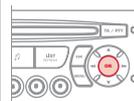

8



Start again from step 1 then set MONTH, DAY, HOUR, MINUTES.

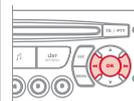

07 CONFIGURATION

SETTING THE DATE AND TIME SCREEN C

1



Press the MENU button.

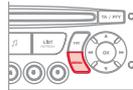

2



Using the arrows, select
PERSONALISATION
CONFIGURATION.

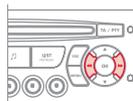

3



Press to confirm the selection.

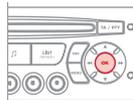

4



Using the arrows, select DISPLAY
CONFIGURATION.

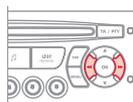

5



Press to confirm the selection.

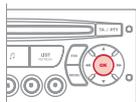

6



Using the arrows, select ADJUST
DATE AND TIME.

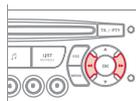

7



Press to confirm the selection.

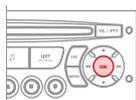

8



Adjust the settings one by one
confirming by pressing the OK
button. Next select the OK tab on the
screen then confirm.

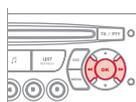

08 SCREEN MENU MAP



MONOCHROME A



1 MAIN FUNCTION

- 2 OPTION A
- 3 OPTION A1
- 3 OPTION A2
- 2 OPTION B...

1 RADIO-CD

- 2 RDS SEARCH
- 2 REG MODE
- 2 CD REPEAT
- 2 RANDOM PLAY

1 VEHICLE CONFIG*

- 2 REV WIPE ACT
- 2 GUIDE LAMPS

* The parameters vary according to vehicle.

1 OPTIONS

- 2 DIAGNOSTICS
- 3 CONSULT
- 3 ABANDON

08 SCREEN MENU MAP



1 UNITS

2 TEMPERATURE: °CELSIUS/°FAHRENHEIT

2 FUEL CONSUMPTION:
KM/L - L/100 - MPG

1 DISPLAY ADJUST

2 YEAR

2 MONTH

2 DATE

2 HOUR

2 MINUTES

2 12 H/24 H MODE

1 LANGUAGE

2 FRANCAIS

2 ITALIANO

2 NEDERLANDS

2 PORTUGUES

2 PORTUGUES-BRASIL

2 DEUTSCH

2 ENGLISH

2 ESPANOL

08 SCREEN MENU MAP



MONOCHROME C



Press the OK dial for access to short-cut menus according to the display on the screen:



RADIO

- 1 activate/deactivate RDS
- 1 activate/deactivate REG mode
- 1 activate/deactivate radiotext

CD/MP3 CD

- 1 activate/deactivate Intro
- 1 activate/deactivate track repeat (the entire current CD for CD, the entire current folder for MP3 CD)
- 1 activate/deactivate random play (the entire current CD for CD, the entire current folder for MP3 CD)

USB

- 1 activate/deactivate track repeat (of the current folder/artist/genre/playlist)
- 1 activate/deactivate random play (of the current folder/artist/genre/playlist)

08 SCREEN MENU MAP



MONOCHROME C

Pressing the MENU button displays:



1 AUDIO FUNCTIONS

2 FM BAND PREFERENCES

3 alternative frequencies (RDS)

4 activate/deactivate

3 regional mode (REG)

4 activate/deactivate

3 radio-text information (RDTXT)

4 activate/deactivate

2 PLAY MODES

3 album repeat (RPT)

4 activate/deactivate

3 track random play (RDM)

4 activate/deactivate



1 TRIP COMPUTER

2 ENTER DISTANCE TO DESTINATION

3 Distance: x miles

2 ALERT LOG

3 Diagnostics

2 STATUS OF THE FUNCTIONS*

3 Functions activated or deactivated

* The parameters vary according to vehicle.

08 SCREEN MENU MAP



PERSONALISATION-CONFIGURATION

- 1
- 2 **DEFINE THE VEHICLE PARAMETERS***
- 2 **DISPLAY CONFIGURATION**
 - 3 **video brightness adjustment**
 - 4 normal video
 - 4 inverse video
 - 4 brightness (- +) adjustment
 - 3 **date and time adjustment**
 - 4 day/month/year adjustment
 - 4 hour/minute adjustment
 - 4 choice of 12 h/24 h mode
 - 3 **choice of units**
 - 4 l/100 km - mpg - km/l
 - 4 °Celsius/°Fahrenheit
- 2 **CHOICE OF LANGUAGE**



BLUETOOTH TELEPHONE

- 1
- 2 **Bluetooth configuration**
 - 3 **Connect/Disconnect a device**
 - 3 **Telephone function**
 - 3 **Audio Streaming function**
 - 4 Consult the paired device
 - 4 Delete a paired device
 - 4 Perform a Bluetooth search
- 2 **Call**
 - 3 **Calls list**
 - 4 Directory
 - 2 **Manage the telephone call**
 - 3 **Terminate the current call**
 - 3 **Activate private mode**

FREQUENTLY ASKED QUESTIONS

QUESTION	ANSWER	SOLUTION
There is a difference in sound quality between the different audio sources (radio, CD...).	For optimum sound quality, the audio settings (Volume, Bass, Treble, Ambience, Loudness) can be adapted to the different sound sources, which may result in audible differences when changing source (radio, CD...).	Check that the audio settings (Volume, Bass, Treble, Ambience, Loudness) are adapted to the sources listened to. It is advisable to set the AUDIO functions (Bass, Treble, Front-Rear Balance, Left-Right Balance) to the middle position, select the musical ambience "None" and set the loudness correction to the "Active" position in CD mode or to the "Inactive" position in radio mode.
The CD is ejected automatically or is not played by the player.	The CD is inserted upside down, is unplayable, does not contain any audio data or contains an audio format which the player cannot play. The CD is protected by an anti-pirating protection system which is not recognised by the audio equipment.	<ul style="list-style-type: none"> - Check that the CD is inserted in the player the right way up. - Check the condition of the CD: the CD cannot be played if it is too damaged. - Check the content in the case of a recorded CD: consult the advice in the "Audio" section. - The audio equipment's CD player does not play DVDs. - Due to their quality level, certain writeable CDs will not be played by the Audio system.
The message "USB peripheral error" is displayed on the screen.	The battery of the peripheral may not be sufficiently charged.	Recharge the battery of the peripheral device.
The Bluetooth connection is cut.	The USB memory stick is not recognised. The memory stick may be corrupt.	Reformat the memory stick.
The CD player sound is poor.	The CD used is scratched or of poor quality.	Insert good quality CDs and store them in suitable conditions.
	The audio equipment settings (bass, treble, ambiences) are unsuitable.	Set the treble or bass level to 0, without selecting an ambience.

QUESTION	ANSWER	SOLUTION
The stored stations do not function (no sound, 87.5 Mhz is displayed...).	An incorrect waveband is selected.	Press the BAND AST button to return to the waveband (AM, FM1, FM2, FMAST) on which the stations are stored.
The traffic announcement (TA) is displayed. I do not receive any traffic information.	The radio station is not part of the regional traffic information network.	Tune to a radio station which broadcasts traffic information.
The quality of reception of the radio station listened to gradually deteriorates or the stored stations do not function (no sound, 87.5 Mhz is displayed...).	The vehicle is too far from the transmitter used by the station listened to or there is no transmitter in the geographical area through which the vehicle is travelling.	Activate the RDS function to enable the system to check whether there is a more powerful transmitter in the geographical area.
	The environment (hills, buildings, tunnels, basement car parks...) block reception, including in RDS mode.	This phenomenon is normal and does not indicate a failure of the audio equipment.
	The aerial is absent or has been damaged (for example when going through a car wash or into an underground car park).	Have the aerial checked by a CITROËN dealer.
Sound cut-outs of 1 to 2 seconds in radio mode.	During this brief sound cut-out, the RDS searches for any frequency permitting better reception of the station.	Deactivate the RDS function if the phenomenon is too frequent and always on the same route.
With the engine off, the audio equipment switches off after a few minutes of use.	When the engine is switched off, the audio equipment operating time depends on the battery charge. The switch-off is normal: the audio equipment switches to economy mode and switches off to prevent discharging of the vehicle's battery.	Start the vehicle's engine to increase the battery charge.
The message "the Audio system is overheated" appears on the display.	In order to protect the installation if the surrounding temperature is too high, the audio equipment switches to an automatic thermal protection mode leading to a reduction of the volume or stopping of the playing of the CD.	Switch the Audio system off for a few minutes to allow the system to cool.

VISUAL SEARCH

EXTERIOR

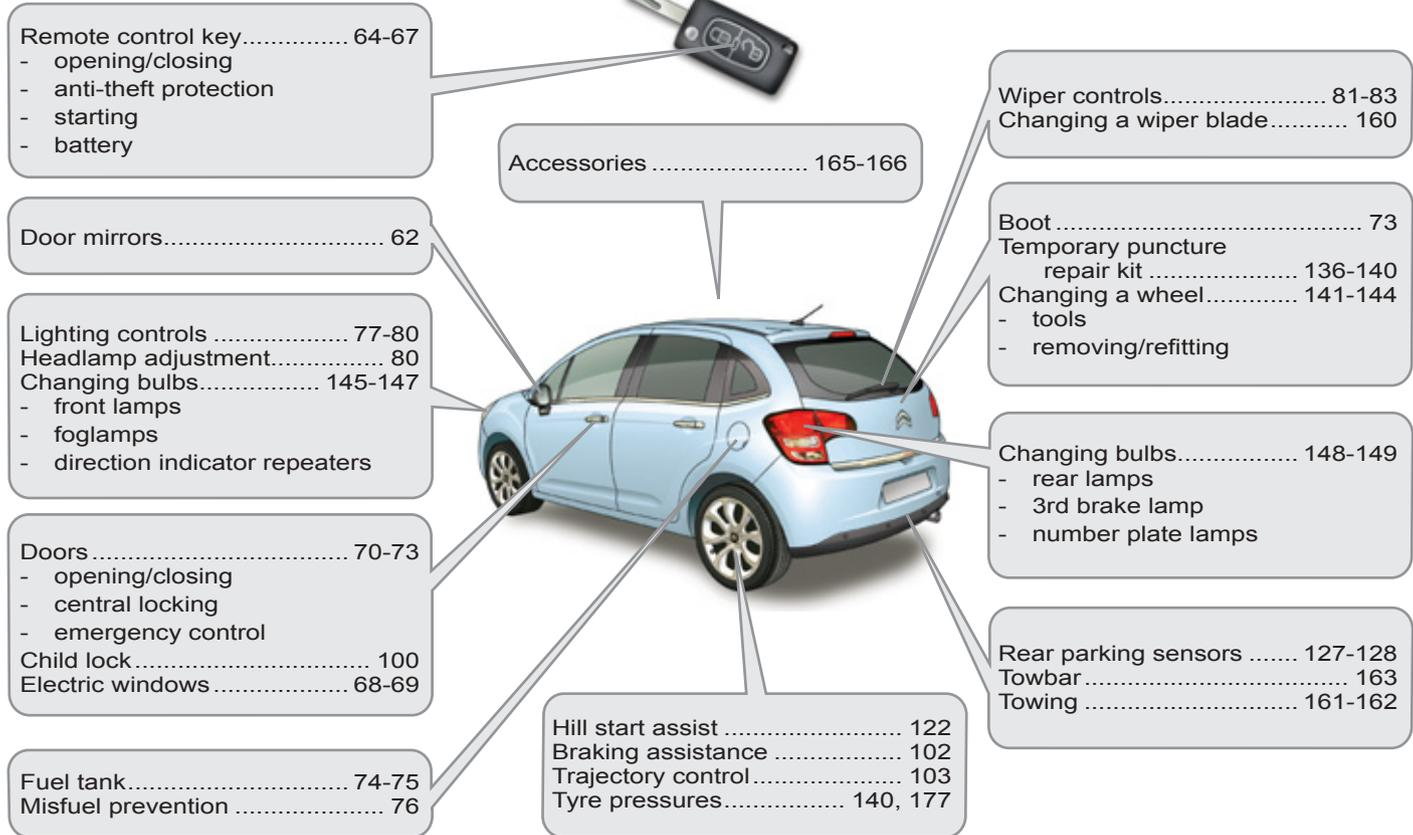

VISUAL SEARCH

INTERIOR

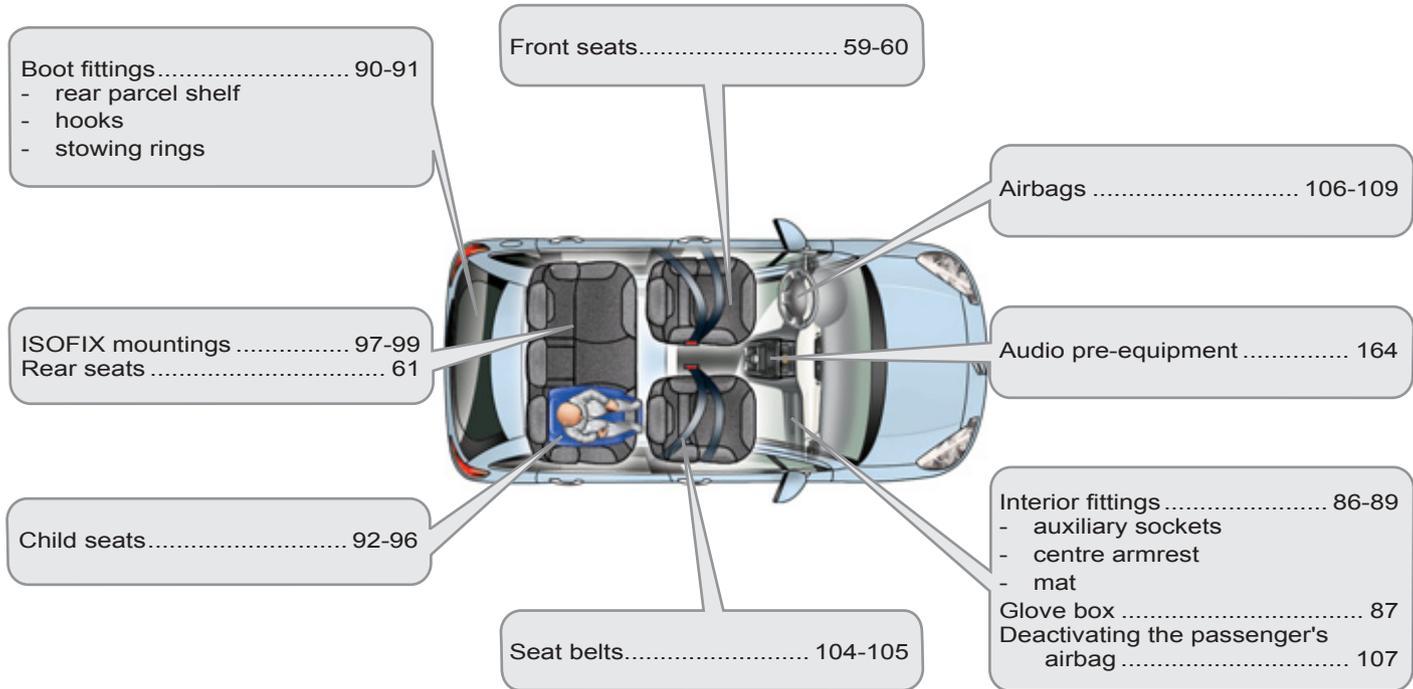

VISUAL SEARCH

INSTRUMENTS AND CONTROLS

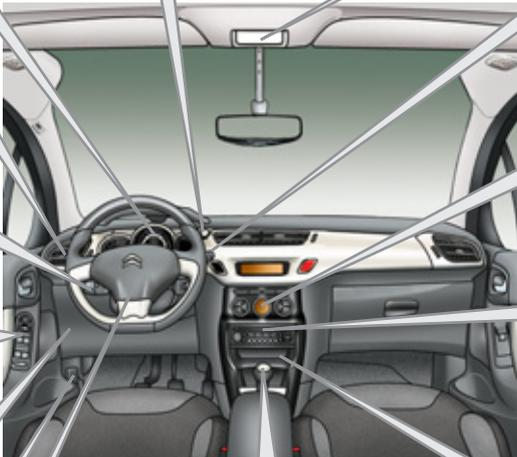

Instrument panels 23-24
Warning lamps 25-34
Indicators 35-37
Adjustment buttons 38-39
- trip distance recorder/clock
- lighting dimmer/black panel

Lighting controls 77-80
Headlamp adjustment 80
Stop & Start 119-121

Speed limiter 123-124
Cruise control 125-126

Door mirrors 62
Electric windows 68-69

Dashboard fuses 151-153

Opening the bonnet 130

Steering wheel adjustment 63
Horn 101

Scented air freshener 58
Multifunction screens 43-49
Hazard warning lamps 101

Rear view mirror 63
Zenith windscreen blind 6
Sun visor 87

Wiper controls 81-83
Trip computer 40-42

Ventilation/Heating 50-54
Manual air conditioning 52-54
Digital air conditioning 55-56
Demisting - Defrosting
(rear screen) 57

Audio system 213-234
Setting the date/time 227
MyWay 181-212
Setting the date/time 204
Emergency or assistance call 179

Interior mood lighting 85

Manual gearbox 110
Gear shift indicator 111
Electronic gearbox 112-115
Automatic gearbox 116-118
Parking brake 110

VISUAL SEARCH

TECHNICAL DATA - MAINTENANCE

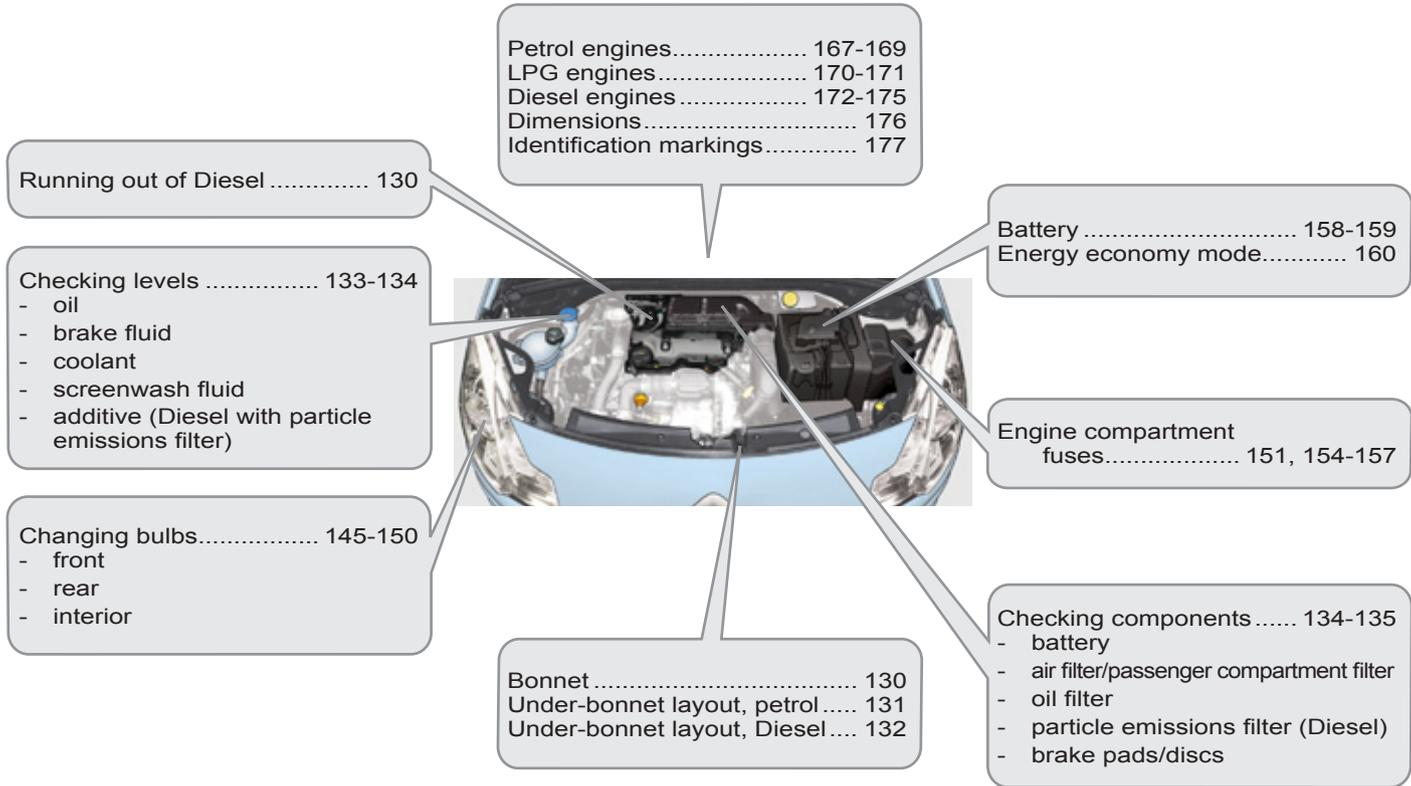

ALPHABETICAL INDEX

- S** Stability control (ESP) 103
Starting the vehicle..... 65, 112, 116
Steering mounted controls,
 audio 215
Stopping the vehicle..... 65, 112, 116
Stop & Start..... 42, 57, 74, 119,
 130, 134, 158
Storage..... 86, 87
Storage box..... 91
Storage drawer..... 89
Stowing rings..... 90
Sun visor 87
Synchronising the remote
 control 66
System, navigation..... 187
Systems, ASR and ESP 103
- T** Table of weights 168, 171, 174
Tables of engines..... 167, 170, 172
Tables of fuses 151
Tank, fuel 74, 76
Technical data..... 167, 170, 172
Telephone 201, 202
Temperature adjustment 55
Temperature control for heated
 seats..... 60
Temporary tyre repair kit..... 136
Third brake lamp 149
Time 38, 204, 226, 227
TMC (Traffic info) 195
Tools 141
Total distance recorder 38
Towbar 163
Towed loads..... 168, 171, 174
Towing another vehicle 162
- T** Traction control (ASR)..... 103
Traffic information
 (TA) 196, 218
Traffic information
 (TMC)..... 195, 196
Trip computer 40-42, 45
Trip distance recorder 38
Tyre pressures 177
Tyres 21
- U** Unlocking 64
Unlocking from the inside..... 71
Update risk areas 194
Updating the date..... 204, 226, 227
Updating
 the time 38, 204, 226, 227
USB Box..... 88, 220
USB player 88, 220
- V** Ventilation 50-52
- W** Warning lamps 25-34
Wash-wipe, rear 82
Weights 168, 171, 174
Window controls 68
Wiper, rear 82
Wiper control stalk..... 81-83
Wipers 81-83
- Z** Zenith windscreen 6











A series of ten horizontal lines spaced evenly down the page, providing a guide for handwriting practice. The lines are parallel and extend across most of the page width.



This handbook describes all of the equipment available in the whole range.

Your vehicle will be fitted with some of this equipment described in this document, depending on its trim level, version and the specification for the country in which it is sold.

The descriptions and illustrations are given without any obligation. Automobiles CITROËN reserves the right to modify the technical specifications, equipment and accessories without having to update this edition of the handbook.

This document is an integral part of your vehicle. It should be passed on to the new user in the event of sale or transfer.

For any work on your vehicle, use a qualified workshop that has the technical information, competence and equipment required, which a CITROËN dealer is able to provide.

Automobiles CITROËN declares, by application of the provisions of the European regulation (Directive 2000/53) relating to End of Life Vehicles, that it achieves the objectives set by this regulation and that recycled materials are used in the manufacture of the products that it sells.

Reproduction or translation of all or part of this handbook is prohibited without written authorisation from Automobiles CITROËN.

Printed in the EU
Anglais

06-11

Automobiles CITROËN

Siège social : 6 rue Fructidor - 75835 Paris Cedex 17 - France

TÉL. : +33 (0) 1 58 79 79 79 - www.citroën.fr

S.A. au capital de 16 000 000 € - R.C.S. Paris 642 050 199 - Siret 642 050 199 00990 - APE 741 J



11A51.0040

Anglais

2011 – DOCUMENTATION DE BORD
4Dconcept
Diadeis
Edipro