

# MY PEUGEOT 2008

HANDBOOK



Download on the  
App Store

GET IT ON  
Google Play



PEUGEOT

# Access to the Handbook



## MOBILE APPLICATION

Install the **Scan MyPeugeot App** (content available offline).



Then select:

- the vehicle,
- the issue period corresponding to the vehicle's initial registration date.



## ONLINE

Visit the **PEUGEOT** website and select the **'MyPeugeot'** section to view or download the handbook or go to the following address:

<http://public.servicebox.peugeot.com/APddb/>



Scan this QR Code for direct access.

Select:

- the language,
- the vehicle and body style,
- the issue period of the handbook corresponding to the vehicle's initial registration date.



This symbol indicates the latest information available.

# Welcome

---

Thank you for choosing a Peugeot 2008 or a Peugeot e-2008.

This document presents the key information and recommendations required for you to be able to explore your vehicle in complete safety. We strongly recommend familiarising yourself with this document and the Warranty and Maintenance Record.

Your vehicle will be fitted with only some of the equipment described in this document, depending on its trim level, version and the specification for the country in which it was sold.

The descriptions and illustrations are for guidance only.

Automobiles PEUGEOT reserves the right to modify the technical specifications, equipment and accessories without having to update this guide.

If ownership of your vehicle is transferred, please ensure this **Handbook** is passed on to the new owner.

## Key



Safety warning



Additional information



Environmental protection feature



Left-hand drive vehicle



Right-hand drive vehicle



Location of the equipment / button described using a black area.



	<b>Overview</b>	■	Heating and Ventilation	45	Hill Assist Descent Control	69	
			Manual air conditioning	46	Seat belts	71	
	<b>Eco-driving</b>	■	Automatic air conditioning	46	Airbags	72	
			Front demisting - defrosting	48	Child seats	75	
			Heated windscreen	49	Deactivating the front passenger airbag	77	
	<b>Instruments</b>	<b>1</b>	Rear screen demisting/defrosting	49	ISOFIX child seats	77	
Instrument panels		9	Remote-controlled heating and		i-Size child seats	79	
Warning and indicator lamps		12	air conditioning (Electric)	49	Installing child seats	79	
Indicators		19	Interior fittings	50	Child lock	82	
Manual test		23	Courtesy lamps	52			
Total distance recorder		23	Interior ambience lighting	53	<b>Driving</b>	<b>6</b>	
Lighting dimmer		23	Boot fittings	53	Driving recommendations	84	
Trip computer		24			Starting / Switching off the engine		
Touch screen		25	<b>Lighting and visibility</b>	<b>4</b>	with the key	86	
Remotely operable features (Electric)		27	Exterior lighting control stalk	55	Starting / Switching off the engine		
			Direction indicators	56	with Keyless Entry and Starting	87	
	<b>Access</b>	<b>2</b>	Headlamp beam height adjustment	57	Manual parking brake	89	
Remote control / Key		28	Automatic illumination of headlamps	57	Electric parking brake	89	
Proximity Keyless Entry and Start		30	Guide-me-home and welcome lighting	58	6-speed manual gearbox	92	
Central locking		32	Automatic headlamp dipping	58	Automatic gearbox (EAT6)	92	
Back-up procedures		32	Cornering lighting	59	Automatic gearbox (EAT8)	94	
Doors		34	Wiper control stalk	60	Drive selector (Electric)	97	
Boot		35	Changing a wiper blade	62	Driving modes	98	
Alarm		35	Automatic wipers	62	Hill start assist	98	
Electric windows		37			Gear efficiency indicator	99	
Sunroof		38			Stop & Start	99	
	<b>Ease of use and comfort</b>	<b>3</b>		<b>Safety</b>	<b>5</b>	Under-inflation detection	101
PEUGEOT i-Cockpit		40	General safety recommendations	64	Driving and manoeuvring aids - General		
Front seats		40	Hazard warning lamps	64	recommendations	102	
Steering wheel adjustment		42	Horn	65	Speed Limit Recognition		
Mirrors		42	Pedestrian horn (Electric)	65	and Recommendation	104	
Rear bench seat		43	Emergency or assistance call	65	Speed limiter	107	
			Electronic stability control (ESC)	67	Cruise control - particular recommendations	109	
			Advanced Grip Control	69	Cruise control	109	

Drive Assist Plus	111
Adaptive Cruise Control	111
Active Lane Keeping Assist	114
Active Lane Keeping Assistance	118
Active Blind Spot Monitoring System	121
Active Safety Brake with Distance Alert and Intelligent emergency braking assistance	122
Distraction detection	125
Parking sensors	126
Visiopark 1	127
Park Assist	130
Full Park Assist	133

### Practical information 7

Compatibility of fuels	138
Refuelling	138
Misfuel prevention (Diesel)	139
Charging system (Electric)	139
Charging the traction battery (Electric)	143
Towing device	146
Towing device with quickly detachable towball	147
Roof bars	149
Snow chains	150
Very cold climate screen	151
Energy economy mode	152
Bonnet	152
Engine compartment	153
Checking levels	154
Checks	156
AdBlue® (BlueHDi)	158
Free-wheeling	159
Advice on care and maintenance	160

### In the event of a breakdown 8

Warning triangle	162
Running out of fuel (Diesel)	162
Tool kit	162
Temporary puncture repair kit	164
Spare wheel	166
Changing a bulb	169
Changing a fuse	171
12 V battery / Accessory battery	176
Towing the vehicle	179

### Technical data 9

Engine technical data and towed loads	181
Petrol engines	182
Diesel engines	184
Electric motor	185
Dimensions	186
Identification markings	186

### PEUGEOT Connect Radio 10

First steps	187
Steering mounted controls	188
Menus	189
Applications	190
Radio	190
DAB (Digital Audio Broadcasting) radio	192
Media	192
Telephone	194
Settings	197
Frequently asked questions	199

### PEUGEOT Connect Nav 11

First steps	201
Steering mounted controls	202
Menus	202
Voice commands	204
Navigation	207
Connected navigation	210
Applications	212
Radio	215
DAB (Digital Audio Broadcasting) radio	216
Media	217
Telephone	218
Settings	221
Frequently asked questions	223

### Alphabetical index ■

### Access to additional videos



## Instruments and controls

These illustrations and descriptions are intended as a guide. The presence and location of certain elements may vary, depending on the version or trim level.

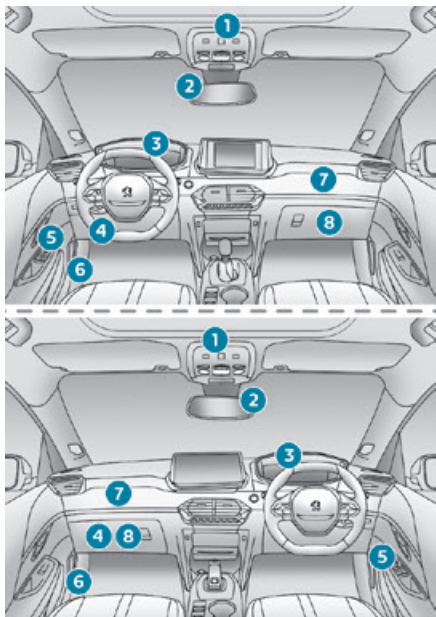

1. Courtesy lamp/Front reading lamps  
Emergency and assistance call buttons  
Sunroof  
Warning lamps display for seat belts and front passenger airbag
2. Interior rear view mirror
3. Instrument panel
4. Fusebox
5. Electric windows  
Electric door mirrors
6. Bonnet release
7. Front passenger airbag
8. Glove box

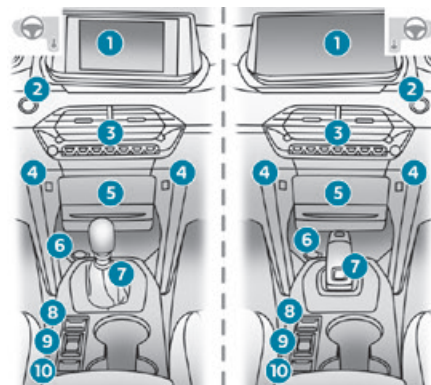

1. Touch screen
2. Switching the engine on/off
3. Central controls
4. USB socket(s)

5. Storage compartment or Wireless smartphone charger
6. Storage compartment/12 V socket
7. Gearbox or drive selector  
Full Park Assist
8. Electric parking brake
9. Choice of driving mode  
Advanced Grip Control
10. Hill Assist Descent Control

### Steering-mounted controls

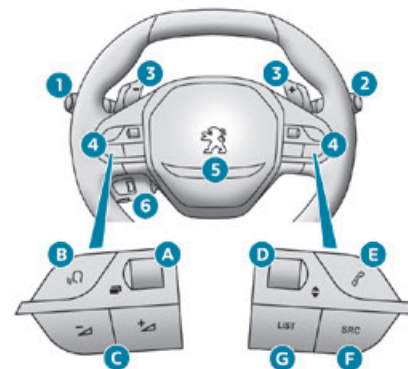

1. Exterior lighting controls/Direction indicators/  
Service indicator
2. Wiper controls/Screenwash/Trip computer
3. Automatic gearbox control paddles
4. Audio system controls
- A. Select the instrument panel display mode

- B. Voice commands
- C. Decrease/Increase volume
- D. Select previous/next media  
Confirm a selection
- E. Access the **Telephone** menu  
Manage calls
- F. Select an audio source
- G. Display the list of radio stations/audio tracks
- 5. Horn/Driver front airbag
- 6. Cruise control/speed limiter/Adaptive Cruise Control

### Side controls



- 1. Halogen or LED technology headlamp beam height adjustment
- 2. Active lane departure warning system
- 3. Lane positioning assist
- 4. Heated windshield
- 5. Alarm
- 6. Electric child lock

### Central controls

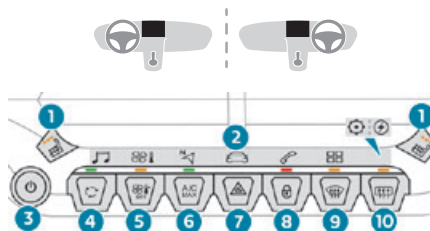

- 1. Heated seats
- 2. Access the touch screen menus
- 3. Touch screen on/off/Adjust volume
- 4. Interior air recirculation
- 5. Air conditioning off
- 6. Maximum air conditioning
- 7. Hazard warning lamps
- 8. Central locking
- 9. Front demisting/defrosting
- 10. Rear screen defrosting

### Electric motor

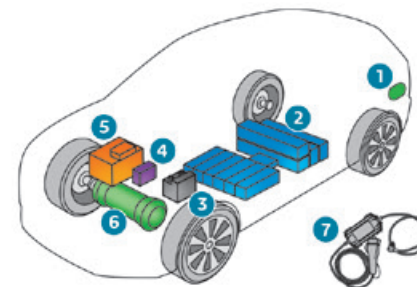

- 1. Charging connectors
- 2. Traction battery
- 3. Accessory battery
- 4. Heat pump
- 5. On-board charger
- 6. Electric motor
- 7. Charging cable with integrated control unit

The charging connectors **1** enable 3 types of charging:

- Domestic charging, via a mains power socket and the supplied cable **7**.
- Accelerated charging, using a Wallbox accelerated charging unit and the corresponding cable.
- Fast charging, using a fast public charger and the corresponding cable.

The 400 V traction battery **2** uses Lithium-Ion technology. It stores and subsequently supplies electric energy to power the electric motor,

heating and air conditioning systems. Its charge level is represented by bars on a gauge, and there is a reserve power warning lamp on the instrument panel.

The 12 V accessory battery **3** powers the vehicle's conventional electrical system. It is used to start the electric motor. This battery is automatically recharged by the traction battery.

The heat pump **4** provides passenger compartment heating and regulates traction battery and on-board charger cooling.

The on-board charger **5** manages traction battery domestic and accelerated charging.

The electric motor **6** provides motive power, based on the selected driving mode and the driving conditions. It recovers energy during vehicle braking and deceleration phases.



## Eco-driving

Eco-driving refers to a range of everyday practices that allow the motorist to optimise their energy consumption (fuel and/or electricity) and CO<sub>2</sub> emissions.

### Optimise your use of the gearbox

With a manual gearbox, move off gently and change up promptly. While accelerating, change up early.

With an automatic gearbox, favour automatic mode and avoid pressing the accelerator pedal heavily or suddenly.

The gear shift indicator prompts you to engage the most suitable gear: whenever this indication is displayed on the instrument panel, follow it straight away.

With an automatic gearbox, this indicator appears only in manual mode.

### Drive smoothly

Maintain a safe distance between vehicles, use engine braking rather than the brake pedal and press the accelerator gradually. These practices help to save on energy consumption, reduce CO<sub>2</sub> emissions and decrease general traffic noise.

If the vehicle has the steering-mounted "CRUISE" control, use cruise control at speeds above 25 mph (40 km/h) when traffic is flowing smoothly.

### Control the use of electrical equipment

Before moving off, if the passenger compartment is too warm, ventilate it by opening the windows and air vents before using the air conditioning. At speeds above 31 mph (50 km/h), close the windows and leave the air vents open.

Consider using equipment that can help keep the temperature in the passenger compartment down (sunroof blind and window blinds, etc.). Unless automatically regulated, switch off the air conditioning as soon as the desired temperature has been reached.

Switch off the demisting and defrosting functions, if they are not managed automatically.

Switch off the heated seat as soon as possible.

Switch off the headlamps and foglamps when the visibility conditions do not require their use.

Avoid running the engine before moving off, particularly in winter (other than in severe wintry conditions: temperature below -23°C); your vehicle will warm up much faster while driving.

As a passenger, avoid connecting your multimedia devices (film, music, video game, etc.) to help reduce consumption of energy.

Disconnect all portable devices before leaving the vehicle.

### Limit the causes of excess consumption

Spread loads throughout the vehicle; place the heaviest items in the boot, as close as possible to the rear seats.

Limit the loads carried in the vehicle and minimise wind resistance (roof bars, roof rack,

bicycle carrier, trailer, etc.). Preferably, use a roof box.

Remove roof bars and roof racks after use.

At the end of winter, remove snow tyres and refit summer tyres.

### Comply with the servicing instructions

Check tyre pressures regularly, with the tyres cold, referring to the label in the door aperture on the driver's side.

Carry out this check in particular:

- before a long journey.
- at each change of season.
- after a long period out of use.

Do not forget the spare wheel and, where applicable, the tyres on your trailer or caravan. Have your vehicle serviced regularly (engine oil, oil filter, air filter, passenger compartment filter, etc.) and observe the schedule of operations in the manufacturer's service schedule.

With a BlueHDi Diesel engine, if the SCR system is faulty, your vehicle will emit pollution. Visit a PEUGEOT dealer or a qualified workshop as soon as possible to restore your vehicle's nitrogen oxide emissions to legal levels.

When filling the fuel tank, do not continue after the third cut-out of the nozzle, to avoid overflow. You will only see the fuel consumption of your new vehicle settle down to a consistent average after the first 1,900 miles (3,000 kilometres).

### **Optimise the driving range (electric vehicles)**

The vehicle's electrical consumption depends heavily on the route, the vehicle speed and your driving style.

Try to remain in the "**ECO**" zone on the power indicator, by driving smoothly and maintaining a steady speed.

Anticipate the need to slow down, and brake smoothly, whenever possible using engine braking with the regenerative braking function, which will move the power indicator into the "**CHARGE**" zone.

## LCD instrument panel

### Dials



1. Analogue speedometer (mph or km/h)
2. LCD display
3. Rev counter (x 1,000 rpm), graduation depends on the engine (Petrol or Diesel)

### LCD display

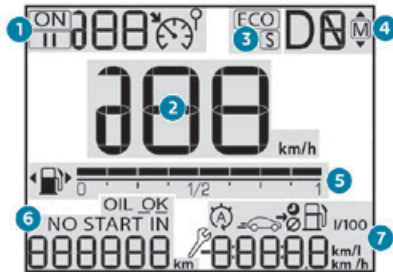

1. Cruise control/speed limiter settings
2. Digital speedometer (mph or km/h)
3. Driving mode selected
4. Gear shift indicator  
Selector position and gear on automatic gearbox
5. Fuel gauge
6. NO START IN
7. Rev counter (x 1000 rpm), graduation depends on the engine (Petrol or Diesel)

5. Fuel gauge
6. Engine oil level indicator (depending on engine)  
Service indicator, then total distance recorder (miles or km)  
These functions are displayed in turn when the ignition is switched on.
7. Trip computer information

## Matrix instrument panel

### Dials

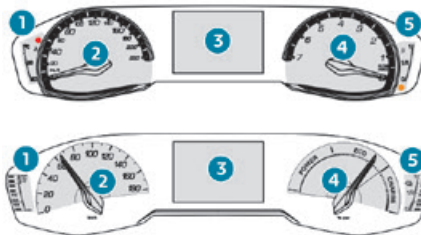

1. Coolant temperature indicator (°C) (Petrol or Diesel)  
Thermal comfort consumption indicator (Electric)
2. Analogue speedometer (mph or km/h)
3. Matrix display
4. Rev counter (x 1000 rpm), graduation depends on the engine (Petrol or Diesel)  
Power indicator (Electric)

5. Fuel gauge (Petrol or Diesel)  
Charge level indicator (Electric)

### Matrix display

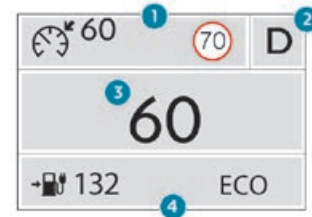
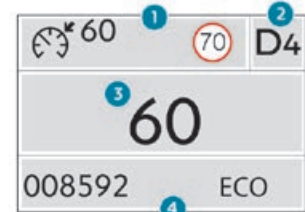

1. Cruise control / speed limiter settings  
Display of speed limit signs
2. Gear shift indicator (arrow and recommended gear)  
Selector position and gear on automatic gearbox (Petrol or Diesel)  
Drive selector position (Electric)
3. Digital speedometer (mph or km/h)
4. Fuel gauge

3. Digital speedometer (mph or km/h)
  - Display of driving aids
  - Trip computer information
  - Power flow / vehicle charge state (Electric)
4. Service indicator, then total distance recorder (miles or km)
  - Remaining range (Electric)
  - These functions are displayed in turn when the ignition is switched on.
  - Driving mode selected (other than "Normal" mode)

## Digital instrument panel

This head-up 3D digital instrument panel can be customised.

Depending on the display mode selected, certain information is hidden or presented differently.

Example with the "DIALS" display mode:



1. Fuel gauge (Petrol or Diesel)
  - Charge level indicator (Electric)
2. Remaining range (miles or km)
3. Cruise control/speed limiter settings
  - Display of speed limit signs
4. Digital speedometer (mph or km/h)
5. Total distance recorder (miles or km)
6. Rev counter (x 1,000 rpm) (Petrol or Diesel)
  - Power indicator (Electric)
7. Gear shift indicator (arrow and recommended gear)
  - Selector position and gear on automatic gearbox (Petrol or Diesel)
  - Drive selector position (Electric)
  - Driving mode selected (other than "Normal" mode)
8. Coolant temperature indicator (°C) (Petrol or Diesel)
9. Analogue speedometer (mph or km/h) (Petrol or Diesel)

## Displays

Some lamps have a fixed location, others can change location.

For certain functions that have indicator lamps for both operation and deactivation, there is only one dedicated location.

### Permanent information

In the standard display, the instrument panel shows:

- in fixed locations:

- Information related to the gearbox and gear shift indicator (Petrol or Diesel).
- Information related to the Drive selector position (Electric).
- Fuel gauge (Petrol or Diesel).
- Range (Petrol or Diesel).
- Coolant temperature indicator (Petrol or Diesel).
- Charge level and range indicator (Electric).
- Power indicator (Electric).
- Driving mode.
- in variable locations:
  - Digital speedometer.
  - Total distance recorder.
  - Status or alert messages displayed temporarily.

### Optional information

Depending on the display mode selected and the active features, additional information may be displayed:

- Rev counter (Petrol or Diesel).
- Trip computer.
- Driving aid functions.
- Speed limiter or cruise control.
- Media currently playing.
- Navigation instructions.
- Analogue speedometer.
- Engine information (G-meters, Power-meters, Boost, Torque) in Sport mode.
- Power flow (Electric).

## Customising the instrument panel

Depending on version, the appearance of the instrument panel may be customisable (colour and/or display mode).

### Display language and units

These depend on the touch screen settings.



When travelling abroad, the speed must be shown in the official units of the country you are driving in (mph, miles or km/h, km).

! As a safety measure, these adjustments must be carried out with the vehicle stationary.

## Choosing the display colour

(With PEUGEOT Connect Nav)

Depending on version, the instrument panel display colour depends on the colour scheme chosen in this system.

-  ▶ Press **Settings** in the banner of the touch screen.
-  ▶ Select "**Color schemes**".
-  ▶ Select a display colour and then press "**OK**" to confirm.

## Choosing the display mode

In each mode, specific types of information are displayed on the instrument panel.

## Changing the display mode

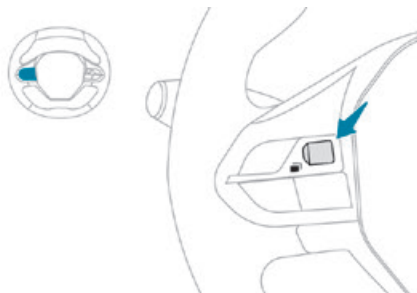

- ▶ Turn the thumbwheel on the left of the steering wheel to display and scroll through the various modes on the instrument panel.
- ▶ Press the thumbwheel to confirm the mode. If you do not press the thumbwheel, the selected display mode is automatically applied after a few moments.



### Presentation of display modes

- "**DIALS**": standard display of analogue and digital speedometers, total distance recorder and:
  - fuel gauge, coolant temperature indicator and rev counter (Petrol or Diesel).
  - battery charge indicator and power indicator (Electric).
- "**NAVIGATION**": specific display, showing the current navigation information (map and instructions).
- "**DRIVING**": specific display, showing the information relating to active driving aid systems.



- "**MINIMAL**": 2D display with digital speedometer, total distance recorder and:
  - fuel gauge and coolant temperature indicator (Petrol or Diesel).
  - battery charge indicator (Electric).
- "**ÉNERGIE**": specific display, showing a visual representation of the vehicle's energy flows (Electric).
- "**PERSONAL 1**"/"**PERSONAL 2**": displays the information selected by the driver in the centre of the instrument panel.

## Configuring a "PERSONAL" display mode

### With PEUGEOT Connect Radio

-  ▶ Press **Settings** in the banner of the touch screen.
-  ▶ Select "**Configuration**".
-  ▶ Select "**Instrument panel personalisation**".

### With PEUGEOT Connect Nav

-  ▶ Press **Settings** in the banner of the touch screen.
- ▶ Select "**OPTIONS**".
-  ▶ Select "**Instrument panel personalisation**".
- ▶ Select "**PERSONAL 1**" or "**PERSONAL 2**".
- ▶ Select the type of information using the scroll arrows on the touch screen:
  - "**Default**" (empty).
  - "**Trip computer**".
  - "**Media**".
  - "**G-metres**" (depending on version).

- **"Power meters + Boost + Torque"** (depending on version).
- **"Energy consumption"** (depending on version).

► Confirm to save and exit.

The information is displayed immediately on the instrument panel if the corresponding display mode is selected.

**i** The type of information selected in the **"PERSONAL 1"** mode is not available in the **"PERSONAL 2"** mode.

## Warning and indicator lamps

Displayed as symbols, the warning and indicator lamps inform the driver of the occurrence of a malfunction (warning lamps) or of the operating status of a system (operation or deactivation indicator lamps). Certain lamps light up in two ways (fixed or flashing) and/or in several colours.

### Associated warnings

The illumination of a lamp may be accompanied by an audible signal and/or a message displayed in a screen.

Relating the type of alert to the operating status of the vehicle allows you to determine whether the situation is normal or whether a fault has occurred: refer to the description of each lamp for further information.

### When the ignition is switched on

Certain red or orange warning lamps come on for a few seconds when the ignition is switched on. These warning lamps should go off as soon as the engine is started.

For more information on a system or a function, refer to the corresponding section.

## Warning lamp continuously lit

The illumination of a red or orange warning lamp indicates the occurrence of a fault that needs further investigation.

### If a warning lamp remains lit

The references **(1)**, **(2)** and **(3)** in the warning and indicator lamp description indicate whether you should contact a qualified professional in addition to the immediate recommended actions.

#### **(1): You must stop the vehicle.**

Stop as soon as it is safe to do so and switch off the ignition.

**(2):** Contact a PEUGEOT dealer or a qualified workshop.

**(3):** Visit a PEUGEOT dealer or a qualified workshop.

## List of warning and indicator lamps

### Red warning/indicator lamps

#### STOP



Fixed, associated with another warning lamp, accompanied by the display of a message and an audible signal.

A serious fault with the engine, braking system, power steering, automatic gearbox or a major electrical fault has been detected.

Carry out (1) and then (2).

#### Engine self-diagnostics system (Petrol or Diesel)



Fixed. A major engine fault has been detected.

Carry out (1) and then (2).

#### Maximum engine coolant temperature



Fixed with display blocks lit in red (with matrix instrument panel).

or

Fixed (except on matrix instrument panel). The cooling system temperature is too high. Carry out (1), then allow the engine to cool before topping up the level, if necessary. If the problem persists, carry out (2).

#### Engine oil pressure (Petrol or Diesel)



Fixed. There is a fault with the engine lubrication system.

Carry out (1) and then (2).

### System malfunction (Electric)



Fixed.

An anomaly involving the electric motor or traction battery has been detected.

Carry out (1) and then (2).

### Cable connected (Electric)



Fixed.

It is not possible to start the vehicle while the charging cable is connected to the vehicle's connector.

Disconnect the charging cable and close the flap.

### 12 V battery charge



Fixed.

The battery charging circuit has a fault (dirty terminals, slack or cut alternator belt, etc.).

Carry out (1).

If the electric parking brake is no longer working, immobilise the vehicle:

- ▶ With the manual gearbox, engage a gear.
- ▶ With the EAT6 automatic gearbox, move the gear selector to position **P**.
- ▶ With the EAT8 automatic gearbox or drive selector, fit the chock against one of the wheels. Clean and tighten the terminals. If the warning lamp does not go off when the engine is started, carry out (2).

### Door(s) open



Fixed, associated with a message identifying the access.

A door or the tailgate is not properly closed (speed less than 6 mph (10 km/h)).



Fixed, associated with a message identifying the access, accompanied by an audible signal.

A door or the tailgate is not properly closed (speed above 6 mph (10 km/h)).

### Seat belts not fastened/unfastened



Fixed or flashing, accompanied by an increasing audible signal.

A seat belt has not been fastened or has been unfastened.

### Manual parking brake



Fixed.

The parking brake is applied or not properly released.

### Electric parking brake



Fixed.

The electric parking brake is applied.



Flashing.

Application/release is faulty.

Carry out (1): park on flat ground (on a level surface).

With a manual gearbox, engage a gear.

With an automatic gearbox or drive selector, select mode **P**.

Switch off the ignition and carry out (2).

### Braking



Fixed.

The brake fluid level in the braking circuit has dropped significantly.

Carry out (1), then top up with fluid that complies with the manufacturer's recommendations. If the problem persists, carry out (2).



Fixed.



The electronic brake force distribution (EBFD) system is faulty. Carry out (1) and then (2).

### Orange warning/indicator lamps

#### Service



Temporarily on, accompanied by the display of a message.

One or more minor faults, for which there is/are no specific warning lamp(s), have been detected. Identify the cause of the fault using the message displayed in the instrument panel.

You can deal with certain problems yourself, for example an open door or the start of saturation of the particle filter.

For other faults, such as with the tyre under-inflation detection system, carry out (3).



Fixed, accompanied by the display of a message.

One or more major faults, for which there is/are no specific warning lamp(s), have been detected. Identify the cause of the fault using the message displayed in the instrument panel, then carry out (3).



Fixed, accompanied by the message

"Parking brake fault".

Automatic release of the electric parking brake is unavailable.

Carry out (2).



Service warning lamp fixed and service spanner flashing then fixed.

The servicing interval has been exceeded.

The vehicle must be serviced as soon as possible.

Only with BlueHDi Diesel engines.

### Engine pre-heating (Diesel)



Temporarily on (up to approximately 30 seconds in severe weather conditions).

When switching on the ignition, if the weather conditions and the engine temperature make it necessary.

Wait until the warning lamp goes off before starting.

When the warning lamp goes off, starting will occur immediately if you press and hold:

- the clutch pedal with a manual gearbox.
- the brake pedal with an automatic gearbox.

If the engine does not start, make the engine starting request again, while keeping your foot on the pedal.

### Particle filter (Diesel)



Fixed, accompanied by an audible signal and a message about the risk of particle filter blockage.

The particle filter is nearing saturation.

As soon as traffic conditions permit, regenerate the filter by driving at a speed of at least 37 mph (60 km/h) until the warning lamp goes off.



Fixed, accompanied by an audible signal and a message indicating that the additive level in the particle filter is too low. The low level in the additive tank has been reached.

Top up without delay: carry out (3).

### Low fuel level (Petrol or Diesel)



Fixed, with the blocks lit red, accompanied by an audible signal (with the matrix instrument panel) or

Fixed, with the reserve level shown in red, accompanied by an audible signal and the display of a message (except with the matrix instrument panel).

When it first comes on, there remains **approximately 5 litres of fuel** in the tank (reserve).

Until the fuel level is topped up, this alert will be repeated every time the ignition is switched on, with increasing frequency as the fuel level decreases and approaches zero.

Refuel without delay to avoid running out of fuel.

**Never drive until completely empty**, as this could damage the emissions control and injection systems.

### Low traction battery level (Electric)



Fixed, accompanied by an audible signal. The state of charge of the traction battery is low.

View the remaining range.

Put the vehicle on charge as soon as possible.

### Limited power (Electric)



Fixed. The state of charge of the traction battery is critical.

The engine power gradually decreases.

You must put the vehicle on charge.

If the warning lamp remains lit, carry out (2).

### Pedestrian horn (Electric)



Fixed. Horn fault detected.

Carry out (3).

### Engine self-diagnostics system (Petrol or Diesel)



Flashing. The engine management system has a fault.

There is a risk that the catalytic converter will be destroyed.

You **must** carry out (2).



Fixed. The emissions control system has a fault. The warning lamp should go off when the engine is started.

Carry out (3) without delay.





Fixed.

A minor engine fault has been detected.

Carry out (3).

### AdBlue® (BlueHDi)



On for around 30 seconds when starting the vehicle, accompanied by a message indicating the driving range.

The driving range is between 1,500 and 500 miles (2,400 and 800 km).

Top up the AdBlue®.



Fixed, on switching on the ignition, accompanied by an audible signal and a message indicating the driving range.

The driving range is between 500 and 62 miles (800 and 100 km).

**Promptly** top up the AdBlue®, or carry out (3).



Flashing, accompanied by an audible signal and a message indicating the driving range.

The driving range is less than 62 miles (100 km).

You **must** top up the AdBlue® to **avoid engine starting being prevented**, or carry out (3).



Flashing, accompanied by an audible signal and a message indicating that starting is prevented.

The AdBlue® tank is empty: the regulatory engine immobiliser prevents the engine from being restarted.

To restart the engine, top up the AdBlue®, or carry out (2).

You **must** add at least 5 litres of AdBlue® to its tank.

### SCR emissions control system (BlueHDi)



Fixed when the ignition is switched on, accompanied by an audible signal and a message.

A malfunction involving the SCR emissions control system has been detected.

This alert disappears once the exhaust emissions return to normal levels.



Flashing AdBlue® warning lamp on switching on the ignition, with the Service and Engine self-

diagnostics warning lamps on fixed, accompanied by an audible signal and a message indicating the driving range.

Depending on the message displayed, it may be possible to drive for up to 685 miles (1,100 km) before the engine immobiliser is triggered.

Carry out (3) without delay, to **avoid starting being prevented**.



Flashing AdBlue® warning lamp on switching on the ignition, with the Service and Engine self-

diagnostics warning lamps on fixed, accompanied by an audible signal and a message indicating that starting is prevented.

The engine immobiliser prevents the engine from restarting (over the authorised driving limit after confirmation of an emissions control system malfunction).

To start the engine, carry out (2).

### Deactivation of the automatic functions (with electric parking brake)



Fixed.

The "automatic application" (on switching off the engine) and "automatic release" (on acceleration) functions are deactivated. If automatic application/release is no longer possible:

- ▶ Start the engine.
- ▶ Use the control lever to apply the parking brake.
- ▶ Take your foot fully off the brake pedal.
- ▶ Hold the control lever pressed in the release direction for between 10 and 15 seconds.
- ▶ Release the control lever.
- ▶ Depress and hold the brake pedal.
- ▶ Hold the control lever in the "Application" direction for 2 seconds.
- ▶ Release the control lever and the brake pedal.

### Malfunction (with electric parking brake)



Fixed, accompanied by the message "Parking brake fault".

The vehicle cannot be immobilised with the engine running.

If manual application and release commands are not working, the electric parking brake control lever is faulty.

The automatic functions must be used at all times and are automatically re-enabled in the event of a control lever fault.

Carry out (2).



Fixed, accompanied by the

message "Parking brake fault".

The parking brake is faulty: manual and automatic functions may not be working. When stationary, to immobilise the vehicle:

- Pull and hold the control lever for approximately 7 to 15 seconds, until the indicator lamp comes on on the instrument panel. If this procedure does not work, secure the vehicle:

- Park on a level surface.
  - With a manual gearbox, engage a gear.
  - With an automatic gearbox or drive selector, select **P**, then place the supplied chock against one of the wheels.
- Then carry out (2).

#### Distance Alert / Active Safety Brake



Fixed, accompanied by the display of a message.

The system has been deactivated via the touch screen ( **Driving/ Vehicle** menu).

#### Distance Alert/Active Safety Brake



Flashing.

The system activates and brakes the vehicle momentarily so as to reduce the speed of collision with the vehicle ahead.



Fixed, accompanied by a message and an audible signal.

The system has a fault.

Carry out (3).

#### Distance Alert / Active Safety Brake



Fixed.

The system has a fault.

If these warning lamps come on after the engine is switched off and then restarted, carry out (3).

#### Anti-lock braking system (ABS)



Fixed.

The anti-lock braking system has a fault. The vehicle retains conventional braking.

Drive carefully at moderate speed, then carry out (3).

#### Power steering



Fixed.

The power steering has a fault.

Drive carefully at moderate speed, then carry out (3).

#### Dynamic stability control (DSC)/Anti-slip regulation (ASR)



Fixed.

The system is deactivated.

The DSC/ASR system is reactivated automatically when the vehicle is restarted, and from around 31 mph (50 km/h).

Below 31 mph (50 km/h), it can be reactivated manually.



Flashing.

The DSC/ASR adjustment is activated if there is a loss of grip or trajectory.



Fixed.

The DSC/ASR system has a fault.

Carry out (3).

#### Emergency brake malfunction (with electric parking brake)



Fixed, accompanied by the message "Parking brake fault".

Emergency braking does not deliver optimal performance.

If automatic release is not available, use manual release or carry out (3).

#### Hill start assist



Fixed, accompanied by the message "Anti roll-back system fault".

The system has a fault.

Carry out (3).

#### Active Lane Keeping Assistance



Fixed.

The system has been automatically deactivated or placed on standby.



Flashing.

You are about to cross a broken lane marking without operating the direction indicators.

The system is activated, then corrects the trajectory on the side of the lane marking detected.



Fixed.

The system has a fault.

Carry out (3).

#### Lane positioning assist



Fixed, accompanied by the Service warning lamp.

The system has a fault.

Carry out (3).

### Airbags



Fixed.

One of the airbags or seat belt pretensioners is faulty.  
Carry out (3).

### Front passenger airbag (ON)



Fixed.

The front passenger airbag is activated.  
The control is in the "ON" position.

**In this case, do NOT install a "rearward facing" child seat on the front passenger seat - Risk of serious injury!**

### Front passenger airbag (OFF)



Fixed.

The front passenger airbag is deactivated.  
The control is in the "OFF" position.  
A "rearward facing" child seat can be installed, unless there is a fault with the airbags (Airbags warning lamp on).

### Parking sensors



Fixed, accompanied by the display of a message and an audible signal.

The system has a fault.  
Carry out (3).

### Under-inflation



Fixed.

The pressure in one or more tyres is too low.

Check the pressure of the tyres as soon as possible.

Reinitialise the detection system after adjusting the pressure.



Under-inflation warning lamp flashing then fixed and Service warning lamp fixed.

The tyre pressure monitoring system is faulty. Under-inflation detection is no longer monitored. Check the tyre pressures as soon as possible and carry out (3).

### Stop & Start (Petrol or Diesel)



Fixed, accompanied by the display of a message.

The Stop & Start system has been deactivated manually.

The engine will not switch off at the next traffic stop.



Fixed.

The Stop & Start system has been deactivated automatically.

The engine will not switch off at the next traffic stop, if the exterior temperature is:

- below 0°C.
- above +35°C.



Flashing then fixed, accompanied by a message.

The system has a fault.  
Carry out (3).

### Rear foglamps



Fixed.

The lamps are on.

## Green warning/indicator lamps

### Hill Assist Descent Control



Fixed.

(grey)

The function has been activated, but is currently paused because the speed is too high. Reduce the vehicle speed to below 19 mph (30 km/h).



Fixed.

The system has been activated, but the conditions for regulation are not met (gradient, speed too high, gear engaged).



Flashing.

The function is regulating the speed of the vehicle.

The vehicle is being braked; the brake lamps come on during the descent.

### Stop & Start (Petrol or Diesel)



Fixed.

When the vehicle stops, the Stop & Start puts the engine into STOP mode.



Flashing temporarily.

STOP mode is momentarily unavailable or START mode is automatically triggered.

### Vehicle ready to drive (Electric)



Fixed, accompanied by an audible signal when it comes on.

The vehicle is ready to drive and the thermal comfort systems are available.

The indicator lamp goes out upon reaching a speed of approximately 3 mph (5 km/h) and lights up again when the vehicle stops moving. The lamp will go out when you turn off the engine and exit the vehicle.

### Park Assist or Full Park Assist



Fixed.  
The function is active.

### Active Lane Keeping Assist



Fixed.  
The function has been activated.

All the conditions have been met: the system is operating.

### Automatic wiping



Fixed.  
Automatic windscreen wiping is activated.

### Direction indicators



Flashing with audible signal.  
The direction indicators are on.

### Daytime running lamps/Sidelamps



Fixed.  
With adequate ambient light, the daytime running lamps are on.  
With inadequate ambient light, the sidelamps are on.

### Dipped beam headlamps



Fixed.  
The lamps are on.

### Automatic headlamp dipping



Fixed.  
The function has been activated via the touch screen (**Driving / Vehicle** menu).

The lighting control stalk is in the "AUTO" position.

### Front foglamps



Fixed.  
The front foglamps are on.

### Blue warning/indicator lamps



Fixed.  
The lamps are on.

### Black/white warning lamps



Fixed (with LCD instrument panels).  
Stop & Start: the change to START mode is rejected because the clutch pedal is not fully depressed.

Fully depress the clutch pedal.

### Foot on the brake



Fixed.  
Omission or insufficient pressure on the brake pedal.

With the EAT6 automatic gearbox, with the engine running, before releasing the parking brake, to move out of position **P**.

With the EAT8 automatic gearbox or the drive selector, it may be necessary to depress the brake pedal to unlock the gearbox from mode **N**. This warning lamp will remain on if you attempt to release the parking brake without depressing the brake pedal.

### Automatic gearbox (EAT8) or Drive selector (Electric)



Fixed.  
The automatic gearbox is locked.

The drive selector is locked.  
You must press the **Unlock** button to unlock it.

### Water in Diesel fuel filter (Diesel)



Fixed (with LCD instrument panels).  
The Diesel fuel filter contains water.

Carry out (2) without delay. Risk of damaging the fuel injection system!

## Indicators

### Service indicator

The servicing information is expressed in terms of distance (kilometres or miles) and time (months or days).

The alert is given at whichever of these two terms is reached first.

The servicing information is displayed in the instrument panel. Depending on the version of the vehicle:

- The distance recorder display line indicates the distance remaining before the next service is due, or the distance travelled since it was due preceded by the "-" sign.
- An alert message indicates the distance remaining, as well as the period before the next service is due or how long it is overdue.

- i** The value indicated is calculated according to the distance covered and the time elapsed since the last service. The alert may also be triggered close to a due date.

### Service spanner



On temporarily when the ignition is switched on.

Between 620 and 1,860 miles (1,000 and 3,000 km) remain before the next service is due.



Fixed, when the ignition is switched on. The next service is due in less than 620 miles (1,000 km).

Have your vehicle serviced very soon.

### Service spanner flashing



Flashing then fixed, when the ignition is switched on.

(With BlueHDi Diesel engines, combined with the Service warning lamp.)

The servicing interval has been exceeded.

Have your vehicle serviced as soon as possible.

### Resetting the service indicator

The service indicator must be reset after each service.

If you have serviced your vehicle yourself:

- ▶ Switch off the ignition.

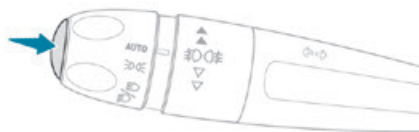

- ▶ Press and hold the button located on the end of the **lighting control stalk**.
- ▶ With no action on the brake pedal, press the **START/STOP** button once; a temporary display window appears and a countdown begins.
- ▶ When the display indicates =0, release the lighting control stalk button; the spanner symbol disappears.

- i** If you disconnect the battery following this operation, lock the vehicle and wait at least 5 minutes for the reset to be registered.

### Reminder of the servicing information



You can view the servicing information by pressing the **"Check"** button in the **Driving/Vehicle** touch screen menu.

### Engine oil level indicator

(Depending on version.)

On versions fitted with an electric gauge, the engine oil level status is displayed on the instrument panel for a few seconds when the ignition is switched on, after the servicing information.

- i** The level read will only be correct if the vehicle is on level ground and the engine has been off for more than 30 minutes.

### Oil level incorrect

This is indicated, depending on the instrument panel, by the display of **"OIL"** or by the message **"Oil level incorrect"**, accompanied by the lighting of the Service warning lamp and an audible signal.

If the low oil level is confirmed by a check using the dipstick, the level must be topped up to avoid damage to the engine.

For more information on **Checking levels**, refer to the corresponding section.

### Gauge fault

This is indicated, depending on the instrument panel, by the display of **"OIL\_\_"** or by the message **"Oil level measurement invalid"**,

accompanied by the lighting of the Service warning lamp and an audible signal.  
Contact a PEUGEOT dealer or a qualified workshop.

**!** In the event of a fault with the electric gauge, the oil level is no longer monitored.  
If the system is faulty, you must check the engine oil level using the manual dipstick located under the bonnet.  
For more information on **Checking levels**, refer to the corresponding section.

## Engine coolant temperature indicator

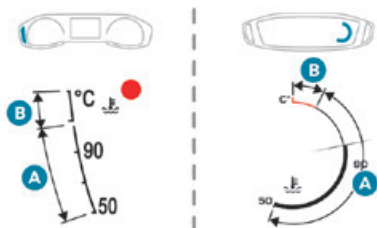

With the engine running:

- In zone **A**, the temperature is correct.
- In zone **B**, the temperature is too high; the associated warning lamp and the central **STOP** warning lamp come on in red on the instrument panel, accompanied by the display of a message and an audible signal.

**You must stop the vehicle as soon as it is safe to do so.**

Wait a few minutes before switching off the engine.

**!** After switching off the ignition, carefully open the bonnet and check the coolant level.

**i** For more information on **Checking levels**, refer to the corresponding section.

## AdBlue® range indicators (BlueHDi)

The Diesel BlueHDi engines are equipped with a system that associates the SCR (Selective Catalytic Reduction) emissions control system and the Diesel particle filter (DPF) for the treatment of exhaust gases. They cannot function without AdBlue® fluid.

When the level of AdBlue® falls below the reserve level (between 1,500 and 0 miles (2,400 and 0 km)), a warning lamp lights up when the ignition is switched on and an estimate of the distance that can be travelled before engine starting is prevented is displayed in the instrument panel.

**!** The engine starting prevention system required by regulations is activated automatically once the AdBlue® tank is empty.

It is then no longer possible to start the engine until the minimum level of AdBlue® has been topped up.

## Manual display of the range

While the driving range is greater than 1,500 miles (2,400 km), it is not displayed automatically.







You can view the range information by pressing the "**Check**" button in the **Driving/Vehicle** touch screen menu.

## Actions required related to a lack of AdBlue®

The following warning lamps light up when the quantity of AdBlue® is lower than the reserve level corresponding to a range of 1,500 miles (2,400 km).



Together with the warning lamps, messages regularly remind you of the need to top up to avoid engine starting being prevented. Refer to the **Warning and indicator lamps** section for details of the messages displayed.

**i** For more information on **AdBlue® (BlueHDi engines)**, and in particular on topping up, refer to the corresponding section.

Warning lamps lit	Action	Remaining driving range
	Top up.	Between 1,500 miles and 500 miles (2,400 km and 800 km)
	Top up as soon as possible.	Between 500 miles and 62 miles (800 km and 100 km)
	<b>A top-up is essential</b> , due to the risk that the engine will be prevented from starting.	Between 62 miles and 0 miles (100 km and 0 km)
	To be able to restart the engine, add at least 5 litres of AdBlue® to its tank.	0 miles (km)

## Malfunction of the SCR emissions control system

### Malfunction detection

  	If a malfunction is detected, these warning lamps come on, accompanied by an audible signal and an "Emissions fault" or "NO START IN" message.
---	--

The alert is triggered while driving, when the fault is detected for the first time, and thereafter when switching on the ignition for subsequent journeys, while the cause of the fault persists.

**i** If the fault is temporary, the alert disappears during the next journey, after self-diagnostic checks of the SCR emissions control system.

### Malfunction confirmed during the permitted driving phase (between 685 miles and 0 miles (1,100 km and 0 km))

If the fault indication is still displayed permanently after 31 miles (50 km) of driving, the fault in the SCR system is confirmed.

The AdBlue warning lamp flashes, and an "Emissions fault: Starting prevented in X miles" or "NO START IN X miles" message is displayed, indicating the driving range in miles or kilometres.

While driving, the message is displayed every 30 seconds. The alert is repeated when switching on the ignition.

You can continue driving for up to 685 miles (1,100 km) before the **engine immobiliser** system is triggered.

**!** Have the system checked by a PEUGEOT dealer or a qualified workshop as soon as possible.

### Starting prevented

Whenever the ignition is switched on, the "Emissions fault: Starting prevented" or "NO START IN" message is displayed.

**!** To be able to restart the engine, contact a PEUGEOT dealer or a qualified workshop.

## Power indicator (Electric)

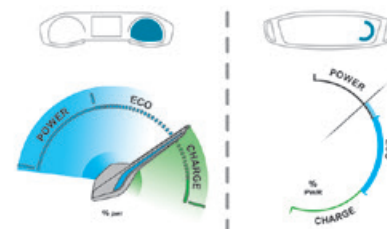

### CHARGE

Traction battery charging during deceleration and braking.

### ECO

Moderate energy consumption and optimised driving range.

### POWER

Energy consumption by the drive train during acceleration.

### NEUTRAL

On switching on the ignition, your vehicle's electric drive train neither consumes nor generates energy: after sweeping over the indicator, the needle or the cursor returns to its "neutral" position.

**i** With the ignition off, opening the driver's door activates the indicator, which moves to the "neutral" position.

## Charge level indicator (Electric)

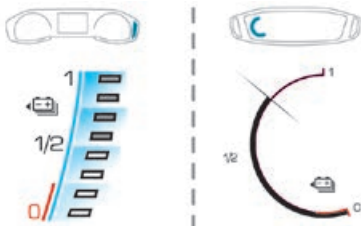

The traction battery charge status and remaining range are displayed continuously when the vehicle is started.

**i** With the ignition off, opening the driver's door activates the indicator.

### Associated warning lamps

Two successive alert levels indicate that the energy available has dropped to a low level:

#### 1st level: Reserve

 The state of charge of the traction battery is low.

Fixed, accompanied by an audible signal.

▶ View the remaining range on the instrument panel.

▶ Put the vehicle on charge as soon as possible.

#### 2nd level: Critical

 The state of charge of the traction battery is critical.

Fixed, together with the reserve warning lamp, accompanied by an audible signal.

▶ You must put the vehicle on charge.

**!** The remaining range is no longer calculated. The drive train power gradually decreases. The heating and air conditioning are switched off (even if the needle or cursor indicating their consumption is not at the **ECO** position).

## Thermal comfort consumption indicator (Electric)



The gauge shows the consumption of electric power for thermal comfort functions.

It concerns the following equipment and systems:

- Heating.
- Air conditioning.
- Front demisting/defrosting.
- Rear screen demisting/defrosting.
- Heated seats.

The traction battery powers the heating and air conditioning systems.

This equipment and these functions can be used:

– If the vehicle is not plugged in, when the **READY** lamp is lit.

– If the vehicle is plugged in, when the ignition is switched on.

Selecting **Eco** mode limits the performance of some equipment. The needle or cursor on the



thermal comfort consumption indicator then moves into the "ECO" zone.

**i** To quickly heat or cool the passenger compartment, feel free to temporarily select the maximum heating or cooling setting.

Excessive use of thermal comfort equipment, particularly at low speed, can significantly decrease the vehicle's range.

Remember to optimise equipment settings upon achieving the desired level of comfort, and adjust them if necessary whenever you start the vehicle.

After an extended period without using the heating, you may notice a slight odour during the first few minutes of use.

## Manual test

This function allows you to check certain indicators and display the alerts log.

 It can be accessed via the "Check" button in the **Driving/Vehicle** touch screen menu.

The following information is displayed on the instrument panel:

- Engine oil level.
- Next service due.
- Tyre pressures.
- Driving range associated with the AdBlue and the SCR system (BlueHDi Diesel).
- Current alerts.

**i** This information is also displayed automatically every time the ignition is switched on.

## Total distance recorder

The total distance recorder measures the total distance travelled by the vehicle since its initial registration.

With the ignition on, the total distance is displayed at all times. It remains displayed for 30 seconds after switching off the ignition. It is displayed when the driver's door is opened, and when the vehicle is locked or unlocked.

**i** When travelling abroad, you may have to change the distance units (km or miles): the road speed must be displayed in the local country's official unit (km/h or mph). The unit is changed via the screen configuration menu, with the vehicle stationary.

## Lighting dimmer

This system allows the brightness of the instruments and controls to be adjusted to suit the ambient light level.

## With PEUGEOT Connect Radio



▶ Press this button to select the **Settings** menu.



▶ Select "**Brightness**".



▶ Adjust the brightness by pressing the arrows or moving the slider.

The settings are applied immediately.

▶ Press outside the settings window to exit.

You can also switch off the screen:



▶ Press this button to select the **Settings** menu.



▶ Select "**Dark**".

The screen goes off completely.

▶ Press the screen again (anywhere on its surface) to activate it.

## With PEUGEOT Connect Nav



▶ Press this button to select the **Settings** menu.



▶ Select "**OPTIONS**".



▶ Select "**Screen configuration**".

▶ Select the "**Brightness**" tab.



▶ Adjust the brightness by pressing the arrows or moving the slider.



▶ Press this button to save and exit.

You can also switch off the screen:



- ▶ Press this button to select the **Settings** menu.
- ▶ Select "**Turn off screen**".

The screen goes off completely.

- ▶ Press the screen again (anywhere on its surface) to activate it.

## Trip computer

Displays information related to the current trip (range, fuel consumption, average speed, etc.).

### Data displayed on the instrument panel

#### With instrument panels with dials

Pressing the end of the wiper control stalk displays the trip computer data.

#### With digital instrument panel

The trip computer data is permanently displayed when the "**PERSONAL**" display mode is selected.

In all other display modes, pressing the end of the wiper control stalk will cause this data to appear temporarily in a specific window.

#### Display of the various tabs

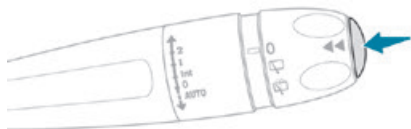

- ▶ Pressing the button located on the end of the **wiper control stalk** displays the following tabs in turn:

- Current information:
  - Driving range (Petrol or Diesel).
  - Current fuel consumption.
  - Stop & Start time counter (Petrol or Diesel).
  - Total mileage (Electric).
- Trips "1" then "2":
  - Average speed.
  - Average fuel consumption.
  - Distance travelled.

### Trip reset



- ▶ When the desired trip is displayed, press the button on the end of the wiper control stalk for more than 2 seconds.

Trips "1" and "2" are independent and are used identically.

### Definitions

#### Range

(miles or km)



The distance which can still be travelled with the fuel remaining in the tank

(depending on the average fuel consumption over the last few miles (kilometres) travelled).

This value may vary following a change in the style of driving or the terrain, resulting in a significant change in the current fuel consumption.

When the range falls below 19 miles (30 km), dashes are displayed.

After filling with at least 5 litres of fuel, the range is recalculated and is displayed if it exceeds 62 miles (100 km).

If dashes instead of figures continue to be displayed when driving, contact a PEUGEOT dealer or a qualified workshop.

#### Current fuel consumption

(mpg or l/100 km or km/l)

(miles/kWh or kWh/100 km or km/kWh)



Calculated during the last few seconds.

This function is only displayed at speeds above 19 mph (30 km/h).

#### Average fuel consumption

(mpg or l/100 km or km/l)

(miles/kWh or kWh/100 km or km/kWh)



Calculated since the last trip computer reset.

#### Average speed

(mph or km/h)



Calculated since the last trip computer reset.

## Distance travelled

(miles or km)



Calculated since the last trip computer reset.

## Stop & Start time counter



(minutes/seconds or hours/minutes)

If your vehicle is equipped with Stop & Start, a time counter calculates the time spent in STOP mode during a journey.

It resets to zero every time the ignition is switched on.

## Touch screen

This system gives access to the following elements:

- Permanent display of the time and the exterior temperature (a blue warning lamp appears if there is a risk of ice).
- Heating/air conditioning controls.
- Vehicle functions and equipment setting menus.
- Audio system and telephone controls and display of related information.
- Display of visual manoeuvring aid functions (visual parking sensor information, Park Assist, etc.).
- Internet services and display of related information.

- Navigation system controls and display of related information (depending on version).

**!** For safety reasons, always stop the vehicle before performing operations that require sustained attention.

Some functions are not accessible while driving.

## Recommendations

This screen is of the capacitive type.

Do not use pointed objects on the touch screen.

Do not touch the touch screen with wet hands.

Use a soft, clean cloth to clean the touch screen.

## Main controls

### With 7-inch touch screen

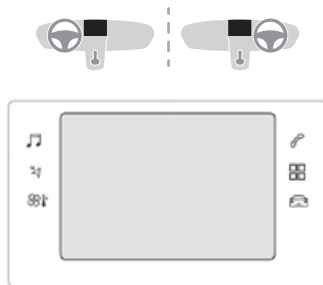

Use the buttons arranged around the touch screen to access the menus, then press the virtual buttons on the touch screen.

### With 10-inch touch screen

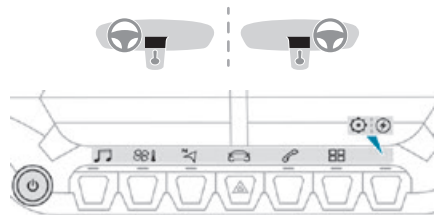

Use the buttons arranged below the touch screen to access the menus, then press the virtual buttons on the touch screen.

## Principles

Some menu may display across two pages: press the **"OPTIONS"** button to access the second page.

**i** If no action is performed on the second page, the first page is displayed automatically.



To deactivate/activate a function, select **"OFF"** or **"ON"**.



Configure a function.



Access additional information on the function.

-  Confirm.
-  Return to the previous page or confirm.

## Menus

-  Press with three fingers on the touch screen to show all of the menu buttons.

 **Radio / Media**  
Refer to the "Audio equipment and telematics" section.

 **Climate**  
Settings for temperature, air flow, etc.

For more information on **Manual air conditioning** or **Automatic air conditioning**, refer to the corresponding section.

 **Navigation** (Depending on equipment)  
Refer to the "Audio equipment and telematics" section.

 **Driving or Vehicle** (Depending on equipment)

Activation, deactivation and settings for certain functions.

The functions are organised in 2 tabs: "**Driving functions**" and "**Vehicle settings**".



 **Telephone**  
Refer to the "Audio equipment and telematics" section.

 **Applications**  
Access to certain configurable equipment.

 **Electric / Energy**

Access the specific Electric functions (energy flow, consumption statistics, deferred charge) organised in the corresponding 3 tabs.  
or

 **Settings**  
Main settings for the audio system, touch screen and digital instrument panel.

 Volume adjustment/mute.  
 See "Audio equipment and telematics" section.

## Information banner(s)

Certain information is displayed permanently in the touch screen banner(s).

### 7-inch touch screen upper banner

- Time and exterior temperature (a blue warning lamp appears if there is a risk of ice).
- Reminder of the air conditioning information, and direct access to the corresponding menu.
- Reminder of the information in the **Radio Media** and **Telephone** menus.
- Notifications.
- Access to the **Settings** for the touch screen and the digital instrument panel (date/time, languages, units, etc.).



### 10-inch HD touch screen side banners

- Exterior temperature (a blue warning lamp appears if there is a risk of ice).
- Access to the **Settings** for the touch screen and the digital instrument panel (date/time, languages, units, etc.).
- Notifications.

- Reminder of the air conditioning information, and direct access to the corresponding menu.
- Time.

## Electric / Energy menu

Depending on version, this is accessible either:

-  – directly, by pressing the button near the touch screen.
-  – via the **Applications** menu.

## Energy flows

The **Flow** tab provides a real-time representation of the electric drive train's operation.

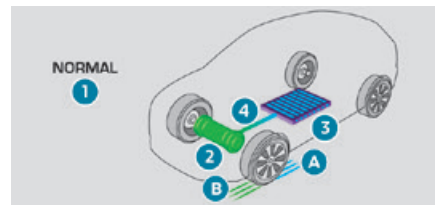

1. Active driving mode
2. Electric motor
3. Traction battery charge level
4. Energy flows

The energy flows have a specific colour for each type of driving:

- A.** Blue: energy consumption
- B.** Green: energy recovery

## Consumption statistics

The **Statistics** tab shows electrical energy consumption statistics.

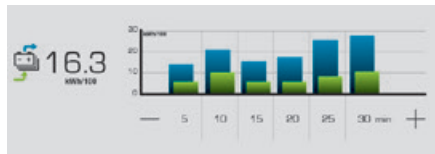

- Blue bar chart: directly consumed energy supplied by the traction battery.
- Green bar chart: energy recovered during deceleration and braking, used to recharge the battery.

The average result for the current trip is stated in kWh/100 km.

► You can change the displayed time scale by pressing the - or + buttons.

## Deferred charging

By default, charging begins when the nozzle is connected. Deferred charging can be programmed.

### Settings



► In the **Electric / Energy** touch screen menu, select the **Charge** tab.

- Set the charging start time.
- Press **OK**.

The setting is saved in the system.



You can also programme the deferred charging function using a smartphone, via the **MyPeugeot** application.

For more information on **Remotely operable features**, refer to the corresponding section.

### Activation

► Connect the vehicle to the desired charging equipment.



► Press this button in the flap within one minute to activate the system (confirmed by the charging indicator lamp coming on in blue).

## Remotely operable features (Electric)



These features are accessible using a smartphone, via the **MyPeugeot** application:

- Battery charge management.
- Temperature pre-conditioning management.
- Consumption, charge status and driving range statistics.

### Installation procedure

- Download the **MyPeugeot app from the appropriate online store for your smartphone**.
- Create an account.
- Enter the vehicle's VIN (code beginning with "VF" on the vehicle registration document).

For more information on **Identification markings**, refer to the corresponding section.

### Network coverage

In order to be able to use the various remotely operable features, ensure that your vehicle is located in an area covered by the mobile network.

A lack of network coverage may prevent communication with the vehicle (for example, if it is in an underground car park). In such cases, the application will display a message indicating that the connection with the vehicle could not be established.

## Remote control / Key

### Remote control function

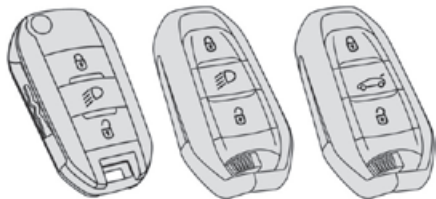

The remote control can be used for the following remote functions, depending on version:

- Unlocking / Locking / Deadlocking the vehicle.
- Unlocking / Locking the boot.
- Remote operation of lighting.
- Folding / Unfolding the door mirrors.
- Activating / Deactivating the alarm.
- Locating the vehicle.
- Opening / Closing the windows.
- Activating the vehicle's electronic immobiliser.

Back-up procedures allow the vehicle to be locked / unlocked in the event of a failure of the remote control, the central locking, the battery, etc. For more information on the **Back-up procedures**, please refer to the corresponding section.

### Integral key

The key built into the remote control can be used for the following operations, depending on version:

- Unlocking/Locking/Deadlocking the vehicle.
- Activation/Deactivation of the manual child lock.
- Activation/Deactivation of the front passenger airbag.
- Back-up Unlocking/Locking of the doors.
- Switching on the ignition and starting/switching off the engine.

#### Without Keyless Entry and Starting

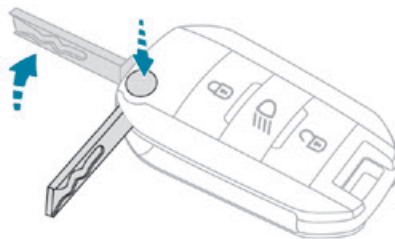

- ▶ To unfold or fold the key, press the button.  
**With Keyless Entry and Starting**

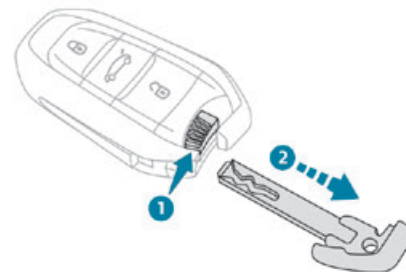

- ▶ To eject the key or put it back in place, pull and hold the button.

### Unlocking the vehicle



Selective unlocking (driver's door, boot) is configured in the **Driving/Vehicle** touch screen menu.

#### Complete unlocking

- ▶ Press the unlocking button.

#### Selective unlocking

##### Driver's door and fuel/charging flap

- ▶ Press the unlocking button.
- ▶ **Press it again** to unlock the other doors and the boot.

Complete or selective unlocking and alarm deactivation is confirmed by the flashing of the sidelamps and/or daytime running lamps. Depending on version, the door mirrors unfold.

## Opening the windows



Depending on version, holding the unlocking button pressed for more than 3 seconds opens the windows.

The windows stop when the button is released.

## Selective unlocking of the boot

When selective unlocking of the boot is activated :



▶ Press this button to unlock the boot. The doors remain locked.

Depending on version, pressing and holding this button causes the boot to open slightly.

If selective unlocking of the boot is deactivated, pressing this button also unlocks the doors.

**!** Do not forget to lock the boot again by pressing the locking button.

## Locking the vehicle



### Normal locking

▶ Press the locking button.

Locking and alarm activation is confirmed by the lighting of the direction indicators.

Depending on version, the door mirrors fold.

**i** An access (door or boot) that is not properly closed prevents locking of the

vehicle. However, if the vehicle is fitted with an alarm, it will be activated after 45 seconds. If the vehicle is unlocked but the doors or boot are not subsequently opened, the vehicle will automatically lock itself again after about 30 seconds. If the vehicle is fitted with an alarm, it will also be reactivated automatically.

## Deadlocking



▶ Press the locking button again within 3 seconds to deadlock the vehicle (confirmed by the temporary lighting of the direction indicators).

**!** Deadlocking renders the interior door controls inoperative. It also deactivates the central locking button.

The horn remains operational.

**Never leave anyone inside the vehicle when it is deadlocked.**

## Closing the windows



Holding the locking button pressed for more than 3 seconds closes the windows.

**!** When closing the windows, ensure that no person or object could prevent their correct closure.

To leave the windows partly open on versions with alarm, you must first deactivate the interior volumetric alarm protection.

For more information on the **Alarm**, refer to the corresponding section.

## Locating the vehicle

This function helps you to spot your vehicle from a distance, with the vehicle locked:

- The direction indicators or sidelamps and/or daytime running lamps, depending on version, flash for approximately 10 seconds.
- The door mirror spotlamps come on.
- The courtesy lamps come on.



▶ Press this button.

## Remote lighting of the lamps

Availability of this function depends on version.



▶ Press this button. The sidelamps, dipped beam headlamps, number plate lamps and door mirror spotlamps come on for 30 seconds.

Pressing again before the end of the timed period switches off the lamps immediately.

## Advice



### Remote control

The remote control is a sensitive, high-frequency device; avoid handling it in your pocket, due to the risk of unintentionally unlocking the vehicle.

Avoid pressing the remote control buttons while out of range of the vehicle, due to the risk of rendering the remote control inoperative. It would then be necessary to reset it.

The remote control does not work when the key is in the ignition switch, even when the ignition is switched off.

### ! Anti-theft protection

Do not modify the electronic vehicle immobiliser, as this might result in malfunctions.

For vehicles with a key ignition switch, remember to remove the key and turn the steering wheel to engage the steering lock.

### ! Locking the vehicle

Driving with the doors locked could make it more difficult for the emergency services to enter the vehicle in an emergency.

As a safety precaution, remove the key from the ignition or take the electronic key with you when leaving the vehicle, even for a short time.

### i Purchasing a second-hand vehicle

Have the key codes memorised by a PEUGEOT dealer, to ensure that the keys in your possession are the only ones able to start the vehicle.

## Proximity Keyless Entry and Start

This Keyless Entry and Starting system enables automatic vehicle locking/unlocking simply by detection of the electronic key.

As long as the driver has the electronic key on their person, the vehicle unlocks as they approach and locks when they walk away.

Key recognition zones:

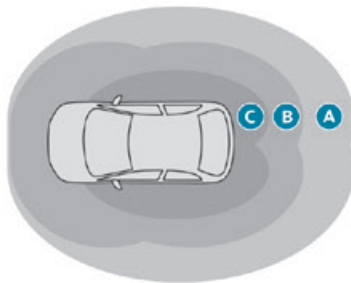

**Zone A:** welcome lighting on approaching the vehicle (between 3 and 5 metres from the vehicle).

**Zone B:** automatic locking on leaving the vehicle (about 2 metres from the vehicle).

**Zone C:** automatic unlocking and welcome lighting on approaching the vehicle (between 1 and 2 metres from the vehicle).

For more information on **Welcome lighting**, please refer to the corresponding section.



The automatic functions are configured via the **Driving / Vehicle** touch screen menu.

## Unlocking the vehicle

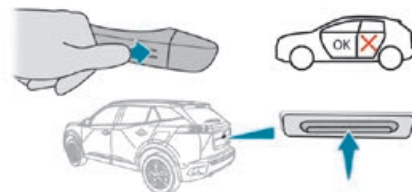

Selective unlocking (driver's door, boot) is configured in the **Driving/Vehicle** touch screen menu.

Selective unlocking is deactivated by default.

## Complete unlocking

The vehicle (doors and boot) unlocks:

► Either automatically as the driver approaches in zone **C**, if the automatic functions are activated.

► Or by gently pressing the driver's door handle or boot button.

Unlocking and alarm deactivation is confirmed by the flashing of the sidelamps and/or daytime running lamps.

Depending on version, the door mirrors unfold.



If the electronic key remains in zone **B** for more than 15 minutes without any action on the vehicle doors, the automatic



functions are deactivated and the vehicle locks.

To unlock the vehicle, use the remote control or press one of the handles.

## Selective unlocking

### Driver's door and fuel/charging flap

They unlock:

- ▶ Either automatically when approaching the driver's door, if the automatic functions are activated.
- ▶ Or by gently pressing the driver's door handle.
- ▶ Once inside the vehicle, to unlock all accesses, press the central locking button or pull the opening control on any door.

### Selective unlocking of the boot

The boot unlocks automatically as you approach the rear of the vehicle.

- ▶ Press the tailgate control to open the boot. The doors remain locked.

## Locking the vehicle

### Normal locking



With the doors and boot closed, the vehicle locks:

- ▶ Either automatically, upon leaving zone **B**, if the automatic functions are activated.

- ▶ Or by gently pressing the driver's door handle.

Locking is confirmed by the lighting of the direction indicators, and by an audible signal when the vehicle is locked upon walking away. It is not possible to lock the vehicle if the electronic key is left inside the vehicle.

**!** For safety and theft protection reasons, never leave the electronic key in the vehicle, even when you are close to it.

### Deadlocking

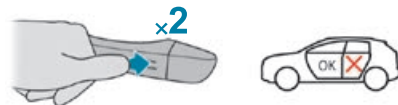

- ▶ Gently press the driver's door handle to lock the vehicle.
- ▶ Press it again within 3 seconds to deadlock the vehicle (confirmed by the temporary lighting of the direction indicators).

**!** Deadlocking renders the interior door controls inoperative. It also deactivates the central locking button. The horn remains operational.

### Never leave anyone inside the vehicle when it is deadlocked.

**i** If one of the doors or the boot is still open or if the electronic key for the Keyless Entry and Starting system has been left inside the vehicle, central locking will be disabled.

**i** If the vehicle is unlocked but the doors or boot are not subsequently opened, the vehicle will automatically lock itself again after about 30 seconds. If the vehicle is fitted with an alarm, it will also be reactivated automatically.

**i** The automatic door mirror folding/unfolding function is configured via the touch screen's **Driving / Vehicle** menu.

**!** As a safety measure, never leave the vehicle, even for a short time, without taking the Keyless Entry and Starting system's electronic key with you. Be aware of the risk of theft of the vehicle if the key is present in one of the defined areas while the vehicle is unlocked.

**!** In order to preserve the battery in the electronic key and the vehicle's battery:

- The unlocking on approach function (zone **C**) automatically goes into standby after several days of non-use (approximately

one week). To unlock the vehicle, use the remote control or press on one of the front door handles. At the next vehicle start, the automatic unlocking and locking functions will be reactivated.

- After the welcome lighting is triggered several times in succession without starting the vehicle, it will be deactivated.
- All of the "hands-free" functions go into extended stand-by after 21 days of non-use. To restore these functions, unlock the vehicle using the remote control and start the engine.

#### **i** Electrical interference

The electronic key may not operate if close to certain electronic devices: telephone (switched on or on standby), laptop computer, strong magnetic fields, etc.

## Central locking

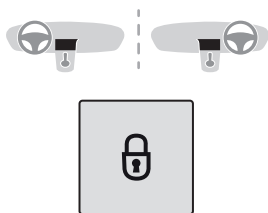

## Manual

- ▶ Press this button to lock/unlock the vehicle (doors and boot) from inside the vehicle.

The indicator lamp comes on to confirm the central locking of the vehicle.

**!** The central locking does not take place if one of the doors is open.

#### **i** When locking/deadlocking from the outside

When the vehicle is locked or deadlocked from the outside, the indicator lamp flashes and the button is inoperative.

- ▶ After normal locking, pull one of the interior door controls to unlock the vehicle.
- ▶ After deadlocking, it is necessary to use the remote control, Keyless Entry and Starting or the integral key to unlock the vehicle.

## Automatic (anti-intrusion security)

The doors and boot lock automatically when driving (speed above 6 mph (10 km/h)).

To deactivate/reactivate this function (activated by default):

- ▶ Press the button until a confirmation message appears.

#### **i** Transporting long or bulky objects

Press the central locking control to drive with the boot open and the doors locked.

Otherwise, every time the speed of the vehicle exceeds 6 mph (10 km/h), the locks will rebound and an alert will appear.

## Back-up procedures

### Lost keys, remote control, electronic key

Visit a PEUGEOT dealer with the vehicle's registration certificate, a personal identification document and, if possible, the label bearing the key code.

The PEUGEOT dealer will be able to retrieve the key code and the transponder code required to order a new key.

### Complete unlocking/locking of the vehicle with the key

Use this procedure in the following situations:

- Remote control battery discharged.
- Remote control malfunction.
- Vehicle battery discharged.
- Vehicle in an area subject to strong electromagnetic interference.

In the first case, change the remote control battery.

In the second case, reinitialise the remote control.

Refer to the corresponding sections.



- ▶ Insert the key in the door lock.
- ▶ Turn the key towards the front/rear to unlock/lock the vehicle.
- ▶ Turn the key rearwards again within 3 seconds to deadlock the vehicle.

**i** If the vehicle is fitted with an alarm, it will not be activated when locking with the key. If the alarm is activated, the siren sounds when the door is opened; switch on the ignition to stop it.

## Central locking not functioning

Use these procedures in the following cases:

- Central locking malfunction.
- Battery disconnected or discharged.

**!** In the event of a malfunction of the central locking system, the battery must be disconnected to ensure that the vehicle is locked fully.

## Driver's door

- ▶ Turn the key towards the rear of the vehicle to lock it, or towards the front to unlock it.

## Passenger doors

### Unlocking

- ▶ Pull the interior door opening control.

### Locking

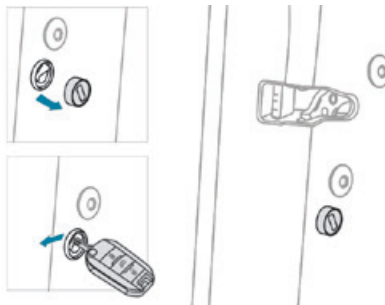

- ▶ Open the doors.
- ▶ For the rear doors, check that the child lock is not on.

Refer to the corresponding section.

- ▶ **Remove the black cap**, located on the edge of the door, using the key.
- ▶ Insert the key into the socket without forcing it, then turn the latch towards the inside of the door.
- ▶ Remove the key and refit the black cap.
- ▶ Close the doors and check from the outside that the vehicle is locked.

## Changing the battery

**!** If the battery is discharged, this warning lamp comes on, accompanied by an audible signal and the display of a message.

**Without Keyless Entry and Starting**  
Battery type: CR2032 / 3 volts.

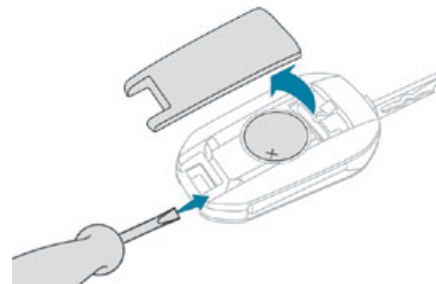

**With Keyless Entry and Starting**  
Battery type: CR2032 / 3 volts.

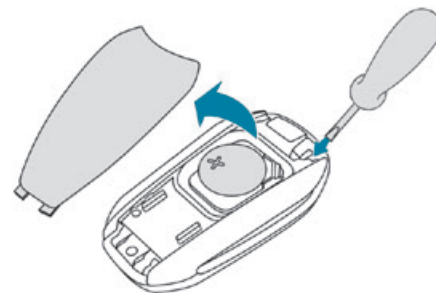

- ▶ Unclip the cover by inserting a small screwdriver in the slot and raise the cover.
- ▶ Remove the discharged battery from its housing.
- ▶ Insert the new battery, observing the polarity, and clip the cover onto the housing.

- ▶ Reinitialise the remote control.

For more information on **Reinitialising the remote control**, refer to the corresponding section.



Do not throw remote control batteries away, as they contain metals that are harmful to the environment. Take them to an approved disposal point.

## Reinitialising the remote control

Following replacement of the battery or in the event of a fault, it may be necessary to reinitialise the remote control.

### Without Keyless Entry and Starting

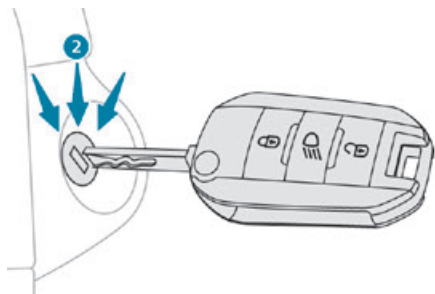

- ▶ Switch off the ignition.
- ▶ Return the key to position **2 (Ignition on)**.
- ▶ Immediately press the closed padlock button for a few seconds.

- ▶ Switch off the ignition and remove the key from the switch.

The remote control is now fully operational again.

### With Keyless Entry and Starting

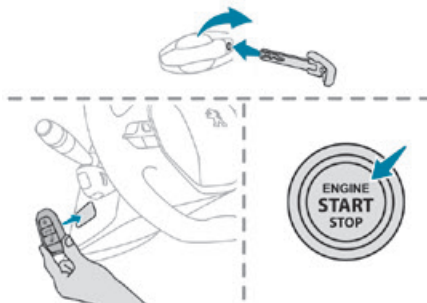

- ▶ Insert the mechanical key (incorporated into the remote control) into the lock to open the vehicle.
- ▶ Place the electronic key against the back-up reader on the steering column and hold it there until the ignition is switched on.
- ▶ Switch on the ignition by pressing the **"START/STOP"** button.
- ▶ **With a manual gearbox**, place the gear lever in neutral then fully depress the clutch pedal.
- ▶ **With an automatic gearbox or drive selector**, while in mode **P**, depress the brake pedal.

If the fault persists after reinitialisation, contact a PEUGEOT dealer or a qualified workshop without delay.

## Doors

### Opening

#### From outside

- ▶ After unlocking the vehicle or with the Keyless Entry and Starting electronic key in the recognition zone, pull the door handle.

#### From inside

- ▶ Pull the interior opening control of a door; this unlocks the vehicle completely.

- i** With selective unlocking activated:
  - Opening the driver's door unlocks the driver's door only (if the vehicle has not already been completely unlocked).
  - Opening one of the passenger doors unlocks the rest of the vehicle.

### Closing



If a door is not properly closed, this warning lamp comes on accompanied by a message if the engine is running, and an audible signal when the vehicle is travelling at more than 6 mph (10 km/h).

## Boot

### Opening

► After unlocking the vehicle or just the boot, press the opening control and then raise the tailgate.

### Closing

► Lower the tailgate using one of the interior grab handles.



If the tailgate is not properly closed, this warning lamp comes on accompanied by a message, if the engine is running, and an audible signal, if the vehicle is travelling at more than 6 mph (10 km/h).

**!** In the event of a malfunction or if you experience difficulty opening or closing the tailgate, have it checked by a PEUGEOT dealer or a qualified workshop without delay, to avoid the issue deteriorating and prevent any risk of the tailgate dropping, potentially causing serious injury.

### Back-up release

To manually unlock the boot in the event of a battery or central locking failure.

### Unlocking

► Fold the rear seats to gain access to the lock from inside the boot.

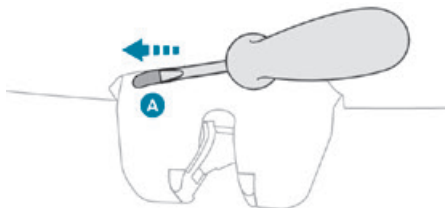

- Insert a small screwdriver into hole **A** of the lock to unlock the boot.
- Move the latch to the left.

### Locking after closing

If the fault persists after closing again, the boot will remain locked.

**i** In the event of a fault with the central locking system, it is essential to disconnect the battery to lock the boot and so ensure complete locking of the vehicle.

## Alarm

(Depending on version)



System which protects and provides a deterrent against theft and break-ins.

### Exterior perimeter monitoring

The system checks for opening of the vehicle. The alarm is triggered if anyone tries to open a door, the boot or the bonnet, for example.

### Interior volumetric monitoring

The system checks for any variation in volume in the passenger compartment. The alarm is triggered if anyone breaks a window, enters the passenger compartment or moves inside the vehicle.

### Self-protection function

The system checks for the putting out of service of its components.

The alarm is triggered if the battery, the central control or the siren wiring is put out of service or damaged.

**!** For all work on the alarm system, contact a PEUGEOT dealer or a qualified workshop.

## Locking the vehicle with full alarm system

### Activation

- Switch off the ignition and exit the vehicle.

► Lock or deadlock the vehicle using the remote control or by pressing on the driver's door handle.

When the monitoring system is active, the red indicator lamp in the button flashes once per second and the direction indicators come on for about 2 seconds.

The exterior perimeter monitoring is activated after 5 seconds and the interior volumetric monitoring after 45 seconds.

**i** The alarm does not activate when locking automatically from a distance.

**!** If an opening (door, boot or bonnet) is not properly closed, the vehicle is not locked, but the exterior perimeter monitoring will be activated after 45 seconds, at the same time as the interior volumetric monitoring.

## Deactivation

► Press one of the remote control unlocking buttons:



short press



long press

or

► Unlock the vehicle by pressing the driver's door handle.

The monitoring system is deactivated: the indicator lamp in the button goes off and the

sidelamps and/or the daytime running lamps flash for about 2 seconds.

### **i** After unlocking using the remote control

If the vehicle automatically locks itself again (as happens if a door or the boot is not opened within 30 seconds of unlocking), the monitoring system is automatically activated.

## Locking the vehicle with exterior perimeter monitoring only

Deactivate the interior volumetric monitoring to avoid the unwanted triggering of the alarm, in certain cases such as:

- Slightly open window.
- Washing the vehicle.
- Changing a wheel.
- Towing the vehicle.
- Transport on a ship or ferry.

## Deactivating interior volumetric monitoring

- Switch off the ignition and within 10 seconds press the alarm button until the indicator lamp is on fixed.
- Exit the vehicle.
- Immediately lock the vehicle using the remote control or the "Keyless Entry and Starting" system.

Only exterior perimeter monitoring is activated; the red indicator lamp in the button flashes every second.

**To take effect, this deactivation must be performed whenever the ignition is switched off.**

## Reactivating interior volumetric monitoring

► Deactivate exterior perimeter monitoring by unlocking the vehicle using the remote control or the "Keyless Entry and Starting" system. The indicator lamp in the button goes off.

► Reactivate the full alarm system by locking the vehicle using the remote control or by pressing the driver's door handle. The red indicator lamp in the button once again flashes every second.

## Triggering of the alarm

This is indicated by sounding of the siren and flashing of the direction indicators for 30 seconds.

Depending on the country of sale, certain monitoring functions remain active until the alarm has been triggered eleven times consecutively. When the vehicle is unlocked using the remote control or the Keyless Entry and Starting system, rapid flashing of the red indicator lamp in the button informs you that the alarm was triggered during your absence. When the ignition is switched on, this flashing stops.

## Failure of the remote control

To deactivate the monitoring functions:

- ▶ Unlock the vehicle using the key in the driver's door lock.
- ▶ Open the door; the alarm is triggered.
- ▶ Switch on the ignition; this stops the alarm. The indicator lamp in the button goes off.

## Locking the vehicle without activating the alarm

- ▶ Lock or deadlock the vehicle using the key (integral to the remote control) in the driver's door lock.

## Malfunction

When the ignition is switched on, fixed illumination of the red indicator lamp in the button indicates a malfunction of the system. Have it checked by a PEUGEOT dealer or a qualified workshop.

## Automatic activation

(Depending on country of sale)

The system is activated automatically 2 minutes after the last door or the boot is closed.

- ▶ To avoid triggering the alarm on entering the vehicle, first press the unlocking button on the remote control or unlock the vehicle using the "Keyless Entry and Starting" system.

## Electric windows

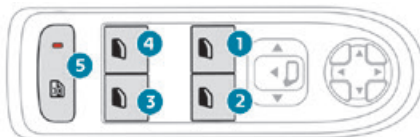

1. Left-hand front
2. Right-hand front
3. Right-hand rear
4. Left-hand rear
5. Electric child lock (depending on version)

For more information on the **Electric child lock**, refer to the corresponding section.

## Manual operation

- ▶ To open/close the window, press/pull the switch without passing the point of resistance; the window stops as soon as the switch is released.

## Automatic operation

- ▶ To open/close the window, press/pull the switch past its resistance point: the window opens/closes completely when the switch is released. Operating the switch again stops the movement of the window.

**i** Window controls remain operational for approximately 45 seconds after switching off the ignition or after locking the vehicle. After that time, the controls are disabled. To reactivate them, switch on the ignition or unlock the vehicle.

## Anti-pinch

If the window meets an obstacle while rising, it stops and immediately partially lowers again.

## Reinitialising the electric windows

Following reconnection of the battery, or if the windows move abnormally, the anti-pinch function must be reinitialised.

**The safety anti-pinch function is not active during these operations.**

For each of the windows:

- ▶ Lower the window fully, then raise it; it will rise in steps of a few centimetres each time the control is pressed. Repeat the operation until the window is fully closed.
- ▶ Continue to pull the switch for at least one second after reaching the window closed position.

**!** If an electric window meets an obstacle during operation, the movement of the window must be reversed. To do this, press the switch concerned. When the driver operates the passengers' electric window switches, it is important to

ensure that nothing can prevent the window from closing properly.

It is important to ensure that the passengers use the electric windows correctly.

Be particularly aware of children when operating the windows.

Be aware of passengers and/or other persons present when closing the windows using the electronic key or the "Keyless Entry and Starting" system.

## Sunroof

The sunroof consists of a movable glass panel that slides over the roof and a blind that can be opened independently. Opening the sunroof automatically opens the blind.

► To operate the panoramic sunroof, use the button in the roof console.

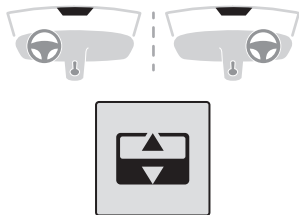

The sunroof can be operated when the ignition is turned on (if the battery is charged enough), with the engine running, in STOP mode of Stop &

Start, and up to 45 seconds after turning off the ignition or after locking the vehicle.

### Precautions

! Do not put your head or arms through the sunroof while the vehicle is moving - risk of serious injury!

! Ensure that any luggage or accessories carried on the roof bars do not interfere with the movement of the sunroof. Do not place heavy loads on the movable glass panel of the sunroof.

! If the sunroof is wet, following a shower or washing the vehicle, wait until it is completely dry before opening. Do not operate the sunroof if it is covered by snow or ice - risk of damage! Use only plastic scrapers to remove snow or ice from the sunroof.

! Check the condition of the sunroof seals regularly (presence of dust or deposits, dead leaves, etc.). If using a car wash, check first that the roof is correctly closed and keep the high-pressure jet at least 30 centimetres from the seals.

! Never leave the vehicle with the sunroof open.

## Operation

When opening the sunroof fully, the movable glass moves to a partially open position, then slides over the roof. All intermediate positions are allowed.

i Depending on the speed of the vehicle, the partially open position may vary to improve the acoustics.

! Before operating the sunroof control button, ensure that no object or person might prevent the movement.

Pay particular attention to children when operating the sunroof.

If something is trapped when operating the sunroof, reverse the movement of the sunroof by pressing the control button in question. The driver must ensure that passengers use the sunroof correctly.

### Anti-pinch system

If the sunroof encounters an obstacle when closing, the movement is automatically reversed. The roof anti-pinch system is designed to be effective at speeds of up to 75 mph (120 km/h).

### Opening/closing the sunroof

► To **open** the sunroof, use the part of the button located towards the **rear**.

► To **close** the sunroof, use the part of the button located towards the **front**.



## Operating the button

- ▶ Pressing the button beyond its point of resistance opens or closes the sunroof fully.
- ▶ Pressing the button again stops the movement in progress.
- ▶ By keeping the button pressed (without going beyond the point of resistance), the movement of the glass stops when this button is released.
- ▶ When the sunroof is closed: pressing once without passing the point of resistance moves it to the partially open position.
- ▶ When the sunroof is partially open: pressing once without passing the point of resistance opens or closes it fully.

**i** The sunroof and windows can be closed by holding down the door locking control. The operation stops as soon as the locking control is released.

## Opening/closing the blind

- ▶ To **open** the blind, pull the handle **backwards** until the desired position is reached.
- ▶ To **close** the blind, push the handle **forwards** until the desired position is reached.

## Reinitialisation

Reinitialisation is required after reconnecting the battery, or if the sunroof malfunctions or moves in a jerky manner.

- ▶ Check that nothing is affecting the movement of the sunroof and that the seals are clean.



- ▶ With the ignition on, fully close the sunroof.
- ▶ Press and hold the **front** part of the button until the sunroof moves slightly, hold for a further 1 second, then release.
- ▶ Wait 2 seconds then press and hold the **front** part of the button again. The sunroof will open and close again. Once the roof is fully closed again, hold for a further 2 seconds, then release.

## PEUGEOT i-Cockpit

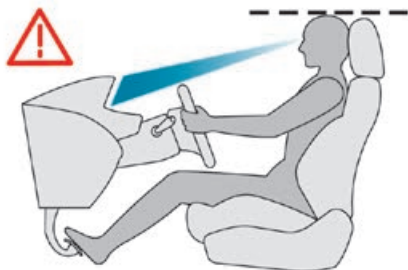

Before taking to the road and to make the most of the ergonomic layout of the PEUGEOT i-Cockpit, carry out these adjustments in the following order:

- head restraint height.
- seat backrest angle.
- seat cushion height.
- longitudinal seat position.
- steering wheel reach and then height.
- rear view mirror and door mirrors.

**i** Once these adjustments have been made, check that the "head-up" instrument panel can be viewed correctly over the smaller diameter steering wheel.

**!** Before moving the seat backwards, ensure that there is no person or object that might prevent the full travel of the seat. There is a risk of trapping or pinching passengers if present in the rear seats or of jamming the seat if large objects are placed on the floor behind the seat.

## Front seats

### Front head restraints

#### Height adjustment

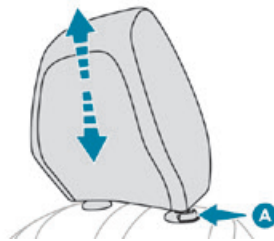

- ▶ **Upwards:** pull the head restraint up to the desired position; the head restraint can be felt to click into position.
- ▶ **Downwards:** press lug **A** to lower the head restraint.

**i** The adjustment is correct when the upper edge of the head restraint is level with the top of the head.

### Removing a head restraint

- ▶ Pull the head restraint fully up.
- ▶ Press the lug **A** to release the head restraint and remove it completely.
- ▶ Stow the head restraint securely.

### Refitting a head restraint

- ▶ Insert the head restraint rods into the guides in the corresponding seat backrest.
- ▶ Push the head restraint down as far as it will go.
- ▶ Press the lug **A** to release the head restraint and push it down.
- ▶ Adjust the height of the head restraint.

**!** Never drive with the head restraints removed; they should be in place and adjusted for the occupant of the seat.

## Manually-adjustable seats

### Longitudinal



- ▶ Raise the control bar and slide the seat forwards or backwards.

### Backrest angle

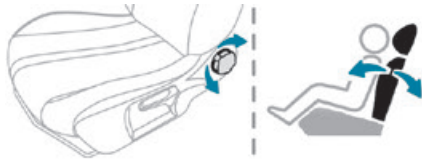

- ▶ Turn the knob to adjust the backrest.

### Backrest angle

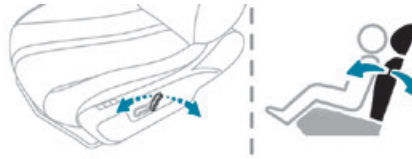

- ▶ Tilt the control forwards or rearwards.

### Height

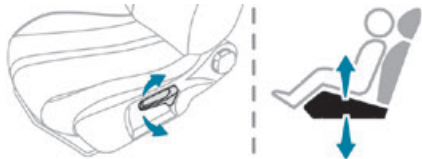

- ▶ Pull the control upwards to raise the seat or push it downwards to lower it until the desired position is obtained.

### Cushion height and angle

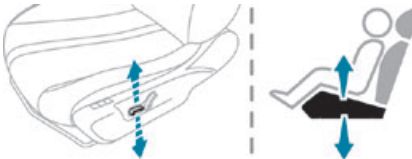

- ▶ Tilt the rear of the control upwards or downwards to obtain the required height and angle.

## Electrically-adjustable seats

### Longitudinal

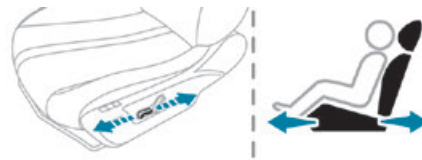

- ▶ Push the control forwards or rearwards to slide the seat.

## Electric lumbar adjustment



- ▶ Press the + or - control to obtain the desired lumbar support.

## Massage function

(Driver's seat only)

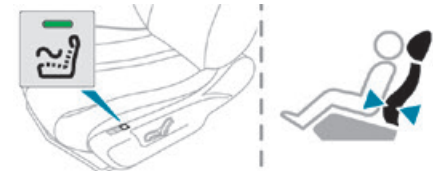

This function provides lumbar massage; it only operates when the engine is running as well as in STOP mode of the Stop & Start system.

### Activation/Deactivation



- ▶ Press this button to activate/deactivate the function.

Upon activation, the indicator lamp comes on. The massage function is activated for a period of one hour.

During this time, massage is performed in 6 cycles of 10 minutes (6 minutes of massage followed by a 4-minute break).

After one hour, the function is deactivated; the indicator lamp goes off.

## Heated seats

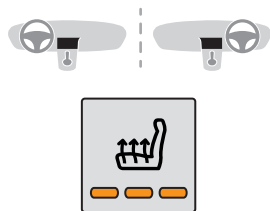

The function is active only with the engine running.

### On/Off

- ▶ Press the button corresponding to the seat.
  - ▶ Each press changes the heating level; the corresponding number of indicator lamps come on.
  - ▶ To switch off the heating, press the button until all of the indicator lamps are off.
- The system status is memorised when the ignition is switched off.



Do not use the function when the seat is not occupied.

Reduce the heating intensity as soon as possible.

When the seat and passenger compartment have reached a satisfactory temperature, switch the function off; reducing electrical consumption in turn decreases energy consumption.

! Prolonged use of the heated seats is not recommended for those with sensitive skin.

There is a risk of burns for people whose perception of heat is impaired (illness, taking medication, etc.).

To keep the heated pad intact and to prevent a short circuit:

- do not place sharp or heavy objects on the seat,
- do not kneel or stand on the seat,
- do not spill liquids onto the seat,
- never use the heating function if the seat is wet.

## Steering wheel adjustment

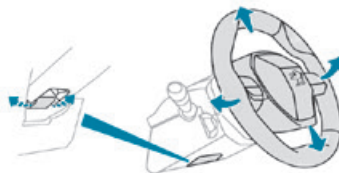

- ▶ When stationary, pull the control to release the steering wheel.
- ▶ Adjust the height and reach to suit your driving position.
- ▶ Push the control lever to lock the steering wheel.

! As a safety measure, these adjustments must only be carried out with the vehicle stationary.

## Mirrors

### Door mirrors

! As a safety measure, the mirrors should be adjusted to reduce the "blind spots". The objects that you see in the mirrors are in fact closer than they appear. Take this into account in order to correctly judge the distance of vehicles approaching from behind.

### Adjustment

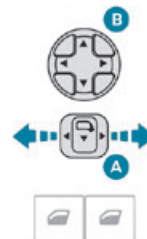

- ▶ Move control **A** to the right or to the left to select the corresponding mirror.
- ▶ Move control **B** in any of the four directions to adjust.

- ▶ Return control **A** to its central position.

### Manual folding

The mirrors can be folded manually (parking obstruction, narrow garage, etc.).

- ▶ Turn the mirror towards the vehicle.

### Electric folding

If the vehicle is so equipped, the mirrors can be folded electrically from the inside, with the vehicle parked and the ignition on:



- ▶ Place control **A** in the centre position.
- ▶ Pull control **A** back.

- ▶ Lock the vehicle from the outside.

### Electric unfolding

- ▶ From outside: unlock the vehicle.
- ▶ From inside: with the ignition on, place control **A** in the central position and then pull it rearwards.

**i** The automatic door mirror folding/unfolding function is configured via the **Driving / Vehicle** touch screen menu.

### Demisting/Defrosting



If the vehicle is so equipped, demisting/defrosting of the heated door mirrors is performed when the heated rear screen is switched on.

For more information on **Rear screen demisting/defrosting**, refer to the corresponding section.

### Interior rear view mirror

Equipped with an anti-dazzle system, which darkens the mirror glass and reduces the nuisance to the driver caused by the sun, headlamps of other vehicles, etc.

#### Manual model

##### Day/night position

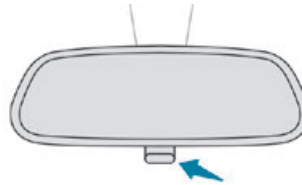

- ▶ Pull the lever to change to the anti-dazzle "night" position.
- ▶ Push the lever to change to the normal "day" position.

##### Adjustment

- ▶ Set the mirror to the normal "day" position.

### Automatic "electrochromic" model

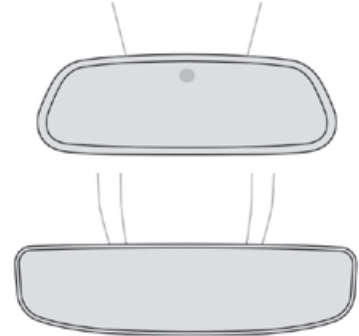

This system automatically and progressively transitions between day and night modes, using a sensor that measures the light entering from the rear of the vehicle.

**i** To ensure optimum visibility during your manoeuvres, the mirror lightens automatically when reverse gear is engaged.

### Rear bench seat

Bench seat with fixed cushions and split folding backrests (2/3-1/3) to adapt the boot load space.

## Rear head restraints

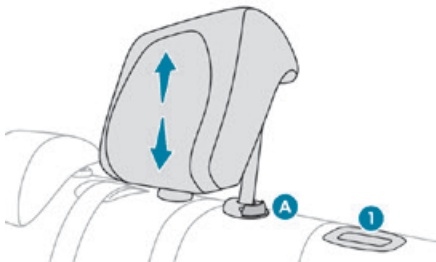

They have two positions:

- A **high position**, for when the seat is in use:
  - ▶ Pull the head restraint fully up.
- A **low position**, for stowing, when the seat is not in use:

- ▶ Press the lug **A** to release the head restraint and push it down.

The rear head restraints can be removed.

### Removing a head restraint

- ▶ Release the backrest using control **1**.
- ▶ Tilt the backrest slightly forwards.
- ▶ Pull the head restraint fully up.
- ▶ Press the lug **A** to release the head restraint and remove it completely.

### Refitting a head restraint

- ▶ Insert the head restraint rods into the guides in the corresponding backrest.
- ▶ Push the head restraint fully down.
- ▶ Press the lug **A** to release the head restraint and push it down.

**!** Never drive with passengers seated at the rear when the head restraints are removed; the head restraints should be in place and in the high position. The head restraint for the centre seat and those for the outer seats are not interchangeable.

## Folding the backrests

**!** Manoeuvring the backrests should only be done when the vehicle is stationary.

First steps:

- ▶ Lower the head restraints.
- ▶ If necessary, move the front seats forward.
- ▶ Check that no person or object might interfere with the folding of the backrests (clothing, luggage, etc.).
- ▶ Check that the seat belts are free, not engaged in the buckles. Release them so that the backrest can be moved.



- ▶ Press the backrest release grip **1**.
- ▶ Guide the backrest **2** down to the horizontal position.

**i** When the backrest is released, the red indicator in the release grip is visible.

## Repositioning the backrests

**!** First check that the outer seat belts are lying vertically flat alongside the backrest latching rings.

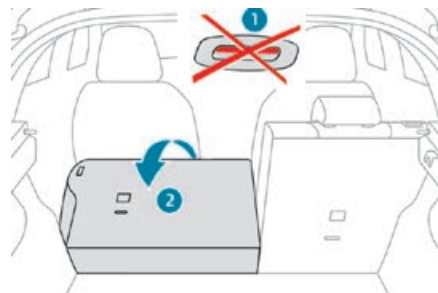

- ▶ Put the backrest **2** in the upright position and push it firmly to latch it home.
- ▶ Check that the red indicator is no longer visible in the release grip **1**.
- ▶ Ensure that the outer seat belts were not trapped during the operation.

**!** Please note: an incorrectly latched backrest compromises the safety of

passengers in the event of sudden braking or an accident.

The contents of the boot may be thrown forwards - risk of serious injury!

## Heating and Ventilation

### Air intake

The air circulating in the passenger compartment is filtered and originates either from the exterior, via the grille located at the base of the windscreen, or from the inside in air recirculation mode.

### Controls

Depending on version, the controls are accessible in the "Air conditioning" touch screen menu or are grouped together in the control panel on the centre console.

### Air distribution

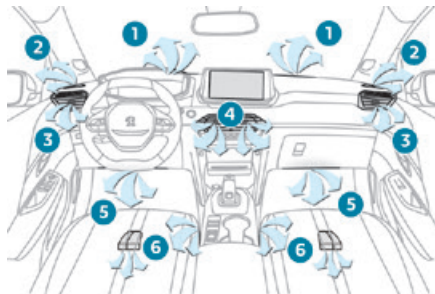

1. Windscreen demisting/defrosting vents
2. Front side window demisting/defrosting vents
3. Adjustable and closable side air vents
4. Adjustable and closable central air vents
5. Air outlets to the front footwells
6. Air outlets to the rear footwells (depending on version)

## Advice

### Using the ventilation and air conditioning system

- ▶ To ensure that air is distributed evenly, keep the external air intake grilles at the base of the windscreen, the nozzles, the vents, the air outlets and the air extractor in the boot free from obstructions.
  - ▶ Do not cover the sunshine sensor located on the dashboard; this sensor is used to regulate the automatic air conditioning system.
  - ▶ Operate the air conditioning system for at least 5 to 10 minutes once or twice a month to keep it in perfect working order.
  - ▶ If the system does not produce cold air, switch it off and contact a PEUGEOT dealer or a qualified workshop.
- When towing the maximum load on a steep gradient in high temperatures, switching off the air conditioning increases the available engine power, enhancing the towing capacity.

! Avoid driving for too long with the ventilation off or with prolonged operation of interior air recirculation. Risk of misting and deterioration of the air quality!

🌿 If the interior temperature is very high after the vehicle has stood for a long time in the sunshine, air the passenger compartment for a few moments. Put the air flow control at a setting high enough to quickly change the air in the passenger compartment.

i Condensation created by the air conditioning results in a discharge of water underneath the vehicle. This is perfectly normal.

### Servicing the ventilation and air conditioning system

- ▶ Ensure that the passenger compartment filter is in good condition and have the filter elements replaced regularly. We recommend using a composite passenger compartment filter. Thanks to its special active additive, this type of filter helps to purify the air breathed by the occupants and keep the passenger compartment clean (by reducing allergic symptoms, unpleasant odours and greasy deposits).
- ▶ To ensure correct operation of the air conditioning system, have it checked

according to the recommendations in the Maintenance and Warranty Guide.

### Stop & Start

The heating and air conditioning systems only operate when the engine is running. Temporarily deactivate the Stop & Start system to maintain a comfortable temperature in the passenger compartment. For more information on the **Stop & Start**, refer to the corresponding section.

### ECO driving mode

Selecting this mode reduces electrical energy consumption, but restricts the performance of the heating and air conditioning systems, although it does not deactivate them.

## Manual air conditioning



Press the **Climate** button to display the system controls page.

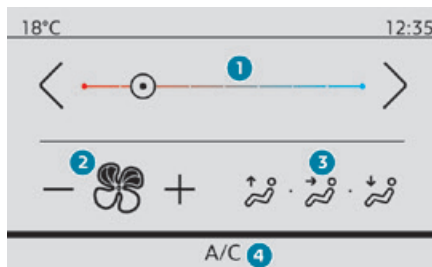

1. Temperature adjustment
2. Air flow adjustment
3. Air distribution adjustment
4. Air conditioning on/off

### Adjusting the temperature

- ▶ Press one of the buttons **1** (- or +) to set the temperature.

### Air flow adjustment

- ▶ Press one of the buttons **2** (- or +) or turn the knob **2** to decrease or increase the speed of the fan.

When the air flow is reduced to a minimum, ventilation stops.

### Air distribution adjustment

- ▶ Press button **3** to adjust the air flow distribution inside the passenger compartment.



Central and side air vents, footwells



Central and side air vents



Windscreen



Windscreen, footwells



Footwells

## Air conditioning on / off

The air conditioning system is designed to operate effectively in all seasons, with the windows closed.

It is used to:

- lower the temperature in summer,
- increase the effectiveness of the demisting in winter, above 3°C.

- ▶ Press button **4** to activate/deactivate the air conditioning system.



Air conditioning does not operate when the air flow is disabled.

To obtain cool air more quickly, enable interior air recirculation for a brief period. Then return to the intake of exterior air.

Switching off the air conditioning may result in some discomfort (humidity or misting).

## Automatic air conditioning

This system automatically controls the activation of the air conditioning system, regulating the



temperature, air flow and air distribution inside the passenger compartment.

The air conditioning operates with the engine running, but the ventilation and its controls can be accessed with the ignition on.



Press the **Climate** menu button to access the system controls.

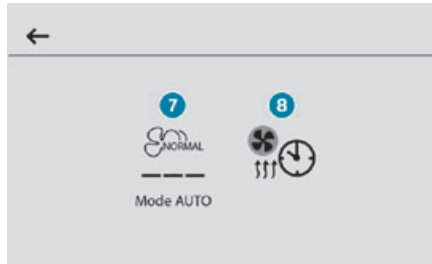
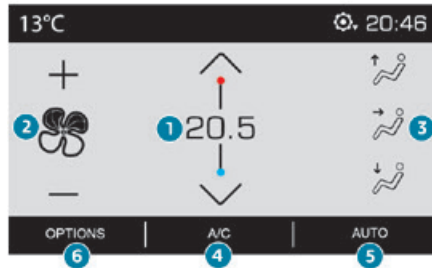

1. Temperature adjustment
2. Air flow adjustment
3. Air distribution adjustment
4. Air conditioning on/off

5. Automatic Comfort programme on/off
6. Access to the secondary page
7. Automatic Comfort programme settings (Soft/Normal/Fast)
8. Temperature pre-conditioning (Electric)

## Temperature adjustment

- ▶ Press one of the buttons **1** to increase (red) or decrease (blue) the value.

The value displayed corresponds to a level of comfort and not to a precise temperature.

## Air flow adjustment

- ▶ Press one of the buttons **2** (- or +) to decrease or increase the speed of the air booster fan.

The air flow symbol (a fan) is filled in progressively as the speed of the fan is increased.

When the air flow is reduced to a minimum, ventilation stops.

"OFF" is displayed alongside the fan.

## Air distribution adjustment

- ▶ Press the buttons **3** to adjust the air flow distribution inside the passenger compartment.



↑ Windscreen and side windows

→ Central and side air vents

↓ Footwells

The lighting of the button indicates that air is being blown in the specified direction.

It is possible to activate all three buttons simultaneously, for uniform distribution throughout the passenger compartment.

## Air conditioning on / off

The air conditioning system is designed to operate effectively in all seasons, with the windows closed.

It is used to:

- lower the temperature in summer,
- increase the effectiveness of the demisting in winter, above 3°C.

- ▶ Press button **4** to activate/deactivate the air conditioning system.

**i** Air conditioning does not operate when the air flow is disabled.

To obtain cool air more quickly, enable interior air recirculation for a brief period. Then return to the intake of exterior air.

Switching off the air conditioning may result in some discomfort (humidity or misting).

## Automatic Comfort programme

This automatic mode ensures optimum management of the passenger compartment temperature, air flow and air distribution, based on the selected comfort level.

► Press button **5** to activate or deactivate the air conditioning system's automatic mode . The indicator lamp in the button lights up when the air conditioning system is operating automatically.

You can adjust the intensity of the automatic Comfort programme by using the "**OPTIONS**" button to select a profile:

– "**Soft**": provides soft and quiet operation by limiting air flow.

– "**Normal**": offers the best compromise between a comfortable temperature and quiet operation (default setting).

– "**Fast**": provides strong and effective air flow.

To change the current profile (shown by the corresponding indicator lamp), press button **7** repeatedly until the desired profile is displayed: The "**Normal**" or "**Fast**" profiles are the most comfortable for passengers in the rear seats.

This profile setting is associated with automatic mode only. However, on deactivation of the **AUTO** mode, the indicator lamp for the most recently selected profile remains on.

Changing the profile setting does not reactivate **AUTO** mode if it was deactivated.

**i** In cold weather with the engine cold, the air flow is increased gradually until the comfort setting has been reached, in order to limit the delivery of cold air into the passenger compartment.

On entering the vehicle, if the interior temperature is much colder or warmer than

the comfort setting requested, there is no need to alter the value displayed to more quickly reach the required level of comfort. The system automatically corrects the temperature difference as quickly as possible.

## Interior air recirculation

The intake of exterior air prevents the formation of mist on the windscreen and side windows. Recirculating the interior air isolates the passenger compartment from outside odours and fumes and allows the desired passenger compartment temperature to be achieved more rapidly.



► Press this button to activate/deactivate the function (confirmed by the illumination/extinction of the indicator lamp).



The function is activated automatically when reverse gear is engaged.

## Maximum air conditioning

This function automatically adjusts the temperature setting to the lowest possible, the air distribution towards the central and side air vents, the air flow to maximum and, if necessary, activates interior air recirculation.



► Press this button to activate/deactivate the function (confirmed by the illumination/extinction of the indicator lamp).

Once the function is deactivated, the system returns to the previous settings.

## Switching off the air conditioning system



► Press this button.

Its indicator lamp comes on and all of the other indicator lamps for the system go off.

This action deactivates all of the functions of the air conditioning system.

The temperature is no longer regulated. A slight flow of air can still be felt, due to the forward movement of the vehicle.

## Front demisting - defrosting

### Automatic Visibility programme

This mode allows the windscreen and side windows to be demisted or defrosted as quickly as possible.



► Press this button to activate/deactivate the mode (confirmed by the illumination/extinction of the indicator lamp).

The programme automatically manages the air conditioning (depending on version), air flow and air intake, and provides optimum distribution towards the windscreen and side windows.

It is possible to manually change the air flow without deactivating the automatic Visibility programme.

**i** With Stop & Start, when demisting has been activated, STOP mode is not available.

**!** In wintry conditions, remove all snow or ice on the windscreen near the camera before moving off. Otherwise, the operation of the equipment associated with the camera may be affected.

## Heated windscreen

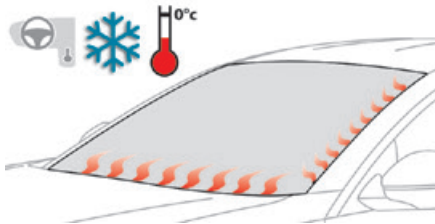

In cold weather, this system heats the bottom of the windscreen, as well as the area alongside the left-hand windscreen pillar. Without changing the settings for the air conditioning system, it allows faster release of the windscreen wiper blades when they are frozen to the windscreen and helps avoid

the accumulation of snow resulting from the operation of the windscreen wipers.

## On/Off



► With the engine running, press this button to activate/deactivate the function (confirmed by an indicator lamp). The function is activated when the exterior temperature drops below 0°C. It is deactivated automatically when the engine is switched off.

## Rear screen demisting/defrosting

Demisting/defrosting only operates with the engine running.

Depending on version, this also applies to the door mirrors.

**i** ► Press this button to activate/deactivate the function (confirmed by the illumination/extinction of the indicator lamp). Demisting/defrosting switches off automatically to prevent an excessive consumption of electrical current.



Switch off demisting/defrosting when you no longer need it; reducing electrical consumption in turn decreases energy consumption.

## Remote-controlled heating and air conditioning (Electric)

This function allows you to programme the vehicle to adjust the passenger compartment temperature to a pre-defined, non-modifiable temperature (approx. 21°C) before you enter the vehicle, on the days and times of your choice.

## Programming

(With PEUGEOT Connect Nav)

In the **Climate > OPTIONS** menu:



Select **Temperature conditioning**.

- Press **+** to programme.
- Select the time of entry into the vehicle and the desired days. Press **OK**.
- Press **ON** to activate this programming. Pre-conditioning begins approximately 45 minutes before the programmed time, and is maintained for 10 minutes afterwards.

**i** You can define multiple programmings. Each one is saved in the system. To optimise battery life, we recommend programming with the vehicle plugged in.



This feature can be programmed using a smartphone, via the

**MyPeugeot** application.

With PEUGEOT Connect Radio, the programming can only be carried out using a smartphone, via the application.

For more information on **Remotely operable features**, refer to the corresponding section.

## Operating conditions

- The function is only activated when the **ignition is off and the vehicle locked**.
- The function is not activated if the battery charge level is below 50%.
- If recurrent programming is activated (e.g. from Monday to Friday) and two pre-conditioning sequences are performed without the vehicle being used, the programming will be deactivated.

## Interior fittings

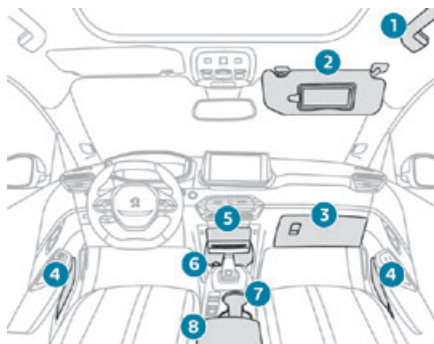

1. Grab handle
2. Sun visor
3. Glove box
4. Door pockets
5. Storage compartment or Storage compartment with flap or Wireless smartphone charger with flap (depending on version)
  - ▶ Press the top centre of the flap to open it.
6. Storage compartment with 12 V accessory socket
7. Cup holder
8. Adjustable centre armrest with storage compartment  
Rear USB socket(s) (depending on version)

## Sun visor

▶ With the ignition on, raise the concealing flap; depending on the version, the mirror is illuminated automatically.

This sun visor is also equipped with a ticket holder.

## Glove box

▶ To open the glove box, raise the handle.

**!** Never drive with the glove box open when a passenger is at the front. It may cause injury during sharp deceleration!

## USB sockets

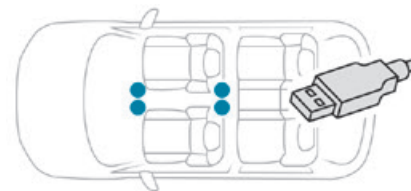

They allow the connection of a portable device in order to recharge it.



The front right USB port also allows a smartphone to be connected by MirrorLink™, Android Auto® or CarPlay®, enabling certain smartphone applications to be used on the touch screen.

For best results, use a cable made or approved by the device manufacturer.

These applications can be managed using the steering mounted controls or the audio system controls.

**i** When the USB port is used, the portable device charges automatically.

A message is displayed if the power drawn by the portable device exceeds the current supplied by the vehicle.

For more information on how to use this equipment, refer to the **Audio equipment and telematics** section .

## 12 V accessory socket

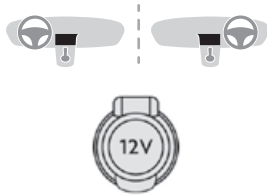

► Plug in a 12 V accessory (with a maximum rated power of 120 W) using a suitable adapter.

**!** Observe the maximum power rating to avoid damaging the accessory..

**!** The connection of an electrical device not approved by PEUGEOT, such as a USB charger, may adversely affect the operation of vehicle electrical systems,

causing faults such as poor radio reception or interference with displays in the screens.

## FOCAL® Premium Hi-Fi system

The vehicle is equipped with a high-fidelity acoustic system from the French brand FOCAL®. 10 speakers incorporating exclusive FOCAL® technologies offer the pleasure of pure and detailed sound inside the vehicle:

- Central speaker/satellite speakers: Polyglass technology delivering sound immersion and spatialisation.
- High fidelity woofer/mid-range speakers: Polyglass technology delivering balance and precise sound.
- TNF tweeters: Inverted dome aluminium technology giving optimum sound dispersion and very detailed higher frequencies.
- 12-way active amplification - 515 Watts: Hybrid Class AB/Class D technology providing breadth and finesse in the high frequency signals, as well as real power in the bass.
- Subwoofer: 200 mm triple coil Power Flower™ technology for defined and dynamic reproduction of lower frequencies.

**i** For optimum sound reproduction, it is recommended that you put the boot floor in the high position (depending on version).

## Wireless smartphone charger

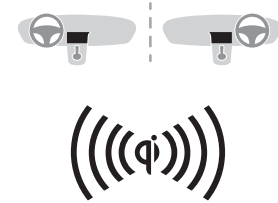

It allows wireless charging of a portable device such as a smartphone, using the magnetic induction principle, in accordance with the Qi 1.1 standard.

The portable device to be charged must be compatible with the Qi standard, either by design or by using a compatible holder or shell. The charging area is identified by the Qi symbol. The charger works with the engine running and with the Stop & Start system in STOP mode. Charging is managed by the smartphone. With Keyless Entry and Starting, the charger's operation may be briefly disrupted when a door is opened or the ignition is switched off.

### Charging

- Open the flap to access the charging area.
- With the charging area clear, place a device in its centre.

**!** The system is not designed to charge multiple devices simultaneously.



**!** Do not leave any metal objects (coins, keys, vehicle remote control, etc.) in the charging area while a device is being charged, due to the risk of overheating or interrupting the charging process.

## Mats

### Fitting

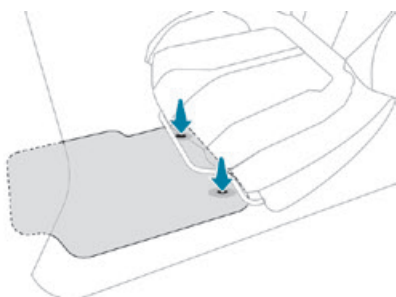

When fitting the mat for the first time, on the driver's side use only the fasteners supplied in the enclosed sachet.

The other mats are simply laid over the carpet.

### Removing/refitting

- ▶ To remove it on the driver's side, move the seat backwards and unclip the fasteners.
- ▶ To refit it, position the mat and secure it by pressing.
- ▶ Check that the mat is secured correctly.

**!** To avoid any risk of jamming the pedals:

- Only use mats which are suitable for the fasteners already present in the vehicle; these fasteners must be used.
- Never fit one mat on top of another.

The use of mats not approved by PEUGEOT may interfere with access to the pedals and hinder the operation of the cruise control/speed limiter.

The approved mats have two fasteners located underneath the seat.

## Courtesy lamps

### Non touch-sensitive version

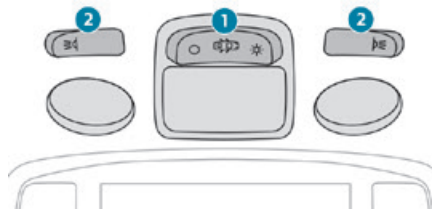

1. Front courtesy lamp

### 2. Front reading lamps

### Front courtesy lamp

 In this position, the courtesy lamp comes on gradually:

- when the vehicle is unlocked.
  - when the key is removed from the ignition switch.
  - when a door is opened.
  - when the remote control locking button is activated, in order to locate the vehicle.
- It switches off gradually:
- when the vehicle is locked.
  - when the ignition is switched on.
  - 30 seconds after the last door is closed.

 Permanently off.

 Permanent lighting.

In "Permanent lighting" mode, the lighting time varies according to the circumstances:

- With the ignition off, approximately 10 minutes.
- In energy saving mode, approximately 30 seconds.
- With the engine running, unlimited.

### Reading lamps

 ▶ With the ignition on, operate the corresponding switch.

**!** Take care not to place anything in contact with the courtesy lamps.

## Touch version with LED

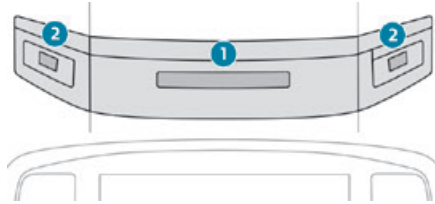

1. Front touch-sensitive courtesy lamp
2. Front touch-sensitive reading lamps

### Front touch-sensitive courtesy lamp

It comes on gradually:

- when the vehicle is unlocked.
- when the ignition is switched off.
- when a door is opened.
- when the remote control locking button is activated, in order to locate the vehicle.

It switches off:

- when the vehicle is locked.
- when the ignition is switched on.
- 30 seconds after the last door is closed.

The front and rear touch-sensitive reading lamps come on and go off at the same time as the courtesy lamp.

A long press on the courtesy lamp completely deactivates it from coming on (confirmed by the "OFF" symbol).

## Touch-sensitive reading lamps

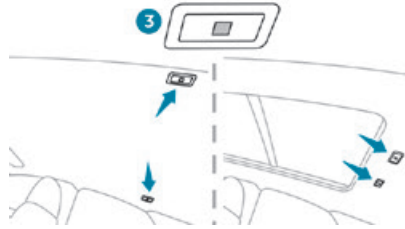

3. Rear touch-sensitive reading lamps

► With the ignition on, press the corresponding reading lamp.

## Interior ambient lighting

The interior ambient lighting casts soft, coloured lighting in the passenger compartment, both day and night.



You can activate/deactivate this function, adjust the brightness and select a colour in the **Driving/Vehicle** touch screen menu.

## Boot fittings

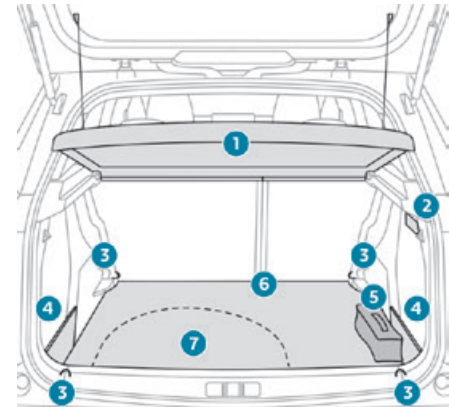

1. Load space cover
2. Boot lamp
3. Stowing rings
4. Open storage wells
5. Tool kit (depending on equipment)
6. Boot carpet or 2-position boot floor
7. Storage well

**i** The stowing rings are designed to secure luggage using different types of retaining nets. These retaining nets are available as an accessory. For more information, contact a PEUGEOT dealer.

## 2-position boot floor

This two-position floor allows the boot volume to be optimised using the lateral stops located on the sides:

- High position (**100 kg max.**): to obtain a flat floor up to the front seats, when the rear seats are folded down.
- Low position (**150 kg max.**): maximum boot volume.

**i** On certain versions, the adjustable boot floor cannot be fitted in the low position.

To change the height:

- ▶ Lift and pull the floor towards you using its central handle, then use the lateral stops to move it.
- ▶ Push the floor all the way forwards to place it in the desired position.

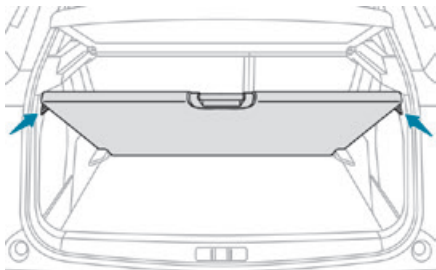

To keep it in the inclined position:

- ▶ From the high position, lift the floor towards the load space cover.

- ▶ Take it past the retractable stops, then rest the floor on these stops.

## Storage well

- ▶ Fully raise the boot carpet to access the storage well.

Depending on version, it includes:

- A temporary puncture repair kit with the tool kit.
- A spare wheel with the tool kit.

## Boot lamp

It comes on automatically when the boot is opened and goes off automatically when the boot is closed.

The lighting time varies according to the circumstances:

- when the ignition is off, approximately 10 minutes.
- in energy economy mode, approximately 30 seconds.
- with the engine running, unlimited.



# Exterior lighting control stalk

## Main lighting

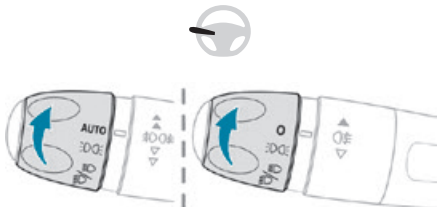

- AUTO** Automatic illumination of lamps/daytime running lamps
- or
- O** Lamps off (ignition off)/ Daytime running lamps (engine running)
- ☾☽** Sidelamps only
- ☾☽** Dipped or main beam headlamps

## Headlamp dipping

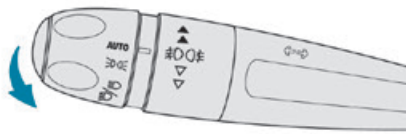

- ▶ Pull the stalk to switch between dipped and main beam headlamps. In the lighting off or "AUTO", depending on version, and sidelamps modes, the driver can switch on the main beam headlamps temporarily ("headlamp flash") by pulling the stalk.

## Displays

Illumination of the corresponding indicator lamp in the instrument panel confirms that the lighting selected is on.

-  A fault with a lamp is signalled by the permanent illumination of this warning lamp, accompanied by the display of a message and an audible signal.

## Rear foglamps

-  They only work if the dipped beam headlamps are on.



- ▶ Rotate the ring forwards to switch them on and backwards to switch them off. When the lamps are switched off automatically ("AUTO" position), the foglamp and the dipped beam headlamps will remain on.

## Front foglamps/Rear foglamps

-  They operate with the sidelamps, dipped or main beam headlamps on.



- ▶ Rotate the ring forwards:
  - once to switch on the front foglamps,
  - a second time to switch on the rear foglamp.
- ▶ Rotate the ring backwards:
  - once to switch off the rear foglamp,
  - a second time to switch off the front foglamps.

If the lighting is switched off automatically ("AUTO" position) or the dipped beam headlamps are switched off manually, the foglamps and sidelamps remain on.

► Rotate the ring backwards to switch the foglamps off; the sidelamps will then switch off.

**!** Switching on the foglamps is prohibited in clear weather or in rain, both day and night. In these situations, the power of their beams may dazzle other drivers. They must only be used in fog or falling snow (rules may vary depending on country). Do not forget to switch off the foglamps when they are no longer necessary.

### **i** Switching off of the lamps when the ignition is switched off

When the ignition is switched off, all of the lamps turn off immediately, except for dipped beam headlamps if automatic guide-me-home lighting is activated.

### **i** Switching on the lamps after switching off the ignition

To reactivate the lighting control, rotate the ring, depending on version, to the "0" position - lamps off, or to the "AUTO" position, then to the desired position.

If the driver's door is opened, a temporary audible signal warns the driver that the lamps are on.

They will go off automatically after a period of time that depends on the state of charge of the battery (entering energy economy mode).

**i** In some weather conditions (e.g. low temperature or humidity), misting on the internal surface of the glass of the headlamps and rear lamps is normal, and will disappear after the lamps have been on for a few minutes.

**!** Never look too closely at the luminous beam of LED or Full LED technology headlamps: risk of serious eye injury!



### **i** Travelling abroad

Vehicles equipped with halogen headlamps:

If planning to use your vehicle in a country that drives on the other side of the road, the headlamp dipped beams must be adjusted to avoid dazzling oncoming drivers. Contact a PEUGEOT dealer or a qualified workshop.

## Daytime running lamps / Sidelamps

These LED lamps at the front and rear of the vehicle light up automatically when the engine starts.

They perform the following functions:

- Daytime running lamps (lighting control stalk at position "0" or "AUTO" with adequate ambient light).
- Sidelamps (lighting control stalk at position "AUTO" with low ambient light or "Sidelamps only" or "Dipped/main beam headlamps").

## Direction indicators

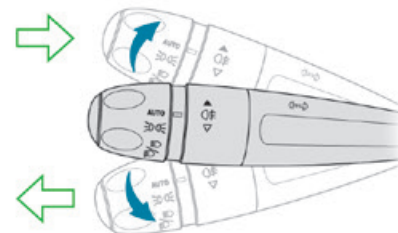

► Left or right: lower or raise the lighting control stalk, beyond the point of resistance.

**i** If you forget to cancel the direction indicators for more than 20 seconds, the volume of the audible signal will increase if the speed is above 50 mph (80 km/h).

## Three flashes

► Press briefly upwards or downwards, without going beyond the point of resistance; the direction indicators will flash 3 times.

## Parking lamps

Vehicle side marking by lighting the sidelamps on the traffic side only.

► Depending on version, within one minute of switching off the ignition, move the lighting control stalk up or down, depending which side the traffic is on (for example, when parking on the left, moving the lighting control stalk upwards turns on the right-hand sidelamps).

This is confirmed by an audible signal and the lighting of the corresponding direction indicator lamp on the instrument panel.

► To switch off the parking lamps, return the lighting control stalk to the central position.

## Headlamp beam height adjustment

### Manually adjusting the halogen or LED technology headlamps

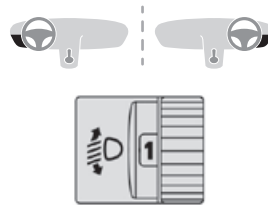

To avoid dazzling other road users, the height of these headlamp beams should be adjusted according to the load in the vehicle.

#### 0 (Initial setting)

Driver only or driver + front passenger

1 5 people

2 5 people + load in the boot

3 Driver only + load in the boot

4 5 6 Not used

This information is provided as a guide only.

Depending on version, the unused positions may be required.

## Automatic adjustment of the Full LED technology headlamps

This system automatically adjusts the height of the headlamp beams according to the load in the vehicle.



In the event of a malfunction, this warning lamp comes on on the instrument panel, accompanied by the display of a message and an audible signal.

The system then places the headlamp beams in the lowest position.

Have the system checked by a PEUGEOT dealer or a qualified workshop.



Do not touch the LED or Full LED technology headlamps - risk of electrocution!

## Automatic illumination of headlamps

When the ring is at the "AUTO" position and a low level of ambient light is detected by the rain/sunshine sensor, the number plate lamps, sidelamps and dipped beam headlamps are switched on automatically, without any action on the part of the driver. They can also come on if rain is detected, at the same time as automatic operation of the windscreen wipers.

As soon as the brightness returns to a sufficient level or after the windscreen wipers are switched off, the lamps are switched off automatically.

## Malfunction



In the event of a malfunction of the rain/sunshine sensor, the vehicle's lighting comes on and this warning lamp is displayed in the instrument panel, accompanied by an audible signal and/or the display of a message. Contact a PEUGEOT dealer or a qualified workshop.



Do not cover the rain/sunshine sensor located at the top centre of the windscreen behind the interior rear view mirror; the associated functions would no longer be controlled.



In fog or snow, the rain/sunshine sensor may detect sufficient light. In this case, the lighting will not come on automatically.

## Guide-me-home and welcome lighting

### Guide-me-home lighting

#### Automatic

With the ring in the "AUTO" position, when the light is poor, the dipped beam headlamps come

on automatically when the ignition is switched off.



You can activate/deactivate this function and adjust the guide-me-home lighting duration in the **Driving / Vehicle** touch screen menu.

#### Manual

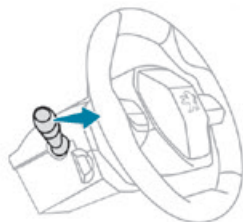

► With the ignition off, pull the lighting control stalk toward you ("headlamp flash") to activate/deactivate the function.

Manual guide-me-home lighting goes off automatically after a period of time.

### Welcome lighting

When the vehicle is unlocked, if the ambient light is low and the "Automatic illumination of headlamps" function is activated, this system automatically turns on certain exterior lamps as well as certain lamps in the passenger compartment.



You can activate/deactivate this function and adjust the welcome lighting duration in the **Driving / Vehicle** touch screen menu.

## Door mirror spotlamps

These spotlamps facilitate access to the vehicle by lighting the ground near the front doors.

The spotlamps come on automatically:

- when the vehicle is unlocked.
- when a door is opened.
- when a request to locate the vehicle is received from the remote control.

They also come on with the welcome lighting and guide-me-home lighting functions.

They go off automatically after 30 seconds.

## Automatic headlamp dipping

When the ring is in the "AUTO" position, this system automatically switches between dipped and main beam headlamps according to the lighting and traffic conditions, using a camera located at the top of the windscreen.

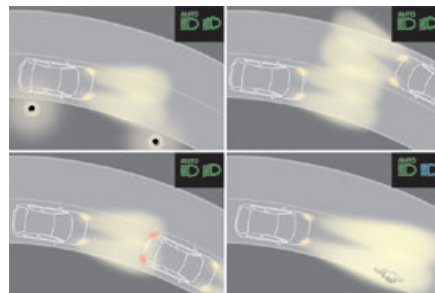

**!** This system is a driving aid.  
The driver remains responsible for the vehicle's lighting, its correct use for the prevailing conditions of light, visibility and traffic, and for observation of driving and vehicle regulations.

**i** The system becomes operational when the vehicle exceeds 16 mph (25 km/h). When the speed falls below 9 mph (15 km/h), the function is no longer operational.

## Activation/Deactivation



It is set via the **Driving / Vehicle** touch screen menu.

The state of the system stays in the memory when switching off the ignition.

## Operation

If the ambient light level is sufficient and/or the traffic conditions do not allow the main beam headlamps to be lit:



– The dipped beam headlamps remain lit. These indicator lamps come on on the instrument panel.

If the ambient light level is very low and traffic conditions permit:



– The main beam headlamps come on automatically. These indicator lamps come on on the instrument panel.

The function is deactivated if the foglamps are switched on.

When the foglamps are switched off, the function is automatically reactivated.



This indicator lamp goes out when the function is deactivated.

## Pause

If the situation requires a change of headlamp beam, the driver can take over at any time.

- ▶ A "headlamp flash" pauses the function:
  - if the "AUTO" and "Dipped beam" indicator lamps were on, the system changes to main beam,
  - if the "AUTO" and "Main beam" indicator lamps were on, the system changes to dipped beam.

To reactivate the system, flash the headlamps again.



The system may suffer interference or not work correctly:

- under conditions of poor visibility (snow, heavy rain, etc.),
- if the windscreen in front of the camera is dirty, misted or obscured (for example, by a sticker, etc.),
- if the vehicle is facing highly reflective signs.

When the system detects thick fog, it temporarily deactivates the function.

The system is not able to detect:

- road users that do not have their own lighting, such as pedestrians,
- vehicles whose lighting is obscured (for example: vehicles running behind a safety barrier on a motorway),
- vehicles at the top or bottom of a steep slope, on winding roads, on crossroads.



Clean the windscreen regularly, particularly the area in front of the camera.

The internal surface of the windscreen can also become misted around the camera. In humid and cold weather, demist the windscreen regularly.

Do not allow snow to accumulate on the bonnet or roof of the vehicle as this could obstruct the detection camera.

## Cornering lighting

This system makes use of the beam from a front foglamp to illuminate the inside of a bend, when the main or dipped beam headlamps are on and the vehicle speed is below 25 mph (40 km/h) (urban driving, winding road, junctions, parking manoeuvres).



Without/With cornering lighting

## Activation / Deactivation



It is set via the **Driving / Vehicle** touch screen menu.

## Switching on / off

This system starts:

- when the corresponding direction indicator is switched on.

or

- from a certain angle of rotation of the steering wheel.

It becomes inactive:

- below a certain angle of rotation of the steering wheel.
- above 25 mph (40 km/h).
- when reverse gear is engaged.

## Wiper control stalk

**i** Before operating the wipers in wintry conditions, clear any snow, ice or frost from the windscreen, and from around the wiper arms and blades.

**!** Do not operate the wipers on a dry windscreen. In extremely hot or cold weather, check that the wiper blades are not stuck to the windscreen before operating the wipers.

**i** After using an automatic car wash, you may temporarily notice abnormal noises and poorer wiping performance. You do not need to replace the wiper blades.

## Without AUTO wiping

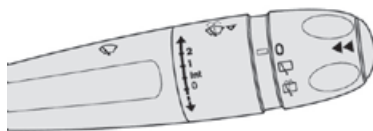

## With AUTO wiping

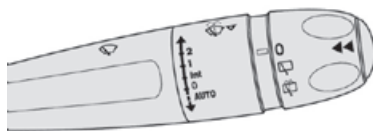

## Windscreen wipers

► To select the wiping speed: raise or lower the stalk to the desired position.

- 2** Fast wiping (heavy rain)
- 1** Normal wiping (moderate rain)
- Int** Intermittent wiping (proportional to the vehicle's speed)
- 0** Off
- ↓** Single wipe (press down and release).

or

**AUTO ↓** Automatic.

Refer to the corresponding section.

**i** If the ignition has been switched off with the windscreen wiper active, it is necessary to operate the control stalk to reactivate the wiping when the ignition is switched on (unless the ignition is off for less than 1 minute).

**i** In position **1** or **2**, the wiping frequency is automatically reduced when the speed of the vehicle drops below 3 mph (5 km/h). When the speed is above 6 mph (10 km/h) again, the wiping frequency returns to the original frequency (fast or normal).

## Single wipe

- ▶ Pull the stalk briefly towards you.

## Front screenwash

- ▶ Pull the wiper control stalk towards you and hold.

The screenwash and windscreen wipers operate for as long as the control stalk is pulled. A final wiping cycle is performed when screenwashing ends.

**i** With automatic air conditioning, any action on the screenwash control results in temporary closure of the air intake to avoid odours inside the passenger compartment.

**!** To avoid damaging the wiper blades, do not operate the screenwash if the screenwash reservoir is empty. Only operate the screenwash if there is no risk of the fluid freezing on the windscreen and hindering visibility. During the winter period, use "very cold climate" rated products. Never top up with water.

## Rear wiper

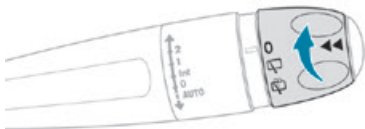

- ▶ Turn the ring to align the desired symbol with the marking.

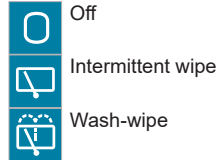

## Reverse gear

When reverse gear is engaged, the rear wiper will come into operation automatically if the front windscreen wipers are operating.

 This function is set via the **Driving / Vehicle** touch screen menu.

**!** In the event of accumulation of snow or hard frost or if a bicycle carrier is fitted to a towing system, deactivate the automatic rear wiper via the touch screen's **Driving / Vehicle** menu.

## Rear screenwash

- ▶ Turn the ring all the way towards the dashboard and hold.
- The screenwash and the wiper operate for as long as the ring remains turned. A final wiping cycle is performed when screenwashing ends.

## Special position of the windscreen wipers

This maintenance position is used while cleaning or replacing the wiper blades. It can also be useful, in wintry weather (ice, snow), to release the wiper blades from the windscreen.

- i** To maintain the effectiveness of the flat wiper blades, it is advisable to:
- handle them with care.
  - clean them regularly using soapy water.
  - avoid using them to hold cardboard on the windscreen.
  - replace them at the first signs of wear.

## Before removing a windscreen wiper blade

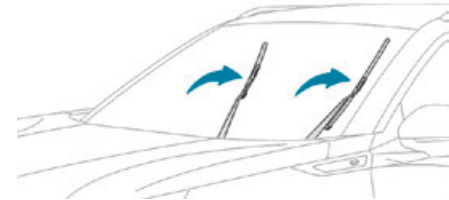

- ▶ Operating the wiper control stalk within one minute after switching off the ignition will place the wiper blades in a vertical position.
- ▶ Proceed with the desired operation or the replacement of the wiper blades.

### After refitting a windscreen wiper blade

- ▶ To return the wiper blades to their initial position, switch on the ignition and operate the wiper control stalk.

## Changing a wiper blade

### Removing/refitting at the front

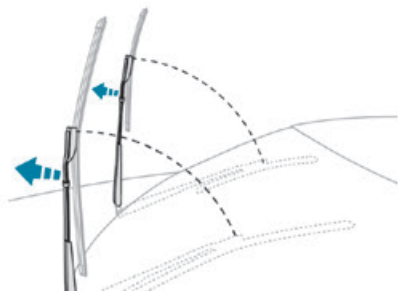

- ▶ Carry out these wiper blade replacement operations from the driver's side.
- ▶ Starting with the wiper blade farthest from you, hold each arm by the rigid section and raise it as far as possible.

**!** Do not touch the wiper blades - risk of irreversible distortion.

Do not release them while they are moving - risk of damaging the windscreen!

- ▶ Clean the windscreen using screenwash fluid.

**i** Do not apply "Rain X" type water-repellent products.

- ▶ Unclip the worn wiper blade closest to you and remove it.
- ▶ Install the new wiper blade and clip it to the arm.
- ▶ Repeat the procedure for the other wiper blade.
- ▶ Starting with the wiper blade closest to you, once again hold each arm by the rigid section and lower it carefully to the windscreen.

### Removing/refitting at the rear

- ▶ Hold the arm by the rigid section and raise it as far as possible.
- ▶ Clean the rear screen using screenwash fluid.
- ▶ Unclip the worn wiper blade and remove it.
- ▶ Install the new wiper blade and clip it to the arm.
- ▶ Once again hold the arm by the rigid section, then guide it carefully onto the rear screen.

## Automatic windscreen wipers

In AUTO mode, the windscreen wipers operate automatically, without any action on the part of the driver. If rain is detected, the wiping adapts to the intensity of the rainfall automatically.

Detection of rainfall is by means of a rain/sunshine sensor at the top centre of the windscreen, behind the rear view mirror.

**!** Do not cover the rain/sunshine sensor. When using an automatic car wash, switch off the automatic wipers and the ignition.

In winter, wait until the windscreen is completely clear of ice before activating the automatic wipers.

## Switching on

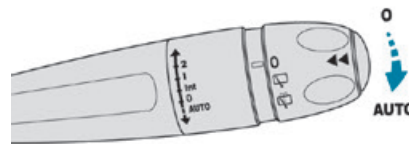

- ▶ Give a short downwards push to the control stalk.

A wiping cycle confirms that the instruction has been accepted.



This indicator lamp comes on in the instrument panel, accompanied by a message.

## Switching off

- ▶ Give the control stalk another brief push downwards or place the control stalk in another position (Int, 1 or 2).





This indicator lamp goes off in the instrument panel, accompanied by a message.

**i** If the ignition has been off for more than one minute, the automatic wipers must be reactivated by pushing the control stalk downwards.

## Malfunction

If a fault occurs with the automatic wipers, the wipers will operate in intermittent mode. Have them checked by a PEUGEOT dealer or a qualified workshop.

## General safety recommendations

**!** Do not remove the labels attached in different places on your vehicle. They include safety warnings as well as identification information for the vehicle.

**!** For all work on your vehicle, use a qualified workshop that has the technical information, skills and equipment required, all of which a PEUGEOT dealer is able to provide.

**!** Depending on country regulations, certain safety equipment may be mandatory: high visibility safety vests, warning triangles, breathalysers, spare bulbs, spare fuses, fire extinguisher, first aid kit, mud flaps at the rear of the vehicle, etc.

**!** **Installing electrical accessories:**

- The fitting of electrical equipment or accessories not approved by PEUGEOT may cause excessive current consumption and faults and failures with the electrical system of your vehicle. Contact a PEUGEOT dealer for information on the range of approved accessories.
- As a safety measure, access to the diagnostic socket, used for the vehicle's electronic systems, is reserved strictly for

PEUGEOT dealers or qualified workshops, equipped with the special tools required (risk of malfunctions of the vehicle's electronic systems that could cause breakdowns or serious accidents). The Manufacturer cannot be held responsible if this advice is not followed.

- Any modification or adaptation not intended or authorised by PEUGEOT or carried out without meeting the technical requirements defined by the Manufacturer will result in the suspension of the commercial warranty.

### **!** Installation of accessory radio communication transmitters

Before installing a radio communication transmitter with an external aerial, you must without fail contact a PEUGEOT dealer for the specification of transmitters which can be fitted (frequency, maximum power, aerial position, specific installation requirements), in line with the Vehicle Electromagnetic Compatibility Directive (2004/104/EC).

### **i** Declarations of conformity for radio equipment

The relevant certificates are available on the <http://public.servicebox.peugeot.com/APddb/> website.

## Hazard warning lamps



► Pressing the red button causes all the direction indicators to flash. They can operate with the ignition off.

## Automatic operation of hazard warning lamps

When braking in an emergency, depending on the rate of deceleration, the hazard warning lamps come on automatically. They switch off automatically when you next accelerate. It is also possible to switch them off by pressing the button.

## Horn



- ▶ Press the central part of the steering wheel.

## Pedestrian horn (Electric)

The pedestrian horn operates once the vehicle is moving and at speeds of up to 19 mph (30 km/h), in forward or reverse gear.

### Malfunction



In the event of a malfunction, this warning lamp comes on on the instrument panel. Contact a PEUGEOT dealer or a qualified workshop to have the system checked.

## Emergency or assistance call

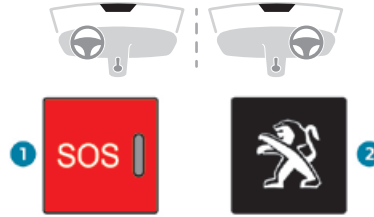

## Peugeot Connect SOS (PE112)

- ▶ In an emergency, press button 1 for more than 2 seconds. The lighting of the indicator lamp and a voice message confirm that the call has been made to the emergency services\*.
- 'Peugeot Connect SOS' immediately locates your vehicle and puts you in contact with the appropriate emergency services\*\*.
- ▶ Pressing again immediately cancels the request. The indicator lamp flashes when the vehicle data is sent, and then remains lit when communication is established.

! If an impact is detected by the airbag control unit, an emergency call is made automatically, independently of the deployment of any airbags.

i 'Peugeot Connect SOS' is a service that can be accessed free of charge.

### System operation

- Upon switching on the ignition, if the indicator lamp lights up red, then green, and then goes out: the system is operating correctly.
  - If the indicator lamp is fixed red: system malfunction
  - If the indicator lamp flashes red: replace the emergency battery.
- In the latter two cases, emergency and assistance call services may not work. Contact a dealer or a qualified repairer as soon as possible.

i The system fault does not prevent the vehicle from being driven.

### Data processing

i All processing of personal information by the "Peugeot Connect SOS" system (PE112) complies with the framework for protection

\* In accordance with the general conditions of use of the service, available from dealers and subject to technological and technical limitations.

\*\* In areas covered by 'Peugeot Connect SOS' and 'Peugeot Connect Assistance'.

The list of countries covered and telematic services provided is available from dealers or on the website for your country.

of personal information established by Regulation 2016/679 (GDPR) and Directive 2002/58/EC of the European Parliament and the Council, and in particular, seeks to protect the vital interests of the data subject, in accordance with Article 6.1, paragraph d) of Regulation 2016/679.

Personal information processing is strictly limited to the management of the "Peugeot Connect SOS" system used with the "112" European single emergency call number. The "Peugeot Connect SOS" system is able to collect and process only the following data relating to the vehicle: chassis number, type (passenger vehicle or light commercial vehicle), fuel type or power source, most recent three locations and direction of travel, and a timestamped log file recording the automatic activation of the system. The recipients of the processed data are the emergency call handling centres designated by the relevant national authorities in the territory in which they are located, enabling priority reception and handling of calls to the "112" emergency number.

#### Data storage

Data contained in the system's memory is not accessible from outside the system until

a call is made. The system is not traceable and is not continuously monitored in its normal operating mode.

The data in the system's internal memory is automatically and continuously erased. Only the vehicle's three most recent locations are stored.

When an emergency call is triggered, the data log is stored for no more than 13 hours.

#### Access to data

You have the right to access the data and, if necessary, submit a request to rectify, erase or restrict the processing of any personal information not processed in accordance with the provisions of Regulation 2016/679 (GDPR). Third parties to which data has been communicated shall be notified of any rectification, erasure or restriction carried out in accordance with the aforementioned Directive, unless doing so would be impossible or require a disproportionate effort. You also have the right to lodge a complaint with the relevant data protection authority.

## Peugeot Connect Assistance

- ▶ If the vehicle breaks down, press button **2** for more than 2 seconds to request assistance (confirmed by a voice message\*).
- ▶ Pressing again immediately cancels the request.

 Privacy mode allows you to manage the level of sharing (data and/or position) between your vehicle and the PEUGEOT brand.

It can be configured in the **Settings** menu on the touch screen.

By default, depending on equipment, deactivate/reactivate geolocation by simultaneously pressing the 2 buttons, then press the "Peugeot Connect Assistance" button to confirm.

 If you purchased your vehicle outside the PEUGEOT dealer network, we invite you to have a dealer check the configuration of these services and, if desired, modify them to suit your wishes. In a multilingual country, configuration is possible in the official national language of your choice.

\* According to the geographic coverage of 'Peugeot Connect SOS', 'Peugeot Connect Assistance' and the official national language chosen by the owner of the vehicle.

The list of countries covered and telematic services provided is available from dealers or on the website for your country.

**i** For technical reasons, in particular to improve the quality of telematic services for customers, the Manufacturer reserves the right to carry out updates to the vehicle's on-board telematic system at any time.

**i** If you benefit from the Peugeot Connect Packs offer with the SOS and Assistance Pack included, there are additional services available to you in your personal space, via the website for your country. For information about the SOS and Assistance Pack, please refer to the general conditions for these services.

## Electronic stability control (ESC)

The electronic stability control programme includes the following systems:

- Anti-lock braking system (ABS) and Electronic brake force distribution (EBFD).
- Emergency braking assistance (EBA).
- Anti-slip regulation (ASR).
- Dynamic stability control (DSC).
- Trailer stability assist (TSA).

## Anti-lock braking system (ABS) and Electronic brake force distribution (EBFD)

These systems enhance the vehicle's stability and handling during braking, and enable greater control while cornering, particularly on poor or slippery road surfaces.

ABS prevents wheel locking in the event of emergency braking.

EBFD manages the braking pressure wheel by wheel.



This warning lamp comes on fixed in the event of an ABS malfunction.

The vehicle retains conventional braking. Drive carefully at a moderate speed.

Contact a PEUGEOT dealer or a qualified workshop as soon as possible.



This warning lamp, when lit together with the **STOP** and ABS warning lamps, accompanied by a message and an audible signal, indicates an EBFD malfunction.

**You must stop as soon as it is safe to do so.** Contact a PEUGEOT dealer or a qualified workshop.

**i** The normal operation of the ABS may result in slight vibrations in the brake pedal.

**!** **When braking in an emergency, press very firmly and maintain this pressure.**

**!** When changing wheels (tyres and rims), ensure that these are approved for your vehicle.

**!** After an impact, have these systems checked by a PEUGEOT dealer or a qualified workshop.

## Emergency braking assistance (EBA)

In an emergency, this system enables you to reach the optimum braking pressure more quickly and therefore reduce the stopping distance.

It is triggered in relation to the speed at which the brake pedal is pressed. This is felt by a reduction in the resistance of the pedal and an increase in braking efficiency.

## Anti-slip regulation (ASR) / Dynamic stability control (DSC)

Anti-slip regulation optimises traction using engine braking and by applying the brakes on the driving wheels to avoid wheel spinning. It also enhances the vehicle's directional stability while accelerating.

If there is a difference between the vehicle's trajectory and the path desired by the driver, the dynamic stability control system automatically uses engine braking and the brakes on one or

more wheels to return the vehicle to the desired path, within the limits of the laws of physics.

These systems are activated automatically every time the vehicle is started.

They come into operation in the event of a grip or trajectory problem.



This warning lamp on the instrument panel flashes to indicate that they are operating.

## Deactivation / Reactivation

In exceptional conditions (starting a vehicle stuck in mud, immobilised in snow, on soft ground, etc.), it may be useful to deactivate the ASR system to freely spin the wheels and regain traction.

Reactivate the system as soon as the level of grip permits.



It is set via the **Driving / Vehicle** touch screen menu.



Deactivation is confirmed by the illumination of this indicator lamp in the instrument panel and the display of a message.

The ASR system is reactivated automatically every time the ignition is switched back on or from 31 mph (50 km/h).

Reactivation is manual below 31 mph (50 km/h).

## Malfuction



In the event of a system malfuction, this warning lamp comes on, accompanied by an onscreen message and audible signal.

Contact a PEUGEOT dealer or a qualified workshop to have the systems checked.

### ! ASR / DSC

These systems enhance safety during normal driving, but should not encourage the driver to take extra risks or drive at high speed.

It is in conditions of reduced grip (rain, snow, ice) that the risk of loss of grip increases. It is therefore important for your safety to keep these systems activated in all conditions, and particularly in difficult conditions.

Correct operation of these systems depends on compliance with the manufacturer's recommendations relating to the wheels (tyres and rims), braking and electronic components, as well as the assembly and repair procedures used by PEUGEOT dealers.

The use of snow tyres is recommended, to ensure that these systems remain effective in winter conditions. All four wheels must be fitted with tyres approved for the vehicle.

## Trailer stability assist (TSA)

When towing, this system reduces the risk of the vehicle or trailer snaking.

### Operation

The system is activated automatically when the ignition is switched on.

The electronic stability control system (ESC) must not have any faults.

Between 37 and 99 mph (60 and 160 km/h), if the system detects oscillations (snaking) in the movement of the trailer, it acts on the brakes to stabilise the trailer and, if necessary, reduces engine power to slow down the vehicle.



This warning lamp flashes in the instrument panel and the brake lamps light up to draw attention to this corrective action.

For information on towed loads and masses, refer to the **Technical data** section or your vehicle's registration certificate

To ensure complete safety while driving with a **Towing device**, refer to the corresponding section.

## Malfuction



If a fault occurs, this warning lamp comes on in the instrument panel, accompanied by a message and an audible signal.

If you wish to continue towing a trailer, reduce your speed and drive carefully!

Contact a PEUGEOT dealer or a qualified workshop to have the system checked.

! The trailer stability assist system offers enhanced safety in normal driving, provided that the recommendations on towing a trailer are observed. It should not encourage the driver to take risks, such as towing a trailer in adverse operating conditions (overloading, failure to observe the

trailer nose weight, worn or under-inflated tyres, faulty braking system, etc.), or to drive at excessive speeds.

In certain cases, the system may not detect trailer snaking, particularly with a light trailer. When driving on slippery or poor surfaces, the system may not be able to prevent sudden trailer snaking.

## Advanced Grip Control

This special patented traction control system improves grip on snow, mud and sand.

**i** For optimum grip on snow, it is recommended that you fit the vehicle with winter tyres.

For optimum system performance, contact a PEUGEOT dealer for advice on the right tyre fitting.

### **i** Recommendations

The vehicle is designed principally to drive on tarmac roads, but it allows you to occasionally drive on other less passable terrain.

However, it does not permit off-road driving such as:

- driving on terrain which could damage the underbody or strip away components (fuel pipe, fuel cooler, etc.) due to obstacles or stones in particular,

- driving on terrain with steep gradients and poor grip,
- crossing a waterway.

## Operating modes

### Snow

This mode adapts its strategy to the conditions of grip encountered for each of the two front wheels on moving off.

(mode active up to 50 mph (80 km/h))

### Mud

This mode, when moving off, allows considerable spin on the wheel with the least grip to optimise clearing of the mud and to regain grip. At the same time, the wheel with the most grip is controlled in such a way as to transmit as much torque as possible.

When moving, the system optimises wheel spin to respond to the driver's requirements as fully as possible.

(mode active up to 31 mph (50 km/h))

### Sand

This mode allows little spin on the two driving wheels at the same time to allow the vehicle to move forward and limit the risks of getting stuck in the sand.

(mode active up to 75 mph (120 km/h))

- !** Do not use the other modes on sand as the vehicle may become stuck.

## Activation/Deactivation

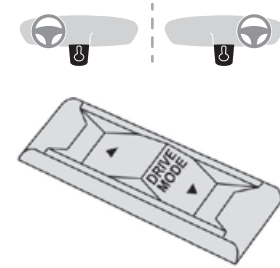

► Press the **DRIVE MODE** button to choose one of the three driving modes; the different modes are displayed in the instrument panel.

► Depending on the circumstances, select "**Snow**", "**Mud**" or "**Sand**".

The chosen mode continues to be displayed in the instrument panel.

► To deactivate, select "**Normal**" mode or any other driving mode.

The system is automatically deactivated when the ignition is switched off.

## Hill Assist Descent Control

System that provides assistance when descending on loose or soft surfaces (gravel, mud, etc.) or a steep gradient.

This system reduces the risk of slip or loss of control of the vehicle when descending, whether going forward or in reverse.

During a descent, it assists the driver in maintaining a constant speed, depending on the gear engaged, while progressively releasing the brakes.

**i** For the system to activate, the gradient must be greater than 5%.

The system can be used with the gearbox in neutral.

Otherwise, engage a gear corresponding to the speed to prevent the engine stalling.

With an automatic gearbox, the system can be used with the selector at **N**, **D** or **R**.

**!** When the system is regulating, the Active Safety Brake system is automatically deactivated.

**i** The system is no longer available:

- if the speed of the vehicle is above 43 mph (70 km/h),
- if the speed of the vehicle is being controlled by the Adaptive Cruise Control, depending on the type of gearbox.

## Switching on

By default, the system is not selected.

The state of the function is not saved when the ignition is switched off.

The driver can select the system when the engine is running, when the vehicle is stationary or when moving at speeds up to approximately 31 mph (50 km/h).

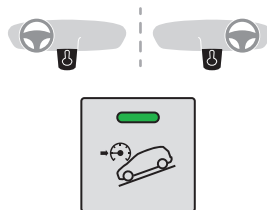

▶ To select the system, at speeds below 31 mph (50 km/h), press this button until its green indicator lamp comes on; this lamp appears in grey in the instrument panel.



▶ The system becomes active at speeds below 19 mph (30 km/h); this lamp comes on in green in the instrument panel.

▶ When the vehicle begins its descent, you can release the accelerator and brake pedals; the system regulates the speed:



– if the gearbox is in first or second gear, the speed decreases and the indicator lamp flashes rapidly,

– if the gearbox is in neutral or if the clutch pedal is depressed, the speed decreases and the indicator lamp flashes slowly; in this case, the maintained descent speed is lower.

On a descent, with the vehicle stationary, if you release the accelerator and brake pedals, the

system will release the brakes to set the vehicle gradually in motion.

The brake lamps light up automatically when the system is regulating.

If the speed exceeds 19 mph (30 km/h), regulation is paused automatically, the indicator lamp goes back to grey in the instrument panel, but the green indicator lamp in the button remains on.

Regulation resumes automatically when the speed falls below 19 mph (30 km/h) again, if the slope and pedal release conditions are met.

You can depress the accelerator or brake pedal again at any time.

## Off

▶ Press the button until its indicator lamp goes off; the indicator lamp on the instrument panel also goes off.

At speeds above 43 mph (70 km/h), the system is automatically deactivated; the indicator lamp in the button goes off.

## Malfunction



If a fault occurs with the system, this warning lamp comes on in green, accompanied by the display of a message in the instrument panel.

Have the system checked by a PEUGEOT dealer or a qualified workshop.



## Seat belts

### Inertia reel

The seat belts are equipped with an inertia reel which allows the strap length to automatically adjust to your shape. The seat belt returns to its storage automatically when it is not used.

The inertia reels are fitted with a device which automatically locks the strap in the event of a collision, emergency braking or if the vehicle rolls over. It can be released by pulling the strap firmly and then releasing it so that it reels in slightly.

### Pyrotechnic pretensioning

This system improves safety in the event of a frontal or side impact.

Depending on the severity of the impact, the pyrotechnic pretensioning system instantly tightens the seat belts against the body of the occupants.

The pyrotechnic pretensioning seat belts are enabled when the ignition is on.

### Force limiter

This system reduces the pressure of the seat belt on the chest of the occupant, thus improving their protection.

### ! In the event of an impact

Depending on the nature and seriousness of impacts, the pyrotechnic pretensioner device may trigger before and independently of airbag deployment. Deployment of the pretensioners is accompanied by a slight discharge of harmless smoke and a noise, due to the

activation of the pyrotechnic cartridge incorporated in the system.

In all cases, the airbag warning lamp comes on.

Following an impact, have the seat belt system checked, and if necessary replaced, by a PEUGEOT dealer or a qualified workshop.

## Front seat belts

The front seat belts are fitted with a pyrotechnic pretensioning system, depending on version, and a force limiting system.

## Rear seat belts

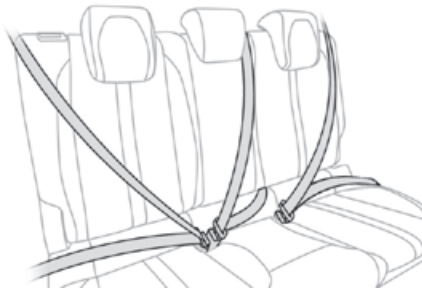

Each of the rear seats has a three-point seat belt with inertia reel.

The outer seats are fitted, depending on the version, with a pyrotechnic pretensioning and force limiting system.

## Fastening

- ▶ Pull the strap, then insert the tongue in the buckle.
- ▶ Check that the seat belt is fastened correctly by pulling the strap.

## Unlocking

- ▶ Press the red button on the buckle.
- ▶ Guide the seat belt as it is reeled in.

## Seat belt not fastened/ unfastened alerts

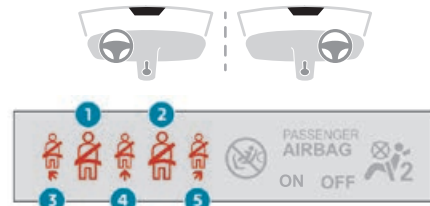

1. Front left seat belt warning lamp
2. Front right seat belt warning lamp
3. Rear left seat belt warning lamp
4. Rear centre seat belt warning lamp
5. Rear right seat belt warning lamp

If the corresponding seat belt is not fastened or is unfastened, when the ignition is switched on, the seat belts warning lamp comes on in the instrument panel and the corresponding warning lamp (1 to 5) comes on in red in the seat belt and front passenger airbag warning lamps display.

**I** If a rear seat belt is not fastened, the corresponding warning lamp (3 to 5) comes on for around 30 seconds.

From about 12 mph (20 km/h) and for 2 minutes, each warning lamp corresponding to an occupied seat whose seat belt is unfastened flashes, accompanied by an audible signal. After these 2 minutes, the corresponding seat warning lamp remains on until the driver or the front/rear passenger fasten their seat belt.

## Advice

**!** The driver must ensure that passengers use the seat belts correctly and that they are all fastened before setting off. Wherever seated in the vehicle, you must always fasten the seat belt, even for short journeys.

Do not interchange the seat belt buckles, as they will not fulfil their role fully. Before and after use, ensure that the seat belt is reeled in correctly.

After folding or moving a seat or rear bench seat, ensure that the seat belt is positioned and reeled in correctly.

### **!** Installation

The lower part of the strap must be positioned as low as possible on the pelvis. The upper part must be positioned in the hollow of the shoulder.

In order to be effective, a seat belt:

- must be tightened as close to the body as possible;
- must be pulled in front of you with a smooth movement, ensuring that it is not twisted;
- must only be used to secure one person;
- must not show signs of tearing or fraying;
- must not be changed or modified, in order to avoid affecting its performance.

### **!** Recommendations for children

Use a suitable child seat if the passenger is less than 12 years old or shorter than one and a half metres. Never use the same seat belt to secure more than one child. Never carry a child on your lap. For more information on **Child seats**, refer to the corresponding section.

### **!** Maintenance

In accordance with current safety regulations, for all repairs on your vehicle's seat belts, go to a qualified workshop with the skills and equipment needed, which a PEUGEOT dealer is able to provide. Have the seat belts checked regularly by a PEUGEOT dealer or a qualified workshop, particularly if the straps show signs of damage.

Clean the seat belt straps with soapy water or a textile cleaning product, sold by PEUGEOT dealers.

## Airbags

### General information

System designed to help improve the safety of the occupants sitting in the front seats and the rear outer seats, in the event of a violent collision. The airbags supplement the action of the seat belts equipped with a force limiting system.

Electronic detectors record and analyse the front and side impacts sustained in the impact detection zones:

- In the event of violent impact, the airbags deploy instantly and help better protect the occupants of the vehicle; immediately after the impact, the airbags deflate rapidly in order not to hinder the visibility or the possible exit of the occupants.
  - In the event of a slight impact, a rear impact and under certain rollover conditions, the airbags may not deploy; only the seat belt helps to protect you in these situations.
- The seriousness of the impact depends on the nature of the obstacle and the speed of the vehicle at the moment of collision.

**! The airbags do not operate when the ignition is switched off.**

This equipment will only deploy once. If a second impact occurs (during the same or a subsequent accident), the airbag will not be deployed again.

### Impact detection zones

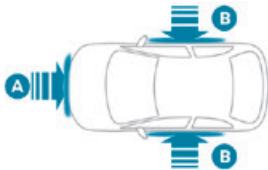

- A. Front impact zone
- B. Side impact zone

**i** When one or more airbags are deployed, the detonation of the pyrotechnic charge incorporated in the system makes a noise and releases a small quantity of smoke. This smoke is not harmful, but sensitive individuals may experience slight irritation. The detonation noise associated with the deployment of one or more airbags may result in a slight loss of hearing for a short time.

## Front airbags

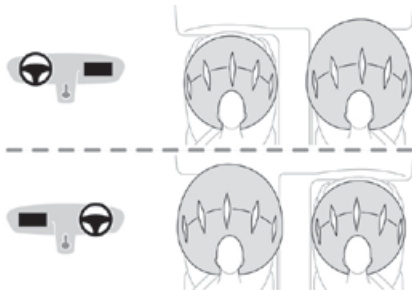

This system protects the driver and front passenger in the event of a serious front impact, in order to limit the risk of head and chest injuries.

The driver's airbag is fitted in the centre of the steering wheel; the front passenger airbag is fitted in the dashboard above the glove box.

**i** The front airbags are adaptive. In particular, they inflate less firmly in the presence of a smaller occupant, with the seat set in a forward longitudinal position.

### Deployment

They deploy, except the front passenger airbag if it is deactivated\*, in the event of a serious front impact to all or part of the front impact zone **A**.

The front airbag inflates between the thorax and head of the front occupant of the vehicle and the steering wheel, driver's side, and the dashboard, passenger's side, to cushion their forward movement.

## Lateral airbags

In the event of a serious side impact, this system protects the driver and the passengers to mitigate the risk of injury to the chest, between the hip and the shoulder.

At the front, each lateral airbag is fitted in the seat backrest frame, on the door side. At the rear, each lateral airbag is fitted in the rear pillar.

### Deployment

They are deployed on one side in the event of a serious side impact applied to all or part of the side impact zone **B**.

The lateral airbag inflates between the hip and shoulder of the vehicle's occupant and the corresponding door trim panel.

## Curtain airbags

System contributing towards greater protection for the driver and passengers (with the exception of the rear centre passenger) in the event of a serious side impact in order to limit the risk of injury to the side of the head.

Each curtain airbag is built into the pillars and the upper passenger compartment area.

\* For more information on Deactivating the front passenger airbag, refer to the corresponding section.

## Deployment

It deploys simultaneously with the corresponding lateral airbag in the event of a serious side impact applied to all or part of the side impact zone **B**.

The curtain airbag inflates between the front and rear occupants of the vehicle and the corresponding windows.

## Malfuction



If this warning lamp comes on in the instrument panel, you must contact a PEUGEOT dealer or a qualified workshop to have the system checked.

The airbags may not be deployed in the event of a serious impact.



In the event of a minor impact or bump at the side of the vehicle or if the vehicle rolls over, the airbags may not be deployed. In the event of a rear or front collision, none of the lateral airbags are deployed.

## Advice



**For the airbags to be fully effective, observe the safety recommendations below.**

Adopt a normal upright sitting position.

Fasten the seat belt ensuring it is correctly positioned and adjusted.

Do not leave anything between the occupants and the airbags (a child, pet, object, etc.), nor

fix or attach anything close to or in the way of the airbag release trajectory; this could cause injuries during their deployment.

Never modify the original definition of your vehicle, particularly in the area directly around the airbags.

After an accident or if the vehicle has been stolen, have the airbag systems checked.

All work on the airbag systems must only be performed by a PEUGEOT dealer or a qualified workshop.

Even if all of the precautions mentioned are observed, a risk of injury or of minor burns to the head, chest or arms cannot be ruled out when an airbag is deployed. The airbag inflates almost instantly (within a few milliseconds) then deflates within the same time discharging the hot gas via openings provided for this purpose.



### Front airbags

Do not drive holding the steering wheel by its spokes or resting your hands on the centre part of the wheel.

Passengers must not place their feet on the dashboard.

Do not smoke as deployment of the airbags can cause burns or the risk of injury from a cigarette or pipe.

Never remove or pierce the steering wheel or hit it violently.

Do not fix or attach anything to the steering wheel or dashboard, as this could cause injuries when the airbags are deployed.



### Lateral airbags

Use only approved covers on the seats, compatible with the deployment of the lateral airbags. For information on the range of seat covers suitable for your vehicle, contact a PEUGEOT dealer.

Do not fix or attach anything to the seat backrests (clothes, etc.), as this could cause injuries to the thorax or arm when the lateral airbag is deployed.

Do not sit with the upper part of the body any nearer to the door than necessary.

The vehicle's front door panels include side impact sensors.

A damaged door or any unauthorised or incorrectly executed work (modification or repair) on the front doors or their interior trim could compromise the operation of these sensors - risk of malfunction of the lateral airbags!

Such work must only be done by a PEUGEOT dealer or a qualified workshop.



### Curtain airbags

Do not fix or attach anything to the roof, as this could cause head injuries when the curtain airbag is deployed.

Do not remove the grab handles installed on the roof, as they play a part in securing the curtain airbags.

## Child seats

**i** The regulations on carrying children are specific to each country. Refer to the legislation in force in your country.

For maximum safety, please observe the following recommendations:

- In accordance with European regulations, **all children under the age of 12 or less than 4 ft 11" (150 cm) tall must travel in approved child seats suited to their weight**, on seats fitted with a seat belt or ISOFIX mountings.
- **Statistically, the safest seats in your vehicle for carrying children are the rear seats.**
- **Children weighing less than 9 kg must travel in the "rear facing" position, whether in the front or rear of the vehicle.**

**i** It is recommended that children travel on the **rear seats** of the vehicle:

- 'rear facing' up to the age of 3,
- 'forward facing' over the age of 3.

**!** Make sure that the seat belt is correctly positioned and tightened.  
For child seats with a support leg, ensure that the support leg is in firm and steady contact with the floor.

## Advice

**!** An incorrectly installed child seat compromises the child's safety in the event of an accident.  
Ensure that there is no seat belt or seat belt buckle under the child seat, as this could destabilise it.  
Remember to fasten the seat belts or the harness of child seats, keeping the slack relative to the child's body to a minimum, even for short journeys.  
When installing a child seat using the seat belt, ensure that the seat belt is tightened correctly on the child seat and that it secures the child seat firmly on the seat of the vehicle. If the passenger seat is adjustable, move it forwards if necessary.

**Remove the head restraint before installing a child seat with a backrest on a passenger seat.**

Ensure that the head restraint is stored or attached securely to prevent it from being thrown around the vehicle in the event of sharp braking. Refit the head restraint once the child seat has been removed.

**!** **Installing a booster seat**  
The chest part of the seat belt must be positioned on the child's shoulder without touching the neck.  
Ensure that the lap part of the seat belt passes correctly over the child's thighs.  
Use a booster seat with backrest, equipped with a belt guide at shoulder level.

**!** **Additional protections**  
To prevent accidental opening of the doors and rear windows, use the "Child lock". Take care not to open the rear windows by more than one third.  
To protect young children from the rays of the sun, fit side blinds on the rear windows.  
As a safety precaution, do not leave:  
– a child alone and unattended in a vehicle,  
– a child or an animal in a vehicle which is exposed to the sun, with the windows closed,  
– the keys within reach of children inside the vehicle.

## Child seat at the rear

"Forward facing" or "Rearward facing"





- ▶ Move the vehicle's front seat forward and straighten the backrest so that the legs of the child in the "forward facing" child seat or the "rearward facing" child seat itself do not touch the vehicle's front seat.
- ▶ Verify that the backrest of the "forward facing" child seat is as close as possible to the backrest of the vehicle's rear seat, and is ideally in contact with it.

### Centre rear seat

A child seat with a support leg must never be installed on the **centre rear passenger seat**.

### Child seat at the front



- ▶ Adjust the front passenger seat to the **highest and fully back longitudinal position, with the backrest straightened.**

### "Forward facing"



**!** You must leave the front passenger airbag active.

### "Rearward facing"



**!** The front passenger airbag must be deactivated before installing a rearward facing child seat. Otherwise, **the child risks being seriously injured or killed if the airbag deploys.**



Warning label - Front passenger airbag

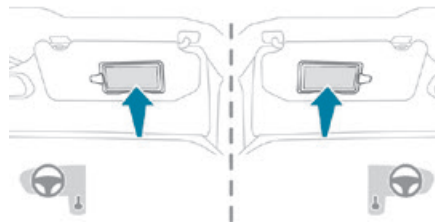

You must comply with the following instruction, as reminded by the warning label on both sides of the passenger sun visor:

**NEVER** use a rearward facing child restraint on a seat protected by an ACTIVE AIRBAG in front of it, **DEATH** or **SERIOUS INJURY** to the **CHILD** can occur.

## Deactivating the front passenger airbag



### Passenger airbag OFF

**!** For your child's safety, the front passenger airbag **MUST** be deactivated when a "rearward facing" child seat is installed on the front passenger seat. Otherwise, the child would be exposed to the risk of death or serious injury in the event of airbag deployment.

**!** **Vehicles not equipped with a deactivation/reactivation control**  
Installing a "rearward facing" child seat on the front passenger seat is strictly prohibited - risk of death or serious injury in the event of airbag deployment!

### Deactivating/Reactivating the front passenger airbag

For vehicles on which it is fitted, the control is located on the side of the glove box.

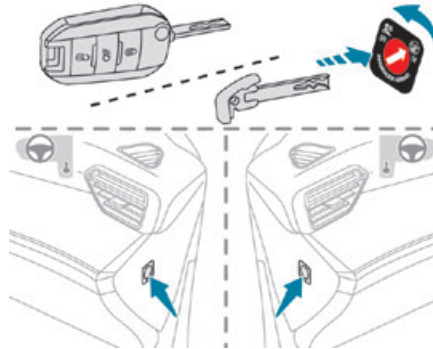

#### With the ignition off:

- ▶ To deactivate the airbag, turn the key in the switch to the **"OFF"** position.
- ▶ To reactivate it, turn the key to the **"ON"** position.

When the ignition is switched on:



This warning lamp comes on and remains lit to signal the deactivation.

Or



This warning lamp comes on for about 1 minute to signal the activation.

## Recommended child seats

Range of recommended child seats secured using a **three-point seat belt**.

### Group 0+: from birth to 13 kg



L1

"RÖMER Baby-Safe Plus"  
Installed in the "rearward facing" position.

### Groups 2 and 3: from 15 to 36 kg



L5

"RÖMER KIDFIX XP"  
Can be fitted to the vehicle's ISOFIX mountings.

The child is restrained by the seat belt.  
A version with a removable backrest may be used for children weighing more than 25 kg. However, for better protection, use a booster seat with backrest for all children weighing up to 36 kg.

## "ISOFIX" mountings

The seats shown below are fitted with ISOFIX compliant mountings:

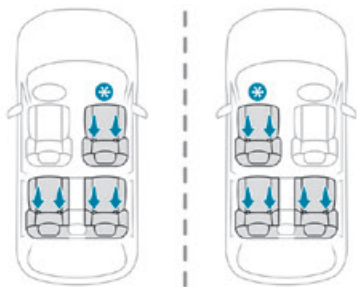

\* Depending on version.

The mountings comprise three rings for each seat, indicated by a marking:

- Two rings **A**, located between the vehicle seat backrest and cushion.

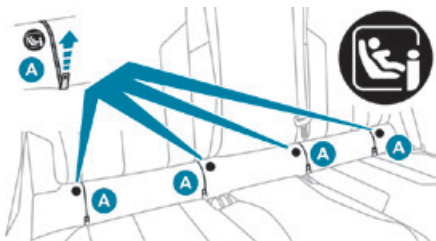

The 2 latches of **ISOFIX child seats** are secured to them.

- One ring **B**, located behind the seat, called the **TOP TETHER**, for fixing seats fitted with an upper strap.



#### Front seat

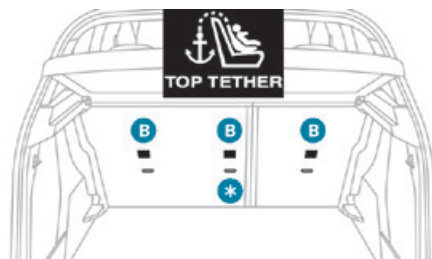

\* Depending on country of sale.

#### Rear seats

This system prevents the child seat from tipping forwards in the event of a front impact.

This ISOFIX mounting system provides fast, reliable and safe fitting of the child seat in the vehicle.

To secure the child seat to the **TOP TETHER**:

- ▶ Remove and stow the head restraint before installing the child seat on this seat (refit it once the child seat has been removed).

- ▶ Pass the strap of the child seat behind the seat backrest, in between the 2 head restraint anchoring points.
- ▶ Secure the upper strap hook to ring **B**.
- ▶ Tighten the upper strap.

**i** When fitting an ISOFIX child seat to the left-hand rear seat of the bench seat, before fitting the seat, first move the centre rear seat belt towards the middle of the vehicle, so as to avoid the seat interfering with the operation of the seat belt.

**!** An incorrectly installed child seat in a vehicle compromises the child's safety in the event of an accident. Strictly observe the fitting instructions provided in the user guide supplied with the child seat.

**i** For information about the options for fitting ISOFIX child seats in your vehicle, refer to the summary table.

## Recommended ISOFIX child seats

**i** Also consult the user guide from the child seat's manufacturer to find out how to install and remove the seat.



<p><b>"RÖMER Baby-Safe Plus and its ISOFIX base"</b> (size category: <b>E</b>)</p>
<p><b>Group 0+:</b> from birth to 13 kg</p>

<p>Installed "rearward facing" using an ISOFIX base which is attached to rings <b>A</b>. The base has a support leg, height-adjustable, which rests on the vehicle's floor. This child seat can also be secured with a seat belt. In this case, only the shell is used and attached to the vehicle seat using the three-point seat belt.</p>

<p><b>"RÖMER Duo Plus ISOFIX"</b> (size category: <b>B1</b>)</p>
<p><b>Group 1:</b> from 9 to 18 kg</p>

<p><b>"RÖMER Duo Plus ISOFIX"</b> (size category: <b>B1</b>)</p>
<p><b>Group 1:</b> from 9 to 18 kg</p>
<p>Suitable for forward-facing installation only. Attached to rings <b>A</b> and ring <b>B</b>, referred to as TOP TETHER, using an upper strap. Three seat body angles: sitting, reclining, lying down.</p> <p>This child seat can also be used in seat positions not equipped with ISOFIX mountings. In this case, it must be secured to the vehicle's seat by the three-point seat belt. Adjust the front seat of the vehicle so that the child's feet do not touch the backrest.</p>

## i-Size child seats

i-Size child seats have two latches that engage on the two rings **A**.

These i-Size child seats also have:



- either an upper strap that is attached to ring **B**.
- or a support leg that rests on the vehicle floor, compatible with the approved i-Size seat position.

Their role is to prevent the child seat from tipping forward in the event of a collision.

For more information on the **ISOFIX mountings**, refer to the corresponding section.

## Installing ISOFIX and i-Size universal child seats

In compliance with European regulations, this table indicates the possibilities for installing child seats secured using the seat belt and universally approved **(a)** as well as the largest **ISOFIX** and **i-Size** for the seat positions fitted with **ISOFIX** anchoring points in the vehicle.

	Seat number					
	Front seats (j)		Rear seats (j)			
	<b>1</b>	<b>3</b>	<b>4</b>	<b>5</b>	<b>6</b>	
	<b>3</b>	<b>1</b>	<b>4</b>	<b>5</b>	<b>6</b>	
Front passenger airbag		Deactivated "OFF" <b>(b)</b>	Activated "ON" <b>(c)</b>			
Position compatible with a <b>universal (a)</b> child seat	no	yes <b>(d) (f)</b>		yes	yes <b>(e)</b>	yes
Position compatible with an <b>i-Size</b> child seat	no	yes		yes	no	yes
Position equipped with a <b>TOP TETHER</b> hook	no	yes		yes	no	yes
" <b>Carrycot</b> " type child seat	no	no		yes <b>(g)</b>	no	yes <b>(g)</b>
"Rearward facing" <b>ISOFIX</b> child seat	no	R3	no	R3 <b>(h) (i)</b>	no	R3 <b>(h) (i)</b>
"Forward facing" <b>ISOFIX</b> child seat	no	F3		F3	no	F3
Booster child seat	no	B3		B3	no	B3 <b>(k)</b>

Rules:

- A position that is **i-Size** compatible is also compatible for **R1**, **R2** and **F2X**, **F2**, **B2**.
- A position that is **R3** compatible is also compatible for **R1** and **R2**.

- A position that is **F3** compatible is also compatible for **F2X** and **F2**.

- A position that is **B3** compatible is also compatible for **B2**.

**(a)** Universal child seat: child seat that can be installed in all vehicles using the seat belt.

- (b) To install a **"rearward facing"** child seat at this seat position, the front passenger airbag must be deactivated **"OFF"** .
- (c) Only a **"forward facing"** child seat is authorised at this seat position with the front passenger airbag activated **"ON"** .
- (d) For a seat with height adjustment, adjust the seat to the highest position and move it fully back.
- (e) Never install a child seat with a support leg on the centre rear seat.
- (f) For a seat without height adjustment, the backrest must be straightened.
- (g) Installing a **"Carrycot"** type child seat on this seat may prevent the installation of additional child seats in the rear.
- (h) Adjust the driver's seat to the highest position.
- (i) Adjust the front passenger seat to the fully forward position.
- (j) Depending on version, refer to the legislation in force in your country before installing a child in this seat position.
- (k) Do not fold down the backrest.

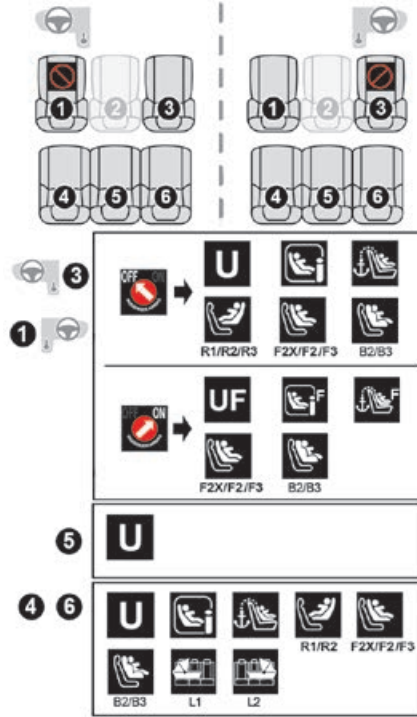

**Key**

- Seat position where the installation of a child seat is forbidden.
- Front passenger airbag **deactivated**.

Front passenger airbag **activated**.

Seat position suitable for the installation of a child seat secured using the seat belt and **universally approved "rearward facing" and/or "forward facing"**.

Seat position suitable for the installation a child seat secured using the seat belt and **universally approved "forward facing"**.

Seat position where securing an **i-Size** child seat is authorised.

Seat position where securing a **"forward facing" i-Size** child seat is authorised.

Presence of a **TOP TETHER** mounting at the rear of the backrest, authorising the attachment of a **"forward facing" universal ISOFIX child seat**.

Presence of a **TOP TETHER** mounting at the rear of the backrest, authorising the attachment of a **"forward facing" universal ISOFIX child seat**.

"Rearward facing" **ISOFIX** child seat:

- **R1: ISOFIX** child seat for **baby**.
- **R2: ISOFIX reduced size** child seat.
- **R3: ISOFIX large size** child seat.

"Forward facing" **ISOFIX** child seat:

- **F2X: ISOFIX** child seat **for toddlers**.
- **F2: ISOFIX reduced height** child seat.
- **F3: ISOFIX full height** child seat.

Child booster seat.



ISOFIX "carrycot" type child seat:

- L1: head to the left-hand side.
- L2: head to the right-hand side.

## Manual child lock



The system prevents a rear door from being opened using its interior handle.  
The red control is located on the edge of each rear door (marked by a label).

## Locking / Unlocking

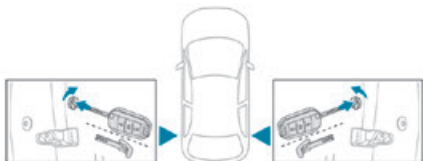

- ▶ To lock, turn the **red** control as far as it will go using the integral key:
  - To the right on the left-hand rear door.
  - To the left on the right-hand rear door.
- ▶ To unlock, turn it in the opposite direction.

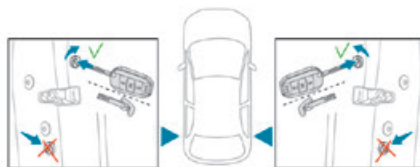

**!** Do not confuse the child lock control, which is red, with the back-up locking control, which is black.

## Electric child lock

Depending on version, this system prevents the opening of the rear doors using their interior handles and/or the use of the rear electric window controls.

### Versions with 1 control



### Electric windows only

This control supplements the manual child lock for the rear doors.



### Doors and electric windows Versions with 2 controls





### Doors only/Electric windows only

## Activation/Deactivation

- ▶ With the ignition on, press the corresponding button to activate/deactivate the child lock (confirmed by the corresponding indicator lamp coming on/going out).

The activation/deactivation of the child lock is also indicated by the display of a message.

 Any other status of the indicator lamp indicates a malfunction of the electric child lock.  
Have it checked by a PEUGEOT dealer or a qualified workshop.

 With the child lock activated, it is still possible to open the rear doors from outside and/or to operate the rear electric windows from the driver's door.

 This system is independent and in no circumstances does it take the place of the central locking control.  
Check the status of the child lock each time you switch on the ignition.  
Always keep the electronic key with you when leaving the vehicle, even for a short time.  
In the event of a serious impact, the electric child lock is switched off automatically to permit the exit of the rear passengers.

## Driving recommendations

- ▶ Observe the driving regulations and remain vigilant whatever the traffic conditions.
- ▶ Monitor your environment and keep your hands on the wheel to be able to react to anything that may happen any time.
- ▶ Drive smoothly, anticipate the need for braking and maintain a longer safety distance, especially in bad weather.
- ▶ Stop the vehicle to carry out operations that require close attention (such as adjustments).
- ▶ During long trips, take a break every two hours.

### Important!

**!** **Never leave the engine running in a closed space without sufficient ventilation.** Internal combustion engines emit toxic exhaust gases such as carbon monoxide. Danger of poisoning and death!

**!** In very severe wintry conditions (temperature below -23°C), let the engine run for 4 minutes before moving off, to ensure the correct operation and durability of the mechanical components of your vehicle (engine and gearbox).

**!** **Never drive with the parking brake applied.** Risk of overheating and damaging the braking system!

**!** **Do not park the vehicle or leave the engine running on a flammable surface (e.g. dry grass, dead leaves).** The vehicle exhaust system is very hot, even several minutes after the engine stops. Risk of fire!

**!** **Never leave a vehicle unattended with the engine running.** If you have to leave your vehicle with the engine running, apply the parking brake and put the gearbox or drive selector into neutral or position **N** or **P** (depending on version).

**!** **Never leave children inside the vehicle unsupervised.**

### On flooded roads

We strongly advise against driving on flooded roads, as this could cause serious damage to the engine or gearbox, as well as to the electrical systems of your vehicle.

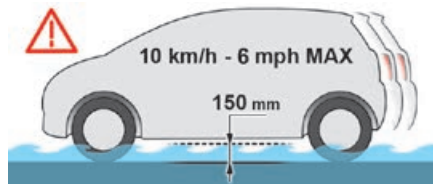

If you are obliged to drive on a flooded road:

- ▶ check that the depth of water does not exceed 15 cm, taking account of waves that might be generated by other users,
  - ▶ deactivate the Stop & Start function,
  - ▶ drive as slowly as possible without stalling. In all cases, do not exceed 6 mph (10 km/h),
  - ▶ do not stop and do not switch off the engine.
- On leaving the flooded road, as soon as safety conditions allow, make several light brake applications to dry the brake discs and pads. If in doubt about the state of your vehicle, contact a PEUGEOT dealer or a qualified workshop.

### Noise (Electric)

#### On the outside

Due to the vehicle's quiet operation when driving, the driver should pay particular attention. At speeds of up to 19 mph (30 km/h), the pedestrian horn warns other road users of the vehicle's presence.

#### **i** **Cooling the traction battery**

The cooling fan comes on during charging to cool the on-board charger and the traction battery.

#### On the inside

During use, you may hear certain perfectly normal noises specific to electric vehicles, such as:

- Traction battery relay when starting.

- Vacuum pump when braking.
- Vehicle tyres or aerodynamics when driving.
- Jolting and knocking noise during hill starts.

## Towing

**!** Driving with a trailer places greater demands on the towing vehicle and particular care must be taken.

**i** Do not exceed the maximum towable weights.

**At altitude:** reduce the maximum load by 10% per 1,000 metres of altitude; the lower air density at high altitudes decreases engine performance.

**!** **New vehicle:** do not tow a trailer until the vehicle has driven at least 620 miles (1,000 kilometres).

**i** If the outside temperature is high, let the engine idle for 1 to 2 minutes after the vehicle comes to a stop, to help it to cool.

## Before setting off

### Nose weight

► Distribute the load in the trailer so that the heaviest items are as close as possible to the axle and the nose weight (at the point where it

joins your vehicle) approaches the maximum permitted without exceeding it.

### Tyres

► Check the tyre pressures of the towing vehicle and of the trailer, observing the recommended pressures.

### Lighting

► Check the electrical signalling on the trailer and the headlamp beam height of your vehicle.

**i** If a genuine PEUGEOT towing device is used, the rear parking sensors will be deactivated automatically to avoid the audible signal.

## When driving

### Cooling

Towing a trailer uphill causes the coolant temperature to increase. The maximum towable load depends on the gradient and the exterior temperature. The fan's cooling capacity does not increase with engine speed.

► Reduce speed and lower the engine speed to limit heating up.

In all cases, pay attention to the coolant temperature.



If this warning lamp and the **STOP** warning lamp come on, stop the vehicle and switch off the engine as soon as possible.

## Brakes

Braking distances are increased when towing a trailer. To avoid overheating the brakes, the use of engine braking is recommended.

### Side wind

Bear in mind that the vehicle will be more susceptible to wind when towing.

## Anti-theft protection

### Electronic immobiliser

The keys include an electronic engine immobiliser system, with a code that must be recognised in order for starting to be possible. If the system malfunctions, indicated by the display of a message, the engine will not start. Contact a PEUGEOT dealer.

## Starting / Switching off the engine with the key

### Key ignition switch

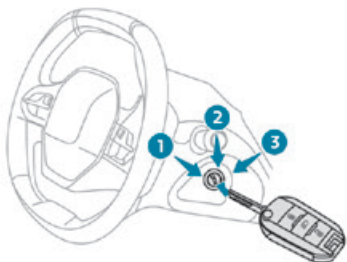

It has 3 positions:

- **1. Stop:** inserting and removing the key, steering column locked.
- **2. Ignition:** steering column unlocked, ignition on, Diesel preheating, engine running.
- **3. Starting.**

**i** Avoid attaching heavy objects to the key or the remote control. It would weigh down on its shaft in the ignition switch and could cause a malfunction.

### Ignition on position

It allows the use of the vehicle's electric equipment or portable devices to be charged.

Once the state of charge of the battery drops to the reserve level, the system switches to energy economy mode : the power supply is cut off automatically to preserve the remaining battery charge.

### Starting the engine

With the parking brake applied:

- ▶ With a **manual gearbox**, place the gear lever in neutral then fully depress the clutch pedal.
- ▶ With an **automatic gearbox**, place the gear selector in mode **N** or **P** then fully depress the brake pedal.
- ▶ Insert the key into the ignition switch; the system recognises the code.
- ▶ Unlock the steering column by simultaneously turning the steering wheel and the key.

**i** In certain cases, you may have to apply significant force to move the steering wheel (wheels on full lock, for example).

- ▶ With a **petrol engine**, operate the starter motor by turning the key to position **3** without pressing the accelerator pedal, until the engine starts. As soon as the engine starts, release the key.

**i** With **petrol engines**, after a cold start, preheating the catalytic converter can cause noticeable engine vibrations for anything up to 2 minutes while stationary with the engine running (accelerated idle speed).

- ▶ With a **Diesel engine**, turn the key to position **2**, ignition on, to operate the engine preheating system.

 Wait until this warning lamp goes off in the instrument panel, then operate the starter motor by turning the key to position **3** without pressing the accelerator pedal, until the engine starts. As soon as the engine starts, release the key.

**i** In wintry conditions, the warning lamp may stay on for a longer period. When the engine is hot, the warning lamp does not come on.

**!** If the engine does not start straight away, switch off the ignition. Wait a few seconds before operating the starter motor again. If the engine does not start after a few attempts, do not keep trying - risk of damaging the starter motor and the engine. Contact a PEUGEOT dealer or a qualified workshop.

**i** In mild conditions, do not leave the engine to warm up while stationary, but move off straight away and drive at moderate speed.

### Switching off the engine

- ▶ Immobilise the vehicle.



- ▶ With the engine at idle, turn the key to position 1.
- ▶ Remove the key from the ignition switch.
- ▶ To lock the steering column, turn the steering wheel until it locks.

**i** To facilitate unlocking of the steering column, it is recommended that the wheels be returned to the straight ahead position before switching off the engine.

**!** Never switch off the ignition before the complete immobilisation of the vehicle. With the engine off, the braking and steering assistance systems are also cut off - risk of loss of control of the vehicle!

**i** Check that the parking brake is correctly applied, particularly on sloping ground. When leaving the vehicle, keep the key in your possession and lock the vehicle.

## Energy economy mode

After the engine has stopped (position 1. **Stop**), for a maximum combined duration of about thirty minutes, you can still use functions such as the audio and telematics system, courtesy lamps, windscreen wipers, dipped beam headlamps, etc.

**i** For more information on **Energy economy mode**, refer to the corresponding section.

### **i** Key left in

When opening the driver's door, an alert message is displayed, accompanied by an audible signal, to remind you that the key is still in the ignition switch at position 1 (**Stop**). If the key has been left in the ignition switch at position 2 (**Ignition on**), the ignition will be switched off automatically after one hour. To switch the ignition back on, turn the key to position 1 (**Stop**), then back to position 2 (**Ignition on**).

## Starting / Switching off the engine with Keyless Entry and Starting

**i** The electronic key must be present in the passenger compartment.

For versions equipped with Proximity Keyless Entry and Starting, the electronic key is also detected in the boot.

If it is not detected, a message is displayed. Move the electronic key so that the engine can be started or switched off.

If there is still a problem, refer to the "Key not detected - Back-up starting or Back-up switch-off" section.

## Starting



- ▶ With a **manual gearbox**, place the gear lever in neutral and fully depress the clutch pedal.
- ▶ With an **automatic gearbox**, select mode **P** or **N** and press the brake pedal.
- ▶ Press the "**START/STOP**" button while maintaining pressure on the pedal until the engine starts.

For **Diesel engines**, when the temperature is below zero and/or the engine is cold, starting will only occur once the preheating warning lamp is off.

 If this warning lamp comes on after pressing the "**START/STOP**" button:

- ▶ Keep the pedal fully depressed and do not press the "**START/STOP**" button again until the engine is running.

If one of the starting conditions is not met, a message is displayed.

In some circumstances, a message indicates that it is necessary to turn the steering wheel

while pressing the **"START/STOP"** button to assist unlocking of the steering column.

**i** With **petrol engines**, after a cold start, preheating the catalytic converter can cause noticeable engine vibrations for anything up to 2 minutes while stationary with the engine running (accelerated idle speed).

**i** If the engine stalls, release the clutch pedal and fully depress it again, the engine will restart automatically.

## Switching off

- ▶ Immobilise the vehicle, with the engine at idle.
- ▶ With a **manual gearbox**, ideally put the gear lever into neutral.
- ▶ With an **automatic gearbox**, ideally select mode **P** or **N**.
- ▶ Press the **"START/STOP"** button.

In some circumstances, it is necessary to turn the steering wheel to lock the steering column.

**i** If the vehicle is not immobilised, the engine will not switch off.

**!** With the engine off, the braking and steering assistance systems are also cut off - risk of loss of control of the vehicle!

**!** Never leave your vehicle with the electronic key still inside.

## Starting/Switching off the electric motor

### Starting

The drive selector must be in mode **P**.

- ▶ Fully depress the brake pedal and briefly press the **"START/STOP"** button.
  - ▶ Keep your foot on the brake pedal until the **READY** indicator lamp comes on and an audible signal is emitted, indicating that the vehicle is ready to drive.
  - ▶ With your foot on the brake, press the **"Unlock"** button and select mode **D/B** or **R**.
  - ▶ Release the brake pedal, then accelerate.
- On starting, the instrument panel lights up and the power indicator needle or cursor moves to the "neutral" position. The steering column automatically unlocks (you may hear a sound and feel the steering wheel move).

### Switching off

- ▶ Press the **"START/STOP"** button.
- Before exiting the vehicle, check that:
- The drive selector is in mode **P**.
  - The **READY** indicator lamp is off.

**i** If the driver's door is opened while the required conditions for stopping are not satisfied, an audible signal is emitted,

accompanied by the display of a warning message.

## Switching on the ignition without starting the engine



With the electronic key in the passenger compartment, pressing the **"START/STOP"** button, **without pressing any of the pedals**, allows the ignition to be switched on without starting the engine.

- ▶ Press this button **again** to switch off the ignition and allow the vehicle to be locked.

## Key not detected

### Back-up starting

A back-up reader is fitted to the steering column, to enable the engine to be started if the system fails to detect the key in the recognition zone, or if the battery in the electronic key is discharged.

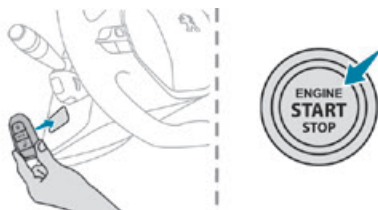

- ▶ Place and hold the remote control against the reader.
- ▶ **With a manual gearbox**, place the gear lever in neutral, then fully depress the clutch pedal.
- ▶ **With an automatic gearbox or a drive selector**, select mode **P**, then fully depress the brake pedal.
- ▶ Press the "**START/STOP**" button. The engine starts.

### Back-up switch-off



If the electronic key is not detected or is no longer in the recognition zone, a message

appears in the instrument panel when closing a door or trying to switch off the engine.

- ▶ To confirm the instruction to switch off the engine, press the "**START/STOP**" button for approximately 5 seconds.

In the event of a fault with the electronic key, contact a PEUGEOT dealer or a qualified workshop.

### Emergency switch-off

In the event of an emergency only, the engine can be switched off without conditions (even when driving).

- ▶ Press the "**START/STOP**" button for about 5 seconds.

In this case, the steering column locks as soon as the vehicle stops.

### Manual parking brake

#### Release



- ▶ Pull the parking brake lever up slightly, press the release button, then lower the lever fully.



When driving the vehicle, if this warning lamp and the **STOP** warning lamp come on, accompanied by an audible signal and the display of a message, this means that the parking brake is still applied or has not been fully released.

### Application

- ▶ Pull the parking brake lever up to immobilise the vehicle.



When parking on a slope, turn the wheels against the kerb, apply the parking brake, engage a gear and switch off the ignition.

### Electric parking brake

In automatic mode, this system applies the parking brake when the engine is switched off and releases it when the vehicle moves off.

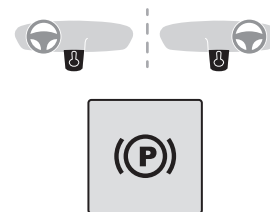

At any time, with the engine running:

- ▶ to apply the parking brake, **briefly** pull the control lever;

- ▶ to release it, briefly **push** the control lever while pressing the brake pedal.  
Automatic mode is activated by default.

## Indicator lamp

 This indicator lamp comes on on the instrument panel and on the control lever to confirm the application of the parking brake, accompanied by the display of the message "Parking brake applied".

The indicator lamp goes out to confirm the release of the parking brake, accompanied by the display of the message "Parking brake released".

The indicator lamp flashes in response to a manual request to apply or release the brake.

 In the event of a battery failure, the electric parking brake will not operate.

As a safety measure, with a manual gearbox, if the parking brake is not applied, immobilise the vehicle by engaging a gear.

As a safety measure, with an automatic gearbox or drive selector, if the parking brake is not applied, immobilise the vehicle by placing the supplied chock against one of the wheels.

Contact a PEUGEOT dealer or a qualified workshop.

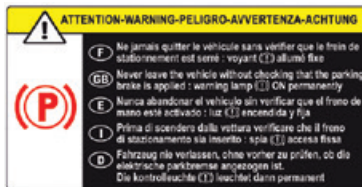

 Before leaving the vehicle, check that the parking brake is applied: the indicator lamps on the instrument panel and the control lever must be on fixed.

If the parking brake is not applied, there is an audible signal and a message is displayed on opening the driver's door.

 Never leave a child alone inside the vehicle, as they could release the parking brake.

 **When the vehicle is parked: on a steep slope, heavily loaded or during towing**

With a manual gearbox, turn the wheels toward the pavement and engage a gear.

With an automatic gearbox or a drive selector, turn the wheels toward the pavement and select mode **P**.

When towing, the vehicle is approved for parking on slopes of up to 12%.

## Manual operation

### Manual release

With the ignition on or engine running:

- ▶ Depress the brake pedal.
- ▶ While maintaining pressure on the brake pedal, briefly push the control lever.

 If you push the control lever without pressing the brake pedal, the parking brake is not released and a message is displayed.

### Manual application

With the vehicle stationary:

- ▶ Pull briefly on the control lever.

The control lever indicator lamp flashes to confirm the application request.

## Automatic operation

### Automatic release

First ensure that the engine is running and the driver's door is properly closed.

The electric parking brake **gradually releases automatically as the vehicle moves off**.

#### With a manual gearbox

- ▶ Fully depress the clutch pedal and engage first gear or reverse.
- ▶ Depress the accelerator pedal and release the clutch pedal.

#### With an automatic gearbox

- ▶ Depress the brake pedal.
- ▶ Select mode **D**, **M** or **R**.
- ▶ Release the brake pedal and depress the accelerator pedal.

#### With a drive selector

- ▶ Depress the brake pedal.
- ▶ Select mode **D**, **B** or **R**.
- ▶ Release the brake pedal and depress the accelerator pedal.

**i** With an automatic gearbox or drive selector, if the brake does not release automatically, check that the front doors are correctly closed.

**!** When stationary with the engine running, do not depress the accelerator pedal unnecessarily. Risk of parking brake release.

### Automatic application

With the vehicle stationary, the parking brake is **automatically applied when the engine is switched off**.

**!** It is not applied automatically if the engine stalls or enters STOP mode of Stop & Start.

**i** With automatic operation, it is also possible to manually apply or release the parking brake using the control lever.

## Special cases

### Immobilising the vehicle with the engine running

To immobilise the vehicle with the engine running, briefly pull the control lever.

### Parking the vehicle with the brake released

**!** In very cold conditions (ice), applying the parking brake is not recommended. To immobilise the vehicle, engage a gear or place the chocks against one of the wheels.

### Immobilising the vehicle with the parking brake released

- ▶ Switch off the engine.
- ▶ Switch on the ignition again, without starting the engine.
- ▶ Release the parking brake manually by pushing the control lever while keeping your foot on the brake pedal.
- ▶ Switch off the ignition.

**i** With an automatic gearbox or drive selector, mode **P** is automatically selected when the ignition is switched off. The wheels are blocked.

For more information on **Changing to free-wheeling**, refer to the corresponding section.

**i** With an automatic gearbox or drive selector, while mode **N** is selected, opening the driver's door triggers an audible signal. It stops when the driver's door closes again.

## Deactivating automatic operation

In some situations, for example when it is extremely cold or when towing (e.g. caravan, breakdown), it may be necessary to deactivate automatic operation of the system.

- ▶ Start the engine.
- ▶ Use the control lever to apply the parking brake, if it is released.
- ▶ Take your foot fully off the brake pedal.
- ▶ Hold the control lever pressed in the release direction for between 10 and a maximum of 15 seconds.
- ▶ Release the control lever.
- ▶ Depress and hold the brake pedal.
- ▶ Pull the control lever in the "Application" direction for 2 seconds.



This indicator lamp on the instrument panel comes on to confirm deactivation of the automatic functions.

- ▶ Release the control lever and the brake pedal.

From now on, the parking brake can only be applied and released manually using the control lever.

Repeat this procedure to reactivate automatic operation (confirmed by the indicator lamp on the instrument panel going off).

## Emergency braking

In the event of a fault with the brake pedal or in an exceptional situation (e.g. driver taken ill, driver under instruction), a continuous pull on the electric parking brake control lever will brake the vehicle. Braking continues while the control lever is pulled, and ceases when the control lever is released.

The ABS and DSC systems stabilise the vehicle during emergency braking.

If emergency braking malfunctions, the message "Parking brake control faulty" will be displayed on the instrument panel.



If the ABS and DSC systems malfunction, indicated by lighting one or both warning lamps on the instrument panel, the vehicle's stability is no longer ensured. In this event, the driver must keep the vehicle stable by successively pulling and releasing the control lever, repeating the operation until the vehicle has stopped.

## 6-speed manual gearbox

### Engaging 5<sup>th</sup> or 6<sup>th</sup> gear

► Move the gear selector fully to the right to engage 5<sup>th</sup> or 6<sup>th</sup> gear.

! Failure to follow this instruction could cause permanent damage to the gearbox (inadvertent engagement of 3<sup>rd</sup> or 4<sup>th</sup> gear).

### Engaging reverse gear

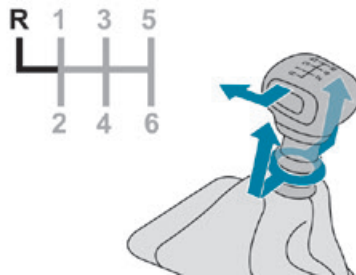

► Raise the ring under the knob and move the gear selector to the left, then forwards.

! Only engage reverse gear when the vehicle is stationary with the engine at idle.

i As a safety precaution and to facilitate starting the engine:

- Always select neutral.
- Press the clutch pedal.

## Automatic gearbox (EAT6)

6-speed automatic gearbox which offers a choice between the comfort of automatic operation or manual gear changing.

Two driving modes are available:

- **Automatic** operation for electronic management of the gears by the gearbox.
- **Manual** operation for sequential changing of the gears by the driver.

### Gear selector module

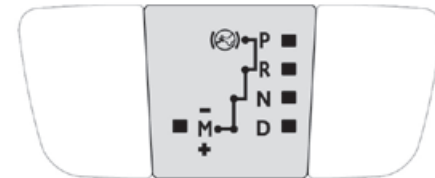

- P. Park
  - Vehicle immobilised, parking brake applied or released.
  - Engine starting.
- R. Reverse
  - Reversing manoeuvres, vehicle stationary, engine at idle.
- N. Neutral
  - Vehicle immobilised, parking brake applied.
  - Engine starting.
- D. Automatic operation

- M. + / -** Manual operation
- ▶ To shift up/down through the gears, push the control backwards/forwards.

## Information displayed on the instrument panel

When a position is selected in the grate with the gear selector, the corresponding indicator lamp lights up on the instrument panel.

- P.** Park
- R.** Reverse
- N.** Neutral
- D.** Drive (automatic operation)
- 1...6.** Gear engaged during manual operation
- .** Instruction not processed in manual operation

## Starting the vehicle



- ▶ With your foot on the brake pedal, select position **P** or **N**.

- ▶ Start the engine.

If the conditions are not met, you will hear an audible signal, accompanied by the display of a message.

- ▶ With the engine running, press the brake pedal.
- ▶ Release the parking brake, unless it is programmed to automatic mode.
- ▶ Select position **R**, **D** or **M**.
- ▶ Gradually release the brake pedal.

The vehicle moves off immediately.

**i** If position **N** is selected inadvertently while driving, allow the engine to return to idle, then select position **D** to accelerate.

**!** When the engine is running at idle with the brakes released, if position **R**, **D** or **M** is selected, the vehicle moves even without the accelerator being pressed. Never leave children unattended in the vehicle when the engine is running. When carrying out maintenance with the engine running, apply the parking brake and select position **P**.

## Automatic operation

- ▶ Select position **D** for **automatic** changing of the six gears.

The gearbox then operates in auto-adaptive mode, without any intervention on the part of the driver. It continuously selects the most suitable gear according to the driving style, the road profile and the load in the vehicle.

For maximum acceleration without touching the selector, press the accelerator fully down (kick-down). The gearbox changes down automatically or holds the gear selected until the maximum engine speed is reached.

When braking, the gearbox changes down automatically to provide effective engine braking. If you release the accelerator sharply, the gearbox will not shift to a higher gear for safety reasons.

**!** Never select position **N** while the vehicle is moving.

Never select positions **P** or **R** unless the vehicle is completely stationary.

## Manual operation



To limit fuel consumption during an extended standstill with the engine running (for example, in a traffic jam), set the gear selector to **N** and apply the parking brake.

- ▶ Selecting position **M** enables sequential shifting between the six gears.
- ▶ To shift up/down through the gears, push the control backwards/forwards.

The gearbox only changes gear if the vehicle speed and engine speed conditions allow; otherwise, the rules for automatic operation are temporarily applied.

**M****4** **D** disappears, and the gears engaged appear in succession on the instrument panel.

If the engine speed is too low or too high, the selected gear flashes for a few seconds, then the gear actually engaged is shown.

It is possible to change from position **D** to position **M** at any time.

When the vehicle is stationary or moving very slowly, the gearbox selects gear **M1** automatically.

 This symbol is displayed if a gear is not engaged correctly (gear selector between two positions).

## Switching the vehicle off

Before switching off the engine, it is possible to engage position **P** or **N** to place the gearbox in neutral.

In both cases, apply the parking brake to immobilise the vehicle, unless it is programmed to automatic mode.

- i** If the selector is not in position **P**, when the driver's door is opened or approximately 45 seconds after the ignition is switched off, an audible signal sounds and a message appears.
- ▶ Return the gear selector to **P**; the audible signal stops and the message disappears.

## Malfunction

 In the event of a malfunction, this warning lamp comes on and a message is displayed, when the ignition is switched on. In this case, the gearbox goes into back-up mode and is locked in 3<sup>rd</sup> gear. It is possible to feel a significant jolt (without risk for the gearbox) while changing from **P** to **R** and from **N** to **R**. Do not exceed 62 mph (100 km/h), local speed restrictions permitting. Have it checked by a PEUGEOT dealer or a qualified workshop.

- !** There is a risk of damaging the gearbox:
- If the accelerator and brake pedals are pressed simultaneously.
  - In the event of a battery failure, forcing the selector from position **P** to another position.

## Automatic gearbox (EAT8)

Automatic 8 speed gearbox with a push selector. It also offers a manual mode with gear changes via control paddles situated behind the steering wheel.

### Gearbox selector positions

- P. Park**  
For parking the vehicle: the front wheels are blocked.
- R. Reverse gear**
- N. Neutral**  
For moving the vehicle with the ignition off, or to allow it to free-wheel.  
For more information on **Changing to free-wheeling**, refer to the corresponding section.
- D. Driving in automatic mode**  
The gearbox manages gear changes according to the style of driving, the road profile and the vehicle load.
- M. Driving in manual mode**  
The driver changes gear using the steering-mounted controls.

### Push selector

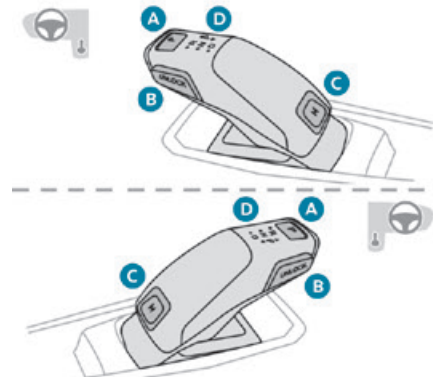

- A. Button P**  
To put the gearbox into Park mode.
- B. Unlock button**  
To unlock the gearbox and come out of **P** or to change to **R**, with the foot on the brake pedal.  
Press and hold this button before pushing the selector.
- C. Button M**  
To change from mode **D** to permanent manual mode.  
(Depending on version: with Full Park Assist, the manual mode is accessed via the **DRIVE MODE** control)
- D. Gearbox state indicator lamps (R, N, D)**



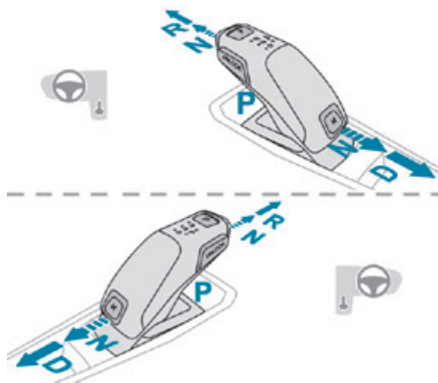

► Move the selector by pressing it forwards (**N** or **R**) or rearwards (**N** or **D**) once or twice, passing the point of resistance if necessary. The push selector returns to its initial position when released.

For example, to change from **P** to **R**, while pressing **Unlock**, push forward twice without crossing the point of resistance or push once crossing the point of resistance:

- In the first case, the gearbox goes from **P** to **N**, then from **N** to **R**.
- In the second case, the gearbox goes directly from **P** to **R**.

## Steering-mounted controls

In mode **M** or **D**, the steering-mounted control paddles can be used to change gear manually. They cannot be used to select neutral or to engage or disengage reverse gear.



- Pull the "+" or "-" paddle towards you and release to shift up or down a gear, respectively.

## Information displayed on the instrument panel

When the ignition is switched on, the gearbox status is displayed on the instrument panel:

**P** : Park.

**R** : Reverse.

**N** : Neutral.

**D1...D8** : Automatic mode.

**M1...M8** : Manual mode.

- : Instruction not processed in manual mode.

If the driver's door is opened with the ignition on, a message is displayed, prompting you to set the gearbox to mode **P**.

## Operation

With the engine running, if it is necessary to press the brake pedal and/or the **Unlock** button

in order to change mode, an alert message is displayed in the instrument panel. Only appropriate attempted changes of mode are accepted.

! With the engine running and the brakes released, if **R**, **D** or **M** is selected, the vehicle moves off, even without pressing the accelerator pedal.

! Never press the accelerator and brake pedals at the same time - risk of damage to the gearbox!  
In the event of a battery failure, you must place the chocks supplied with the vehicle tools against one of the wheels to immobilise the vehicle.

## Unlocking the gearbox

- From mode **P**:
  - Fully depress the brake pedal.
  - Press the **Unlock** button.
  - While continuing to press the brake pedal and the **Unlock** button, select another mode.
- From neutral **N**, at a speed below 3 mph (5 km/h):
  - Fully depress the brake pedal.
  - While continuing to depress the brake pedal, select another mode.

## Engaging reverse gear

- Slow down until you come to a stop.

▶ Depress the brake pedal, then press the **Unlock** button.

▶ While maintaining the presses, select mode **R**.

### Permanent manual mode

#### Entering the mode:

With EAT8 without Full Park Assist button:

▶ With mode **D** initially selected.

▶ Press button **M**; the green indicator lamp in the button comes on.

With EAT8 and Full Park Assist button:

▶ Press the **DRIVE MODE** control.

▶ Select "Manual" mode, which is displayed on the instrument panel.

#### Exiting the mode:

▶ Push forwards once to return to **D**.

or

▶ Press button **M**; the indicator lamp in the button goes off.

or

▶ Select another mode using the **DRIVE MODE** control.

### Switching off the ignition

To switch off the ignition, the vehicle must be stationary.

### Changing to free-wheeling

For more information on **Changing to free-wheeling**, refer to the corresponding section.

**i** If you open the driver's door while mode **N** is engaged, an audible signal will

sound. It will stop when you close the driver's door again.

### Special aspects of automatic mode

The gearbox selects the gear that offers optimum performance, taking account of the outside temperature, the road profile, the vehicle load and the driving style.

For maximum acceleration, press the accelerator fully down (kick-down). The gearbox changes down automatically or holds the selected gear until the maximum engine speed is reached. Steering mounted controls allow the driver to temporarily select a gear, if the vehicle speed and engine speed conditions permit.

### Special aspects of manual mode

The gearbox only changes from one gear to another if the vehicle speed and engine speed conditions permit.

### Starting the vehicle

From mode **P**:

▶ Fully depress the brake pedal.

▶ Start the engine.

▶ Maintaining pressure on the brake pedal, press the **Unlock** button.

▶ Push once or twice rearwards to select the automatic mode **D**, or forwards to engage reverse **R**.

From neutral **N**:

▶ Fully depress the brake pedal.

▶ Start the engine.

▶ Maintaining pressure on the brake pedal, push rearwards to select the automatic mode **D**, or forwards, while pressing the **Unlock** button to engage reverse **R**.

Then, from **D** or **R**:

▶ Release the brake pedal.

▶ Accelerate gradually to automatically release the electric parking brake.

The vehicle moves off immediately.

**!** With an automatic gearbox, never try to start the engine by pushing the vehicle.

### Stopping the vehicle

Whatever the state of the gearbox, when the ignition is switched off, mode **P** is engaged automatically and immediately.

However, in mode **N**, mode **P** will be engaged after a delay of 5 seconds (allowing for the process of putting the vehicle into free-wheeling mode).

Check that mode **P** has been engaged and that the electric parking brake was applied automatically; if not, apply it manually.

 The corresponding indicator lamps in the selector and the electric parking brake control lever must be on, as well as those in the instrument panel.

## Gearbox malfunction



This warning lamp comes on, accompanied by an audible signal and the display of a message.

Visit a PEUGEOT dealer or a qualified workshop. Do not drive faster than 62 mph (100 km/h), keeping to the speed limit.

The gearbox switches to back-up mode: mode **D** is locked in third gear, the steering-mounted control paddles are inoperative, mode **M** is no longer available. You may feel a significant jolt on engaging reverse gear. This will not damage the gearbox.

## Selector malfunction

### Minor malfunction



This warning lamp comes on, accompanied by the display of a message and an audible signal.

Drive cautiously and visit a PEUGEOT dealer or a qualified workshop.

In certain cases, the selector indicator lamps may no longer come on, but the gearbox state is still displayed on the instrument panel.

### Major malfunction



This warning lamp comes on, accompanied by the display of a message.

! Stop as soon as it is safe to do so, away from traffic, and call a PEUGEOT dealer or a qualified workshop.

## Drive selector (Electric)

The drive selector is a pulse selector with a regenerative braking function.

The drive selector provides traction control based on the driving style, the road profile and the vehicle load.

With regenerative braking activated, it also manages engine braking when the accelerator pedal is released.

- P.** Park  
For parking the vehicle: the front wheels are blocked.
- R.** Reverse gear
- N.** Neutral  
For moving the vehicle with the ignition off and allowing it to free-wheel.  
For more information on **Changing to free-wheeling**, refer to the corresponding section.
- D/B.** Automatic forward drive (**D**) or automatic forward drive with regenerative braking (**B**)

## Information displayed on the instrument panel

When the ignition is switched on, the drive selector status is displayed on the instrument panel:

- P** : Park.
- R** : Reverse.
- N** : Neutral.
- D** : Automatic forward drive.

**B** : Automatic forward drive with regenerative braking activated.

## Operation

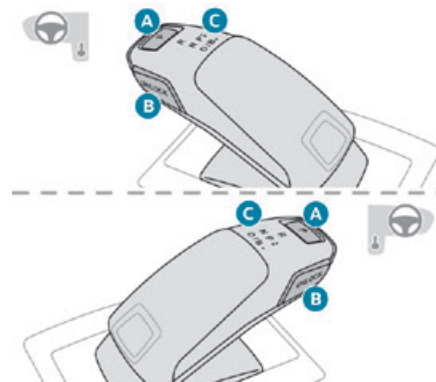

- A.** Button **P**  
To put the gearbox into Park mode.
- B.** **Unlock** button  
To unlock the selector and come out of **P** or change to **R**, with the foot on the brake pedal. Press and hold this button before pushing the selector.
- C.** Selector state indicators (**R**, **N**, **D/B**)
  - ▶ Move the selector by pushing it forwards (**N** or **R**) or backwards (**N** or **D/B**) once or twice, passing the point of resistance if necessary. The push selector returns to its initial position when released.

For example, to change from **P** to **R**, either push forwards twice without passing the point of resistance or push just once, passing the point of resistance:

- In the first case, the selector goes from **P** to **N**, then from **N** to **R**.
- In the second case, the selector goes directly from **P** to **R**.

## Regenerative braking

The regenerative braking function emulates engine braking, slowing the vehicle with no need to depress the brake pedal. When the driver releases the accelerator pedal, the vehicle slows down more quickly and recharges the battery.

► From mode **D/B**, moving the push selector backwards activates/deactivates the function. The **D** on the instrument panel is replaced with a **B**.

The state of the function is not saved when the ignition is switched off.

**!** The driver must always be ready to use the brake pedal: in certain situations (e.g. full battery, extreme temperatures), the regenerative braking level may be temporarily limited and deceleration may be reduced.

## Driving modes

The number and type of driving modes available depend on the vehicle's engine and equipment.

Driving modes are selected using the following control:

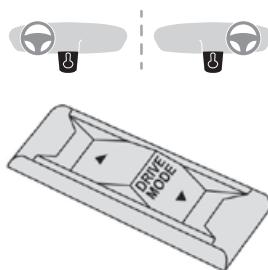

Pressing the control displays the modes on the instrument panel.

With an electric motor, you cannot select a mode if the **READY** lamp is off.

When the message disappears, the selected mode is activated and remains indicated on the instrument panel (except **NORMAL** mode). With Advanced Grip Control, additional driving modes are available, offering enhanced traction control.

For more information on **Advanced Grip Control**, refer to the corresponding section. Whenever the ignition is switched on, **NORMAL** mode is selected by default.

### **NORMAL**

Restores the vehicle's original settings.  
Reduces traction battery electrical energy consumption by limiting engine torque.

### **ECO**

Reduces energy consumption by restricting the performance of the heating and air conditioning systems, although it does not deactivate them. Free-wheeling in **ECO** mode: depending on version, with the EAT8 gearbox, moving into "free-wheeling" is encouraged to slow the vehicle down without using engine braking. You can save fuel by anticipating the need to slow down and lifting your foot fully off the accelerator pedal. Further reduces traction battery electrical energy consumption by limiting engine torque.

### **SPORT**

Enables more dynamic driving, acting on the power steering, accelerator and gear changes with an automatic gearbox and the possibility of displaying the vehicle's dynamic settings on the instrument panel.

### **MANUAL**

Permanent "Manual" mode with an automatic gearbox and Full Park Assist. Enables manual gear changing using the steering-mounted paddles.

## Hill start assist

This system keeps your vehicle briefly stationary (for approximately 2 seconds) when making a hill start, while you transfer your foot from the brake pedal to the accelerator pedal.

This system is only active when:

- the vehicle is completely stationary, with your foot on the brake pedal,
- certain slope conditions are met,
- the driver's door is closed.

**!** Do not leave the vehicle while it is being held temporarily by hill start assist.

If someone needs to get out of the vehicle with the engine running, apply the parking brake manually. After that, ensure that the parking brake indicator lamp and the indicator lamp **P** in the electric parking brake control lever are on fixed.

**!** The hill start assist function cannot be deactivated. However, use of the parking brake to immobilise the vehicle interrupts its operation.

## Operation

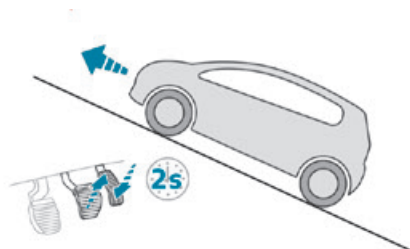

**On an ascending slope, with the vehicle stationary, the vehicle is held for a short time when you release the brake pedal:**

- provided you are in first gear or neutral with a manual gearbox.
- provided you are in mode **D** or **M** with an automatic gearbox.
- provided you are in mode **D** or **B** with a drive selector.

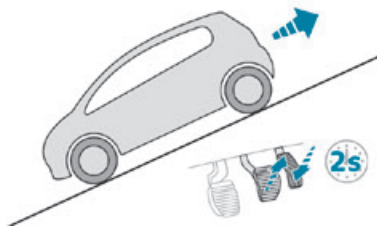

**On a descending slope, with the vehicle stationary and reverse gear engaged, the vehicle is held for a short time when you release the brake pedal.**

## Malfunction



These warning lamps come on in the event of a malfunction.

Contact a PEUGEOT dealer or a qualified workshop to have the system checked.

## Gear efficiency indicator

This system helps reduce fuel consumption by recommending the most appropriate gear.

## Operation

Depending on the driving situation and the vehicle's equipment, the system may advise skipping one or more gears.

Gear engagement recommendations are only optional. In fact, the configuration of the road, the traffic density and safety remain determining factors when choosing the best gear. Therefore, the driver remains responsible for deciding whether or not to follow the system's advice. This function cannot be deactivated.



With an automatic gearbox, the system is only active in manual operation.



The information appears in the instrument panel in the form of an arrow and the recommended gear.



The system adapts its gear shift recommendation according to the driving conditions (slope, load, etc.) and the driver's requirements (power, acceleration, braking, etc.).

The system never suggests:

- engaging first gear,
- engaging reverse.

## Stop & Start

The Stop & Start function puts the engine temporarily into standby - STOP mode - during phases when the vehicle is stopped (red lights,

queues, etc.). The engine restarts automatically - START mode - as soon as the driver wishes to move off again.

Primarily designed for urban use, the function is intended to reduce fuel consumption and exhaust emissions as well as the noise level when stationary.

The function does not affect the functionalities of the vehicle, in particular the braking.

### Deactivation/Reactivation

The function is **activated** by default when the ignition is switched on.



It is set via the **Driving / Vehicle** touch screen menu.

A message in the instrument panel confirms the change of status.

When the function is deactivated, if the engine was in standby, it restarts immediately.

### Associated indicator lamps



Function activated.



Function deactivated or malfunction.

### ! Opening the bonnet

Before doing anything under the bonnet, deactivate the Stop & Start system to avoid

any risk of injury caused by the engine restarting automatically.



### ! Driving on flooded roads

Before entering into a flooded area, it is strongly recommended that you deactivate the Stop & Start system.

For more information on **Driving recommendations**, particularly on flooded roads, refer to the corresponding section.

## Operation

### Main conditions for operation

- The driver's door must be closed.
- The driver's seat belt must be fastened.
- The state of charge of the battery must be sufficient.
- The temperature of the engine must be within its nominal operating range.
- The outside temperature must be between 0°C and 35°C.

### Putting the engine into standby (STOP mode)

The engine automatically goes into standby as soon as the driver indicates the intention of stopping.

- With a **manual gearbox**: with the gear lever in neutral and the clutch pedal released.

- With an **automatic gearbox**: with the brake pedal depressed until the vehicle stops or the gear selector in position **N**, with the vehicle stopped.

### Time counter

A time counter adds up the time spent in standby during a journey. It resets to zero every time the ignition is switched on.

### Special cases:

The engine will not go into standby if all of the conditions for operation are not met and in the following cases.

- Steep slope (ascending or descending).
- Vehicle has not exceeded 6 mph (10 km/h) since the last engine start (with the key or the "START/STOP" button).
- Needed to maintain a comfortable temperature in the passenger compartment.
- Demisting active.



In these cases, this indicator lamp flashes for a few seconds, then goes off.

**i** After the engine has restarted, STOP mode is not available until the vehicle has reached a speed of 5 mph (8 km/h).

**i** During parking manoeuvres, STOP mode is not available for a few seconds after coming out of reverse gear or turning the steering wheel.

## Engine restarting (START mode)

The engine automatically restarts as soon as the driver indicates the intention of moving off again.

- ▶ **With a manual gearbox:** with the clutch pedal fully depressed.
- ▶ **With an automatic gearbox:**
  - With the selector in position **D** or **M**: with the brake pedal released.
  - With the selector in position **N** and the brake pedal released: with the selector at **D** or **M**.
  - With the selector in position **P** and the brake pedal depressed: with the selector at **R**, **N**, **D** or **M**.
  - Reverse gear engaged.

### Special cases

The engine restarts automatically if all the operating conditions are met again and in the following cases.

- With a manual gearbox: vehicle speed exceeds 2.5 mph (4 km/h),
- With an automatic gearbox, in mode **N**, vehicle speed exceeds 0.6 mph (1 km/h).



In these cases, this indicator lamp flashes for a few seconds, then goes off.

## Malfunctions



In the event of a malfunction, this warning lamp flashes for a few moments, then remains on, accompanied by an onscreen message.

Have the vehicle checked by a PEUGEOT dealer or a qualified workshop.

## The vehicle stalls in STOP mode

All of the instrument panel warning lamps come on if there is a fault.

- ▶ Switch off the ignition then start the engine again with the key or the "START/STOP" button.



The Stop & Start system requires a 12 V battery of specific technology and specification.

All work concerning the battery must be carried out only by a PEUGEOT dealer or a qualified workshop.

## Under-inflation detection

This system automatically checks the pressures of the tyres while driving.

It compares the information given by the wheel speed sensors with **reference values, which must be reinitialised every time the tyre pressures are adjusted or a wheel changed.**

The system triggers an alert as soon as it detects a drop in the inflation pressure of one or more tyres.



Under-inflation detection does not replace the need for vigilance on the part of the driver.

This system does not avoid the need to regularly check the tyre pressures (including the spare wheel), especially before a long journey.

Driving with under-inflated tyres, particularly in adverse conditions (heavy load, high speed, long journey):

- worsens road-holding.
- lengthens braking distances.
- causes premature wear of the tyres.
- increases energy consumption.



The inflation pressures defined for the vehicle can be found on the tyre pressure label.

For more information on the **Identification markings**, refer to the corresponding section.



### Checking tyre pressures

This check should be done when the tyres are "cold" (vehicle stopped for 1 hour or after a journey of less than 6 miles (10 km) at moderate speeds).

Otherwise, add 0.3 bar to the pressures shown on the label.



### Snow chains

The system does not have to be reinitialised after fitting or removing snow chains.

## Under-inflation alert



This is signalled by the fixed illumination of this warning lamp, accompanied by an

audible signal and, depending on equipment, the display of a message.

- ▶ Reduce speed immediately, avoid excessive steering movements and avoid sudden braking.
- ▶ Stop the vehicle as soon as it is safe to do so.

**!** The loss of pressure detected does not always cause visible bulging of the tyre. Do not rely on just a visual check.

- ▶ Using a compressor, such as the one in the temporary puncture repair kit, check the pressures of the four tyres when cold.
- ▶ If it is not possible to make this check immediately, drive carefully at reduced speed.
- ▶ In the event of a puncture, use the temporary puncture repair kit or the spare wheel (depending on equipment).

**i** The alert is kept active until the system is reinitialised.

## Reinitialisation

Reinitialise the system after adjusting one or more tyre pressures and after changing one or more wheels.

**!** Before reinitialising the system, make sure that the pressures of the four tyres are correct for the conditions of use of the

vehicle and conform to the values written on the tyre pressure label.

Check the pressures of the four tyres before performing the reinitialisation.

The system does not advise if a pressure is incorrect at the time of reinitialisation.



With the vehicle stationary, the system is reinitialised via the **Driving /**

**Vehicle** touch screen menu..

## Malfunction



These warning lamps come on in the event of a malfunction.

A message appears, accompanied by an audible signal.

In this case, the tyre under-inflation monitoring function is no longer performed.

Have the system checked by a PEUGEOT dealer or a qualified workshop.

## Driving and manoeuvring aids - General recommendations

**i** Driving and manoeuvring aids cannot, in any circumstances, replace the need for vigilance on the part of the driver. The driver must comply with the Highway Code, must remain in control of the vehicle in all circumstances and must be able to retake control of it at all times. The driver must adapt

the speed to climactic conditions, traffic and the state of the road.

It is the driver's responsibility to constantly check the traffic, to assess the relative distances and speeds of other vehicles and to anticipate their movements before indicating and changing lane.

The systems cannot exceed the limits of the laws of physics.

### **i** Driving aids

You should hold the steering wheel with both hands, always use the interior and exterior rear view mirrors, always keep the feet close to the pedals and take a break every two hours.

### **i** Manoeuvring aids

The driver must always check the surroundings of the vehicle before and during the whole manoeuvre, in particular using the mirrors.

### **!** Radar

The operation of the radar as well as the associated functions may be impaired through the accumulation of dirt (mud, frost, etc.), in certain difficult weather conditions (very heavy rain, snow) or if the bumper is damaged. If the front bumper is to be repainted, contact a PEUGEOT dealer or a qualified workshop;



certain types of paint could interfere with the operation of the radar.



### ! Driving aids camera

This camera and its associated functions may be impaired or not work if the windscreen area in front of the camera is dirty, misty, frosty, covered with snow, damaged or masked by a sticker.

On versions with camera alone, this message indicates to you that the camera is obstructed: **"Driving aids camera: visibility limited, see user guide"**.

In humid and cold weather, demist the windscreen regularly.

Poor visibility (inadequate street lighting, heavy rain, thick fog, snowfall), dazzle (headlamps of an oncoming vehicle, low sun, reflections on a damp road, leaving a tunnel, alternating shade and light) can also impair detection performance.

In the event of a windscreen replacement, contact a PEUGEOT dealer or a qualified workshop to recalibrate the camera; otherwise, the operation of the associated driving aids may be disrupted.

### i Other cameras

The images from the camera(s) displayed on the touch screen or on the instrument panel may be distorted by the relief.

In the presence of areas in shade, or in conditions of bright sunlight or inadequate lighting, the image may be darkened and with lower contrast.

Obstacles may appear further away than they actually are.

### ! Sensors

The operation of the sensors as well as the associated functions may be disturbed by sound interference such as that emitted by noisy vehicles and machinery (e.g. lorries, pneumatic drills), by the accumulation of snow or dead leaves on the road or in the event of damaged bumpers and mirrors. When reverse gear is engaged, an audible signal (long beep) indicates that the sensors may be dirty.

A front or rear impact to the vehicle can upset the sensors' settings, which is not always detected by the system: distance measurements may be distorted.

The sensors do not systematically detect obstacles that are too low (pavements, studs) or too thin (trees, posts, wire fences). Certain obstacles located in the sensors' blind spots may not be detected or may no longer be detected during the manoeuvre.

Certain materials (fabrics) absorb sound waves: pedestrians may not be detected.

### i Maintenance

Clean the bumpers and door mirrors and the field of vision of the cameras regularly. When washing your vehicle at high pressure, direct the spray from at least 30 cm away from the radar, sensors and cameras.

### ! Mats

The use of mats not approved by PEUGEOT may interfere with the operation of the speed limiter or cruise control.

To avoid any risk of jamming the pedals:

- ▶ ensure that the mat is secured correctly,
- ▶ never fit one mat on top of another.

### i Units of speed

Ensure that the units of speed displayed on the instrument panel (mph or km/h) are those for the country you are driving in. If this is not the case, when the vehicle is stationary, set the display to the required units of speed so that it complies with what is authorised locally.

In case of doubt, contact a PEUGEOT dealer or a qualified workshop.

## Speed Limit Recognition and Recommendation

Refer to the **General recommendations on the use of driving and manoeuvring aids.**

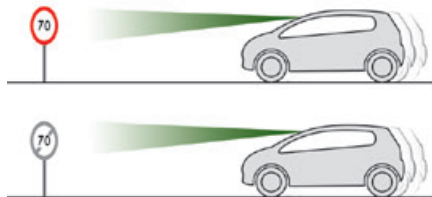

This system displays the maximum authorised speed in the instrument panel, according to the speed limits in the country in which you are driving, using:

- Speed limit signs detected by the camera.
- Speed limit details from the navigation system mapping.



**!** You should update your navigation mapping regularly in order to receive accurate speed limit information from the system.



- Signs indicating an intersection area detected by the camera:

Sign detected	Suggested speed (calculated)
<b>Entry into an intersection area</b> Example: 	<b>Without PEUGEOT Connect Nav</b> 10 mph or 20 km/h (depending on the units of the instrument panel) <b>With PEUGEOT Connect Nav</b> Display of the speed in force in the country in which you are driving.

- Certain qualifier plates are detected by the camera:

Qualifier plate detected	Display of the speed associated with the qualifier plate
<b>Speed limit in rain</b> Examples: 	If the wiper control stalk is in the "intermittent wipe" or "automatic wipe" position (in order to activate the rain sensor): 68 mph (110 km/h) (for example)

Qualifier plate detected	Display of the speed associated with the qualifier plate
<b>Speed limit if towing</b> 	If an approved towing device is fixed to the vehicle: 56 mph (90 km/h) (for example)
<b>Speed limit applicable over a certain distance</b> Example: 	43 mph (70 km/h) (for example)
<b>Speed limit for vehicles whose gross vehicle weight or gross train weight is less than 3.5 tonnes</b> 	56 mph (90 km/h) (for example)

Qualifier plate detected	Display of the speed associated with the qualifier plate
<b>Speed limit in snow</b> Example: 	If the exterior temperature is below 3 °C: 19 mph (30 km/h) (for example) with a "snowflake" symbol
<b>Speed limit at certain times</b> Example: 	19 mph (30 km/h) (for example) with a "clock" symbol

**!** The units for the speed limit (mph or km/h) depend on the country you are driving in. This should be taken into account so that you observe the speed limit. For the system to operate correctly when you change country, the units for speed in the instrument panel must be those for the country you are driving in.

**!** The automatic reading of road signs is a driving aid system and does not always display speed limits correctly. The speed limit signs present on the road always take priority over the display by the system. The system is designed to detect signs that conform to the Vienna Convention on road signs.

**i** Specific speed limits, such as those for heavy goods vehicles, are not displayed. The display of the speed limit in the instrument panel is updated as you pass a speed limit sign intended for cars (light vehicles).

## Activation / Deactivation

By default, the system is automatically activated at every engine start.



It is set via the **Driving / Vehicle** touch screen menu.

## Information displayed on the instrument panel

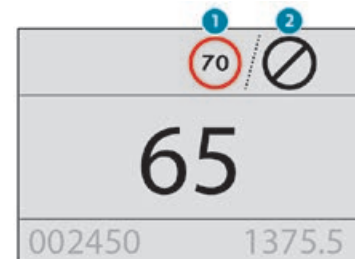

1. Detected speed limit indication or
2. End of speed limit indication



The system is active but is not detecting speed limit information.



On detecting speed limit information, the system displays the value.



In the case of suggested maximum speeds, the first time the vehicle exceeds the suggested speed by **more than 3 mph (5 km/h)** (e.g. 59 mph (95 km/h)), the speed is displayed flashing for 10 seconds.

## Operating limits

The system does not take account of reduced speed limits, especially those imposed in the following cases:

- Atmospheric pollution.
- Towing.
- Driving with a space-saver type spare wheel or snow chains fitted.
- Tyre repaired using the temporary puncture repair kit.
- Young drivers.

The system may not display the speed limit if it does not detect a speed limit sign within a preset period and in the following situations:

- Road signs that are obstructed, non-standard, damaged or bent.
- Obsolete or incorrect maps.

## Recommendation



In addition to **Speed Limit Recognition and Recommendation**, the driver can select the speed displayed as a speed setting for the speed limiter or cruise control using the speed limiter or cruise control memorisation button.

If rain is detected, the system will propose to the driver a speed setting lower than the speed read/obtained from the mapping in order to adapt to the weather conditions (example: on a motorway, the proposed speed will be 68 mph (110 km/h) instead of 81 mph (130 km/h)).

**i** For more information on the **Speed limiter, Cruise control or Adaptive cruise control**, refer to the corresponding sections.

## Steering mounted controls

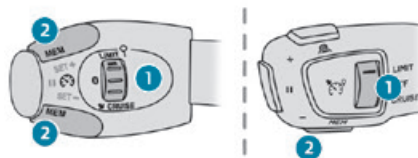

1. Speed limiter/cruise control mode selection

2. Memorise the speed setting

## Information displayed on the instrument panel



3. Speed limit indication
4. Speed memorisation prompt
5. Current speed setting

## Memorising the speed



- ▶ Switch on the speed limiter/cruise control. The speed limiter/cruise control information is displayed. Upon detecting a sign suggesting a new speed setting, the system displays the value and "MEM" flashes for a few seconds, prompting you to save it as the new speed setting.

**i** If there is a difference of less than 6 mph (9 km/h) between the speed setting and the speed displayed by the Speed Limit Recognition and Recommendation, the "MEM" symbol is not displayed.

Depending on the road conditions, several speeds may be displayed.

► Press button **2**once to save the suggested speed value.

A message is displayed to confirm the request.

► Press button **2**again to confirm and save the new speed setting.

The display then reverts to its previous state.

## Extended Traffic Sign Recognition

Refer to the **General recommendations on the use of driving and manoeuvring aids**.



This additional system recognises these **road signs** and displays them in the instrument panel if the appropriate display mode is selected.

One-way street: if you start driving the wrong way down a one-way street, an alert message, including the sign's symbol, is displayed in the instrument panel (request to check the traffic direction).

Other signs: when approaching one of these signs, the sign's symbol is displayed in the instrument panel.

**!** The actual road signs always take priority over the display from the system.

The signs must comply with the Vienna Convention on road signs.

### Activation / Deactivation



It is set via the **Driving / Vehicle** touch screen menu.

### Speed limiter

Refer to the **General recommendations on the use of driving and manoeuvring aids**.



This system prevents the vehicle from exceeding the speed programmed by the driver (speed setting).

The speed limiter is **switched on** manually.

The minimum speed setting is 19 mph (30 km/h).

The speed setting remains in the system memory when the ignition is switched off.

## Steering-mounted control

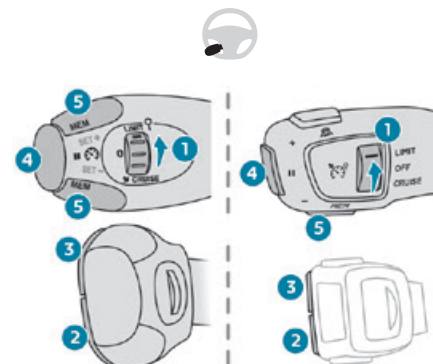

1. ON (**LIMIT** position) / OFF
2. Reduce the speed setting
3. Increase the speed setting
4. Pause / resume speed limiter with the speed setting previously stored
5. Use the speed suggested by the Speed Limit Recognition and Recommendation (**MEM** display)

For more information on the **Speed Limit Recognition and Recommendation**, refer to the corresponding section.

## Information displayed on the instrument panel

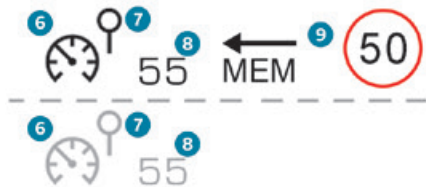

6. Speed limiter on/pause
7. Speed limiter mode selected
8. Programmed speed value
9. Speed suggested by the Speed Limit recognition and recommendation system (depending on version)

## Switching on/pausing

- ▶ Turn thumbwheel 1 to the "LIMIT" position to select the speed limiter; the function is paused.
- ▶ If you are satisfied with the limit speed setting (most recent speed setting programmed in the system), press button 4 to switch the speed limiter on.
- ▶ Pressing button 4 again temporarily pauses the function.

**i** An audible warning will sound if the vehicle's speed exceeds the speed setting for an extended period.

## Adjusting the limit speed setting

You do not have to switch the speed limiter on in order to set the speed.

To modify the limit speed setting based on the vehicle's current speed:

- ▶ Briefly press button 2 or 3 to change the value in steps of + or - 1 mph (1.6 km/h).
- ▶ Press and hold button 2 or 3 to change the value in steps of + or - 5 mph (8 km/h).

To modify the cruise speed setting based on the speed suggested by the Speed Limit Recognition and Recommendation, as shown on the instrument panel:

- ▶ Press button 5 once; a message is displayed to confirm the memorisation request.
- ▶ Press button 5 again to save the suggested speed.

The speed is immediately shown on the instrument panel as the new speed setting.

## Temporarily exceeding the speed setting

- ▶ Press the accelerator pedal down fully.

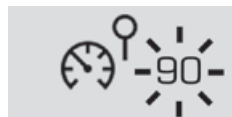

The speed limiter is deactivated temporarily and the displayed speed setting flashes.

- ▶ Release the accelerator pedal to return to below the programmed speed. When the limit speed is exceeded but this is not due to action by the driver (in case of a steep slope, for example), an audible signal triggers immediately.

**!** On a steep descent or in the event of sharp acceleration, the speed limiter will not be able to prevent the vehicle from exceeding the speed setting. Brake if necessary to control the speed of your vehicle.



Once the speed of the vehicle returns to the programmed setting, the speed limiter functions again: the display of the speed setting becomes fixed again.

## Switching off

- ▶ Turn the thumbwheel 1 to the "OFF" position: the display of information on the speed limiter disappears.

## Malfunction



Dashes are displayed (flashing, initially, then fixed) in the event of a speed limiter malfunction. Have the system checked by a PEUGEOT dealer or a qualified workshop.

## Cruise control - particular recommendations

**!** For the safety of everyone, only use the cruise control where the driving conditions allow running at a constant speed and keeping an adequate safety distance. **Remain vigilant** when the cruise control is activated. If you hold one of the speed setting modification buttons down, a very rapid change in the speed of your vehicle may occur.

When **descending a steep hill**, the cruise control system cannot prevent the vehicle from exceeding the set speed. Brake if necessary to control the speed of your vehicle.

On **steep climbs** or when towing, the set speed may not be reached or maintained.

### **i** Exceeding the programmed speed setting

The speed setting can be exceeded **temporarily** by pressing the accelerator pedal (the programmed speed flashes). To return to the speed setting, release the accelerator pedal (when this speed is reached again, the display of the speed stops flashing).

### **!** Operating limits

Never use the system in the following situations:

- In an urban area with the risk of pedestrians crossing the road.
- In heavy traffic (except versions with the Stop & Go function).
- On winding or steep roads.
- On slippery or flooded roads.
- In poor weather conditions.
- Driving on a speed circuit.
- Driving on a rolling road.
- When using snow chains, non-slip covers or studded tyres.

programmed by the driver (speed setting), without using the accelerator pedal. Cruise control is **switched on** manually. It requires a minimum vehicle speed of 25 mph (40 km/h).

With a manual gearbox, third gear or higher must be engaged.

With an automatic gearbox, mode **D** or second gear or higher in mode **M** must be engaged.

With a driver selector, mode **D** or **B** must be engaged.

**i** Cruise control remains active after changing gear, regardless of the gearbox type, on engines fitted with Stop & Start.

**i** Switching off the ignition cancels any speed setting.

## Steering mounted control

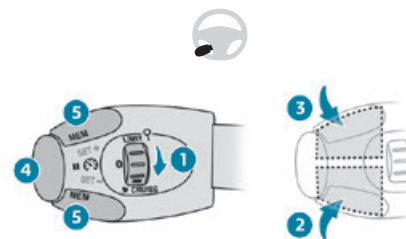

1. ON (CRUISE position) / OFF

## Cruise control

Refer to the **General recommendations on the use of driving and manoeuvring aids** and to **Cruise control - particular recommendations**.

 This system automatically keeps the vehicle's speed at the cruise value

2. Activate cruise control at the current speed / decrease speed setting
3. Activate cruise control at the current speed / increase speed setting
4. Pause / resume cruise control with the speed setting previously saved
5. Use the speed suggested by the Speed Limit Recognition and Recommendation (**MEM** display)

For more information on the **Speed Limit Recognition and Recommendation**, refer to the corresponding section.

## Information displayed on the instrument panel

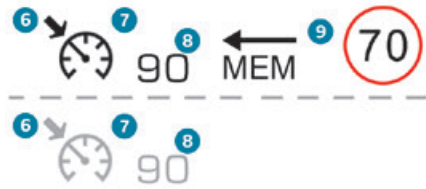

6. Cruise control pause/resume
7. Cruise control mode selection
8. Speed setting value
9. Speed suggested by the Speed Limit recognition and recommendation system (depending on version)

## Switching on/pausing

- ▶ Turn thumbwheel **1** to the "**CRUISE**" position to select cruise control mode; the function is paused.
- ▶ Press button **2** or **3** to activate cruise control and save a speed setting when the vehicle has reached the desired speed; the vehicle's current speed is saved as the speed setting.
- ▶ Release the accelerator pedal.
- ▶ Pressing button **4** temporarily pauses the function.
- ▶ Pressing button **4** again restores operation of the cruise control (ON).

- i Operation of the cruise control can also be paused temporarily:
  - by pressing the brake pedal.
  - automatically, if the electronic stability control (ESC) system is triggered.

## Modifying the cruise speed setting

Cruise control must be active.

To modify the cruise speed setting, based on the current speed of the vehicle:

- ▶ Briefly press button **2** or **3** to change the value in steps of + or - 1 mph (km/h).
- ▶ Press and hold button **2** or **3** to change the value in steps of + or - 5 mph (km/h).

**!** Pressing and holding button **2** or **3** results in a rapid change in the speed of the vehicle.

**!** As a precaution, we recommend setting a cruise speed fairly close to the current speed of your vehicle, to avoid any sudden acceleration or deceleration of the vehicle.

To modify the cruise speed setting using the speed suggested by the Speed Limit Recognition and Recommendation shown on the instrument panel:

- ▶ Press button **5** once; a message is displayed to confirm the memorisation request.
- ▶ Press button **5** again to save the suggested speed.

The speed is immediately shown on the instrument panel as the new speed setting.

## Switching off

- ▶ Turn the thumbwheel **1** to the "**OFF**" position: the cruise control information disappears from the screen.

## Malfunction





Dashes are displayed (flashing, initially, then fixed) in the event of a cruise control system malfunction.

Have the system checked by a PEUGEOT dealer or a qualified workshop.

## Drive Assist Plus

Only available on versions with the EAT8 automatic gearbox and gear selector.

This system automatically adjusts the speed and corrects the trajectory, using the Adaptive Cruise Control with Stop & Go function in conjunction with the Lane Positioning Assist.

These two functions must be activated and in operation.

This system is especially suitable for driving on motorways and main roads.

For more information on **Adaptive Cruise Control** and **Lane Positioning Assist**, refer to the corresponding sections.

**!** The system assists the driver by acting on the steering, acceleration and braking, within the limits of the laws of physics and the capabilities of the vehicle. Certain road infrastructure elements or vehicles present on the road may not be properly seen or may be poorly interpreted by the camera and radar, resulting in an unexpected change in direction, a lack of steering correction and/or inappropriate management of acceleration or braking.

## Adaptive Cruise Control

Refer to the **General recommendations on the use of driving and manoeuvring aids** and to **Cruise control - particular recommendations**.

This system **automatically** maintains the speed of your vehicle at a value which you set (speed setting), while keeping a safe distance from the vehicle in front (target vehicle), and which has been set beforehand by the driver. The system automatically manages the acceleration and deceleration of the vehicle.

With the **Stop & Go function**, the system manages the braking until the vehicle comes to a complete stop and the restarting of the vehicle.

**!** The brake lamps come on if the vehicle is slowed down by the system. It can be dangerous to drive if the brake lamps are not in perfect working order.



To do so, it has a camera located at the top of the windscreen and, depending on version, a radar located in the front bumper.

**!** Primarily designed for driving on main roads and motorways, this system only works with moving vehicles driving in the same direction as your vehicle.

**i** If the driver operates a direction indicator to overtake a slower vehicle, the cruise control allows the vehicle to temporarily approach the vehicle in front to assist the overtaking manoeuvre, without ever exceeding the speed setting.

**!** Some vehicles present on the road may not be properly seen or may be poorly interpreted by the camera and/or radar (e.g. a lorry), which may lead to a poor assessment of the distances and lead to the vehicle inappropriately accelerating or braking.

## Steering mounted control

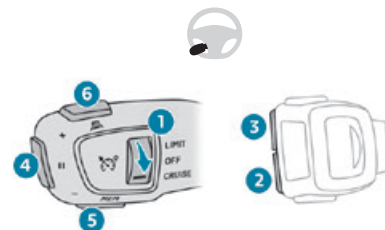

1. ON (**CRUISE** position) / OFF
2. Activation of cruise control at the current speed / decrease speed setting
3. Activation of cruise control at the current speed / increase speed setting

4. Pause / resume cruise control with the speed setting previously saved  
Confirmation of the restarting of the vehicle after automatic stop (versions with Stop & Go function)
5. Use the speed suggested by the Speed Limit Recognition and Recommendation (**MEM** display)
6. Display and adjustment of the distance setting to the vehicle in front

## Use

### Activating the system (pause)

► With the engine running, turn the thumbwheel **1** downwards to the **CRUISE** position. Cruise control is ready to operate (grey display).

### Switching on cruise control and setting the speed

With a manual gearbox, your speed must be between 19 and 112 mph (30 and 180 km/h). With an EAT8 automatic gearbox or a drive selector, your speed must be between 0 and 112 mph (0 and 180 km/h).

- Press button **2** or **3**: the current speed becomes the speed setting (minimum 19 mph (30 km/h)) and cruise control is immediately activated (green display).
- Press **3** to increase or **2** to decrease the speed setting (steps of 5 mph (km/h) if held pressed).

**!** Pressing and holding button **2** or **3** results in a rapid change in the speed of the vehicle.

### Pausing / resumption of cruise control

- Press **4** or depress the **brake pedal**. To pause cruise control, it is also possible to:
  - shift from mode **D** to **N**;
  - depress the clutch pedal for more than 10 seconds;
  - press the electric parking brake control.
- Press **4** to restart cruise control. Cruise control may have been paused automatically:
  - when the speed of the vehicle goes below 19 mph (30 km/h) with a manual gearbox.
  - when the speed of the engine goes below 1100 rpm with a manual gearbox.
  - by triggering of the ESC system.

With an EAT8 gearbox or a drive selector, following braking that has brought the vehicle to a complete stop, if the traffic conditions do not allow the vehicle to begin moving again within 3 seconds of stopping, press button **4** or the accelerator pedal to move off.

If the driver takes no action after the vehicle has been stopped, the electric parking brake is applied automatically after about 5 minutes.

**i** Cruise control remains active after changing gear, regardless of the gearbox type.

**!** When the driver attempts to reactivate cruise control, after the function has been paused, the message "Activation not possible, unsuitable conditions" is briefly displayed if reactivation is not possible (safety conditions not met).

### Changing the programmed speed setting with the Speed Limit Recognition and Recommendation function

- Press **5** to accept the speed suggested by the function on the instrument panel, then press again to confirm.

**!** To prevent sudden acceleration or deceleration of the vehicle, select a speed setting relatively close to the vehicle's current speed.

### Changing the inter-vehicle distance

- Press **6** to display the distance setting thresholds ("Distant", "Normal" or "Close"), then press again to select a threshold. After a few seconds, the option is accepted and will be memorised when the ignition is switched off.

### Temporarily exceeding the speed setting

- Fully depress the accelerator pedal. Distance monitoring and cruise control are deactivated while acceleration is maintained. "Cruise control suspended" is displayed.

## Deactivating the system

- ▶ Turn the thumbwheel 1 upwards to the OFF position.

## Information displayed on the instrument panel

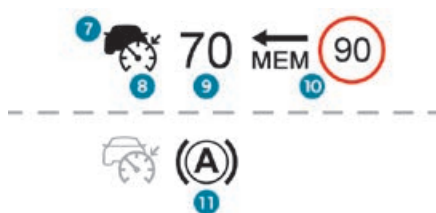









7. Vehicle detected by the system (full symbol)
8. Cruise control active (colour not grey)
9. Speed setting value
10. Speed suggested by the Speed Limit Recognition and Recommendation
11. Vehicle held stationary (versions with automatic gearbox or drive selector)



12. Inter-vehicle distance setting
13. Position of the vehicle detected by the system

## Messages and alerts



- i** The display of these messages or alerts is not sequential.

-  "Cruise control paused" or "Cruise control suspended" following a brief acceleration by the driver.
-  "Cruise control active", no vehicle detected.
-  "Cruise control paused", vehicle detected.
-  "Cruise control active", vehicle detected.
-   "Take back control" (orange).
- ▶ Brake or accelerate, depending on the context.
-   "Take back control" (red).

▶ **Take back control of the vehicle immediately:** the system cannot manage the current driving situation.

- i** "Activation not possible, conditions unsuitable". The system refuses to activate cruise control, as the necessary conditions are not fulfilled.

### Stop & Go function

-   "To move off again, press the accelerator pedal or press the II button" (button 4).

The system has brought the vehicle to a complete stop.

Within 3 seconds, the vehicle gradually and automatically begins moving again. After 3 seconds, the driver must accelerate or press button 4 to move off again.

- !** While the vehicle is immobilised, the following recommendations apply:
  - The driver should not leave the vehicle.
  - Do not open the boot.
  - Do not drop off or pick up passengers.
  - Do not engage reverse gear.

- !** When moving off again, watch out for cyclists, pedestrians and animals, as they may not be detected properly.

## Operating limits

Cruise control operates by day and night, in fog or moderate rainfall.

Certain situations cannot be managed by the system and require driver intervention.

### Elements not detected by the system:

- Pedestrians, some cyclists, animals.
- Stationary vehicles (traffic jam, breakdown, etc.).

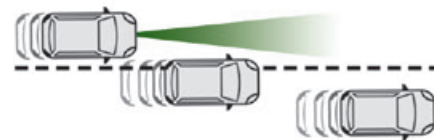

- Vehicles crossing your lane.

- Vehicles driving in the opposite direction.

**Situations in which the driver must pause the cruise control system:**

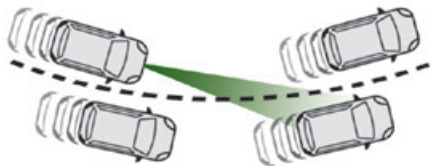

- Vehicles in a tight bend.
- When approaching a roundabout.

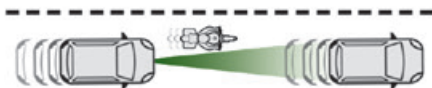

- When following a narrow vehicle.

**Situations in which the driver is prompted to immediately resume control:**

- Excessively sharp deceleration by the vehicle in front of you.

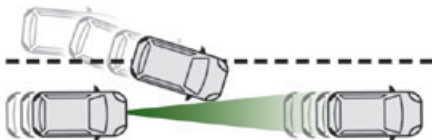

- When a vehicle cuts in sharply between your vehicle and the one in front.

- !** Pay particular attention:
- When motorcycles are present and when there are vehicles staggered across the traffic lane.
  - When entering a tunnel or crossing a bridge.

- !** If any of the following malfunctions occurs, do not use the system:
- Following an impact on the windscreen close to the camera or on the front bumper (versions with radar).
  - Brake lamps not working.

- !** If the vehicle has undergone any of the following modifications, do not use the system:
- Carrying long objects on roof bars.
  - Towing.
  - Front end of the vehicle modified (for example by adding long-range headlamps or painting the front bumper).

## Active Lane Keeping Assist

Refer to the **General recommendations on the use of driving and manoeuvring aids.**

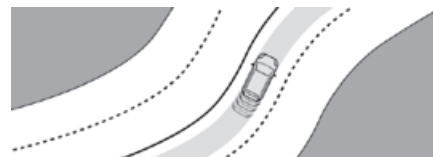

Using a camera located at the top of the windscreen, the system identifies lane markings and steers the vehicle inside this lane to keep it in the lateral position chosen by the driver. This function is primarily suitable for driving on motorways and main roads.

## Conditions for operation

- Adaptive Cruise Control active.
- Traffic lane marked out by lines on both sides.
- ESC system operational.
- ASR system activated.
- No trailer detected.
- No 'space-saver' spare wheel in use.
- Vehicle not subject to strong lateral g-forces.
- Direction indicators not activated.

## Activation/Deactivation



► With the Adaptive Cruise Control with Stop & Go function activated, press this button.

The action is confirmed by:

- The indicator lamp in the button lighting up green.
- The following symbol being displayed on the instrument panel.

The colour of the symbol on the instrument panel depends on the operating status of the system:



(grey colour)

One or more operating conditions is not met; the system is paused.



(green colour)

All operating conditions are met; the system is active.



(orange colour)

System malfunction.

If the driver no longer wishes to use the system for a while, they can deactivate it by pressing the button again.

The indicator lamp in the button goes off and the symbol disappears from the instrument panel.



The system status is saved when the ignition is switched off.

## Cruise control

The driver must hold the steering wheel properly. When cruise control is activated, the symbol is displayed in green: by small steering actions, the system directs the vehicle and keeps it in the position chosen by the driver, in the traffic lane.

This position is not necessarily the centre of the lane.

The driver can feel movements in the steering wheel.

The driver can change the position of the vehicle at any time, by turning the steering wheel.

When the driver feels that the vehicle's position is appropriate, whilst keeping hands on the steering wheel, they must release the pressure to let the system resume control of the steering, but the vehicle will not be automatically centred within the lane.

## Pausing/Suspending the system



The driver must act promptly if they believe that the traffic conditions or the state of the road surface require their intervention, by moving the steering wheel to temporarily suspend system operation. Any action on the brake pedal that results in cruise control being paused will also cause the system to be paused.



If the system detects that the driver is not holding the wheel firmly enough, it triggers a series of gradual alerts and then deactivates itself if there is no response from the driver.



If the function is suspended due to the prolonged release of the force holding the steering wheel, you must reactivate it by pressing the button again.

### Automatic pause













- Triggering of the ESC.
- Prolonged failure to detect one of the lane limit markings. In this case, the active lane departure warning function can take over, and the system will reactivate itself once the operating conditions are again met.



### In response to action by the driver: suspension

- Activation of the direction indicators.
- Travelling outside the lane limits.
- Too tight a grip on the steering wheel or dynamic action on the steering wheel.
- Action on the brake pedal (resulting in a pause until cruise control is reactivated) or accelerator pedal (suspension for as long as the pedal is depressed).
- Pausing of the cruise control.
- Deactivation of the ASR.

## Driving situations and related alerts

The tables below describe the displays associated with the main driving situations. The display of these alerts is not sequential.

Button indicator lamp	Cruise control thumbwheel	Symbols	Display	Comments
Off	CRUISE	 (grey)	 (grey)	Cruise control paused; lane positioning assist not active.
Off	CRUISE	 (green)	 (grey)	Cruise control active; lane positioning assist not active.
Green	CRUISE	 (green)	 (green)	Drive Assist Plus active, operates normally (correction is made at the steering wheel).
Green	CRUISE	 (grey)	 (grey)	Drive Assist Plus paused.
Green	CRUISE	 (green)/(grey)	 (grey)	Drive Assist Plus active; not all conditions required for lane positioning assist have been met.
Green	OFF or LIMIT	 (grey)	 (grey)	Cruise control not active; not all conditions required for lane positioning assist have been met.

Button indicator lamp	Cruise control thumbwheel	Symbols	Display	Comments
Green	CRUISE	 (green)/(grey)	 (grey)	Drive Assist Plus suspended: cruise control and lane positioning assist are suspended.

Messages	Driving situations
"Activate cruise control to use the lane positioning assist system"	Activation of lane positioning assist while cruise control is not active.
"Unsuitable conditions, Activation on stand-by"	Activation of lane positioning assist while not all conditions are met.
"Keep your hands on the steering wheel"	Prolonged driving without holding the steering wheel, holding it improperly or without applying any force.
"Hold the steering wheel"	Actual or imminent loss of lane positioning assist.
"Retake control"	Simultaneous loss of cruise control and lane positioning assist.

## Operating limits

**i** The Lane Keeping Assist system may issue an alert when the vehicle is travelling in a long straight lane on a smooth road surface even if the driver is holding the steering wheel properly.

The system may fail to operate or may produce unsuitable corrections to the steering in the following situations:

- Poor visibility (insufficient road lighting, snowfall, rain, fog).

- Dazzle (headlamps of an oncoming vehicle, low sun, reflections on a wet road surface, leaving a tunnel, alternating light and shade).
- Windscreen area in front of the camera being dirty, misted up, frost-covered, snow-covered, damaged or masked by a sticker.
- Lane markings eroded, partially hidden (snow, mud) or multiple (roadworks, surface joints).
- Travelling in a tight bend.
- Winding roads.
- Presence of a tarmac joint on the road.

**!** The system must not be activated in the following situations:

- Driving with a "space-saver" type spare wheel.
- When towing, especially with an unconnected or unapproved trailer.
- Poor weather conditions.
- Driving on slippery road surfaces (risk of aquaplaning, snow, ice).
- Driving on racing circuits.
- Driving on a rolling road.

## Malfunction



A system malfunction is indicated by the Service warning lamp coming on and this (orange) symbol, accompanied by an alert message and an audible signal.

## Active Lane Keeping Assistance

Refer to the **General recommendations on the use of driving and manoeuvring aids**.

Using a camera located at the top of the windscreen to identify lane markings on the road and at the edges of the road (depending on version), the system corrects the trajectory of the vehicle while alerting the driver if it detects a risk of unintentionally crossing a line or hard shoulder (depending on version).

This system is particularly useful on motorways and main roads.

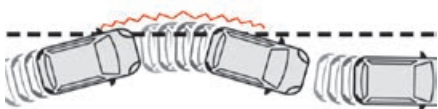

## Conditions for operation

- Vehicle speed between 40 and 112 mph (65 and 180 km/h).
- Road marked with a central dividing line.
- Steering wheel held in both hands.

- Direction indicators not activated.
- ESC system activated and operational.

**!** The system helps the driver only if there is a risk of the vehicle unintentionally wandering from the lane it is being driven in. It does not manage the safe driving distance, vehicle speed or brakes.

The driver must hold the steering wheel with both hands in a way that allows control to be maintained in circumstances where the system is not able to intervene (for example, if the central dividing line disappears).

## Operation

Once the system identifies a risk of the vehicle involuntarily crossing one of the lane markings detected or a lane limit (e.g. grass border), it makes the necessary trajectory correction to return the vehicle to its initial path.

The driver will notice a turning movement of the steering wheel.



This warning lamp flashes during trajectory correction.

**i** The driver can prevent the correction by keeping a firm grip on the wheel (during an avoiding manoeuvre, for example). The correction is interrupted immediately if the direction indicators are operated.

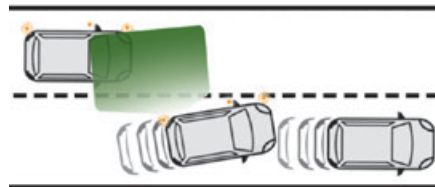

While the direction indicators are on and for a few seconds after switching them off, the system considers that any change of trajectory is intentional and no correction is triggered during this period.

However, with the Blind Spot Monitoring System activated, if the driver starts changing lanes and another vehicle is detected in the vehicle's blind spot, the system will correct the trajectory even though the direction indicators are on.







For more information on the **Blind Spot Monitoring System**, refer to the corresponding section.

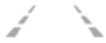
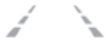

**!** If the system detects that the driver is not holding the wheel firmly enough during an automatic correction of trajectory, it interrupts the correction. An alert is triggered to encourage the driver to take back control of the vehicle.



## Driving situations and related alerts

The table below describes the alerts and messages displayed in different driving situations. These alerts are not displayed sequentially.

Function status	Indicator lamp	Display and/or associated message	Comments
OFF		 (grey)	Function deactivated.
ON		 (grey)	System active, conditions not met: <ul style="list-style-type: none"> <li>– speed below 40 mph (65 km/h),</li> <li>– no lane marking recognised,</li> <li>– ASR/DSC systems deactivated or operation of ESC system triggered,</li> <li>– "sport" driving.</li> </ul>
ON		 (grey)	Automatic deactivation/standby of the function (for example, due to detection of a trailer or use of the "space-saver" spare wheel provided with the vehicle).
ON		 (green)	Lane marking detection. Speed above 40 mph (65 km/h).
ON		 (orange)/(green)	The system corrects the trajectory on the side where the risk of unintentional crossing is detected (orange line).

Function status	Indicator lamp	Display and/or associated message	Comments
ON		 (orange)/(green) "Hold the wheel!"	<ul style="list-style-type: none"> <li>– If, while correcting the trajectory, the system determines that the correction will not be enough and that a solid line will be crossed (orange line): the driver is warned that they must provide additional trajectory adjustment.</li> <li>– If the steering wheel is not held properly, an audible warning sounds, accompanied by a message, until the trajectory correction is completed or the driver has grasped the steering wheel correctly.</li> </ul> <p>The duration of audible warnings will increase if multiple corrections are performed in quick succession. The warning will become continuous, persisting until the driver responds.</p>

## Operating limits

The system goes into standby automatically in the following cases:

- ESC deactivated or operation triggered.
- Speed below 43 mph (70 km/h) or greater than 112 mph (180 km/h),
- Electrical connection of a trailer.
- Use of a "space-saver" spare wheel detected (as detection is not immediate, deactivation of the system is recommended).
- Dynamic driving style detected, pressure on the brake or accelerator pedal.
- Driving where there are no lane markings.
- Activation of the direction indicators.
- Crossing the inside line on a bend.
- Driving in a tight corner.

– Inactivity by the driver detected during correction.

-  The following situations may interfere with the operation of the system or prevent it from working:
- Insufficient contrast between the road surface and the side of the road (e.g. shade).
  - Lane markings worn, hidden (snow, mud) or multiple (roadworks, etc.),
  - Running close to the vehicle in front (the lane markings may not be detected).
  - Roads that are narrow, winding.

### Risk of undesirable operation

We recommend deactivating the system in the following driving situations:

- Driving on damaged, unstable or very slippery (ice) road surfaces,
- Poor weather conditions.
- Driving on a speed circuit.
- Driving on a rolling road.

## Deactivation / Activation



► Press this button to deactivate / reactivate the system at any time.



Deactivation is signalled by the lighting of the indicator lamp in the button and this warning lamp in the instrument panel.

The system is **automatically reactivated** every time the ignition is switched on.

## Malfunction



In the event of a system malfunction, these warning lamps come on on the instrument panel, accompanied by an onscreen message and an audible signal. Have the system checked by a PEUGEOT dealer or a qualified workshop.

## Active Blind Spot Monitoring System

Refer to the **General recommendations on the use of driving and manoeuvring aids**.

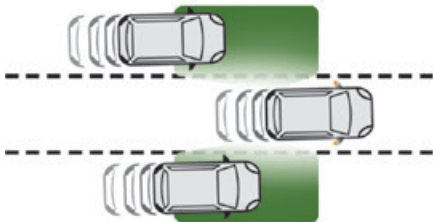

This system includes sensors, placed on the sides of the bumpers, and warns the driver of

the potentially dangerous presence of another vehicle (car, truck, motorcycle) in the blind spot areas of their vehicle (areas hidden from the driver's field of vision).

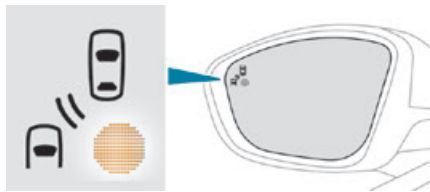

The warning is given by a fixed warning lamp that appears in the door mirror on the side in question:

- immediately, when being overtaken;
- after a delay of about one second, when overtaking a vehicle slowly.

In addition to this alert, a correction of trajectory will be felt if you attempt to cross a line with the direction indicator activated, to help you avoid a collision.

## Activation / Deactivation



It is set via the **Driving / Vehicle** touch screen menu.

When starting the vehicle, the warning lamp comes on in each mirror to indicate that the system is activated.

The state of the system stays in the memory when switching off the ignition.

**i** The system is automatically deactivated when towing with a towing device approved by PEUGEOT.

## Conditions for operation

- All vehicles are moving in the same direction and in adjacent lanes.
- The speed of the vehicle must be between 7 and 87 mph (12 and 140 km/h) for the alert and between 40 and 87 mph (65 and 140 km/h) for a correction of trajectory.
- The system must be activated to trigger a change of trajectory.
- When you overtake a vehicle with a speed difference of less than 6 mph (10 km/h).
- When another vehicle overtakes you with a speed difference of less than 16 mph (25 km/h).
- Traffic is flowing normally.
- Overtaking a vehicle over a certain period of time and the vehicle being overtaken remains in the blind spot.
- You are driving on a straight or slightly curved road.
- Your vehicle is not pulling a trailer, a caravan, etc.

## Operating limits

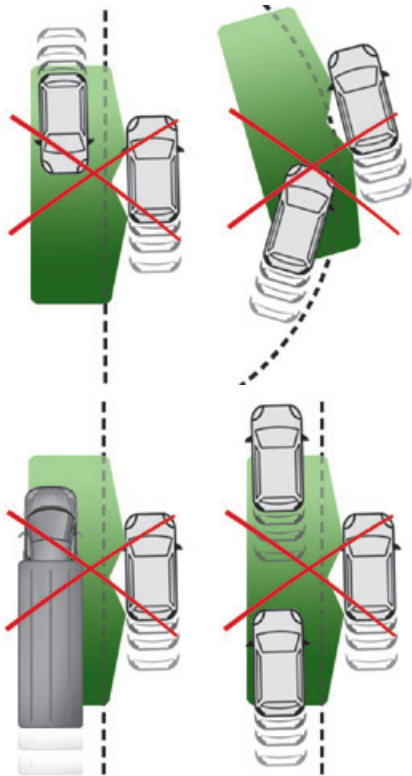

No alert will be given and no correction will be made in the following situations:

- In the presence of non-moving objects (parked vehicles, barriers, street lamps, road signs, etc.).
- Oncoming traffic.
- Driving on a winding road or a sharp corner.
- When overtaking or being overtaken by a very long vehicle (lorry, bus, etc.) which is both detected in the rear blind spot and present in the driver's front field of vision.
- When overtaking quickly.
- In very heavy traffic: vehicles detected in front and behind are confused with a lorry or a stationary object.
- If the Park Assist or Full Park Assist function is activated.

## Malfunction



If the event of a malfunction, this warning lamp comes on in the instrument panel, accompanied by the display of a message. Contact a PEUGEOT dealer or a qualified workshop to have the system checked.

- i** The system may suffer temporary interference in certain weather conditions (rain, hail, etc.). In particular, driving on a wet surface or moving from a dry area to a wet area can cause false alerts (for example, the presence of a fog of water droplets in the blind spot angle is interpreted as a vehicle). In bad or wintry weather, ensure that the sensors are not covered by mud, ice or snow.

Take care not to cover the warning zone in the door mirrors, or the detection zones on the front and rear bumpers with adhesive labels or other objects; they may hamper correct operation of the system.

## Active Safety Brake with Distance Alert and Intelligent emergency braking assistance

Refer to the **General recommendations on the use of driving and manoeuvring aids**.



This system:

- warns the driver that their vehicle is at risk of collision with the vehicle in front, a pedestrian or, depending on version, a cyclist.
- reduces the vehicle's speed to avoid a collision or limit its severity.

- i** The system also takes motorcyclists and animals into account; however, animals below 0.5 m tall and objects on the road are not necessarily detected.

This system is comprised of three functions:

- Distance Alert.
- Intelligent emergency braking assistance.

– Active Safety Brake (automatic emergency braking).

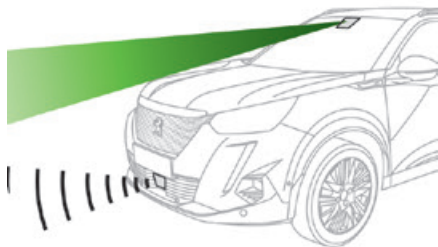

The vehicle has a multifunction camera located at the top of the windscreen and, depending on version, a radar located in the front bumper.

**!** This system does not avoid the need for vigilance on the part of the driver.

This system is designed to assist the driver and improve road safety.

It is the driver's responsibility to continuously monitor traffic conditions in accordance with applicable driving regulations.

**i** As soon as the system detects a potential obstacle, it prepares the braking circuit in case automatic braking is needed. This may cause a slight noise and a slight sensation of deceleration.

## Deactivation / Activation

By default, the system is automatically activated at every engine start.



It is set via the **Driving / Vehicle** touch screen menu.



Deactivation of the system is signalled by the illumination of this warning lamp, accompanied by the display of a message.

## Operating conditions and limits

Vehicle moving forward.

ESC system in working order.

ASR system activated.

Seat belts fastened for all passengers.

Stabilised speed on unwinding roads.

In the following cases, deactivating the system via the vehicle's configuration menu is advised:

- Towing a trailer.
- Carrying long objects on roof bars.
- Vehicles with snow chains fitted.
- Before using an automatic car wash, with the engine running.
- Before placing the vehicle on a rolling road in a workshop.
- Towed vehicle, engine running.
- Following an impact to the windscreen close to the detection camera.



The system is automatically deactivated after the use of certain types of "space-saver" type spare wheel (smaller

diameter) is detected, or if a fault with brake pedal switch or at least two brake lamps is detected.



It can be dangerous to drive if the brake lamps are not in perfect working order.



It is possible that warnings are not given, are given too late or seem unjustified. The driver must always stay in control of the vehicle and be prepared to react at any time to avoid an accident.



After an impact, the function automatically stops operating. Contact a PEUGEOT dealer or a qualified workshop to have the system checked.

## Distance Alert

This function warns the driver that their vehicle is at risk of a collision with the vehicle in front, or a pedestrian or cyclist present in their traffic lane.

### Modifying the alert trigger threshold

This trigger threshold determines the sensitivity with which the function warns of the risk of collision.



The threshold is set via the **Driving / Vehicle** touch screen menu.

- ▶ Select one of the three pre-defined thresholds: "Far", "Normal" or "Close".

The last threshold selected is memorised when the ignition is switched off.

## Operation

Depending on the degree of risk of collision detected by the system and the alert trigger threshold chosen by the driver, several different levels of alert may be triggered and displayed in the instrument panel.

The system takes account of the vehicle dynamics, the speed of your vehicle and the one in front, the environmental conditions and the operation of the vehicle (actions on the pedals, the steering wheel, etc.) to trigger the alert at the best moment.



**Level 1 (orange):** visual alert only, indicating that the vehicle in front is very close.

The message "Vehicle close" is displayed.



**Level 2 (red):** visual and audible alert, indicating that a collision is imminent.

The message "Brake!" is displayed.

**Level 3:** in some cases, a vibration alert in the form of micro-braking can be given, confirming the risk of collision.

**i** Where the speed of your vehicle is too high approaching another vehicle, the first level of alert may not be displayed: the level 2 alert may be displayed directly.

**Important:** the level 1 alert is not displayed when there is a stationary obstacle or when

the "Close" trigger threshold has been selected.

## Intelligent emergency braking assistance

If the driver brakes, but not sufficiently to avoid a collision, this system will supplement the braking, within the limits of the laws of physics.

This assistance will only be provided if the driver presses the brake pedal.

## Active Safety Brake



This function, also called automatic emergency braking, intervenes following the alerts if the

driver does not react quickly enough and does not operate the vehicle's brakes. It aims to reduce the speed of impact or avoid a collision where the driver fails to react.

## Operation

The system operates subject to the following conditions:

- The vehicle's speed does not exceed 37 mph (60 km/h) when a pedestrian is detected.
- The vehicle's speed does not exceed 50 mph (80 km/h) when a stationary vehicle or a cyclist is detected.
- The vehicle's speed is between 6 mph and 53 mph (10 km/h and 85 km/h) (versions with camera only) or 87 mph (140 km/h) (versions with camera and radar) when a moving vehicle is detected.



This warning lamp immediately flashes (for approximately 10 seconds) when the function acts on the vehicle's braking.

With an automatic gearbox or drive selector, in the event of automatic emergency braking until the vehicle comes to a complete stop, keep the brake pedal pressed down to prevent the vehicle from moving off again.

With a manual gearbox, in the event of automatic emergency braking until the vehicle comes to a complete stop, the engine may stall.

**i** The driver can maintain control of the vehicle at any time by firmly turning the



steering wheel and/or firmly depressing the accelerator pedal.

**i** The brake pedal may vibrate slightly while the function is operating. If the vehicle comes to a complete stop, automatic braking is maintained for 1 to 2 seconds.

## Malfunction

 In the event of a system malfunction, this warning lamp comes on on the instrument panel, accompanied by an onscreen message and an audible signal.

Contact a PEUGEOT dealer or a qualified workshop to have the system checked.

  If these warning lamps come on after the engine has been switched off and then restarted, contact a PEUGEOT dealer or a qualified workshop to have the system checked.

## Distraction detection

Refer to the **General recommendations on the use of driving and manoeuvring aids**.

Take a break in case of feeling tired or at least every 2 hours.

The function comprises the "Driver Attention Alert" system combined with the "Driver Attention Alert by camera" system.

**!** These systems are in no way designed to keep the driver awake or to prevent the driver from falling asleep at the wheel. It is the driver's responsibility to stop if feeling tired.

## Activation / Deactivation



It is set via the **Driving / Vehicle** touch screen menu.

The state of the system stays in the memory when the ignition is switched off.

## Driver Attention Alert



The system triggers an alert as soon as it detects that the driver has not taken a break after two hours of driving at a speed above 40 mph (65 km/h).

This alert is issued via the display of a message encouraging the driver to take a break, accompanied by an audible signal. If the driver does not follow this advice, the alert is repeated hourly until the vehicle is stopped. The system resets itself if one of the following conditions is met:

- With the engine running, the vehicle has been stationary for more than 15 minutes.
- The ignition has been switched off for a few minutes.
- The driver's seat belt is unfastened and their door is opened.

**i** As soon as the speed of the vehicle drops below 40 mph (65 km/h), the system goes into standby. The driving time is counted again once the speed is above 40 mph (65 km/h).

## Driver Attention Alert by camera

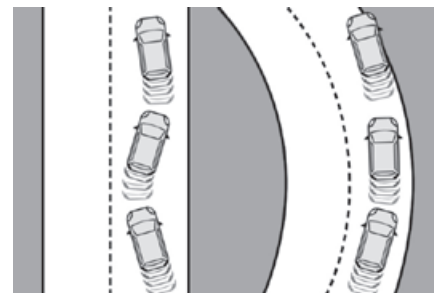

 Using a camera placed at the top of the windscreen, the system assesses the driver's level of vigilance, fatigue or distraction by identifying variations in trajectory compared to the lane markings.

This system is particularly suited to fast roads (speed higher than 40 mph (65 km/h)).

At a first-level alert, the driver is warned by the "Take care!" message, accompanied by an audible signal.

After three first-level alerts, the system triggers a further alert with the message "Dangerous

**driving: take a break"**, accompanied by a more pronounced audible signal.

**i** In certain driving conditions (poor road surface or strong winds), the system may give alerts independent of the driver's level of vigilance.

- !** The following situations may interfere with the operation of the system or prevent it from working:
- lane markings absent, worn, hidden (snow, mud) or multiple (roadworks);
  - close to the vehicle ahead (lane markings not detected);
  - roads that are narrow, winding, etc.

## Parking sensors

Refer to the **General recommendations on the use of driving and manoeuvring aids**.

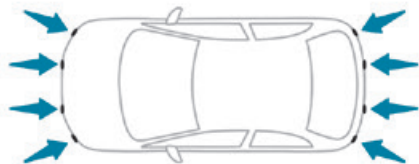

Using sensors located in the bumper, this system signals the proximity of obstacles (e.g. pedestrian, vehicle, tree, barrier) present in their field of detection.

## Rear parking sensors

The system is switched on by engaging reverse gear, as confirmed by an audible signal.

The system is switched off when you come out of reverse gear.

### Audible assistance



The system signals the presence of obstacles within the sensors' detection zone.

The proximity information is given by an intermittent audible signal, the frequency of which increases as the vehicle approaches the obstacle.

When the distance between the vehicle and the obstacle becomes less than about thirty centimetres, the audible signal becomes continuous.

The sound emitted by the speaker (right or left) indicates the side on which the obstacle is located.

### **i** Adjusting the audible signal

 With PEUGEOT Connect Radio or PEUGEOT Connect Nav, pressing

this button opens the window for adjusting the volume of the audible signal.

## Visual assistance



This supplements the audible signal by displaying bars on the screen that represent the distance between the obstacle and the vehicle (white: more distant, orange: close, red: very close).

When the obstacle is very close, the "Danger" symbol is displayed on the screen.

## Front parking sensors

Supplementing the rear parking sensors, the front parking sensors are triggered when an obstacle is detected in front and the speed of the vehicle is still below 6 mph (10 km/h).

Front parking sensor operation is suspended if the vehicle stops for more than three seconds in forward gear, if an obstacle is no longer detected or the vehicle speed exceeds 6 mph (10 km/h).

**i** The sound emitted by the speaker (front or rear) locates the obstacle relative to the vehicle, in front or behind it.



## Side parking sensors



Using four additional sensors located on the sides of the bumpers, the system records the position of obstacles during the manoeuvre and indicates them when they are located alongside the vehicle.

**!** Only fixed obstacles are indicated correctly. Moving obstacles detected at the beginning of the manoeuvre may be indicated mistakenly, while moving obstacles that appear alongside the vehicle but were not previously recorded will not be indicated.

**!** Objects memorised during the manoeuvre will no longer be stored after switching off the ignition.

## Deactivation / Activation



It is set via the **Driving / Vehicle** touch screen menu.

The state of the system stays in the memory when the ignition is switched off.



**i** The rear parking sensors system will be deactivated automatically if a trailer or bicycle carrier is connected to a towing device installed in accordance with the manufacturer's recommendations. In this case, the outline of a trailer is displayed at the rear of the image of the vehicle.

The parking sensors are deactivated while the Park Assist and Full Park Assist functions are measuring a space. For more information on the **Park Assist** or the **Full Park Assist**, refer to the corresponding section.

**i** When the vehicle is started, the visual and audible aids will be available after the touch screen has started up.

## Operating limits

If the boot is heavily loaded, the vehicle may tilt, affecting distance measurements.

## Malfunction



In the event of a malfunction when shifting to reverse, one of these warning lamps comes on on the instrument panel, accompanied by the display of a message and an audible signal (short beep). Contact a PEUGEOT dealer or a qualified workshop to have the system checked.

## Visiopark 1

Refer to the **General recommendations on the use of driving and manoeuvring aids**.

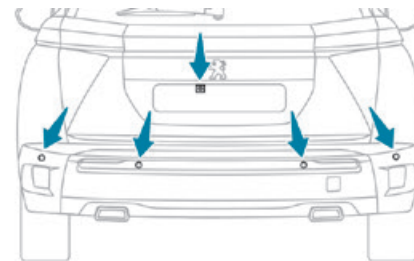

As soon as reverse gear is engaged with the engine running, this system displays views of your vehicle's close surroundings on the touch screen using a camera located at the rear of the vehicle.

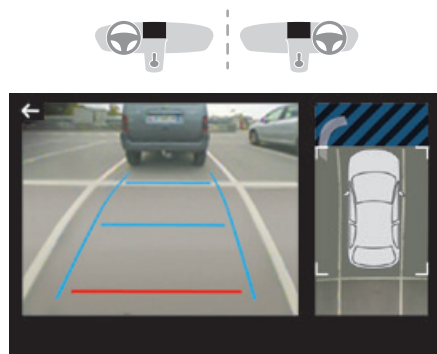

The screen is divided into two parts with a contextual view and a view from above the vehicle in its close surroundings. The parking sensors supplement the information on the view from above the vehicle.

Various contextual views may be displayed:

- Standard view.
- 180° view.
- Zoom view.

AUTO mode is activated by default.

In this mode, the system chooses the best view to display (standard or zoom).

You can change the type of view at any time during a manoeuvre.

The system status is not saved when the ignition is switched off.

## Principle of operation

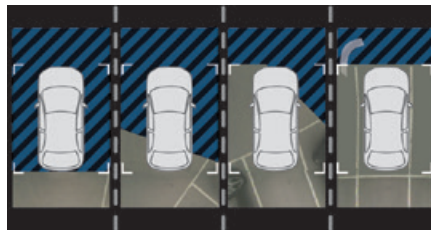

Using the rear camera, the vehicle's close surroundings are recorded during manoeuvres at low speed.

An image from above your vehicle in its close surroundings is reconstructed (represented between the brackets) in real time and as the manoeuvre progresses.

It facilitates the alignment of your vehicle when parking and allows obstacles close to the vehicle to be seen. It is automatically deleted if the vehicle remains stationary for too long.

## Rear vision



To activate the camera, located on the tailgate, engage reverse and keep the speed of the vehicle below 6 mph (10 km/h).

The system is deactivated:

- Automatically, at speeds above approximately 12 mph (20 km/h),
- Automatically, if the tailgate is opened.
- When changing out of reverse gear.
- By pressing the white arrow in the upper-left corner of the touch screen.

## AUTO mode

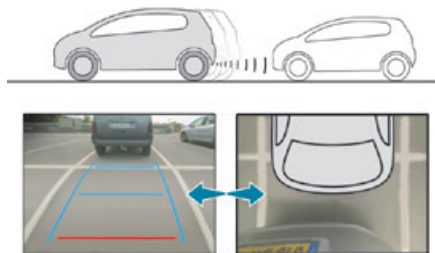

This mode is activated by default. Using sensors in the rear bumper, the automatic view changes from the rear view (standard) to the view from above (zoom) as an obstacle is approached at the level of the red line (less than 30 cm) during a manoeuvre.

## Standard view

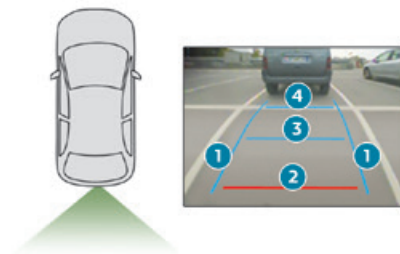

The area behind the vehicle is displayed on the screen.

The blue lines **1** represent the width of your vehicle, with the mirrors unfolded; their direction changes according to the position of the steering wheel.

The red line **2** represents a distance of 30 cm from the rear bumper; the two blue lines **3** and **4** represent 1 m and 2 m, respectively. This view is available with AUTO mode or in the view selection menu.

## Zoom view

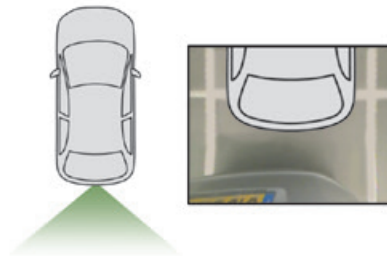

The camera records the vehicle's surroundings during the manoeuvre in order to create a view from above the rear of the vehicle in its near surroundings, allowing the vehicle to be manoeuvred around nearby obstacles. This view is available with AUTO mode or in the view selection menu.

**i** Obstacles may appear further away than they actually are.

It is important to monitor the sides of the vehicle during the manoeuvre, using the mirrors.

Parking sensors also provide additional information about the area around the vehicle.

## 180° view

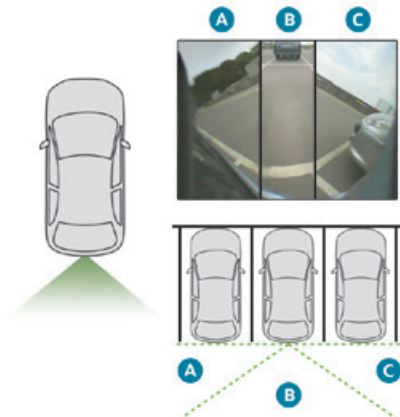

The 180° view facilitates reversing out of a parking space, making it possible to see the approach of vehicles, pedestrians and cyclists. This view is not recommended for carrying out a complete manoeuvre.

It features 3 areas: left **A**, centre **B** and right **C**.

This view is only available via the view selection menu.

## Park Assist

Refer to the **General recommendations on the use of driving and manoeuvring aids**.

This system provides active parking assistance: it detects a parking space and then steers in the appropriate direction to park in the space while the driver controls the driving direction, gear changes, acceleration and braking.

To help the driver monitor the manoeuvre, the system automatically triggers the display of Visiopark 1 and activates the parking sensors. The system measures the available parking spaces and calculates the distances to obstacles using ultrasonic sensors built into the front and rear bumpers of the vehicle.

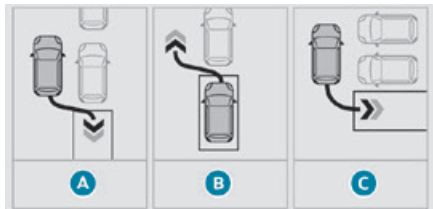

The system assists with the following manoeuvres:

- A.** Entering a "parallel" parking space
- B.** Leaving a "parallel" parking space
- C.** Entering a "bay" parking space

## Operation

- ▶ When approaching a parking area, reduce the speed of your vehicle to 19 mph (30 km/h) or less.

### Activating the function



The function is activated in the **Vehicle / Driving** touch screen menu.

Select **"Park Assist"**.



Activating the function deactivates the Blind Spot Monitoring System.



You can deactivate the function at any time until the parking space entry or exit manoeuvre begins, by pressing the arrow located in the top left-hand corner of the display page.

### Selecting the type of manoeuvre

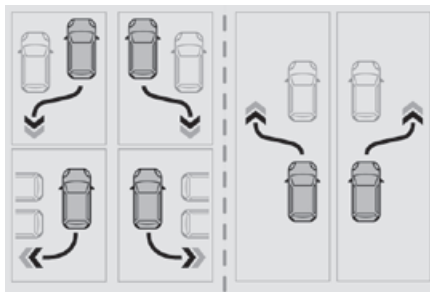

A manoeuvre selection page is displayed on the touch screen: by default, the "Entry" page if the vehicle has been running since the ignition was switched on, otherwise, the "Exit" page.

- ▶ Select the type and side of the manoeuvre to activate the parking space search.

The selected manoeuvre can be changed at any time, even while searching for an available space.



This indicator lamp comes on to confirm the selection.

### Parking space search

- ▶ You should drive at a distance of between 0.50 m and 1.50 m from the row of parked vehicles, without ever exceeding 19 mph (30 km/h), until the system finds an available space.

The parking space search stops over this limit.

The function automatically deactivates once the vehicle speed exceeds 31 mph (50 km/h).



For "parallel" parking, the space must at a minimum be equal to the length of your vehicle plus 0.60 m.

For "bay" parking, the width of the space must be equal to the width of your vehicle plus 0.70 m.



If the parking sensors function has been deactivated in the **Driving/Vehicle** menu of the touch screen, it will be automatically reactivated when the system is activated.

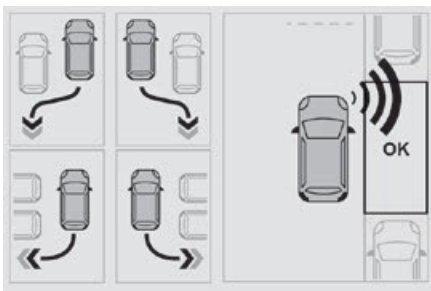

When the system finds an available space, "OK" is displayed on the parking view, accompanied by an audible signal.

### Preparing for the manoeuvre

► Move very slowly until the request to stop the vehicle is displayed: "**Stop the vehicle**", accompanied by the "**STOP**" sign and an audible signal.

Once the vehicle has stopped, an instructions page is displayed on the screen.

► To prepare for the manoeuvre, follow the instructions.

The start of the manoeuvre is indicated by the message "**Manoeuvre under way**", accompanied by an audible signal.

Reversing is indicated by this message:

"**Release the steering wheel, reverse**".

Visiopark 1 and the parking sensors are automatically activated to help you monitor

your vehicle's close surroundings during the manoeuvre.

### During the manoeuvre

The system controls the vehicle's steering. It gives instructions on the manoeuvring direction when starting "parallel" entry and exit parking manoeuvres, and for all "bay" entry manoeuvres. There instructions are displayed as a symbol accompanied by a message:



"Reverse".



"Go forwards".

The manoeuvring status is indicated by these symbols:



Manoeuvre in progress (green).



Manoeuvre cancelled or finished (red) (the arrows indicate that the driver must resume control of the vehicle).

The maximum speeds during manoeuvres are indicated by these symbols:



5 mph or 7 km/h, for parking space entry.



3 mph or 5 km/h, for parking space exit.

! During manoeuvring phases, the steering wheel performs rapid turns: do not hold the steering wheel or put your hands between the spokes of the steering wheel. Watch out for any objects that could interfere with the

manoeuvre (loose clothing, scarf, tie, etc.). Risk of injury!

It is the driver's responsibility to constantly monitor the traffic, especially vehicles coming towards you.

The driver should check that no objects or people are obstructing the vehicle's path.

**i** The images from the camera(s) displayed on the touch screen may be distorted by the terrain.

In shady areas, or in inadequate sunlight or lighting conditions, the image may be darkened and with lower contrast

The manoeuvre can be permanently interrupted at any time, either by the driver or automatically by the system.

Interruption by the driver:

- taking over control of the steering.
- activating the direction indicator lamps on the opposite side to that of the manoeuvre.
- unfastening the driver's seat belt.
- switching off the ignition.

Interruption by the system:

- vehicle exceeding the speed limit of 5 mph (7 km/h) during parking space entry manoeuvres, or 3 mph (5 km/h) during parking space exit manoeuvres.
- activation of anti-slip regulation on a slippery road.
- opening of a door or the boot.
- engine stall.

- system malfunction.
- after 10 manoeuvres to enter or exit a parallel parking space and after 7 manoeuvres to enter a parking bay.

Interrupting the manoeuvre automatically deactivates the function.

The manoeuvre symbol is displayed in red, accompanied by the **"Manoeuvre cancelled"** message on the touch screen.

A message prompts the driver to take back control of the vehicle.



The function is deactivated after a few seconds; this warning lamp goes off and the function returns to the initial display.

## End of the parking space entry or exit manoeuvre

The vehicle stops as soon as the manoeuvre is completed.

The manoeuvring symbol is displayed in red accompanied by the message **"Manoeuvre completed"** on the touch screen.



Deactivation of the function is confirmed by this indicator lamp going off, accompanied by an audible signal.

If entering a parking space, the driver may be required to complete the manoeuvre.

## Operating limits

- The system may suggest an inappropriate parking space (parking prohibited, work in progress with damaged road surface, location alongside a ditch, etc.).

- The system may indicate that a space has been found but will not offer it because of a fixed obstacle on the opposite side of the manoeuvre, which would not allow the vehicle to follow a trajectory required for parking.
- The system may indicate that a space has been found but the manoeuvre will not be triggered, because the width of the lane is insufficient.
- The system is not designed for performing the parking manoeuvre on a sharp bend.
- The system does not detect spaces that are much larger than the vehicle itself or that are delimited by obstacles that are too low (pavements, studs, etc.) or too thin (trees, posts, wire fences, etc.).
- If the boot is heavily loaded, the tilt of the vehicle towards the rear may interfere with the distance measurements.



Do not use the function under the following exterior conditions:

- Alongside a soft shoulder (e.g. ditch) or quay or on the edge of a drop.
- When the road surface is slippery (e.g. ice).



If any of the following malfunctions occurs, do not use the system:

- If a tyre is under-inflated.
- If one of the bumpers is damaged.
- If one of the cameras is faulty.



If the vehicle has undergone any of the following modifications, do not use the function:

- When carrying an object extending beyond the dimensions of the vehicle (ladder on the roof bars, bicycle carrier on the tailgate, etc.).
- With a non-approved towball in place.
- With snow chains fitted.
- When driving on a small-diameter or "space-saver" type spare wheel.
- When the wheels fitted are a different size from the original ones.
- After modifying one or both bumpers (added protection).
- If the sensors have been repainted other than by the PEUGEOT dealer network.
- With sensors not approved for the vehicle.

## Malfunctions



When the function is not activated, the temporary flashing of this indicator lamp and an audible signal indicate a system malfunction.

If the malfunction occurs while the system is in use, the indicator lamp goes off.



If the parking sensor malfunction occurs during use, indicated by one of these warning lamps coming on, it causes the function to deactivate.

In the event of a malfunction, have the system checked by a PEUGEOT dealer or a qualified workshop.



In the event of a power steering malfunction, this warning lamp is displayed on the instrument panel, accompanied by a warning message.

You must stop as soon as it is safe to do so. Contact a PEUGEOT dealer or a qualified workshop.

## Full Park Assist

Refer to the **General recommendations on the use of driving and manoeuvring aids**.

This system provides active parking assistance for vehicles fitted with the EAT8 automatic gearbox or a gear selector: it detects a free "parallel" or "bay" parking space and then operates the vehicle, parking it with no need for driver intervention. It also allows you to drive out of a "parallel parking" space automatically. The system controls the steering, direction, acceleration and braking. The system measures the available parking spaces and calculates the distances to obstacles using 12 ultrasonic sensors built into the front and rear bumpers of the vehicle.

To help the driver monitor the successful completion of the manoeuvre, the system automatically displays the Visiopark 1 and activates the parking sensors.

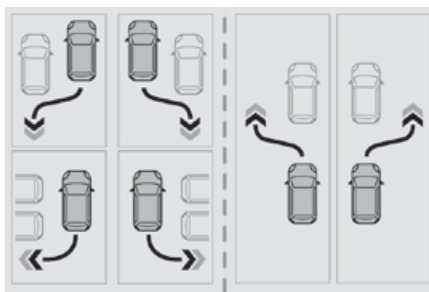

**To initiate parking assistance when approaching a parking area:**

- ▶ Reduce the speed of the vehicle to a maximum of 19 mph (30 km/h).

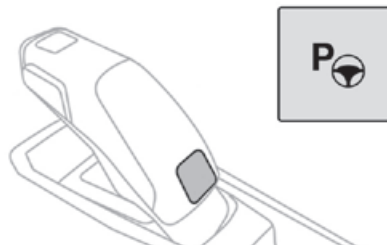

- ▶ Press the button on the gear selector or, on the touch screen, select **Driving / Vehicle > Full Park Assist**.



Activating the system deactivates Blind Spot Monitoring System.

### Sequence

Once the system is activated, the following steps will be performed successively:

- Select the type of manoeuvre via the touch screen.
- Search for an available space.
- Prepare for the manoeuvre.
- Perform the manoeuvre.
- Finalise the manoeuvre.



It is possible to deactivate the system at any time until the start of the manoeuvre, by pressing the red arrow in the upper left corner of the screen.



Full Park Assist is not always able to react automatically and appropriately due to the performance limits inherent to the system.

The manoeuvre remains the responsibility of the driver, who must not leave the driving position and must never try to lock the system control button.

The driver's seat belt must remain fastened during the manoeuvre.

## Choice of the type of manoeuvre and search for space

Depending on whether the vehicle has been driven or not since the ignition was switched on,

the function proposes the entry to or exit from a parking space on the touch screen.

- ▶ Select the type and side of the manoeuvre to activate the parking space search.

 Illumination of this lamp confirms activation.

It is possible to change the type of manoeuvre at any time, including during the available space search phase.

- ▶ Drive at a distance of 0.50 to 1.50 m from the row of parked vehicles, not exceeding 19 mph (30 km/h), until the system finds an available space (indicated by **OK** on the display and an audible signal).

- i** For "parallel" parking, the space must at least equal to the length of your vehicle plus 1 m.
- For "bay" parking, the space must at least equal to the width of your vehicle plus 0.70 m.

## Preparing for the manoeuvre

- ▶ Move very slowly until the request to stop the vehicle and the **"STOP"** sign are displayed, accompanied by an audible signal.
- Once the vehicle has stopped, an instructions page is displayed on the screen.
- ▶ To prepare for the manoeuvre, you must fulfil all of these instructions.

 This symbol will be displayed automatically when the instruction has been applied.

When all instructions have been validated, a new screen is displayed, indicating that you can undertake the manoeuvre.

 ▶ To undertake the manoeuvre, press this button.

- ▶ While holding down the button, gradually release the brake pedal.

**!** The button must be held down throughout the manoeuvre.

The start of the manoeuvre is indicated by the display of a screen with the message **"Manoeuvre under way"**, accompanied by an audible signal.

Visiopark 1 and the parking sensors are automatically activated to help you monitor the immediate area around your vehicle during the manoeuvre.

## Performing the manoeuvre

As soon as the driver releases the brake pedal, the system automatically takes control of choosing the travel direction, forwards or reverse, acceleration, braking and the steering direction.

The manoeuvring status is indicated by these symbols:

 Manoeuvre in progress.

 Manoeuvre interrupted.

 Manoeuvre completed or abandoned (white arrows indicate that the driver must take back control of their vehicle).

The direction of the manoeuvre is indicated by these symbols:

 Forward gear.

 Reverse gear.

The central arrow is green whilst the vehicle is moving, or white to indicate the next manoeuvring direction.

**!** Throughout the whole manoeuvre, indicated by the green **"AUTO"** symbol, the driver must hold the selector button down.

**!** During manoeuvring phases, the steering wheel performs rapid turns: do not hold the steering wheel or put your hands between the spokes of the steering wheel. Watch out for any objects that could interfere with the manoeuvre (loose clothing, scarf, tie, etc.). Risk of injury!

**i** If the vehicle slows down significantly, the brake lamps may come on.

## Pausing/resuming the manoeuvre

The manoeuvre can be interrupted temporarily at any time, either automatically by the system if



an obstacle is detected, or by driver action. If the driver notices a hazard, they may also interrupt the manoeuvre permanently.

To suspend the manoeuvre, the driver can:

- Release the function control button.
- Depress the brake pedal.
- Resume control of the steering.
- Change the gearbox status (except changing to **P**).

The vehicle is immediately immobilised if the manoeuvre is suspended.



This is confirmed by the display of this symbol, accompanied by the message "**Manoeuvre suspended**".

#### Resuming the manoeuvre after resolving the conditions for suspending it:

- ▶ Release all controls (brake pedal, function control button, steering wheel, etc.).
- ▶ Press the function control button again.

#### Permanent interruption after suspending the manoeuvre:

- ▶ Depress the brake pedal and engage a gear.

#### Abandoning the manoeuvre

The manoeuvre is abandoned in the following situations:

- No action by the driver within 30 seconds of the manoeuvre being suspended.
- Intentional application of the parking brake.
- Gearbox mode **P** engaged by the driver.
- Driver's seat belt unfastened.
- Opening of a door or the boot.

– Activation of the direction indicator lamps on the opposite side to that of the manoeuvre.

- In certain cases, when a wheel of the vehicle hits a pavement or a low obstacle.
  - Triggering of anti-slip regulation on a slippery road.
  - Engine stalling.
  - Sudden appearance in the field of the manoeuvre of an obstacle not detected by the system before the manoeuvre was started, with the obstacle remaining for more than 30 seconds.
  - After 10 manoeuvres to enter or exit a "parallel" parking space and after 7 manoeuvres to enter a "bay" parking space,
  - System malfunction during the manoeuvre.
- Abandoning the manoeuvre immediately triggers the vehicle's brakes and automatically deactivates the function.



This symbol is displayed, accompanied by the message "**Manoeuvre abandoned**" on the touch screen.

A message prompts the driver to take back control of the vehicle.



The function is deactivated after a few seconds; this indicator lamp goes off on the instrument panel and the initial display is resumed.

The system automatically engages gearbox mode **P** after 4 seconds.

## End of manoeuvre

The vehicle stops as soon as the manoeuvre is completed.



This symbol is displayed, accompanied by the message "**Manoeuvre completed**" on the touch screen.



When the function is deactivated, this indicator lamp on the instrument panel goes off and the original display is restored.

- If entering a parking space, the driver may be required to complete the manoeuvre. The gearbox changes to **P** 4 seconds after completion of the manoeuvre.
- When exiting a parking space, the gearbox changes to **N** when the manoeuvre is complete. A message and symbols prompt the driver to take back control of the vehicle. The gearbox automatically changes to mode **P** if no action is taken by the driver within 30 seconds.

## Operating limits

- The system may suggest an inappropriate parking space (parking prohibited, work in progress with damaged road surface, location alongside a ditch, etc.).
- The system may indicate that a space has been found but will not offer it because of a fixed obstacle on the opposite side of the manoeuvre, which does not allow the vehicle to follow the trajectory required for parking.

- The system may indicate that a space has been found but the manoeuvre will not be triggered because the width of the lane is insufficient.
- The system is not designed to perform parking manoeuvres on a steep slope or on a sharp curve.
- The system does not detect spaces that are much larger than the vehicle itself or that are delimited by obstacles that are too low (pavements, studs, etc.) or too thin (trees, posts, wire fences, etc.).
- The system may be impaired by incorrect inflation of the vehicle's tyres.
- The tilting of the vehicle if the boot is heavily loaded can affect the distance measurements.

 Do not use the function under the following exterior conditions:

- Alongside a soft shoulder (ditch) or quay or on the edge of a drop.
- When the road surface is slippery (ice).

 Do not use the function in the presence of one of the following malfunctions:

- If a tyre is under-inflated.
- If one of the bumpers is damaged.
- If one of the cameras is faulty.
- If the brake lamps are not working.



 Do not use the function if the vehicle has been subject to one of the following modifications:

- When carrying an object extending beyond the dimensions of the vehicle (ladder on the roof bars, bicycle carrier on the tailgate, etc.).
- With a non-approved towball in place.
- With snow chains fitted.
- When driving on a small-diameter or "space-saver" type spare wheel.
- When the wheels fitted are a different size from the original ones.
- After modifying one or both bumpers (added protection).
- If the sensors have been repainted outside the PEUGEOT dealer network.
- With sensors not approved for the vehicle.

## Malfunctions

 When the function is not activated, the temporary flashing of this warning lamp and an audible signal indicate a Full Park Assist malfunction.

If the malfunction occurs while the system is in use, the warning lamp goes off.

  If a parking sensor malfunction, indicated by one of these warning lamps coming on, occurs during Full Park Assist use, the function is deactivated.

Contact a PEUGEOT dealer or a qualified workshop.



In the event of a power steering malfunction, this warning lamp is displayed on the instrument panel, accompanied by a message.

You must stop as soon as it is safe to do so. Contact a PEUGEOT dealer or a qualified workshop.



## PEUGEOT & TOTAL PARTNERS IN PERFORMANCE!

For over 20 years, the PEUGEOT TOTAL partnership has set new performance standards in achieving success in the toughest conditions, with victories in the Le Mans 24 Hours, the World Rally Championship and the Dakar Rally. To obtain these exceptional results, the Peugeot Sport teams chose TOTAL QUARTZ, a high-tech lubricant that protects the engine in the most extreme conditions.

**TOTAL QUARTZ protects your engine against the effects of time.**

TOTAL QUARTZ INEO FIRST is a very high-performance lubricant developed jointly by the Peugeot and Total R&D teams. Specially formulated for the engines in Peugeot vehicles, its innovative technology significantly reduces CO<sub>2</sub> emissions and keeps your engine clean.



PEUGEOT RECOMMENDS TOTAL



PEUGEOT



TOTAL

OFFICIAL PARTNERS

## Compatibility of fuels



Petrol fuels conforming to the EN228 standard containing up to 5% and 10% ethanol respectively.



Diesel fuels conforming to the EN590, EN16734 and EN16709 standards and containing up to 7%, 10%, 20% and 30% fatty acid methyl ester respectively. The use of B20 or B30 fuels, even occasionally, imposes special maintenance conditions referred to as "Arduous conditions".



Paraffinic Diesel fuel conforming to the EN15940 standard.

**!** The use of any other type of (bio) fuel (vegetable or animal oils, pure or diluted, domestic fuel, etc.) is strictly prohibited (risk of damage to the engine and fuel system).

**i** The only fuel additives authorised for use are those that meet the B715001 (petrol) or B715000 (Diesel) standards.

### Diesel at low temperature

At temperatures below 0 °C (+32 °F), the formation of paraffins in summer-type Diesel

fuels could prevent the engine from operating correctly. In these temperature conditions, use winter-type Diesel fuel and keep the fuel tank more than 50 % full.

At temperatures below -15 °C (+5 °F) to avoid problems starting, it is best to park the vehicle under shelter (heated garage).

### Travelling abroad

**Certain fuels could damage your vehicle's engine.**

**In certain countries, the use of a particular fuel may be required (specific octane rating, specific trade name, etc.) to ensure correct operation of the engine.**

For all additional information, consult a dealer.

### Refuelling

**Fuel tank capacity: approximately 44 litres (Petrol) or 41 litres (Diesel).**

**Reserve level: approximately 5 litres.**

### Low fuel level



When the low fuel level is reached, this warning lamp comes on on the instrument panel, accompanied by an onscreen message and an audible signal. When it first comes on, **about 5 litres** of fuel remain.

Until sufficient fuel is added, this warning lamp appears every time the ignition is switched on, accompanied by an onscreen message and an audible signal. When driving, this message

and audible signal are repeated with increasing frequency as the fuel level drops towards **0**.

You must refuel as soon as possible to avoid running out of fuel.

For more information on **Running out of fuel (Diesel)**, refer to the corresponding section.

#### **! Stop & Start**

Never refuel with the engine in STOP mode; you must switch off the ignition.

### Refuelling

When refuelling, at least 5 litres must be added in order to be registered by the fuel gauge.

Opening the filler cap may create a noise caused by an inrush of air. This vacuum is entirely normal, resulting from the sealing of the fuel system.

To refuel in complete safety:

► **Always switch off the engine.**

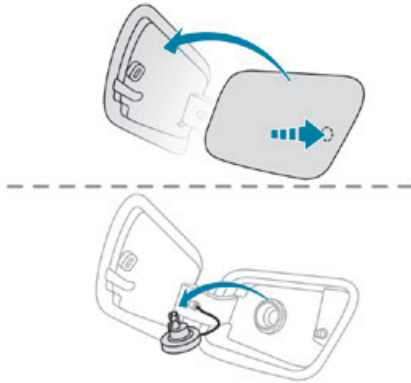

- ▶ With the vehicle unlocked, press the rear-central part of the filler flap to open it.
- ▶ Take care to select a pump that delivers the correct fuel type for the vehicle's engine (see a reminder label on the inside of the filler flap).
- ▶ Turn the filler cap to the left.
- ▶ Remove the filler cap and hang it on its carrier (on the filler flap).
- ▶ Introduce the filler nozzle and push it in as far as possible before starting to refuel (to minimise the risk of splashing).
- ▶ Fill the tank.

**Do not continue after the nozzle's third cut-out. Doing so may cause malfunctions.**

- ▶ Refit the filler cap.
- ▶ Turn it to the right.
- ▶ Push the fuel filler flap to close it.

**!** If you have put in the wrong fuel for the vehicle, you must have the fuel tank drained and filled with the correct fuel before starting the engine.

The vehicle is fitted with a catalytic converter, which helps to reduce the level of harmful emissions in the exhaust gases.

**For petrol engines, you must use unleaded fuel.**

The filler neck is narrower, admitting unleaded petrol nozzles only.

## Misfuel prevention (Diesel)

(Depending on country of sale.)

This mechanical device prevents filling the tank of a Diesel vehicle with petrol.

Located in the filler neck, the misfuel prevention device appears when the filler cap is removed.

### Operation

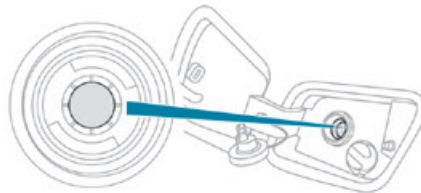

When a petrol filler nozzle is inserted into the fuel filler neck of a Diesel vehicle, it comes into contact with the flap. The system remains closed and prevents filling.

**Do not persist but introduce a Diesel type filler nozzle.**

**i** It remains possible to use a fuel jerrycan to fill the tank.

### **i** Travelling abroad

As Diesel fuel pump nozzles may be different in other countries, the presence of the misfuel prevention device may make refuelling impossible.

Before travelling abroad, it is advisable to check with a PEUGEOT dealer if the vehicle is suitable for the distribution equipment of the countries visited.

## Charging system (Electric)

### 400 V electrical system

The electrical traction system, which operates at a voltage of approximately 400 V, is identified by orange cables, and its components are marked with this symbol:

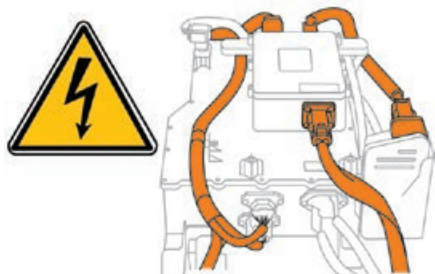

**!** An electric vehicle's power train can become hot during use and after switching off the ignition.

Observe the warning messages shown on labels, particularly inside the flap. All work on or modifications to the vehicle's electrical system (including the traction battery, connectors, orange cables and other components visible from the interior or exterior) is strictly prohibited - risk of severe burns or potentially fatal electric shock (short-circuit/electrocution)! In the event of a problem, always contact a PEUGEOT dealer or a qualified workshop.

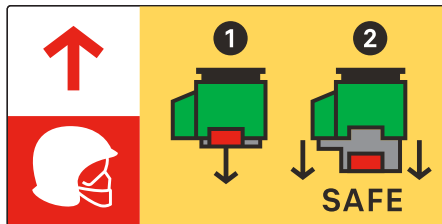

**!** This label is intended solely for use by firefighters and maintenance services in the event of any work on the vehicle. No other person must touch the device shown on this label.

**!** **In the event of an accident or impact**  
The electrical system or the traction battery may be seriously damaged in the event of an accident or impact involving the vehicle underbody. Stop as soon as it is safe to do so and switch off the ignition. Contact a PEUGEOT dealer or a qualified workshop without delay.

**!** **In the event of exposure to a fire**  
Immediately exit and evacuate all passengers from the vehicle. Never attempt to fight the fire yourself - risk of electrocution! You must immediately contact the emergency services, informing them that the incident involves an electric vehicle.

**!** **When washing**  
Before washing the vehicle, always check that the charging flap is closed correctly. Never wash the vehicle while the battery is on charge.

**!** **High-pressure washing**  
To avoid damaging electrical components, it is expressly prohibited to use high-pressure washing to clean the front compartment or the vehicle underbody. Do not use a pressure greater than 80 bar when washing the bodywork.

**!** Never allow water or dust to enter the connector or charging nozzle - risk of electrocution or fire!  
Never connect / disconnect the charging nozzle or cable with wet hands - risk of electrocution!

## Traction battery

This battery stores the energy that powers the electric motor and the thermal comfort equipment in the passenger compartment. It is discharged during use, and must therefore be regularly recharged. There is no need to wait for the traction battery to fall to its reserve level before recharging.

Battery life may vary according to the type of driving, the route, thermal comfort equipment usage and battery component ageing.

**i** The traction battery ageing process is influenced by multiple factors, including climate conditions, the distance travelled and how often it has been fast-charged.

### **!** In the event of damage to the traction battery

It is strictly prohibited to work on the vehicle yourself.

Do not touch liquids coming from the battery, and in the event of skin contact with these products, wash abundantly with water and contact a doctor as soon as possible.

Contact a PEUGEOT dealer or a qualified workshop to have the system checked.

## Charging connectors and indicator lamps

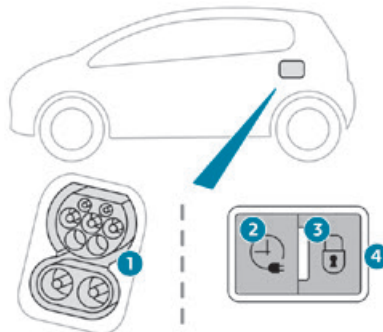

1. Charging connectors
2. Deferred charge activation button
3. Nozzle locking indicator lamp  
Red: nozzle positioned correctly and locked in the connector.
4. Charging indicator lamp



State of charging indicator lamp	Meaning
Fixed white	Welcome lighting when flap is opened.
Fixed blue	Deferred charge.
Flashing green	Charging.
Fixed green	Charging finished.
Fixed red	Malfunction.

**!** In case of impact, even light, against the charging flap, do not use it.  
Do not remove or modify the charging connector - risk of fire!  
Contact a PEUGEOT dealer or a qualified workshop.

## Charging cables

The charging cable supplied with the vehicle is suitable for electrical systems in the country of sale. If you travel abroad, refer to the following table to check your charging cable's compatibility with local electrical systems.

Contact a PEUGEOT dealer or a qualified workshop for more information and to obtain suitable charging cables.



### Domestic socket

(Domestic charging - single-phase alternating current (AC))



Mode 2 with a standard socket **A**: 8 A maximum charging current.

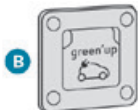

Mode 2 with a Green'Up socket **B**: 16 A maximum charging current.

### Mode 2 (AC) charging cable with built-in control unit

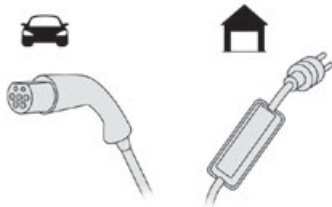

### ! Mode 2 charging cable with built-in control unit

Avoiding damage to the cable is essential.

In the event of damage, do not use the cable and contact a PEUGEOT dealer or a qualified workshop for a replacement.

### Accelerated charging unit (Wallbox)

(Accelerated charging - single-phase or three-phase alternating current (AC))



Depending on version, in mode 3 with a Wallbox accelerated charging unit: 32 A maximum charging current.

### Mode 3 (AC) charging cable

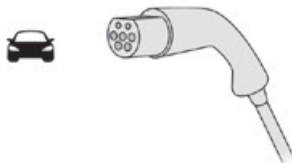

### ! Accelerated charging unit (Wallbox)

Do not remove or modify the charging unit. Risk of electrocution and/or fire! Refer to the charging unit user manual for operating instructions.

### Public fast charging station

(Fast charging - direct current (DC))



### Mode 4 (DC) charging cable

(integrated in the public fast charging station)

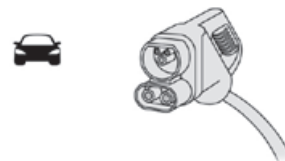



## Control unit

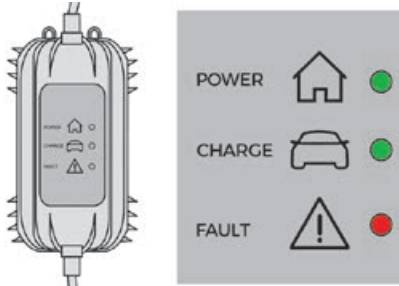

### POWER

Green: electrical connection established; charging can begin.

### CHARGE

Flashing green: charging in progress or temperature pre-conditioning activated.  
Fixed green: charging complete.

### FAULT

Red: anomaly; charging not permitted or must be stopped immediately. Check that everything is connected correctly and that the electrical system is not faulty.  
If the indicator lamp does not go off, contact a PEUGEOT dealer or a qualified workshop.  
Upon plugging the charging cable into a domestic socket, all of the indicator lamps come on briefly.  
If no indicator lamps come on, check the domestic socket's circuit-breaker.

- If the circuit breaker has tripped, contact a professional to check that your electrical system is suitable and carry out any necessary repairs.
- If the circuit-breaker has not tripped, avoid using the charging cable and contact a PEUGEOT dealer or a qualified workshop.

### Recommendations on the control unit label

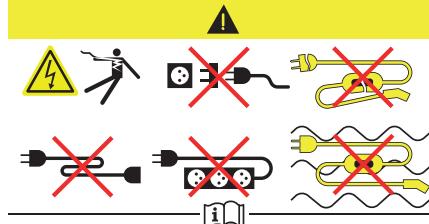

1. Refer to the handbook before use.
2. Incorrect use of this charging cable may result in fire, property damage and serious injury or death by electrocution!
3. Always use a correctly earthed power socket, protected by a 30 mA residual current device.
4. Always use an electrical socket protected by a circuit-breaker appropriate for the electrical circuit's current rating.
5. The weight of the control unit must not be borne by the electrical socket, plug and cables.
6. Never use this charging cable if it is defective or in any way damaged.

7. Never attempt to repair or open this charging cable. It contains no repairable parts - replace the charging cable if it is damaged.
8. Never immerse this charging cable in water.
9. Never use this charging cable with an extension cable, a multi-plug socket, a conversion adaptor or on a damaged electrical socket.
10. Do not unplug the plug from the wall as a means of stopping charging.
11. Do not force the connector if it is locked into the vehicle.
12. Immediately stop charging, by locking and then unlocking the vehicle using the remote control key, if the charging cable or wall socket feel burning hot to the touch.
13. This charging cable includes components liable to cause electrical arcing or sparks. Do not expose to flammable vapours.
14. Only use this charging cable with PEUGEOT vehicles.
15. Never plug the cable into the wall socket (or unplug it) with wet hands.

## Charging the traction battery (Electric)

To recharge, connect the vehicle to a domestic electrical system (for domestic or accelerated charging) or a fast public charging station (for fast charging).

For a full charge, follow the desired charging procedure without pausing it, until it ends automatically. Charging may be performed either immediately or deferred.

You can stop charging at any time by unlocking the vehicle and removing the nozzle.

For more information on the charging displays on the **Instrument panel** and the **Touch screen**, refer to the corresponding section.



Depending on version, the deferred charge function is configured via either the touch screen or the **MyPeugeot** application. For more information on the **Deferred charging** function, refer to the corresponding section.

It is also possible to monitor the charging progress using the **MyPeugeot** application.

For more information on **Remotely operable features**, refer to the corresponding section.

As a safety measure, the engine will not start if the charging cable is plugged into the connector on the vehicle. A warning is displayed on the instrument panel.

### Cooling the traction battery

The cooling fan comes on during charging to cool the on-board charger and the traction battery.

### Vehicle not used for an extended period

Fully recharge the traction battery every three months. Follow the domestic charging procedure.

Before carrying out this charging operation, check that the accessory battery is not disconnected or discharged. If it is, refer to the corresponding section for information on reconnecting or recharging it.

## Precautions

Electric vehicles were developed in accordance with the guidelines on maximum electromagnetic fields issued by the International Commission on Non-Ionizing Radiation Protection (ICNIRP - 1998 Guidelines).



Wearers of pacemakers or equivalent devices should consult a doctor to enquire about any applicable precautionary measures, or contact the manufacturer of their implanted electronic medical device to check that it is guaranteed to operate in an environment compliant with the ICNIRP guidelines.

### If in doubt

**Domestic or accelerated charging:** do not remain inside or near the vehicle, or near the charging cable or charging unit, even for a short time.

**Fast charging:** do not use the system yourself and avoid approaching public fast

charging points. Leave the area and ask a third party to recharge the vehicle.

## For domestic or accelerated charging

### Before charging

Depending on the context:

- ▶ Have a professional check that the electrical system to be used complies with applicable standards and is compatible with the vehicle.
- ▶ Have a professional electrician install a dedicated domestic power socket or accelerated charging unit (Wallbox) compatible with the vehicle. Use the charging cable supplied with the vehicle.

### (During charging)

- Never work under the bonnet:
  - Some areas remain very hot, even an hour after charging ends - risk of burns!
  - The fan may start at any time - risk of cuts or strangulation!

### After charging

Check that the charging flap is closed. Do not leave the cable connected to the domestic power socket - risk of short-circuit or electrocution in the event of contact with or immersion in water!

## For fast charging

### Before charging

Check that the fast public charging station and its charging cable are compatible with the vehicle.

If the exterior temperature is below:

- 0°C, charging times may be extended.
- -20°C, charging is still possible, but charging times may be extended even further (the battery has to be heated first).

### ! (During charging)

Do not remain in or near the vehicle. While charging is in progress, opening the driver's door will interrupt charging.

### ! After charging

Check that the charging flap is closed.

## Connection

- ▶ Before charging, check that the drive selector is in mode **P** and the ignition is off, otherwise charging is not possible.
- ▶ Open the charging flap by pressing the push-button, and check that there are no foreign bodies on the charging connector.

### Domestic charging (mode 2)

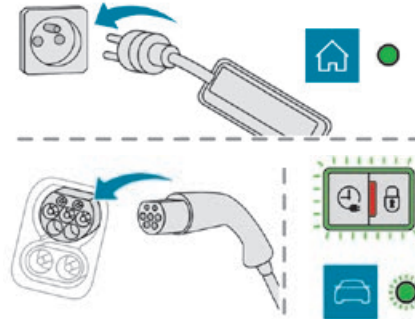

- ▶ Connect the charging cable from the control unit to the domestic socket.

When the connection is made, all of the indicator lamps on the control unit light up, then only the **POWER** indicator lamp remains on in green.

- ▶ Remove the protective cover on the charging nozzle.

▶ Insert the nozzle into the charging connector. The start of charging is confirmed by the flashing in green of the **CHARGE** indicator lamps in the flap, then on the control unit.

If this is not the case, charging has not started; restart the procedure, ensuring that all connections are properly established. The red indicator lamp in the flap comes on to indicate that the nozzle is locked.

**i** If charging has finished but the cable is still connected, opening the driver's door restarts charging for around 20 seconds.

### Accelerated charging (mode 3)



- ▶ Follow the instructions for use of the accelerated charging unit (Wallbox).
- ▶ Remove the protective cover on the charging nozzle.
- ▶ Insert the nozzle into the charging connector. The start of charging is confirmed by the flashing in green of the charging indicator lamp in the flap.

If this is not the case, charging has not started; restart the procedure, ensuring that the connection is correct.

The red indicator lamp in the flap comes on to indicate that the nozzle is locked.

### Fast charging (mode 4)



► Depending on version, remove the protective cover from the lower section.

► Connect the charging cable to the vehicle connector, following the instructions for use of the fast public charging station.

The start of charging is confirmed by the flashing in green of the charging indicator lamp in the flap.

If this is not the case, charging has not started; restart the procedure, ensuring that the connection is correct.

The red indicator lamp in the flap comes on to indicate that the nozzle is locked.

## Disconnection



Before disconnecting the nozzle from the charging connector:

► If the vehicle is unlocked, **lock it and then unlock it**.

► If the vehicle is locked, unlock it.

The red indicator lamp in the flap goes out to confirm that the charging nozzle is unlocked.

► Within **30 seconds**, remove the charging nozzle.

## Domestic charging (mode 2)

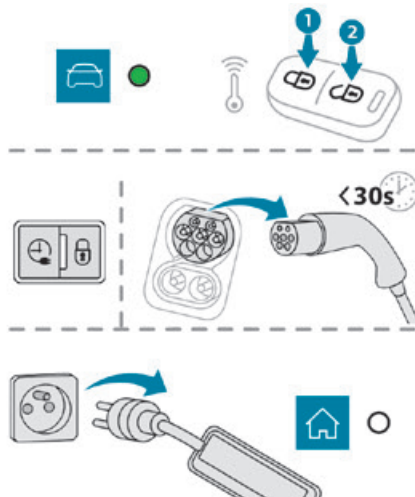

When charging is complete, the green **CHARGE** indicator lamp on the control unit comes on fixed.

► Replace the protective cover on the charging nozzle and close the charging flap.

► Disconnect the control unit end of the charging cable from the domestic socket.

## Accelerated charging (mode 3)

The end of charging is indicated by the charging control unit and by the fixed lighting of the green indicator lamp in the flap.

► Hang up the nozzle on the charging unit and close the charging flap.

## Fast charging (mode 4)

The end of charging is indicated by the charger and by the fixed lighting of the green indicator lamp in the flap.

► Hang up the nozzle on the charging station.

► Depending on version, replace the protective cover on the lower section and close the charging flap.

## Towing device

### Load distribution

► Distribute the load in the trailer so that the heaviest items are as close as possible to the axle, and the nose weight approaches the maximum permitted without exceeding it. Air density decreases with altitude, thus reducing engine performance. The maximum towable load must be reduced by 10% per 1,000 metres of altitude.

**i** Use genuine towing devices and their wiring harnesses approved by PEUGEOT. We recommend having them fitted by a PEUGEOT dealer or a qualified workshop. If not fitted by a PEUGEOT dealer, they must still be fitted in accordance with the vehicle manufacturer's instructions. Certain driving or manoeuvring aid functions are automatically deactivated while an approved towing system is in use.

**!** Comply with the maximum authorised towable weight, as indicated on your vehicle's registration certificate, on the manufacturer's label and in the **Technical data** section of this guide.

**Complying with the maximum authorised nose weight (towball weight) also includes the use of accessories (bicycle carriers, tow boxes, etc.).**

**!** Observe the legislation in force in the country where you are driving.

**i Electric motor**  
Electric vehicles must never be equipped with towing devices. It is therefore not possible to tow a trailer or caravan.

## Towing device with quickly detachable towball

### Presentation

This genuine towing device can be fitted and removed with no need for tools.

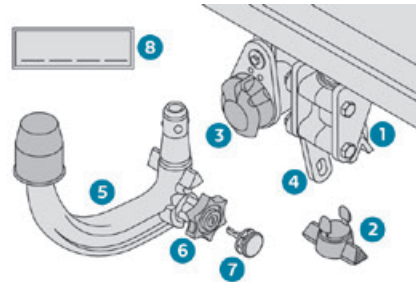

1. Carrier
2. Protective plug
3. Connection socket
4. Safety eye
5. Detachable towball
6. Locking/unlocking wheel
7. Security key lock
8. Label to note the key references

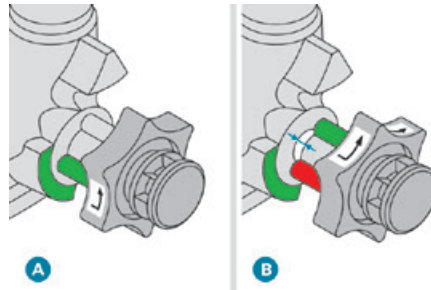

- A. Locked position** (the **green** marks are opposite each other); the wheel is in contact with the towball (no gap).
- B. Unlocked position** (**red** mark opposite the **green** mark); the wheel is no longer in contact with the towball (gap of around 5 mm).

**!** Trailers with LED lamps are not compatible with the wiring harness of this device.

**i** To ensure complete safety while driving with a **Towing device**, refer to the corresponding section.

**!** **Before each use**  
Verify that the towball is correctly fitted, checking the following points:

- the green mark on the wheel is aligned with the green mark on the towball,
- the wheel is in contact with the towball (position **A**),
- the security key lock is closed and the key removed; the wheel can no longer be operated,
- the towball must not be able to move in its carrier; test by attempting to shake it with your hand.

If the towball is not locked, the trailer can become detached - risk of an accident!

**! During use**

Never release the locking system with a trailer or load carrier on the towball.  
 Never exceed the maximum authorised weight for the vehicle - the Gross Train Weight or GTW.  
 Always comply with the maximum authorised load on the towing device: if it is exceeded, this device may become detached from the vehicle - risk of an accident!  
 Before driving, check the headlamp height adjustment and check that the lamps on the trailer operate correctly.  
 For more information on **Headlamp height adjustment**, refer to the corresponding section.

**! After use**

When travelling without a trailer or load carrier, remove the towball and fit the protective plug 2 from the carrier 1, to provide clear visibility of the number plate and/or its lighting.

## Fitting the towball

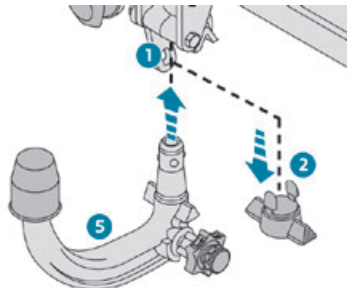

- ▶ Below the rear bumper, remove the protective plug 2 from the carrier 1.
- ▶ Insert the end of the towball 5 into the carrier 1 and push it upwards; it will lock into position automatically.

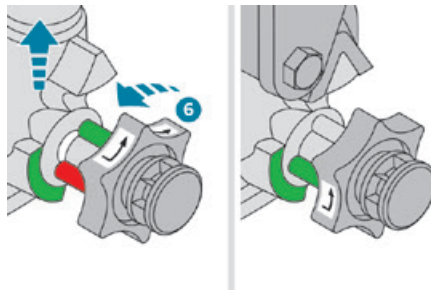

- ▶ The wheel 6 rotates a quarter turn anti-clockwise; take care to keep your hands clear!

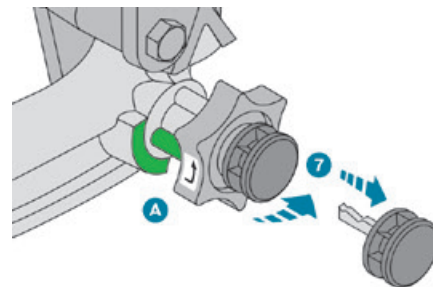

- ▶ Check that the mechanism has correctly locked into place (position A).
- ▶ Close the lock 7 using the key.
- ▶ Remove the key. The key cannot be removed while the lock is open.
- ▶ Clip the cap onto the lock.

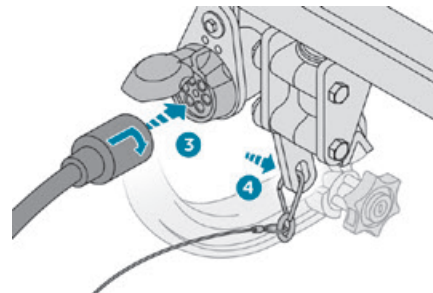

- ▶ Remove the protective cover from the towball.
- ▶ Attach the trailer to the towball.
- ▶ Attach the cable on the trailer to the safety eye 4 on the carrier.

- ▶ Insert the trailer plug and rotate it by a quarter turn to connect it to the connection socket **3** on the carrier.

## Removing the towball

- ▶ Grasp the trailer plug, perform a quarter turn and pull to disconnect it from the connection socket **3** on the carrier.
- ▶ Detach the cable on the trailer from the safety eye **4** on the carrier.
- ▶ Detach the trailer from the towball.
- ▶ Refit the protective cover to the towball.
- ▶ Remove the cap from the lock and press it onto the head of the key.

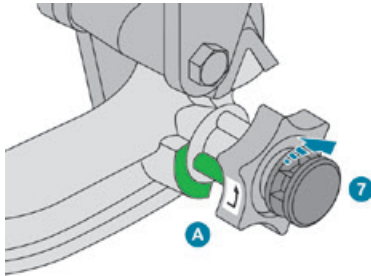

- ▶ Insert the key into the lock **7**.
- ▶ Open the lock using the key.

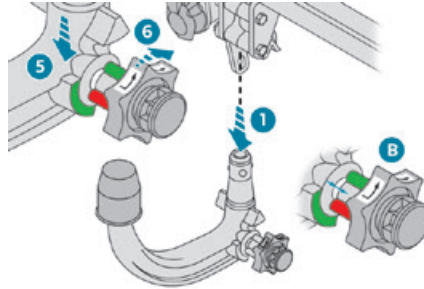

- ▶ Hold the towball **5** firmly in one hand; using the other hand, pull and turn the wheel **6** fully in a clockwise direction; do not release the wheel.
- ▶ Extract the towball from the bottom of its carrier **1**.
- ▶ Release the wheel; it automatically stops in the unlocked position (position **B**).

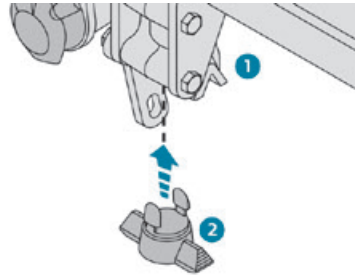

- ▶ Refit the protective plug **2** to the carrier **1**.
- ▶ Stow the towball in its bag away from knocks and dirt.

## Maintenance

Correct operation is only possible if the towball and its carrier are kept clean.

Before cleaning the vehicle with a high-pressure jet wash, the towball must be removed and the protective plug fitted to the carrier.

**i** Affix the enclosed label in a clearly visible location, close to the carrier or in the boot.

Contact a PEUGEOT dealer or a qualified workshop for any work on the towball system.

## Roof bars

**!** As a safety measure and to avoid damaging the roof, it is essential to use the transverse bars approved for the vehicle. Observe the instructions on fitting and use contained in the guide supplied with the roof bars.

**!** Maximum load distributed over the roof bars, for a loading height not exceeding 40 cm: **70 kg**.

As this value may change, please verify the maximum load quoted in the guide supplied with the roof bars.

If the height exceeds 40 cm, adapt the speed of the vehicle to the profile of the road to avoid damaging the roof bars and the fixings on the vehicle.



Be sure to refer to national legislation in order to comply with the regulations for transporting objects that are longer than the vehicle.

### ! Recommendations

Distribute the load uniformly, taking care to avoid overloading one of the sides. Arrange the heaviest part of the load as close as possible to the roof. Secure the load securely. Drive gently: the vehicle will be more susceptible to the effects of side winds and its stability may be affected. Regularly check the security and tight fastening of the roof bars, at least before each trip. Remove the roof bars once they are no longer needed.

### ! Sunroof

Check that the load does not pass below the roof bars so that it does not impede the movements of the sunroof - risk of major damage!

## Fitting on longitudinal bars



The transverse bars must be fixed at the engraved markings on the longitudinal bars.

## Fitting directly to the roof

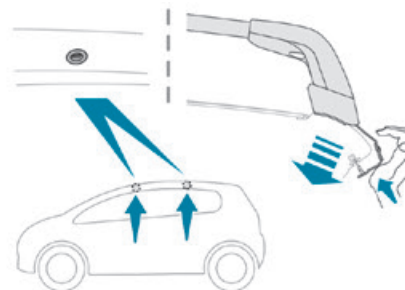

You must only attach the transverse bars to the four fixing points located on the roof frame. These points are concealed by the vehicle doors when the doors are closed. The roof bar fixings have a stud which must be inserted into the opening of each fixing point.

## Snow chains

In wintry conditions, snow chains improve traction as well as the behaviour of the vehicle when braking.

! The snow chains must be fitted only to the front wheels. They must never be fitted to "space-saver" type spare wheels.

i Take account of the legislation specific to each country on the use of snow chains and the maximum authorised speed.

Use only chains designed to be fitted to the type of wheel fitted to the vehicle:

Original tyre size	Maximum link size
215/65R16	9 mm (Polaire XP9)
215/60R17	9 mm (Polaire XP9)
215/55R18	10 mm (Polaire 0112)

For more information on snow chains, contact a PEUGEOT dealer or a qualified workshop.

## Installation tips

- ▶ To fit the chains during a journey, stop the vehicle on a flat surface at the side of the road.
- ▶ Apply the parking brake and position any wheel chocks under the wheels to prevent movement of the vehicle.



- ▶ Fit the chains following the instructions provided by the manufacturer.
- ▶ Move off gently and drive for a few moments, without exceeding 31 mph (50 km/h).
- ▶ Stop the vehicle and check that the snow chains are correctly tightened.

**i** It is strongly recommended that before setting off, you practise fitting the snow chains on a level and dry surface.

**!** Avoid driving with snow chains on roads that have been cleared of snow to avoid damaging the vehicle's tyres and the road surface. If the vehicle is fitted with alloy wheels, check that no part of the chain or its fixings is in contact with the wheel rim.

## Very cold climate screen

(Depending on country of sale.)

This removable protective screen prevents the accumulation of snow at the radiator cooling fan. It consists of a first element for the upper part of the front grille and a second element for the lower part.

**i** For fitting / removing, it is recommended that you contact a PEUGEOT dealer or a qualified workshop.

**!** Before any operation, ensure that the engine is off and the cooling fan has stopped.

**!** It is essential to remove them when:

- the exterior temperature exceeds 10°C.
- towing.
- the speed is above 75 mph (120 km/h).

## Fitting

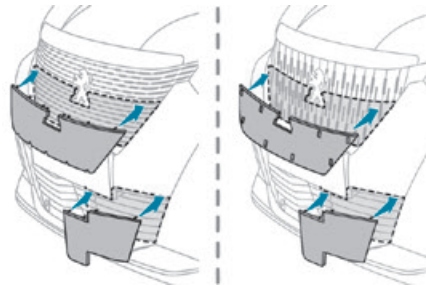

- ▶ Hold the side screen in front of the lower left grille of the bumper.
- ▶ First insert the lower fixing brackets into the bumper.
- ▶ Tilt the side screen upwards until the side and then upper fixing brackets click into the bumper.
- ▶ Check that the unit is firmly held by pressing around the edges.

Repeat the same process to fit the central screen into the upper grille of the bumper.

## Removing

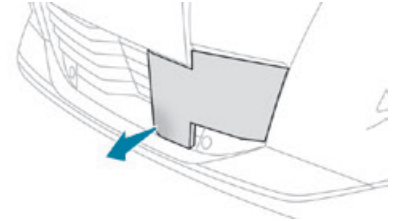

### For the side screen

- ▶ Insert a finger into the notch in the lower part of the side screen.
- ▶ Pull towards you to unclip the unit.

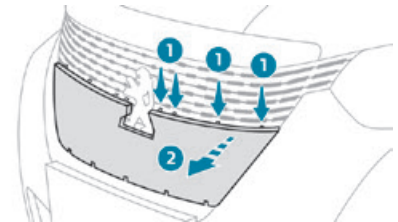

### For the central screen with horizontal grille

- ▶ Press the upper fixing brackets to release them from the grille.
- ▶ Gently tilt the central screen downwards.
- ▶ Pull towards you to unclip the unit.

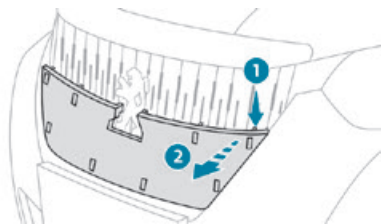

### For the central screen with vertical grille

- ▶ Insert a flat screwdriver into the holes to reach the upper fixing brackets of the central screen.
- ▶ Press on each upper fixing bracket in turn to release them from the grille.
- ▶ Pull towards you to unclip the unit.

## Energy economy mode

This system manages the duration of use of certain functions, in order to conserve a sufficient level of charge in the battery with the ignition off. After switching off the engine, you can still use functions such as the audio and telematic system, the wipers and the dipped beam headlamps or courtesy lamps, for a combined duration of approximately 40 minutes.

### Selecting the mode

A confirmation message is displayed when energy economy mode is entered, and the active functions are placed on standby.

**i** If a telephone call is in progress at the time, it will be maintained for around 10 minutes via the audio system's hands-free system.

## Exiting the mode

These functions are automatically reactivated the next time the vehicle is used.

To restore the use of these functions

immediately, start the engine and let it run:

- For less than 10 minutes, to use the equipment for approximately 5 minutes.
- For more than 10 minutes, to use the equipment for approximately 30 minutes.

Let the engine run for the specified duration to ensure that the battery charge is sufficient.

To recharge the battery, avoid repeatedly or continuously restarting the engine.

**!** A flat battery prevents the engine from starting.

For more information on the **12 V battery**, refer to the corresponding section.

## Load reduction mode

This system manages the use of certain functions according to the level of charge remaining in the battery.

When the vehicle is being driven, the load reduction function temporarily deactivates certain

functions, such as the air conditioning and the heated rear screen.

The deactivated functions are reactivated automatically as soon as conditions permit.

## Bonnet

### **!** Stop & Start

Before doing anything under the bonnet, you must switch off the ignition to avoid any risk of injury resulting from an automatic change to START mode.



**i** The location of the interior bonnet release lever prevents opening the bonnet when the left-hand front door is closed.

**!** When the engine is hot, handle the exterior safety catch and the bonnet stay with care (risk of burns), using the protected area.

When the bonnet is open, take care not to damage the safety catch.

Do not open the bonnet under very windy conditions.

**!** Cooling of the engine when stopped  
The engine cooling fan may start after the engine has been switched off. Take care with objects or clothing that could be caught in the blades of the fan!

## Opening

- ▶ Open the left-hand front door.

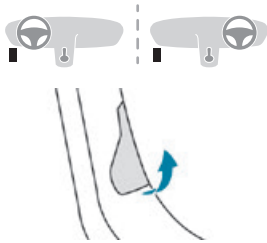

- ▶ Pull the interior release lever, located at the bottom of the door frame, towards you.

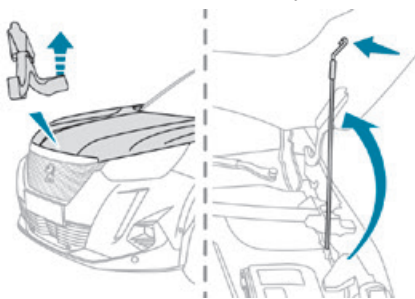

- ▶ Lift the exterior safety catch and raise the bonnet.
- ▶ Unclip the stay from its housing and place it in the support slot to hold the bonnet open.

## Closing

- ▶ Hold the bonnet and pull out the stay from the support slot.
- ▶ Clip the stay in its housing.
- ▶ Lower the bonnet and release it near the end of its travel.
- ▶ Pull on the bonnet to check that it is locked correctly.

**!** Because of the presence of electrical equipment under the bonnet, it is strongly recommended that exposure to water (rain, washing, etc.) be limited.

## Engine compartment

The engine shown here is an example for illustrative purposes only. The locations of the following elements may vary:

- Air filter.
- Engine oil dipstick.
- Engine oil filler cap.

### Petrol engine

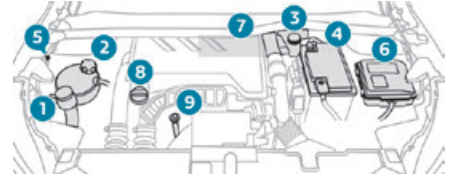

### Diesel engine

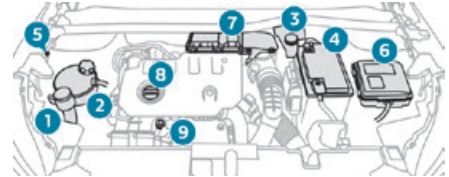

1. Screenwash fluid reservoir
2. Engine coolant reservoir
3. Brake fluid reservoir
4. Battery/Fuses
5. Remote earth point (-)
6. Fusebox
7. Air filter
8. Engine oil filler cap
9. Engine oil dipstick

**!** The Diesel fuel system operates under very high pressure.

All work on this circuit must be carried out only by a PEUGEOT dealer or a qualified workshop.

## Electric motor

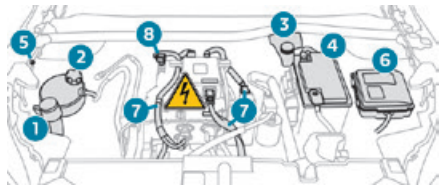

1. Screenwash fluid reservoir
2. Engine coolant reservoir
3. Brake fluid reservoir
4. Battery / Fuses
5. Remote earth point (-)
6. Fusebox
7. 400 V electrical system
8. Emergency circuit-breaker for firefighters and maintenance technicians

For more information on the **Charging system (Electric)**, refer to the corresponding section.

## Checking levels

Check all of the following levels regularly in accordance with the manufacturer's service schedule. Top them up if required, unless otherwise indicated.

If a level drops significantly, have the corresponding system checked by a PEUGEOT dealer or a qualified workshop.

**!** The fluids must comply with the manufacturer's requirements and with the vehicle's engine.

**!** Take care when working under the bonnet, as certain areas of the engine may be extremely hot (risk of burns) and the cooling fan could start at any time (even with the ignition off).

## Used products

**!** Avoid prolonged contact of used oil or fluids with the skin. Most of these fluids are harmful to health and very corrosive.



Do not discard used oil or fluids into sewers or onto the ground. Empty used oil into the containers reserved for this purpose at a PEUGEOT dealer or a qualified workshop.

## Engine oil



The level is checked, with the engine having been switched off for at least 30 minutes and on level ground, either using the oil level indicator in the instrument panel when the ignition is switched on (for vehicles equipped with an electric gauge), or using the dipstick.

It is normal to top up the oil level between two services (or oil changes). It is recommended that you check the level, and top up if necessary, every 3,000 miles (5,000 km).

**!** In order to maintain the reliability of the engine and emissions control system, never use additives in the engine oil.

## Checking using the dipstick

For the location of the dipstick, please refer to the illustration of the corresponding engine compartment.

- ▶ Grasp the dipstick by its coloured grip and pull it out completely.
- ▶ Wipe the end of the dipstick using a clean, lint-free cloth.

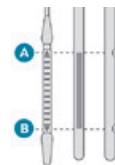

- ▶ Reinsert the dipstick and push fully down, then pull it out again to visually check the oil level: the correct level is between marks **A** (max) and **B** (min).

**Do not start the engine** if the level is:

- above mark **A**: contact a PEUGEOT dealer or a qualified workshop.
- below mark **B**: top up the engine oil immediately.

**! Oil grade**

Before topping up or changing the engine oil, check that the oil is suitable for the engine and complies with the recommendations in the service schedule supplied with the vehicle (or available from your PEUGEOT dealer and qualified workshops).

Use of non-recommended oil may invalidate the contractual warranty in the event of engine failure.

**Topping up the engine oil level**

For the location of the engine oil filler cap, please refer to the corresponding under-bonnet engine compartment illustration.

- ▶ Add oil in small quantities, avoiding any spills on engine components (risk of fire).
- ▶ Wait a few minutes before checking the level again using the dipstick.
- ▶ Top up the level if necessary.
- ▶ After checking the level, carefully screw the oil filler cap back on and replace the dipstick in its tube.

**i** Within 30 minutes of adding oil, the oil level indication in the instrument panel when the ignition is switched on is not valid.

**Brake fluid**

The level of this fluid should be close to the "**MAX**" mark. If not, check the brake pad wear.

To know how often the brake fluid should be replaced, refer to the manufacturer's servicing schedule.

**!** Clean the cap before removing it to refill.  
Use only DOT4 brake fluid from a sealed container.

**Engine coolant**

It is normal to top up this fluid between two services.

The check and top-up must only be done with the engine cold.

A low level presents a risk of serious damage to the engine.

The level of this fluid should be close to the "**MAX**" mark but should never exceed it.

If the level is close to or below the "**MIN**" mark, it is essential to top up.

When the engine is hot, the temperature of this fluid is regulated by the fan.

As the cooling system is pressurised, wait at least one hour after switching off the engine before carrying out any work.

In order to avoid the risk of scalding if you need to top up in an emergency, wrap a cloth around the cap and unscrew the cap by two turns to allow the pressure to drop.

Once the pressure has dropped, remove the cap and top up to the required level.

**Screenwash fluid**

Top up to the required level when necessary.

**Fluid specification**

The fluid must be topped up with a ready-to-use mixture.

In winter (temperatures below zero), a liquid containing an agent to prevent freezing must be used which is appropriate for the prevailing conditions, in order to protect the elements of the system (pump, tank, ducts, jets, etc.).

**!** Filling with pure water is prohibited under all circumstances (risk of freezing, limestone deposits, etc.).

**AdBlue (BlueHDi)**

An alert is triggered when the reserve level is reached.

For more information on **Indicators** and in particular the AdBlue range indicators, refer to the corresponding section.

To avoid the vehicle being immobilised in accordance with regulations, you must top up the AdBlue tank.

For more information on **AdBlue® (BlueHDi)**, and in particular on the supply of AdBlue, refer to the corresponding section.

## Checks

Unless otherwise indicated, check these components in accordance with the manufacturer's service schedule and according to your engine.

Otherwise, have them checked by a PEUGEOT dealer or a qualified workshop.

**!** Only use products recommended by PEUGEOT or products of equivalent quality and specification. In order to optimise the operation of components as important as those in the braking system, PEUGEOT selects and offers very specific products.

### 12 V battery



The battery does not require any maintenance.

However, check regularly that the terminals are correctly tightened (versions without quick release terminals) and that the connections are clean.

**i** For more information on the precautions to take before any work on the **12 V battery**, refer to the corresponding section.

**!** Versions equipped with Stop & Start are fitted with a 12 V lead-acid battery of specific technology and specification. Its replacement should be carried out only by a PEUGEOT dealer or a qualified workshop.

### Passenger compartment filter



Depending on the environment and the use of the vehicle (e.g. dusty atmosphere, city driving), **change it twice as often, if necessary**.

**i** A clogged passenger compartment filter can adversely affect air conditioning system performance and generate undesirable odours.

### Air filter



Depending on the environment and the use of the vehicle (e.g. dusty atmosphere, city driving), **change it twice as often, if necessary**.

### Oil filter



Change the oil filter each time the engine oil is changed.

### Particle filter (Diesel)



When the particle filter is approaching saturation, this

warning lamp comes on temporarily, accompanied by a message warning of the risk of the filter clogging.

As soon as the traffic conditions permit, regenerate the filter by driving at a speed of at least 37 mph (60 km/h) until the warning lamp goes off.

**i** If the warning lamp stays on, this indicates a low Diesel additive level. For more information on **Checking levels**, refer to the corresponding section.

**i** Following prolonged operation of the vehicle at very low speed or at idle, you may, in exceptional circumstances, notice water vapour coming from the exhaust while accelerating. This has no impact on the vehicle's behaviour or the environment.

**i** **New vehicle**  
During the first few particle filter regeneration operations, you may notice a "burning" smell. This is perfectly normal.

### Manual gearbox



The gearbox does not require any maintenance (no oil change).

### Automatic gearbox



The gearbox does not require any maintenance (no oil change).

## Manual parking brake



If you notice excessive brake lever travel or decreased effectiveness, the parking brake must be adjusted, even between two services.

This system must be checked by a PEUGEOT dealer or a qualified workshop.

## Electric parking brake



This system does not require any routine servicing. However, in the event of a problem, do not hesitate to have the system checked by a PEUGEOT dealer or a qualified workshop.

**i** For more information on the **Electric parking brake**, refer to the corresponding section.

## Brake pads



Brake wear depends on the style of driving, particularly in the case of vehicles used in town, over short distances. It may be necessary to have the condition of the brakes checked, even between vehicle services. Unless there is a leak in the circuit, a drop in the brake fluid level indicates that the brake pads are worn.

**i** After washing the vehicle, moisture, or in wintry conditions, ice can form on the brake discs and pads: braking efficiency may

be reduced. Gently dab the brakes to dry and defrost them.

## Brake disc/drum wear



For any information on checking brake disc/drum wear, contact a PEUGEOT dealer or a qualified workshop.

## Wheels and tyres



The inflation pressure of all tyres, including the spare wheel, must be checked on "cold" tyres.

The pressures indicated on the tyre pressure label are valid for "cold" tyres. If you have driven for more than 10 minutes or more than 6 miles (10 kilometres) at over 31 mph (50 km/h), add 0.3 bar (30 kPa) to the values indicated on the label.



Under-inflation increases energy consumption. Non-compliant tyre pressure causes premature wear on tyres and has an adverse effect on the vehicle's road holding - risk of an accident!

Driving with worn or damaged tyres reduces the braking and road holding performance of the vehicle. It is recommended to regularly check the condition of the tyres (tread and sidewalls) and wheel rims as well as the presence of the valves. When the wear indicators no longer appear set back from the tread, the depth of the grooves is

less than 1.6 mm; it is essential to replace the tyres.

Using different size wheels and tyres from those specified can affect the lifetime of tyres, wheel rotation, ground clearance, the speedometer reading and have an adverse effect on road holding.

Fitting different tyres on the front and rear axles can cause the ESC to mistime.

## Shock absorbers



It is not easy for drivers to detect when shock absorbers are worn. Nevertheless, the shock absorbers have a major impact on road holding and braking performance. For your safety and driving comfort, it is important to have them regularly checked by a PEUGEOT dealer or a qualified workshop.

## Timing and accessory kits



The timing and accessory kits are used from the time the engine is started until it is switched off. It is normal for them to wear over time.

A faulty timing or accessory kit can damage the engine, rendering it unusable. Observe the recommended replacement frequency, stated in distance travelled or time elapsed, whichever is reached first.

## AdBlue® (BlueHDi)

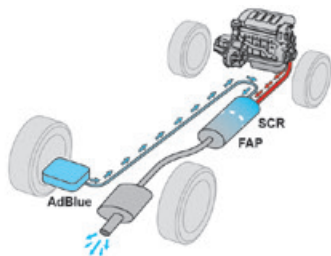

To respect the environment and ensure compliance with the Euro 6 standard, without adversely affecting the performance or fuel consumption of its Diesel engines, PEUGEOT has taken the decision to equip its vehicles with a system that associates SCR (Selective Catalytic Reduction) with a Diesel Particle Filter (DPF) for the treatment of exhaust gases.

### SCR system

Using a liquid called AdBlue® that contains urea, a catalytic converter turns up to 85% of the nitrogen oxides (NOx) into nitrogen and water, which are harmless to health and the environment.



The AdBlue® is contained in a **special tank** holding about 15 litres. Its capacity allows a driving range of approximately 5,600 miles (9,000 km), **which may vary considerably** depending on your driving style.

An alert system is triggered once the reserve level is reached: it is then possible to drive for a further 1,500 miles (2,400 km) before the tank is empty and the vehicle blocked.

**i** For more information on the **Warning and indicator lamps** and the associated alerts, or the **Indicators**, please refer to the corresponding sections.

**!** Once the AdBlue® tank is empty, a system required by legislation prevents starting of the engine.

If the SCR system is faulty, the level of emissions from the vehicle will no longer meet the Euro 6 standard: the vehicle becomes polluting.

In the event of a confirmed SCR system malfunction, it is essential to visit a PEUGEOT dealer or a qualified workshop. After 685 miles (1,100 km), a device is automatically activated to prevent the engine from starting.

In both cases, a range indicator indicates the distance that can be travelled before the vehicle is stopped.

**i** **Freezing of the AdBlue®**  
AdBlue® freezes at temperatures below around -11°C. The SCR system includes a heater for the AdBlue® tank, allowing you to continue driving in very cold conditions.

### Supply of AdBlue®

It is recommended that the AdBlue® be topped up as soon as the first alert is issued indicating that the reserve level has been reached.

- !** In order to ensure that the SCR system operates correctly:
- Use only AdBlue® fluid that meets the ISO 22241 standard.
  - Never transfer AdBlue® to another container: it would lose its purity.
  - Never dilute AdBlue® with water.

AdBlue® can be obtained from a PEUGEOT dealer or a qualified workshop.

### Storage recommendations

AdBlue® freezes at about -11°C and deteriorates above +25°C. Containers should be stored in a cool area and protected from direct sunlight. Under these conditions, the fluid can be kept for at least a year.

If the fluid has frozen, it can be used once it has completely thawed out in the ambient air.

- !** Never store AdBlue® containers in your vehicle.

### Precautions for use

AdBlue® is a urea-based solution. This fluid is non-flammable, colourless and odourless (when kept in a cool place).



In the event of contact with the skin, wash the affected area with soap and running water. In the event of contact with the eyes, immediately rinse the eyes with large amounts of water or with an eye wash solution for at least 15 minutes. Seek medical attention if you feel a persistent burning sensation or irritation.

If swallowed, immediately wash out the mouth with clean water and then drink plenty of water. In certain conditions (high temperature, for example), the risk of release of ammonia cannot be excluded: do not inhale the fluid. Ammonia vapours have an irritant effect on mucous membranes (eyes, nose and throat).

! Store AdBlue® out of the reach of children, in its original container.

## Procedure

Before starting the top-up procedure, ensure that the vehicle is parked on a flat and level surface. In wintry conditions, ensure that the temperature of the vehicle is above -11 °C. Otherwise the AdBlue® may be frozen and so cannot be poured into its tank. Park the vehicle in a warmer area for a few hours to allow the top-up to be carried out.

! Never put the AdBlue® into the Diesel fuel tank.

! If any AdBlue® is splashed, or if there are any spillages on the bodywork, rinse

immediately with cold water or wipe with a damp cloth. If the fluid has crystallised, clean it off using a sponge and hot water.

! Important: in the event of a top-up after a breakdown because of a lack of AdBlue, it is essential to wait around 5 minutes before switching on the ignition, without opening the driver's door, unlocking the vehicle, introducing the key into the ignition switch, or introducing the key of the "Keyless Entry and Starting" system into the passenger compartment. Switch on the ignition, then wait for 10 seconds before starting the engine.

- ▶ Switch off the ignition and remove the key from the switch to switch off the engine. or
- ▶ With Keyless Entry and Starting, press the "START/STOP" button to switch off the engine.

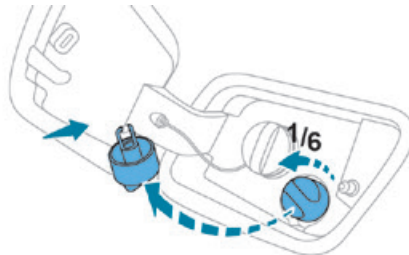

- ▶ Turn the blue cap of the AdBlue® tank a 6<sup>th</sup> of a turn anti-clockwise and remove it.
- ▶ With a container of AdBlue®: after checking the expiry date, read the instructions on the label carefully before pouring the contents of the container into the vehicle's AdBlue tank.
- ▶ With an AdBlue® pump: introduce the nozzle and fill the tank until the nozzle automatically cuts out.

! In order not to overfill the AdBlue® tank:

- Add between 10 and 13 litres using AdBlue® containers.
- Stop after the nozzle's first automatic cut-out, if you are refilling at a service station. The system only registers AdBlue® top-ups of 5 litres or more.

! If the AdBlue® tank is completely empty – which is confirmed by the message "Top up AdBlue: Starting impossible" – it is essential to add at least 5 litres.

## Free-wheeling

In certain situations, you must allow the vehicle to free-wheel (while being towed, on a rolling road, in an automatic car wash, or being transported by rail or sea freight, etc.). The procedure varies according to the type of gearbox and parking brake.

## With manual or EAT6 automatic gearbox and electric parking brake



### Release procedure

- ▶ With the engine running and while depressing the brake pedal, move the gear selector to the neutral position.
- ▶ While depressing the brake pedal, switch off the ignition.
- ▶ Release the brake pedal, then switch on the ignition again.
- ▶ While depressing the brake pedal, press the control lever to release the parking brake.
- ▶ Release the brake pedal, then switch off the ignition.

### Reverting to normal operation

- ▶ While depressing the brake pedal, start the engine.

## With EAT8 automatic gearbox and manual parking brake



### Release procedure

- ▶ With the vehicle stationary and the engine running, select mode **N** and switch off the ignition.

#### Within 5 seconds:

- ▶ Switch on the ignition again.
- ▶ While depressing the brake pedal, move the push selector forwards or backwards to confirm mode **N**.
- ▶ Switch off the ignition.

If the 5-second time limit is exceeded, the gearbox engages mode **P**; it is then necessary to restart the procedure.

### Reverting to normal operation

- ▶ Press button **P** on the selector.

## With EAT8 automatic gearbox or drive selector and electric parking brake



### Release procedure

- ▶ With the vehicle stationary and the engine running, select mode **N** and switch off the ignition.

#### Within 5 seconds:

- ▶ Switch on the ignition again.
- ▶ While depressing the brake pedal, move the push selector forwards or backwards to confirm mode **N**.

- ▶ While depressing the brake pedal, press the control lever to release the parking brake.
- ▶ Release the brake pedal, switch off the ignition.

If the 5-second time limit is exceeded, the gearbox engages mode **P**; it is then necessary to restart the procedure.

### Reverting to normal operation

- ▶ While depressing the brake pedal, restart the engine.

### **i** Keyless Entry and Starting

You must not depress the brake pedal while switching the ignition on or off. If you do, the engine will start, requiring you to restart the procedure.

## Advice on care and maintenance

### General recommendations

Observe the following recommendations to avoid damaging the vehicle.

#### Exterior

**!** Never use a high-pressure jet wash in the engine compartment - risk of damaging the electrical components!  
Do not wash the vehicle in bright sunshine or extremely cold conditions.

**i** When washing the vehicle in an automatic roller-brush car wash, be sure to lock the doors and, depending on version, move the electronic key away. When using a pressure washer, hold the lance at least 30 cm from the vehicle (particularly when cleaning areas containing chipped paint, sensors or seals). Promptly clean up any stains containing chemicals liable to damage the vehicle's paint (including tree resin, bird droppings, insect secretions, pollen and tar). If justified by the environment, clean the vehicle more frequently to remove salty deposits (in coastal areas), soot (in industrial areas) and mud (in wet or cold areas). These substances can be highly corrosive. Contact a PEUGEOT dealer or a qualified workshop for advice on removing stubborn stains requiring special products (such as tar or insect removers). Preferably, have paint touch-ups performed by a PEUGEOT dealer or a qualified workshop.

## Interior

**!** When washing the vehicle, never use a water hose or high-pressure jet to clean the interior. Liquids carried in cups or other open containers can spill, presenting a risk of damage if they come into contact with the

controls in the dashboard and centre console. Be vigilant!

## Bodywork

### High-gloss paint

**!** Do not use abrasive products or solvents, petrol or oil to clean the bodywork. Never use an abrasive sponge to clean stubborn stains. Risk of scratching the paintwork! Do not apply polish in strong sunshine, or to plastic or rubber parts.

**i** Use a soft sponge and soapy water or a pH neutral product. Gently wipe the bodywork with a clean microfibre cloth. Apply polish with the vehicle clean and dry. Comply with the instructions for use stated on the product.

### Decals

(Depending on version)

**!** Do not use a high pressure washer to clean the vehicle. Risk of damaging or detaching the decals!

**i** Use a high-flow hose at a temperature between 25°C and 40°C. Sweep the jet of water across the surface to be cleaned, perpendicular to it. Rinse the vehicle with demineralised water.

## Leather

Leather is a natural product. Appropriate regular care is essential for its durability. It must be protected and nourished using a specific leather product, to keep it supple and preserve its original appearance.

**!** Do not clean leather using unsuitable cleaning agents such as solvents, detergents, petrol or pure alcohol. When cleaning items partly made from leather, take care not to damage the other materials with the specific leather product.

**i** Before cleaning greasy stains or liquids, quickly mop up any surplus. Before cleaning, wipe off any residues liable to scuff the leather, using a cloth that has been dampened with demineralised water and thoroughly wrung out. Clean leather using a soft cloth moistened with soapy water or a pH-neutral product. Dry with a soft, dry cloth.

## Warning triangle

As a safety precaution, before leaving your vehicle to set up and install the triangle, switch on the hazard warning lamps and put on your high visibility vest.

## Storage compartment

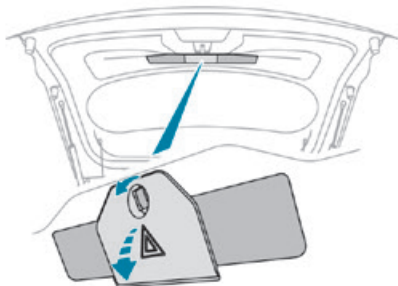

There is a compartment in the interior trim of the tailgate to store a warning triangle.

- ▶ After opening the tailgate, release the cover by turning the screw a quarter turn to the left.

## Assembling and placing the triangle

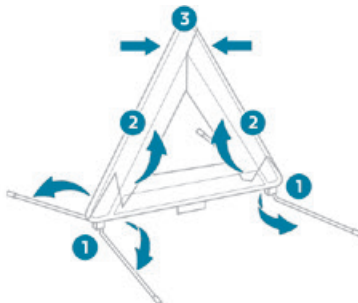

For versions supplied with a triangle as original equipment, refer to the illustration above.

For other versions, refer to the assembly instructions provided with the triangle.

- ▶ Put the triangle in place behind the vehicle, as required by local legislation.

## Running out of fuel (Diesel)

With Diesel engines, the fuel system must be primed if you run out of fuel.

**Before starting to prime the system**, it is essential to put at least 5 litres of Diesel into the fuel tank.

**i** For more information on **Refuelling** and on **Misfuel prevention (Diesel)**, refer to the corresponding section.

### 1.5 BlueHDI engines

- ▶ Switch on the ignition (without starting the engine).
  - ▶ Wait around 1 minute and switch off the ignition.
  - ▶ Operate the starter motor to start the engine.
- If the engine does not start at the first attempt, do not keep trying, but restart the procedure.

## Tool kit

Set of tools supplied with the vehicle.

Its content depends on your vehicle's equipment:

- Temporary puncture repair kit.
- Spare wheel.

## Access to the tools

Depending on version, the tool kit is stored in a bag or in a storage box in the boot.

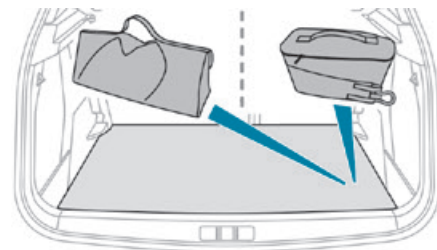

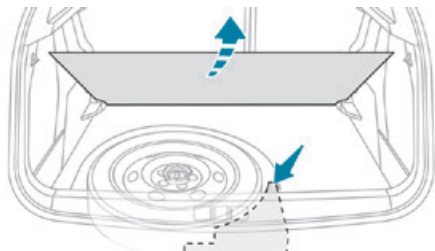
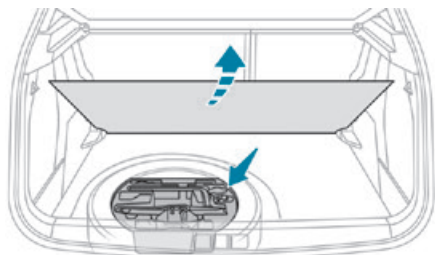
**On the boot carpet or floor****Under the boot carpet or floor**

► Raise the boot floor (depending on version), then the boot carpet by pulling the strap to access the tools.

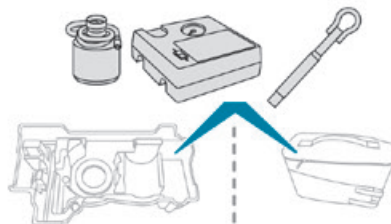
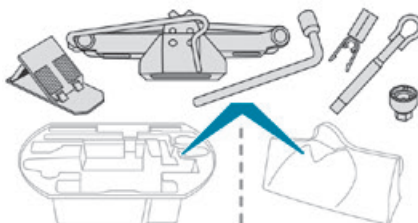
**With temporary puncture repair kit****With spare wheel**

! These tools are specific to the vehicle and may vary according to the level of equipment.

Do not use them for any other purpose.

! The jack must only be used to change a wheel with a damaged or punctured tyre. Do not use any jack other than the one supplied with the vehicle.

If the vehicle does not have its original jack, contact a PEUGEOT dealer or a qualified

workshop to obtain the one that was intended by the manufacturer.

The jack meets European standards, as defined in the Machinery Directive 2006/42/CE.

The jack does not require any maintenance.

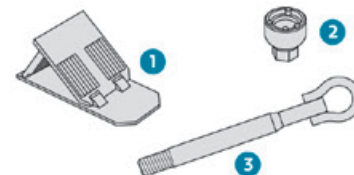
**List of tools**

1. Chock to immobilise the vehicle (depending on equipment)
2. Socket for the wheel security bolts (located in the glove box) (depending on equipment) For adapting the wheelbrace to the special 'security' bolts.
3. Removable towing eye

For more information on **Towing the vehicle** and using the removable towing eye, refer to the corresponding section.

## With temporary puncture repair kit

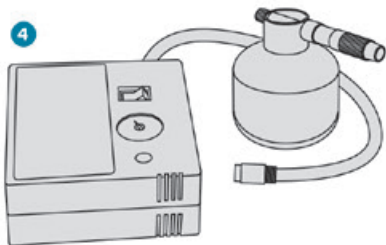

4. 12 V compressor with a cartridge of sealant and a speed limit sticker  
For temporary repair of a tyre and to adjust the tyre pressure.

For more information about the **Temporary puncture repair kit**, refer to the corresponding section.

## With spare wheel

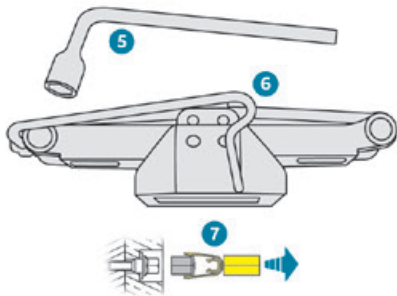

5. Wheelbrace  
For removing the wheel trim and the wheel bolts.
6. Jack with integrated handle  
To raise the vehicle.
7. Wheel bolt cap remover (depending on equipment)  
For removing the wheel bolt head finishers on alloy wheels.

For more information on the **Spare wheel**, refer to the corresponding section.

## Temporary puncture repair kit

- i** Scan the QR Code on page 3 to view explanatory videos.

Made up of a compressor and a sealant cartridge, it allows you to carry out a **temporary repair** of the tyre so that you can drive to the nearest garage.

It is designed to repair most punctures located on the tyre tread.

- i** The vehicle's electric system allows the connection of the compressor to the 2 V power supply for long enough to repair a tyre after a puncture.

- i** For more information on the **Tool kit**, refer to the corresponding section.

## Repair procedure

- !** Do not remove any foreign bodies (e.g. nail, screw) which have penetrated into the tyre.

- ▶ Park the vehicle without obstructing traffic and apply the parking brake.
- ▶ Follow the safety instructions (hazard warning lamps, warning triangle, high visibility jacket, etc.) according to the legislation in force in the country in which you are driving.
- ▶ Switch the ignition off.
- ▶ Remove the valve cap from the tyre to be repaired, and place it in a clean area.

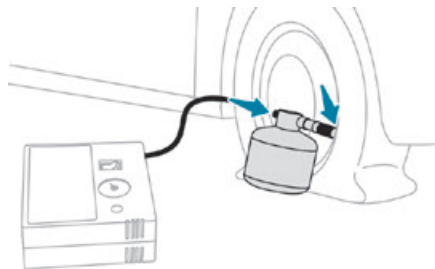

- ▶ Connect the pipe from the bottle of sealant to the valve of the tyre to be repaired and tighten firmly.
- ▶ Connect the pipe from the compressor to the bottle of sealant.
- ▶ Check that the compressor switch is in position "O".

- ▶ Fully uncoil the electric cable stowed under the compressor.
- ▶ Connect the compressor's electric plug to the vehicle's 12 V socket.



- ▶ Affix the speed limit sticker.

**!** The speed limit sticker must be affixed inside the vehicle in the area close to the driver, to remind them that a wheel is in temporary use.

**i** The tyre inflation pressures are given on this label.

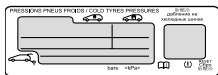

- ▶ Switch the ignition on.

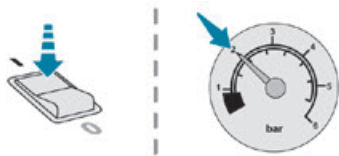

- ▶ Switch on the compressor by moving the switch to position "I" until the tyre pressure reaches 2 bar. The sealant product is injected under pressure into the tyre; do not disconnect

the pipe from the valve during this operation (risk of blowback).

**!** If after approximately 7 minutes, the pressure of 2 bar is not reached, this indicates that the tyre is not repairable; contact a PEUGEOT dealer or a qualified workshop for assistance.

- ▶ Move the switch to position "O".
- ▶ Disconnect the compressor's electric plug from the vehicle's 12 V socket.
- ▶ Remove the kit.
- ▶ Refit the cap on the valve.
- ▶ Remove and store the bottle of sealant.

**!** The sealant product is harmful if swallowed and causes irritation to the eyes.

Keep this product out of the reach of children. The use-by date of the fluid is marked on the bottle.

After use, do not discard the bottle in standard waste, take it to a PEUGEOT dealer or an authorised waste disposal site. Do not forget to obtain a new bottle of sealant, available from a PEUGEOT dealer or a qualified workshop.

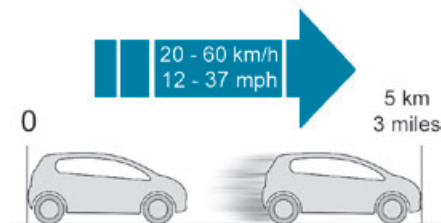

- ▶ Drive immediately for approximately 3 miles (5 kilometres) at reduced speed (between 12 and 37 mph (20 and 60 km/h)) to plug the puncture.
- ▶ Stop to check the repair **and the tyre pressure** using the kit.

**!** With a tyre repaired using this type of kit, do not exceed a speed of 50 mph (80 km/h) and do not drive more than 125 miles (200 km). Contact a PEUGEOT dealer or a qualified workshop to have the tyre changed.

## Checking/adjusting tyre pressures

The compressor can be used, **without injecting sealant**, to check and, if necessary, adjust the tyre pressures.

- ▶ Remove the valve cap from the tyre and keep it in a clean place.
- ▶ Uncoil the pipe stowed under the compressor.
- ▶ Screw the pipe onto the valve and tighten firmly.

- ▶ Check that the compressor switch is in position "O".
- ▶ Fully uncoil the electric cable stowed under the compressor.
- ▶ Connect the compressor's electric plug to the vehicle's 12 V socket.
- ▶ Switch the ignition on.

**i** The tyre inflation pressures are given on this label.

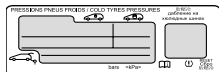

- ▶ Start the compressor by placing the switch at position "I" and adjust the pressure to the value shown on the vehicle's tyre pressure label. To deflate: press the black button located on the compressor pipe, near the valve connection.

**!** If after 7 minutes the pressure of 2 bar is not reached, the tyre is damaged; contact a PEUGEOT dealer or a qualified workshop for assistance.

- ▶ Once the correct pressure is reached, put the switch in position "O".
- ▶ Remove the kit and stow it.
- ▶ Refit the cap on the valve.

**!** Should the pressure of one or more tyres be adjusted, it is necessary to reinitialise the under-inflation detection system. For more information on **Tyre under-inflation detection**, refer to the corresponding section.

## Spare wheel

- i** Scan the QR Code on page 3 to view explanatory videos.
- i** For more information on the **Tool kit**, refer to the corresponding section.

## Accessing the spare wheel

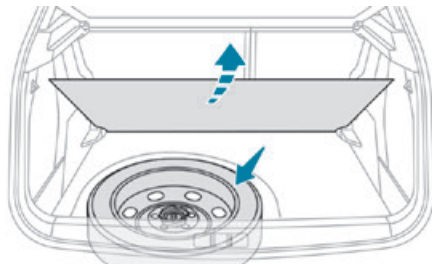

The spare wheel is stored under the boot carpet. To access the spare wheel, first refer to the **Tool kit** section.

- i** Depending on version, the spare wheel may be a standard steel or 'space-saver' wheel.

## Removing the spare wheel

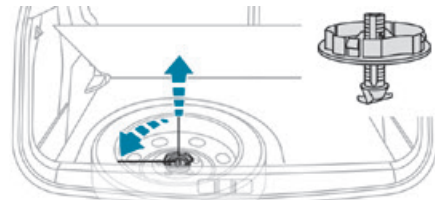

- ▶ Slacken the central nut.
- ▶ Remove the fastening device (nut and bolt).
- ▶ Lift the spare wheel towards you from the rear.
- ▶ Take the wheel out of the boot.

## Putting the spare wheel back in place

**!** The punctured wheel cannot be placed in the boot under the floor.

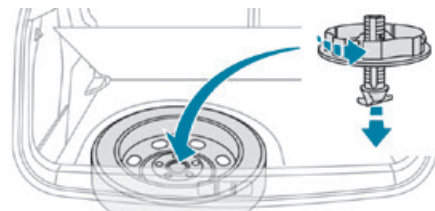

- ▶ Put the spare wheel back in place in its housing.
- ▶ Slacken the nut on the bolt by a few turns.
- ▶ Position the fastening device (nut and bolt) in the middle of the wheel.



- ▶ Tighten the central nut sufficiently to retain the wheel correctly.
- ▶ Depending on version, put the tool box back in place in the middle of the wheel and clip it in place.

## Removing a wheel

### ! Parking the vehicle

Immobilise the vehicle where it does not obstruct traffic: the ground must be level, stable and non-slippery.

With a manual gearbox, engage first gear to lock the wheels, apply the parking brake, unless it is programmed to be in automatic mode, and switch off the ignition.

With an automatic gearbox, select mode **P** to lock the wheels, apply the parking brake, unless it is programmed to be in automatic mode, and switch off the ignition.

Check for the fixed illumination of the parking brake warning lamps in the instrument panel. The occupants must get out of the vehicle and wait where they are safe.

If necessary, place a chock under the wheel diagonally opposite the wheel to be changed. Never go underneath a vehicle raised using a jack; use an axle stand.

### i Wheel with wheel trim

**When removing the wheel**, first remove the wheel trim by pulling at the valve aperture using the wheelbrace.

**When refitting the wheel**, refit the wheel trim, starting by placing its aperture in line with the valve and then pushing it into place all round its edge with the palm of your hand.

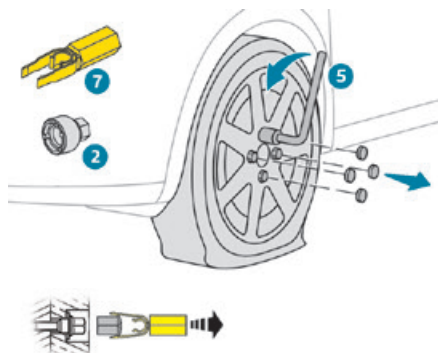

- ▶ To remove the wheel bolt cover on each of the bolts, use tool 7 (alloy wheels).
- ▶ Fit security socket 2 on wheelbrace 5 to slacken the security bolt.
- ▶ Slacken the other bolts using the wheelbrace 5 only.

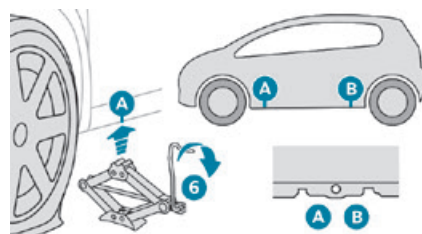

- ▶ Place the foot of jack 6 on the ground and ensure that it is directly below the front **A** or rear **B** jacking point on the underbody, whichever is closest to the wheel to be changed.

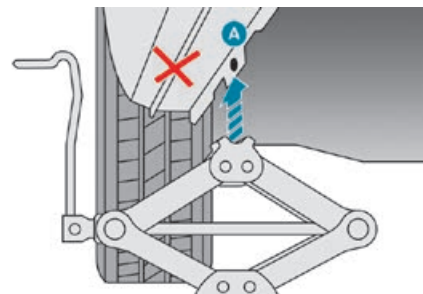

- ▶ Extend jack 6 until its head comes into contact with jacking point **A** or **B**; contact area **A** or **B** on the vehicle must be properly inserted into the central part of the head of the jack.
- ▶ Raise the vehicle until there is sufficient space between the wheel and the ground to admit the spare (not punctured) wheel easily.

**!** Ensure that the jack is stable. If the ground is slippery or loose, the jack may slip or collapse - risk of injury!  
Take care to position the jack strictly at one of the jacking points **A** or **B** under the vehicle, ensuring that the head of the jack is centred under the contact area of the vehicle. Otherwise, there is a risk of damage to the vehicle and/or of the jack collapsing - risk of injury!

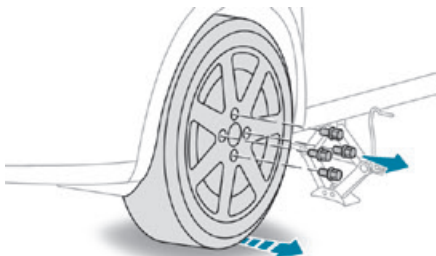

- ▶ Remove the bolts and store them in a clean place.
- ▶ Remove the wheel.

## Fitting a wheel

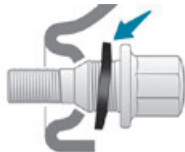

### **i** Fitting a steel or "space-saver" type spare wheel

If the vehicle is equipped with alloy wheels, the washers do not make contact with the steel or "space-saver" type spare wheel. The wheel is secured by the conical contact of each bolt.

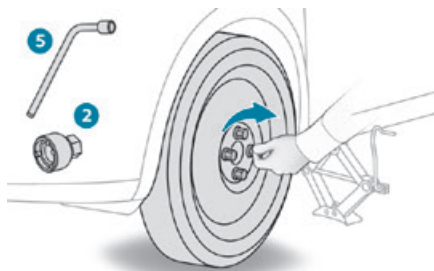

- ▶ Fit the wheel on the hub.
- ▶ Screw in the bolts by hand as far as possible.
- ▶ Pre-tighten the security bolt using the wheelbrace **5** equipped with a security socket **2**.
- ▶ Pre-tighten the other bolts using the wheelbrace **5** only.

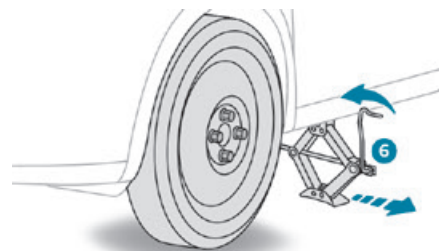

- ▶ Lower the vehicle again fully.
- ▶ Fold jack **6** and remove it.

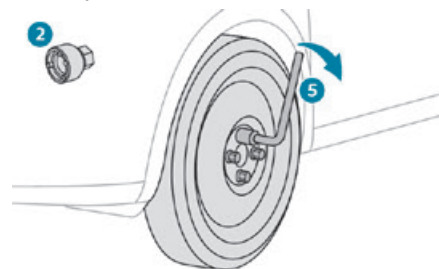

- ▶ Tighten the security bolt using the wheelbrace **5** equipped with a security socket **2**.
- ▶ Tighten the other bolts using the wheelbrace **5** only.
- ▶ Refit the bolt covers to each of the bolts (depending on equipment).
- ▶ Store the tools.

## After changing a wheel



### ! With a "space-saver" type spare wheel

Deactivate certain driving aid functions (Active Safety Brake, Adaptive cruise control, etc.).

Do not exceed the maximum authorised speed of 50 mph (80 km/h).

Driving with more than one "space-saver" type spare wheel is prohibited.

! Visit a PEUGEOT dealer or a qualified workshop as soon as possible to have the tightness of the bolts and the pressure of the spare wheel checked.

Have the punctured tyre examined. After inspection, the technician will advise you on whether the tyre can be repaired or if it must be replaced.

## Changing a bulb

i In some weather conditions (e.g. low temperature or humidity), misting on the internal surface of the glass of the headlamps and rear lamps is normal, and will disappear

after the lamps have been on for a few minutes.

! Never look too closely at the luminous beam of LED or Full

LED technology headlamps: risk of serious eye injury!



! The headlamps have polycarbonate lenses with a protective coating:

– **Do not clean them with a dry or abrasive cloth, nor with detergent or solvent products.**

– Use a sponge and soapy water or a pH neutral product.

– When using a high-pressure washer on persistent marks, do not keep the lance directed towards the headlamps, lamps or their edges for too long, so as not to damage their protective coating and seals.

! Changing a bulb must only be done with the ignition off and after the headlamp /

lamp has been switched off for several minutes - risk of serious burns!

Do not touch the bulb directly with your fingers; use a lint-free cloth.

It is essential only to use anti-ultraviolet (UV) type bulbs, so as not to damage the headlamp.

Always replace a failed bulb with a new bulb of the same type and specification. To avoid lighting imbalance, replace the bulbs in pairs.

### i Refitting the lamp units

Perform the operations in the reverse order to dismantling.

## Light-emitting diode (LED) headlamps and lamps

Depending on version, the affected types of headlamps / lamps are:

- "LED" technology headlamps.
- Full LED technology headlamps.
- Front foglamps.
- Offset daytime running lamps.
- Direction indicator side repeaters.
- Side spotlamps.
- 3D rear lamps.
- Third brake lamp.
- Number plate lamps.

**!** If you need to replace this type of bulb, you must contact a PEUGEOT dealer or a qualified workshop.  
Do not touch LED or Full LED technology headlamps - risk of electrocution!

## Front lamps

### Model with Full LED technology headlamps

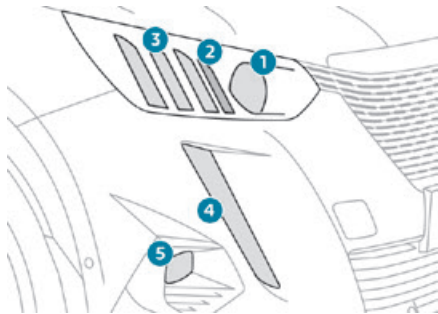

1. Dipped beam headlamps / Main beam headlamps
2. Direction indicators
3. Sidelamps
4. Daytime running lamps / Sidelamps
5. Front foglamps

### Model with LED technology headlamps

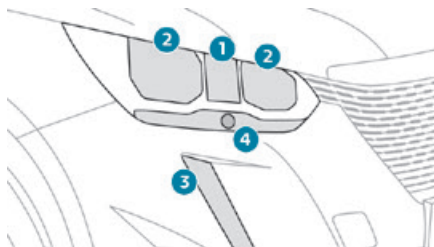

1. Main beam headlamps (LED)
2. Dipped beam headlamps (LED)
3. Daytime running lamps / Sidelamps (LED)
4. Direction indicators (PY21W amber).

### Model with halogen headlamps

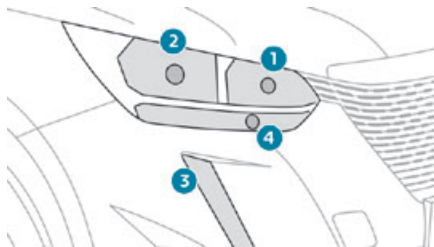

1. Main beam headlamps (H9)
2. Dipped beam headlamps (H18)
3. Daytime running lamps / Sidelamps (LEDs)
4. Direction indicators (PY21W amber).

### **!** Opening the bonnet / Accessing the bulbs

With the engine warm, proceed with caution - risk of burns!

Take care with objects or clothing that could be caught in the blades of the cooling fan - risk of strangulation!



### **i** Halogen bulbs (Hx)

To ensure good quality lighting, check that the bulb is correctly positioned in its housing.

### Main / Dipped beam headlamps

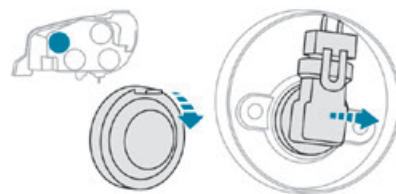

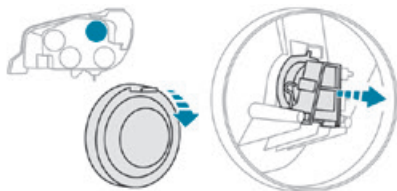

- ▶ Remove the protective cover by pulling the tab.
- ▶ Pull the bulb holder backwards to remove it.
- ▶ Pull the bulb to remove it.
- ▶ Replace the bulb.

When refitting the bulb holder in its housing, press until you hear a click which means it is locked in place.

### Direction indicators

**i** Rapid flashing of a direction indicator lamp (left or right) indicates that one of the bulbs on the corresponding side has failed.

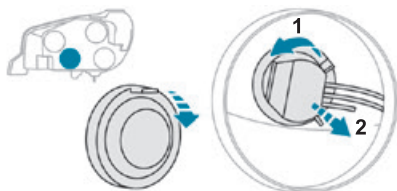

- ▶ Remove the protective cover by pulling the tab.
- ▶ Turn the bulb holder anti-clockwise.

- ▶ Pull the bulb and bulb holder assembly backwards.
- ▶ Replace the bulb.

**i** Amber coloured bulbs must be replaced by bulbs with identical specifications and colour.

## Rear lamps

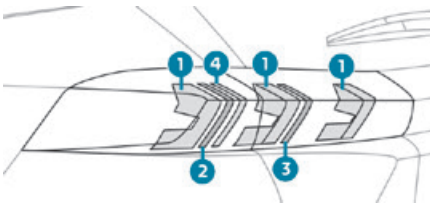

1. Sidelamps / Daytime running lamps (LED)
2. Brake lamps (LED)
3. Reversing lamps (LED)
4. Direction indicators (LED)

### Foglamps (P21W)

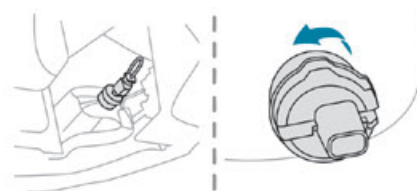

These bulbs are replaced from outside the rear bumper.

- ▶ Pass your hand under the bumper.
- ▶ Disconnect the connector.
- ▶ Turn the bulb holder a quarter turn and remove it.
- ▶ Turn the bulb a quarter turn and replace it.

**!** To change the bulb within a few minutes of switching off the ignition, take care not to touch the exhaust - risk of burns!

## Changing a fuse

### Accessing the tools

The extraction tweezers are located behind the fusebox cover.

Depending on version:

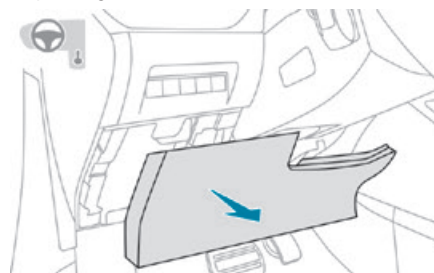

- ▶ Unclip the cover by pulling at the top left, then right.
- ▶ Remove the cover completely.
- ▶ Take the tweezers from their housing.

In the event of a breakdown

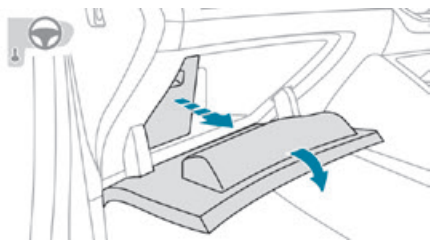

- ▶ Open the glove box.
- ▶ Press on the central handle of the fusebox cover.
- ▶ Lower the cover completely.
- ▶ Take the tweezers from their housing.

## Changing a fuse

Before changing a fuse:

- ▶ Identify the cause of the fault and fix it.
- ▶ Switch off all power consumption.
- ▶ Immobilise the vehicle and switch off the ignition.

▶ Identify the defective fuse using the current allocation tables and diagrams.

To replace a fuse, it is essential to:

- ▶ Use the special tweezers to extract the fuse from its housing and check the condition of its filament.
- ▶ Always replace the failed fuse with a fuse of the same rating (same colour); use of a different rating may cause malfunctions - risk of fire!

If the fault recurs soon after replacing a fuse, have the electrical system checked by a PEUGEOT dealer or a qualified workshop.

**i** The fuse allocation tables and the corresponding diagrams are available from a PEUGEOT dealer or from a qualified workshop.

**!** The replacement of a fuse not shown in the allocation tables may cause a serious malfunction of the vehicle. Contact a PEUGEOT dealer or a qualified workshop.

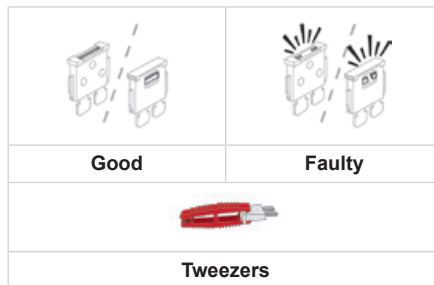

**i** **Installing electrical accessories**  
The vehicle's electrical system is designed to operate with standard or optional equipment.  
Before fitting other electrical equipment or accessories to your vehicle, contact a PEUGEOT dealer or a qualified workshop.

**!** PEUGEOT accepts no responsibility for the cost incurred in repairing the vehicle or for rectifying malfunctions resulting from

the installation of accessories not supplied or not recommended by PEUGEOT and not installed in accordance with its recommendations, in particular when the combined power consumption of all of the additional equipment connected exceeds 10 milliamperes.

## Fuses in the dashboard

The fusebox is located in the lower dashboard (left-hand side).

To access the fuses, follow the same procedure as described for accessing the fuse replacement tools.

## Fuse tables

### Lower fusebox

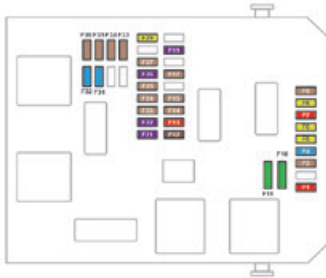

Fuse N°	Rating (Amps)	Functions
F1	10 A	Electrochrome interior rear view mirror
F3	5 A	Wireless smartphone charger.
F4	15 A	Horn.
F5	20 A	Screenwash pump.
F6	20 A	Screenwash pump.
F7	5 A	Rear USB sockets.
F8	20 A	Rear wiper.
F10	30 A	Locking/Unlocking.
F11	30 A	Locking/Unlocking.
F14	5 A	Emergency and assistance calls - Alarm.
F24	5 A	7-inch touch screen.

Fuse N°	Rating (Amps)	Functions
F27	5 A	Alarm (retrofit).
F29	20 A	10-inch touch screen.
F31 or F32	15 A	Cigarette lighter/12 V accessory socket.

### Upper fusebox

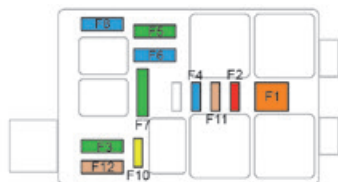

Fuse N°	Rating (Amps)	Functions
F1	40 A	Heated rear screen.
F2	10 A	Heated door mirrors.
F3	30 A	Front one-touch electric windows.
F4	20 A	Door mirrors adjustment - Folding door mirrors.
F5	30 A	Rear one-touch electric windows.
F6	15 A	Sunroof.
F10	30 A	Heated front seats.

## Engine compartment fuses

The fusebox is placed in the engine compartment near the battery.



## Accessing the fuses

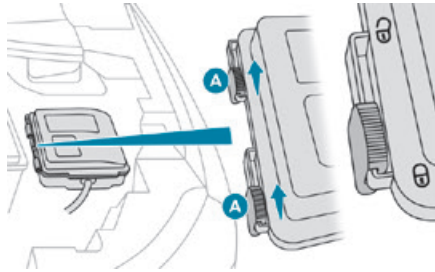

- ▶ Release the two latches **A**.
- ▶ Remove the cover.
- ▶ Replace the fuse.
- ▶ When you have finished, close the cover carefully, then engage the two latches **A** to ensure that the fusebox is properly sealed.

## Fuse table

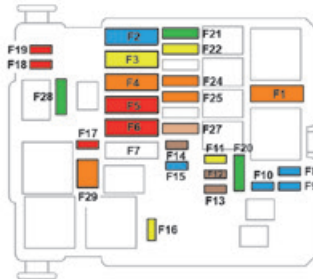

Fuse N°	Rating (Amps)	Functions
F16	20 A	Heated windscreen.
F18	10 A	Right-hand main beam halogen headlamp.
F19	10 A	Left-hand main beam halogen headlamp.
F29	40 A	Windscreen wipers.

## 12 V battery / Accessory battery

Procedure for starting the engine using another battery or for charging a discharged battery.

### Lead-acid starter batteries



These batteries contain harmful substances (sulphuric acid and lead).

They must be disposed of in accordance with regulations and must never under any circumstances be discarded with household waste.

Take used remote control batteries and vehicle batteries to a special collection point.



Protect your eyes and face before handling the battery.

All operations on the battery must be carried out in a well ventilated area and away from naked flames and sources of sparks, to avoid any risk of explosion or fire.  
Wash your hands afterwards.

### Electric motor



#### Flat accessory battery

It is no longer possible to start the motor or recharge the traction battery.

#### ! Precautions before working on the accessory battery

Select mode **P**, switch off the ignition, check that the instrument panel is off and that the vehicle is not plugged in.

#### ! Recharging the accessory battery

You must not recharge the battery without first disconnecting the terminals and removing the battery from the motor compartment.  
Do not disconnect the battery terminals while the **READY** indicator lamp is lit, or while the vehicle is charging.

#### ! Jump-starting another vehicle

Do not use the accessory battery to jump-start another vehicle or to charge another vehicle's battery.

### Access to the battery

The battery is located under the bonnet.

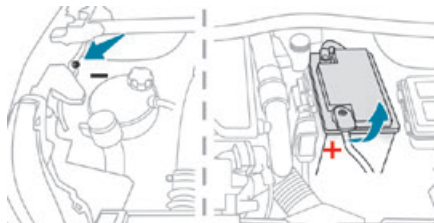

For access to the (+) terminal:

► Release the bonnet by pulling the internal release lever, then the external safety catch.

► Raise the bonnet.

(+) Positive terminal.

This terminal has a quick-release clamp.

(-) Negative terminal.

As the battery's negative terminal is not accessible, a remote earth point is located facing the battery.

### Starting using another battery

If the vehicle's battery is flat, the engine can be started using a backup battery (either external or from another vehicle) and jump leads or using a battery booster.



Never start the engine by connecting a battery charger.

Never use a 24 V or higher battery booster. Check beforehand that the backup battery has a nominal voltage of 12 V and a capacity at least equal to that of the discharged battery.

The two vehicles must not be in contact with each other.

Switch off all electricity-consuming equipment on both vehicles (audio system, wipers, lighting, etc.).

Make sure that the jump leads are well away from the engine's moving parts (fan, belt, etc.).

Do not disconnect the (+) terminal while the engine is running.

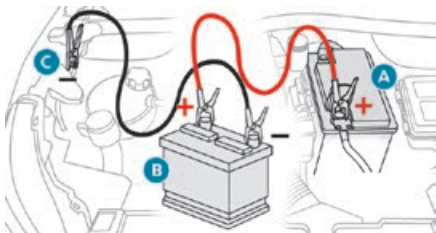

- ▶ Lift the plastic cover on the (+) terminal, if the vehicle has one.
  - ▶ Connect the red cable to the (+) terminal of flat battery **A** (at the metal elbow), then to the (+) terminal of the backup battery **B** or of the booster.
  - ▶ Connect one end of the green or black cable to the (-) terminal of the backup battery **B** or of the booster (or to an earth point on the assisting vehicle).
  - ▶ Connect the other end of the green or black cable to the earth point **C**.
  - ▶ Start the engine on the assisting vehicle and leave it running for a few minutes.
  - ▶ Operate the starter on the broken down vehicle and let the engine run.
- If the engine does not start immediately, switch off the ignition and wait a few moments before trying again.
- ▶ Wait for it to return to idle.
  - ▶ Disconnect the jump leads **in reverse order**.

- ▶ Refit the plastic cover to the (+) terminal, if the vehicle has one.
- ▶ Allow the engine to run for at least 30 minutes, with the vehicle stationary, so that the battery reaches an adequate state of charge.

**!** Driving immediately without having reached a sufficient level of charge may affect some of the vehicle's functionalities.

**!** With an automatic gearbox, never try to start the engine by pushing the vehicle.

## Charging the battery using a battery charger

For optimum service life of the battery, it is essential to maintain an adequate state of charge.

In some circumstances, it may be necessary to charge the battery:

- using the vehicle mainly for short journeys;
- if the vehicle is to be taken off the road for several weeks.

Contact a PEUGEOT dealer or a qualified workshop.

**!** To charge the vehicle's battery yourself, use only a charger compatible with lead-acid batteries with a nominal voltage of 12 V.

**!** Follow the instructions provided by the manufacturer of the charger. Never reverse polarities.

**i** It is not necessary to disconnect the battery.

- ▶ Switch off the ignition.
- ▶ Switch off all electrical consumers (audio system, lighting, wipers, etc.).

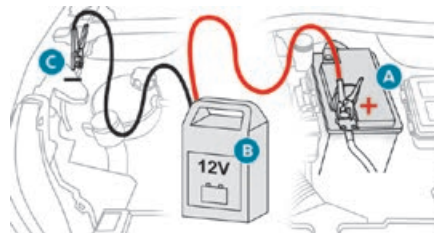

- ▶ Switch off charger **B** before connecting the cables to the battery, so as to avoid any dangerous sparks.
- ▶ Ensure that the charger cables are in good condition.
- ▶ Lift the plastic cover on the (+) terminal, if the vehicle has one.
- ▶ Connect the cables of charger **B** as follows:
  - the positive (+) red cable to the (+) terminal of battery **A**,
  - the negative (-) black cable to earth point **C** on the vehicle.

- ▶ At the end of the charging operation, switch off charger **B** before disconnecting the cables from battery **A**.

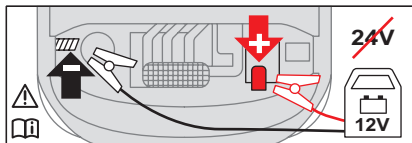

**!** If this label is present, use only a 12 V charger to avoid causing irreversible damage to the electrical components related to the Stop & Start system.

**!** Never try to charge a frozen battery - risk of explosion!

If the battery has frozen, have it checked by a PEUGEOT dealer or by a qualified workshop who will verify that the internal components have not been damaged and that the case has not cracked, which would mean a risk of toxic and corrosive acid leaking.

## Disconnecting the battery

In order to maintain an adequate state of charge for starting the engine, it is recommended that the battery be disconnected if the vehicle is taken out of service for a long period.

Before disconnecting the battery:

- ▶ Close all openings (doors, boot, windows, roof).

- ▶ Switch off all electrical consumers (audio system, wipers, lighting, etc.).
- ▶ Switch off the ignition and wait for 4 minutes. At the battery, it is only necessary to disconnect the (+) terminal.

### Quick-release terminal clamp

#### Disconnecting the (+) terminal

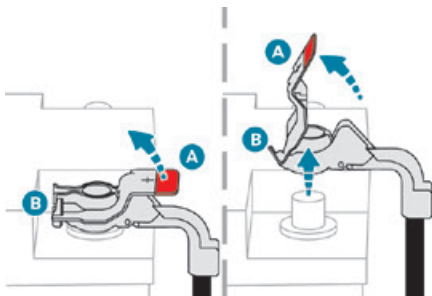

- ▶ Depending on equipment, lift the plastic cover on the (+) terminal.
- ▶ Raise lever **A** fully to release clamp **B**.
- ▶ Remove clamp **B** by lifting it off.

#### Reconnecting the (+) terminal

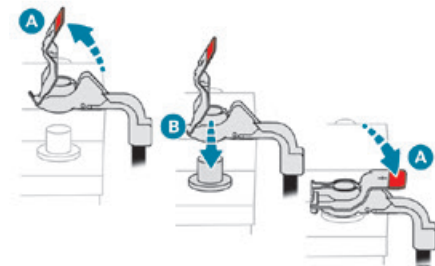

- ▶ Raise lever **A** fully.
- ▶ Refit the open clamp **B** on the (+) terminal.
- ▶ Push clamp **B** fully down.
- ▶ Lower lever **A** to lock clamp **B**.
- ▶ Depending on equipment, lower the plastic cover on the (+) terminal.

**!** Do not force the lever as locking will be impossible if the clamp is not positioned correctly; start the procedure again.

#### After reconnection

After reconnecting the battery, turn on the ignition and wait 1 minute before starting the engine, to enable the electronic systems to initialise.

If minor problems nevertheless persist following this operation, contact a PEUGEOT dealer or a qualified workshop.

Referring to the relevant section, reset certain equipment:

- Remote control key or electronic key (depending on version).
- Sunroof and electric sun blind.
- Electric windows.
- Date and time.
- Preset radio stations.

**i** The Stop & Start system may not be operational during the trip following the first engine start.

In this case, the system will only be available again after a continuous period with the vehicle immobilised, the duration of which depends on the exterior temperature and the state of charge of the battery (up to about 8 hours).

## Towing the vehicle

### **i** General recommendations

Observe the legislation in force in the country where you are driving. Ensure that the weight of the towing vehicle is higher than that of the towed vehicle.

The driver must remain at the wheel of the towed vehicle and must have a valid driving licence.

When towing a vehicle with all four wheels on the ground, always use an approved towing arm; rope and straps are prohibited.

The towing vehicle must move off gently.

When the vehicle is towed with its engine off, there is no longer braking and steering assistance.

### **!** A professional towing service must be called if:

- Broken down on a motorway or main road.









- Not possible to put the gearbox into neutral, unlock the steering, or release the parking brake.

- Not possible to tow a vehicle with an automatic gearbox, with the engine running.
- Towing with only two wheels on the ground.
- Four-wheel drive vehicle.
- No approved towbar available.

**!** Before towing the vehicle, it is essential to put the vehicle in free-wheeling mode. For more information on **Changing to free-wheeling**, refer to the corresponding section.

### **i** Electric motor

An electric vehicle must never be used for road transfers. It may be used, for example, to exit a rut.

Type of vehicle (engine / gearbox)gearbox	Towing constraints			
	Font wheels on the ground	Rear wheels on the ground	Flatbed	4 wheels on the ground with towbar
Internal combustion / Manual				
Internal combustion / Automatic				

	Towing constraints			
Type of vehicle (engine / gearbox)gearbox	Font wheels on the ground	Rear wheels on the ground	Flatbed	4 wheels on the ground with towbar
Electric	❌	✅	✅	❌

**i** In case of battery or electric parking brake failure, it is essential to call a professional using flatbed recovery vehicles (excluding manual gearbox).

## Access to the tools

For more information on accessing the **Tool kit**, refer to the corresponding section.

## Towing your vehicle

To access the front screw thread:

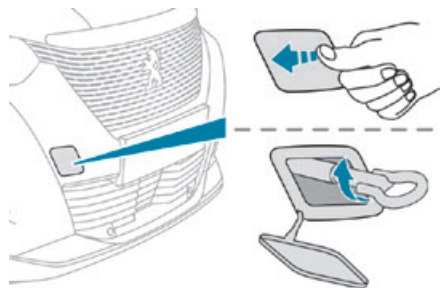

- ▶ Unclip the cover by pressing at its left-hand section.
- ▶ Release the cover to the right and then downwards.

To be towed:

- ▶ Screw the towing eye in fully.
- ▶ Install the towbar.
- ▶ Put the gearbox into neutral.

**!** Failure to observe this instruction could result in damage to certain components (braking, transmission, etc.) and to the absence of braking assistance the next time the engine is started.

**!** Automatic gearbox: never tow the vehicle with the driving wheels on the ground and the engine off.

- ▶ Unlock the steering and release the parking brake.
- ▶ Switch on the hazard warning lamps on both vehicles.
- ▶ Move off gently, drive slowly and only for a short distance.

## Towing another vehicle

To access the rear screw thread:

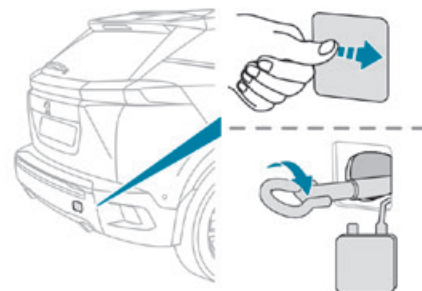

- ▶ Unclip the cover by pressing at its right-hand section.
  - ▶ Pull the cover downwards.
- To tow:
- ▶ Screw the towing eye in fully.
  - ▶ Install the towbar.
  - ▶ Switch on the hazard warning lamps on both vehicles.
  - ▶ Move off gently, drive slowly and only for a short distance.

## Engine technical data and towed loads

### Engines

The engine characteristics are given in the vehicle's registration document, as well as in sales brochures.

**i** The maximum power corresponds to the value type-approved on a test bed, under conditions defined in European legislation (Directive 1999/99/EC).

For more information, contact a PEUGEOT dealer or a qualified workshop.

### Weights and towed loads

The weights and towed loads relating to the vehicle are indicated on the registration document, as well as in sales brochures.

These values are also indicated on the manufacturer's plate or label.

For more information, contact a PEUGEOT dealer or a qualified workshop.

The GTW (Gross Train Weight) values and the towable loads listed are valid for a maximum altitude of 1,000 metres. The towable load must be reduced by steps of 10% for each additional 1,000 metres.

The maximum authorised nose weight corresponds to the weight permitted on the towball.

**!** When exterior temperatures are high, the vehicle performance may be limited in order to protect the engine. When the exterior temperature is higher than 37°C, reduce the towed weight.

**!** Towing even with a lightly loaded vehicle can adversely affect its road holding. Braking distances are increased when towing a trailer. When using a vehicle to tow, never exceed a speed of 62 mph (100 km/h) (observe the local legislation in force).

## Engines and towed loads - Petrol

<b>Engines</b>	<b>1.2 PureTech 100 S&amp;S</b>	<b>1.2 PureTech 130</b>	<b>1.2 PureTech 130 S&amp;S</b>	
<b>Gearboxes</b>	<b>BVM6 (Manual 6-speed)</b>	<b>EAT6 (Auto. 6-speed)</b>	<b>BVM6 (Manual 6-speed)</b>	<b>EAT8 (Auto. 8-speed)</b>
Codes	EB2ADTD MB6 STT	EB2ADTSM AT6III	EB2ADTS MB6 STT	EB2ADTS ATN8 STT
Model codes: UR...	HNKK	HNLW	HNSK	HNSS
Cubic capacity (cc)	1,199	1,199	1,199	1,199
Max. power: EC standard (kW)	75	96	96	96
Fuel	Unleaded	Unleaded	Unleaded	Unleaded
Braked trailer (within the GTW limit) (kg) on a 10% or 12% gradient	1,200	500	1,200	1,200
Unbraked trailer (kg)	630	500	633	640
Maximum authorised nose weight (kg)	48	48	48	48



<b>Engines</b>	<b>1.2 PureTech 155</b>	<b>1.2 PureTech 155 S&amp;S</b>	<b>1.5 VTi 115</b>
<b>Gearboxes</b>	<b>EAT8 (Auto. 8-speed)</b>	<b>EAT8 (Auto. 8-speed)</b>	<b>EAT6 (Auto. 6-speed)</b>
Codes	EB2ADTXM ATN8	EB2ADTX ATN8 STT	EC5F AT6III
Model codes: UR... UX...	HNJP	HNNS	NFJW
Cubic capacity (cc)	1,199	1,199	1,498
Max. power: EC standard (kW)	115	115	84
Fuel	Unleaded	Unleaded	Unleaded
Braked trailer (within the GTW limit) (kg) on a 10% or 12% gradient	500	1,200	500
Unbraked trailer (kg)	500	640	500
Maximum authorised nose weight (kg)	48	48	48

## Engines and towed loads - Diesel

<b>Engines</b>	<b>1.5 BlueHDi 100 S&amp;S</b>	<b>1.5 BlueHDi 130 S&amp;S</b>
<b>Gearboxes</b>	<b>BVM6 (Manual 6-speed)</b>	<b>EAT8 (Auto. 8-speed)</b>
Codes	DV5RD MB6 STT	DV5RC ATN8 STT
Model codes: UC...	YHYJ	YHZR
Cubic capacity (cc)	1,499	1,499
Max. power: EC standard (kW)	75	96
Fuel	Diesel	Diesel
Braked trailer (within the GTW limit) (kg) on a 10% or 12% gradient	1,200	1,200
Unbraked trailer (kg)	640	640
Maximum authorised nose weight (kg)	48	48

## Electric motor

Model codes: UJ...	ZKXZ
Braked trailer (within the GTW limit) (kg) on a 10% or 12% gradient	0
Unbraked trailer (kg)	0
Maximum authorised nose weight (kg)	0
<b>Electric motor</b>	
Technology	Synchronous with permanent magnets
Max. power : EC standard (kW)/(hp)	100 / 136
<b>Traction battery</b>	
Technology	Lithium-Ion
Installed capacity (kWh)	50
<b>Domestic charging</b>	
Alternating current voltage (Vac) Rating (A)	230 (single-phase) 8 or 16
<b>Accelerated charging</b>	
Alternating current voltage (Vac) Rating (A)	230 (single-phase or three-phase) 16 or 32
<b>Fast charging</b>	
Direct current voltage (Vdc)	400

## Dimensions (mm)

These dimensions have been measured on an unladen vehicle.

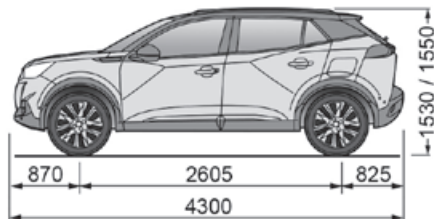
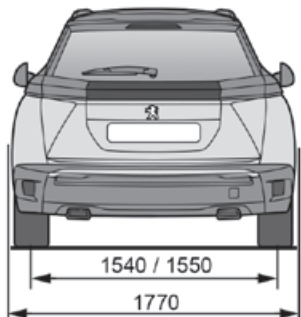
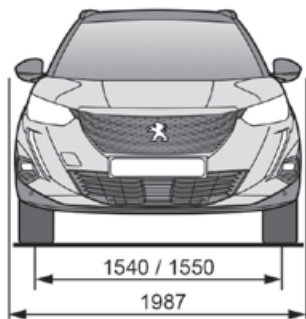

## Identification markings

Various visible markings for the identification and research of your vehicle.

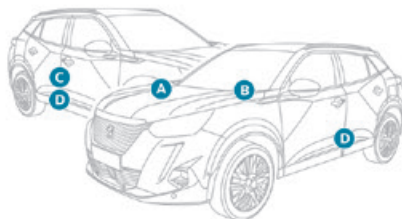

### A. Vehicle identification number (VIN), under the bonnet.

Stamped on the chassis.

### B. Vehicle identification number (VIN), on the dashboard.

On a label, visible through the windscreen.

### C. Manufacturer's label.

Fixed at the right-hand door.

Bears the following information:

- Manufacturer's name.

– European whole vehicle type approval number.

– Vehicle identification number (VIN).

– Gross vehicle weight (GVW).

– Gross train weight (GTW).

– Maximum weight on the front axle.

– Maximum weight on the rear axle.

### D. Tyres / paint code label.

Fixed at the driver-side door.

Bears the following information about the tyres:

– tyre pressures, unladen and laden.

– tyre specification, made up of the dimensions and type as well as the load and speed indices.

– spare tyre inflation pressure.

Also indicates the paint colour code.

**i** The vehicle may be originally equipped with tyres with higher load and speed indices than those indicated on the label, without affecting tyre pressure (on cold tyres).

## PEUGEOT Connect Radio



### Multimedia audio system - Applications - Bluetooth® telephone

**i** The functions and settings described vary according to the vehicle version and configuration, as well as the country of sale.

**!** For safety reasons and because they require sustained attention by the driver, the following operations must be carried out with the **vehicle stationary** and the ignition on:

- Pairing the smartphone with the system via Bluetooth.
- Using the smartphone.
- Connection to the CarPlay®, MirrorLink™ or Android Auto applications (certain

applications interrupt their display while the vehicle is moving).

- Changing the system settings and configuration.

**i** The system is protected so that it only operates in the vehicle.

The message **Energy Economy Mode** is displayed when the system is about to enter the corresponding mode.

**i** The system's Open Source Software (OSS) source codes are available at the following addresses:

<https://www.groupe-psa.com/fr/oss/>  
<https://www.groupe-psa.com/en/oss/>

### First steps



With the engine running, a press mutes the sound.

With the ignition off, a press turns the system on. Increase or decrease the volume using the wheel or the "plus" or "minus" buttons (depending on the equipment). Use the buttons on either side of or below the touch screen to access the menus, then press the virtual buttons on the touch screen. Depending on the model, use the "Source" and "Menu" buttons on the left of the touch screen to access the menus, then press the virtual buttons on the touch screen.

At all times it is possible to display the rolling menus by pressing the screen briefly with three fingers.

All touch-sensitive areas on the screen are white.

On pages with multiple tabs at the bottom of the screen, you can switch between pages either by tapping the tab for the desired page or by swiping the pages to the left or right with your finger.

Press in the shaded area to go back up a level or confirm.

Press the back arrow to go back a level or confirm.



The touch screen is of the "capacitive" type.

To clean the screen, use a soft, non-abrasive cloth (e.g. spectacles cloth) with no additional product.

Do not use sharp objects on the screen.  
Do not touch the screen with wet hands.

Certain information is displayed permanently in the upper bar of the touch screen:

- Air conditioning status information (depending on version), and direct access to the corresponding menu.
- Radio Media and Telephone menu status information.
- Privacy status information.
- Access to the touch screen and digital instrument panel settings.

Audio source selection (depending on equipment):

- FM/DAB/AM radio stations (depending on equipment).
- Telephone connected via Bluetooth and Bluetooth multimedia broadcast (streaming).
- USB Memory stick.
- Media player connected via the auxiliary socket (depending on equipment).

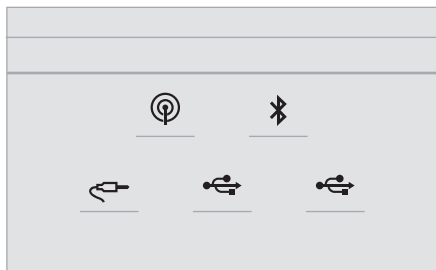

**i** In the "Settings" menu, it is possible to create a profile for an individual or for a group of people with shared interests, and configure a wide range of settings (radio presets, audio settings, ambiances, etc.). Settings are applied automatically.

**i** In very hot conditions, the volume may be limited to protect the system. It may

enter standby mode (with the screen and sound off) for 5 minutes or more. The system will resume normal operation when the temperature in the passenger compartment has dropped.

## Steering mounted controls

### Steering mounted controls - Type 1



**Radio:**  
Select the previous/next preset radio station.

Select the previous/next item in a menu or a list.

**Media:**  
Select the previous/next track.  
Select the previous/next item in a menu or a list.



**Radio:**  
Short press: display the list of radio stations.

Long press: update the list.

**Media:**  
Short press: display the list of folders.  
Long press: display the available sorting options.



Change audio source (radio; USB; AUX if equipment connected; CD; streaming).



Confirm a selection.



Increase volume.



Decrease volume.



Mute/restore sound by simultaneously pressing the increase and decrease volume buttons.

### Steering mounted controls - Type 2



**Voice commands:**  
This control is located on the steering wheel or at the end of the lighting control stalk (depending on equipment).  
Short press, smartphone voice commands via the system.



Increase volume.



Decrease volume.

Mute by pressing the volume increase and decrease buttons simultaneously (depending on equipment).

Restore the sound by pressing one of the two volume buttons.



**Media** (short press): change the multimedia source.



**Telephone** (short press): start telephone call.

**Call in progress** (short press): access telephone menu.

**Telephone** (long press): reject an incoming call, end call; when no call is in progress, access telephone menu.

 **Radio** (rotate): automatic search for the previous/next station.

**Media** (rotate): previous/next track, move in a list.

**Short press**: confirm a selection; if nothing selected, access to presets.

 **Radio**: display the list of stations.  
**Media**: display the list of tracks.

**Radio** (press and hold): update the list of stations received.

## Menus

## Applications



 Access configurable equipment.

## Radio Media

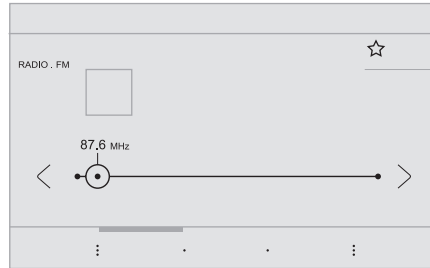

 Select an audio source or radio station.

## Telephone



 Connect a mobile phone via Bluetooth®.  
 Run certain applications on a smartphone connected via MirrorLink™, CarPlay® or Android Auto.

## Settings

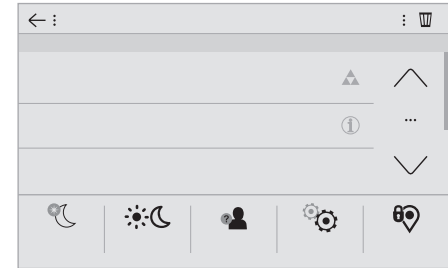

 Configure a personal profile and/or configure the sound (balance, ambience, etc.) and the display (language, units, date, time, etc.).

## Driving



 Activate, deactivate or configure certain vehicle functions.

## Navigation

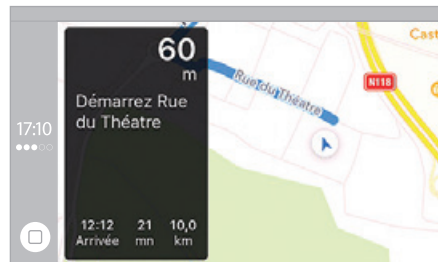

 Configure the navigation and select your destination via MirrorLink™, CarPlay® or Android Auto.

## Air conditioning

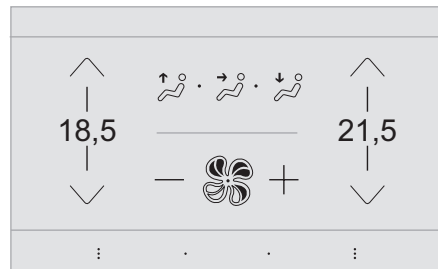

 Manage various temperature and air flow settings.







## Applications

### Viewing photos





Insert a USB memory stick in the USB port.

 To protect the system, do not use a USB hub.

The system can read folders and image files in the formats: .tiff; .gif; .jpg/jpeg; .bmp and .png.

-  Press **Applications** to display the main page.
-  Press **"Photos"**.
-  Select a folder.
-  Select an image to view.
-  Press this button to display the details of the photo.
-  Press the back arrow to go back a level.





### Managing messages

-  Press **Applications** to display the main page.
-  Press **"SMS"**.
-  Select the **"SMS"** tab.
-  Press this button to select the display settings for messages.

-  Press this button to search and select a recipient.
-  Select the **"Quick messages"** tab.
-  Press this button to select the display settings for messages.
-  Press this button to write a new message.
-  Press the bin alongside the selected message to delete it.
-  Press this button alongside the selected message to display the secondary page.
-  Press this button to edit and modify the existing text.
-  Press this button to write a new message.
-  Press the bin to delete the message.

## Radio

### Selecting a station

-  Press **Radio Media** to display the main page.
-  Press one of the buttons to perform an automatic search for radio stations.
- Or
-  Move the slider to manually search for frequencies up or down.
- Or
-  Press the frequency.





Enter the FM and AM waveband values using the virtual keypad.

OK

Press "OK" to confirm.



Radio reception may be affected by the use of electrical equipment not approved by the Brand, such as a USB charger connected to the 12 V socket. The exterior environment (hills, buildings, tunnels, basement car parks, etc.) may block reception, including in RDS mode. This phenomenon is perfectly normal in the context of radio wave transmission, and in no way indicative of an audio system malfunction.

## Changing the waveband



Press **Radio Media** to display the main page.

Press the "**OPTIONS**" button to access the secondary page.



Press "**Band**" to change waveband.



Press in the shaded area to confirm.

## Presetting a station

Select a radio station or frequency.



Make a short press on the star outline. If the star is solid, the radio station is already preset.

Or

Select a radio station or frequency.

Press "**Preset**".



Make a long press on one of the buttons to preset the station.

## Activating/Deactivating RDS

RDS, if activated, allows you to continue listening to the same station by automatically retuning to alternative frequencies.



Press **Radio Media** to display the main page.

Press the "**OPTIONS**" button to access the secondary page.



Activate/deactivate "**RDS**".



Press in the shaded area to confirm.



RDS station tracking may not be available nationwide, as many radio stations do not cover 100 % of the country. This explains the loss of reception of the station during a journey.

## Displaying text information

The "Radio Text" function displays information transmitted by the radio station relating to the station or the currently playing song.



Press **Radio Media** to display the main page.

Press the "**OPTIONS**" button to access the secondary page.



Activate/deactivate "**News**".



Press in the shaded area to confirm.

## Playing TA messages

The TA (Traffic Announcement) function gives priority to TA alert messages. To operate, this function needs good reception of a radio station that transmits this type of message. While traffic information is being broadcast, the current media is automatically interrupted so that the TA message can be heard. Normal play of the previously playing media resumes at the end of the message.



Press **Radio Media** to display the main page.

Press the "**OPTIONS**" button to access the secondary page.



Activate/deactivate "**TA**".



Press in the shaded area to confirm.

## Audio settings



Press **Radio Media** to display the main page.

Press the "**OPTIONS**" button to access the secondary page.



Press "**Audio settings**".



Select the "**Tone**", "**Balance**", "**Sound**", "**Voice**" or "**Ringtones**" tab to configure the sound settings.



Press the back arrow to confirm.

In the "**Tone**" tab, the **Ambience**, **Bass**, **Medium** and **Treble** sound settings are different and independent for each audio source.

In the "**Balance**" tab, the **All passengers**, **Driver** and **Front only** settings are common to all sources.

In the "**Sound**" tab, activate or deactivate "**Volume linked to speed**", "**Auxiliary input**" and "**Touch tones**".

The balance/distribution (or spatialisation with the Arkamys® system) uses audio processing to adjust the sound quality according to the number of passengers in the vehicle.

Onboard audio: Arkamys Sound Staging® optimises the sound distribution inside the passenger compartment.

## DAB (Digital Audio Broadcasting) radio

### Terrestrial Digital Radio

Digital radio provides higher quality sound. The various "multiplexes/ensembles" offer a choice of radio stations organised in alphabetical order.



Press **Radio Media** to display the main page.

Press the "**OPTIONS**" button to access the secondary page.



Press "**Band**" to select "**DAB band**".



Press in the shaded area to confirm.

### FM-DAB Follow-up

"DAB" does not cover 100 % of the country. When the digital radio signal is poor, the "FM-DAB Follow-up" enables you to continue listening to the same station by automatically switching to the corresponding "FM" analogue station (if there is one).



Press **Radio Media** to display the main page.

Press the "**OPTIONS**" button to access the secondary page.



Activate/deactivate "**FM-DAB Follow-up**".



Press in the shaded area to confirm.

If "FM-DAB Follow-up" is activated, there may be a time offset of a few seconds when the system switches to "FM" analogue radio, and in some cases a change in volume. When the digital signal quality is restored, the system automatically changes back to "DAB".

If the "DAB" station being listened to is not available on "FM", or if "FM-DAB Follow-up" is not activated, the sound will cut out while the digital signal is too weak.

## Media

### USB port



Insert the USB memory stick into the USB port or connect the USB device to the USB port using a suitable cable (not supplied).

To protect the system, do not use a USB hub.

The system builds playlists (in temporary memory); this operation can take from a few seconds to several minutes at the first connection.

Reduce the number of non-music files and the number of folders to reduce the waiting time.

Playlists are updated whenever the ignition is switched off or a USB memory stick is connected. The audio system memorises these lists, which will subsequently load faster if they have not been changed.

## Auxiliary (AUX) jack socket

Depending on equipment



Connect a portable device (MP3 player, etc.) to the auxiliary jack socket using an audio cable (not supplied).

This source is only available if "Auxiliary input" has been selected in the audio settings.

First adjust the volume on the portable device (to a high level). Then adjust the volume of the audio system.

Controls are managed via the portable device.

## Selecting the source



Press **Radio Media** to display the main page.

Press the **"SOURCES"** button.  
Select the source.

## BluetoothStreaming®

Streaming allows you to listen to the audio feed from your smartphone.

The Bluetooth profile must be activated.

First adjust the volume on the portable device (to a high level). Then adjust the volume of the system.

If play does not start automatically, it may be necessary to start the audio playback from the smartphone.

Control is from the portable device or by using the system's touch buttons.

**i** Once connected in Streaming mode, the smartphone is considered to be a media source.

## Connecting Apple® players

Connect the Apple® player to the USB socket using a suitable cable (not supplied).

Play starts automatically.

Control is via the audio system.

**i** The classifications available are those of the portable device connected (artists/albums/genres/playlists/audio books/podcasts). It is also possible to use a classification structured in the form of a library.

The default classification used is by artist. To modify the classification used, return to the first level of the menu then select the desired classification (playlists for example) and confirm to go down through the menu to the desired track.

The version of software in the audio system may not be compatible with the generation of the Apple® player.

## Information and advice

The system supports USB mass storage devices, BlackBerry® devices or Apple® players via the USB ports. The adapter cable is not supplied.

Devices are managed using the audio system controls.

Other devices, not recognised on connection, must be connected to the auxiliary socket using a jack cable (not supplied) or via Bluetooth streaming, if compatible.



To protect the system, do not use a USB hub.

The audio system will only play audio files with ".wav", ".wma", ".aac", ".ogg" and ".mp3" file extensions, at bit rates between 32 Kbps and 320 Kbps.

It also supports VBR (Variable Bit Rate) mode. No other file types (".mp4", etc.) can be read. All ".wma" files must be standard WMA 9 files.

The supported sampling rates are 11, 22, 44 and 48 KHz.

To avoid reading and display problems, we recommend choosing file names less than 20 characters long that do not contain any special characters (e.g. " ? ; ù).

Use only USB memory sticks in FAT32 format (File Allocation Table).



We recommend using the original USB cable for the portable device.

## Telephone

### USB sockets

Depending on equipment, for more information on the USB sockets compatible with the **CarPlay**®, **MirrorLink**™ or **Android Auto** applications, refer to the "Ease of use and comfort" section.

**i** The synchronisation of a smartphone allows users to display applications adapted to the CarPlay®, MirrorLink™ or Android Auto technology of the smartphone on the vehicle screen. For the CarPlay® technology, the CarPlay® function must be activated on the smartphone beforehand. For the communication process between the smartphone and the system to work, it is essential in all cases that the smartphone is unlocked.

As the principles and standards are constantly changing, **it is recommended that you keep the smartphone's operating system up-to-date, as well as the date and time of the smartphone and of the system.**

For the list of eligible smartphones, go to the Brand's national website.

### MirrorLink™ smartphone connection

Depending on country.

**i** The "MirrorLink™" function requires a compatible smartphone and compatible applications.

### Telephone not connected by Bluetooth®



When connecting a smartphone to the system, we recommend enabling Bluetooth® on the smartphone.



Connect a USB cable. The smartphone charges when connected by a USB cable.



From the system, press "**Telephone**" to display the main page.



Press "**MirrorLink™**" to start the application in the system.

Depending on the smartphone, it may be necessary to activate the "**MirrorLink™**" function.



During the procedure, several screen pages relating to certain features are displayed.

Accept to start and complete the connection.

### Telephone connected by Bluetooth®



Connect a USB cable. The smartphone charges when connected by a USB cable.



From the system, press "**Telephone**" to display the main page.

Press the "**PHONE**" button to display the secondary page.



Press "**MirrorLink™**" to start the application in the system.

Once the connection is established, a page is displayed, showing the applications already downloaded to the smartphone that are compatible with MirrorLink™ technology. Access to the different audio sources remains available in the margin of the MirrorLink™ display, using the touch buttons located in the upper bar.

Access to the menus for the system is possible at any time using the dedicated buttons.

**i** There may be a pause before applications become available, depending on the quality of the network.

### CarPlay® smartphone connection

Depending on country.

**i** On connecting the USB cable, the CarPlay® function deactivates the system's Bluetooth® mode. The "**CarPlay**" function requires the use of a compatible smartphone and compatible applications.



Connect the USB cable. The smartphone charges when connected by the USB cable.



From the system, press **Telephone** to display the CarPlay® interface.

Or



If the smartphone has already connected by Bluetooth®.



Connect the USB cable. The smartphone charges when connected by the USB cable.



From the system, press **"Telephone"** to display the main page.

Press the **"PHONE"** button to go to the secondary page.



Press **"CarPlay"** to display the CarPlay® interface.



When the USB cable is disconnected and the ignition is switched off then back on, the system will not automatically switch to Radio Media mode; the source must be changed manually.



The CarPlay® navigation can be accessed at any time by pressing the system's

**Navigation** button.

## Android Auto smartphone connection

Depending on country.



On the smartphone, download the Android Auto application.



The "Android Auto" function requires the use of a compatible smartphone and applications.

### Telephone not connected by Bluetooth®



Connect a USB cable. The smartphone charges when connected by a USB cable.



From the system, press **"Telephone"** to display the main page.



Press **"Android Auto"** to start the application in the system.

Depending on the smartphone, it may be necessary to activate the **"Android Auto"** function.



During the procedure, several screen pages relating to certain features are displayed.

Accept to start and complete the connection.



When connecting a smartphone to the system, we recommend enabling Bluetooth® on the smartphone.

### Telephone connected by Bluetooth®



From the system, press **"Telephone"** to display the main page.

Press the **"PHONE"** button to display the secondary page.



Press **"Android Auto"** to start the application in the system.

Access to the different audio sources remains available in the margin of the Android Auto display, using the touch buttons located in the upper bar.

Access to the menus for the system is possible at any time using the dedicated buttons.



There may be a pause before applications become available, depending on the quality of the network.

## Pairing a Bluetooth® telephone



The services available depend on the network, the SIM card and the compatibility of the Bluetooth devices used. Consult the telephone user guide and the service provider to check which services are available.



The Bluetooth function must be activated and the telephone configured as "Visible to all" (in the telephone settings).

To complete the pairing, whichever procedure is used (from the telephone or from the system), ensure that the code is the same in the system and in the telephone.



If the pairing procedure fails, we recommend deactivating and then reactivating the Bluetooth function on the telephone.



### Procedure from the telephone



Select the name of the system in the list of detected devices.

In the system, accept the connection request from the telephone.

### Procedure from the system

-  Press **Telephone** to display the main page.
-  Press **"Bluetooth search"**.  
The list of detected telephones is displayed.
-  Select the name of the chosen telephone in the list.

### Connection sharing

The system offers to connect the telephone with 3 profiles:

- **"Telephone"** (hands-free kit, telephone only),
- **"Streaming"** (streaming: wireless playing of audio files on the telephone),
- **"Mobile internet data"**.

-  Select one or more profiles.
- OK** Press **"OK"** to confirm.

Depending on the type of telephone, you may be prompted to accept the transfer of contacts and messages.

**i** The ability of the system to connect just one profile depends on the telephone. All three profiles may connect by default.





**i** The profiles compatible with the system are: HFP, OPP, PBAP, A2DP, AVRCP, MAP and PAN.

Visit the Brand's website for more information (compatibility, additional help, etc.).

### Automatic reconnection

On returning to the vehicle, if the last telephone connected is present again, it is automatically recognised and within about 30 seconds after switching on the ignition, the pairing is established automatically (Bluetooth activated).

#### To modify the connection profile:



-  Press **Telephone** to display the main page.
- Press the **"PHONE"** button to access the secondary page.
-  Press **"Bluetooth connection" to display the list of paired devices.**
-  Press the "Details" button for a paired device.
-  Select one or more profiles.
- OK** Press **"OK"** to confirm.

### Managing paired telephones



This function lets you connect or disconnect a device or delete a pairing.

-  Press **Telephone** to display the main page.

Press the **"PHONE"** button to access the secondary page.





-  Press **"Bluetooth connection" to display the list of paired devices.**
-  Press on the name of the telephone selected in the list to disconnect it. Press again to connect it.

### Deleting a telephone

-  Press the basket at the top right of the screen to display a basket alongside the telephone chosen.
-  Press the basket alongside the telephone chosen to delete it.

### Receiving a call

An incoming call is announced by a ring and a superimposed display in the screen.

-  Make a short press on the steering mounted **PHONE** button to accept an incoming call.
- And
-  Make a long press
-  on the steering mounted **PHONE** button to reject the call.
- Or
-  Press **"End call"**.

## Making a call

**!** Using the telephone is not recommended while driving.  
Parking the vehicle.  
Make the call using the steering mounted controls.

### Calling a new number



Press **Telephone** to display the main page.



Enter the phone number using the digital keypad.



Press "**Call**" to start the call.

### Calling a contact



Press **Telephone** to display the main page.



Or press and hold



the steering mounted **PHONE** button.

Press "**Contacts**".

Select the desired contact from the displayed list.



Press "**Call**".

### Calling a recently used number



Press **Telephone** to display the main page.

Or



Press and hold



the steering mounted button.

Press "**Recent calls**".

Select the desired contact from the displayed list.



It is always possible to make a call directly from the telephone; as a safety measure, first park the vehicle.

## Setting the ringtone



Press **Telephone** to display the main page.

Press the "**OPTIONS**" button to access the secondary page.



Press "**Ring volume**" to display the volume bar.



Press the arrows or move the slider to set the ring volume.

## Settings

### Configuring profiles



Press **Settings** to display the main page.



Press "**Profiles**".

Select "**Profile 1**", "**Profile 2**", "**Profile 3**" or "**Common profile**".



Press this button to enter a name for the profile using the virtual keypad.



Press "**OK**" to save.



Press the back arrow to confirm.



Press this button to activate the profile.



Press the back arrow again to confirm.



Press this button to reset the selected profile.

## Adjusting the brightness



Press **Settings** to display the main page.



Press **Brightness**.



Move the slider to adjust the brightness of the screen and/or the instrument panel (depending on version).



Press in the shaded area to confirm.

## Modifying system settings



Press **Settings** to display the main page.



Press "**Configuration**" to access the secondary page.



Press "**System configuration**".



Press the "**Units**" tab to change the units of distance, fuel consumption and temperature.





Press the **"Factory settings"** tab to restore the initial settings.

**!** Returning the system to factory settings activates the English language by default (depending on version).

Press the **"System info"** tab to display the versions of the various modules installed in the system.



Press the **"Privacy"** tab,  
or

-  Press **Settings** to display the main page.
-  Press **"Privacy"** to activate or deactivate the private data mode.
-  Activate or deactivate:
  - **"No sharing (data, vehicle position)"**.
  - **"Only data sharing"**
  - **"Data and vehicle position sharing"**

-  Press the back arrow to confirm.
-  Press **Settings** to display the main page.
-  Press **"Configuration"** to access the secondary page.
-  Press **"Screen configuration"**.





Press **"Brightness"**.  
 Move the slider to adjust the brightness of the screen and/or the instrument panel (depending on version).

 Press the back arrow to confirm.





- Press **"Animation"**.
  -  Activate or deactivate: **"Automatic scrolling"**.
  -  Select **"Animated transitions"**.

 Press the back arrow to confirm.





## Selecting the language

-  Press **Settings** to display the main page.
-  Press **"Configuration"** to access the secondary page.
-  Select **"Language"** to change the language.
-  Press the back arrow to confirm.

## Setting the time







-  Press **Settings** to display the main page.
-  Press **"Configuration"** to access the secondary page.
-  Press **"Date and time"**.
- Select **"Time"**.
  -  Press this button to set the time using the virtual keypad.
  -  Press **"OK"** to save the time.

 Press this button to set the time zone.

-  Select the display format for the time (12h/24h).
-  Activate or deactivate summer time (+1 hour).
-  Activate or deactivate GPS synchronisation (UTC).
-  Press the back arrow to save the settings.

**i** The system may not automatically manage the change between winter and summer time (depending on the country of sale).

## Setting the date

-  Press **Settings** to display the main page.
-  Press **"Configuration"** to access the secondary page.
-  Press **"Date and time"**.
- Select **"Date"**.
  -  Press this button to set the date.
  -  Press the back arrow to save the date.
  -  Select the display format for the date.
  -  Press the back arrow again to confirm.



**i** Time and date setting is only available if "GPS Synchronisation:" is deactivated.

## Frequently asked questions

The following information groups together the answers to the most frequently asked questions concerning the system.

### Radio

**The reception quality of the tuned radio station gradually deteriorates or the station presets are not working (no sound, 87.5 MHz is displayed, etc.).**

The vehicle is too far from the selected station's transmitter, or no transmitter is present in the geographical area.

► Activate the "RDS" function in the upper bar to enable the system to check whether there is a more powerful transmitter in the geographical area.

The environment (hills, buildings, tunnels, basement car parks, etc.) is blocking reception, including in RDS mode.

This is a perfectly normal phenomenon, and is not indicative of an audio system malfunction. The aerial is missing or has been damaged (for example while entering a car wash or underground car park).

► Have the aerial checked by a dealer.

**I cannot find some radio stations in the list of received stations.**

**The name of the radio station changes.**

The station is no longer received or its name has changed in the list.

► Press the round arrow on the "List" tab on the "Radio" page.

Some radio stations send other information in place of their name (the title of the song for example).

The system interprets these details as the station name.

► Press the round arrow on the "List" tab on the "Radio" page.

### Media

**Playback of my USB memory stick starts only after a very long wait (around 2 to 3 minutes).**

Some files supplied with the memory stick may greatly slow down access to reading the memory stick (multiplication by 10 of the cataloguing time).

► Delete the files supplied with the memory stick and limit the number of sub-folders in the file structure on the memory stick.

**Some characters in information about the currently playing media are not displayed correctly.**

The audio system is unable to process certain types of character.

► Use standard characters to name tracks and folders.

**Playback of streaming files does not start.**

The connected device does not automatically launch playback.

► Start playback from the device.

**Track names and playing times are not displayed on the audio streaming screen.**

The Bluetooth profile does not allow the transfer of this information.

### Telephone

**I cannot connect my Bluetooth telephone.**

The telephone's Bluetooth function may be switched off or the device may not be visible.

► Check that the telephone has Bluetooth switched on.

► Check in the telephone settings that it is "visible to all".

The Bluetooth telephone is not compatible with the system.

► Check the compatibility of the telephone on the Brand's website (services).

**Android Auto and/or CarPlay do not work.**

Android Auto and CarPlay may not activate if the USB cables are of poor quality.

► Use genuine USB cables to ensure compatibility.

**Android Auto and/or CarPlay do not work.**

Android Auto and CarPlay are not available in all countries.

► Check the Google Android Auto or Apple website to see which countries are supported.

**The volume of the telephone connected in Bluetooth mode is inaudible.**

The volume depends on both the system and the telephone.

► Increase the volume of the audio system, to maximum if required, and increase the volume of the telephone if necessary.

Ambient noise affects the quality of the telephone call.

► Reduce ambient noise (close windows, turn down ventilation, slow down, etc.).

**The contacts are not listed in alphabetical order.**

Some telephones offer display options.

Depending on the settings chosen, contacts can be transferred in a specific order.

► Modify the telephone directory display settings.

## Settings

**When the treble and bass settings are changed, the ambience is deselected.**

**When the ambience is changed, the treble and bass settings are reset.**

Selecting an ambience imposes the treble and bass settings, and vice versa.

► Modify the treble and bass or ambience settings to obtain the desired musical ambience.

**When the balance settings are changed, the distribution is deselected.**

**When the distribution setting is changed, the balance settings are deselected.**

Selecting a distribution setting imposes the balance settings, and vice versa.

► Modify the balance setting or the distribution setting to obtain the desired sound quality.

**There is a difference in sound quality between audio sources.**

To allow for optimal listening quality, the sound settings can be tailored to different audio sources, which can generate audible differences when changing source.

► Check that the sound settings are appropriate to the sources listened to. Adjust the sound functions to the middle position.

**When the engine is off, the system switches off after several minutes of use.**

When the engine is switched off, the system's operating time depends on the state of charge of the battery.

The switch-off is normal: the system automatically goes into energy economy mode and switches off to maintain an adequate charge in the battery.

► Start the vehicle's engine to increase the charge of the battery.

# PEUGEOT Connect Nav



## GPS navigation - Applications - Multimedia audio system - Bluetooth® telephone

**i** The functions and settings described vary according to the vehicle version and configuration, as well as the country of sale.

**!** For safety reasons and because they require sustained attention by the driver, the following operations must be carried out with the **vehicle stationary** and the ignition on:

- Pairing the smartphone with the system via Bluetooth.
- Using the smartphone.
- Connection to the CarPlay®, MirrorLink™ or Android Auto applications (certain

applications interrupt their display while the vehicle is moving).

- Watching a video (the video stops when the vehicle starts to move again).
- Changing the system settings and configuration.

**i** The system is protected so that it only operates in the vehicle.

The message **Energy Economy Mode** is displayed when the system is about to enter the corresponding mode.

**i** System and map updates can be downloaded from the Brand's website.

The update procedure is also available on the website.

**i** The system's Open Source Software (OSS) source codes are available at the following addresses:

<https://www.groupe-psa.com/fr/oss/>  
<https://www.groupe-psa.com/en/oss/>

## First steps



With the engine running, a press mutes the sound.

With the ignition off, a press turns the system on. Increase or decrease the volume using the wheel or the "plus" or "minus" buttons (depending on the equipment).

Use the menu buttons on either side of or below the touch screen for access to the menus, then press the virtual buttons in the touch screen. Depending on the model, use the "Source" or "Menu" buttons to access the rolling menus, then press the virtual buttons in the touch screen. Display the rolling menus at any time by pressing the screen briefly with three fingers. All of the touch areas of the screen are white. Press the back arrow to go back a level. Press "OK" to confirm.

**!** The touch screen is of the "capacitive" type.

To clean the screen, use a soft, non-abrasive cloth (e.g. spectacles cloth) with no additional product.

Do not use sharp objects on the screen. Do not touch the screen with wet hands.

Certain information is displayed permanently in the side bars or in the upper bar of the touch screen (depending on equipment):

- Air conditioning status information (depending on version), and direct access to the corresponding menu.
- Go directly to the audio source selection option, to view the list of radio stations (or list of titles depending on the source).
- Go to the "Notifications" of messages, emails, map updates and, depending on the services, the navigation notifications.
- Go to the settings for the touch screen and the digital instrument panel.

Audio source selection (depending on equipment):

- FM/DAB/AM radio stations (depending on equipment).
- Telephone connected via Bluetooth and Bluetooth multimedia broadcast (streaming).
- USB memory stick.
- Media player connected via the auxiliary socket (depending on equipment).
- Video (depending on equipment).

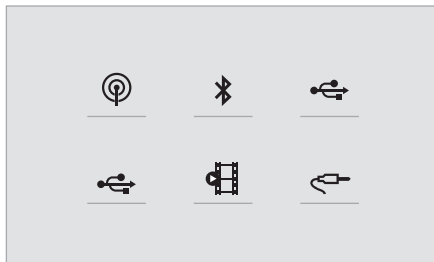

**I** In the "Settings" menu, it is possible to create a profile for an individual or for a group of people with shared interests, and configure a wide range of settings (radio presets, audio settings, navigation history, favourite contacts, etc.). Settings are applied automatically.

**I** In very hot conditions, the volume may be limited to protect the system. It may

enter standby mode (with the screen and sound off) for 5 minutes or more.

The system will resume normal operation when the temperature in the passenger compartment has dropped.

## Steering mounted controls



### Voice control:

This control is located on the steering wheel or at the end of the lighting control stalk (depending on equipment).

Short press, system voice control.

Long press, voice control for smartphone or CarPlay®, MirrorLink™ (availability depending on country), Android Auto via the system.



Increase volume.



Decrease volume.

Mute by pressing the volume increase and decrease buttons simultaneously (depending on equipment).

Restore the sound by pressing one of the two volume buttons.



**Media** (short press): change the multimedia source.



**Telephone** (short press): start telephone call.

**Call in progress** (short press): access telephone menu.

**Telephone** (long press): reject an incoming call, end call; when no call is in progress, access telephone menu.



**Radio** (rotate): automatic search for the previous / next station.

**Media** (rotate): previous / next track, move in a list.

**Short press**: confirm a selection; if nothing selected, access to presets.



**Radio**: display the list of stations.

**Media**: display the list of tracks.

**Radio** (press and hold): update the list of stations received.

## Menus

### Connected navigation



Enter navigation settings and choose a destination.

Use real-time services, depending on equipment.

## Applications



 Run certain applications from the smartphone connected via CarPlay®, MirrorLink™ or Android Auto. Check the status of the Bluetooth® and Wi-Fi connections.

## Radio Media

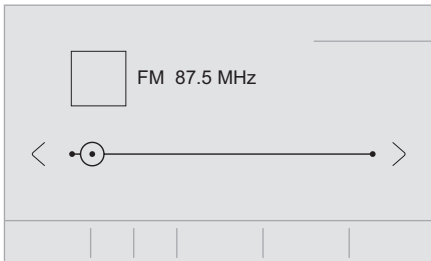

 Select an audio source or radio station, or display photographs.

## Telephone

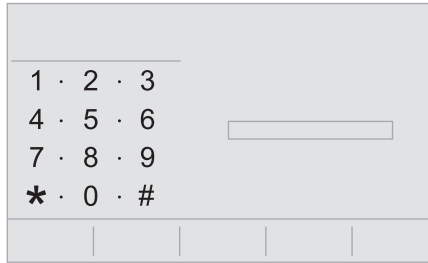

 Connect a telephone via Bluetooth®, read messages and emails and send quick messages.

## Settings

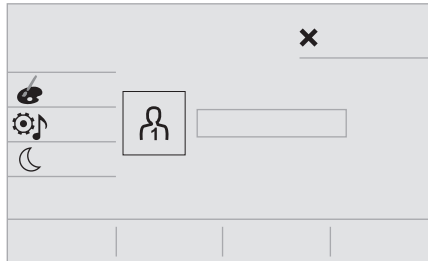

 Configure a personal profile and/or configure the sound (balance, ambience, etc.) and the display (language, units, date, time, etc.).

## Vehicle



 Activate, deactivate or configure certain vehicle functions.

## Air conditioning

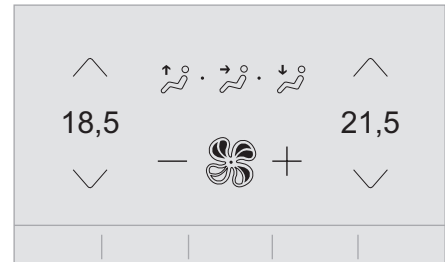

 Manage various temperature and air flow settings.

## Voice commands

### Steering wheel-mounted controls



#### Voice commands:

Voice commands can be issued from any screen page after a short press on the "Voice commands" button located on the steering wheel or at the end of the lighting control stalk (depending on equipment), as long as there is no telephone call in progress.



To ensure that voice commands are always recognised by the system, please follow these recommendations:

- **use natural language in a normal tone without breaking up words or raising your voice.**
- always wait for the "beep" (audible signal) before speaking.
- for best results, closing the windows and sunroof is recommended, to avoid extraneous interference (depending on version).
- before issuing a voice command, ask any other passengers to refrain from speaking.

### First steps



Example of a "voice command" for navigation:

**"Navigate to address 11 regent street, London"**

Example of a "voice command" for the radio and media:

**"Play artist Madonna"**

Example of a "voice command" for the telephone:

**"Call David Miller"**



The voice commands, with a choice of 17 languages (Arabic, Brazilian, Czech, Danish, Dutch, English, Farsi, French, German, Italian, Norwegian, Polish, Portuguese, Russian, Spanish, Swedish, Turkish), are made using the language previously chosen and set in the system. For some voice commands, there are alternative synonyms.

Example: Guide to / Navigate to / Go to / ...  
The voice commands in Arabic for: "Navigate to address" and "Display POI in the city", are not available.

### Information - Using the system



When voice commands are activated, by briefly pressing the button, help is displayed on the touch screen, offering various menus and enabling voice-based interaction with the system.

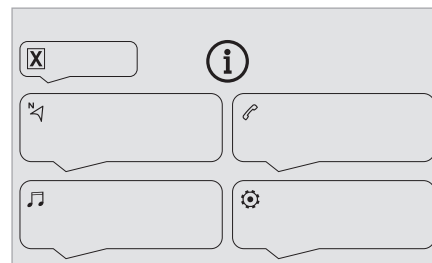

A number of commands are available when a menu is selected.

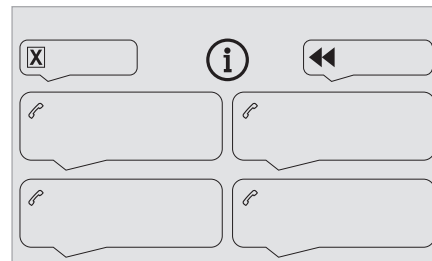

Press the Push To Talk button and tell me what you'd like after the tone. Remember you can interrupt me at any time by pressing this button. If you press it again while I'm waiting for you to speak, it'll end the conversation. If you need to start over, say "cancel". If you want to undo something, say "undo". And to get information and tips at any time, just say "help". If you ask to me do something and there's some information missing that I need, I'll give you some examples or take you through it step by

step. There's more information available in "novice" mode. You can set the dialogue mode to "expert" when you feel comfortable.

## Global voice commands



### Voice commands

**Set dialogue mode as novice - expert**  
**Select user 1 / Select profile John**  
**Increase temperature**  
**Decrease temperature**



### Help messages

There are lots of topics I can help you with. You can say: "help with phone", "help with navigation", "help with media" or "help with radio". For an overview on how to use voice controls, you can say "help with voice controls". Say "yes" if I got that right. Otherwise, say "no" and we'll start that again.

## "Navigation" voice commands



### Voice commands

**Navigate home**  
**Navigate to work**  
**Navigate to preferred address, Tennis club**  
**Navigate to contact, John Miller**  
**Navigate to address 11 regent street, London**



### Help messages

To plan a route, say "navigate to" followed by the address, the contact name or an intersection. For example, "navigate to address 11 Regent Street, London", "navigate to contact, John Miller", or "navigate to intersection of Regent Street, London". You can specify if it's a preferred address, or a Point of Interest. For example, say "navigate to preferred address, Tennis club", or "navigate to POI Heathrow Airport in London". Or, you can just say, "navigate home". To see Points of Interest on a map, you can say things like "show POI hotels in Banbury". For more information say "help with points of interest" or "help with route guidance".

To choose a destination, say something like "navigate to line three" or "select line two". If you can't find the destination but the street's right, say for example "select the street in line three". To move around a displayed list, you can say "next page" or "previous page". You can undo your last action and start over by saying "undo", or say "cancel" to cancel the current action.



### Voice commands

**Tell me the remaining distance**  
**Tell me the remaining time**  
**Tell me the arrival time**  
**Stop route guidance**



### Help messages

You can say "stop" or "resume route guidance". To get information about your current route, you can say "tell me the remaining time", "remaining

distance" or "arrival time". To learn more commands, try saying "help with navigation".



### Voice commands

**Show POI "hotel" at the destination**  
**Show nearby POI petrol station**  
**Navigate to POI Heathrow Airport in London**  
**Navigate to POI petrol station along the route**



### Help messages

To see points of interest on a map, you can say things like "show hotels in Banbury", "show nearby parking", "show hotel at the destination" or "show petrol station along the route". If you prefer to navigate directly to a point of interest, you can say "navigate to nearby petrol station". If you feel you are not being well understood, try to say the word "POI" in front of the point of interest. For example say "navigate to POI restaurant at the destination".

To choose a POI, say something like "select line 2". If you've searched for a Point of Interest and don't see the one you're after, you can filter further by saying something like "select POI in line 2", or "select the city in line 3". You can also scroll through the list by saying "next page" or "previous page".

**i** Depending on the country, give destination (address) instructions in the language configured for the system.

## "Radio Media" voice commands



### Voice commands

**Turn on source radio - Streaming Bluetooth**  
- ...



### Help messages

You can select an audio source by saying "turn on source" followed by the device name. For example, "turn on source, Streaming Bluetooth", or "turn on source, radio". Use the command "play" to specify the type of music you'd like to hear. You can choose between "song", "artist", or "album". Just say something like "play artist, Madonna", "play song, Hey Jude", or "play album, Thriller".



### Voice commands

**Tune to channel BBC Radio 2**  
**Tune to 98.5 FM**

**Tune to preset number five**



### Help messages

You can pick a radio station by saying "tune to" and the station name or frequency. For example "tune to channel Talksport" or "tune to 98.5 FM". To listen to a preset radio station, say for example "tune to preset number five".



### Voice commands

**What's playing?**



### Help messages

To choose what you'd like to play, start by saying "play" and then the item. For example, say "play song Hey Jude", "play line 3" or "select line 2". You can undo your last action and start over by saying "undo", or say "cancel" to cancel the current action.



### Voice commands

**Play song Hey Jude**

**Play artist Madonna**

**Play album Thriller**



### Help messages

I'm not sure what you'd like to play. Please say "play" and then a song title, an album title, or an artist name. For example, say "play song Hey Jude", "play artist Madonna" or "play album Thriller". To select a line number from the display, say "select line two". To move around a displayed list, you can say "next page" or "previous page". You can undo your last action and start over by saying "undo", or say "cancel" to cancel the current action.



Media voice commands are available only with a USB connection.

## "Telephone" voice commands



If there is no telephone connected by Bluetooth, a voice message announces: "Please first connect a telephone", and the voice session is closed.



### Voice commands

**Call David Miller\***

**Call voicemail\***

**Display calls\***



### Help messages

To make a phone call, say "call" followed by the contact name, for example: "Call David Miller". You can also include the phone type, for example: "Call David Miller at home". To make a call by number, say "dial" followed by the phone number, for example, "Dial 107776 835 417". You can check your voicemail by saying "call voicemail". To send a text, say "send quick message to", followed by the contact, and then the name of the quick message you'd like to send. For example, "send quick message to

\* This function is available only if the telephone connected to the system supports downloading of contacts and recent calls and the corresponding download has been performed.



David Miller, I'll be late". To display the list of calls, say "display calls". For more information on SMS, you can say "help with texting". To choose a contact, say something like "select line three". To move around the list say "next page" or "previous page". You can undo your last action and start over by saying "undo", or say "cancel" to cancel the current action.

## "Text message" voice commands

If there is no telephone connected by Bluetooth, a voice message announces: "Please first connect a telephone", and the voice session is closed.

The "Text messages" voice commands function allows you to dictate and send an SMS.

Dictate the text, taking care to pause briefly between each word.

When you have finished, the voice recognition system will automatically generate an SMS.



### Voice commands

Send quick message to Bill Carter, I'll be late



### Help messages

From the list of quick messages, say the name of the one you'd like to send. To move around the list you can say "go to start", "go to end", "next page" or "previous page". You can undo your last action and start over by saying "undo", or say "cancel" to cancel the current action.



### Voice commands

Send SMS to John Miller, I'm just arriving  
Send SMS to David Miller at the office, don't wait for me



### Help messages

Please say "call" or "send quick message to", and then select a line from the list. To move around a list shown on the display, you can say "go to start", "go to end", "next page" or "previous page". You can undo your last action and start over by saying "undo", or say "cancel" to cancel the current action.



### Voice commands

Listen to most recent message\*



### Help messages

To hear your last message, you can say "listen to most recent message". When you want to send a text, there's a set of quick messages ready for you to use. Just use the quick message name and say something like "send quick message to

Bill Carter, I'll be late". Check the phone menu for the names of the supported messages.

The system only sends pre-recorded "Quick messages".

## Navigation

### Choice of a destination

#### To a new destination

##### Intuitive method:



Press **Navigation** to display the main page.



Press **"Search..."**.



Enter an address or the key words for the destination.



Press **"OK"** to select the **"Guidance criteria"**.

Or

##### Guided method:

In order to be able to use the navigation, you must enter the **"City"**, the **"Street"** (suggestions are displayed automatically when you begin typing), then enter the **"Number"** using the virtual keypad, or select

\* This function is available only if the telephone connected to the system supports downloading of contacts and recent calls and the corresponding download has been performed.

an address from the **"Contact"** list or the address **"History"**.

**i** If you do not confirm the number, the navigation system will show one end of the street.

Press the **"MENU"** button to access the secondary page.



Select **"Enter address"**.

Then



Select the **"Country"**.



Select the keyboard "language".



Change the keyboard "type" according to the selected "language": ABCDE;

AZERTY; QWERTY or QWERTZ.



Enter the **"City"**, the **"Street"** and the **"Number"**, and confirm by pressing on the displayed suggestions.



Press **"OK"** to select the **"Guidance criteria"**.

And/or



Select **"See on map"** to choose the **"Guidance criteria"**.



Press **"OK"** to start guided navigation.

**i** Zoom in/out using the touch buttons or with two fingers on the screen.

## To a recent destination



Press **Navigation** to display the main page.

Press the **"MENU"** button to access the secondary page.



Select **"My destinations"**.

Select the **"Recent"** tab.

Select the address chosen in the list to display the **"Guidance criteria"**.



Press **"OK"** to start guided navigation.



Select **"Position"** to see the point of arrival on the map.

## To "Home" or "My work"



Press **Navigation** to display the main page.

Press the **"MENU"** button to access the secondary page.



Select **"My destinations"**.

Select the **"Preferred"** tab.



Select **"Home"**.

Or



Select **"My work"**.

Or

Select a preset favourite destination.

## To a contact



Press **Navigation** to display the main page.

Press the **"MENU"** button to access the secondary page.



Select **"My destinations"**.

Select the **"Contact"** tab.

Select a contact in the list to start guided navigation.

## To points of interest (POI)

### Guided method:

Points of interest (POI) are listed in different categories.



Press **Navigation** to display the main page.

Press the **"MENU"** button to access the secondary page.



Select **"Points of interest"**.



Select the **"Travel"**, **"leisure"**, **"Commercial"**, **"Public"** or **"Geographic"**

tab.

Or



Select **"Search"** to enter the name and address of a POI.



Press **"OK"** to calculate the route.

Or

### Intuitive method:

**i** You can only select this method of using the service if a network connection is active; this may be either a "network connection provided by the vehicle", if you use the Peugeot Connect Packs solution, or else a "network connection provided by the user" via a smartphone. In both cases, the system is automatically connected to the Internet, if network coverage permits.

 Press **Navigation** to display the main page.

Press the **"MENU"** button to access the secondary page.

 Select **"Search"**.

Press on the mode shown in the bottom right of the screen (On-Board or Connected) to change the "Database".

 Select the "Database" in "On-Board" mode (integrated into the map), or in "Connected" mode (connected to the Internet).

 Press the back arrow to confirm.

 Enter an address or the key words for the destination (POI).

 Press **"OK"** to start the search.

 Select the **"On the route"**, **"Around the vehicle"** or **"At destination"** tab to refine your search.

Select the desired address to calculate the route.

## To a point on the map

 Press **Navigation** to display the main page.

Explore the map by sliding a finger on the screen.

Select the destination by pressing on the map.

 Tap the screen to place a marker and display the sub-menu.

 Press this button to start guided navigation.

Or

 Press this button to save the displayed address.

**i** A long press on a point opens a list of nearby POIs.

## To GPS coordinates

 Press **Navigation** to display the main page.

Explore the map by sliding a finger on the screen.

Touch the screen with a finger to go to the next image.

 Press this button to display the world map.

Using the grid, select the desired country or region by zooming.

 Press this button to display or enter the GPS coordinates.



A marker is displayed in the middle of the screen, with the **"Latitude"** and **"Longitude"** coordinates.

Choose the type of coordinates:  
DMS for: Degrees, Minutes, Seconds.  
DD for: Degrees, Decimals.



Press this button to start guided navigation.

Or



Press this button to save the displayed address.

OR



Press this button to enter the **"Latitude"** value using the virtual keypad.

And



Press this button to enter the **"Longitude"** value using the virtual keypad.

## TMC (Traffic Message Channel)

Available in some countries.

TMC (Traffic Message Channel) messages are based on a European standard for traffic information broadcasting via the RDS system on FM radio, sending traffic information in real time. The TMC information is then displayed on a GPS Navigation system map and taken into account straight away when routes are calculated, to avoid accidents, traffic jams and closed roads.

**i** Danger zone alerts may or may not be displayed, depending on the applicable

legislation and subscription to the corresponding service.

## Connected navigation

### Connected navigation connection

Depending on version, vehicle trim level and subscription to online services and options.

#### Network connection provided by the vehicle



With the Peugeot Connect Packs solution, the system is automatically connected to the Internet and connected services, and does not require the user to provide a connection via their smartphone.  
**OR**

#### Network connection provided by the user



For the list of suitable smartphones, visit the Brand's national website.

Activate and enter settings for sharing the smartphone connection.

As processes and standards are constantly changing, we recommend you

**update the smartphone operating system as well as the date and time on the smartphone and system**, to ensure that the communication process between the smartphone and the system functions correctly.

#### USB connection



Connect the USB cable.  
The smartphone charges when connected by the USB cable.

#### Bluetooth connection



Activate the Bluetooth function on the telephone and ensure that it is visible to all (see the "Connect-App" section).

#### Wi-Fi connection



Select a Wi-Fi network detected by the system and connect to it.

This function is only available if it has been activated either via the "Notifications" or via the "Applications" menu.



Press "**Notifications**".



Select Wi-Fi to activate it.

**OR**



Press **Connect-App** to display the main page.

Press the "**OPTIONS**" button to access the secondary page.



Select "**Wi-Fi network connection**".



Select the "**Secured**", "**Not secured**" or "**Stored**" tab.



Select a network.



Using the virtual keypad, enter the Wi-Fi network "**Key**" and "**Password**".



Press "**OK**" to establish a connection between the smartphone and the

vehicle's system.

Usage restrictions:

- With CarPlay®, connection sharing is only available with a Wi-Fi connection.
- With MirrorLink™, connection sharing is only available with a USB connection.

The quality of services depends on the quality of the network connection.

### Authorize sending information



Press **Settings** to display the main page.

Press the "**OPTIONS**" button to access the secondary page.



Select "**System configuration**".



Select the "**Private mode**" tab.

**OR**



Press "**Notifications**".



Press "**Private mode**".

THEN



Activate or deactivate:

- "No sharing (data, vehicle position)".
- "Only data sharing"
- "Sharing data and vehicle position"

## Settings specific to connected navigation



Press **Navigation** to display the main page.

Press the "**MENU**" button to access the secondary page.



Select "**Settings**".



Select the "**Map**" tab.



Activate or deactivate:

- "**Allow declaration of danger zones**".
- "**Guidance to final destination on foot**".

These settings must be configured for each profile.



Press "**OK**" to confirm your selection.



Select the "**Alerts**" tab.



Activate or deactivate:

- "**Advise of car park nearby**".
- "**Filling station alert**".

- "**Risk areas alert**" then press the warning icon (triangle) to configure the alerts.
- "**Give an audible warning**".
- "**Advise proximity of POI 1**".
- "**Advise proximity of POI 2**".

OK

Press "**OK**" to confirm your selection.



The "Notifications", located in the upper bar, can be accessed at any time.



Danger zone alerts may or may not be displayed, depending on the applicable legislation and subscription to the corresponding service.



When "TOMTOM TRAFFIC" appears, the services are available.



The services offered with connected navigation are as follows.

A Connected Services pack:

- Weather,
- Filling stations,
- Car park,
- Traffic,
- POI local search.

A Danger area pack (optional).

## Declaration: "Risk areas alert"



To send information about danger zones, select the option: **Allow declaration of danger zones**



Press **Navigation** to display the main page.



Press the "**Declare a new danger zone**" button located in the side bars or the upper bar of the touch screen (depending on equipment).



Select the "**Type**" option to select the type of "Danger area".



Select the "**Speed**" option and enter it using the virtual keypad.

OK

Press "**OK**" to save and send the information.

## Displaying fuel information



Press **Navigation** to display the main page.



Press this button to display the list of services.



Press "**POI on map**" to display the list of points of interest.





Press one of the buttons to search for "**Stations**".











Activate/deactivate "**Stations**".



Press this button to display a secondary page.





-  Select the **"Settings"** tab.
-  Select the desired fuel.
-  Press **"OK"** to save.

## Displaying charging station details

-  Press **Navigation** to display the main page.
-  Press this button to display the list of services.
-  Press **"POI on map"** to display the list of points of interest.
-  Press one of the buttons to search for **"Stations"**.
-  Activate/deactivate **"Stations"**.
-  Press this button to display a secondary page.
-  Select the **"Settings"** tab.
-  Select the desired connector type.
-  Press **"OK"** to save.

## Displaying weather information

-  Press **Navigation** to display the main page.

-  Press this button to display the list of services.
-  Select **"View map"**.
-  Select **"Weather"**.
-  Press this button to display basic information.
-  Press this button to display detailed weather information.

**i** The temperature displayed at 6 a.m. will be the maximum temperature for the day. The temperature displayed at 6 p.m. will be the minimum temperature for the night.

## Applications

### USB ports

Depending on equipment, for more information on the USB ports compatible with **CarPlay**<sup>®</sup>, **MirrorLink**<sup>™</sup> or **Android Auto** applications, refer to the "Ease of use and comfort" section.

**i** For the list of suitable smartphones, visit the Brand's national website.

**i** Synchronising a smartphone enables users to display applications that support the smartphone's **MirrorLinkCarPlay**<sup>®</sup>, <sup>™</sup> or **Android Auto** technology on the vehicle's screen. For **CarPlay**<sup>®</sup> technology, the

**CarPlay**<sup>®</sup> function must first be activated on the smartphone.

In all cases, the smartphone must be unlocked, to enable the communication process between the smartphone and the system to function.

As principles and standards are constantly changing, **we recommend keeping the smartphone's operating system up-to-date, together with the date and time on the smartphone and the system.**

## Connectivity

 Press **Applications** to display the main page.

Press **"Connectivity"** to access the **CarPlay**<sup>®</sup>, **MirrorLink**<sup>™</sup> or **Android Auto** functions.

## CarPlay<sup>®</sup> smartphone connection

Depending on country.

**i** On connecting the USB cable, the **CarPlay**<sup>®</sup> function deactivates the system's **Bluetooth**<sup>®</sup> mode.

The **"CarPlay"** function requires the use of a compatible smartphone and compatible applications.

 Connect the USB cable. The smartphone charges when connected by the USB cable.



Press "**Telephone**" to display the CarPlay® interface.

Or



Connect the USB cable. The smartphone charges when connected by the USB cable.



From the system, press "**Applications**" to display the main page.

Press "**Connectivity**" to access the "CarPlay®" function.



Press "**CarPlay**" to display the CarPlay® interface.

**i** When the USB cable is disconnected and the ignition is switched off then back on, the system will not automatically switch to Radio Media mode; the source must be changed manually.

## MirrorLink™ smartphone connection

Depending on country.

**i** The "**MirrorLink™**" function requires the use of a compatible smartphone and compatible applications.

You can check that your telephone is compatible on the Brand's website (services).



When connecting a smartphone to the system, we recommend enabling Bluetooth® on the smartphone.



Connect the USB cable. The smartphone charges when connected by the USB cable.



From the system, press "**Applications**" to display the main page.

Press "**Connectivity**" to access the "MirrorLink™" function.



Press "**MirrorLink™**" to start the application in the system.

Depending on the smartphone, it may be necessary to activate the "**MirrorLink™**" function.



**OK** During the procedure, several screen pages relating to certain features are displayed.

Accept to start and complete the connection. Once the connection is established, a page is displayed, showing the applications already downloaded to the smartphone that are compatible with MirrorLink™ technology. Access to the different audio sources remains available in the margin of the MirrorLink™ display, using the touch buttons located in the upper bar.

Access to the menus for the system is possible at any time using the dedicated buttons.

**i** There may be a pause before applications become available, depending on the quality of the network.

## Android Auto smartphone connection

Depending on country.

**i** Install the "**Android Auto**" application on the smartphone via "Google Play". The "**Android Auto**" function requires the use of a compatible smartphone and compatible applications.



Connect the USB cable. The smartphone charges when connected by the USB cable.



From the system, press "**Applications**" to display the main page.

Press "**Connectivity**" to access the "Android Auto" function.



Press "**Android Auto**" to start the application in the system.



**OK** During the procedure, several screen pages relating to certain features are displayed.

Accept to start and complete the connection. Access to the different audio sources remains available in the margin of the Android Auto display, using the touch buttons located in the upper bar.

Access to the menus for the system is possible at any time using the dedicated buttons.

**i** In Android Auto mode, the function that displays rolling menus by briefly pressing the screen with three fingers is disabled.

 There may be a pause before applications become available, depending on the quality of the network.

## Car Apps

 Press **Applications** to display the main page.  
Press "**Car Apps**" to display the applications home page.

## Internet Browser

 Press **Applications** to display the main page.  
Press "**Connectivity**" to access the "**Connected Apps**" function.  
Press "**Connected Apps**" to display the browser home page.

 Select the country of residence.

 Press "**OK**" to save and start the browser.

 Connection to the internet is via one of the network connections provided by the vehicle or the user.

## Bluetooth connection®

 The services available depend on the network, the SIM card and the compatibility of the Bluetooth devices used. Consult the smartphone user guide and the

service provider to check which services are available.

 The Bluetooth function must be activated and the smartphone configured as "Visible to all".

To complete the pairing, whichever procedure is used (from the smartphone or from the system), ensure that the code is the same in the system and in the smartphone.

 If the pairing procedure fails, we recommend deactivating and then reactivating the Bluetooth function on the smartphone.

### Procedure from the smartphone

 Select the name of the system in the list of detected devices.

In the system, accept the connection request from the smartphone.

### Procedure from the system

 Press **Connect-App** to display the main page.

Press the "**OPTIONS**" button to access the secondary page.

 Press "**Bluetooth connection**".

 Select "**Search**".  
The list of detected smartphones is displayed.

 Select the name of the chosen smartphone in the list.

 Depending on the type of smartphone, you may be prompted to accept the transfer of contacts and messages.

## Connection sharing

The system offers to connect the smartphone with 3 profiles:

- "**Telephone**" (hands-free kit, telephone only),
- "**Streaming**" (streaming: wireless playing of audio files on the smartphone),
- "**Mobile internet data**".

 The "**Mobile internet data**" profile must be activated for connected navigation (if the vehicle does not have "Emergency and assistance call" services), after first activating smartphone connection sharing.

 Select one or more profiles.

 Press "**OK**" to confirm.

## Wi-Fi connection

Network connection via the smartphone's Wi-Fi.

 Press **Connect-App** to display the main page.

Press the "**OPTIONS**" button to access the secondary page.





Select "**Wi-Fi network connection**".



Select the "**Secured**", "**Not secured**" or "**Stored**" tab.



Select a network.



Using the virtual keypad, enter the Wi-Fi network "**Key**" and "**Password**".



Press "**OK**" to establish the connection.



The Wi-Fi connection and Wi-Fi connection sharing are exclusive.

## Wi-Fi connection sharing

Creation of a local Wi-Fi network by the system.



Press **Connect-App** to display the main page.

Press the "**OPTIONS**" button to access the secondary page.



Select "**Share Wi-Fi connection**".

Select the "**Activation**" tab to activate or deactivate Wi-Fi connection sharing.

And/or

Select the "**Settings**" tab to change the system's network name and password.



Press "**OK**" to confirm.



To protect against unauthorised access and to make all systems as secure as

possible, the use of a security code or a complex password is recommended.

## Managing connections



Press **Connect-App** to display the main page.

Press the "**OPTIONS**" button to access the secondary page.



Select "**Manage connection**".

With this function, you can view the access to connected services, the availability of connected services and modify the connection mode.

## Radio

### Selecting a station



Press **Radio Media** to display the main page.

Press "**Frequency**".



Press one of the buttons to perform an automatic search for radio stations.

Or



Move the slider to manually search for frequencies up or down.

Or



Press **Radio Media** to display the main page.

Press the "**OPTIONS**" button to access the secondary page.



Select "**Radio stations**" on the secondary page.

Press "**Frequency**".



Enter the values using the virtual keypad. First enter the units then click on the decimals field to enter the figures after the decimal point.



Press "**OK**" to confirm.



Radio reception may be affected by the use of electrical equipment not approved by the Brand, such as a USB charger connected to the 12 V socket.

The exterior environment (hills, buildings, tunnels, basement car parks, etc.) may block reception, including in RDS mode.

This phenomenon is perfectly normal in the context of radio wave transmission, and in no way indicative of an audio system malfunction.

### Presetting a station

Select a radio station or frequency. (refer to the corresponding section)

Press "**Presets**".



Make a long press on one of the buttons to preset the station.

### Changing the waveband



Press **Radio Media** to display the main page.

To change the waveband, press "Band...", displayed at the top right of the screen.

## Activating/Deactivating RDS

RDS, if activated, allows you to continue listening to the same station by automatic retuning to alternative frequencies.



Press **Radio Media** to display the main page.

Press the "**OPTIONS**" button to access the secondary page.



Select "**Radio settings**".

Select "**General**".



Activate/deactivate "**Station follow**".



Press "**OK**" to confirm.

**i** RDS station tracking may not be available nationwide, as many radio stations do not cover 100 % of the country. This explains the loss of reception of the station during a journey.

## Displaying text information

The "Radio Text" function displays information transmitted by the radio station relating to the station or the currently playing song.



Press **Radio Media** to display the main page.

Press the "**OPTIONS**" button to access the secondary page.



Select "**Radio settings**".

Select "**General**".



Activate/deactivate "**Display radio text**".



Press "**OK**" to confirm.

## Playing TA messages

The TA (Traffic Announcement) function gives priority to TA alert messages. To operate, this function needs good reception of a radio station that carries this type of message. While traffic information is being broadcast, the current media is automatically interrupted so that the TA message can be heard. Normal play of the previously playing media resumes at the end of the message.

Select "**Announcements**".



Activate/deactivate "**Traffic announcement**".



Press "**OK**" to confirm.

## DAB (Digital Audio Broadcasting) radio

### Terrestrial Digital Radio

Digital radio provides higher quality sound.

The various "multiplexes/ensembles" offer a choice of radio stations organised in alphabetical order.



Press **Radio Media** to display the main page.

Press "Band ..." at the top right of the screen to display the "**DAB**" waveband.

## FM-DAB tracking

"DAB" does not cover 100 % of the territory. When the digital radio signal is poor, "FM-DAB auto follow-up" enables you to continue listening to the same station by automatically switching to the corresponding FM analogue station (if there is one).



Press **Radio Media** to display the main page.

Press the "**OPTIONS**" button to access the secondary page.



Select "**Radio settings**".

Select "**General**".



Activate/deactivate "**FM-DAB Follow-up**".



Activate/deactivate "**Station follow**".



Press "**OK**".

**i** If "FM-DAB auto tracking" is activated, there may be a time offset of a few seconds when the system switches to "FM"

analogue radio, and in some cases a change in volume.

When the digital signal quality is restored, the system automatically changes back to "DAB".

**!** If the "DAB" station being listened to is not available on "FM" ("**FM-DAB**" option shaded), or "FM-DAB auto tracking" is not activated, the sound will cut out while the digital signal is too weak.

## Media

### USB port



Insert the USB memory stick into the USB port or connect the USB device to the USB port using a suitable cable (not supplied).

**!** To protect the system, do not use a USB hub.

The system builds playlists (in temporary memory); this operation can take from a few seconds to several minutes at the first connection.

Reduce the number of non-music files and the number of folders to reduce the waiting time. Playlists are updated whenever the ignition is switched off or a USB memory stick is connected. The audio system memorises these lists, which will subsequently load faster if they have not been changed.

### Auxiliary socket (AUX)

Depending on equipment



Connect a portable device (MP3 player, etc.) to the auxiliary jack socket using an audio cable (not supplied).

This source is only available if "Auxiliary input" has been selected in the audio settings.

First adjust the volume on the portable device (to a high level). Then adjust the volume of the audio system.

Controls are managed via the portable device.

### Selecting the source



Press **Radio Media** to display the main page.

Select "**SOURCES**".

Select the source.

### Watching a video

Depending on equipment/Depending on version/  
Depending on country.

Insert a USB memory stick in the USB port.



Video control commands are accessible only through the touch screen.



Press **Radio Media** to display the main page.

Select "**SOURCES**".



Select **Video** to start the video.



To remove the USB memory stick, press the pause button to stop the video, then remove the memory stick.

The system can play video files in the MPEG-4 Part 2, MPEG-2, MPEG-1, H.264, H.263, VP8, WMV and RealVideo formats.

### Streaming Bluetooth®

Streaming allows you to listen to the audio feed from your smartphone.

The Bluetooth profile must be activated.

First adjust the volume on the portable device (to a high level).

Then adjust the volume of the audio system.

If play does not start automatically, it may be necessary to start the audio playback from the smartphone.

Control is from the portable device or by using the system's touch buttons.



Once connected in streaming mode, the smartphone is considered to be a media source.

### Connecting Apple® players

Connect the Apple® player to the USB port using a suitable cable (not supplied).

Play starts automatically.

Control is via the audio system.



The classifications available are those of the portable device connected (artists/

albums/genres/playlists/audio books/podcasts).

The default classification used is by artist. To modify the classification used, return to the first level of the menu then select the desired classification (playlists for example) and confirm to go down through the menu to the desired track.

The version of software in the audio system may not be compatible with the generation of the Apple® player.

## Information and advice

The system supports USB mass storage devices, BlackBerry® devices and Apple® players via the USB ports. The adapter cable is not supplied.

Devices are managed using the audio system controls.

Other devices, not recognised on connection, must be connected to the auxiliary socket using a jack cable (not supplied) or via Bluetooth streaming, if compatible.

The audio system will only play audio files with ".wma", ".aac", ".flac", ".ogg" and ".mp3" file extensions, at bit rates between 32 Kbps and 320 Kbps.

It also supports VBR (Variable Bit Rate) mode. No other file types (".mp4", etc.) can be read. All ".wma" files must be standard WMA 9 files. The supported sampling rates are 32, 44 and 48 KHz.

To avoid reading and display problems, we recommend choosing file names less than 20 characters long that do not contain any special characters (e.g. " ? . ; ù).

Use only USB memory sticks in FAT32 format (File Allocation Table).

 We recommend using the original USB cable for the portable device.

## Telephone

### Pairing a Bluetooth® telephone

 The services available depend on the network, the SIM card and the compatibility of the Bluetooth devices used. Consult the telephone user guide and the service provider to check which services are available.

 The Bluetooth function must be activated and the telephone configured as "Visible to all" (in the telephone settings).

To complete the pairing, whichever procedure is used (from the telephone or from the system), ensure that the code is the same in the system and in the telephone.

 If the pairing procedure fails, we recommend deactivating and then reactivating the Bluetooth function on the telephone.

### Procedure from the telephone

 Select the system name in the list of detected devices.

In the system, accept the connection request from the telephone.

### Procedure from the system

 Press **Telephone** to display the main page.

 Press "**Bluetooth search**".

Or

 Select "**Search**".  
The list of detected telephones is displayed.

 Select the name of the chosen telephone in the list.

### Connection sharing

The system offers to connect the telephone with 3 profiles:

- "**Telephone**" (hands-free kit, telephone only),
- "**Streaming**" (streaming: wireless playing of audio files on the telephone),
- "**Mobile internet data**".

 The "**Mobile internet data**" profile must be activated for connected navigation,

after first activating smartphone connection sharing.

 Select one or more profiles.

**OK** Press **"OK"** to confirm.

Depending on the type of telephone, you may be prompted to accept the transfer of contacts and messages.

 The ability of the system to connect just one profile depends on the telephone. All three profiles may connect by default.

 The profiles compatible with the system are: HFP, OPP, PBAP, A2DP, AVRCP, MAP and PAN.

Visit the Brand's website for more information (compatibility, additional help, etc.).

### Automatic reconnection

On returning to the vehicle, if the last telephone connected is present again, it is automatically recognised and within about 30 seconds after switching on the ignition, the pairing is established automatically (Bluetooth activated).

#### To modify the connection profile:

 Press **Telephone** to display the main page.

Press the **"OPTIONS"** button to access the secondary page.

 Select **"Bluetooth connection"** to display the list of paired devices.

 Press the **"Details"** button.

 Select one or more profiles.

**OK** Press **"OK"** to confirm.

### Managing paired telephones

This function lets you connect or disconnect a device or delete a pairing.

 Press **Telephone** to display the main page.

Press the **"OPTIONS"** button to access the secondary page.

 Select **"Bluetooth connection"** to display the list of paired devices.

 Press on the name of the telephone selected in the list to disconnect it.

Press again to connect it.

### Deleting a telephone

 Select the basket at top right of the screen to display a basket alongside the telephone chosen.

 Press the basket alongside the telephone chosen to delete it.

### Receiving a call

An incoming call is announced by a ring and a superimposed display in the screen.

 Make a short press on the steering mounted telephone button to accept an incoming call.

And

 Make a long press

 on the steering mounted telephone button to reject the call.

Or

 Select **"End call"** on the touch screen.

### Making a call

 Using the telephone is not recommended while driving.

Park the vehicle.

Make the call using the steering mounted controls.

### Calling a new number

 Press **Telephone** to display the main page.

 Enter the phone number using the digital keypad.

 Press **"Call"** to start the call.

### Calling a contact

 Press **Telephone** to display the main page.



Or press and hold  
the steering mounted telephone button.



Select "**Contact**".

Select the desired contact from the displayed list.



Select "**Call**".

## Calling a recently used number



Press **Telephone** to display the main page.

Or



Press and hold



the steering mounted telephone button.

Select "**Calls**".

Select the desired contact from the displayed list.

**i** It is always possible to make a call directly from the telephone; as a safety measure, first park the vehicle.

## Managing contacts/entries



Press **Telephone** to display the main page.

Select "**Contact**".



Select "**Create**" to add a new contact.



Press the "**Telephone**" tab to enter the contact's telephone number(s).



Press the "**Address**" tab to enter the contact's address(es).



Press the "**Email**" tab to enter the contact's email address(es).



Press "**OK**" to save.



Press this button to sort contacts by Surname+first name or by First name+surname.

**i** The "**Email**" function allows email addresses to be entered for a contact, but the system is not able to send emails.

## Managing messages



Press **Telephone** to display the main page.

Press the "**OPTIONS**" button to access the secondary page.



Select "**Messages**" to display the list of messages.



Select the "**All**", "**Incoming**" or "**Sent**" tab.



Select the details of the message chosen in one of the lists.



Press "**Answer**" to send a quick message stored in the system.



Press "**Call**" to start the call.



Press "**Play**" to listen to the message.

**!** Access to "**Messages**" depends on the compatibility between the smartphone and the onboard system. Some smartphones retrieve messages or email messages more slowly than others.

## Managing quick messages



Press **Telephone** to display the main page.

Press the "**OPTIONS**" button to access the secondary page.



Select "**Quick messages**" to display the list of messages.



Select the "**Delayed**", "**My arrival**", "**Not available**" or "**Other**" tab, enabling you to

create new messages.



Press "**Create**" to write a new message.



Select the message chosen in one of the lists.



Press "**Transfer**" to select one or more recipients.



Press "**Play**" to start playing the message.

## Managing email



Press **Telephone** to display the main page.

Press the "**OPTIONS**" button to access the secondary page.



Select "**Email**" to display the list of messages.



Select the **"Incoming"**, **"Sent"** or **"Not read"** tab.

Select the message chosen in one of the lists.



Press **"Play"** to start playing the message.

**!** Access to email messages depends on the compatibility between the smartphone and the onboard system.

## Settings

### Audio settings



Press **Settings** to display the main page.



Select **"Audio settings"**.

Then select **"Ambience"**, **"Position"**, **"Sound"**, **"Voice"** or **"Ringtone"**.



Press **"OK"** to save the settings.

**i** The balance/distribution (or spatialisation with the Arkamys® system) uses audio processing to adjust the sound quality according to the number of passengers in the vehicle.

Available only with the front and rear speaker configuration.

**i** The **Ambience** setting (choice of 6 ambiances) and the **Bass**, **Medium** and

**Treble** sound settings are different and independent for each audio source.

Activate or deactivate **"Loudness"**.

The **"Position"** settings (All passengers, Driver and Front only) are common to all sources.

Activate or deactivate **"Touch tones"**, **"Volume linked to speed"** and **"Auxiliary input"**.



Onboard audio: Arkamys Sound Staging® optimises the sound distribution inside the passenger compartment.

### Configuring profiles



Press **Settings** to display the main page.

Press the **"OPTIONS"** button to access the secondary page.



Select **"Setting of the profiles"**.

Select **"Profile 1"**, **"Profile 2"**, **"Profile 3"** or **"Common profile"**.



Press this button to enter a name for the profile using the virtual keypad.



Press **"OK"** to confirm.



Press this button to add a photograph to the profile.



Insert a USB memory stick containing the photograph in the USB port.

Select the photograph.



Press **"OK"** to accept the transfer of the photograph.



Press **"OK"** again to save the settings.



The location for the photograph is square; the system reshapes the original photograph if in another format.



Press this button to reset the selected profile.



Resetting the selected profile activates the English language by default.

Select a **"Profile"** (1 or 2 or 3) to link **"Audio settings"** with it.



Select **"Audio settings"**.

Then select **"Ambience"**, **"Position"**, **"Sound"**, **"Voice"** or **"Ringtone"**.



Press **"OK"** to save the selected profile's settings.

### Modifying system settings



Press **Settings** to display the main page.

Press the **"OPTIONS"** button to access the secondary page.



Select **"Screen configuration"**.

Select **"Animation"**.



Activate or deactivate: **Automatic scrolling**

Select "**Brightness**".

 Move the slider to adjust the brightness of the screen and/or the instrument panel.

 Press **Settings** to display the main page.

Press the "**OPTIONS**" button to access the secondary page.

 Select "**System settings**".

Select "**Units**" to change the units of distance, fuel consumption and temperature.

Select "**Factory settings**" to restore the initial settings.

 Resetting the system to "Factory settings" activates English and degrees Fahrenheit and deactivates summer time.

Select "**System info**" to display the versions of the various modules installed in the system.

## Selecting the language

 Press **Settings** to display the main page.

Press the "**OPTIONS**" button to access the secondary page.

 Select "**Languages**" to change the language.

## Setting the date

 Press **Settings** to display the main page.

Press the "**OPTIONS**" button to access the secondary page.

 Select "**Setting the time-date**".

Select "**Date**".

 Press this button to set the date.

 Press "**OK**" to confirm.

 Select the display format for the date.

 Time and date setting is only available if "GPS synchronisation" is deactivated.

## Setting the time

 Press **Settings** to display the main page.

Press the "**OPTIONS**" button to access the secondary page.

 Select "**Setting the time-date**".

Select "**Time**".

 Press this button to set the time using the virtual keypad.

 Press "**OK**" to confirm.

 Press this button to set the time zone.

 Select the display format for the time (12h/24h).

 Activate or deactivate summer time (+1 hour).

 Activate or deactivate GPS synchronisation (UTC).

 Press "**OK**" to confirm.

 The system may not automatically manage the change between winter and summer time (depending on the country of sale).

## Colour schemes

Depending on equipment/Depending on version.

 As a safety measure, the procedure for changing the colour scheme is only possible when the **vehicle is stationary**.

 Press **Settings** to display the main page.

 Select "**Color schemes**".

 Select a colour scheme in the list then press "**OK**" to confirm.

 Whenever the colour scheme is changed, the system restarts, temporarily displaying a black screen.



## Frequently asked questions

The following information groups together the answers to the most frequently asked questions concerning the system.

### Navigation

#### I cannot enter the navigation address.

The address is not recognised.

► Use the "intuitive method" by pressing the "Search..." button at the bottom of the "Navigation" page.

#### The route calculation is not successful.

The route settings may conflict with the current location (for example, if toll roads are excluded but the vehicle is on a toll road).

► Check the route settings in the "Navigation" menu.

#### I do not receive "Danger zone" alerts.

You have not subscribed to the online services option.

► If you have subscribed to the option:

- a few days may elapse before the service is activated,
- services may not be selected in the system menu,
- online services are not active ("TOMTOM TRAFFIC" not shown on the map).

#### The POIs do not appear.

The POIs have not been selected.

► Set the zoom level to 600 ft (200 m) or select POIs in the POI list.

#### The "Danger zone" audible warning feature is not working.

The audible warning is not active or the volume is too low.

► Activate the audible warning in the "Navigation" menu and check the voice volume in the sound settings.

#### The system does not suggest a detour around an incident on the route.

The route settings do not take account of TMC messages.

► Configure the "Traffic info" function in the route settings list (Without, Manual or Automatic).

#### I receive a warning about a "Danger area" that is not on my route.

As well as providing guided navigation, the system announces all "Danger areas" positioned in a cone located in front of the vehicle. It may provide an alert for "Danger areas" located on nearby or parallel roads.

► Zoom the map to show the exact location of the "Danger area". You can select "On the route" to stop receiving warnings or decrease the warning duration.

#### Certain traffic jams along the route are not indicated in real time.

On starting, a few minutes may elapse before the system begins to receive traffic information.

► Wait until traffic information is being received correctly (traffic information icons shown on the map).

In certain countries, only major routes (motorways, etc.) are listed for the traffic information.

This is perfectly normal. The system is dependent on the traffic information available.

#### The altitude is not displayed.

On starting, GPS initialisation may take up to 3 minutes to receive more than 4 satellites correctly.

► Wait until the system has started up completely so that there is GPS coverage by at least 4 satellites.

Depending on the geographical environment (tunnel, etc.) or the weather, the conditions of reception of the GPS signal may vary.

This behaviour is normal. The system is dependent on the GPS signal reception conditions.

#### My navigation is no longer connected.

During start-up and in certain geographical areas, the connection may be unavailable.

► Check that the online services are activated (settings, contract).

### Radio

**The reception quality of the tuned radio station gradually deteriorates or the station presets are not working (no sound, 87.5 MHz is displayed, etc.).**

The vehicle is too far from the selected station's transmitter, or no transmitter is present in the geographical area.

▶ Activate the "" function by means of the short-cut menu to enable the system to check whether there is a more powerful transmitter in the geographical area.

The aerial is missing or has been damaged (for example while entering a car wash or underground car park).

▶ Have the aerial checked by a dealer.

The environment (hills, buildings, tunnels, basement car parks, etc.) is blocking reception, including in RDS mode.

This is a perfectly normal phenomenon, and is not indicative of an audio system malfunction.

**I cannot find some radio stations in the list of stations received.**

**The name of the radio station changes.**

The station is no longer received or its name has changed in the list.

Some radio stations send other information in place of their name (the title of the song for example).

The system interprets these details as the station name.

▶ Press the "Update list" button in the "Radio stations" secondary menu.

## Media

**Playback of my USB memory stick starts only after a very long wait (around 2 to 3 minutes).**

Some files supplied with the memory stick may greatly slow down access to reading the memory stick (multiplication by 10 of the cataloguing time).

▶ Delete the files supplied with the memory stick and limit the number of sub-folders in the file structure on the memory stick.

**There may be an extended pause after inserting a USB stick.**

The system reads a variety of data (folder, title, artist, etc.). This can take from a few seconds to a few minutes.

This is perfectly normal.

**Some characters in information about the currently playing media may not be displayed correctly.**

The audio system is unable to process certain types of character.

▶ Use standard characters to name tracks and folders.

**Playback of streaming files does not start.**

The connected device does not automatically launch playback.

▶ Start playback from the device.

**Track names and playing times are not displayed on the audio streaming screen.**

The Bluetooth profile does not allow the transfer of this information.

## Telephone

**I cannot connect my Bluetooth telephone.**

The telephone's Bluetooth function may be switched off or the device may not be visible.

▶ Check that the telephone has Bluetooth switched on.

▶ Check in the telephone settings that it is "visible to all".

▶ Deactivate then reactivate the telephone's Bluetooth function.

The Bluetooth telephone is not compatible with the system.

▶ You can check the compatibility of the telephone on the Brand's website (services).

**Android Auto and/or CarPlay do not work.**

Android Auto and CarPlay may not activate if the USB cables are of poor quality.

▶ Use genuine USB cables to ensure compatibility.

**Android Auto and/or CarPlay do not work.**

Android Auto and CarPlay are not available in all countries.

▶ Check the Google Android Auto or Apple website to see which countries are supported.

**The volume of the telephone connected in Bluetooth mode is inaudible.**

The volume depends on both the system and the telephone.

▶ Increase the volume of the audio system, to maximum if required, and increase the volume of the telephone if necessary.

Ambient noise affects the quality of the telephone call.

▶ Reduce the ambient noise level (close windows, turn down ventilation, slow down, etc.).

**Some contacts are duplicated in the list.**

The options for synchronising contacts are: synchronise the contacts on the SIM card, the contacts on the telephone, or both. When both synchronisations are selected, some contacts may be duplicated.

- ▶ Select "" or "".

### **The contacts are not listed in alphabetical order.**

Some telephones offer display options.

Depending on the settings chosen, contacts can be transferred in a specific order.

- ▶ Modify the telephone directory display settings.

### **The system does not receive SMS.**

Bluetooth mode does not allow SMS text messages to be sent to the system.

## **Settings**

### **When the treble and bass settings are changed, the ambience is deselected.**

### **When the ambience is changed, the treble and bass settings are reset.**

Selecting an ambience imposes the treble and bass settings, and vice versa.

- ▶ Modify the treble and bass or ambience settings to obtain the desired musical ambience.

### **When the balance settings are changed, the distribution is deselected.**

### **When the distribution setting is changed, the balance settings are deselected.**

Selecting a distribution setting imposes the balance settings, and vice versa.

- ▶ Modify the balance setting or the distribution setting to obtain the desired sound quality.

### **There is a difference in sound quality between audio sources.**

To allow for optimal listening quality, the sound settings can be tailored to different audio

sources, which can generate audible differences when changing source.

- ▶ Check that the sound settings are appropriate to the sources listened to. We recommend setting the sound functions (Bass:, Treble:, Balance) to the middle position, setting the musical ambience to "None", setting loudness correction to "Active" in USB mode and "Inactive" in Radio mode.

- ▶ In all cases, after applying sound settings, adjust the volume level on the portable device (to a high level) first. Then adjust the volume level on the audio system.

### **When the engine is off, the system switches off after several minutes of use.**

When the engine is switched off, the system's operating time depends on the state of charge of the battery.

The switch-off is normal: the system automatically goes into energy economy mode and switches off to maintain an adequate charge in the battery.

- ▶ Start the vehicle's engine to increase the charge of the battery.

### **The date and time cannot be set.**

Setting of the date and time is only available if the synchronisation with the satellites is deactivated.

- ▶ Settings menu / Options / Time-Date setting. Select the "Time" tab and deactivate the "GPS synchronisation" (UTC).

3D digital instrument panel ..... 10

## A

ABS ..... 67  
 Accelerated charging unit (Wallbox) ..... 141  
 Accessories ..... 64  
 Active Safety Brake ..... 122–124  
 AdBlue® ..... 20, 158  
 AdBlue® tank ..... 159  
 Additive, Diesel ..... 156  
 Adjusting headlamps ..... 57  
 Adjusting head restraints ..... 40  
 Adjusting seat ..... 40–41  
 Adjusting the air distribution ..... 46–47  
 Adjusting the air flow ..... 46–47  
 Adjusting the date ..... 198, 222  
 Adjusting the height and reach  
 of the steering wheel ..... 42  
 Adjusting the lumbar support ..... 41  
 Adjusting the seat angle ..... 41  
 Adjusting the temperature ..... 46–47  
 Adjusting the time ..... 198, 222  
 Advanced Grip Control ..... 69  
 Advice on care and maintenance ..... 140, 160  
 Advice on driving ..... 7, 84–85  
 Airbags ..... 72–74, 76  
 Airbags, curtain ..... 73–74  
 Airbags, front ..... 73–74, 77  
 Airbags, lateral ..... 73–74  
 Air conditioning ..... 45, 47–48

Air conditioning, automatic ..... 46, 48  
 Air conditioning, manual ..... 46  
 Air intake ..... 48  
 Air vents ..... 45  
 Alarm ..... 35–36  
 Amplifier, audio ..... 51  
 Android Auto connection ..... 213  
 Anti-lock braking system (ABS) ..... 67  
 Antitheft / Immobiliser ..... 29  
 Apple CarPlay connection ..... 194, 212  
 Applications ..... 214  
 Assistance call ..... 65  
 Assistance, emergency braking ..... 67, 124  
 Audible warning ..... 65  
 Audio streaming (Bluetooth) ..... 193, 217

## B

Battery, 12 V ..... 152, 156, 176–178  
 Battery, ancillaries ..... 176  
 Battery, charging ..... 177–178  
 Battery, remote control ..... 33–34  
 Blanking screen (snow shield) ..... 151  
 Blind ..... 38  
 Blind spot monitoring system, active ..... 22  
 Blind spot sensors ..... 121  
 BlueHDi ..... 20, 155, 162  
 Bluetooth (hands-free) ..... 195–196, 218–219  
 Bluetooth (telephone) ..... 195–196, 218–219  
 Bodywork ..... 161  
 Bonnet ..... 152–153

Boot ..... 35, 54  
 Brake discs ..... 157  
 Brakes ..... 157  
 Braking ..... 98  
 Braking assistance system ..... 67  
 Braking, automatic emergency ..... 122–124  
 Braking, dynamic emergency ..... 90–92  
 Brightness ..... 197  
 Bulbs ..... 170  
 Bulbs (changing) ..... 169–171

## C

Cable, audio ..... 217  
 Cable, Jack ..... 217  
 Capacity, fuel tank ..... 138  
 Cap, fuel filler ..... 138  
 Care of the bodywork ..... 161  
 Central locking ..... 31–32  
 Changing a bulb ..... 169–171  
 Changing a fuse ..... 171–172, 174–175  
 Changing a wheel ..... 163, 166  
 Changing a wiper blade ..... 61–62  
 Changing the remote control battery ..... 33  
 Charge level indicator ..... 22  
 Charger, induction ..... 51  
 Charger, wireless ..... 51  
 Charging cable ..... 141, 143  
 Charging connector ..... 141, 143, 145–146  
 CHECK ..... 23  
 Checking the engine oil level ..... 19

Checking the levels ..... 154–155  
 Checking tyre pressures  
 (using the kit) ..... 164–165  
 Checks ..... 153, 156–157  
 Checks, routine ..... 156–157  
 Child lock ..... 82  
 Children ..... 72, 77, 79  
 Children (safety) ..... 82  
 Child seats ..... 72, 75–77  
 Child seats, conventional ..... 77, 79  
 Child seats, i-Size ..... 79  
 Child seats, ISOFIX ..... 77–79  
 Cleaning (advice) ..... 140, 160–161  
 Closing the boot ..... 31, 35  
 Closing the doors ..... 31, 34  
 Collision Risk Alert ..... 122–123  
 Configuration, vehicle ..... 26  
 Connected applications ..... 214  
 Connection,  
 Bluetooth ..... 195–196, 214, 218–219  
 Connection, MirrorLink ..... 194–195, 213  
 Connection, Wi-Fi network ..... 214–215  
 Connectivity ..... 212  
 Consumption figures ..... 27  
 Container, AdBlue® ..... 158  
 Control, emergency boot release ..... 35  
 Control, emergency door ..... 32–33  
 Control, heated seats ..... 42  
 Controls, steering mounted ..... 94–97  
 Control stalk, lighting ..... 55, 57  
 Control stalk, wipers ..... 60–63  
 Control unit ..... 141, 143

Courtesy lamp, front ..... 53  
 Courtesy lamps ..... 52–53  
 Cruise control ..... 106, 109–110  
 Cruise control, adaptive ..... 111  
 Cruise control by speed limit recognition ..... 106  
 Cruise control,  
 dynamic with Stop function ..... 106

## D

DAB (Digital Audio Broadcasting) -  
 Digital radio ..... 192, 216  
 Date (setting) ..... 198, 222  
 Daytime running lamps ..... 56, 170  
 Deactivating the passenger airbag ..... 73, 76–77  
 Deadlocking ..... 29, 31  
 Deferred charging ..... 27, 141, 143  
 Defrosting ..... 48  
 Defrosting, front ..... 48  
 Demisting ..... 48  
 Demisting, front ..... 48  
 Demisting, rear ..... 49  
 Demisting, rear screen ..... 49  
 Dials and gauges ..... 9–10  
 Digital instrument panel ..... 10–11  
 Dimensions ..... 186  
 Dipstick ..... 19, 154  
 Direction indicators ..... 56–57, 170–171  
 Display screen, instrument panel ..... 9  
 Domestic charging ..... 143–146, 185  
 Doors ..... 34

## E

Drive Assist Plus ..... 111  
 Driver's attention warning ..... 125  
 Driving ..... 84–85  
 Driving aids camera (warnings) ..... 103  
 Driving aids (recommendations) ..... 102  
 Driving economically ..... 7  
 Driving modes ..... 98  
 Dynamic stability control (DSC) ..... 67–68

EBFDF ..... 67  
 Eco-driving (advice) ..... 7  
 ECO mode ..... 98  
 Economy mode ..... 152  
 Electric motor ..... 5, 26, 139, 185  
 Electric windows ..... 37  
 Electronic brake force distribution (EBFDF) ..... 67  
 Emergency braking assistance (EBA) ..... 67  
 Emergency call ..... 65  
 Emergency switching off ..... 88–89  
 Emergency warning lamps ..... 64, 162  
 Emissions control system, SCR ..... 21, 158  
 Energy economy mode ..... 152  
 Energy flows ..... 26  
 Energy recovery ..... 21, 98  
 Engine ..... 157  
 Engine compartment ..... 153  
 Engine, Diesel ..... 138, 153, 162, 184  
 Engine, petrol ..... 153, 182  
 Engines ..... 181–182, 184

Environment ..... 7, 34, 84  
 ESC (electronic stability control) ..... 67  
 Expanded traffic sign recognition ..... 107

---

**F**

Fatigue detection ..... 125  
 Filling the AdBlue® tank ..... 155, 159  
 Filling the fuel tank ..... 138–139  
 Filter, air ..... 156  
 Filter, oil ..... 156  
 Filter, particle ..... 156  
 Filter, passenger compartment ..... 45, 156  
 Fitting a wheel ..... 167–168  
 Fitting roof bars ..... 149–150  
 Fittings, boot ..... 53  
 Fittings, interior ..... 50  
 Flap, charging ..... 27, 141, 143, 145–146  
 Flap, fuel filler ..... 138–139  
 Flashing indicators ..... 56–57, 171  
 Floor, boot, adjustable ..... 54  
 Fluid, brake ..... 155  
 Fluid, engine coolant ..... 155  
 Foglamps, front ..... 55, 59  
 Foglamps, rear ..... 55, 171  
 Folding the rear seats ..... 44  
 Frequency (radio) ..... 216  
 Fuel ..... 7, 138  
 Fuel consumption ..... 7  
 Fuel tank ..... 138–139  
 Full Park Assist ..... 133

Fusebox, dashboard ..... 172  
 Fusebox, engine compartment ..... 172, 174–175  
 Fuses ..... 171–172, 174–175

---

**G**

Gauge, fuel ..... 138  
 Gearbox,  
 automatic ..... 92, 94–97, 99–101, 156, 177  
 Gearbox, manual ..... 92, 99–101, 156  
 Gear lever, manual gearbox ..... 92  
 Gear shift indicator ~  
 Gear efficiency indicator ..... 99  
 Glove box ..... 50  
 G.P.S. .... 209

Hi-Fi system ..... 51  
 High voltage ..... 139  
 Hill Assist Descent Control (HADC) ..... 69  
 Hill start assist ..... 98–99  
 Histogramme, fuel consumption ..... 27  
 Horn ..... 65  
 Horn for pedestrians ..... 65, 84

---

**I**

Hazard warning lamps ..... 64, 162  
 headlamp adjustment ..... 57  
 Headlamp adjustment ..... 57  
 Headlamps, automatic dipping ..... 58–59  
 Headlamps, automatic illumination ..... 57–58  
 Headlamps, dipped beam ..... 170  
 Headlamps, halogen ..... 57, 170  
 Headlamps, main beam ..... 170  
 Head restraints, front ..... 40  
 Head restraints, rear ..... 44  
 Heating ..... 45  
 Heating, programmable ..... 27, 49

Ignition ..... 88, 220  
 Ignition on ..... 88  
 Ignition switch ..... 86–87  
 Immobiliser, electronic ..... 85  
 Indicator, AdBlue® range ..... 20  
 Indicator, coolant temperature ..... 20  
 Indicator, engine oil level ..... 19  
 Indicators, direction ..... 56, 171  
 Inflating tyres ..... 157, 186  
 Inflating tyres and accessories  
 (using the kit) ..... 164–165  
 Infrared camera ..... 103  
 Instrument panel ..... 11, 23–24, 103  
 Instrument panel, LCD ..... 9  
 Instrument panel, matrix ..... 9  
 Instrument panels ..... 9–10  
 Internet browser ..... 210, 214  
 ISOFIX mountings ..... 77, 79

---

**J**  
 Jack ..... 163–164, 166, 217  
 Jump starting ..... 176

---

**K**  
 Key ..... 28–29, 32–33  
 Key, electronic ..... 30–31  
 Keyless Entry and Starting ..... 30–31, 87–88  
 Key not recognised ..... 88–89  
 Key with remote control ..... 28, 85–86  
 Kit, hands-free ..... 195–196, 218–219  
 Kit, puncture repair ..... 163–164  
 Kit, temporary puncture repair ..... 162–165

---

**L**  
 Labels, identification ..... 186  
 Lamp, boot ..... 54  
 Lamps, parking ..... 57  
 Lamps, rear ..... 171  
 Lams with "Full LED" technology ..... 57, 59  
 Lane assist ..... 111, 114–116, 118  
 Lane departure warning active ..... 118, 121  
 Leather (care) ..... 161  
 LEDs - Light-emitting diodes ..... 56, 170  
 Level, AdBlue® ..... 155  
 Level, brake fluid ..... 155  
 Level, Diesel additive ..... 156

Level, engine coolant ..... 20, 155  
 Level, engine oil ..... 19, 154  
 Levels and checks ..... 153–155  
 Level, screenwash fluid ..... 61, 155  
 Light-emitting diodes - LEDs ..... 56, 170  
 Lighting, cornering ..... 59  
 Lighting dimmer ..... 23  
 Lighting, exterior ..... 55  
 Lighting, guide-me home ..... 29, 58  
 Lighting, interior ..... 52–53  
 Lighting, mood ..... 53  
 Lighting, welcome ..... 58  
 Loading ..... 149–150  
 Load reduction mode ..... 152  
 Locating your vehicle ..... 29  
 Locking ..... 29, 31  
 Locking from the inside ..... 32  
 Locking the doors ..... 32  
 Low fuel level ..... 138  
 Low traction battery level ..... 22  
 Lumbar ..... 41

---

**M**  
 Mains socket (domestic network) ..... 141  
 Maintenance (advice) ..... 140, 160  
 Maintenance, routine ..... 103, 156–157  
 Manoeuvring aids (recommendations) ..... 102  
 Map reading lamps ..... 52  
 Markings, identification ..... 186  
 Massage function ..... 41

Mat ..... 52, 103  
 Menu ..... 194  
 Menu, main ..... 26  
 Menus (audio) ..... 189–190, 202–203  
 Menu short cuts ..... 26  
 Messages ..... 220  
 Messages, quick ..... 220  
 Mirror, rear view ..... 43  
 Mirrors, door ..... 42–43, 49, 121  
 Mirror, vanity ..... 50  
 Misfuel prevention ..... 139  
 Motor, electric ..... 5, 88, 139, 185  
 Mountings, ISOFIX ..... 77, 79

---

**N**  
 Navigation ..... 207–209  
 Navigation, connected ..... 210–212

---

**O**  
 Obstacle detection ..... 126  
 Oil change ..... 154  
 Oil consumption ..... 154  
 Oil, engine ..... 154  
 On-board tools ..... 54, 162–164  
 Opening the bonnet ..... 152–153  
 Opening the boot ..... 30, 35  
 Opening the doors ..... 30, 34  
 Opening the windows ..... 28

---

<b>P</b>	
Pads, brake .....	157
Paint .....	161, 186
Paint colour code .....	186
Park Assist .....	130
Parking brake .....	89, 157
Parking brake, electric .....	89–92, 157
Parking sensors, audible and visual .....	126
Parking sensors, front .....	126
Parking sensors, rear .....	126
Personalisation .....	11
Plates, identification .....	186
Player, Apple® .....	193, 217
Player, USB .....	192, 217
Port, USB .....	50, 192, 212, 217
Power .....	21
Power indicator .....	21
Pressures, tyres .....	157, 166, 186
Pre-tensioning seat belts .....	72
Priming the fuel system .....	162
Profiles .....	197, 221
Protecting children .....	73, 75–77, 79
Proximity Keyless Entry & Start .....	30
Public fast charging station .....	141, 145
Puncture .....	164, 166

---

<b>Q</b>	
Quiet vehicle warning sound .....	65, 84

---

<b>R</b>	
Radar (warnings) .....	102
Radio .....	190–191, 215
Radio, digital (Digital Audio Broadcasting - DAB) .....	192, 216
Range, AdBlue .....	20, 155
RDS .....	191, 216
Reading lamps .....	52
Rear screen, demisting .....	49
Recharging the battery .....	177–178
Recharging the traction battery .....	139, 143, 145–146
Recirculation, air .....	48
Recovery .....	179–180
Reduction of electrical load .....	152
Regeneration of the particle filter .....	156
Regenerative braking (deceleration by engine braking) .....	97–98
Reinitialisation of the under-inflation detection system .....	102
Reinitialising the remote control .....	34
Reminder, key in ignition .....	87
Reminder, lighting on .....	56
Remote control .....	28–32
Remote functions .....	27, 49
Removing a wheel .....	167–168
Removing the mat .....	52
Replacing bulbs .....	169–171
Replacing fuses .....	171–172
Replacing the air filter .....	156
Replacing the oil filter .....	156

Replacing the passenger compartment filter .....	156
Reservoir, screenwash .....	155
Reset trip .....	24
Rev counter .....	10
Reversing camera .....	103, 127–128
Roof bars .....	149–150
Roof, opening .....	38
Running out of fuel (Diesel) .....	162

---

<b>S</b>	
Safety, children .....	73, 75–77, 79
Saturation of the particle filter (Diesel) .....	156
Screen menu map .....	194
Screens, very cold conditions .....	151
Screenwash .....	61
Screenwash, front .....	61
Screenwash, rear .....	61
SCR (Selective Catalytic Reduction) .....	21, 158
Seat angle .....	41
Seat belts .....	71–72, 77
Seat belts, rear .....	71
Seat, rear bench .....	43
Seats, electric .....	41
Seats, front .....	40–41
Seats, heated .....	42
Seats, rear .....	43–44, 75
Selector, drive .....	97
Selector, gear .....	94–97
Sensors (warnings) .....	103



Serial number, vehicle ..... 186  
 Service indicator ..... 19, 23  
 Servicing ..... 19, 156–157  
 Settings, equipment ..... 26  
 Settings, system ..... 197, 221  
 Sidelamps ..... 56–57, 170  
 Side parking sensors ..... 127  
 Smartphone ..... 27, 49  
 Snow chains ..... 101, 150  
 Snow screen ..... 151  
 Socket, 12 V accessory ..... 51  
 Socket, auxiliary ..... 193, 217  
 Socket, Jack ..... 217  
 Speakers ..... 51  
 Speed limiter ..... 106–108  
 Speed limit recognition ..... 104–105  
 Speedometer ..... 9–10, 103  
 Sport mode ..... 98  
 Spotlamps, side ..... 58  
 Stability control (ESC) ..... 67–68  
 Starting a Diesel engine ..... 138  
 Starting the engine ..... 86, 88  
 Starting the vehicle ..... 86–87, 94–97  
 Starting using another battery ..... 88, 176  
 State of charge, battery ..... 26  
 Station, radio ..... 190–191, 215–216  
 Stay, bonnet ..... 153  
 Steering mounted controls, audio ..... 188, 202  
 Steering wheel, adjustment ..... 42  
 Stickers, customising ~ Stickers,  
 expressive ..... 161  
 Stopping the vehicle ..... 86–88, 94–97

Stop & Start ..... 25, 46, 49, 99–101,  
 138, 152, 156, 179  
 Storage ..... 50  
 Storage box ..... 54  
 Storage wells ..... 54  
 Sunshine sensor ..... 45  
 Sun visor ..... 50  
 Superfast charging ..... 145–146, 185  
 Suspension ..... 157  
 Switching off the engine ..... 86, 88  
 Synchronising the remote control ..... 34

**T**

Tables of engines ..... 185  
 Tables of fuses ..... 172, 174–175  
 Tank, fuel ..... 138–139  
 Technical data ..... 182, 184–185  
 Telephone ..... 51, 195–197, 218–220  
 Temperature, coolant ..... 20  
 Thermal comfort consumption indicator ..... 22  
 Thermal comfort equipment ..... 22  
 Thermal preconditioning of the passenger  
 compartment ..... 27, 49  
 Time (setting) ..... 198, 222  
 TMC (Traffic info) ..... 209  
 Tool box ..... 54  
 Tools ..... 162–164  
 Topping-up AdBlue® ..... 159  
 Top Tether (fixing) ..... 77, 79  
 Total distance recorder ..... 23  
 Touch screen ..... 25–27, 49

Touch-sensitive reading lamps ..... 53  
 Towball, quickly detachable ..... 147–149  
 Towbar ..... 68, 146  
 Towbar with quickly  
 detachable towball ..... 147–149  
 Towed loads ..... 181–182, 184  
 Towing another vehicle ..... 179–180  
 Traction battery ..... 22, 139–140, 185  
 Traction battery charge ..... 139, 143, 145–146  
 Traction control (ASR) ..... 67–68  
 Traffic information (TMC) ..... 209  
 Trailer ..... 68, 146  
 Trailer stability assist (TSA) ..... 68  
 Trajectory control systems ..... 67  
 Triangle, warning ..... 162  
 Trip computer ..... 24–25  
 Trip distance recorder ..... 23  
 Tyres ..... 157, 186  
 Tyre under-inflation detection ..... 101, 166

**U**

Under-inflation (detection) ..... 101  
 Unlocking ..... 28, 30  
 Unlocking from the inside ..... 32  
 Unlocking the boot ..... 29, 31  
 Unlocking the doors ..... 32  
 Unlocking the tailgate ..... 31  
 Updating the date ..... 198, 222  
 Updating the time ..... 198, 222  
 USB ..... 192, 212, 217

---

## V

Ventilation .....	45
Video .....	217
Visibility .....	48
Visiopark 1 .....	127
Voice commands .....	204–207

---

## W

Wallbox .....	141
Warning and indicator lamps .....	12
Warning lamp, driver's seat belt not fastened .....	71
Warning lamps .....	12, 23
Warning lamp, seat belts .....	71
Warnings and indicators .....	12
Washing .....	103
Washing (advice) .....	140, 160–161
Weights .....	181–182, 184
Welcome lighting .....	29, 58
Wheel, spare .....	157, 162–164, 166
Windscreen, heated .....	49
Windscreen wipers .....	60, 62
Wiper blades (changing) .....	61–62
Wiper, rear .....	61
Wipers .....	60, 62–63
Wipers, automatic rain sensitive .....	62–63























































Automobiles PEUGEOT declares, in accordance with the provisions of the European legislation (Directive 2000/53) relating to End-of-Life Vehicles, that it achieves the objectives set by this legislation and that recycled materials are used in the manufacture of the products that it sells.  
Reproduction or translation of all or part of this document is prohibited without written authorisation from Automobiles PEUGEOT.



**PEUGEOT**



AUTOMOBILES PEUGEOT - Siège Social : 7, rue Henri Sainte-Claire Déville - 92500 RUEIL-MALMAISON  
<http://www.peugeot.com>

Société anonyme au capital de 172.711.770 € - R.C.S.NANTERRE : 552 144 503

Printed in the EU  
11-19

[www.peugeot.com](http://www.peugeot.com)



**ANG. 19P24.0040**