

# YOUR 206 AT A GLANCE

1

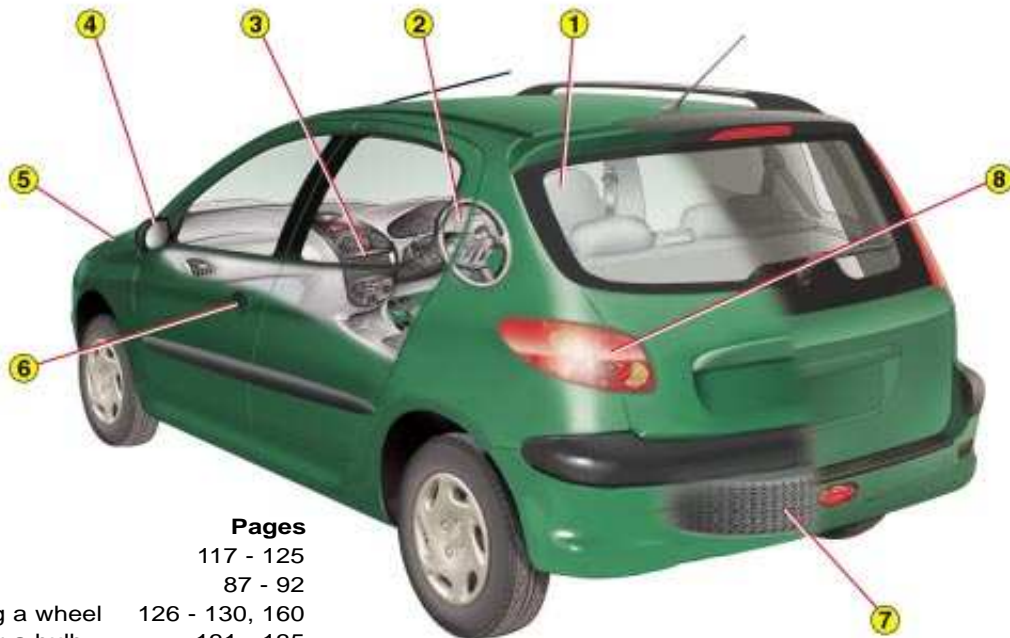

	Pages
1 Seats	74 - 85
2 Instruments and controls	29 - 31
3 Control panel	37 - 73, 97 - 98
4 Mirrors	100



	Pages
5 Checks	117 - 125
6 Access	87 - 92
7 Changing a wheel	126 - 130, 160
8 Changing a bulb	131 - 135

Each model may only be fitted with some of the equipment shown, according to its specification and the technical requirements in the country of first registration of the vehicle.

206 SW: version available according to country.

# YOUR 206 AT A GLANCE

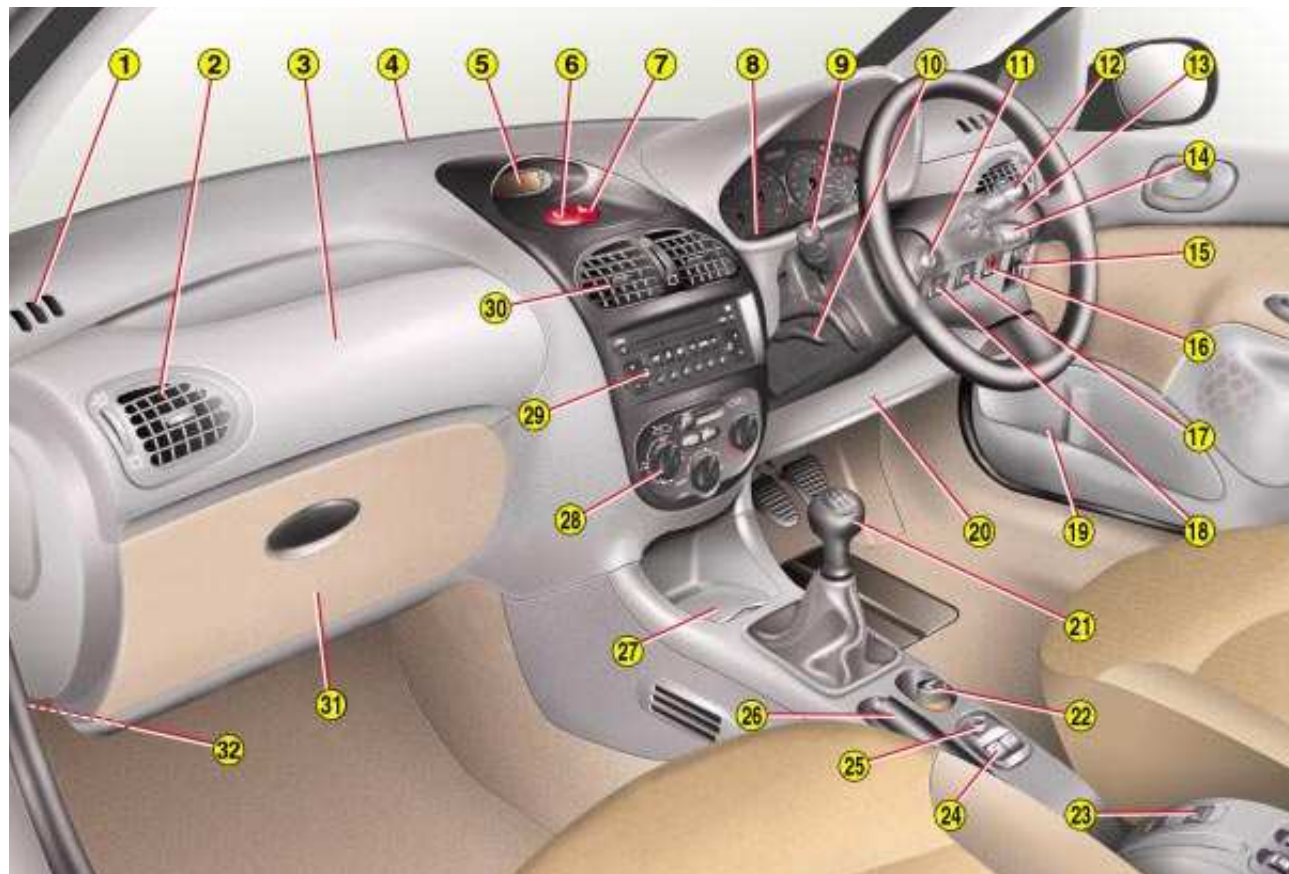

# YOUR 206 AT A GLANCE



- |  |  |  |
|--|--|--|
| <b>1</b> Side window demisting vents               | <b>13</b> Driver's air bag<br>Horn                   | <b>24</b> Front electric window switches   |
| <b>2</b> Adjustable side vent                      | <b>14</b> Audio equipment remote control             | <b>25</b> Electric mirrors switch  |
| <b>3</b> Passenger air bag                         | <b>15</b> Headlamp height adjustment                 | <b>26</b> Handbrake  |
| <b>4</b> Windscreen demisting vents                | <b>16</b> Passenger air bag disarming switch*        | <b>27</b> Front ashtray  |
| <b>5</b> Multifunction display                     | <b>17</b> Rear window locking switch                 | <b>28</b> Controls for heating, ventilation, air conditioning and heated rear screen and mirrors |
| <b>6</b> Central locking switch                    | <b>18</b> Dynamic stability control (ESP/ASR) button | <b>29</b> Audio equipment  |
| <b>7</b> Hazard warning lights switch              | <b>19</b> Storage compartment                        | <b>30</b> Adjustable centre vents  |
| <b>8</b> Instrument dials lighting rheostat        | <b>20</b> Fuse box                                   | <b>31</b> Glove box  |
| <b>9</b> Lights and direction indicators stalk     | <b>21</b> Gear lever                                 | <b>32</b> Bonnet opening control   |
| <b>10</b> Steering wheel height adjustment control | <b>22</b> Lighter                                    |  |
| <b>11</b> Steering lock                            | <b>23</b> Alarm button                               |  |
| <b>12</b> Windscreen wiper stalk                   |  |  |

\* According to destination.

# YOUR 206 AT A GLANCE



## KEYS

The keys enable you to switch on the ignition, independently operate the locks on the front doors and the tailgate (saloon) as well as operating the passenger air bag disarming switch and the fuel filler flap.

### Central locking

From the driver's door, you can lock and unlock the doors and the boot. If one of the doors, the boot (206 SW) or the rear screen (206 SW) is open, the central locking will not work.



## Remote control

Press button **A** to remotely lock the vehicle.

This is confirmed by fixed lighting of the direction indicators for approximately two seconds.

Press button **B** to remotely unlock the vehicle.

This is confirmed by rapid flashing of the direction indicators for approximately two seconds.

**206 SW:** press and hold button **B** to unlock the vehicle and open the rear screen.

## Key in ignition

If you leave the key in the ignition, a buzzer reminds you of this when opening the driver's door.

## Locating the vehicle

To locate your vehicle, when you have left it locked in a car park:

- ☞ press button **A**, the courtesy lights will switch on and the indicator lights flash for a few seconds.

## STARTING

**The 4 positions of the key in the ignition:**

### STOP position:

The ignition is off.

**1<sup>st</sup> notch, Accessories position:** the ignition is off but the accessories can be used.

**2<sup>nd</sup> notch, Running position:** the ignition is on.

### Starting position:

Operates the starter.

## Steering lock

Before starting, unlock the steering if necessary, by gently turning the steering wheel at the same time as you turn the key.

It is advisable to press the clutch pedal while operating the starter, to make starting easier.



# YOUR 206 AT A GLANCE



## KEYS

The keys enable you to switch on the ignition, independently operate the locks on the front doors and the tailgate (saloon) as well as operating the passenger air bag disarming switch and the fuel filler flap.

### Central locking

From the driver's door, you can lock and unlock the doors and the boot. If one of the doors, the boot (206 SW) or the rear screen (206 SW) is open, the central locking will not work.



## Remote control

Press button **A** to remotely lock the vehicle.

This is confirmed by fixed lighting of the direction indicators for approximately two seconds.

Press button **B** to remotely unlock the vehicle.

This is confirmed by rapid flashing of the direction indicators for approximately two seconds.

**206 SW:** press and hold button **B** to unlock the vehicle and open the rear screen.

## Key in ignition

If you leave the key in the ignition, a buzzer reminds you of this when opening the driver's door.

## Locating the vehicle

To locate your vehicle, when you have left it locked in a car park:

- ☞ press button **A**, the courtesy lights will switch on and the indicator lights flash for a few seconds.

## STARTING

**The 4 positions of the key in the ignition:**

### STOP position:

The ignition is off.

**1<sup>st</sup> notch, Accessories position:** the ignition is off but the accessories can be used.

**2<sup>nd</sup> notch, Running position:** the ignition is on.

### Starting position:

Operates the starter.

## Steering lock

Before starting, unlock the steering if necessary, by gently turning the steering wheel at the same time as you turn the key.

It is advisable to press the clutch pedal while operating the starter, to make starting easier.



## Starting a petrol engine

Do not press the accelerator.

Operate the starter, without releasing the key, until the engine turns.



## Starting a diesel engine

Do not press the accelerator.

Turn the key to the "Running" position.

If the engine is warm enough, the pre-heat light does not come on and you can start immediately.

If the pre-heat light comes on, wait for it to go out before operating the starter.

If the engine stalls, it is necessary to return the key to the "STOP" position before restarting.



*Never race a cold engine.  
Never run the engine in a confined space.*

*Do not make any modifications to the steering lock.*

## FRONT AIR BAGS

### Disarming the passenger air bag\*

Insert the ignition key into switch 1 and turn it to:

- the **ON** position; the passenger air bag is armed.
- the **OFF** position; the passenger air bag is disarmed.



### Operating check

With the ignition on (2<sup>nd</sup> notch of the ignition), illumination of this warning light, accompanied by an audible signal and the message "**Passenger air bag deactivated**" on the multifunction display, indicates that the passenger air bag is disarmed (switch in the "OFF" position).

*The warning light remains on throughout the disarming process.*



### Precautions regarding the passenger air bag

For a vehicle fitted with a disarming switch:



- disarm the air bag if you install a rear-facing child seat,
- arm the air bag for an adult passenger.

For a vehicle not fitted with a disarming switch:



- do not install a rear-facing child seat on the front passenger seat.

In no circumstances should you place your feet or any other object on the fascia.

\* According to destination.



# YOUR 206 AT A GLANCE



## STEERING WHEEL CONTROLS

### Lights

#### Front lights (ring A)



Lights off



Side lights



Dipped/  
main beam  
headlamps



Automatic  
switching on  
of lights

#### Automatic switching on of lights

To activate or deactivate the function, place the key in the accessories position with the lights stalk in position **0** and press the end of the stalk for more than four seconds.



#### Rear fog lamp (ring B)



Rear fog lamp  
(rotation of the ring  
forwards)

#### Front fog lamps/Rear fog lamp (ring C)



Front fog lamps  
(1<sup>st</sup> rotation of the ring  
forwards).



Front fog lamps and  
rear fog lamp (2<sup>nd</sup>  
rotation of the ring  
forwards).



### Windscreen wipers

#### Front

- 2 Fast wipe
- 1 Normal wipe
- I Intermittent wipe

or

- AUTO** Automatic wipe
- 0** Off
- ↓ Single wipe

Wash-wipe: pull the stalk towards you.

#### Rear

- Off
- Intermittent wipe
- Wash-wipe



#### Automatic wipe

In the **AUTO** position, the windscreen wiper operates automatically and **adjusts its speed to the intensity of the rainfall.**





## FRONT SEATS

- 1- Forwards/backwards adjustment.
- 2- Access to rear seats (3-door).
- 3- Seat back angle adjustment.
- 4- Height adjustment.
- 5- Head restraint height and angle adjustment.



*Never drive with the head restraints removed.*

## Modifiable passenger seat

### Access to the storage compartment

- Push the seat as far back as possible.
- Raise then pull the front of the seat to unlock it, then tilt the modifiable seat.





# YOUR 206 AT A GLANCE

## Rear seats

- Lift the front of the seat cushion **1**,
- Tilt the seat cushion **1** against the front seats,
- Position the seat belt under the belt holder **2**,
- Pull control **3** to unlock the seat back **4**,
- Remove or lower the head restraint,
- Tilt the seat back **4**.

When refitting, take care not to trap the seat belts.

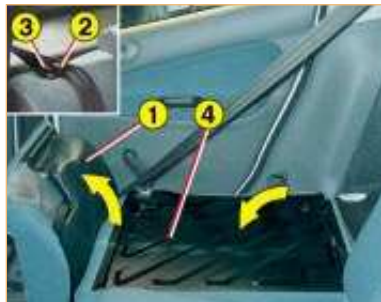

## Load space cover

To install:

- position **(1)** one end of the cover roller in one of the two supports,
- compress **(2)** the opposite end of the roller and position it,
- release it **(3)** so that it engages,
- unroll **(4)** the cover to the boot pillars,
- insert the cover guides in the rails on the pillars.

To remove:

- remove the cover guides from the rails on the pillars,
- return the cover to its roller, compress it and remove it from its support.

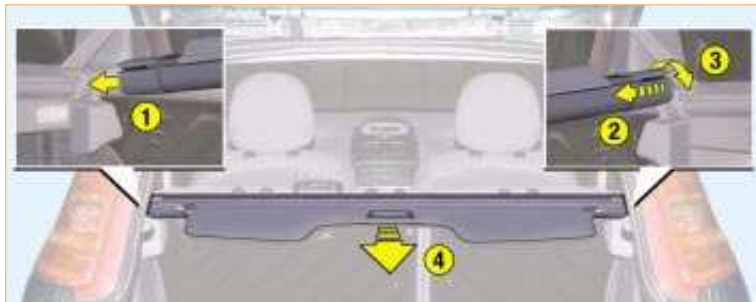
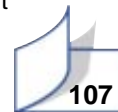

## Starting a petrol engine

Do not press the accelerator.

Operate the starter, without releasing the key, until the engine turns.



## Starting a diesel engine

Do not press the accelerator.

Turn the key to the "Running" position.

If the engine is warm enough, the pre-heat light does not come on and you can start immediately.

If the pre-heat light comes on, wait for it to go out before operating the starter.

If the engine stalls, it is necessary to return the key to the "STOP" position before restarting.



*Never race a cold engine.  
Never run the engine in a confined space.*

*Do not make any modifications to the steering lock.*

## FRONT AIR BAGS

### Disarming the passenger air bag\*

Insert the ignition key into switch 1 and turn it to:

- the **ON** position; the passenger air bag is armed.
- the **OFF** position; the passenger air bag is disarmed.



### Operating check

With the ignition on (2<sup>nd</sup> notch of the ignition), illumination of this warning light, accompanied by an audible signal and the message "**Passenger air bag deactivated**" on the multifunction display, indicates that the passenger air bag is disarmed (switch in the "OFF" position).

*The warning light remains on throughout the disarming process.*



### Precautions regarding the passenger air bag

For a vehicle fitted with a disarming switch:



- disarm the air bag if you install a rear-facing child seat,
- arm the air bag for an adult passenger.

For a vehicle not fitted with a disarming switch:



- do not install a rear-facing child seat on the front passenger seat.

In no circumstances should you place your feet or any other object on the fascia.

\* According to destination.

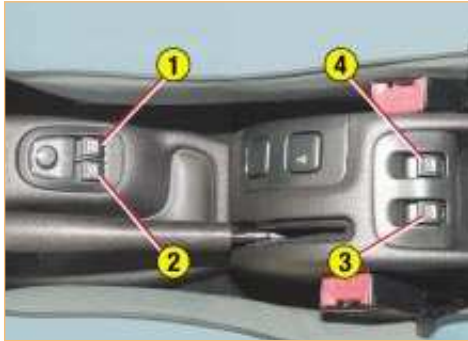

## ELECTRIC WINDOWS

### 1. Driver's electric window

**Manual operation:** press or pull the switch lightly. The window stops as soon as the switch is released.

**Automatic operation:** press or pull the switch firmly. One touch completely opens or closes the window.

Automatic opening and closing only operate when the engine is running.

### 2. Passenger's electric window.

### 3. Rear left electric window.

### 4. Rear right electric window.

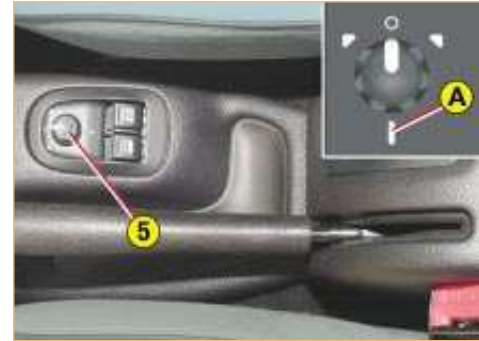

## ELECTRIC MIRRORS

Turn knob 5 to the right or to the left to select the corresponding mirror.

Move knob 5 in all four directions to adjust.

### Electric folding mirrors

With the ignition on, turn knob 5 to position A.



## DOORS



Front doors



Rear doors (206 SW)

LOCKING/UNLOCKING THE BOOT AND THE REAR SCREEN  
(206 SW)

*The boot and the rear screen cannot be opened simultaneously.*

With the rear screen closed, to open the **boot**, pull the handle **A** and lift.

With the boot closed, to open the **rear screen**, press and hold the unlocking button on the remote control or pull the handle **B**, then lift the rear screen using the windscreen wiper arm (at **C**).

**The lighting is switched on by opening the boot or the rear screen.**

**Note:** Close the rear screen using the windscreen wiper arm **C** or by pressing the centre of the window.





## STEERING WHEEL HEIGHT ADJUSTMENT

When stationary, lower the handle to unlock the steering wheel. Adjust to the desired height and lift the handle to lock the steering wheel.



## OPENING THE BONNET

**From inside the vehicle:** pull the handle.



**From the outside:** lift the catch and raise the bonnet. Secure the strut to hold the bonnet open.



101



92

## THE AUTOMATIC AUTOADAPTIVE GEARBOX

### Starting

To start the engine, place the selector lever in position **N** or **P**. **Press the brake to leave position P** and when selecting forward or reverse gears.

### Position of the selector lever







This is shown by an indicator on the instrument panel.



- P. Park.
- R. Reverse.
- N. Neutral.
- D. Drive: in this position, all four gears change automatically.
- 3. Automatic changing of the first three gears only.
- 2. Automatic changing of the first two gears only.
- A. Sport programme.
- B. Snow programme.



## HEATING/AIR CONDITIONING

N°	Symbol	Function
1		Setting the air distribution.
2		Air intake control.
3		Temperature adjustment.
4		Demisting the rear screen and mirrors.
5		Air flow adjustment.
6		Air conditioning control.



68



70

# YOUR 206 AT A GLANCE



## AUTOMATIC AIR CONDITIONING



N°	Symbol	Function
1		Air flow adjustment.
2		Setting the air distribution.
3		Air intake control.
4		Air conditioning control.
5		Demisting the rear screen and mirrors.
6		Switching off.
7		Temperature adjustment.
8		Automatic comfort programme.
9		Automatic visibility programme.

# PEUGEOT SERVICING

---

## PEUGEOT SERVICING

Your vehicle benefits from extended service intervals.

- For petrol engines: every 20 000 miles (30 000 km) or every two years.
- For direct injection diesel engines: every 12 000 miles (20 000) km or every two years.
- For indirect injection diesel engines: every 10 000 miles (15 000 km) or every two years.

**The extension of the service intervals means that the engine oil level must be checked regularly: topping up of the oil between oil changes is normal.**

**This is why the PEUGEOT network is offering you an intermediate service between regular services.**

**The date of this visit is not shown by the service indicator. It is to be carried out at least every 10 000 miles (15 000 km) for saloon and 206 SW petrol engines; every 6 000 miles (10 000 km) for 206 GTi 180 direct injection diesel engines and every 5 000 miles (7 500 km) for indirect injection diesel engines.**

**A PEUGEOT dealer will carry out a quick check and top up the levels if necessary (oil, coolant, windscreen wash up to 2 litres).**

**If the oil level is too low there is a risk of serious damage to the engine: check the engine oil level at least every 2 000 to 3 000 miles (3 000 to 5 000 km), depending on the conditions of use.**

This extended servicing has been made possible by modifications to our vehicles and to the lubricants:

**THUS IT IS ESSENTIAL TO USE ONLY ENGINE LUBRICANTS THAT ARE SUITED TO YOUR ENGINE AND RECOMMENDED BY THE MANUFACTURER (see "Lubraicants" pages).**

# PEUGEOT SERVICING

---

## SPECIAL FEATURES

Some of your vehicle's vital components have specific servicing schedules.

The **brake fluid** must be replaced **every 40 000 miles (60 000 km)** or every 2 years.

The **passenger compartment filter** must be checked **at each visit** to the PEUGEOT dealer (intermediate visits and regular services).

The **timing belt**: consult your PEUGEOT dealer.

### Arduous conditions of use

If the vehicle is used in certain particularly arduous conditions:

- **Continuous door-to-door use.**
- **Town use (e.g. taxi).**
- **Repeated short journeys, with the engine cold in low temperatures.**

Or in long stays in the following conditions:

- Hot countries with temperatures often above 30 °C.
- Cold countries with temperatures often below minus 15 °C.
- Countries with a dusty atmosphere.
- Countries whose lubricants or fuels do not conform to our recommendations.

It is necessary to follow an "Arduous Conditions" servicing schedule, which includes:

- shorter service intervals:
  - Every 10 000 miles (15 000 km) or every year for 206 GTi petrol engine vehicles.
  - Every 12 000 miles (20 000 km) or every year for saloon or 206 SW petrol engine vehicles.
  - Every 10 000 miles (15 000 km) or every year for Direct Injection Diesel engine vehicles.
  - Every 6 000 miles (10 000 km) or every year for Indirect Injection Diesel engine vehicles.
- special operations:
  - Replacement of the air filter every 15 000 km for the 206 RC.

## PEUGEOT SERVICING

### SERVICE INDICATOR

This is a visual reminder of when the next service is due. This service is to be carried out according to the manufacturer's servicing schedule.

#### Operation

As soon as the ignition is switched on and for 5 seconds, the spanner symbolising "service operation" is lit. The trip recorder display shows you the distance remaining (in round figures) before the next service.

**Example:** 4,800 miles remain before the next service is due. When the ignition comes on and for 5 seconds the display indicates:



5 seconds after the ignition is switched on, the total distance recorder resumes normal operation and the display shows the total or trip distances.



**The distance remaining before the next service is less than 500 miles.**

**Example:** 400 miles remain before the next service is due.

When switching on the ignition and for 5 seconds, the display shows:



5 seconds after the ignition is switched on, the total distance recorder resumes normal operation and the symbol remains lit.

This indicates that a service should be carried out shortly. The display shows the total or trip distances.



**The service is overdue.**

Each time the ignition is switched on and for 5 seconds, the symbol and the excess distance flash.

**Example:** the service is overdue by 300 miles. The service should be carried out very shortly. When the ignition is switched on and for 5 seconds, the display shows:



5 seconds after the ignition is switched on, the total distance recorder resumes normal operation and the symbol remains lit. The display shows the total or trip distances.



# PEUGEOT SERVICING

---

## Resetting the service indicator



Your PEUGEOT dealer carries out this operation after each service.

However, if you carry out the service yourself, the reset procedure is as follows:

- Switch off the ignition.
- Press and hold button **1**.
- Switch on the ignition.

The display begins a 10 second countdown.

- Keep button **1** pressed for 10 seconds.
- The display shows [= **0**] and the service symbol disappears.



# PEUGEOT SERVICING

## TYPES OF SERVICE











Each vehicle has its own servicing cycle, based upon the engine type.

This cycle consists of alternating two types of service, A and C, intermediate visits and a few additional operations depending on your vehicle; these correspond to key stages in the life of your vehicle.

When the first service is carried out and at each subsequent service, your dealer will advise you of the type and content of the next service due.

## THE MAINTENANCE CYCLE FOR YOUR SALOON and 206 SW PETROL

Service every 20,000 miles (30,000 km) or 2 years.

MILES (KM)		20,000 (30,000)		40,000 (60,000)		60,000 (90,000)	
<b>1st service at 6,000 miles (10,000 km) or 6 months*.</b> This is necessary in order to benefit from the warranty							
							
80,000 (120,000)	100,000 (150,000)	120,000 (180,000)	140,000 (210,000)	160,000 (240,000)			
							

These services are to be carried with at least **10W40 synthetic based oil**.  
They can also be carried out with **5W30 Fuel Economy oil** or with **5W40 synthetic oil**.

**Arduous conditions of use** (see corresponding section).

\* Whichever comes first.



Intermediate top-up visit included in  
the Servicing Schedule.

# PEUGEOT SERVICING

## TYPES OF SERVICE













Each vehicle has its own servicing cycle, based upon the engine type.

This cycle consists of alternating two types of service, A and C, intermediate visits and a few additional operations depending on your vehicle; these correspond to key stages in the life of your vehicle.

When the first service is carried out and at each subsequent service, your dealer will advise you of the type and content of the next service due.

## THE MAINTENANCE CYCLE FOR YOUR SALOON and 206 SW PETROL

Service every 20,000 miles (30,000 km) or 2 years.

MILES (KM)		20,000 (30,000)		40,000 (60,000)		60,000 (90,000)	
<b>1st service at 6,000 miles (10,000 km) or 6 months*.</b> This is necessary in order to benefit from the warranty		 		 		 	
		 		 		 	
80,000 (120,000)	100,000 (150,000)	120,000 (180,000)	140,000 (210,000)	160,000 (240,000)			

These services are to be carried with at least **10W40 synthetic based oil**.  
They can also be carried out with **5W30 Fuel Economy oil** or with **5W40 synthetic oil**.

**Arduous conditions of use** (see corresponding section).

\* Whichever comes first.



























Intermediate top-up visit included in  
the Servicing Schedule.

# PEUGEOT SERVICING

## THE MAINTENANCE CYCLE FOR YOUR 206 GTi 180\*\*

Service every 12,000 miles (20,000 km) or 2 years.

MILES (KM)		12,000 (20,000)	24,000 (40,000)	36,000 (60,000)	48,000 (80,000)	60,000 (100,000)							
<b>1st service at 6,000 miles (10,000 km) or 6 months*.</b> This is necessary in order to benefit from the warranty													
72,000 (120,000)	84,000 (140,000)	96,000 (160,000)	108,000(180,000)	120,000 (200,000)	132,000 (220,000)	144,000 (240,000)							
													

These services are to be carried with **5W40 synthetic based oil** only.

**Arduous conditions of use** (see corresponding section).

\* Whichever comes first.

\*\* During the year, according to destination.















Intermediate top-up visit included in the Servicing Schedule.

# PEUGEOT SERVICING

## THE MAINTENANCE CYCLE FOR YOUR 206 TURBO DIESEL HDI

Service every 12,000 miles (20,000 km) or 2 years.

MILES (KM)		12,000 (20,000)	24,000 (40,000)	36,000 (60,000)	48,000 (80,000)	60,000 (100,000)
<b>1st Service at 6,000 miles (10,000 km) or 6 months*.</b> This is necessary in order to benefit from the warranty.						
72,000 (120,000)	84,000 (140,000)	96,000 (160,000)	108,000 (180,000)	120,000 (200,000)	132,000 (220,000)	144,000 (240,000)
						

These services are to be carried out with **10W40 synthetically based oil** minimum. They can also be carried out with **5W30 Fuel Economy oil** or with **5W40 synthetic oil**.

**Arduous conditions of use** (see corresponding section).

\* Whichever comes first.





































Intermediate top-up visit incorporated in the Servicing Schedule.

# PEUGEOT SERVICING

## THE MAINTENANCE CYCLE FOR YOUR 206 INDIRECT INJECTION DIESEL

Service every 10,000 miles (15,000 km) or 2 years.

MILES (KM)		10,000 (15,000)	20,000 (30,000)	30,000 (45,000)	40,000 (60,000)
<b>1st Service at 6,000 miles 10,000 km or 6 months*.</b> This is necessary in order to benefit from the warranty.					
					
50,000 (75,000)	60,000 (90,000)	70,000 (105,000)	80,000 (120,000)	90,000 (135,000)	100,000 (150,000)
					
					
110,000 (165,000)	120,000 (180,000)	130,000 (195,000)	140,000 (210,000)	150,000 (225,000)	160,000 (240,000)
					
					
					

These services are to be carried out with **10W40 synthetically based oil** minimum. They can also be carried out with **5W30 Fuel Economy oil** or with **5W40 synthetic oil**.

**Arduous conditions of use** (see corresponding section).

\* Whichever comes first.



Intermediate top-up visit incorporated in the Servicing Schedule.

# PEUGEOT SERVICING

## A & C SERVICE LEVELS AND THE INTERMEDIATE VISIT

Operations	Description of operation	1st service	Level		
			A	C	Intermediate
DRAIN/REFILL	- Engine oil	●	●	●	
	- Bleed fuel filter (diesel)	●	●	●	
REPLACE	- Oil filter		●	●	
	- Fuel filter* (petrol)			●	
	- Fuel filter element (diesel)			●	
	- Air filter element			●	
	- Spark plugs (petrol)			●	
LEVEL	- Engine oil (check + top-up)	●			●
	- Manual gearbox oil (check + top-up)	●		●	
	- Battery (check + top-up) if cap is removable		●	●	
	- Screen wash front/rear (check + top-up)	●	●	●	●
	- Coolant (check + top-up)	●	●	●	●
	- Brake fluid (check + top-up)	●	●	●	
	- Power steering fluid (check + top up according to specification)	●	●	●	
CHECK	- Operation of lights and indicators	●	●	●	
	- Condition of glass, headlamp and light lenses and mirrors		●	●	
	- Horn		●	●	
	- Windscreen washer jets		●	●	
	- Condition of wiper blades		●	●	
	- Condition and tension of the ancillary drive belts		●	●	
	- Handbrake		●	●	
	- Condition of hydraulic circuits (hoses and covers)		●	●	
	- Condition of rubber boots and gaiters	●	●	●	
	- Brake pads		●	●	o
	- Play in hubs, link rods, ball joints, flexible mountings		●	●	
	- Shock absorbers		●	●	
	- Rear drum brake lining wear		●	●	
	- Condition and pressure of tyres (including spare wheel)	●	●	●	
	- Emission control check as per current legislation (petrol)	●	●	●	
	- Smoke opacity (diesel)	●	●	●	
- Passenger compartment filter (according to specification)		●	●	o	
- Visual check of the whole vehicle	●			●	
SERVICE*	- Courtesy vehicle			●	
ROAD TEST			●	●	





# TRADE NAMES OF RECOMMENDED ENGINE LUBRICANTS IN EUROPE<sup>(1)</sup>

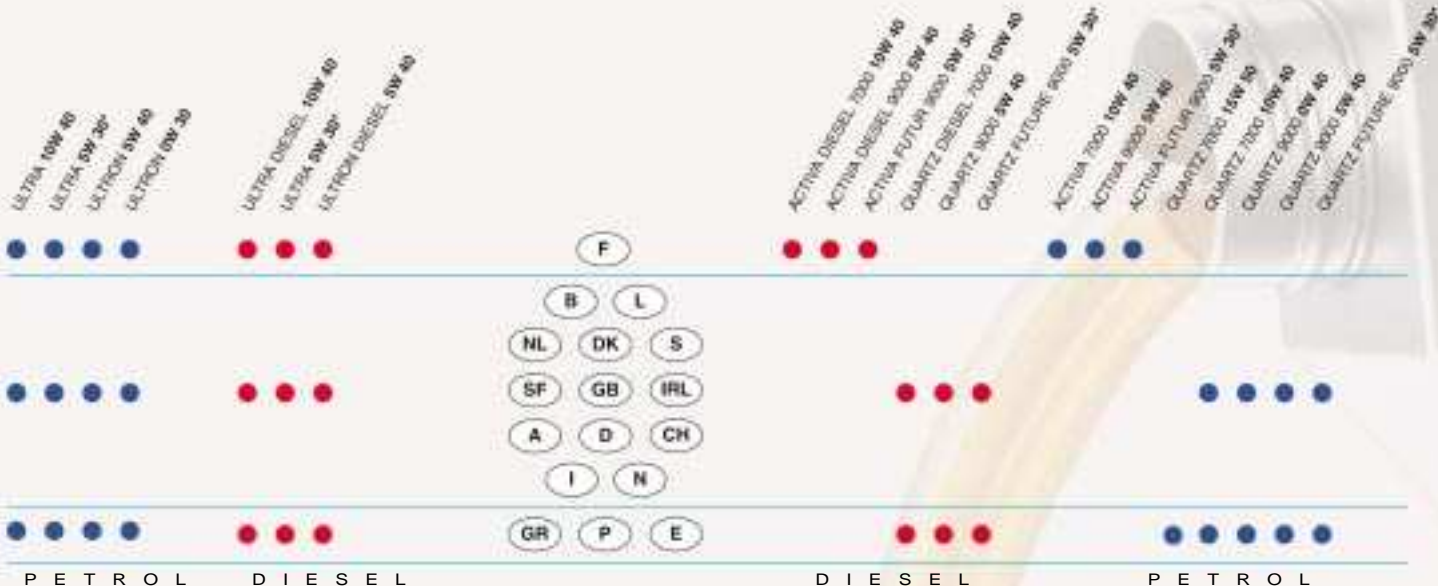

(1) Minimum quality standard: Petrol engines: ACEA A3 and API SH/SJ; Diesel engines: ACEA B3 and API CF/CD  
**ACEA** = Association des Constructeurs Européens Automobiles (Association of European Automobile Manufacturers) -  
**API** = American Petroleum Institute.

If oil is used which does not conform to the ACEA A3-B3 standards, this requires the "Arduous Conditions" servicing schedule to be followed, which involves shorter intervals between services.

**Use 5W40 synthetic oil only for the 2.0 litre 16V 180 bhp engine.**

# PEUGEOT SERVICING

## Recommended lubricants

The oils which appear in the previous table are suitable for most purposes.

The diagram opposite states the optimum range of viscosity depending on the temperatures at which the oils are to be used.

It is also possible to use "superior quality" synthetic oils.

In the absence of semi-synthetic or synthetic oils, oils of API SH/SJ quality (for petrol engines), or CD/CF quality (for diesel engines) may be used by following the "Arduous Conditions" servicing schedule which specifies shorter intervals.

Do not hesitate to ask for advice from a PEUGEOT dealer to maintain driving pleasure and to minimise the maintenance cost of your vehicle.

For countries outside Europe, please contact a local PEUGEOT dealer.

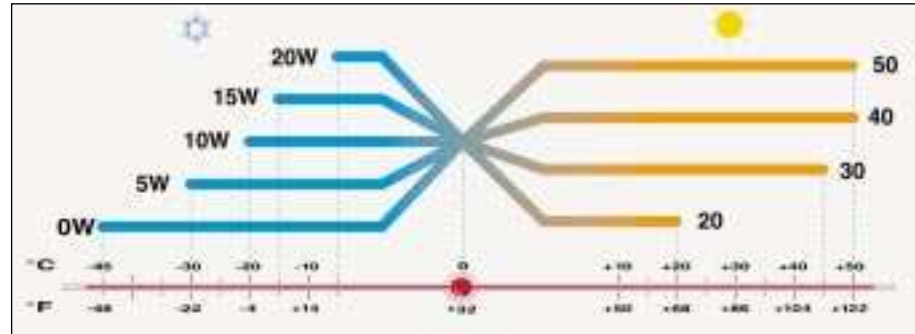

		
Manual Gearbox	<b>ONLY</b> ESSO GEAR OIL BV 75W80 PR 9736.41	<b>ONLY</b> TOTAL TRANSMISSION BV 75W80
Automatic Gearbox	<b>ONLY</b> ATF 4HP20-AL4 PR 9736.22	
Power steering	ESSO ATF D PR 9730.94	TOTAL FLUIDE AT42

## Other recommended products

Brake fluid	PEUGEOT DOT4
Coolant	PROCOR TM108/GLYSANTIN G33 or REVKOGEL 2000 <b>ONLY</b> protection to minus 35 °C

# INSTRUMENTS AND CONTROLS

## INSTRUMENT DIALS: PETROL - DIESEL MANUAL GEARBOX (saloon and 206 SW)



1. Seat belt not fastened warning light\*
2. Passenger air bag disarming warning light\*
3. Front and side air bags warning light
4. Front fog lamps indicator light
5. Anti-lock braking system (ABS) warning light
6. Rear fog lamp indicator light
7. Diesel pre-heat warning light
8. Left hand direction indicator
9. Total distance recorder, service indicator and engine oil level indicator

10. Right hand direction indicator
11. Engine diagnostics warning light
12. Main beam headlamps indicator light
13. Handbrake, low brake fluid level and electronic brake force distribution warning light
14. Dipped beam headlamps indicator light
15. Battery charge warning light
16. Engine oil pressure and temperature warning light
17. Water in diesel filter warning light
18. Coolant temperature and low level warning light

19. Engine oil temperature indicator
20. Total distance recorder button
21. Central (STOP) warning light
22. Speedometer
23. Coolant temperature indicator
24. Rev counter
25. Lighting-rheostat button
26. Fuel gauge
27. Low fuel level warning light
28. Dynamic stability control (ESP/ASR) warning light

\* According to destination.

# INSTRUMENTS AND CONTROLS

## INSTRUMENT DIALS: PETROL MANUAL GEARBOX (206 GTi 180\*\*)



1. Seat belt not fastened warning light\*
2. Passenger air bag disarming warning light\*
3. Front and side air bags warning light
4. Front fog lamps indicator light
5. Anti-lock braking system (ABS) warning light
6. Rear fog lamp indicator light
7. Left hand direction indicator
8. Total distance recorder, service indicator and engine oil level indicator

9. Right hand direction indicator
10. Engine diagnostics warning light
11. Main beam headlamps indicator light
12. Handbrake, low brake fluid level and electronic brake force distribution warning light
13. Dipped beam headlamps indicator light
14. Battery charge warning light
15. Engine oil pressure and temperature warning light
16. Coolant temperature and low level warning light

17. Engine oil temperature indicator
18. Total distance recorder button
19. Central (STOP) warning light
20. Speedometer
21. Coolant temperature indicator
22. Rev counter
23. Lighting-rheostat button
24. Fuel gauge
25. Low fuel level warning light
26. Dynamic stability control (ESP/ASR) warning light

\* According to destination.

\*\* During the year, according to destination.

# INSTRUMENTS AND CONTROLS

## INSTRUMENT DIALS: PETROL AUTOMATIC GEARBOX (saloon and 206 SW)



1. Seat belt not fastened warning light\*
2. Passenger air bag disarming warning light\*
3. Front and side air bags warning light
4. Front fog lamps indicator light
5. Anti-lock braking system (ABS) warning light
6. Rear fog lamp indicator light
7. Left hand direction indicator
8. Total distance recorder, service indicator and engine oil level indicator

9. Right hand direction indicator
10. Engine diagnostics warning light
11. Main beam headlamps indicator light
12. Handbrake, low brake fluid level and electronic brake force distribution warning light
13. Dipped beam headlamps indicator light
14. Battery charge warning light
15. Engine oil pressure and temperature warning light
16. Coolant temperature and low level warning light
17. Operating programmes

18. Gear indicator
19. Total distance recorder button
20. Central (STOP) warning light
21. Speedometer
22. Coolant temperature indicator
23. Rev counter
24. Lighting-rheostat button
25. Fuel gauge
26. Low fuel level warning light
27. Dynamic stability control (ESP/ASR) warning light

\* According to destination.



# INSTRUMENTS AND CONTROLS

## INSTRUMENTS AND CONTROLS

A permanently lit warning light or one flashing, with the engine running, indicates an operating fault of the unit concerned. The illumination of certain warning lights may be accompanied by an audible signal and a message on the multifunction display. Do not ignore this warning: consult a PEUGEOT dealer as soon as possible.

If the central STOP warning light comes on when you are driving, stop your vehicle immediately, where it is safe to do so.



### Central (STOP) warning light

Linked to the "engine oil pressure", "coolant temperature and low coolant level", "handbrake", "low brake fluid level" and "electronic brake force distribution system fault" warning lights.

**You must stop if the light flashes with the engine running.**

Consult a PEUGEOT dealer.



### Engine oil pressure and temperature warning light

Linked to the central (STOP) warning light.

**You must stop.**

This warning light indicates one of the following:

- insufficient oil pressure,
- a lack of oil in the lubrication circuit. Top up the level.
- an oil temperature which is too high. The warning light is accompanied by an audible signal. To lower the oil temperature, reduce your speed.

Consult a PEUGEOT dealer.



### Coolant temperature and low coolant level warning light

Linked to the central (STOP) warning light.

**You must stop.**

Wait for the engine to cool before topping up the level.

The cooling circuit is pressurised.

In the event of breakdown and to prevent any risk of burns, unscrew the cap by two turns to allow the pressure to drop.

When the pressure has dropped, remove the cap and top up the level.

Consult a PEUGEOT dealer.



### Handbrake, low brake fluid and Electronic Brake Force Distribution system fault warning light

Linked to the central (STOP) warning light.

This indicates one of the following:

- that the handbrake is applied or not fully released,
- an excessive drop in brake fluid level (if the warning light remains on even when the handbrake is released).
- a fault in the Electronic Brake Force Distribution system, if lit at the same time as the ABS warning light.

**You must stop.**

Consult a PEUGEOT dealer.



### Anti-lock braking system (ABS) warning light

This comes on for 3 seconds each time the ignition is switched on.

If the warning light remains on or comes on above 8 mph (12 km/h), this indicates an ABS malfunction.

However, the vehicle retains conventional servo-assisted braking.

Lighting of this warning light is accompanied by an audible signal and the message "ABS fault" on the multifunction display.

Consult a PEUGEOT dealer.



## INSTRUMENTS AND CONTROLS



### Dynamic stability control system (ESP/ASR) warning light

This comes on for a few seconds each time the ignition is switched on.

Consult a PEUGEOT dealer if the ESP/ASR switch indicator light flashes and this warning light remains on or comes on with the engine running, vehicle moving.

With the engine running and the vehicle moving, it flashes if the system is activated.

It lights permanently when the system is disarmed.



### Battery charge warning light

This indicates one of the following:

- faulty operation of the charging circuit,
- slack battery or starter terminals,
- a cut or slack alternator belt,
- an alternator failure.

Consult a PEUGEOT dealer.



### Engine diagnostics warning light

This comes on each time the ignition is switched on.

If it comes on with the engine running, this indicates incorrect operation of the injection, ignition or emission control system. There is a risk of damage to the catalytic converter (petrol engine only).

Consult a PEUGEOT dealer.



### Diesel engine pre-heat warning light

Wait until the warning light goes out before starting the engine.

If the temperature is high enough, the warning light comes on for less than one second. You can start the engine without waiting.



### Low fuel level warning light

When this light first comes on, you have enough fuel to drive at least 30 miles (50 km). The tank capacity is approximately 50 litres.



### Water in diesel filter indicator\*

Consult a PEUGEOT dealer as soon as possible.

There is a risk of damage to the injection system.



### Seat belt not fastened warning light\*

When the ignition is switched on, this indicator light comes on if the driver has not fastened his seat belt.



### Passenger air bag disarming warning light\*

Illumination of this warning light is accompanied by an audible signal and the message "**Passenger air bag deactivated**" on the multifunction display.

If the passenger air bag is disarmed, the warning light comes on when the ignition is switched on and it remains on.

Always consult a PEUGEOT dealer if the warning light flashes.



### Front and side air bags warning light

The light will come on for a few seconds when the ignition is switched on.

With the engine running, illumination of this warning light is accompanied by an audible signal and a message on the multifunction display indicating a fault in the air bags.

Consult a PEUGEOT dealer.

\* According to destination.

## INSTRUMENTS AND CONTROLS

---



### Coolant temperature indicator

- needle in zone **(A)**, the temperature is correct,
- needle in zone **(B)**, the temperature is too high. The central **STOP** warning light flashes.

#### **You must stop.**

Consult a PEUGEOT dealer.



### Engine oil temperature indicator

With the engine running, this indicates the oil temperature:

- needle in zone **(C)**, the temperature is correct,
- needle in zone **(D)**, the temperature is too high. To lower the oil temperature, reduce your speed.

# INSTRUMENTS AND CONTROLS

## Instrument panel display

After switching on the ignition, three functions are shown in succession:

- service indicator (see corresponding section),
- engine oil level indicator,
- total distance recorder (total or trip distances).

**Note:** the total or trip distances are displayed for 30 seconds when the ignition is switched off, on opening the driver's door, as well as on locking and unlocking the vehicle.

## Engine oil level

When the ignition is switched on, the engine oil level is indicated for approximately 10 seconds, after the servicing information.



### Maximum oil level

If the flashing of the six squares is confirmed by checking using the dipstick, a surplus of oil can cause damage to the engine.

Consult a PEUGEOT dealer without delay.



### Lack of oil

Flashing of the six segments and "min" on the display indicate a lack of oil which can cause damage to the engine.

If the lack of oil is confirmed by checking using the dipstick, it is essential to top up the level.



### Oil level gauge fault

Flashing of the six segments indicates a fault in the oil level gauge.

There is a risk the engine will be damaged.

Consult a PEUGEOT dealer.

**The level indicated when checking using the dipstick is only correct if the vehicle has been on level ground, with the engine stopped, for more than 10 minutes.**

## INSTRUMENTS AND CONTROLS

### Total distance records



Briefly pressing button **1** alternates between the total and trip distance displays.

To reset the trip recorder to zero, when it is displayed press the button for more than 3 seconds.

### Lighting rheostat



With the lights on, press the button to vary the intensity of the lighting of the instruments and controls. When the lighting reaches the minimum (or maximum) setting, release the button then press it again to increase (or reduce) the brightness.

As soon as the lighting is of the required brightness, release the button.



### HAZARD WARNING LIGHTS

Press the button, the direction indicators flash.

They can operate with the ignition off.

### Automatic lighting of hazard warning lights\*

When braking in an emergency, depending on the force of deceleration, the hazard warning lights come on automatically. They switch off automatically the first time you accelerate.

It is also possible to switch them off by pressing the button.

\* According to destination.

## YOUR 206 IN DETAIL

### DISPLAY A



This displays the following information:

- the time,
- the date,
- the outside temperature (this flashes if there is a risk of ice),
- the audio system displays,
- a door check (e.g.: "left front door open"),
- warning messages (e.g. "remote control battery flat") or information messages (e.g. "economy mode active"), displayed temporarily.

### Adjusting the parameters

Press and hold button **1** for two seconds to access the settings; the data flashes, indicating it is ready to be modified.

Then, each press of button **1** scrolls through the various data in the following order:

- language of information displayed,
- hours (12 then 24 hour mode),
- minutes,
- year,
- month,
- day,
- unit of temperature (degrees Celsius or Fahrenheit).

Pressing button **2** alters the value of the parameter selected. Press and hold for rapid advance (return to start after the last possible value).

After 7 seconds with no action, the main display returns; the modified data are now recorded.

**Note:** Pressing button **2** briefly displays the outside temperature for a few seconds.

## YOUR 206 IN DETAIL

### DISPLAY B



This enables the following information to be displayed:

- the time,
- the date,
- the outside temperature (this flashes when there is a risk of ice),
- the radio displays,
- the status of the doors. The display shows you, by means of a graphic, whether a door is open,
- the warning messages (e.g. "battery charge low") or information messages (e.g. "fuel tank low"), displayed temporarily, can be cleared by pressing button **1** or **2**,
- the trip computer.

### Setting the parameters

Press and hold button **1** for two seconds to access the settings. The data flashes, indicating it is ready to be modified.

Then, individual presses on button **1** allow you to scroll through the various data in the following sequence:

- language in which the information is displayed,
- unit of distance (kms or miles),
- unit of temperature (degrees Celsius or Fahrenheit),
- time format (12 then 24 hour mode),
- hour,
- minutes,
- year,
- month,
- day.

Pressing button **2** allows you to change the data selected. Maintain the pressure for rapid scrolling.

After 7 seconds without moving, the main display returns; the modified data are now recorded.

## YOUR 206 IN DETAIL

### DISPLAY C



This enables the following information to be displayed:

- the time,
- the date,
- the outside temperature (this flashes when there is a risk of ice),
- the radio displays,
- the status of the doors. The display shows you, by means of a graphic, whether a door is open,

- the warning messages (e.g. "fuel level low"), displayed temporarily. These can be cleared using the remote control,
- the trip computer (see corresponding section),
- the satellite navigation system (see corresponding section).

### Setting the parameters

The remote control allows you to access the settings. Accessing the different menus is described in the section "Satellite Navigation System".

## YOUR 206 IN DETAIL

### AUDIO RB3

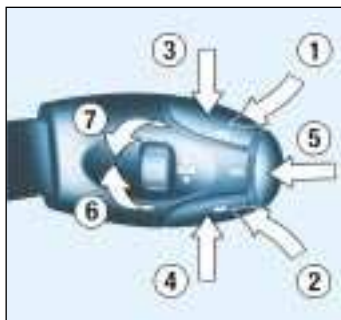

Stalk movement	Function
1 - Press (behind)	Increase volume
2 - Press (behind)	Decrease volume
1 + 2 - Simultaneous press	Sound cut-off (mute); restoring of the sound by pressing any button
3 - Press	Automatic search of higher frequencies (radio) - Selection of the next track (CD)
4 - Press	Automatic search of lower frequencies (radio) - Selection of the previous track (CD)
5 - Press the end	Change of source (radio/cassette/CD changer)
6 - Rotation (clockwise)	Selection of next station stored in memory (radio) - Selection of next CD
7 - Rotation (anti-clockwise)	Selection of previous station stored in memory (radio) - Selection of previous CD



## YOUR 206 IN DETAIL

Button		Function
<b>A</b>		<b>Radio on/off</b>
<b>B</b>	–	Decrease volume
<b>C</b>	+	Increase volume
<b>D</b>	<b>RDS</b>	RDS function on/off Press for more than 2 seconds: regional following mode on/off
<b>E</b>	<b>TA</b>	Traffic information priority on/off
<b>F</b>		Press fully: cassette rewind
<b>G</b>		Press fully: cassette fast forward
<b>F+G</b>	◀▶ ◀◀▶▶	Press half way: reversal of direction of play of the cassette Press fully: ejection of the cassette
<b>H</b>	🎵	Adjustment of bass, treble, loudness, sound distribution and automatic volume correction
<b>I</b>	▲	Increase the setting of the functions associated with button <b>H</b>
<b>J</b>	▼	Decrease the setting of the functions associated with button <b>H</b>
<b>K</b>	<b>SRC</b>	Selection of source: radio, cassette or CD changer Press for more than 2 seconds: CD shuffle
<b>L</b>	▶▶	Manual and automatic search of higher frequency Selection of next CD track and PTY (radio)
<b>M</b>	<b>MAN</b>	Manual/automatic operation of buttons <b>L</b> and <b>N</b> in radio mode
<b>N</b>	◀◀	Manual and automatic search of lower frequency Selection of previous CD track and PTY (radio)
<b>O</b>	<b>BND</b> <b>AST</b>	Selection of FM1, FM2, FMast and AM wavebands Press for more than 2 seconds: automatic storing of stations in memory (autostore)
<b>1 to 6</b>	<b>1 2 3 4 5 6</b>	Selection of station stored in memory - Selection of a CD changer disc Press for more than 2 seconds: storing of a station in memory

## YOUR 206 IN DETAIL

---

### GENERAL FUNCTIONS



#### On/off

With the ignition key in the accessories or ignition position, press button **A** to switch the audio system on or off.

**The audio system can operate for 30 minutes without the vehicle ignition being switched on.**

### Anti-theft system

The audio system is coded in such a way that it can operate only on your vehicle. It would not function if fitted to another vehicle

**The anti-theft system is automatic and requires no action on your part.**

### ADJUSTING THE VOLUME

Press button **C** to increase the volume, or button **B** to decrease it.

Continuous pressure on buttons **C** and **B** allows a gradual adjustment of the volume.

### AUDIO SETTINGS



Press button **H** several times in succession to access the bass (**BASS**), treble (**TREB**), loudness (**LOUD**), fader (**FAD**), balance (**BAL**) and automatic volume correction settings.

Exit from audio mode is automatic after a few seconds without pressing any button, or by pressing button **H** after configuration of the automatic volume correction.

**Note:** bass and treble settings are specific to each source. It is possible to set them differently for radio, cassette (**RB3**), CD (**RD3**) and CD changer.

## YOUR 206 IN DETAIL

---

### Adjusting the bass



When "**BASS**" is displayed, press button **I** or **J** to vary the setting.

- "**BASS –9**" for a minimum bass setting,
- "**BASS 0**" for a normal setting,
- "**BASS +9**" for a maximum bass setting.

### Adjusting the treble

When "**TREB**" is displayed, press button **I** or **J** to vary the setting.

- "**TREB –9**" for a minimum treble setting,
- "**TREB 0**" for a normal setting,
- "**TREB +9**" for a maximum treble setting.

### Adjusting the loudness

This function automatically emphasises bass and treble tones.

Press button **I** or **J** to switch the function on or off.

### Adjusting the front/rear sound distribution (Fader)

When "**FAD**" is displayed, press button **I** or **J**.

Button **I** increases the volume in the front.

Button **J** increases the volume in the rear.

### Adjusting the right/left sound distribution (Balance)

When "**BAL**" is displayed, press button **I** or **J**.

Button **I** increases the volume on the right-hand side.

Button **J** increases the volume on the left-hand side.

### Automatic volume correction "CAV"

This function enables the volume to be automatically adjusted depending on the level of noise produced by the speed of the vehicle.

Press buttons **I** or **J** to switch the function on or off.

## YOUR 206 IN DETAIL

### RADIO

#### Notes on radio reception

Your car radio is subject to phenomena which do not affect domestic radio sets. Both AM (MW/LW) and FM reception are subject to various forms of interference. This is no reflection on the quality of the equipment, but is due to the nature of the signals and the way in which they are transmitted.

On MW/LW, interference may be noticed when passing under high voltage power lines or bridges, or in tunnels.

On FM, interference may be the result of increasing distance from the transmitter, deflection of the signals by obstacles (mountains, hills, buildings, etc.), or of being in an area which is not covered by a transmitter.

#### Selecting radio mode

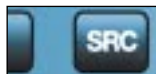

**Audio RB3:** press button "**SRC**" several times in succession.



**Audio RD3:** press button **R**.

#### Selecting a waveband



**Audio RB3:** briefly press the "**BND/AST**" button to select the FM1, FM2, FMast and AM wavebands.



**Audio RD3:** briefly press button **R** to select the FM1, FM2, FMast and AM wavebands.

#### Automatic station search



Briefly press button **L** or **N** to search for the station immediately above or below. By continuing to press the button in the direction selected, you will obtain continuous scrolling of the frequency.

The scrolling stops at the first station found as soon as the button is released.

If the **TA** traffic information programme is selected, only stations broadcasting this type of pro-

gramme are selected.

Searching for a station occurs first in "**LO**" sensitivity (selection of the most powerful transmitters) during scanning of the waveband, then in "**DX**" sensitivity (selection of the weakest and most distant transmitters).

To make a direct search in "**DX**" sensitivity, press button **L** or **N** twice.

## YOUR 206 IN DETAIL

---

### Manual station search

Press the "**MAN**" button.

Briefly press button **L** or **N** to increase or decrease the frequency displayed.

By continuing to press the button in the direction selected, you will obtain continuous scrolling of the frequency.

The scrolling stops as soon as the button is released.

Pressing the "**MAN**" button again returns you to automatic station search.

### Manual storing of stations in the memory

Select the station required.

Press one of the buttons "**1**" to "**6**" for more than two seconds.

The sound stops then becomes audible again, confirming that the station has been stored in the memory.

### Automatic storing of FM stations in the memory (autostore)



**Audio RB3:** press and hold the "**BND/AST**" button for more than two seconds.



**Audio RD3:** press and hold button **R** for more than two seconds.

Your radio automatically stores the 6 stations with the strongest signal in **FM**. These stations are stored in the FMast waveband.

If it is not possible to find 6 stations, the remaining memories are empty.

### Recalling stations stored in the memory

For each waveband, briefly press buttons "**1**" to "**6**" to recall the corresponding station.

## YOUR 206 IN DETAIL

---

### RDS

#### Using the RDS (Radio Data System) function on FM

Radio Data System allows you to continue listening to the same station, whatever frequency it is using for the region you are going through.



Briefly press the "RDS" button to switch the function on or off.

The multifunction display will show:

- "RDS" if the function is selected.
- "(RDS)" if the function is selected but not available.

#### RDS station following

The display indicates the name of the station selected. The radio is continually searching for the station which has the best reception and which is transmitting the same programme.

#### Traffic information programme



Press the "TA" button to switch the function on or off.

The multifunction display will show:

- "TA" if the function is selected,
- "(TA)" if the function is selected but not available.

Any traffic information flash will be given priority, whatever source you are listening to (radio, cassette or CD changer).

If you wish to interrupt a message, press the "TA" button; this switches the function off.

**Note: the volume of traffic information announcements is independent of the volume of normal radio listening. You can adjust it using the volume button. The setting will be stored and will be used when the next messages are broadcast.**

#### Regional following mode (REG)

When they are part of a network, certain stations broadcast regional programmes in the various areas they serve. With regional following mode you can keep listening to the same programme.

Press the "RDS" button for more than two seconds to switch the function on or off.

## YOUR 206 IN DETAIL

---

### CASSETTE: AUDIO RD3

#### Selecting cassette mode

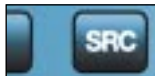

When a cassette is inserted, the cassette player will start automatically.  
If a cassette is already inserted, press button "**SRC**" several times to select cassette mode.

**Note:** before inserting the cassette, ensure that the tape is taut.

#### Ejecting the cassette



Fully press buttons **F** and **G** to eject the cassette from the player.

#### Direction of play

The player will play sides 1 and 2 of the cassette alternately, by automatically reversing the direction of play at the end of a side.

To manually reverse the direction of play, press the 2 buttons **F** and **G** half way.

#### Fast forward/rewind

Fully press button **F** or **G** to fast forward or rewind the cassette. At the end of the fast forward/rewind, the set plays the current side.

#### Recommendations for using cassettes

- Use good quality cassettes.
- Avoid the use of cassettes which play for longer than 90 minutes.
- Never expose the cassettes to heat or the direct rays of the sun.
- Re-tighten the tape if necessary before inserting the cassette in the player.
- Clean the playing head regularly with a damp type cleaning cassette.

## YOUR 206 IN DETAIL

---

### CD CHANGER

#### Selecting CD changer mode



*Audio RB3: press button "SRC" several times in succession.*



*Audio RD3: press button P.*

#### Selecting a disc

Press buttons "1" to "6" of the radio to select the corresponding disc.

#### Selecting a track



Press button **L** to select the next track.

Press button **N** to return to the start of the current track or to select the previous track.

#### Accelerated play

Keep button **L** or **N** pressed for forwards or backwards accelerated play. Accelerated play stops as soon as the button is released.

#### Shuffle (RDM)

When the CD changer is selected:

- **audio RB3:** keep button "SRC" pressed for two seconds;
- **audio RD3:** keep button **P** pressed for two seconds.

The tracks will be played in random sequence. Pressing the button again for two seconds returns you to normal play.



*The use of copied compact discs may cause faults.  
Insert circular compact discs only.*







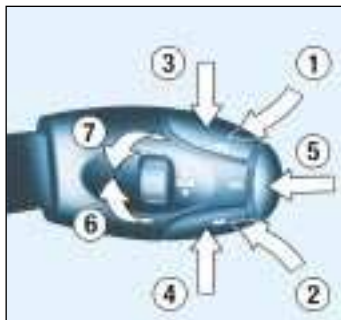

## YOUR 206 IN DETAIL

### AUDIO RD3



Stalk movement	Function
1 - Press (behind)	Increase volume
2 - Press (behind)	Decrease volume
1 + 2 - Simultaneous press	Sound cut-off (mute); restoring of the sound by pressing any button
3 - Press	Automatic search of higher frequencies (radio) - Selection of the next track (CD)
4 - Press	Automatic search of lower frequencies (radio) - Selection of the previous track (CD)
5 - Press the end	Change of source (radio/CD/CD changer)
6 - Rotation (clockwise)	Selection of next station stored in memory (radio) - Selection of following CD
7 - Rotation (anti-clockwise)	Selection of previous station stored in memory (radio) - Selection of previous CD

## YOUR 206 IN DETAIL

Button		Function
<b>A</b>		<b>Radio on/off</b>
<b>B</b>	–	Decrease volume
<b>C</b>	+	Increase volume
<b>D</b>	<b>RDS</b>	RDS function on/off Press for more than 2 seconds: regional following mode on/off
<b>E</b>	<b>TA</b>	Traffic information priority on/off Press for more than 2 seconds: PTY function on/off
<b>H</b>		Adjustment of bass, treble, loudness, sound distribution and automatic volume correction
<b>I</b>		Increase the setting of the functions associated with button <b>H</b>
<b>J</b>		Decrease the setting of the functions associated with button <b>H</b>
<b>L</b>		Manual and automatic search of higher frequency Selection of next CD track and PTY (radio)
<b>M</b>	<b>MAN</b>	Manual/automatic operation of buttons <b>L</b> and <b>N</b>
<b>N</b>		Manual and automatic search of lower frequency. Selection of previous CD track and PTY (radio)
<b>P</b>	<b>CH.CD</b>	Selection of CD changer Press for more than 2 seconds: shuffle
<b>Q</b>	<b>CD</b>	Selection of CD Press for more than 2 seconds: shuffle
<b>R</b>	<b>Radio</b>	Selection of radio. Selection of FM1, FM2, RMAST, AM wavebands Press for more than 2 seconds: automatic storing of stations in memory (autostore)
<b>S</b>		Ejection of CD
<b>1 to 6</b>	<b>1 2 3 4 5 6</b>	Selection of station stored in memory - Selection of a CD changer disc Press for more than 2 seconds: storing of a station in memory

## YOUR 206 IN DETAIL

### RADIO

#### Notes on radio reception

Your car radio is subject to phenomena which do not affect domestic radio sets. Both AM (MW/LW) and FM reception are subject to various forms of interference. This is no reflection on the quality of the equipment, but is due to the nature of the signals and the way in which they are transmitted.

On MW/LW, interference may be noticed when passing under high voltage power lines or bridges, or in tunnels.

On FM, interference may be the result of increasing distance from the transmitter, deflection of the signals by obstacles (mountains, hills, buildings, etc.), or of being in an area which is not covered by a transmitter.

#### Selecting radio mode

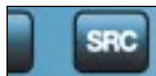

**Audio RB3:** press button "**SRC**" several times in succession.



**Audio RD3:** press button **R**.

#### Selecting a waveband



**Audio RB3:** briefly press the "**BND/AST**" button to select the FM1, FM2, FMast and AM wavebands.



**Audio RD3:** briefly press button **R** to select the FM1, FM2, FMast and AM wavebands.

#### Automatic station search



Briefly press button **L** or **N** to search for the station immediately above or below. By continuing to press the button in the direction selected, you will obtain continuous scrolling of the frequency.

The scrolling stops at the first station found as soon as the button is released.

If the **TA** traffic information programme is selected, only stations broadcasting this type of pro-

gramme are selected.

Searching for a station occurs first in "**LO**" sensitivity (selection of the most powerful transmitters) during scanning of the waveband, then in "**DX**" sensitivity (selection of the weakest and most distant transmitters).

To make a direct search in "**DX**" sensitivity, press button **L** or **N** twice.

## YOUR 206 IN DETAIL

---

### Manual station search

Press the "**MAN**" button.

Briefly press button **L** or **N** to increase or decrease the frequency displayed.

By continuing to press the button in the direction selected, you will obtain continuous scrolling of the frequency.

The scrolling stops as soon as the button is released.

Pressing the "**MAN**" button again returns you to automatic station search.

### Manual storing of stations in the memory

Select the station required.

Press one of the buttons "**1**" to "**6**" for more than two seconds.

The sound stops then becomes audible again, confirming that the station has been stored in the memory.

### Automatic storing of FM stations in the memory (autostore)



**Audio RB3:** press and hold the "**BND/AST**" button for more than two seconds.



**Audio RD3:** press and hold button **R** for more than two seconds.

Your radio automatically stores the 6 stations with the strongest signal in **FM**. These stations are stored in the FMast waveband.

If it is not possible to find 6 stations, the remaining memories are empty.

### Recalling stations stored in the memory

For each waveband, briefly press buttons "**1**" to "**6**" to recall the corresponding station.

## YOUR 206 IN DETAIL

---

### RDS

#### Using the RDS (Radio Data System) function on FM

Radio Data System allows you to continue listening to the same station, whatever frequency it is using for the region you are going through.



Briefly press the "RDS" button to switch the function on or off.

The multifunction display will show:

- "RDS" if the function is selected.
- "(RDS)" if the function is selected but not available.

#### RDS station following

The display indicates the name of the station selected. The radio is continually searching for the station which has the best reception and which is transmitting the same programme.

#### Traffic information programme



Press the "TA" button to switch the function on or off.

The multifunction display will show:

- "TA" if the function is selected,
- "(TA)" if the function is selected but not available.

Any traffic information flash will be given priority, whatever source you are listening to (radio, cassette or CD changer).

If you wish to interrupt a message, press the "TA" button; this switches the function off.

**Note: the volume of traffic information announcements is independent of the volume of normal radio listening. You can adjust it using the volume button. The setting will be stored and will be used when the next messages are broadcast.**

#### Regional following mode (REG)

When they are part of a network, certain stations broadcast regional programmes in the various areas they serve. With regional following mode you can keep listening to the same programme.

Press the "RDS" button for more than two seconds to switch the function on or off.

## YOUR 206 IN DETAIL

### PTY function: Audio RD3

This allows you to listen to stations broadcasting a specific type of programme (news, culture, sport, rock etc.).



With **FM** selected, press the "TA" button for more than two seconds to switch this function on or off.

To search for a **PTY** programme:



- select the **PTY** function,
- briefly press button **L** or **N** to scroll down the list of the various types of programmes offered,
- when the programme of your choice is displayed, keep button **L** or **N** pressed for more than two seconds to carry out an automatic search (after an automatic search the **PTY** function is switched off).

In **PTY** mode the different types of programmes can be stored in the memory. To do this, press the preselection buttons "1" to "6" for more than two seconds. Briefly press the corresponding button to recall the type of programme stored in the memory.

### EON system: Audio RD3

This connects stations which are part of the same network. It enables the broadcast of traffic information, by a station that is part of the same network as the station to which you are listening.

This service is available when you have selected the **TA** traffic information programme or the **PTY** function.

## YOUR 206 IN DETAIL

---

### COMPACT DISC: AUDIO RD3

#### Selecting CD mode



After insertion of a disc, printed face upwards, the player starts automatically.  
If a disc is already inserted, press button **Q**.

#### Ejection of a disc

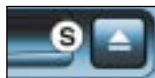

Press button **S** to eject the disc from the player.

#### Selecting a track



Press button **L** to select the next track.

Press button **N** to return to the start of the current track or to select the previous track.

#### Accelerated play

Keep button **L** or **N** pressed for forwards or backwards accelerated play.  
Accelerated play stops as soon as the button is released.

#### Shuffle (RDM)

When the CD player is selected, keep button **Q** pressed for two seconds. The tracks will be played in random sequence.  
Pressing the button again for two seconds returns you to normal play.

Shuffle mode is de-activated each time the audio system is switched off.



*The use of copied compact discs may cause faults.  
Insert circular compact discs only.*

## YOUR 206 IN DETAIL

### 5 CD CHANGER\*



This is located in the glove box. It holds up to 5 discs.

To load the changer, insert the discs with the printed side upwards.

To remove a disc, press and hold one of the buttons "1" to "5".

### 6 CD CHANGER\*

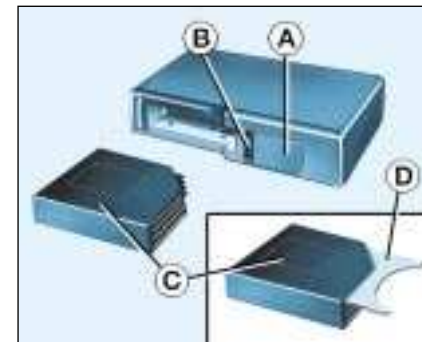
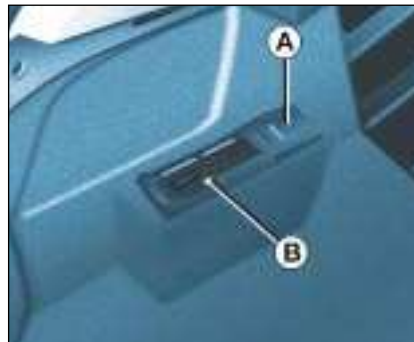

This is located in the boot on the left-hand side. It holds up to 6 discs.

To insert a disc into the changer:

- open sliding panel **A**,
- press button **B** to eject the cartridge **C**,
- open one of the six compartments of the cartridge by pulling tab **D**,
- **insert the disc into the cartridge, with the printed face upwards, and close the compartment,**
- insert the cartridge into the changer, observing the direction of the arrow,
- close the sliding panel **A**.



*The use of copied compact discs may cause faults.  
Insert circular compact discs only.*

\* According to destination.



## YOUR 206 IN DETAIL

### THE SATELLITE NAVIGATION SYSTEM

#### Introduction

The satellite navigation system guides you to the destination of your choice by means of vocal and visual instructions.

The heart of the system lies in the use of a map database and a GPS system. The latter enables your position to be located by means of several satellites.

The satellite navigation system consists of the following components:

- the remote control,
- the display,
- the control unit,
- the last voice message recall control,
- the CD ROM,
- the multifunction aerial.

Some functions or services described may vary depending on the CD-ROM version or the country where the vehicle is sold.

#### The remote control

Pointing this at the screen enables the information contained in the various menus to be selected.



#### Direction arrows:

These enable you to move around the screen and thus select a function.

On the welcome screen only, the up and down arrows enable the brightness of the screen to be adjusted.

The right and left arrows enable the complete name of the road to be displayed temporarily, during guidance, if the name exceeds the capacity of the screen.

**menu** : this button allows access to the main menu. It can be used at any time.

**esc** : escape button  
 "Short press": cancels the current operation and returns to the previous screen.

"Press for more than 2 seconds": returns to the welcome screen.

This button can be used in any menu. It is inactive during guidance.

**mod** : mode button  
 "Short press": changes between date, navigation, radio and permanent locating.

**val** : Validation button  
 Confirms the function selected.

Reference of the 2 batteries: 1.5 volts type LR03.

A special compartment in the glove box permits storage of the remote control.

## YOUR 206 IN DETAIL

### The display

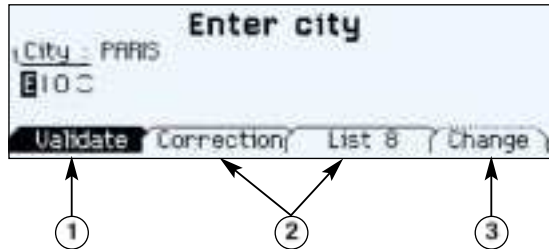

When the menus are used, the functions which appear at the bottom of the screen are presented in various ways:

1. Function selected.
2. Function inaccessible in this situation.
3. Function accessible.

**Note:** the "List" option is accessible for a maximum of 80 possible addresses.

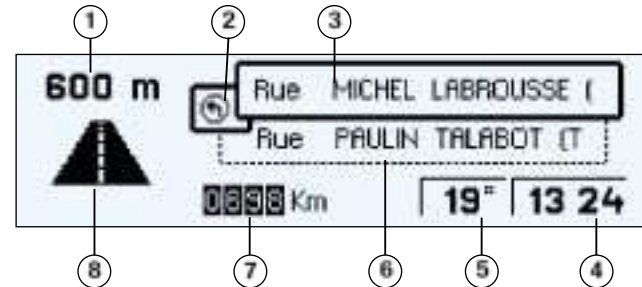

During guidance the screen displays different information depending on the manoeuvres to be carried out:

1. Distance to next manoeuvre.
2. Next manoeuvre to be carried out.
3. Next road to take.
4. Time.
5. Exterior temperature.
6. Current road.
7. Distance to final destination.
8. Manoeuvre to be carried out.

## YOUR 206 IN DETAIL

### The control unit

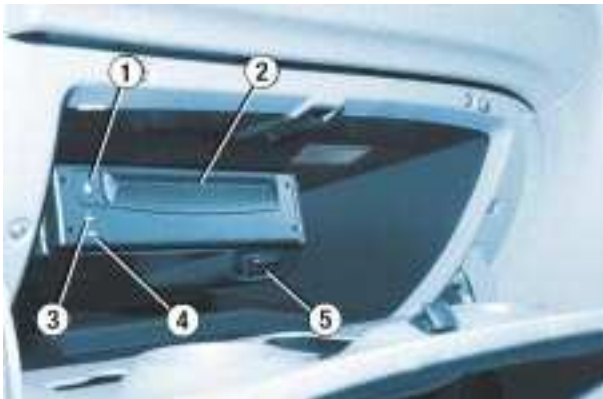

This is located in the glove box.

1. CD-ROM eject button.
2. CD-ROM compartment.
3. ON indicator light indicates that the control unit is supplied with power.
4. CD indicator light shows that there is a CD-ROM in the unit.
5. Remote control storage compartment.

### The last voice message recall control



Pressing the button on the end of the lights stalk allows the last voice message to be repeated, or, if appropriate, a voice message to be heard and a more detailed display of the approaching landscape to be displayed.

### The CD-ROM



This contains all the mapping data.

It must be inserted with the printed face upwards.

Use only CD-ROMs approved by PEUGEOT.



*The use of copied compact discs may cause faults.*



The satellite navigation system is active when the globe is lit with a full outline.

## YOUR 206 IN DETAIL

### Main menu



Switch on the ignition.

Press the "**Menu**" button to access the main menu.

Select a function using the direction arrows, then confirm ("**VAL**" button).

### Navigation/Guidance

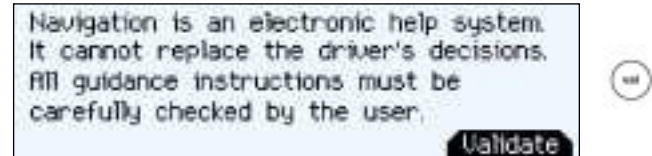

Following selection of the "**Navigation/guidance**" menu, a screen warns you about the use of the navigation system. Follow the regulations in force and do not use the remote control while driving.

Press the "**VAL**" button to access the next screen.

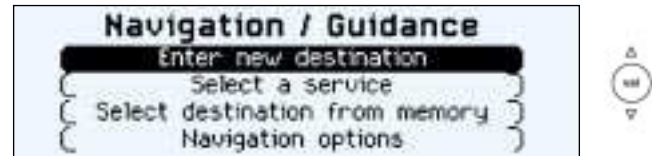

The "**Navigation/guidance**" menu offers the following options:

- entering of the address of a new destination;
- selection of a service (hotel, station, airport...) available in a town;
- selection of an address stored in one of the two directories;
- access to the "**Navigation options**" menu.
- Radio functions are suspended when the system is in guidance mode.

## YOUR 206 IN DETAIL

### Entering a new destination

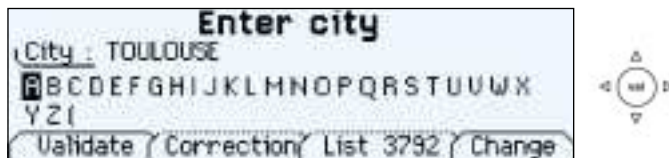

The last town entered is displayed.

To enter the name of another town, select each letter using the direction arrows then confirm ("**VAL**" button) for each letter.

If an error is made, the "**Correct**" function enables the last letter entered to be cleared.

The "**List**" function indicates, as the name is entered, the number of towns beginning with the same letters. If the list contains less than 5 names, these are displayed automatically. Select a town then confirm ("**VAL**" button).

The "**Change**" function enables the town entered to be completely cleared.

When the complete name of the town is displayed, select the "**Validate**" function then press the "**VAL**" button.

**Note:** following confirmation of a letter, only those letters which could make up an existing name appear.

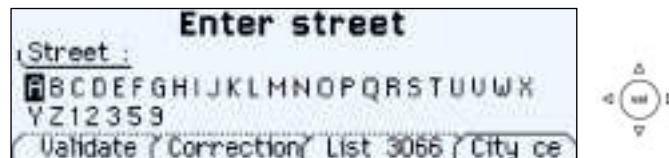

Enter the name of the street. Select the "**Validate**" function then press the "**VAL**" button.

**Note:** the guidance can be activated from the time the town is entered without the name of a street or a number. To do this, select the "**City centre**" function.

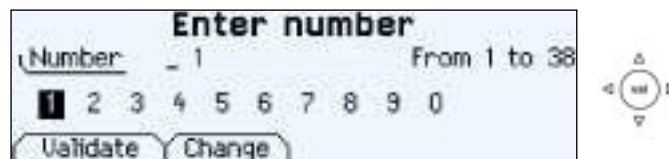

Enter the number on the street. Select the "**Validate**" function then press the "**VAL**" button.

**Note:** the guidance can be activated as soon as the town and street are entered without a number. To do this, select the "**Validate**" function.

## YOUR 206 IN DETAIL



The complete destination is displayed. Select the **"Validate"** function then press the **"VAL"** button.

**Note:** you can also change the destination or store it in one of the two directories (see the section on storing an address in a directory).

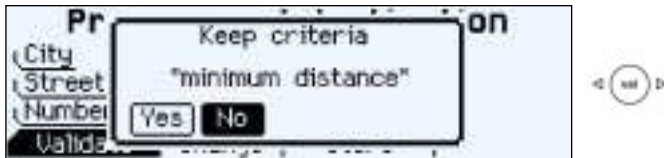

The last guidance criterion used is displayed.

Guidance begins automatically, retaining this criterion if there is no action within 5 seconds or following confirmation of the **"NO"** function.

Follow the instructions.

If you wish to change the guidance criterion, select the **"YES"** function then press the **"VAL"** button.

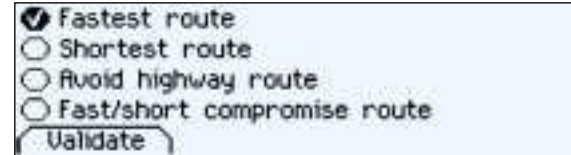

Select a criterion from the list offered then confirm (**"VAL"** button). When the criterion of your choice is selected, select the **"Validate"** function then press the **"VAL"** button. Guidance begins, follow the instructions.

## YOUR 206 IN DETAIL

### Selecting a service



The last address entered is displayed.

There are 3 options for defining the location in which you wish to obtain a service:

- resume the last address entered by means of the "**Validate**" function.
- enter the name of a new town then enter the street (or the "**City centre**" function) by means of the "**Change**" function.
- automatically enter your current location by using the "**Current location**" function.



After confirming the address, select a service by scrolling through the list using the direction arrows then press the "**VAL**" button.

A cursor on the left-hand side of the screen indicates your position in the list.



The address of the required service is displayed.

An indication on the right-hand side of the screen (e.g. 1/50) indicates whether there are any other establishments (50 maximum) offering the same service within a radius of approximately 30 miles (50 km).

Use the "**Next**" or "**Previous**" functions to consult the list offered.

When the establishment of your choice is displayed, select the "**Validate**" function then press the "**VAL**" button. Select a guidance criterion. Guidance begins, follow the instructions.

## YOUR 206 IN DETAIL

### Storing an address in a directory

When a new address is entered, you can store it by selecting the "**Store**" function.

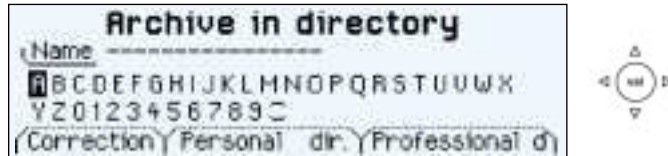

Enter the description of the address. If the description already exists for a different address, you can replace the old address with a new one.

Select the Personal or Professional directory, then press the "**VAL**" button. The address is then stored in the directory of your choice.

### Selecting a stored destination



Using the direction arrows, select the directory in which the address you are looking for is stored then press the "**VAL**" button.

The stored addresses are displayed.

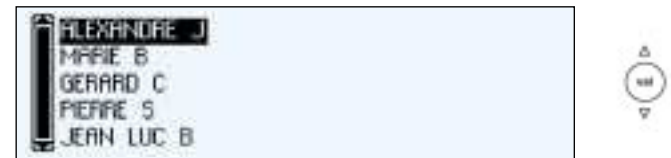

A cursor on the left-hand side of the screen indicates your position in the list. Select a description, by scrolling through the list using the direction arrows, then press the "**VAL**" button. The complete address is displayed. Select the "**Validate**" function then press the "**VAL**" button. Select a guidance criterion. Guidance begins, follow the instructions.



## YOUR 206 IN DETAIL

### Display configuration



From the general menu, the "**Configure display**" menu gives access to the following parameters:

- Adjustment of the display brightness;
- Adjustment of the date and time;
- Selection of the language of the display and voice information (English, German, Spanish, French, Italian, Dutch);
- Adjustment of formats and units. This enables you to choose between Km/h or mph and degrees Celsius or Fahrenheit and to modify the format for the hours (12 or 24 hour mode).

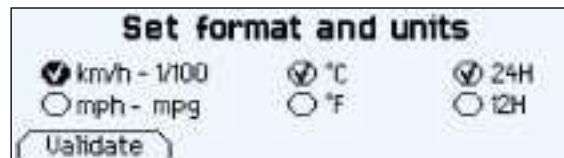

### Navigation options

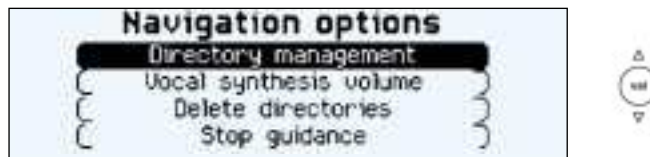

From the navigation/guidance menu, the "**Navigation options**" menu offers the following options:

- Management of the directories. It enables an address stored under a description to be renamed or deleted. To do this, select the directory and the description to be changed;
- Voice synthesis volume adjustment;
- Deletion of all data stored in the two directories;
- Stopping or resuming of guidance. Two messages may be displayed depending on the previous status: "**Resume guidance**" or "**Stop guidance**".

## YOUR 206 IN DETAIL

---

### Guidance tools

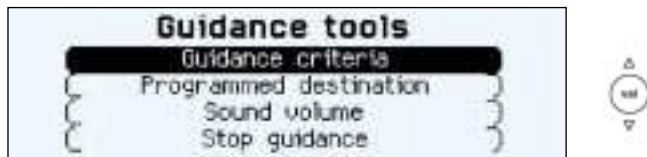

Access to the "**Guidance tools**" menu is by pressing the "**VAL**" button during guidance.

It enables:

- the current guidance criterion to be changed,
- the programmed destination to be displayed or changed,
- the voice synthesis volume to be adjusted,
- the current guidance to be stopped.

## YOUR 206 IN DETAIL

---



# YOUR 206 IN DETAIL

---

## VENTILATION

1. Windscreen de-icing or demisting vents.
2. Front door windows de-icing or demisting vents.
3. Side vents.
4. Centre vents.
5. Air outlet to front footwells.
6. Air outlet to rear footwells.

## Advice on operation

- Place the air flow control at a level sufficient to ensure correct renewal of air in the passenger compartment. The **"OFF"** position cuts off all the air circulation in the passenger compartment.  
**Note:** only use the **"OFF"** position occasionally (risk of condensation).
- Select the air distribution most suited to your requirements and the climatic conditions.
- Gradually adjust the temperature setting for your comfort.
- Position the outside air control to the left; the "Outside Air" position.
- For perfectly even air distribution, take care not to obstruct the exterior air intake grille on the bonnet, the vents and the air ducts under the front seats. Check that the passenger compartment filter is in good condition.

## YOUR 206 IN DETAIL

### HEATING/VENTILATION

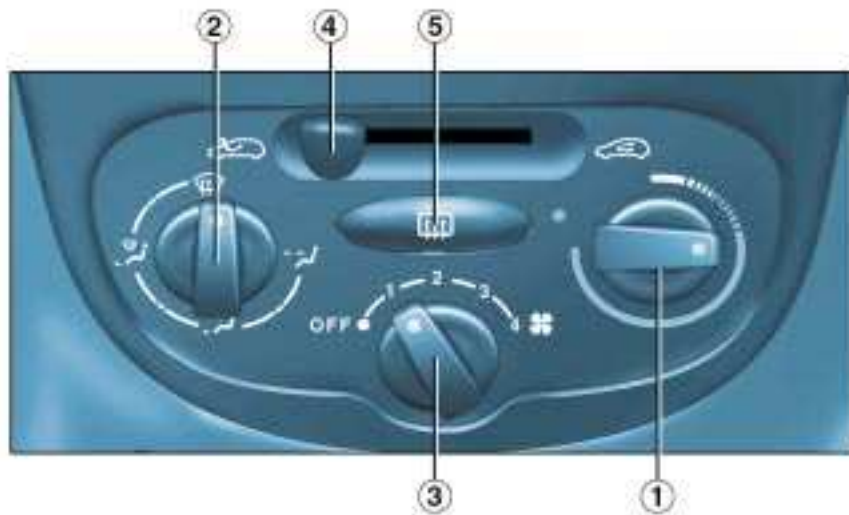

#### 1. Temperature adjustment

To be adjusted to your requirements. From blue (exterior temperature) to red (hot).

#### 2. Air distribution adjustment



Windscreen and side windows (de-icing/demisting).

To quickly de-ice or demist the windscreen and side windows:

- position the air intake control to the left; the "Outside Air" position,
- turn the temperature and air flow controls to maximum,
- close the centre and side vents.

## YOUR 206 IN DETAIL



Windscreen, side windows and footwells.



Footwells.

These settings are recommended for cold climates.



Centre and side vents.

This setting is recommended for hot climates.

### 3. Air flow adjustment



Turn the control from position **1** to position **4** to obtain an air flow sufficient to ensure your comfort.

### 4. Air intake control



Intake of exterior air.

This is the normal operating position.



Recirculation of interior air.

This position prevents exterior odours and smoke entering the passenger compartment and speeds up the rate at which the passenger compartment can be heated.

As soon as possible, position the control in the exterior air intake position to prevent misting of the windows.

### 5. Demisting the rear screen and the mirrors



With the engine running, press once to demist the rear screen and the mirrors.

It switches off automatically after approximately twelve minutes. Press again to switch it back on for twelve minutes.

It is possible to stop demisting by pressing the button again before the end of the twelve minutes.

## YOUR 206 IN DETAIL

### AIR CONDITIONING

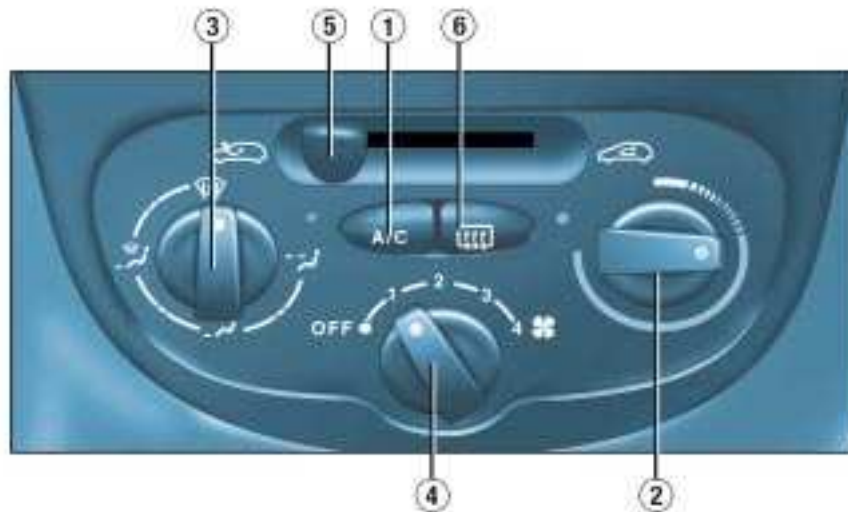

#### 1. Air conditioning

The air conditioning is designed to operate in all seasons. In summer, it enables the temperature to be lowered and in winter, above 0 °C, it increases the effectiveness of the demisting.



Press the switch to activate the air conditioning. The indicator light comes on.

**The air conditioning does not operate while the air flow adjustment control is in the "OFF" position.**

#### Note:

It is quite normal that the condensation created by the air conditioning results in a flow of water under the vehicle when it is stationary.

#### 2. Temperature adjustment

To be adjusted to your requirements. From blue (cold when the air conditioning is on) to red (hot).

## YOUR 206 IN DETAIL

### 3. Air distribution adjustment



Windscreen and side windows (de-icing/demisting).

To quickly de-ice or demist the windscreen and side windows:

- turn the temperature and air flow controls to maximum,
- close the centre vents,
- position the air intake control to the left; the "Outside Air" position,
- start the air conditioning.



Windscreen, side windows and footwells.



Footwells.

These settings are recommended for cold climates.



Centre and side vents.

This setting is recommended for hot climates.

### 4. Air flow adjustment



Turn the control from position 1 to position 4 to obtain an air flow sufficient to ensure your comfort.

### 5. Air intake control



Intake of exterior air.

This is the normal operating position.



Recirculation of interior air.

This position prevents exterior odours and smoke entering the passenger compartment.

Used simultaneously with the air conditioning, recirculation enables both heating and cooling performance to be improved.

Used without the air conditioning, recirculation may result in misting of the windows.

As soon as possible, position the control in the exterior air intake position.

### 6. Demisting the rear screen and the mirrors



With the engine running, press once to demist the rear screen and the mirrors.

It switches off automatically after approximately twelve minutes.

Press again to switch it back on for twelve minutes.

It is possible to stop demisting by pressing the button again before the end of the twelve minutes.

### Important precaution

Operate the air conditioning system for 5 to 10 minutes, once or twice a month, to keep it in perfect working order.

If the system does not produce cold air, do not use it and contact a PEUGEOT dealer.



## YOUR 206 IN DETAIL

### AUTOMATIC AIR CONDITIONING



#### Automatic operation

##### 1. Temperature adjustment



The chosen temperature is displayed. Press the up and down arrows to change it. A setting around 21 °C enables a comfortable temperature to be obtained.

##### 2. Automatic comfort programme



Press the **AUTO** button. The system automatically adjusts the atmosphere inside the vehicle in accordance with the temperature that you have chosen. To do this, it controls the temperature, the flow, the distribution and the intake of air as well as the air conditioning.

**Note:** for your comfort, the settings are retained between two start-ups of your vehicle if the temperature in the passenger compartment has not changed significantly; otherwise, operation resumes in automatic mode.

##### 3. Automatic visibility programme



In some cases, the automatic comfort programme may not be sufficient for de-icing or demisting of the windows (humidity, several passengers, ice etc.). In this case, select the automatic visibility programme to clear the windows quickly.

To exit this programme and return to the automatic comfort programme, press the **AUTO** button.

# YOUR 206 IN DETAIL

## Manual operation

If you wish, you can make a different choice from that offered by the system by changing a setting. The other functions will still be controlled automatically. Pressing the **AUTO** button returns the system to completely automatic operation.

## 4. Air conditioning



Press this button to switch off the air conditioning. The symbol **ECO** is displayed. Automatic operation of the air conditioning is resumed when the button is pressed again. The symbol **A/C** is displayed.

## Notes

It is quite normal that the condensation created by the air conditioning results in a flow of water under the vehicle when it is stationary.

To prevent condensation on the inside of the vehicle in cold or wet weather, you are advised to avoid using the **ECO** mode.

## 5. Air distribution



Pressing this button several times in succession enables the air flow to be directed in turn towards:

- the windscreen (de-icing or demisting),
- the windscreen and the footwells,
- the footwells,
- the centre and side vents and the footwells,
- the centre and side vents.

## 6. Air flow



The flow of air can be increased or reduced by pressing buttons + or – respectively.

## 7. Air intake



Press this button for recirculation of the interior air. Recirculation, shown on the display, enables the passenger compartment to be insulated from exterior odours and smoke.

Avoid prolonged recirculation of interior air. To do this, press the button again to resume automatic management of the intake of air.

**Note:** To prevent condensation on the inside of the vehicle in cold or wet weather, you are advised to avoid using this mode.

## 8. Switching the system off



The **OFF** button enables the entire system to be switched off.

Temperature-related comfort is no longer guaranteed.

Pressing the **OFF**, **AUTO**, or **visibility** button again reactivates the system with the values set before it was switched off.

## 9. Demisting the rear screen



Press this button to demist the rear screen and the mirrors. Demisting switches off automatically. It is possible to stop operation of the demisting before it is switched off automatically by pressing the button again.

## Important precaution

Operate the air conditioning for 5 to 10 minutes, once or twice a month, to keep it in good working order.

If the system does not produce cold air, do not use it and contact your PEUGEOT dealer.

## YOUR 206 IN DETAIL

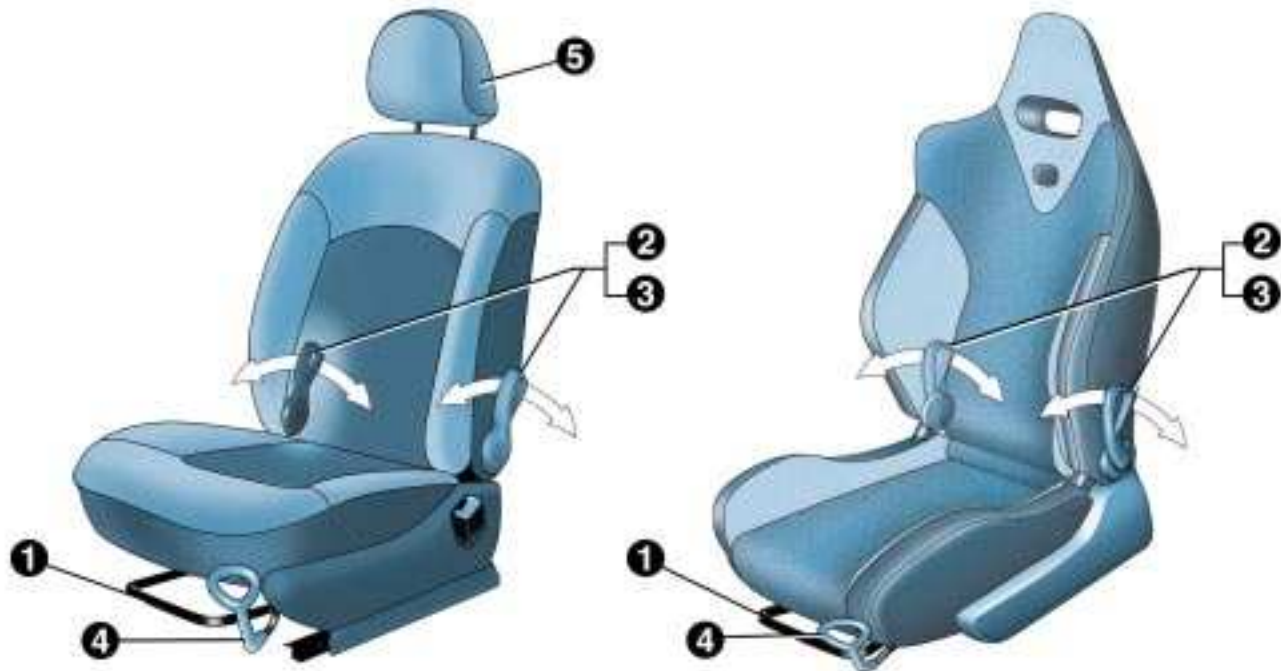

# YOUR 206 IN DETAIL

## FRONT SEATS

### 1. Forwards-backwards adjustment

Lift the control and slide the seat forwards or backwards.

### 2. Access to rear seats (3 door)

Pull one of the two handles to fold the seat back and move the seat forwards. On repositioning, the seat returns to its initial position

It is impossible to access the rear seats if the front seat is in the reclining position.

### 3. Seat back angle adjustment

Push one of the two handles towards the rear.

### 4. Seat height adjustment

Pull the handle upwards.

Remove your weight from the seat to raise, or press on the seat to lower.

### 5. Head restraint height and angle adjustment (saloon and 206 SW)

To raise the restraint, push it upwards.

**The adjustment is correct when the upper edge of the head restraint is level with the top of the head.**

The head restraint has a frame with notches, which prevent the head restraint dropping down (this is a safety device in the event of an impact).

To lower the head restraint, it is necessary to push simultaneously:

- the button located at the base of the head restraint frame,
- the head restraint downwards.

To remove the head restraint, press the lug.

## Rear head restraints

These have one position for when they are being used (high) and a storage position (low). They can be removed.

To lower the head restraints, press the lug.

To remove them, pull upwards as far as the stop then press the release control.



*Never drive with the head restraints removed; they should be in place and correctly adjusted.*

## YOUR 206 IN DETAIL



### Modifiable front passenger seat (saloon)

#### Access to the storage compartment

- Push the seat as far back as possible.
- Lift then pull the front of the seat to unlock it.
- Tilt the seat cushion forwards.



### Storage compartment

- Lift the cover to gain access to the storage compartment.
- Ensure that the cover is locked correctly before folding back the seat cushion.



### Folding seat back (all models)

- Remove the head restraint for complete folding of the seat.
- Push either of the two handles **2** towards the rear to fold the seat back.

**Note:** with the modifiable seat, this can be tilted or removed in order to fold down the seat back horizontally.

## YOUR 206 IN DETAIL

---



### Removing the modifiable front passenger seat

- Push the seat as far back as possible.
- Lift then pull the front of the seat to unlock it.
- Tilt the seat forwards.
- Pulling upwards, tilt the seat from left to right to make it easier to remove.



### Refitting the modifiable front passenger seat

- Push the seat as far back as possible.
- Engage the seat fastener in the clips.
- Fold back the seat.

# YOUR 206 IN DETAIL

## FRONT SEATS

### 1. Forwards-backwards adjustment

Lift the control and slide the seat forwards or backwards.

### 2. Access to rear seats (3 door)

Pull one of the two handles to fold the seat back and move the seat forwards. On repositioning, the seat returns to its initial position

It is impossible to access the rear seats if the front seat is in the reclining position.

### 3. Seat back angle adjustment

Push one of the two handles towards the rear.

### 4. Seat height adjustment

Pull the handle upwards.

Remove your weight from the seat to raise, or press on the seat to lower.

### 5. Head restraint height and angle adjustment (saloon and 206 SW)

To raise the restraint, push it upwards.

**The adjustment is correct when the upper edge of the head restraint is level with the top of the head.**

The head restraint has a frame with notches, which prevent the head restraint dropping down (this is a safety device in the event of an impact).

To lower the head restraint, it is necessary to push simultaneously:

- the button located at the base of the head restraint frame,
- the head restraint downwards.

To remove the head restraint, press the lug.

## Rear head restraints

These have one position for when they are being used (high) and a storage position (low). They can be removed.

To lower the head restraints, press the lug.

To remove them, pull upwards as far as the stop then press the release control.



*Never drive with the head restraints removed; they should be in place and correctly adjusted.*

## YOUR 206 IN DETAIL



### REAR SEATS

To fold the rear seats:

- lift the front of the seat cushion 1,
- tilt the seat cushion 1 against the front seats,
- position the seat belt under the belt holder 2,
- pull control 3 to unlock the seat back 4,
- remove or lower the head restraint,
- tilt the seat back 4.

**Always start with the seat, never the seat back (risk of damage).**

When repositioning:

- fold up the seat back,
- fold back the seat cushion,
- reposition the lap belt and the buckles before locking the front of the seat cushion.

**Take care not to trap the seat belts.**



## YOUR 206 IN DETAIL

---



### Removing the rear seat

- Tilt the seat cushion against the front seats.
- Squeeze the seat fasteners to release them from their attachments.
- Remove the seat cushion.



### TRANSPORTING LONG OBJECTS

To allow the transportation of long objects:

#### Front seat:

- remove the modifiable seat (see corresponding paragraph) and fold down the seat back.

#### Rear seat:

- remove the seat cushion,
- tilt the seat back.

## YOUR 206 IN DETAIL

### GENERAL POINTS RELATING TO CHILD SEATS

Although one of PEUGEOT's main criteria when designing your vehicle, the safety of your children also depends on you.

For maximum safety, please follow these precautions:

- Since 1992, **all children under the age of 10 must travel in approved child seats\* suited to their weight**, on seats fitted with a seat belt.

In order to recognise a child seat which conforms to current legislation, **check that it bears an orange label indicating the weight range for its use and its approval number.**

- **A child weighing less than 9 kg must travel in the rearwards facing position both in the front and in the rear. PEUGEOT recommends that children should travel in the "rearwards facing" position up to the age of two.**
- **Statistically, the safest seats in your vehicle for the transportation of children are the rear seats.**
- If a child is travelling on a booster seat, check that the lap section of the seat belt passes over the child's thighs correctly. The chest section of the seat belt must be positioned on the child's shoulder without touching the neck. PEUGEOT recommends that you use a booster seat with a back, fitted with a seat belt guide.
- Remember to fasten the seat belt or the child seat harness **keeping the slack in relation to the child's body to a minimum**, even for short journeys.

\* According to current legislation in the country.

\*\* Consult the relevant administration in your country for information regarding the rules for transporting children on the front passenger seat.

### Rules for transporting children on the front passenger seat\*\*

Children under the age of 10 must not travel in the forwards facing position, unless the rear seats are already occupied by other children or the rear seats cannot be used (absent or folded). In this case, adjust the front passenger seat to the most rearward position and arm the passenger air bag.

The rearwards facing position is permitted from birth to 13 kg or 18 kg. In this position, it is essential to disarm the passenger air bag.

## YOUR 206 IN DETAIL



### "ISOFIX" MOUNTINGS

The front passenger seat, the two rear side seats (saloon and 206 SW) and the one third section of the rear seat (206 RC) are fitted with **ISOFIX mountings**. These are two rings located between the seat back and the seat cushion.

The **ISOFIX child seats** are fitted with two locks which are secured easily on these rings. All this guarantees reliable, safe and fast fitting.



The ISOFIX child seat approved for PEUGEOT vehicles and sold by PEUGEOT dealers is the **Isifix KIDDY\*** child seat. It can be fitted in the "rear facing" position from birth to 13 kg and in the "forwards facing" position from 9 to 18 kg.

In the front, in the "rear facing" position, the front passenger seat must be moved as far forward as possible so that the body of the child seat is in contact with or as close as possible to the fascia.

In the rear, in the "forwards facing" position, in the saloon and 206 SW, it is imperative that the front passenger seat is in the mid-way position on the runner, seat back upright. In the 206 RC, the body of the child seat must be in the most upright position. Refer to the child seat's installation guide for this setting.

In the rear, in the "rear facing" position, the body of the child seat must be in contact with the back of the corresponding front seat.

This seat can also be used on seats not fitted with ISOFIX mountings. In this case it is compulsory to attach it to the vehicle's seat by means of the three-point seat belt for both the "rear facing" and "forwards facing" positions.

Refer to the "Summary table for fitting child seats".

**When the ISOFIX KIDDY seat is fitted in the "rear facing" position on the front passenger seat, it is essential to disarm the passenger air bag.**

**Otherwise, the child would risk being killed or seriously injured if the air bag were to inflate.**

**Follow the instructions for fitting the child seat in the seat manufacturer's instruction booklet.**

\* You can only fit ISOFIX child seats approved by PEUGEOT and sold by PEUGEOT dealers on your vehicle's ISOFIX mountings.

## YOUR 206 IN DETAIL



### CHILD SEATS RECOMMENDED BY PEUGEOT

In addition to the ISOFIX child seats, PEUGEOT offers a complete range of child seats which are secured using the seat belt:

#### Group 0+: from birth to 13 kg

L1 - "Britax Babysure": installed in the rear-facing position in the front or in the rear using a three-point seat belt.

In the front, it is compulsory to disarm the passenger air bag and the passenger seat must be adjusted to the **'mid-way'** position on the runner.

#### Group 1: from 9 to 18 kg

L2 - "Römer Prince": installed in the rear using a two or three-point seat belt.

For the safety of your child, the seat and the restraining cushion must never be separated.

#### Group 2: from 15 to 25 kg

L3 - "Römer Vario": installed in the rear with a two or three-point seat belt.

## YOUR 206 IN DETAIL



### Groups 2 and 3: from 15 to 36 kg

L4 - "Recaro Start": installed in the rear with a three-point seat belt.

The height and width of the seat back and length of the seat cushion must be adjusted according to the age and build of your child.

L5 - "Klippan Optima": installed in the rear with a three-point seat belt.

From the age of 6 years (approximately 22 kg), the booster is used on its own.

Refer to the "Summary table for the installation of child seats".



*Never leave one or more children alone and unsupervised in a vehicle.*

*Never leave a child or an animal in a vehicle which is exposed to the sun and has the windows closed.*

*To protect your young children from the sun, fit blinds on the rear windows.*

*Never leave the keys within reach of children inside the vehicle.*



*Disarm the passenger air bag when installing a "rearwards facing" child seat on the front passenger seat. Otherwise, the child would risk being killed or seriously injured were the air bag to inflate.*

*Observe strictly the recommendations for assembling and securing the child seat as shown in the child seat instructions.*

*To prevent the doors from opening accidentally, use the child lock\*.*

*Also, do not open the rear windows more than a third\*.*

*\* According to model.*

## YOUR 206 IN DETAIL

### SUMMARY TABLE FOR FITTING CHILD SEATS (Saloon and 206 SW)

In accordance with the European regulation (Directive 2000/3), the table below indicates the options for the installation of child restraints, depending on the weight group and the seat in the vehicle:

Seat	Statutory weight group			
	Group 0 <sup>(a)</sup> at 0+ < 13 kg	Group 1 9 - 18 kg	Group 2 15 - 25 kg	Group 3 22 - 36 kg
Front passenger <sup>(b)</sup> Fixed seat, Height adjustable seat	<b>U</b> L1, L6	<b>U</b> L2, L7	<b>U</b> L3, L4, L5	<b>U</b> L4, L5
Rear passenger Side seat	<b>U</b> L1, L6	<b>U</b> L2, L7	<b>U</b> L3, L4, L5	<b>U</b> L4, L5
Rear passenger Centre seat Three-point seat belt	<b>X</b>	<b>U F</b> L2	<b>U F</b> L3, L4, L5	<b>U F</b> L4, L5
Rear passenger Centre seat Two-point seat belt	<b>X</b>	<b>U F</b> L2	<b>U F</b> L3	<b>U F</b>

**U** : universal category

**U F** : universal category, forward-facing.

**X** : no child restraint.

According to destination:

L1 : BRITAX Babysure

E11 0344117

Universal (birth to 13 kg).

L2 : ROMER Prince

E1 03301058

Universal (9 to 18 kg).

L3 : ROMER Vario

E1 03301120

Universal (15 to 25 kg).

L4 : RECARO Start

E1 03301108

Universal (15 to 36 kg).

L5 : KLIPPAN Optima

E17 030007

Universal (15 to 36 kg).

L6 : KIDDY Isifix Rearwards facing<sup>(c)</sup>

E1 03301123 and

Universal (birth to 13 kg).

L7 : KIDDY Isifix Forwards facing<sup>(c)</sup>

E2 030011

Universal (9 to 18 kg).

(a) Group 0: from birth to 10 kg.

(b) The rules for transporting children in the front passenger seat are specific to each country. Consult the current legislation in your country.

(c) See section "Seats - Isifix mountings" for use of the KIDDY child seat on the vehicle's Isifix mountings, or failing this with the seat belt.

## YOUR 206 IN DETAIL

### SUMMARY TABLE FOR FITTING CHILD SEATS (206 GTi 180\*)

In accordance with the European regulation (Directive 2000/3), the table below indicates the options for the installation of child restraints, depending on the weight group and the seat in the vehicle:

Seat	Statutory weight group			
	Group 0 <sup>(a)</sup> at 0+ < 13 kg	Group 1 9 - 18 kg	Group 2 15 - 25 kg	Group 3 22 - 36 kg
Front passenger <sup>(b)</sup>	U L1, L6	U L2, L7	U L3, L4, L5	U L4, L5
Rear passenger Side seat				

U : universal category

According to destination:

L1 : BRITAX Babysure	E11 0344117	Universal (birth to 13 kg).
L2 : ROMER Prince	E1 03301058	Universal (9 to 18 kg).
L3 : ROMER Vario	E1 03301120	Universal (15 to 25 kg).
L4 : RECARO Start	E1 03301108	Universal (15 to 36 kg).
L5 : KLIPPAN Optima	E17 030007	Universal (15 to 36 kg).
L6 : KIDDY Isofix Rearwards facing <sup>(c)</sup>	E1 03301123 and	Universal (birth to 13 kg).
L7 : KIDDY Isofix Forwards facing <sup>(c)</sup>	E2 030011	Universal (9 to 18 kg).

(a) Group 0: from birth to 10 kg.

(b) The rules for transporting children in the front passenger seat are specific to each country. Consult the current legislation in your country.

(c) See section "Seats - Isofix mountings" for use of the KIDDY child seat on the vehicle's Isofix mountings, or failing this with the seat belt.

\* During the year, according to destination.

## YOUR 206 IN DETAIL



### SEAT BELTS

#### Seat belt height adjustment:

- to lower: pull the control towards you and slide it downwards.
- to raise: slide the control upwards.

#### To lock the seat belts

Pull the strap, then insert the end into the buckle.

#### Front seat belts with pre-tensioner and force limiter

Safety in the event of front impacts has been improved by the introduction of seat belts with pre-tensioner and force limiter for the front seats. Depending on the seriousness of the impact, the pre-tensioning system instantly tightens the seat belts and pulls them against the bodies of the occupants.

The pre-tensioning seat belts are active when the ignition is on.

The force limiter eases the pressure of the seat belt on the body of the occupant in the event of an accident.

#### Rear seat belts

The rear seats are fitted with three three-point inertia reel seat belts (saloon and 206 SW) or with two three-point inertia reel seat belts (206 GTi 180).



*To be effective, a seat belt must be tightened as close to the body as possible.*

*Depending on the nature and seriousness of the impact, the pre-tensioning system may be triggered before and independently of the air bags.*

*In all cases, the air bag warning light on the instrument panel comes on.*

*Following an impact, have the system checked by a PEUGEOT dealer.*



# YOUR 206 IN DETAIL

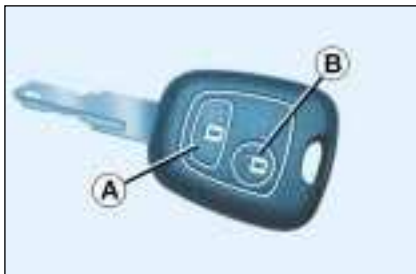

## THE KEYS

The keys allow you to switch on the ignition and operate the passenger air bag disarming switch and the fuel filler cap, as well as independently operate the locks on the front doors.

### Central locking

The keys allow you to lock or unlock the doors and tailgate from the front doors.

If one of the doors, the tailgate (206 SW) or the rear screen (206 SW) is open, the central locking does not work.

### The remote control

This performs the same functions as the key, at a distance.

## Locking

Press button **A** to lock the vehicle. This is confirmed by fixed lighting of the direction indicators for approximately two seconds.

## Unlocking

Press button **B** to unlock the vehicle. This is confirmed by the rapid flashing of the direction indicators.

**206 SW:** Press and hold button **B** to unlock the vehicle and open the rear screen.

**Note:** If the vehicle is locked and unlocking is activated inadvertently, unless the doors are opened within 30 seconds, the vehicle will lock automatically (206 SW).

Avoid pressing the buttons of your remote control out of range of your vehicle. You risk causing it not to work and the remote control would then have to be reprogrammed.

## Key in ignition

A buzzer sounds on opening the driver's door, if the key has been left in the ignition.

## Locating your vehicle

To locate your vehicle, if you have locked it, in a car park:

- ☞ press button **A**. The courtesy lights come on and the direction indicators flash for a few seconds.

## Changing the battery of the remote control

Warning that the battery is flat is given by an audible signal accompanied by the message "**Remote control battery low**" on the multi-function display.

To replace the battery, remove the screw then unclip the casing using a coin at the ring (CR 2016/3 volt battery).

If the remote control does not work after the battery has been changed, reprogramme the remote control.

## Programming the remote control

- ☞ Switch off the ignition.
- ☞ Switch the ignition on again.
- ☞ Press button **A** immediately.
- ☞ Switch off the ignition and remove the remote control key from the ignition lock. The remote control is now working again.

## YOUR 206 IN DETAIL

### ELECTRONIC ENGINE IMMOBILISER

This locks the engine management system as soon as the ignition has been switched off and therefore prevents starting of the vehicle by anyone who does not have the key.

The ignition key has an electronic chip which has a special code. When the ignition is switched on, the code is recognised and starting is possible.

**If the system does not function correctly**, contact a PEUGEOT dealer as soon as possible.



### Confidential card

The confidential card contains the identification code necessary for any work carried out by a PEUGEOT dealer on the system. This code is hidden by a film, which should be removed only if necessary.

**Keep your card in a safe place, never inside the vehicle.**



*Make a careful note of the number on each key. The key number is coded on the label attached to the key.*

*If the keys are lost, your PEUGEOT dealer can rapidly supply you with new keys.*

*The high frequency remote control is a sensitive system; do not operate it while it is in your pocket as there is a possibility that it may unlock your vehicle, without you being aware of it.*

*The remote control does not operate when the key is in the ignition, even when the ignition is switched off, except for reprogramming.*

*Driving with the doors locked may make access to the passenger compartment by the emergency services more difficult in an emergency.*

*As a safety precaution (with children on board), remove the ignition key when you leave the vehicle, even for a short time.*

*Do not repeatedly press the button of your remote control out of range of your vehicle.*

*You run the risk of stopping it from working and the remote control would have to be reprogrammed.*

*When purchasing a second-hand vehicle:*

- ensure that you are given the confidential card;*
- have the key codes memorised by a PEUGEOT dealer, to ensure that the keys in your possession are the only ones which can start the vehicle.*

*Do not make any modifications to the electronic engine immobiliser system.*

## SPECIAL FEATURES

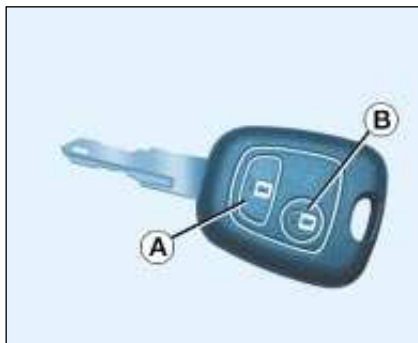

### Deadlocking

Deadlocking the doors is an additional security device. When it is used it means that the interior and exterior door locking controls cannot open the doors.

#### There are two methods of operation:

- with the ignition key,
- with the remote control, which has two buttons:

- A. Deadlocking/locking of the doors and tailgate.
- B. Unlocking.

### Using the key

**To deadlock**, turn the key towards the rear of the vehicle.

**To lock**, within 5 seconds of deadlocking, turn the key towards the rear of the vehicle again.

**To unlock**, turn the key towards the front of the vehicle.

### Using the remote control

#### To deadlock

Press button **A** once to deadlock the vehicle.

This is indicated by fixed lighting of the direction indicators for approximately two seconds.

A second press on button **A** within 5 seconds of deadlocking changes this to normal locking.

This is indicated by fixed lighting of the direction indicators for approximately two seconds.

#### To unlock

Press button **B** once to unlock the vehicle.

This is indicated by rapid flashing of the direction indicators.

## YOUR 206 IN DETAIL

### ELECTRONIC ENGINE IMMOBILISER

This locks the engine management system as soon as the ignition has been switched off and therefore prevents starting of the vehicle by anyone who does not have the key.

The ignition key has an electronic chip which has a special code. When the ignition is switched on, the code is recognised and starting is possible.

**If the system does not function correctly**, contact a PEUGEOT dealer as soon as possible.



### Confidential card

The confidential card contains the identification code necessary for any work carried out by a PEUGEOT dealer on the system. This code is hidden by a film, which should be removed only if necessary.

**Keep your card in a safe place, never inside the vehicle.**



*Make a careful note of the number on each key. The key number is coded on the label attached to the key.*

*If the keys are lost, your PEUGEOT dealer can rapidly supply you with new keys.*

*The high frequency remote control is a sensitive system; do not operate it while it is in your pocket as there is a possibility that it may unlock your vehicle, without you being aware of it.*

*The remote control does not operate when the key is in the ignition, even when the ignition is switched off, except for reprogramming.*

*Driving with the doors locked may make access to the passenger compartment by the emergency services more difficult in an emergency.*

*As a safety precaution (with children on board), remove the ignition key when you leave the vehicle, even for a short time.*

*Do not repeatedly press the button of your remote control out of range of your vehicle.*

*You run the risk of stopping it from working and the remote control would have to be reprogrammed.*

*When purchasing a second-hand vehicle:*

- ensure that you are given the confidential card;*
- have the key codes memorised by a PEUGEOT dealer, to ensure that the keys in your possession are the only ones which can start the vehicle.*

*Do not make any modifications to the electronic engine immobiliser system.*

## SPECIAL FEATURES

### THE ALARM\*

#### Setting and deactivating the alarm system

##### Switching off the siren

The alarm completes the security equipment for your vehicle. It offers two types of protection.

- **external protection:** when it is set, the alarm sounds if one of the doors, the boot or the bonnet is opened;
- **internal protection:** when it is set, the alarm sounds if the sensors detect air movement in the passenger compartment (a broken window) or movement within the car.

The alarm also has an anti-tamper function.

If there is an attempt to tamper with the wires to the siren, control unit or the battery, the siren sounds and the direction indicators light.

#### Setting the alarm (external and internal protection)

Switch the ignition off and get out of the vehicle.

Deadlock the vehicle.

The doors lock.

The direction indicators light for two seconds.

The red light on the switch flashes once a second.

5 seconds later, internal protection is set.

45 seconds later, external protection is set.

**Note:** when the alarm is triggered, the siren sounds for thirty seconds. After the thirty seconds it stops, but the alarm remains set.

#### Warning

When the alarm is set, if a door, the tailgate or bonnet are not closed correctly, the siren sounds for a moment. If the vehicle is closed correctly in the following 45 seconds, the alarm is activated and the direction indicators remain on for two seconds. In all cases, the alarm is activated after 45 seconds.

#### Disarming the alarm (internal and external protection)

Press the release button of the remote control key.

The doors unlock.

The direction indicators flash for two seconds.

The red light on the switch goes out.

**Note:** if the warning light continues to flash after de-activation of the alarm, it is a sign that the alarm has been triggered. The flashing will stop when the ignition is switched ON.

\* According to destination.

# YOUR 206 IN DETAIL

## THE DOORS



The front doors



The rear doors (206 SW)

Opening the doors from outside

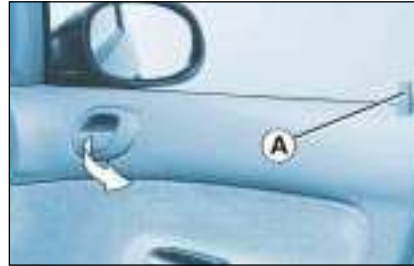

### Opening the doors from inside

#### Locking from inside

##### Without central locking

To lock, press button **A**. The button locks the door in question.

The button on the driver's door locks the door, the tailgate and the rear screen (206 SW).

##### With central locking

To lock, press button **A**.

Locking one of the front doors locks the front and rear doors, the tailgate and the rear screen (206 SW).

On the rear doors, the button only locks the door in question.

#### Unlocking from inside

To unlock, pull button **A** or operate the handle.

## "Door open" warning

**With the engine running**, you are warned if a door is not shut properly by an audible signal and a message or graphic on the multifunction display, indicating the door in question.

**Note:** if your vehicle is not fitted with central locking, a rear door which is not shut properly is not indicated by an audible signal, a message or a graphic on the multifunction display.

In addition, **when the vehicle is moving**, if the courtesy light button is in the "lighting on opening a door" position, the courtesy light flashes.

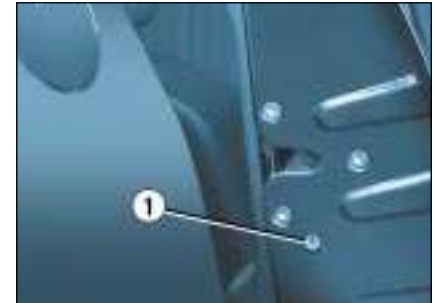

## CHILD SAFETY LOCK

On each rear door this prevents opening of the door from the inside. Turn switch **1** a quarter turn using the ignition key.

## YOUR 206 IN DETAIL

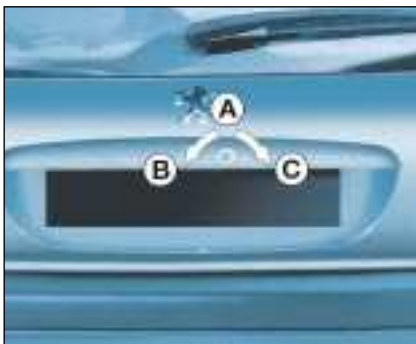

### LOCKING/UNLOCKING OF THE TAILGATE (saloon and 206 GTi 180)

#### Without central locking:

To lock, turn the key from **A** to **C**.  
To open, turn the key from **A** to **B**, press the handle then lift the tailgate.

#### With central locking:

Locking and unlocking of the tailgate is simultaneous with the doors.

**The lighting is activated on opening the tailgate.**

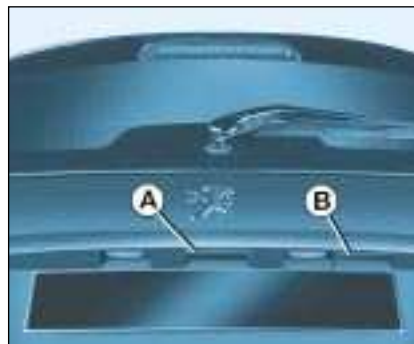

### LOCKING/UNLOCKING OF THE TAILGATE AND REAR SCREEN (206 SW)

*It is not possible to open the tailgate and the rear screen simultaneously.*

#### Without central locking

The tailgate and rear screen are locked or unlocked via the driver's door lock.  
With the rear screen closed, to open the **tailgate**, operate the handle **A** and lift the tailgate.

With the tailgate closed, to open the **rear screen**, operate the handle **B**, then lift the rear screen using the windscreen wiper arm (location **C**).

#### With central locking

Locking or unlocking of the tailgate is simultaneous with the doors.

With the rear screen closed, to open the **tailgate**, operate the handle **A** and lift the tailgate.

With the tailgate closed, to open the **rear screen**, press and hold the remote control unlocking button or operate the handle **B**, then lift the rear screen using the windscreen wiper arm (location **C**).



## YOUR 206 IN DETAIL

The lighting is activated on opening the tailgate or the rear screen.

**Notes:** the tailgate and the rear screen lock automatically while driving (above 6 mph (10 km/h)) and unlock when one of the doors is opened.

When the rear windscreen wiper is in a wiping position, the rear screen can only be opened at the end of the cycle.

Close the rear screen using the windscreen wiper arm or by pressing the centre of the glass.

### "Tailgate/rear screen open" warning

With the engine running, if the tailgate or the rear screen is not properly closed, you are warned by an audible signal and a message "Tailgate open" or a diagram on the multifunction display.

In addition, **while driving**, if the courtesy light button is in the "lighting on opening the tailgate or rear screen" position, the courtesy light flashes.

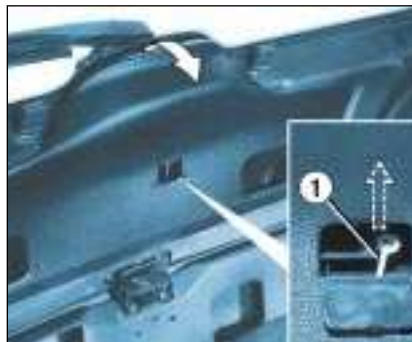

### TAILGATE RELEASE (saloon and 206 GTi 180)

This enables the tailgate to be unlocked in the event of a central locking fault:

- Fold back the rear seats to gain access to the boot from inside the vehicle,
- Pull the tailgate trim to release it,
- Pull the opening catch **1** upwards.

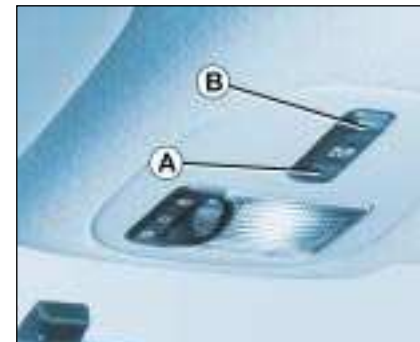

### SUNROOF (saloon and 206 GTi 180)

#### To open

Press part **B** of the switch. The sunroof will open in the intermediate (comfort) position. To open completely, press part **B** again.

#### To close

Press part **A** of the switch. The sunroof will close in the intermediate (comfort) position. To close completely, press part **A** again.

#### Panoramic sunroof screen

To move it to your chosen position, press part **A** or **B** of the switch.



## YOUR 206 IN DETAIL

The lighting is activated on opening the tailgate or the rear screen.

**Notes:** the tailgate and the rear screen lock automatically while driving (above 6 mph (10 km/h)) and unlock when one of the doors is opened.

When the rear windscreen wiper is in a wiping position, the rear screen can only be opened at the end of the cycle.

Close the rear screen using the windscreen wiper arm or by pressing the centre of the glass.

### "Tailgate/rear screen open" warning

With the engine running, if the tailgate or the rear screen is not properly closed, you are warned by an audible signal and a message "Tailgate open" or a diagram on the multifunction display.

In addition, **while driving**, if the courtesy light button is in the "lighting on opening the tailgate or rear screen" position, the courtesy light flashes.

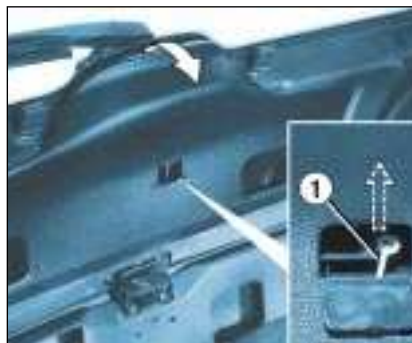

### TAILGATE RELEASE (saloon and 206 GTi 180)

This enables the tailgate to be unlocked in the event of a central locking fault:

- Fold back the rear seats to gain access to the boot from inside the vehicle,
- Pull the tailgate trim to release it,
- Pull the opening catch **1** upwards.

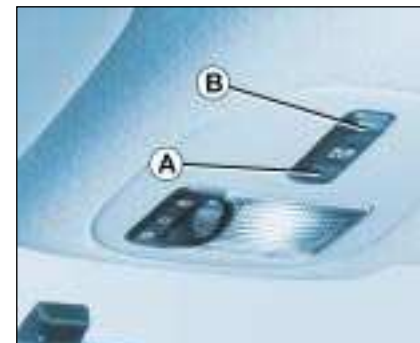

### SUNROOF (saloon and 206 GTi 180)

#### To open

Press part **B** of the switch. The sunroof will open in the intermediate (comfort) position. To open completely, press part **B** again.

#### To close

Press part **A** of the switch. The sunroof will close in the intermediate (comfort) position. To close completely, press part **A** again.

#### Panoramic sunroof screen

To move it to your chosen position, press part **A** or **B** of the switch.

## YOUR 206 IN DETAIL



*Always remove the key from the ignition when leaving the vehicle, even for a short time.*

*If an obstacle is detected when operating the roof, you must reverse the movement of the roof. To do this, press the control concerned.*

*When the driver operates the roof control, he must ensure that no one is preventing correct closing of the roof.*

*The driver must ensure that passengers use the sunroof correctly.*

*Be aware of children when operating the roof.*

### FILLING THE FUEL TANK

The tank must be filled with fuel with **the engine switched off.**

Insert the key then turn it to the left. Remove the cap.

A label indicates which type of fuel to use.

If you fill your tank, do not continue after the third cut-off of the pump nozzle. This could result in vehicle malfunctions.

**The capacity of the tank is approximately 50 litres.**



### OPENING THE BONNET

**Inside the vehicle:** pull the handle on the left-hand side, under the fascia.

**Outside the vehicle:** lift the catch and raise the bonnet.



### BONNET STRUT

Secure the strut to hold the bonnet open.

Before closing the bonnet, replace the strut in its housing.

#### To close

Lower the bonnet and release it at the end of its travel. Check that the bonnet is locked.

## YOUR 206 IN DETAIL



*Always remove the key from the ignition when leaving the vehicle, even for a short time.*

*If an obstacle is detected when operating the roof, you must reverse the movement of the roof. To do this, press the control concerned.*

*When the driver operates the roof control, he must ensure that no one is preventing correct closing of the roof.*

*The driver must ensure that passengers use the sunroof correctly.*

*Be aware of children when operating the roof.*

### FILLING THE FUEL TANK

The tank must be filled with fuel with **the engine switched off.**

Insert the key then turn it to the left. Remove the cap.

A label indicates which type of fuel to use.

If you fill your tank, do not continue after the third cut-off of the pump nozzle. This could result in vehicle malfunctions.

**The capacity of the tank is approximately 50 litres.**



### OPENING THE BONNET

**Inside the vehicle:** pull the handle on the left-hand side, under the fascia.

**Outside the vehicle:** lift the catch and raise the bonnet.



### BONNET STRUT

Secure the strut to hold the bonnet open.

Before closing the bonnet, replace the strut in its housing.

#### To close

Lower the bonnet and release it at the end of its travel. Check that the bonnet is locked.

## YOUR 206 IN DETAIL

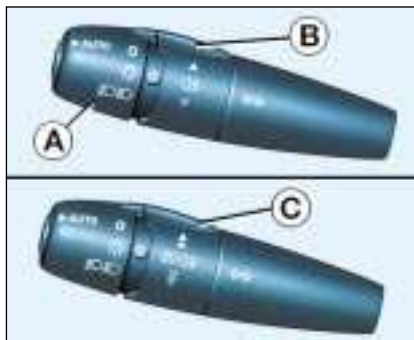

### THE LIGHTS STALK

#### Front and rear lights

Selection is by turning ring A.



Lights off



Side lights



Dipped/main beam headlamps



Automatic switching on of lights

#### Dipped/Main beam change

Pull the stalk towards you.

**Note:** with the ignition off, when the driver's door is opened, a buzzer sounds if you have left your lights on.

#### Front fog lamps and rear fog lamp

Rotate the ring forwards to switch on and backwards to switch off. The status is confirmed by the indicator light on the instrument panel.

#### Vehicles fitted with a rear fog lamp (ring B)



Rear fog lamp

This only operates with the dipped/main beam headlamps.

**Note:** when the lights are switched off automatically, the rear fog lamp and the dipped headlamps will remain on (turn the ring backwards to switch off the rear fog lamp. The dipped headlamps and side lights will then be switched off).

#### Vehicles fitted with front fog lamps and a rear fog lamp (ring C)



Front fog lamps (first rotation of the ring forwards)

The front fog lamps operate with the side lights and the dipped headlamps.

When the main beam headlamps are switched on, the front fog lamps are switched off. They are switched on again when the main beam headlamps are switched off.



Front and rear fog lamps (2nd rotation of the ring forwards).

**Note:** to switch off the rear fog lamp and the front fog lamps, turn the ring backwards twice in succession.

**Note:** when the lights are switched off automatically or when the dipped headlamps are switched off manually, the front fog lamps, the rear fog lamp and the side lights will remain on (turn the ring backwards to switch off the front fog lamps. The side lights will then be switched off).

## YOUR 206 IN DETAIL

### "Follow me home" lighting

In poor light or at night, if you leave your vehicle, the side lights and dipped headlamps can be left on for approximately one minute.

To do this:

- place the key in the **STOP** position,
- place the lights stalk in the **0** position,
- flash the headlamps,
- get out of the vehicle and lock it.



*In good or rainy weather, both day and night, the front fog lamps and the rear fog lamp are dazzling and are prohibited.*

*Do not forget to switch them off when they are no longer needed.*

### Direction indicators (flashers)



**Left:** downwards.  
**Right:** upwards.

### AUTOMATIC SWITCHING ON OF LIGHTS

Side lights and dipped beam headlamps switch on automatically if the light is poor and when the windscreen wipers operate continuously.

They switch off at the same time when the light becomes bright enough or the windscreen wipers are switched off.

***Note:** In foggy weather or in snow the brightness sensor can detect sufficient light. As a result, the lights will not come on automatically.*

This function is active when the vehicle is supplied to the customer.

To disarm or activate the function:

- Place the key in the accessories position (1st notch),
- Press the end of the lights stalk for more than four seconds.

**The brightness sensor, coupled with the rain sensor, is located in the centre of the windscreen, behind the interior mirror. It is used for automatic switching on of the lights.**

### Operating check

#### Activation

Activation of this function is accompanied by an audible signal and the message **"Automatic lighting active"** on the multifunction display.

#### Disarming

Disarming of the function is accompanied by an audible signal.

**Note:** the function is temporarily disarmed when the driver uses the manual lighting controls.

**If the brightness sensor does not function correctly**, the system activates the function (the lights come on). The driver is alerted by an audible signal, accompanied by the message **"Auto lighting fault"** on the multifunction display.

Contact a PEUGEOT dealer to have the system checked.

## YOUR 206 IN DETAIL

### "Follow me home" lighting

In poor light or at night, if you leave your vehicle, the side lights and dipped headlamps can be left on for approximately one minute.

To do this:

- place the key in the **STOP** position,
- place the lights stalk in the **0** position,
- flash the headlamps,
- get out of the vehicle and lock it.



*In good or rainy weather, both day and night, the front fog lamps and the rear fog lamp are dazzling and are prohibited.*

*Do not forget to switch them off when they are no longer needed.*

### Direction indicators (flashers)



**Left:** downwards.  
**Right:** upwards.

### AUTOMATIC SWITCHING ON OF LIGHTS

Side lights and dipped beam headlamps switch on automatically if the light is poor and when the windscreen wipers operate continuously.

They switch off at the same time when the light becomes bright enough or the windscreen wipers are switched off.

***Note:** In foggy weather or in snow the brightness sensor can detect sufficient light. As a result, the lights will not come on automatically.*

This function is active when the vehicle is supplied to the customer.

To disarm or activate the function:

- Place the key in the accessories position (1st notch),
- Press the end of the lights stalk for more than four seconds.

**The brightness sensor, coupled with the rain sensor, is located in the centre of the windscreen, behind the interior mirror. It is used for automatic switching on of the lights.**

### Operating check

#### Activation

Activation of this function is accompanied by an audible signal and the message **"Automatic lighting active"** on the multifunction display.

#### Disarming

Disarming of the function is accompanied by an audible signal.

**Note:** the function is temporarily disarmed when the driver uses the manual lighting controls.

**If the brightness sensor does not function correctly,** the system activates the function (the lights come on). The driver is alerted by an audible signal, accompanied by the message **"Auto lighting fault"** on the multifunction display. Contact a PEUGEOT dealer to have the system checked.

## YOUR 206 IN DETAIL

### WINDSCREEN WIPER STALK

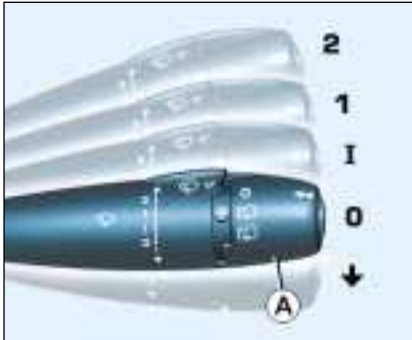

#### Front windscreen wiper with intermittent wipe

- 2** Fast wipe (heavy rain).
- 1** Normal wipe (moderate rain).
- I** Intermittent wipe.
- 0** Off.
- ↓** Single wipe (press downwards).

In the **Intermittent** position, the wiping speed is in proportion to the vehicle speed.

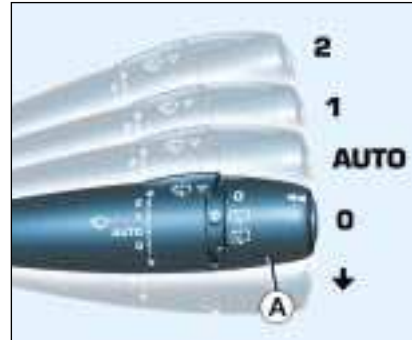

#### Front windscreen wiper with automatic wipe

- 2** Fast wipe (heavy rain).
- 1** Normal wipe (moderate rain).
- AUTO** Automatic wipe.
- 0** Off.
- ↓** Single wipe (press downwards).

In the **AUTO** position, the wiping speed is in proportion to the intensity of the rainfall.

After the ignition has been switched off, if the stalk was in a wipe position, you must reactivate this function:

- move the stalk to any position,
- then move it back to the required position.

#### Windscreen wash

Pull the wipers stalk towards you. The windscreen wash, then the windscreen wipers, operate for a fixed period.

## YOUR 206 IN DETAIL

### Automatic timed windscreen wipers

In the **AUTO** position, the windscreen wipers operate automatically and **adapt their speed to the intensity of the rainfall.**

### Operating check

#### Activation

When the function is activated, the message "**Automatic wiping active**" appears on the multifunction display.

**In the event of malfunction**, the driver is informed by an audible signal and the message "**Auto wiper fault**" on the multifunction display.

**In the event of malfunction** in the **AUTO** position, the windscreen wiper will operate in intermittent mode.

Contact a PEUGEOT dealer to have the system checked.



*Do not cover the rain sensor located on the windscreen behind the interior mirror.*

*When using an automatic car wash, switch off the ignition or check that the wiper stalk is not in the automatic position.*

*In winter, it is advisable to wait for the windscreen to completely clear of ice before operating the automatic wipe.*

### Rear screen wiper



Turn ring **A** to the first notch for intermittent wiping.

### Rear screen wash



Turn ring **A** past the first notch; the screen wash then the wiper operate for a fixed period.

**206 SW:** the rear screen wiper and rear screen wash functions are disarmed when the rear screen is open.



## YOUR 206 IN DETAIL

### Automatic timed windscreen wipers

In the **AUTO** position, the windscreen wipers operate automatically and **adapt their speed to the intensity of the rainfall.**

### Operating check

#### Activation

When the function is activated, the message "**Automatic wiper active**" appears on the multifunction display.

**In the event of malfunction**, the driver is informed by an audible signal and the message "**Auto wiper fault**" on the multifunction display.

**In the event of malfunction** in the **AUTO** position, the windscreen wiper will operate in intermittent mode.

Contact a PEUGEOT dealer to have the system checked.



*Do not cover the rain sensor located on the windscreen behind the interior mirror.*

*When using an automatic car wash, switch off the ignition or check that the wiper stalk is not in the automatic position.*

*In winter, it is advisable to wait for the windscreen to completely clear of ice before operating the automatic wipe.*

### Rear screen wiper



Turn ring **A** to the first notch for intermittent wiping.

### Rear screen wash



Turn ring **A** past the first notch; the screen wash then the wiper operate for a fixed period.

**206 SW:** the rear screen wiper and rear screen wash functions are disarmed when the rear screen is open.

# YOUR 206 IN DETAIL

## TRIP COMPUTER



Pressing the button on the end of the **wash/wipe stalk** enables the following data to be displayed:

### Display B



- the range
- the distance travelled
- the average consumption
- the current consumption
- the average speed

### Zero reset

Press the stalk for more than two seconds.

### Display C



- the current consumption and the range,
- the average consumption, the distance travelled and the average speed calculated over a period "1",
- the average consumption, the distance travelled and the average speed calculated over a period "2".

Periods "1" and "2" are defined by the frequency of the zero reset. They allow, for instance, daily calculations over period "1" and monthly calculations over period "2".

### Zero reset

When the required period is displayed, press the stalk for more than two seconds.

## YOUR 206 IN DETAIL



### Range

The display shows the distance that can still be covered with the fuel remaining in the tank.

**Note:** this figure may rise if there is a change in driving style or road surface, causing a significant drop in current fuel consumption.

If there are less than 3 litres of fuel in the tank, only three segments will be displayed.

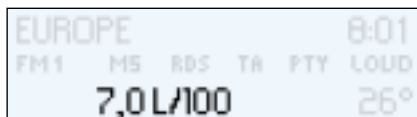

### Current fuel consumption

This gives the fuel consumption recorded during the last two seconds. This function is only displayed when the vehicle is travelling at more than 12 m.p.h. (20 km/h).



### Average consumption

This is the ratio between the amount of fuel consumed and the distance travelled since the computer was last reset to zero.



### Average speed

This is obtained by dividing the distance travelled by the period of time the vehicle has been in use (with the ignition on), since the computer was last reset to zero.



### Distance travelled

This shows the distance travelled since the computer was last reset to zero.

After the trip computer has been reset to zero, the range data becomes meaningful only after the vehicle has been in use for a certain period.

If horizontal segments are displayed instead of figures when driving, contact a PEUGEOT dealer.

## YOUR 206 IN DETAIL

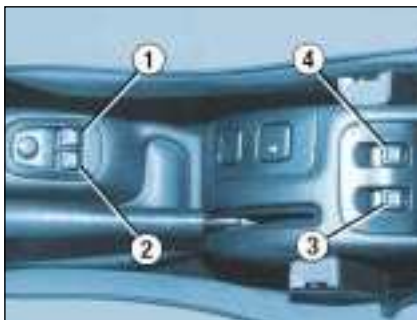

### ELECTRIC WINDOWS

#### 1. Driver's electric window switch

You have two options:

– **Manual operation:**

Press or pull switch 1 gently. The window stops as soon as the switch is released.

– **Automatic operation:**

Press or pull switch 1 firmly. One touch completely opens or closes the window.

Automatic closing only operates when the engine is running and only on the driver's electric window.

2. Passenger's electric window switch.
3. Rear left electric window switch.
4. Rear right electric window switch.

### Temporary disarming of the rear windows (child safety)



This switch enables the rear windows to be locked whatever their position.

A 1st press activates the control (the indicator light on the button comes on) and a 2nd press deactivates it (the indicator light on the button goes out).



*Always remove the key from the ignition when leaving the vehicle, even for a short time.*

*If an obstacle is detected when operating the electric windows, you must reverse the movement of the window. To do this, press the control concerned.*

*When the driver operates the passenger electric window controls, he must ensure that no one is preventing correct closing of the windows.*

*The driver must ensure that passengers use the electric windows correctly.*

*Be aware of children when operating the windows.*

### REAR QUARTER LIGHTS (3 DOOR)

To partially open the rear windows, tilt lever then push the window.

## YOUR 206 IN DETAIL



### Manual interior mirror

The interior mirror has two positions:

- day (normal),
- night (anti-dazzle).

To change from one to the other, push or pull the lever on the lower edge of the mirror.



### Manual exterior mirrors

Move the lever in all four directions to adjust.

When the vehicle is parked, the exterior mirrors can be folded back manually.

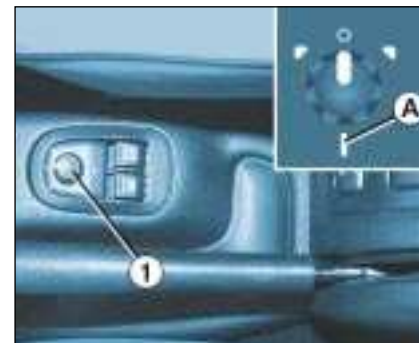

### ELECTRIC EXTERIOR MIRRORS

Turn knob 1 to the right or to the left to select the corresponding mirror.

Move knob 1 in all four directions to adjust.

#### Fold-back electric mirrors

With the ignition on, turn knob 1 to position A.



*The outside of the mirror on the driver's side is convex (area at edge defined by dotted line) in order to eliminate the "blind spot".*

*Furthermore, objects observed in the driver's and passenger's mirrors are in reality closer than they appear.*

*This must be taken into account to judge correctly the distance of vehicles approaching from behind.*

## YOUR 206 IN DETAIL



### COURTESY LIGHTS

#### Front courtesy light (button A)



Comes on when a door, the tailgate (206 SW) or the rear screen (206 SW) is opened. In this position the courtesy light flashes while driving if an access is not closed correctly.



Off



Permanently on when the key is in the accessories position or with the ignition on.

#### Map-reading light

With the key in the accessories or ignition on position, turn button **B** to the left or to the right.

#### Rear courtesy light (206 SW)



Comes on when a door, the tailgate or the rear screen is opened. In this position the courtesy light flashes while driving if an access is not closed correctly.



Off



Permanently on when the key is in the accessories position or with the ignition on.



### AREAS FOR TOLL CARDS/ CAR PARK TICKETS

The athermic windscreen has two non-reflective zones located either side of the base of the interior mirror.

They are intended for affixing toll cards and/or car park tickets.

### SUN VISOR

The sun visors are fitted with a vanity mirror, with a concealing flap on the driver's side.

## YOUR 206 IN DETAIL



### HEADLAMP ADJUSTMENT

Depending on the load in your vehicle, it is recommended that the headlamp beam is adjusted.

- 0** - 1 or 2 people in the front seats.
- - 3 people.
- 1** - 5 people.
- 2** - 5 people + maximum authorised load.
- 3** - Driver + maximum authorised load.

**Initial setting is position 0.**



### STEERING WHEEL HEIGHT ADJUSTMENT

When stationary, lower the handle to unlock the steering wheel.

Adjust to the desired height and lift the handle to lock the steering wheel.



### HORN



Press one of the spokes or the centre of the steering wheel.

## YOUR 206 IN DETAIL



### FRONT ASHTRAY

To empty, close the cover.

Pull the lug and release the ashtray upwards.

### LIGHTER

Press and wait a few minutes until it springs out automatically.

It is supplied with power with the ignition key in the accessories position (1st notch).



### GLOVE BOX

To open the glove box, lift the handle. The light comes on when the cover is opened.

1. Handbook pack storage.
2. Can holder.
3. Pen holder.
4. Spectacles storage.
5. Map storage.
6. Coin storage.



## YOUR 206 IN DETAIL

### BOOT LAYOUT (SALOON)



#### Rear parcel shelf

To remove the shelf:

- unhook the two strings 1,
- slightly raise the shelf, then remove it.



There are several options for storing the shelf:

- either behind the front seats,
- or behind the rear seat using the luggage retaining net,
- or flat in the boot.



#### Stowing rings

Use the stowing rings on the boot floor and on the back of the rear seat to secure your luggage.

#### Luggage retaining net

Hooked onto the stowing rings, this enables your luggage to be secured.



#### Retaining strap

A strap secured to the side of the boot enables you to secure various objects (cans, first aid kit etc.).

## YOUR 206 IN DETAIL

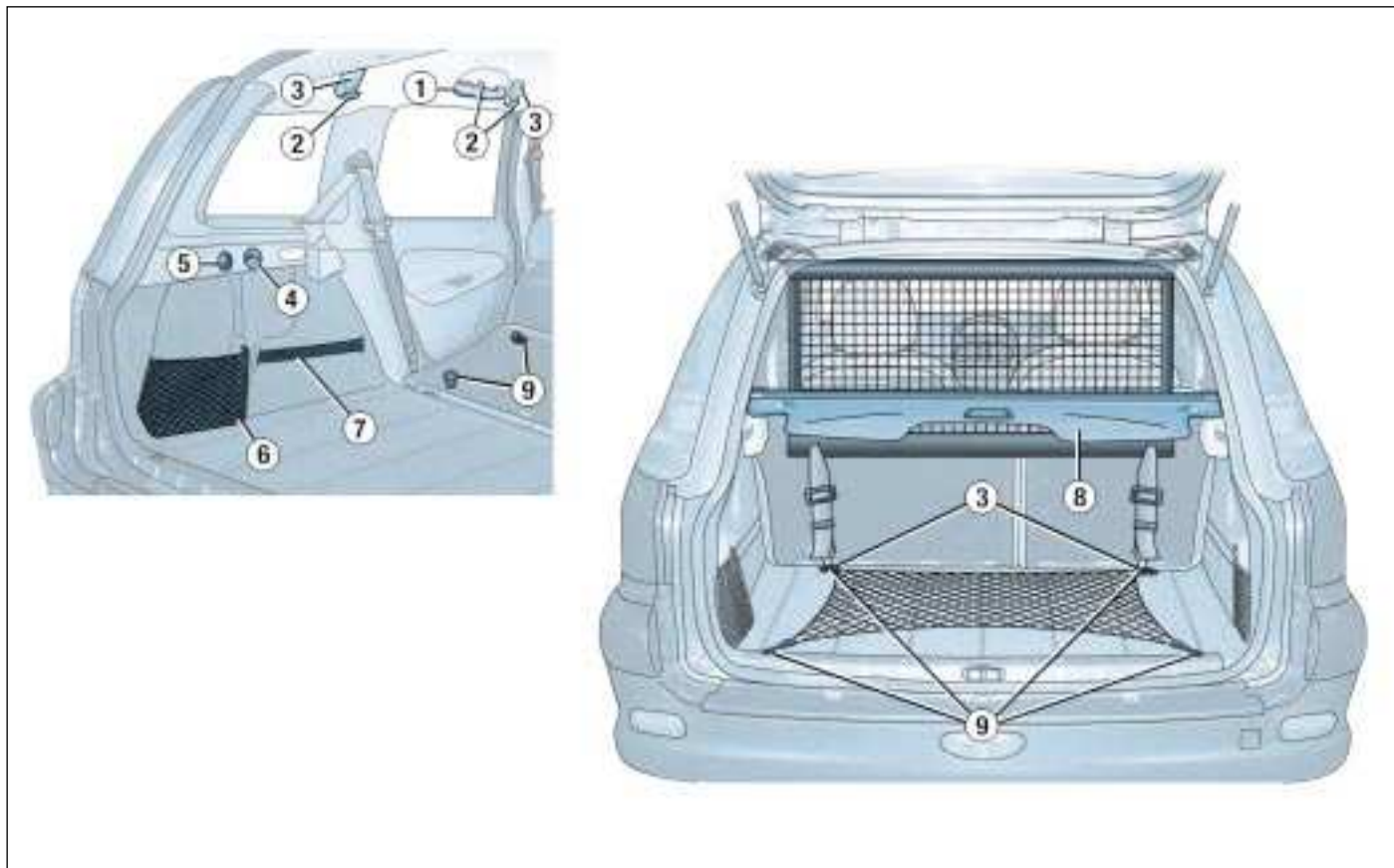

# YOUR 206 IN DETAIL

## BOOT LAYOUT (206 SW)

### 1. Grab handles and coat hooks

### 2. Coat hooks

There are six hooks to accommodate coats.

### 3. High load retaining net fastenings

The high load retaining net can be installed behind the front seats or behind the rear seat.

Open the covers of the corresponding upper fastenings.

Install one end of the metal bar in one of the two fastenings, compress the bar, then install the other end and release.

Secure the two net strap hooks behind the front seats, with the rear seat folded down, or in the stowing rings on the floor.

The rings are located directly below the corresponding upper fastenings.

Pull the two straps taut.

### 4. Hooks

There are two side hooks on which to hang light bags.

### 5. 12 V Socket for accessories

This is a 12 volt socket (lighter type) installed on the the rear left trim and supplied from the accessories position (1st notch).

### 6. Storage nets

There are two nets (which cannot be removed) which can contain the luggage retaining net, a first aid kit etc.

### 7. Retaining straps

There are two straps for securing various objects: cans etc.

### 8. Load space cover

**Note:** release the rear seat back to make installation and removal of the load space cover easier.

To install it:

- position one end of the roller in one of the two supports,
- compress the opposite end of the roller and position it,
- release it to allow it to engage,
- unroll the cover as far as the boot pillars,
- insert the cover guides in the rails in the pillars.

To remove it:

- remove the cover guides from the pillar rails,
- return the cover into its roller, compress it and remove it from its support.

### 9. Stowing rings

There are eight stowing rings for securing the luggage retaining net: four on the rear seat back and four on the boot floor (two of which are under the carpet, at the far end of the boot).

### Warning triangle

The tailgate has a location intended for a warning triangle.

## YOUR 206 IN DETAIL

---

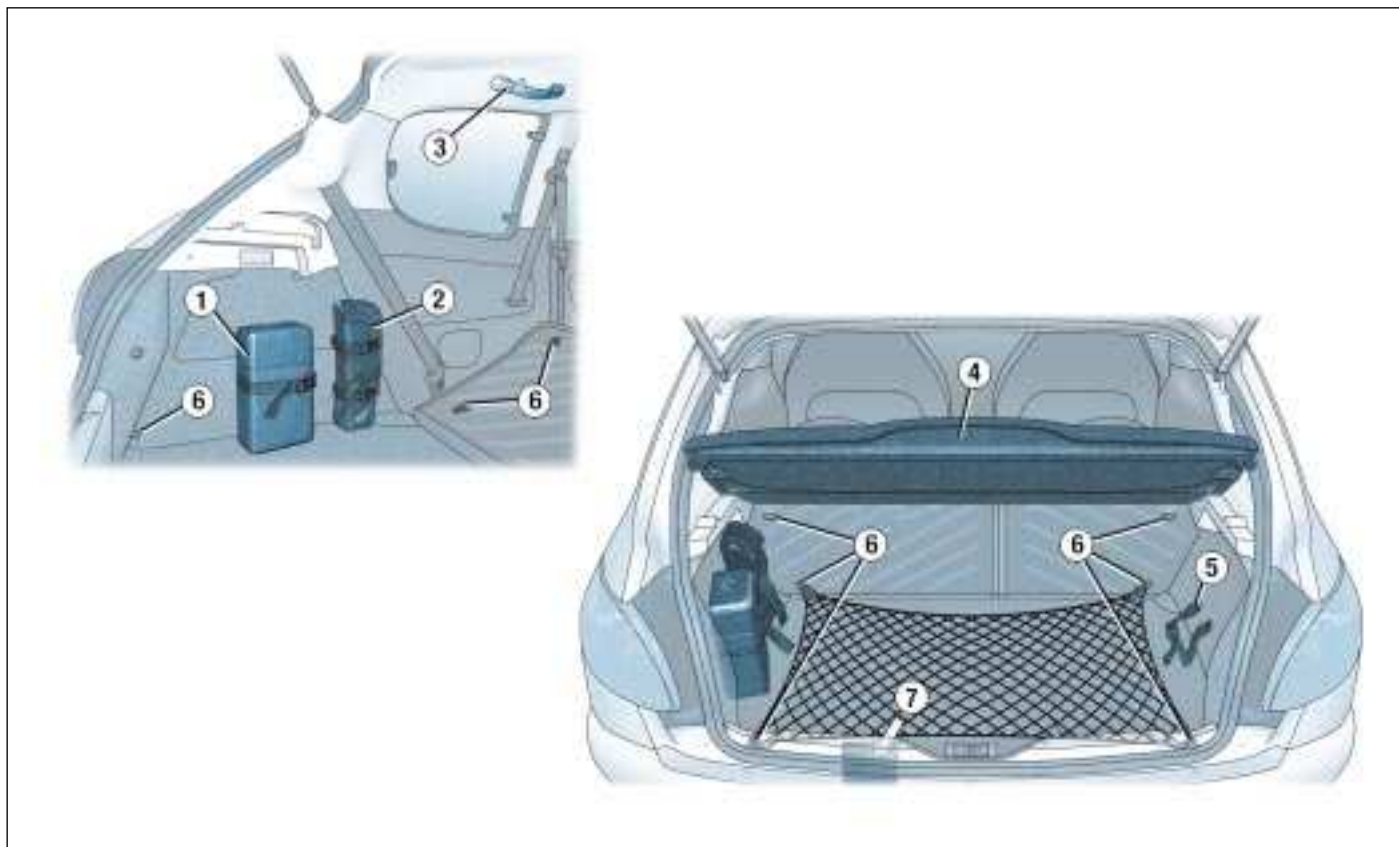

## YOUR 206 IN DETAIL

---

### BOOT LAYOUT (206 GTi 180\*)

1. **Puncture repair aerosols insulated storage box.**
2. **Cover containing the jack and the folding chock.**
3. **Grab handles with coat hook.**
4. **Removable rear shelf.**
5. **Retaining strap for miscellaneous objects: can, first aid kit, etc.**
6. **Stowing rings.**  
There are six stowing rings onto which the luggage retaining net may be hooked: four on the back of the rear seats and two on the boot rear inner panel (on the right and on the left).
7. **Luggage retaining net storage** (example of location).

\* During the year, according to destination.

## YOUR 206 IN DETAIL



### AUTOMATIC AUTOADAPTIVE GEARBOX

#### Moving Off

To move off, move the selector lever to position **N** or **P**. **Press the brake to exit position P.**

#### Stopped or parked

Always leave the lever in position **P** when you get out of your vehicle. If not, a buzzer will sound when you open the driver's door.

#### Positions of the selector lever

These positions are displayed on the instrument panel.

- P.** Park: use with the handbrake.
  - R.** Reverse: this must only be engaged when the vehicle is stationary, engine at idle.
  - N.** Neutral: if **N** is engaged by mistake while the car is moving, allow the engine to return to idle before engaging a new forward gear.
  - D.** Drive: in this position, the four gears change automatically. The gear change points vary depending on the programme selected.
3. Automatic changing of the first three gears only.  
Select this position when you notice frequent changes between third and fourth gear (town driving or on winding roads).
  2. Automatic changing of the first two gears only.  
This position is particularly suitable for mountain roads, when going uphill (to make the best use of the engine's power) or downhill (engine braking).

## YOUR 206 IN DETAIL

### Operating programmes

You have a choice of three operating programmes:

- Autoadaptive (normal)
- Sport
- Snow

One press on button **A** or **B** will select Sport or Snow respectively. The selection is displayed on the instrument panel. Pressing the button a second time will return to the autoadaptive (normal) programme.

### Autoadaptive programme (normal)

Gear changes are carried out on the basis of various parameters, such as:

- driving style,
- road characteristics,
- vehicle load.

The gearbox selects the most suitable programme from those in the memory for the current driving conditions.

### Sport programme

The Sport programme automatically favours more dynamic driving.

### Snow Programme

In position **D**, the Snow programme provides smooth driving suited to slippery roads in order to improve traction and stability. Starting is in **2nd gear** and changing down is at low engine speeds.

### Special operating features

- During prolonged braking, the gearbox changes down automatically, so as to provide efficient engine braking.
- If you take your foot off the accelerator suddenly (when you are taken by surprise, for example), the gearbox will not change up, so as to improve safety.
- When the engine is cold, the gearbox automatically selects a special programme that enables the engine to reach its ideal temperature more quickly in order to decrease pollution.

### Kickdown

For immediate maximum acceleration without touching the gear lever, press the accelerator pedal down as far as it will go. The gearbox will change down automatically or stay in the gear selected, up to maximum engine speed.



*Any disruption of the system is signalled by the simultaneous flashing of the Sport and Snow lights on the instrument panel. In such a case, the gearbox will operate in downgrade mode. You may feel a substantial knock when reverse is selected from **P** to **R** or **N** to **R** (without any risk of damage to the gearbox).*

*Do not exceed 60 mph (100km/h). Contact a PEUGEOT dealer without delay.*

*When the engine is idling with the car in gear, the car will move even without you accelerating.*

*Do not accelerate while a gear is being selected, when the vehicle is stationary.*

*When stationary, have your foot on the brake pedal when selecting a gear.*

*Do not accelerate in gear with the brakes on.*

*If work needs to be done with the engine running, apply the hand-brake and select position **P**.*

*Do not change down to brake on slippery roads.*

*Never select position **N** when the vehicle is moving.*

*Never engage **P** or **R** unless the vehicle is stationary.*

*Do not leave children inside the vehicle unsupervised when the engine is running.*



## YOUR 206 IN DETAIL



### HANDBRAKE

#### Locking

Pull the handbrake to immobilise your vehicle.

**Warning:** when parking on a slope, direct your wheels towards the pavement and pull the handbrake.

#### Unlocking

Pull on the handle and press the button to release the handbrake.



Illumination of this warning light and of the **STOP** warning light, accompanied by an audible signal (while the vehicle is being driven) and the message "**hand-brake on**" on the multifunction display, indicates that the handbrake is still on or has not been properly released.

### ANTI-LOCK BRAKING SYSTEM (ABS) AND THE ELECTRONIC BRAKE FORCE DISTRIBUTION (EBFD)

The ABS, in conjunction with the electronic brake force distribution, increases the stability and manoeuvrability of your vehicle, particularly on poor or slippery road surfaces.

**Note :** when changing wheels (tyres and rims), make sure that these are approved.

The anti-lock braking system comes into operation automatically when there is a risk of wheel lock.



When this warning light comes on, accompanied by a buzzer and the message "**ABS fault**", it indicates that there is a malfunction of the ABS, which can cause a loss of control of the vehicle when braking.



When this warning light comes on, connected to the **STOP** and **ABS** warning lights, accompanied by a buzzer and the message "**Braking fault**", it indicates that there is a malfunction of the electronic brake force distribution, which can cause a loss of control of the vehicle when braking.

**Stop immediately.**

In both cases, consult a PEUGEOT dealer.

Normal operation of the ABS may make itself felt by slight vibrations of the brake pedal.

**In emergency braking, press very firmly without releasing the pressure.**

### EMERGENCY BRAKING ASSISTANCE SYSTEM

In an emergency, this system enables the optimum braking pressure to be reached more quickly, thus reducing the stopping distance.

It is triggered by the speed at which the brake pedal is activated. The effect of this is a reduction in the resistance of the pedal and an increase in braking efficiency.

In the event of emergency braking, depending on the force of the deceleration, the hazard warning lights are switched on automatically. They are switched off automatically on acceleration.



## YOUR 206 IN DETAIL

### TRACTION CONTROL (ASR) AND DYNAMIC STABILITY CONTROL (ESP)

These systems are linked and complement the ABS.

The ASR system optimises drive to prevent the wheels skidding, by acting on the brakes of the drive wheels and on the engine. It also allows the directional stability of the vehicle to be improved on acceleration.

If there is a variation between the trajectory followed by the vehicle and that required by the driver, the ESP system automatically acts on the engine and the brake of one or more wheels, in order to put the vehicle back on course.

### Operation of the ASR and ESP systems



The warning light flashes if the ASR or ESP is activated.

### Disarming the ASR/ESP systems

In exceptional conditions (starting a vehicle which is bogged down, stuck in snow, on soft ground), it may be advisable to disarm the ASR and ESP systems, so that the wheels can move freely and regain grip.

- ☞ Press the **"ESP OFF"** switch, located under the steering wheel to the right.



The switch lights up and the warning light comes on: the ASR and ESP systems are disarmed.

### These are triggered again:

- ☞ automatically if the ignition is switched off,
- ☞ manually by pressing the switch again.

### Operating check



When a malfunction of the systems occurs, the switch light flashes and the warning light comes on.

Contact a PEUGEOT dealer to have the system checked.



*The ESP system offers exceptional safety in normal driving, but this should not encourage the driver to take extra risks or drive at high speed.*

*The correct functioning of this system depends on observation of the manufacturer's recommendations regarding wheels (tyres and rims), the braking components and the electronic components, as well as the PEUGEOT assembly and operation procedures.*

*After an impact, have the system checked by a PEUGEOT dealer.*

## YOUR 206 IN DETAIL

### AIR BAGS

The air bags have been designed to maximise the safety of the occupants in the event of serious collisions; they work in conjunction with the force limiting seat belts.

In the event of a serious collision, the electronic detectors record and analyse any abrupt deceleration of the vehicle: if the triggering threshold is reached, the air bags inflate instantly and protect the occupants of the vehicle.

Immediately after the impact, the air bags deflate rapidly, so that they do not hinder the visibility of the occupants nor their possible exit from the vehicle.

The air bags will not be deployed in collisions which are not serious, for which the seat belt is sufficient to provide maximum protection. The seriousness of the collision depends on the nature of the obstacle and the speed of the vehicle at the moment of impact.

**Air bags only operate when the ignition is switched on.**

**Note:** the gas escaping from the air bag can be a minor irritant.



### FRONT AIR BAGS

These are folded in the centre of the steering wheel for the driver and in the fascia for the front passenger. They are deployed simultaneously, except in cases where the air bag is disarmed.



#### Front air bag malfunction

If this warning light comes on, accompanied by a buzzer and the message "Air bag fault" on the multifunction display, contact a PEUGEOT dealer to have the system checked.

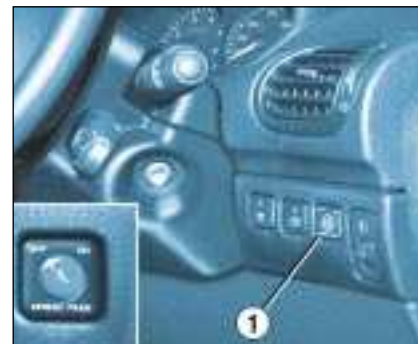

### Disarming the passenger air bag\*

**To ensure the safety of your child, it is essential to disarm the passenger air bag when you install a rear-facing child seat on the front passenger seat.**

☞ With the ignition switched off, insert the key into the passenger air bag disarming switch 1, turn it to the "OFF" position, then remove the key keeping the slot in this position.



The air bag warning light on the instrument panel is lit throughout the disarming process.

\* According to destination.

## YOUR 206 IN DETAIL

In the **"OFF"** position, the passenger air bag will not be triggered in the event of an impact.

As soon as the child seat is removed, turn the air bag slot to the **"ON"** position to re-activate the air bag and thus ensure the safety of your passenger in the event of an impact.

### Operating check

This is confirmed by an indicator light, accompanied by an audible signal and a message on the multi-function display.

With the ignition on (2nd notch), illumination of this warning light accompanied by an audible signal and the message **"Passenger air bag disarmed"** on the multifunction display, indicates that the passenger air bag is disarmed (switch in the **"OFF"** position).

### SIDE AIRBAGS\*

These are incorporated into the frame of the front seat back, on the door side.

They are deployed independently of each other depending on which side the collision occurs, in collisions which could cause injury to the chest, the abdomen or the head.



### Operating check

This is confirmed by an indicator light on the instrument panel.

It comes on for six seconds, each time the ignition is switched on.

#### If the indicator light:

- does not light up when the ignition is switched on, or
- does not go out after six seconds, or
- flashes for five minutes then stays on,

Contact a PEUGEOT dealer.

\* According to destination.

## YOUR 206 IN DETAIL

---



**For the front and side\* air bags to be fully effective, observe the following safety rules:**

- *Wear a correctly adjusted seat belt.*
- *Sit in a normal upright position.*
- *Do not leave anything between the occupants of the front seats and the air bags (a child, pet, object...).*  
*This could hamper the operation of the air bags or injure the occupants.*
- *All work on the air bag system is strictly forbidden unless it is carried out by qualified personnel of the PEUGEOT network.*
- *After an accident or if the vehicle has been stolen or broken into, have the air bag systems checked.*

### **Front air bags**

- *Do not drive holding the steering wheel by its spokes or resting your hands on the centre part of the wheel.*
- *Passengers must not place their feet on the fascia.*
- *Smoke as little as possible; deployment of the air bags can cause burns or the risk of injury from a cigarette or pipe.*
- *Never remove or pierce the steering wheel or hit it violently.*

### **Side air bags\***

- *Only put approved covers on the front seats. Contact your PEUGEOT dealer.*
- *Do not fix or glue anything to the front seat backs. This could cause injury to the chest or arms when the side air bag inflates.*
- *Do not sit with the upper part of the body any nearer to the door than necessary.*

*\* According to destination.*

## YOUR 206 IN DETAIL

In the **"OFF"** position, the passenger air bag will not be triggered in the event of an impact.

As soon as the child seat is removed, turn the air bag slot to the **"ON"** position to re-activate the air bag and thus ensure the safety of your passenger in the event of an impact.

### Operating check

This is confirmed by an indicator light, accompanied by an audible signal and a message on the multi-function display.

With the ignition on (2nd notch), illumination of this warning light accompanied by an audible signal and the message **"Passenger air bag disarmed"** on the multifunction display, indicates that the passenger air bag is disarmed (switch in the **"OFF"** position).

### SIDE AIRBAGS\*

These are incorporated into the frame of the front seat back, on the door side.

They are deployed independently of each other depending on which side the collision occurs, in collisions which could cause injury to the chest, the abdomen or the head.



### Operating check

This is confirmed by an indicator light on the instrument panel.

It comes on for six seconds, each time the ignition is switched on.

#### If the indicator light:

- does not light up when the ignition is switched on, or
- does not go out after six seconds, or
- flashes for five minutes then stays on,

Contact a PEUGEOT dealer.

\* According to destination.

## YOUR 206 IN DETAIL

---



**For the front and side\* air bags to be fully effective, observe the following safety rules:**

- *Wear a correctly adjusted seat belt.*
- *Sit in a normal upright position.*
- *Do not leave anything between the occupants of the front seats and the air bags (a child, pet, object...). This could hamper the operation of the air bags or injure the occupants.*
- *All work on the air bag system is strictly forbidden unless it is carried out by qualified personnel of the PEUGEOT network.*
- *After an accident or if the vehicle has been stolen or broken into, have the air bag systems checked.*

### **Front air bags**

- *Do not drive holding the steering wheel by its spokes or resting your hands on the centre part of the wheel.*
- *Passengers must not place their feet on the fascia.*
- *Smoke as little as possible; deployment of the air bags can cause burns or the risk of injury from a cigarette or pipe.*
- *Never remove or pierce the steering wheel or hit it violently.*

### **Side air bags\***

- *Only put approved covers on the front seats. Contact your PEUGEOT dealer.*
- *Do not fix or glue anything to the front seat backs. This could cause injury to the chest or arms when the side air bag inflates.*
- *Do not sit with the upper part of the body any nearer to the door than necessary.*

*\* According to destination.*

## PRACTICAL INFORMATION

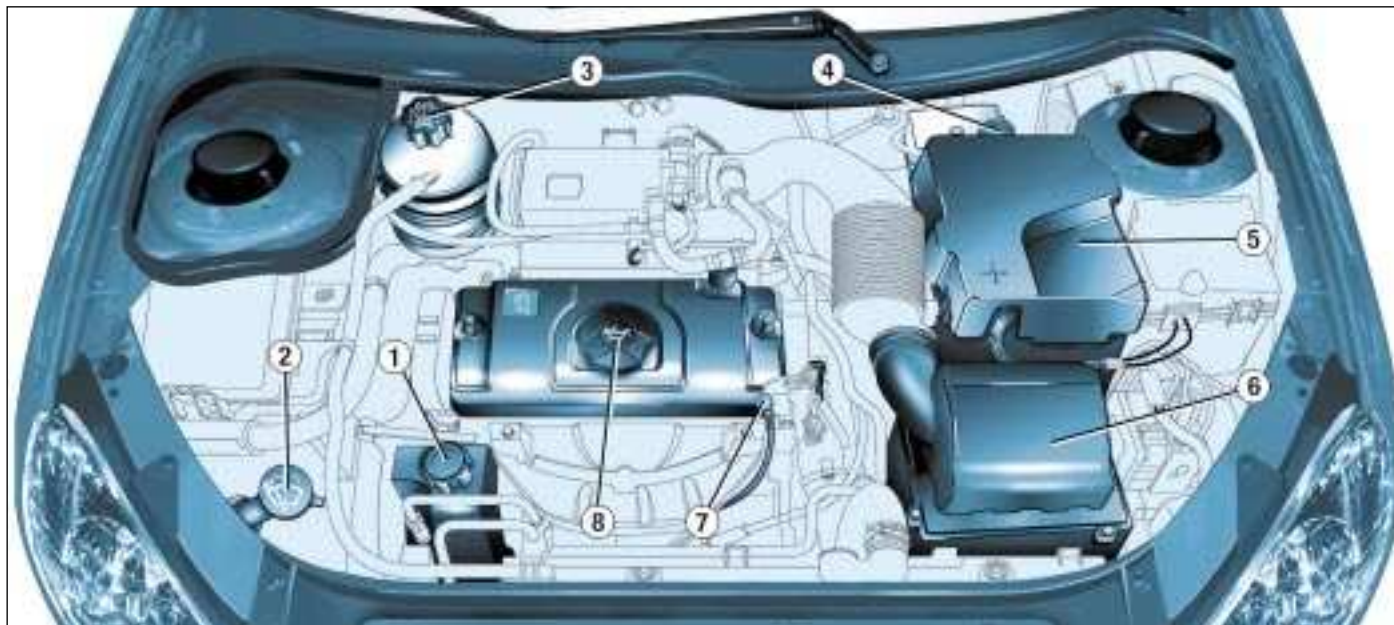

### 1.1 litre, 1.4 litre ENGINE

1. Power steering reservoir
2. Windscreen and headlamp\* wash reservoir
3. Coolant reservoir

4. Brake fluid reservoir
5. Battery
6. Air filter

7. Dipstick

8. Engine oil filler cap

\* According to destination.



## PRACTICAL INFORMATION

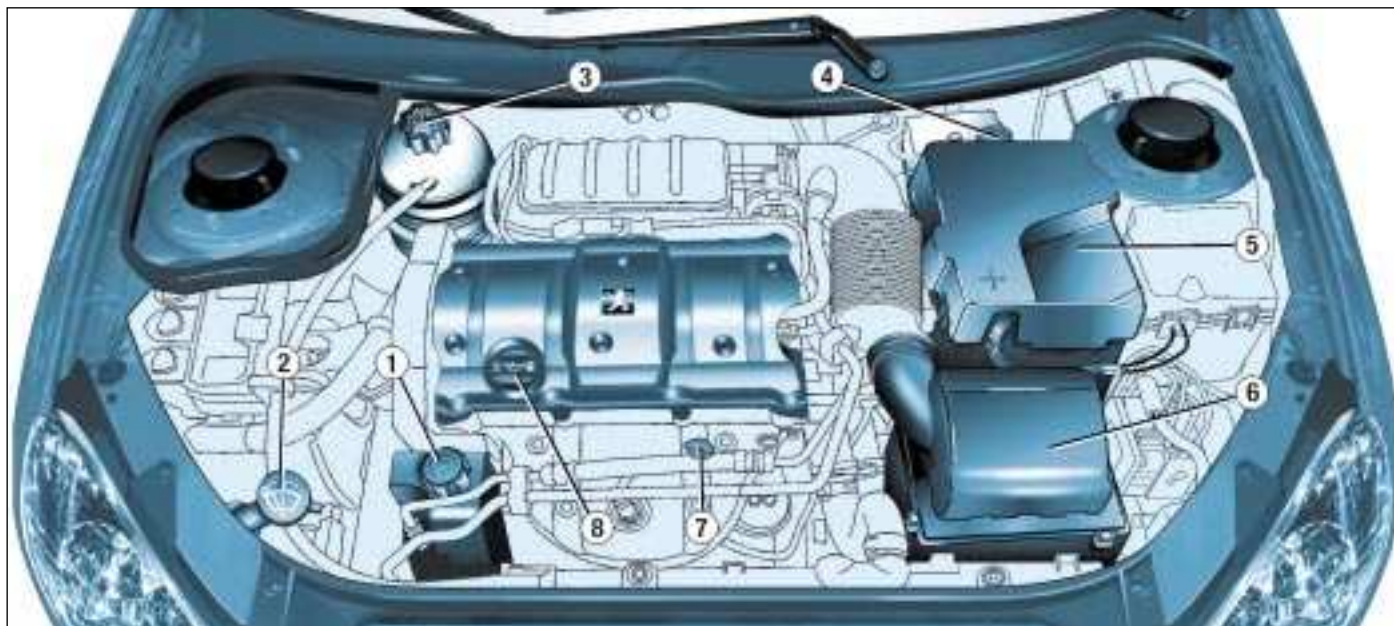

### 1.6 litre 16V ENGINE

1. Power steering reservoir
2. Windscreen and headlamp\* wash reservoir
3. Coolant reservoir

4. Brake fluid reservoir
5. Battery
6. Air filter

7. Dipstick

8. Engine oil filler cap

\* According to destination.



## PRACTICAL INFORMATION

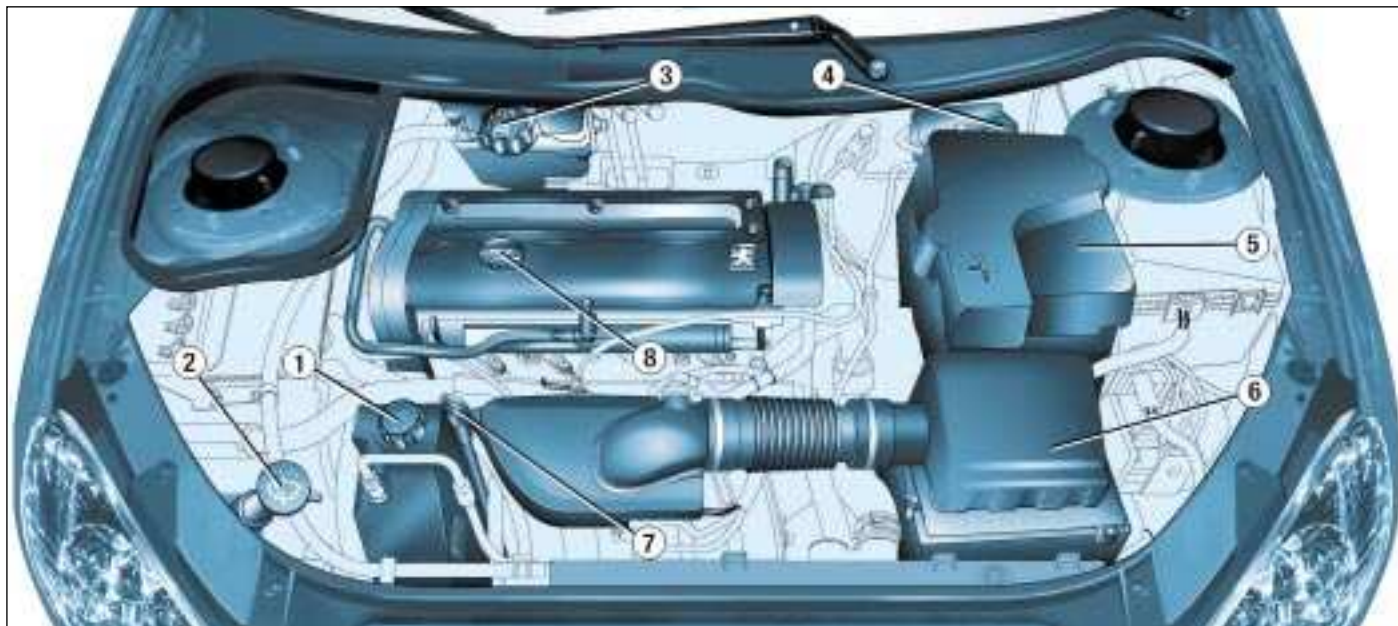

### 2 litre 16V ENGINE

1. Power steering reservoir
2. Windscreen and headlamp\* wash reservoir
3. Coolant reservoir

4. Brake fluid reservoir
5. Battery
6. Air filter

7. Dipstick

8. Engine oil filler cap

\* According to destination.

## PRACTICAL INFORMATION

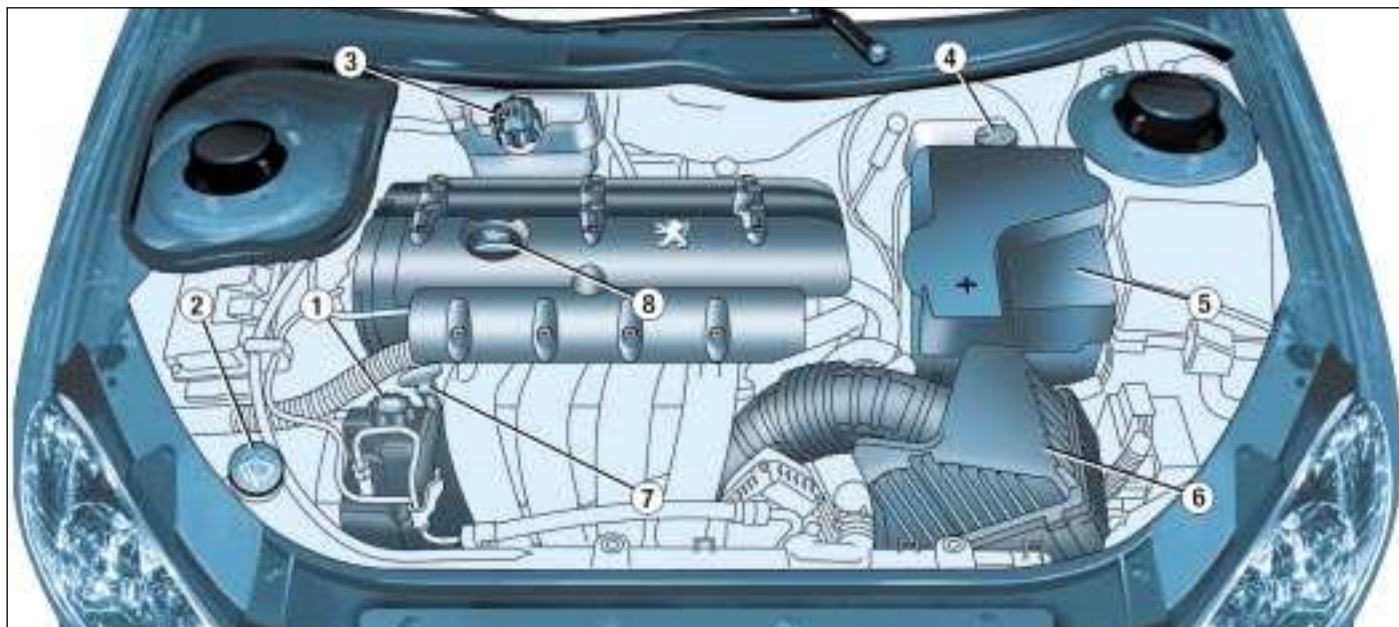

### 2 litre 16V ENGINE (180 bhp\*\*)

- |   |   |
|---|---|
| <ul style="list-style-type: none"> <li>1. Power steering reservoir</li> <li>2. Windscreen and headlamp* wash reservoir</li> <li>3. Coolant reservoir</li> </ul> | <ul style="list-style-type: none"> <li>4. Brake fluid reservoir</li> <li>5. Battery</li> <li>6. Air filter</li> </ul> |
|---|---|

- 7. Dipstick
- 8. Engine oil filler cap

\* According to destination.

\*\* During the year, according to destination.

## PRACTICAL INFORMATION

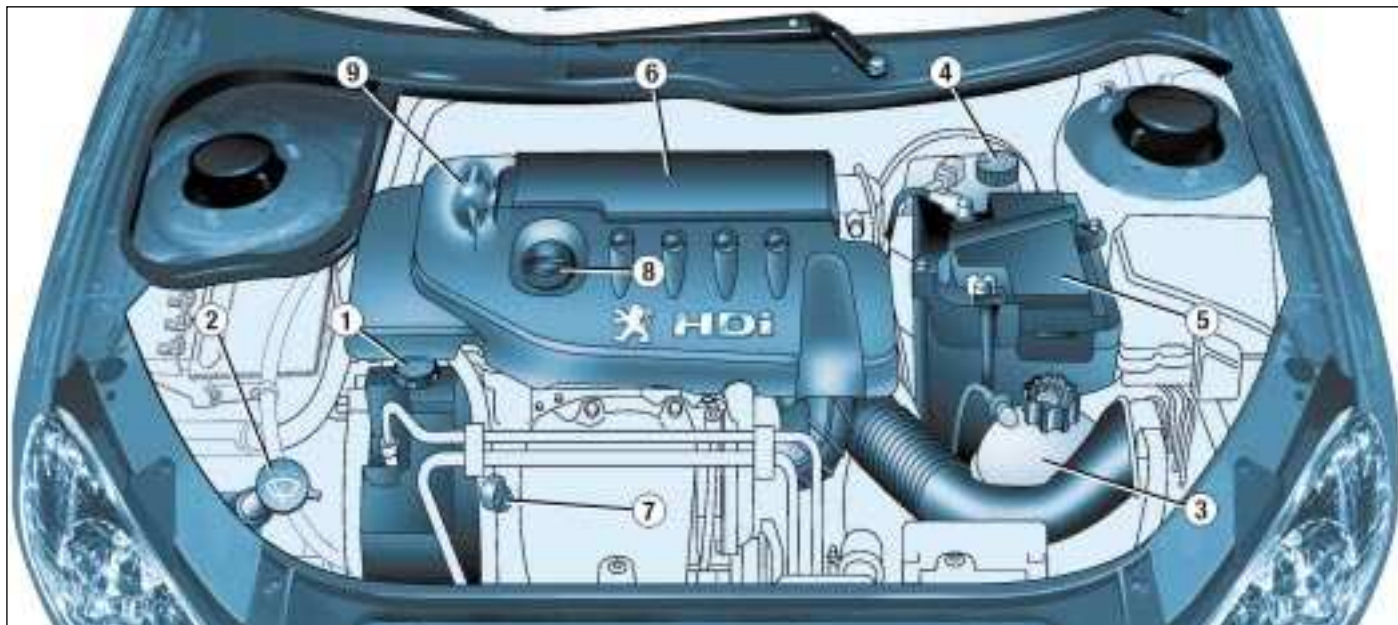

### 1.4 litre turbo diesel HDi ENGINE

1. Power steering reservoir
2. Windscreen and headlamp\* wash reservoir
3. Coolant reservoir

4. Brake fluid reservoir
5. Battery
6. Air filter

7. Dipstick
8. Engine oil filler cap
9. Priming pump

\* According to destination.



## PRACTICAL INFORMATION

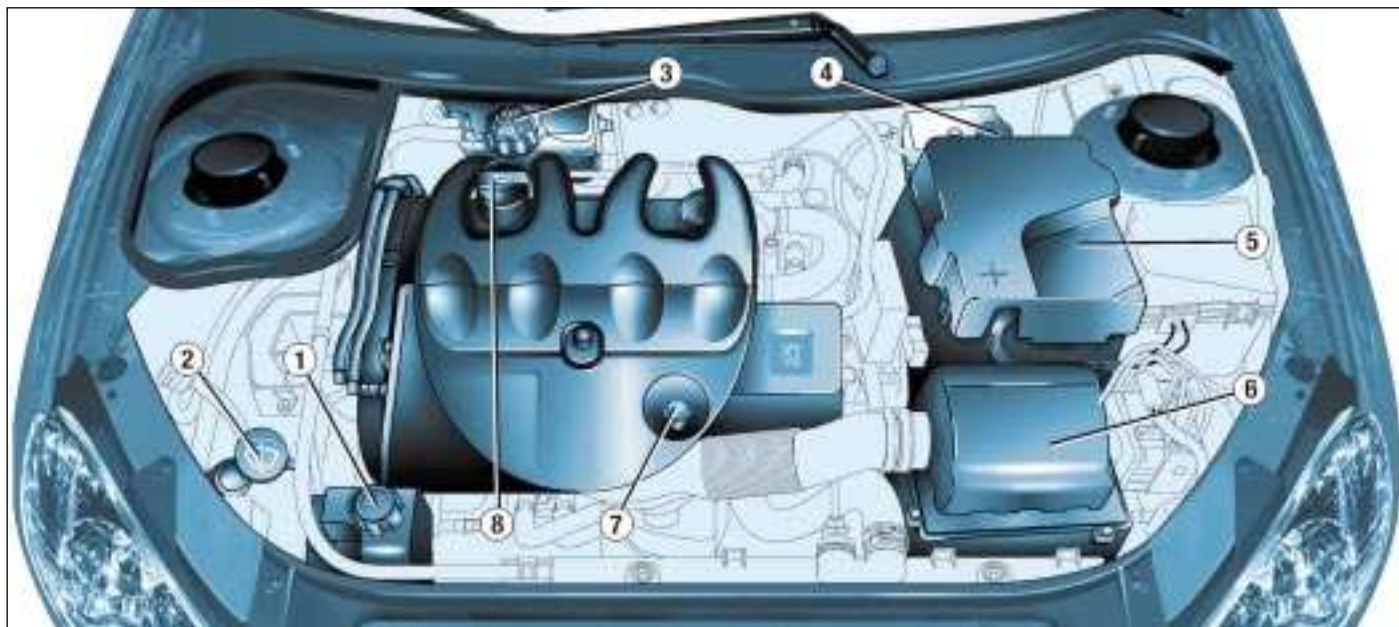

### 1.9 litre Diesel ENGINE

- 1. Power steering reservoir
- 2. Windscreen and headlamp\* wash reservoir
- 3. Coolant reservoir

- 4. Brake fluid reservoir
- 5. Battery
- 6. Air filter

- 7. Dipstick

- 8. Engine oil filler cap

\* According to destination.

## PRACTICAL INFORMATION

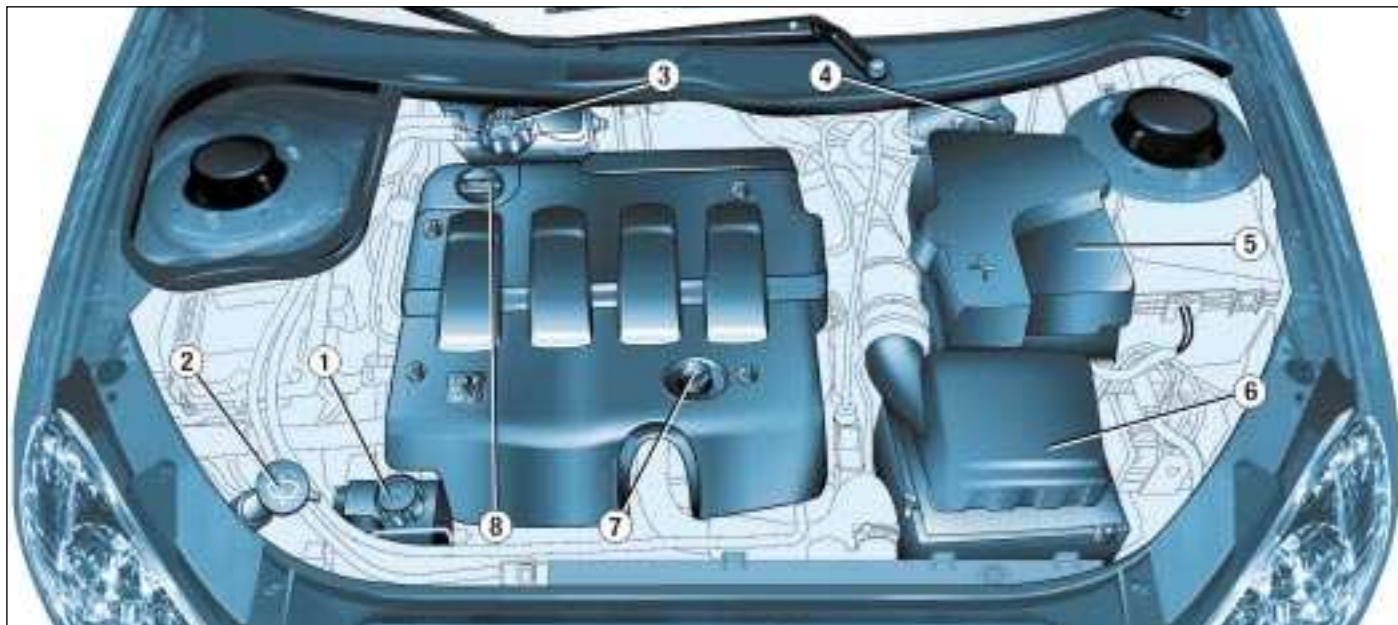

### 2 litre Turbo Diesel HDI ENGINE

1. Power steering reservoir
2. Windscreen and headlamp\* wash reservoir
3. Coolant reservoir

4. Brake fluid reservoir
5. Battery
6. Air filter

7. Dipstick

8. Engine oil filler cap

\* According to destination.

## PRACTICAL INFORMATION

### CHECKING THE LEVELS

#### Oil level

☞ Check the level regularly and top up between changes. The maximum consumption is 0.5 l per 600 miles (1 000 km).

Check the level with the vehicle level, engine cold, using the oil level gauge on the instrument panel or the dipstick.

#### Dipstick

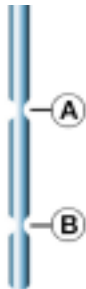

There are two marks on the dipstick:

**A** = maximum

Never fill past this mark.

**B** = minimum

To maintain the reliability of engines and emission control systems, the use of additives in engine oil is prohibited.

#### Oil change

According to the information given in "PEUGEOT SERVICING".

**Note:** avoid used oil coming into prolonged contact with the skin.

#### Viscosity selection

In all cases, the oil selected must meet the manufacturer's requirements.

#### Brake fluid level:

- The level must always be between the DANGER and MAXIMUM marks in the reservoir.
- If the level drops substantially, contact a PEUGEOT dealer immediately.

#### Fluid change:

- must be carried out according to the manufacturer's servicing schedule.
- use fluids recommended by the manufacturer, which fulfil DOT4 standards.

**Note:** brake fluid is harmful to health and very corrosive. Avoid all contact with the skin.

#### Cooling system

Use the fluid recommended by the manufacturer.

When the engine is warm, the temperature of the coolant is controlled by the engine fan. As this fan can operate with the ignition key removed and because the cooling system is pressurised, wait for at least one hour after the engine has stopped before carrying out any work.

Slacken the cap to the first notch to release the pressure to prevent any risk of scalding. When the pressure has dropped, remove the cap and top up the level.

**Note:** the coolant does not need to be changed.

#### Used oil

*Do not dispose of used oil, brake fluid or coolant into drains or into the ground.*

#### Power steering reservoir

☞ Open the reservoir, with the engine at ambient temperature. The level should always be above the MIN. mark and close to the MAX. mark.

#### Windscreen and headlamp\* wash level

For best quality cleaning and for your safety, we would advise that you use products recommended by PEUGEOT.

\* According to destination.

# PRACTICAL INFORMATION

## CHECKS

### Battery

At the start of winter, have your battery checked by a PEUGEOT dealer.

### Air filter and passenger compartment filter

Have the filter elements replaced regularly. **If you drive in dusty conditions, change them twice as often.**

### Brake pads

Brake pad wear depends on the style of driving, in particular for vehicles which are used in town, over short distances.

It may be necessary to check the thickness of the pads, even between services.

### Handbrake

Where the handbrake travel is too great or there is a reduction in the performance of the system, the handbrake should be adjusted, even between services.

Have the system checked by a PEUGEOT dealer.

### Manual gearbox

This does not need an oil change. Check the level, according to the manufacturer's servicing schedule.

### Automatic gearbox

This does not need an oil change. Have the level checked by a PEUGEOT dealer, according to the manufacturer's servicing schedule.

### Oil filter

Change the filter regularly, in accordance with the servicing schedule.

## RUNNING OUT OF FUEL (DIESEL)

If you should run out of fuel, it is necessary to re-prime the circuit:

### 1.4 litre HDI engine

- fill the fuel tank with at least five litres of diesel,
- operate the manual re-priming pump, until fuel appears in the transparent pipe under the bonnet,
- operate the starter until the engine starts.



*Only use products recommended by PEUGEOT.*

*To ensure best performance from components as important as the power steering and the braking system, PEUGEOT selects and offers quite specific products.*

# PRACTICAL INFORMATION

## CHECKS

### Battery

At the start of winter, have your battery checked by a PEUGEOT dealer.

### Air filter and passenger compartment filter

Have the filter elements replaced regularly. **If you drive in dusty conditions, change them twice as often.**

### Brake pads

Brake pad wear depends on the style of driving, in particular for vehicles which are used in town, over short distances.

It may be necessary to check the thickness of the pads, even between services.

### Handbrake

Where the handbrake travel is too great or there is a reduction in the performance of the system, the handbrake should be adjusted, even between services.

Have the system checked by a PEUGEOT dealer.

### Manual gearbox

This does not need an oil change. Check the level, according to the manufacturer's servicing schedule.

### Automatic gearbox

This does not need an oil change. Have the level checked by a PEUGEOT dealer, according to the manufacturer's servicing schedule.

### Oil filter

Change the filter regularly, in accordance with the servicing schedule.

## RUNNING OUT OF FUEL (DIESEL)

If you should run out of fuel, it is necessary to re-prime the circuit:

### 1.4 litre HDI engine

- fill the fuel tank with at least five litres of diesel,
- operate the manual re-priming pump, until fuel appears in the transparent pipe under the bonnet,
- operate the starter until the engine starts.



*Only use products recommended by PEUGEOT.*

*To ensure best performance from components as important as the power steering and the braking system, PEUGEOT selects and offers quite specific products.*



## PRACTICAL INFORMATION



### CHANGING A WHEEL (saloon)

#### Parking the vehicle

- If possible, park the vehicle on level, stable and non-slippery ground.
- Apply the handbrake, engage first or reverse gear (position **P** for the automatic gearbox).

#### Access to the spare wheel and the jack

The wheel is located outside the vehicle, under the boot, supported by a metal carrier.

- Remove the wheelbrace **1**, secured **on the rear right inner panel of the boot**.



- Using the wheelbrace **1**, slacken the spare wheel carrier retaining bolt, located **inside the boot under the carpet**.
- Lift the carrier to release the hook rearwards, then lower it.
- Remove the jack storage box **2** located in the spare wheel.

#### Removing a wheel

- Chock the rear of the wheel diagonally opposite the wheel to be changed, using the jack storage box.
- Remove the wheel trim using the wheelbrace, by pulling at the valve passage hole.
- Slacken the wheel bolts.
- Place the jack under the locating point on the sub-frame **E** that is closest to the wheel to be changed. Ensure that the entire surface of the jack base plate is in contact with the ground.
- Extend the jack, completely unscrew the bolts and remove the wheel.

## PRACTICAL INFORMATION

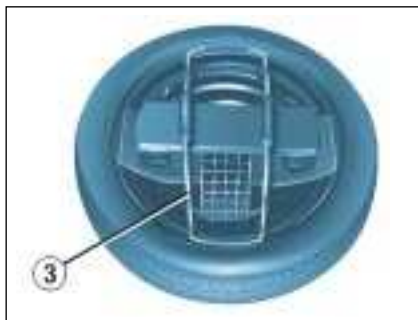

### Refitting the wheel

- After positioning the wheel, lightly pre-tighten the bolts using the wheelbrace.
- Compress the jack and release it.
- Fully tighten the bolts using the wheelbrace.
- Replace the trim except in the case of a space-saver spare wheel, starting at the valve passage hole, and press it on using the palm of the hand.

**Note:** If the vehicle is fitted in production with a wheel anti-theft lock, the trim cap on the anti-theft bolt is in two parts.

### Replacing the wheel in the carrier

- Replace the jack storage box in the wheel.
- Replace the support spacer **3** by clipping it to the space-saving spare wheel.
- Replace the wheel in the carrier directing the spacer **3** along the centre line of the vehicle, with the opening towards the front as shown in the diagram above (for a space-saving spare wheel only).
- Lift the wheel then the carrier and reposition the hook.
- Do not forget to fully tighten the spare wheel carrier retaining bolt.
- Stow the wheelbrace.



*For your safety, always change a wheel:*

- on level, stable and non slippery ground,
- with the handbrake applied,
- with first or reverse gear engaged,
- with the vehicle chocked using the jack storage box,
- never go underneath a vehicle raised using a jack (use an axle stand).

### After changing the wheel

- Have the tightening of the bolts and the pressure of the spare tyre checked as soon as possible by a PEUGEOT dealer.
- Have the punctured tyre repaired and replace it on the vehicle as soon as possible.
- The space-saver spare wheel fitted with a 115/70 R 15 tyre must only be used **temporarily**:
  - inflation pressure: 4.2 bars (60 p.s.i.),
  - maximum speed: 80 km/h.

## PRACTICAL INFORMATION

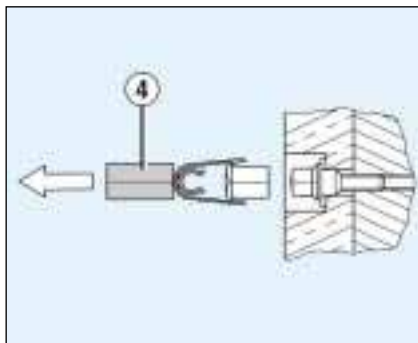

### SPECIAL FEATURES OF ALLOY WHEELS

#### Bolt covers

Alloy wheel bolts are covered by chrome trims.

Use the yellow tool 4 to remove the trims before slackening the bolts.

Tool 4 is located:

- on the saloon and 206 GTi 180, on the rear right inner panel of the boot,
- on the 206 SW, in the jack storage compartment.

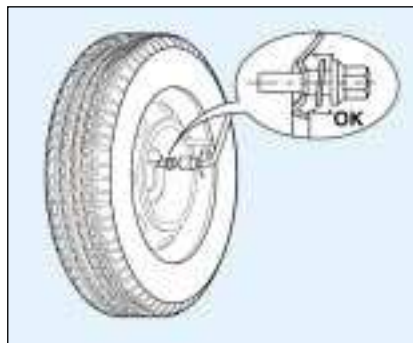

### Fitting the spare wheel

If your vehicle is equipped with a steel spare wheel, when fitting it, it is **normal** to notice that the bolt washers do not come into contact with the rim. The spare wheel is secured by the cone-shape of each bolt.

### Fitting snow tyres

If you fit snow tyres that are mounted on steel rims onto your vehicle, it is **essential** that you use special bolts available from your PEUGEOT dealer.

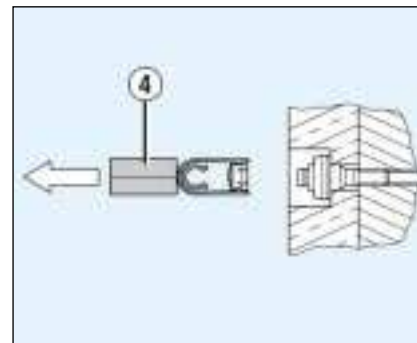

### Wheel anti-theft bolts\*

If your wheels are fitted with anti-theft bolts (one per wheel), the chrome-plated trim cap and then the plastic cover on the wheel must be removed, using tool 4, before slackening the bolt using one of the anti-theft sockets (handed to you along with the duplicate keys and the confidential card on delivery of your vehicle) and the wheelbrace 1.

**Note:** take a careful note of the code number engraved on the head of the anti-theft socket. This will enable you to obtain a duplicate anti-theft socket from a PEUGEOT dealer.

\* According to model and destination.

## PRACTICAL INFORMATION



### CHANGING A WHEEL (206 SW)

#### Parking the vehicle

- If possible, park the vehicle on level, stable and non-slippery ground.
- Apply the handbrake, engage first or reverse gear, (position **P** for the automatic gearbox).

#### Access to the spare wheel and the jack

The wheel is located outside the vehicle, under the boot, supported by a metal carrier.

- Remove the wheelbrace **1** secured under the right-hand boot trim.



- Using the wheelbrace **1**, slacken the spare wheel carrier retaining bolt located inside the boot under the carpet.
- Lift the carrier to release the hook rearwards, then lower it.
- Remove the jack storage box **2** located in the spare wheel.

#### Removing a wheel

- Chock the rear of the wheel diagonally opposite the wheel to be changed, using the collapsible chock located in jack storage box.
- Remove the wheel trim using the wheelbrace, by pulling at the valve passage hole.
- Slacken the wheel bolts.
- Place the jack under the locating point on the sub-frame **E** that is closest to the wheel to be changed. Ensure that the entire surface of the jack base plate is in contact with the ground.
- Extend the jack, completely unscrew the bolts and remove the wheel.

## PRACTICAL INFORMATION

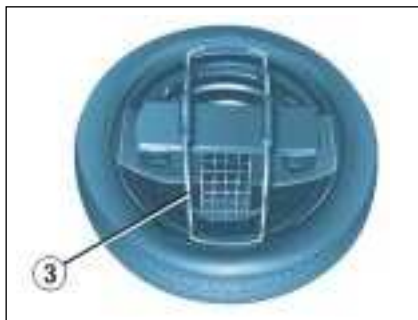

### Refitting the wheel

- After positioning the wheel, lightly pre-tighten the bolts using the wheelbrace.
- Compress the jack and release it.
- Fully tighten the bolts using the wheelbrace.
- Replace the trim except in the case of a space-saver spare wheel, starting at the valve passage hole, and press it on using the palm of the hand.

**Note:** If the vehicle is fitted in production with a wheel anti-theft lock, the trim cap on the anti-theft bolt is in two parts.

### Replacing the wheel in the carrier

- Replace the jack storage box in the wheel.
- Replace the support spacer **3** by clipping it to the space-saving spare wheel.
- Replace the wheel in the carrier directing the spacer **3** along the centre line of the vehicle, with the opening towards the front as shown in the diagram above (for a space-saving spare wheel only).
- Lift the wheel then the carrier and reposition the hook.
- Do not forget to fully tighten the spare wheel carrier retaining bolt.
- Stow the wheelbrace.



*For your safety, always change a wheel:*

- on level, stable and non slippery ground,
- with the handbrake applied,
- with first or reverse gear engaged,
- with the vehicle chocked using the jack storage box,
- never go underneath a vehicle raised using a jack (use an axle stand).

### After changing the wheel

- Have the tightening of the bolts and the pressure of the spare tyre checked as soon as possible by a PEUGEOT dealer.
- Have the punctured tyre repaired and replace it on the vehicle as soon as possible.
- The space-saver spare wheel fitted with a 115/70 R 15 tyre must only be used **temporarily**:
  - inflation pressure: 4.2 bars (60 p.s.i.),
  - maximum speed: 80 km/h.

## PRACTICAL INFORMATION

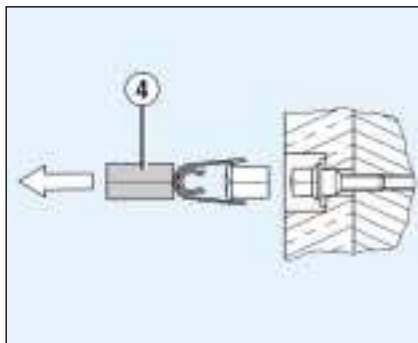

### SPECIAL FEATURES OF ALLOY WHEELS

#### Bolt covers

Alloy wheel bolts are covered by chrome trims.

Use the yellow tool 4 to remove the trims before slackening the bolts.

Tool 4 is located:

- on the saloon and 206 GTi 180, on the rear right inner panel of the boot,
- on the 206 SW, in the jack storage compartment.

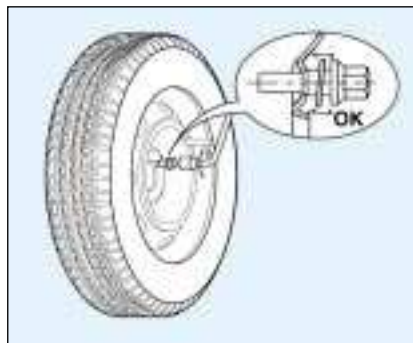

### Fitting the spare wheel

If your vehicle is equipped with a steel spare wheel, when fitting it, it is **normal** to notice that the bolt washers do not come into contact with the rim. The spare wheel is secured by the cone-shape of each bolt.

### Fitting snow tyres

If you fit snow tyres that are mounted on steel rims onto your vehicle, it is **essential** that you use special bolts available from your PEUGEOT dealer.

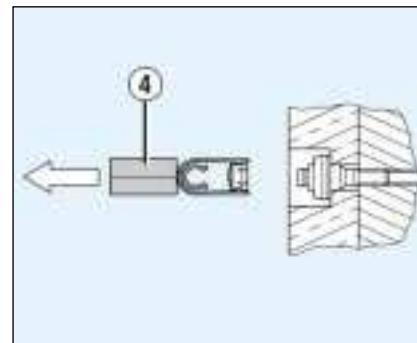

### Wheel anti-theft bolts\*

If your wheels are fitted with anti-theft bolts (one per wheel), the chrome-plated trim cap and then the plastic cover on the wheel must be removed, using tool 4, before slackening the bolt using one of the anti-theft sockets (handed to you along with the duplicate keys and the confidential card on delivery of your vehicle) and the wheelbrace 1.

**Note:** take a careful note of the code number engraved on the head of the anti-theft socket. This will enable you to obtain a duplicate anti-theft socket from a PEUGEOT dealer.

\* According to model and destination.

## PRACTICAL INFORMATION

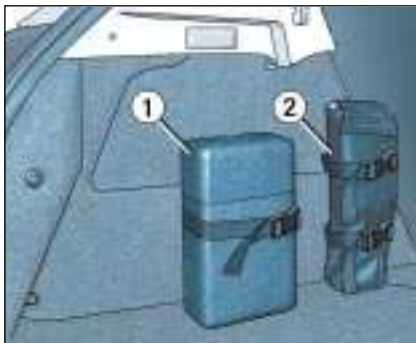

### PUNCTURES (206 GTi 180\* )

Because this version does not possess a spare wheel, you will find two temporary tyre repair aerosols stored in an insulated box **1** secured by a strap on the left-hand side of the boot.

#### Using the repair aerosols

(Also read the instructions for use on the aerosols).

- ☞ If possible remove the object which caused the puncture.
- ☞ Turn the wheel so that the valve is at the 2 o'clock or 10 o'clock position.



- ☞ Shake the aerosols vigorously before use. In very cold weather, warm the aerosols for a few minutes in your hands.
- ☞ In one hand hold the valve.
- ☞ With the other, firmly push the spray end of the aerosol onto the valve, keeping it centralised.
- ☞ Maintain the pressure firmly for one minute, then immediately drive **at a moderate speed** to the nearest garage.

\* During the year, according to destination.

### CHANGING A WHEEL

#### Tools

- The jack and the chock are in a cover **2** secured by two straps on the left-hand side of the boot.
- The wheelbrace and the bolt cover tool are secured on the boot rear right inner panel.

#### Wheel changing procedure

The wheels of your 206 GTi 180 are fitted with anti-theft bolts.

The wheels are changed in the same way as on the saloon.

Refer to the corresponding sections.



*The aerosol cans enable you to carry out a temporary repair (maximum speed 50 mph (80 km/h)).*

*After use, the tyre must be replaced. As the aerosol cans are pressurised, they must not be exposed to a temperature above 50 °C.*

*Store them away from heat in their insulated storage box.*



## PRACTICAL INFORMATION

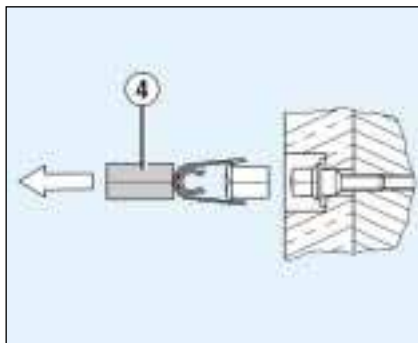

### SPECIAL FEATURES OF ALLOY WHEELS

#### Bolt covers

Alloy wheel bolts are covered by chrome trims.

Use the yellow tool 4 to remove the trims before slackening the bolts.

Tool 4 is located:

- on the saloon and 206 GTi 180, on the rear right inner panel of the boot,
- on the 206 SW, in the jack storage compartment.

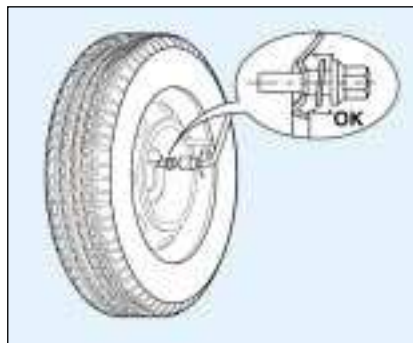

### Fitting the spare wheel

If your vehicle is equipped with a steel spare wheel, when fitting it, it is **normal** to notice that the bolt washers do not come into contact with the rim. The spare wheel is secured by the cone-shape of each bolt.

### Fitting snow tyres

If you fit snow tyres that are mounted on steel rims onto your vehicle, it is **essential** that you use special bolts available from your PEUGEOT dealer.

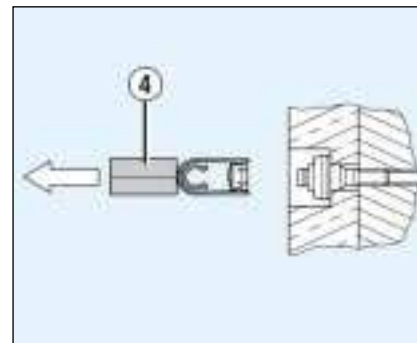

### Wheel anti-theft bolts\*

If your wheels are fitted with anti-theft bolts (one per wheel), the chrome-plated trim cap and then the plastic cover on the wheel must be removed, using tool 4, before slackening the bolt using one of the anti-theft sockets (handed to you along with the duplicate keys and the confidential card on delivery of your vehicle) and the wheelbrace 1.

**Note:** take a careful note of the code number engraved on the head of the anti-theft socket. This will enable you to obtain a duplicate anti-theft socket from a PEUGEOT dealer.

\* According to model and destination.



## PRACTICAL INFORMATION



### CHANGING A BULB

#### Dipped/main headlamps H7 55 W

- Pull the tab **A** upwards and remove the protective cover.
- Disconnect the connector.
- Press the end of the securing clip to remove it. Change the faulty bulb.
- On fitting, ensure that the direction notches are in the correct position and that the clip is secured correctly.
- Reconnect the connector.
- Replace the protective cover.

#### Side lights W 5 W

Turn the pin connector **B** a quarter turn and remove it. Change the bulb.

#### Remarks

- Only touch the bulbs with a dry cloth.
- To replace the bulbs on the right side, remove the wash-wipe reservoir filler pipe first.
- Condensation may form inside the headlamps. It will disappear when the lights are used.

## PRACTICAL INFORMATION



*PEUGEOT recommends the use of H7 bulbs of brands:*

- GE/TUNGSRAM,
- PHILIPS,
- OSRAM,

*to avoid damaging the headlamps.*

*These comply with the anti-UV (ultraviolet) specifications necessary for the correct operation and reliability of the headlamps.*

*The headlamps are fitted with polycarbonate glass with a protective coating. We strongly advise against cleaning them using a dry or abrasive cloth or using detergents or solvents.*

*Use a soft, damp cloth.*



### Amber direction indicators PY 21 W

Turn the pin connector **C** a quarter turn and remove it.  
Change the bulb.

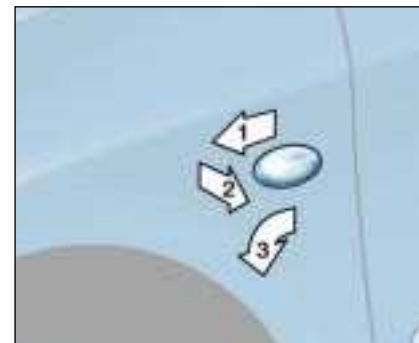

### Amber direction indicator side repeater WY 5 W

Push the repeater forwards or backwards and release the assembly.  
Hold the connector and turn the transparent cover a quarter turn.  
Change the bulb.

## PRACTICAL INFORMATION

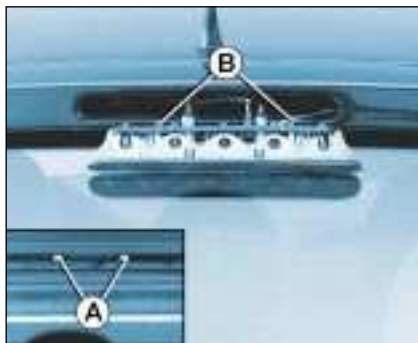

### Third brake light 5 bulbs W 5 W (saloon, 206 GTi 180)

Using a 10 mm spanner, unscrew the 2 nuts **A**.

Release the light unit.

Squeeze the two tabs **B** to release the bulb holder.

Change the faulty bulb.

### Third brake light (206 SW)

This is fitted with electroluminescent diodes.

In the event of a fault, consult a PEUGEOT dealer.



### Front fog lamps H1 55 W

Press under the access flap to release it.

Open the flap.

Turn the cover to remove it.

Disconnect the bulb.

Press the two ends of the securing clip to release the bulb.

## PRACTICAL INFORMATION

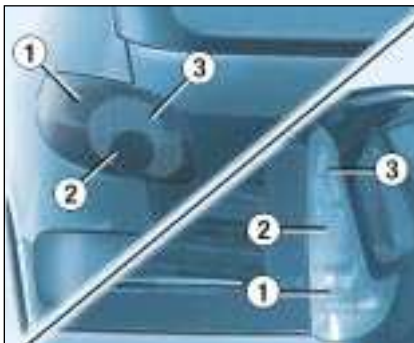

Saloon, 206 GTi 180 206 SW

1. **Direction indicators P 21 W.**
2. **Reversing lights P 21 W.**
3. **Brake lights/side lights P 21/5 W.**

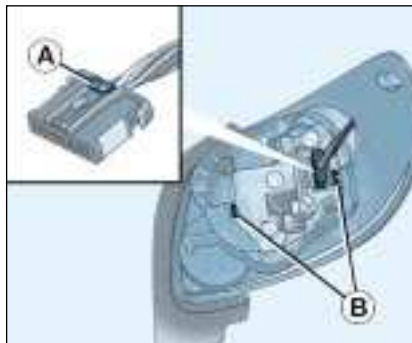

### Rear lights (saloon, 206 GTi 180)

Unclip the boot side trim.  
Remove the wing bolt.  
Release the light unit.  
Press the lug **A** and disconnect the connector.  
Remove the foam.  
Move aside the tabs **B** and remove the bulb holder.  
Change the faulty bulb.  
When refitting, ensure that the bulb holder and the light are repositioned correctly.



### Rear lights (206 SW)

Unclip the top of the boot trim using a coin.  
Unscrew the two wing bolts using the wheelbrace if necessary.  
Release the light unit.  
Disconnect the connector. Move aside the tabs **1** and remove the bulb holder **2**.  
Change the faulty bulb.  
When refitting, refit the boot trim by engaging it from the bottom then clipping the top.

## PRACTICAL INFORMATION

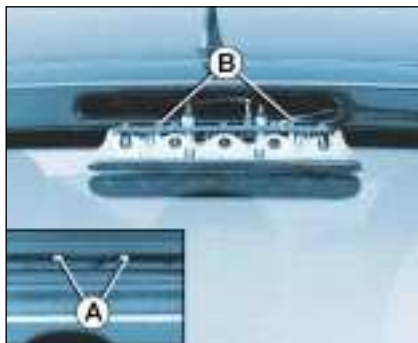

### Third brake light 5 bulbs W 5 W (saloon, 206 GTi 180)

Using a 10 mm spanner, unscrew the 2 nuts **A**.

Release the light unit.

Squeeze the two tabs **B** to release the bulb holder.

Change the faulty bulb.

### Third brake light (206 SW)

This is fitted with electroluminescent diodes.

In the event of a fault, consult a PEUGEOT dealer.



### Front fog lamps H1 55 W

Press under the access flap to release it.

Open the flap.

Turn the cover to remove it.

Disconnect the bulb.

Press the two ends of the securing clip to release the bulb.

## PRACTICAL INFORMATION

---



### Rear fog lamp P 21 W

Unclip the lamp and release the assembly.

Turn the pin connector a quarter turn and remove it.

Change the bulb.



### Number plate lights W 5 W

Insert a thin screwdriver into one of the outer holes of the transparent cover.

Push it outwards to unclip it.

Remove the transparent cover.

Change the faulty bulb.

## PRACTICAL INFORMATION

### CHANGING A FUSE

The fuse boxes are located under the fascia and in the engine compartment.



#### Fascia fuse box

Unscrew the catch a quarter turn using a coin then remove the cover to gain access to the fuses.

The spare fuses and the pliers **A** are fitted inside of the fascia fuse box lid.

### Removing and fitting a fuse

Before changing a fuse, the cause of the fault must be found and remedied. The fuse numbers are indicated on the fuse box.

Use the pliers **A**.

**Always replace a faulty fuse (identification according to fuse) with a fuse of the same rating.**

Correct

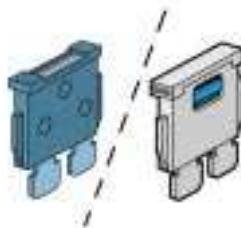

Incorrect



Pliers **A**

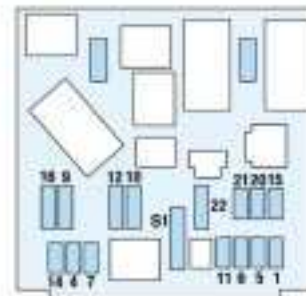

## PRACTICAL INFORMATION

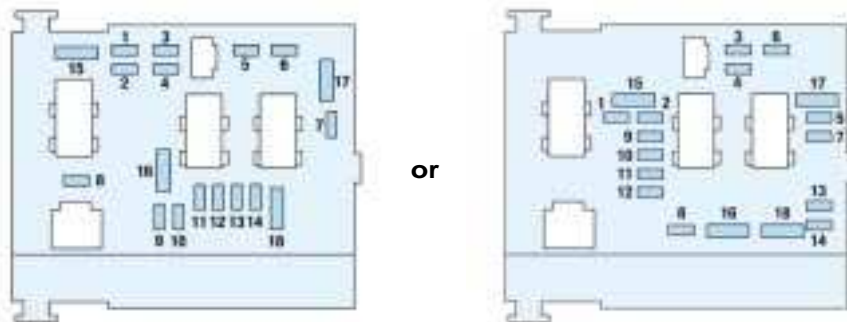

### Engine compartment fuse box

To gain access to the box in the engine compartment (next to the battery), unclip the cover.

After carrying out work, close the cover very carefully.

Fuse N°	Rating	Functions
1*	20 A	Fan unit
2*	60 A	ABS/ESP
3*	30 A	ABS/ESP
4*	70 A	Built-in systems interface supply
5*	70 A	Built-in systems interface supply
6*	–	Not used
7*	30 A	Ignition switch supply
8*	–	Not used

\* The maxi fuses provide additional protection for the electrical systems. Any work on these fuses must be carried out by a PEUGEOT dealer.



The electrical circuit of your vehicle is designed to operate with standard or optional equipment.

Before installing other electrical equipment or accessories in your vehicle, consult a PEUGEOT dealer.

Some electrical accessories or the way in which they are fitted may have an adverse effect on the operation of your vehicle (its electronic control circuits, the audio circuit and the electrical charging circuit).

PEUGEOT declines any responsibility for expenses incurred by the repair of your vehicle or for any malfunctions resulting from the installation of auxiliary accessories, not supplied and not recommended by PEUGEOT and not installed in accordance with PEUGEOT's instructions, in particular for any equipment the power consumption of which exceeds 10 milliamps.



## PRACTICAL INFORMATION

Fuse N°	Rating	Functions
1	10 A	Pre-heat unit (diesel) - Water in diesel sensor - Reversing lights switch - Speed sensor - Air flow sensor (diesel)
2	15 A	Canister solenoid valve - Fuel pump
3	10 A	ABS/ESP engine control unit - ESP stop switch
4	10 A	Automatic gearbox control unit - Engine control unit
5	–	Not used
6	15 A	Front fog lamps
7	–	Not used
8	20 A	Fan assembly relay - Engine control unit - Diesel injection pump - Diesel high pressure regulator - Engine management solenoid valve
9	15 A	Left dipped beam
10	15 A	Right dipped beam
11	10 A	Left main beam
12	15 A	Right main beam
13	15 A	Horns
14	10 A	Front and rear windscreen wash pumps
15	30 A	Throttle housing heater - Diesel injection pump - Oxygen sensor - Engine control unit - Air flow sensor - Ignition coil - Engine management solenoid valve - Diesel heater - Injectors - Engine variable timing solenoid valve (206 GTi 180) - Engine variable air intake solenoid valve (206 GTi 180)
16	30 A	Air pump relay
17	30 A	High and low speed windscreen wiper
18	40 A	Air conditioning fan

## PRACTICAL INFORMATION

### CHANGING A FUSE

The fuse boxes are located under the fascia and in the engine compartment.



#### Fascia fuse box

Unscrew the catch a quarter turn using a coin then remove the cover to gain access to the fuses.

The spare fuses and the pliers **A** are fitted inside of the fascia fuse box lid.

### Removing and fitting a fuse

Before changing a fuse, the cause of the fault must be found and remedied. The fuse numbers are indicated on the fuse box.

Use the pliers **A**.

**Always replace a faulty fuse (identification according to fuse) with a fuse of the same rating.**

Correct

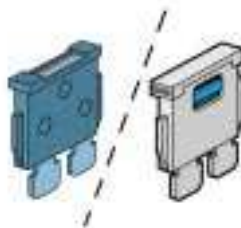

Incorrect



Pliers **A**

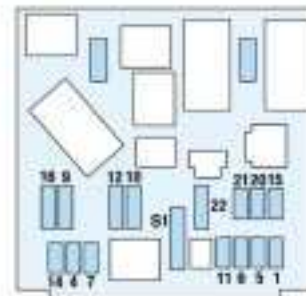

## PRACTICAL INFORMATION

Fuse	Rating	Functions
1	15 A	Alarm siren
4	20 A	Multifunction display - Navigation control unit - Boot lighting - Audio equipment
5	15 A	Automatic gearbox diagnostics
6	10 A	Coolant level - Automatic gearbox - Audio equipment - Steering wheel angle sensor (ESP)
7	15 A	Driving school accessory - Alarm
9	30 A	Rear electric windows
10	40 A	Rear screen and mirror demisting
11	15 A	Rear windscreen wiper
12	30 A	Front electric windows - Sunroof
14	10 A	Engine fuse box - Air bags - Steering wheel controls - Rain sensor
15	15 A	Instrument panel - Multifunction display - Navigation control unit - Air conditioning - Audio equipment
16	30 A	Locking/unlocking controls for doors, bonnet and boot - Deadlocking controls
20	10 A	Right-hand brake light
21	15 A	Left-hand brake light - 3rd brake light
22	20 A	Front and rear (206 SW) courtesy light - Map reader - Glove box lighting - Lighter - 12 volts rear socket (206 SW)
S1	Shunt	PARC shunt

## PRACTICAL INFORMATION

### BATTERY

#### To charge the battery using a battery charger:

- Disconnect the battery,
- Follow the instructions for use given by the battery charger manufacturer,
- Reconnect starting with the negative (–) terminal,
- Check that the terminals and connectors are clean. If they are covered with sulphate (white or greenish deposit), disconnect them and clean them.

#### To start the vehicle from another battery:

- Connect the red cable to the positive (+) terminals of the two batteries,
- Connect one end of the green or black cable to the negative (–) terminal of the slave battery,
- Connect the other end of the green or black cable to an earth point on the broken down vehicle as far as possible from the battery,

Operate the starter, let the engine run.

Wait for the engine to return to idle, then disconnect the cables.

**It is advisable to disconnect the battery if the vehicle is not to be used for a period of more than one month.**



- *Before disconnecting the battery, you must wait for 2 minutes after switching off the ignition.*
- *Never disconnect a terminal when the engine is running.*
- *Never charge a battery without first disconnecting the terminals.*
- *Close the windows and sunroof before disconnecting the battery. If they do not operate normally following reconnection of the battery, they must be reintialised (see sections "Electric windows - Safety auto-reverse" and "Sunroof - Safety auto-reverse").*
- *After every reconnection of the battery, switch on the ignition and wait 1 minute before starting to allow the electronic systems to be initialised. If slight difficulties are experienced after this, please contact a PEUGEOT dealer.*

### ECONOMY MODE FUNCTION

After the engine has stopped, with the key in the accessories position, certain functions (windscreen wiper, electric windows, courtesy lights, audio equipment etc.) can only be used for thirty minutes, to prevent discharging the battery.

Once the thirty minutes are over, the message "**Economy mode active**" appears on the multifunction display and the active functions are put on standby.

*A flat battery will prevent the engine from starting.*

## PRACTICAL INFORMATION

### FITTING AUDIO EQUIPMENT

Your vehicle is equipped with certain factory-fitted audio equipment:

- roof aerial,
- coaxial aerial cable,
- basic interference suppression,
- supply to front speakers,
- supply to rear speakers and tweeters,
- two 8-way connectors.

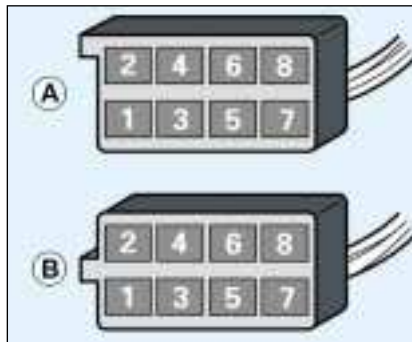

### FITTING SPEAKERS

The factory-fitted equipment allows the fitting of:

- 165 mm diameter speakers in the front doors,
- 130 mm diameter speakers in the rear doors,
- 22.5 mm diameter tweeters in the mirror trims.

### Making the connections

- A1 : –  
 A2 : –  
 A3 : –  
 A4 : –  
 A5 : –  
 A6 : (+ve) Ignition positive  
 A7 : (+ve) Permanent  
 A8 : Earth

- B1 : (+) Rear right speaker  
 B2 : (–) Rear right speaker  
 B3 : (+) Front right speaker and tweeter  
 B4 : (–) Front right speaker and tweeter  
 B5 : (+) Front left speaker and tweeter  
 B6 : (–) Front left speaker and tweeter  
 B7 : (+) Rear left speaker  
 B8 : (–) Rear left rear speaker



*Consult a PEUGEOT dealer before installing audio equipment or speakers in your vehicle.*

## PRACTICAL INFORMATION

### TOWING YOUR VEHICLE



Saloon and 206 GTi 180 rear towing eye



206 SW rear towing eye

#### Without lifting (four wheels on the ground)

You must always use a tow bar.

#### Saloon and 206 GTi 180

##### From the front or the rear

Attach the tow bar to the towing eye.

#### 206 SW

**From the front**, attach the tow bar to the towing eye.

##### From the rear:

- unclip the cover using a coin,
- screw in the towing eye (located in the jack storage compartment) as far as it will go.

#### By lifting (two wheels only on the ground)

It is preferable to lift the vehicle by the wheels.

#### Special features of the automatic gearbox

When towing with all four wheels on the ground, the following rules must be adhered to:

- gear lever in position **N**,
- tow the vehicle at a speed less than 30 mph (50 km/h) over a distance of not more than 30 miles (50 km),
- do not add oil to the gearbox.



*Never use the radiator crossmember.*

## PRACTICAL INFORMATION



### TOWING A TRAILER, CARAVAN, BOAT etc.

Only use original PEUGEOT tow bars that have been tested and approved from the design stage of your vehicle.

The tow bar must be fitted by a PEUGEOT dealer.

Your vehicle is primarily designed for transporting people and luggage but it may also be used for towing a trailer.

Driving with a trailer subjects the towing vehicle to more significant stress and its driver must be particularly careful.

Air density decreases with altitude, thus reducing engine performance. Above 1 000 metres, the maximum towing load must be reduced by 10 % and so on for every 1 000 metres of altitude.

### Driving advice

**Distribution of loads:** Distribute the load in the trailer so that the heaviest items are as close as possible to the axle and the nose weight approaches the maximum permitted without exceeding it.

**Cooling:** Towing a trailer on a slope increases the temperature of the coolant.

As the fan is electrically controlled, its cooling capacity is not dependent on the engine speed.

On the contrary, use a high gear to lower the engine speed and reduce your speed.

The maximum towing load on a long slope depends on the gradient and the outside temperature.

In all cases, pay attention to the coolant temperature.

If the warning light comes on, stop the vehicle and switch off the engine as soon as possible.

**Tyres:** Check the tyre pressures of the towing vehicle and of the trailer, observing the recommended pressures.

**Braking:** Towing increases the braking distance.

**Lights:** Check the electrical signalling on the trailer.

**Side wind:** Take into account the increased sensitivity to side wind.

## PRACTICAL INFORMATION



### Removing the mat

When removing the mat on the driver's side, move the seat as far back as possible and remove the fixings.

When refitting the mat, position it and replace the fixings by turning them a quarter of a turn.

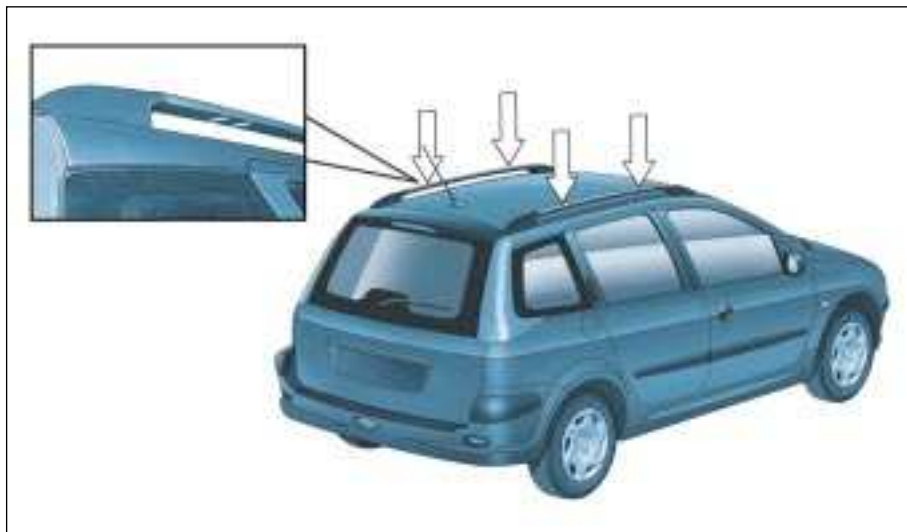

### FITTING ROOF BARS (206 SW)

When fitting transverse roof bars, ensure that they are positioned correctly.

The correct positions are shown by marks on each of the longitudinal bars.

Use accessories approved by PEUGEOT and follow the manufacturer's fitting instructions.

**Maximum authorised  
weight on the roof rack:  
75 kg**



## PRACTICAL INFORMATION

### BODYWORK MAINTENANCE

To preserve the paintwork and the plastic trim on your vehicle, we recommend that you wash them regularly.

- by hand: there are no specific precautions to take;
- using an automatic car wash: repeated use of poorly maintained automatic car washes can lead to the appearance of microscopic scratches which give the paintwork a matt appearance (especially visible on dark colours);
- using a high pressure washer: always follow the recommendations on the equipment (pressure and spraying distance).

If there are damaged areas on the vehicle (painted bumpers or headlamps), it is not recommended to direct the high pressure jet onto them. Wash these areas by hand.

Also avoid the entry of water into the locks.

For all questions relating to the maintenance of your vehicle, contact an approved dealer who can advise you on quality products selected by our departments.



- *Clean off bird droppings, resinous deposits, tar stains and grease marks as soon as possible; (these all contain substances which can cause serious damage to the paintwork).*
- *Do not use a dry or abrasive cloth, or detergent or solvent products to clean the double lens, complex surface headlamps as they are fitted with polycarbonate glass covered in a protective finish.*
- *Do not use petrol, oil or cloth stain removers to clean the bodywork and plastic parts of your vehicle.*
- *To prevent the development of bodywork corrosion as a result of accidental damage (stone chips, scratches etc.), have them repaired swiftly.*

## PRACTICAL INFORMATION

### 206 ACCESSORIES

For your PEUGEOT only use accessories and original parts approved by the manufacturer.

These accessories and parts are all adapted to your PEUGEOT, after being tested and approved for reliability and safety, which PEUGEOT cannot guarantee for other products.

A wide choice of original accessories, approved by PEUGEOT, is available through the dealer network. They all carry the PEUGEOT guarantee.

- Safety** : Anti-theft alarms, window engraving, wheel locks, warning triangle, first aid kit, ...
- Protection** : Covers compatible with side air bags (saloon and 206 SW), carpets, boot tray, ...
- Communication** : Audio/telephone, hands-free kit, on-board satellite navigation system, CD changers, radios, speakers, radio trim, rear shelf fitted with 4 speakers (saloon), ...
- Customising** : Alloy wheels, trims, sunroof\*, front fog lamps, mud flaps, tailgate spoiler (saloon), sport exhaust, aluminium and wood panel trim, door sills, body kit, wing extenders, ...  
\* To fit a sunroof, it is essential that only original PEUGEOT products are used.
- Comfort** : Centre armrest, writing table, passenger seat protection, large storage box (saloon and 206 SW)\*\*, bottle holder, CD or cassette storage, telephone console, door deflectors, under shelf storage (saloon), ...  
\*\* With "modifiable seats" option only.
- Leisure** : Tow bar, roof bars, roof boxes, ski carrier, bicycle carrier\*\*\*, snow chains, ...  
\*\*\* Do not fit the bicycle carrier on the spoiler or on the rear screen.
- Children** : Booster seats and child seats, Kiddy Isofix seat, sun blinds, ...
- Maintenance products** : Windscreen wash fluid, interior and exterior maintenance and cleaning products, ...
- Van** : Kit for conversion into a van, ...



*Before fitting an electrical accessory in your vehicle, consult a PEUGEOT dealer.*

# TECHNICAL DATA

## ENGINES AND GEARBOXES

PETROL				
Models Model codes	2CHF 2AHFX 2SHFX 2EHFX	2CK6D 2AK6D	2CKFW 2AKFW 2EKFW	
<b>ENGINES</b>	<b>1.1 litre</b>	<b>1.4 litre</b>	<b>1.4 litre</b>	
Cubic capacity (cm <sup>3</sup> )	1 124	1 360	1 360	
Bore x stroke (mm)	72 x 69	75 x 77	75 x 77	
EU standard maximum power (kW)	44.1	55	55	
Maximum power at engine speed (rpm)	5 500	5 500	5 500	
EU standard maximum torque (Nm)	94	118	120	
Maximum torque at engine speed (rpm)	2 700	2 800	2 800	
Fuel	Unleaded	Leaded	Unleaded	
Catalytic converter	Yes	No	Yes	
<b>Gearbox</b>	Manual (5 speed)	Manual (5 speed)	Manual (5 speed)	Automatic (4 speed)
<b>Oil capacity (in litres)</b>				
Engine (with cartridge replacement)	3.2 (2) - 3.4 (3)	3 (2) - 3.25 (3)	3 (2) - 3.25 (3)	3 (2) - 3.25 (3)
Gearbox-Final drive	2	2	2	-

(2) Draining by gravity - (3) Draining by suction

# TECHNICAL DATA

## ENGINES AND GEARBOXES

PETROL				
Models Model codes	2CNFU 2HNFU 2KNFU	2ANFU	2CRFN 2ARFN 2ERFN	2CRFKA/IF
<b>ENGINES</b>	<b>1.6 litre 16V</b>		<b>2 litre 16V</b>	<b>2 litre 16V</b>
Cubic capacity (cm <sup>3</sup> )	1 587		1 997	1 997
Bore x stroke (mm)	78,5 x 82		85 x 88	85 x 88
EU standard maximum power (kW)	80		100	130
Maximum power at engine speed (rpm)	5 800		6 000	7 000
EU standard maximum torque (Nm)	147		190	202
Maximum torque at engine speed (rpm)	4 000		4 100	4 750
Fuel	Unleaded		Unleaded	Unleaded
Catalytic converter	Yes		Yes	Yes
<b>Gearbox</b>	Manual (5 speed)	Automatic (4 speed)	Manual (5 speed)	Manual (5 speed)
<b>Oil capacity (in litres)</b>				
Engine (with cartridge replacement)	3.2 (2) - 3.4 (3)	3.2 (2) - 3.4 (3)	4.25	3.8 - 5.3
Gearbox-Final drive	2	—	1.9	1.9

(2) Draining by gravity - (3) Draining by suction

# TECHNICAL DATA

## ENGINES AND GEARBOXES

DIESEL				
Models Model codes	2C8HX 2A8HX 2S8HX 2E8HX	2CWJY 2AWJY 2SWJY 2TWJY	2CRHY 2ERHY 2ARHY 2KRHY 2HRHY	2CRHYU 2ARHYU
<b>ENGINES</b>	<b>1.4 litre turbo HDI</b>	<b>1.9 litre</b>	<b>2 litre turbo HDI</b>	<b>2 litre turbo HDI (ECO)</b>
Cubic capacity (cm <sup>3</sup> )	1 398	1 867	1 997	1 997
Bore x stroke (mm)	73.7 x 82	82.2 x 88	85 x 88	85 x 88
EU standard maximum power (kW)	50	51	66	66
Maximum power at engine speed (rpm)	4 000	4 600	4 000	4 000
EU standard maximum torque (Nm)	150	125	205	205
Maximum torque at engine speed (rpm)	1 750	2 500	1 900	1 900
Fuel	Diesel	Diesel	Diesel	Diesel
Catalytic converter	Yes	Yes	Yes	Yes
<b>Gearbox</b>	Manual (5 speed)	Manual (5 speed)	Manual (5 speed)	Manual (5 speed)
<b>Oil capacity (in litres)</b>				
Engine (with cartridge replacement)	3.8	4.8	4.5	4.5
Gearbox-Final drive	2	1.9	1.9	1.9

## TECHNICAL DATA

### SALOON AND 206 GTi 180 CONSUMPTION\*

			In accordance with directive 99/100 in M.P.G. (litres/100 km)			
Engine	Gearbox	Model codes	Urban driving	Inter-urban	Mixed	Emission of CO <sub>2</sub> by weight g/Km
1.1 litre	Manual	HFXF	34.4 (8.2)	56.5 (5)	45.6 (6.2)	148
1.1 litre	Manual	HFXU/A	33.6 (8.4)	54.3 (5.2)	44.9 (6.3)	151
1.4 litre	Manual	K6D2	30.0 (9.4)	51.4 (5.5)	40.4 (7)	162
1.4 litre	Manual	KFWF KFWA	33.6 (8.4) 33.2 (8.5)	56.5 (5) 54.3 (5.2)	44.9 (6.3) 44.9 (6.3)	149 151
1.4 litre	Automatic	KFWR	29.7 (9.5)	52.3 (5.4)	40.9 (6.9)	165
1.6 litre 16V	Manual	NFUF HNFUF	32.8 (8.6) 32.5 (8.7)	55.4 (5.1) 49.6 (5.7)	44.1 (6.4) 41.4 (6.8)	153 161
1.6 litre 16V	Automatic	NFUR HNFUR	28.5 (9.9) 27.6 (10.2)	51.4 (5.5) 48.7 (5.8)	40.0 (7.1) 37.6 (7.5)	171 179
2 litre 16V	Manual	RFNF	26.4 (10.7)	46.3 (6.1)	36.7 (7.7)	185
2 litre 16V	Manual	2CRFKA/IF	23.9 (11.8)	42.6 (6.7)	32.8 (8.6)	204
1,4 litre Turbo HDI	Manual	8HFX	51.4 (5.5)	77.1 (3.6)	65.7 (4.3)	113
1,9 litre diesel	Manual	WJYF WJYU	38.2 (7.4) 36.2 (7.8)	64.2 (4.4) 62.1 (4.6)	51.4 (5.5) 48.7 (5.8)	144 153
2 litre Turbo HDI	Manual	RHYF HRHYF	42.8 (6.6) 40.9 (6.9)	68.9 (4.1) 64.2 (4.4)	56.5 (5) 53.3 (5.3)	136 144
2 litre Turbo HDI (ECO)	Manual	RHYU	48.7 (5.8)	74.3 (3.8)	62.8 (4.5)	120

Fuel consumption values correct at time of printing.

\* During the year, according to destination.

# TECHNICAL DATA

## 206 SW CONSUMPTION

			In accordance with directive 99/100 in M.P.G. (litres/100 km)			
Engine	Gearbox	Model codes	Urban driving	Inter-urban	Mixed	Emission of CO <sub>2</sub> by weight g/Km
1,1 litre	Manual	2EHFXF	32.5 (8.7)	54.3 (5.2)	43.5 (6.5)	156
1,4 litre	Manual	2EKFWF	33.2 (8.5)	54.3 (5.2)	44.1 (6.4)	153
		2EKFWA	33.2 (8.5)	54.3 (5.2)	44.1 (6.4)	153
1,6 litre 16V	Manual	2KNFUF	32.5 (8.7)	51.4 (5.5)	42.2 (6.7)	159
1,6 litre 16V	Automatic	2KNFUR	27.6 (10.2)	48.7 (5.8)	37.6 (7.5)	179
2 litre 16V	Manual	2ERFNF	25.7 (11)	45.6 (6.2)	35.8 (7.9)	189
1,4 litre Turbo HDI	Manual	2E8HXF	50.4 (5.6)	74.3 (3.8)	64.2 (4.4)	117
2 litre Turbo HDI	Manual	2ERHYF	41.4 (6.8)	68.9 (4.1)	55.4 (5.1)	138
		2KRHYF	40.9 (6.9)	68.9 (4.1)	53.3 (5.3)	144

Fuel consumption values correct at time of printing.

## TECHNICAL DATA

### WEIGHTS AND TOWING LOADS SALOON AND 206 GTi 180\*\* (IN KG)

3 and 5 DOOR							
Engine	1.1 litre	1.4 litre	1.4 litre	1.6 litre 16V	1.6 litre 16V	2 litre 16V	2 litre 16V
Gearbox	Manual	Manual	Automatic	Manual	Automatic	Manual	Manual
Model codes:	HFX	KFWF/A K6D	KFWR	NFUF	NFUR	RFN	2CRFKA/IF
• Kerb weight	985	1 025	1 055	1 100	1 055	1 125	1 159
• Gross vehicle weight (GVW)	1 405	1 450	1 480	1 567	1 614	1 560	1 550
• Gross train weight (GTW)*	1 920	2 365	2 395	2 467	2 504	2 475	2 450
• Unbraked trailer	485	510	525	550	550	560	575
• Braked trailer (within GTW)	700	1 100	1 100	1 100	1 100	1 100	1 100

3 and 5 DOOR					VANS		
Engine	1.4 litre HDI	1.9 litre D	2 litre HDI	2 litre HDI (ECO)	1.1 litre	1.4 litre HDI	1.9 litre D
Gearbox	Manual	Manual	Manual	Manual	Manual	Manual	Manual
Model codes:	8HX	WJY	RHY	RHYU	HFXU 2SHFX	2S8HXF	WJYU 2SWJY
• Kerb weight	1 061	1 084	1 145	1 145	900	1 049	1 000
• Gross vehicle weight (GVW)	1 525	1 525	1 585	1 585	1 405	1 525	1 525
• Gross train weight (GTW)*	2 425	2 440	2 500	2 500	1 920	2 425	2 440
• Unbraked trailer	530	540	570	500	485	524	540
• Braked trailer (within GTW)	1 100	1 100	1 100	1 100	700	1 100	1 100

\* In the case of a towing vehicle, the speed is limited to 60 mph (100 km/h).

\*\* During the year, according to destination.



# TECHNICAL DATA

## WEIGHTS AND TOWING LOADS 206 SW (IN KG)

5 DOOR							
Engine	1.1 litre	1.4 litre	1.6 litre 16V	1.6 litre 16V	2 litre 16V	1.4 litre HDI	2 litre HDI
Gearbox	Manual	Manual	Manual	Automatic	Manual	Manual	Manual
Model codes:	HFX	KFW	NFUF	NFUR	RFN	8HX	RHY
• Kerb weight	1 065	1 074	1 148	1 190	1 192	1 110	1 191
• Gross vehicle weight (GVW)	1 485	1 499	1 563	1 585	1 562	1 535	1 611
• Gross train weight (GTW)*	1 985	2 399	2 463	2 485	2 462	2 435	2 511
• Unbraked trailer	500	500	500	500	500	500	500
• Braked trailer (within GTW)	700	1 100	1 100	1 100	1 100	1 100	1 100

\* In the case of a towing vehicle, the speed is limited to 60 mph (100 km/h).

# TECHNICAL DATA

SALOON AND 206 GTi 180 DIMENSIONS (3 AND 5 DOOR VERSIONS)

206 SW DIMENSIONS

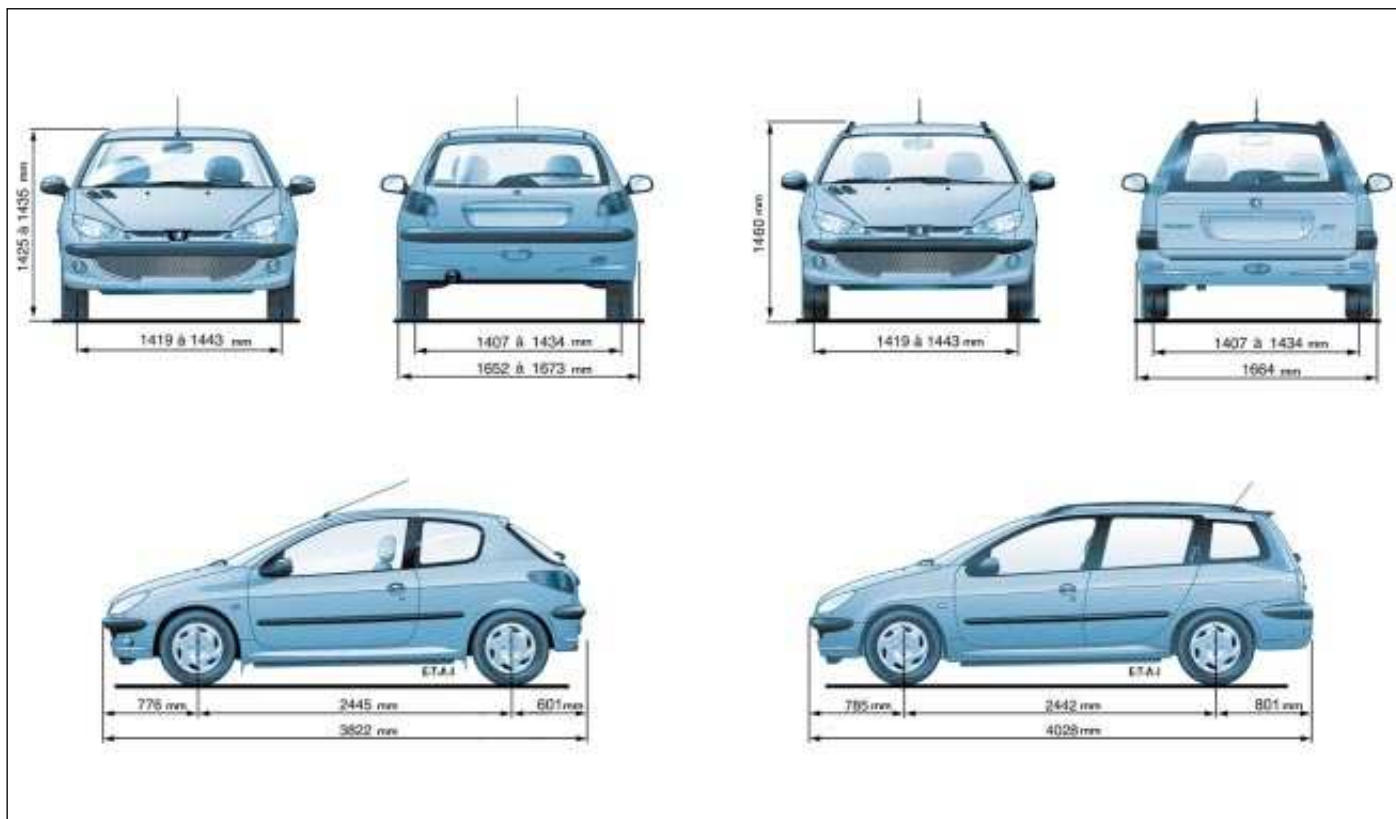

## TECHNICAL DATA

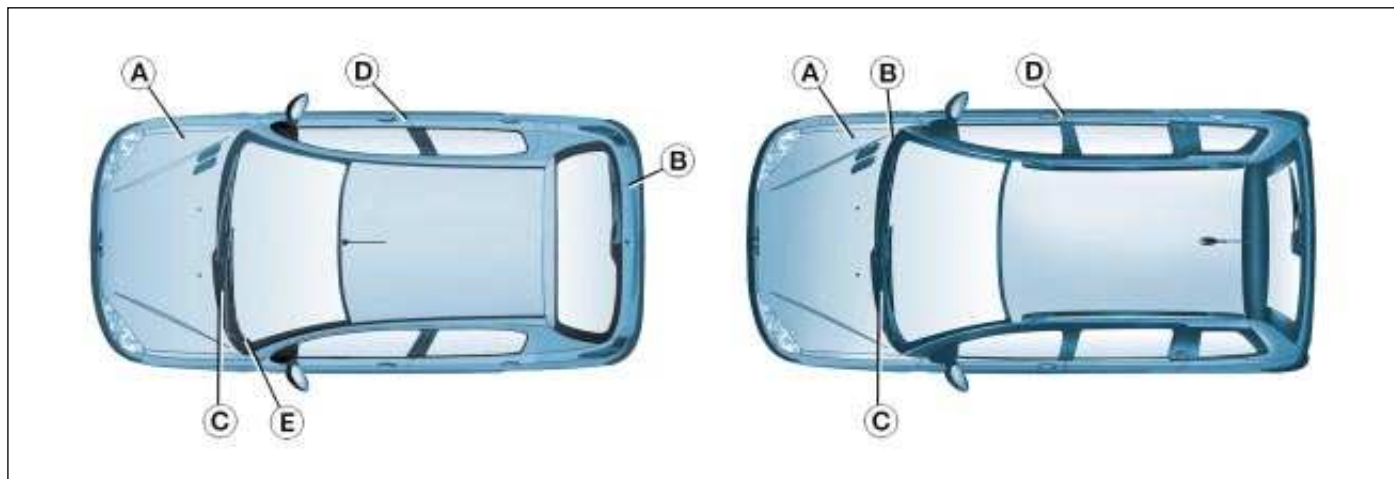

Saloon and 206 RC

206 SW

### THE IDENTIFICATION FEATURES OF YOUR 206

- A. Manufacturer's plate.**
- B. Serial number on the bodywork (location according to version).**
- C. Serial number on the fascia.**
- D. Tyres and paint reference.**

The label **D** on the driver's door centre pillar, near the hinges, gives:

- the wheel and tyre sizes,
- the brands of tyres\* approved by the manufacturer,
- the tyre pressures: **(checking of the tyre pressure must be carried out cold, at least every month).**
- the paint colour reference\*.

- E. Fuel consumption\* in the corner of the windscreen.**

\* According to destination.